

# YASKAWA AC Drive - V1000

## Compact Vector Control Drive

## Finless Type Installation Guide

Type: CIMR-VA□□□□□□J□□, CIMR-VA□□□□□□□□□□

Models: 200 V Class, Three-Phase Input: 0.1 to 18.5 kW

200 V Class, Single-Phase Input: 0.1 to 3.0 kW

400 V Class, Three-Phase Input: 0.2 to 18.5 kW

To properly use the product, read this manual thoroughly and retain for easy reference, inspection, and maintenance. Ensure the end user receives this manual.

# 安川インバータ V1000

小形ベクトル制御

## フィンレスタイプ 設置要領書

形 式 CIMR-VA□□□□□□J□□, CIMR-VA□□□□□□□□□□

容量範囲 200 V級 (三相電源用) 0.1~18.5 kW

200 V級 (単相電源用) 0.1~3.0 kW

400 V級 (三相電源用) 0.2~18.5 kW

製品を安全にお使い頂くために、本書を必ずお読みください。

また、本書をお手元に保管していただくとともに、最終的に本製品をご使用になるユーザー様のお手元に確実に届けられるよう、お取り計らい願います。

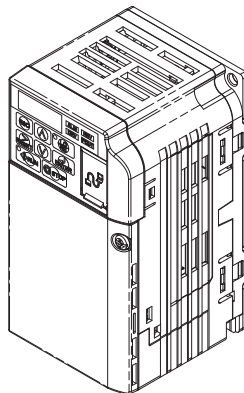

---

**Copyright © 2007 YASKAWA ELECTRIC CORPORATION™**

All rights reserved. No part of this publication may be reproduced, stored in a retrieval system, or transmitted, in any form, or by any means, mechanical, electronic, photocopying, recording, or otherwise, without the prior written permission of Yaskawa. No patent liability is assumed with respect to the use of the information contained herein. Moreover, because Yaskawa is constantly striving to improve its high-quality products, the information contained in this manual is subject to change without notice. Every precaution has been taken in the preparation of this manual. Nevertheless, Yaskawa assumes no responsibility for errors or omissions. Neither is any liability assumed for damages resulting from the use of the information contained in this publication.



# Table of Contents

---

<b>1 PREFACE</b> .....	<b>4</b>
<b>2 PRODUCT OVERVIEW</b> .....	<b>6</b>
<b>3 CONDITIONS OF ACCEPTABILITY</b> .....	<b>8</b>
<b>4 PERIODIC MAINTENANCE</b> .....	<b>15</b>
<b>5 DIMENSIONS</b> .....	<b>16</b>
<b>6 SELECTING AN EXTERNAL HEATSINK</b> .....	<b>21</b>
<b>7 REVISION HISTORY</b> .....	<b>25</b>

## 1 Preface

### ◆ Applicable Documentation

This manual provides instructions on installing the V1000 Finless drive. For more specific information on the operation of this product, refer to the other manuals listed in the following table:

	<b>Yaskawa AC Drive - V1000 Finless Installation Guide</b> <b>Manual No.: TOBPC71060621</b>
	This guide contains basic information required to install the V1000 Finless.
	<b>Yaskawa AC Drive - V1000 Technical Manual</b>
	This manual describes installation, wiring, operation procedures, functions, troubleshooting, maintenance, and inspections to perform before operation. To obtain instruction manuals for Yaskawa products access these sites: U.S.: <a href="http://www.yaskawa.com">http://www.yaskawa.com</a> Europe: <a href="http://www.yaskawa.eu.com">http://www.yaskawa.eu.com</a> Japan: <a href="http://www.e-mechatronics.com">http://www.e-mechatronics.com</a> Other areas: contact a Yaskawa representative.
	<b>Yaskawa AC Drive - V1000 Quick Start Guide</b>
This guide is packaged together with the product. It contains basic information required to install and wire the drive. This guide provides basic programming and simple setup and adjustment.	

### ◆ Terms

**Note:** Indicates supplementary information that Yaskawa highly recommends be followed, even though equipment may not be at risk.

**Drive:** Yaskawa AC Drive-V1000 Finless Drive

## ◆ Registered Trademarks

- Company names and product names listed in this manual are registered trademarks of those companies.

### General Precautions

- The diagrams in this manual may be indicated without covers or safety shields to show details. Restore covers or shields before operating the drive and run the drive according to the instructions described in this manual.
- The products and specifications described in this manual or the content and presentation of the manual may be modified without notice to improve the product and/or the manual. Such modifications are indicated by a revised manual number.
- When ordering a new copy of the manual due to damage or loss, contact your Yaskawa representative or the nearest Yaskawa sales office and provide the manual number shown on the front cover.
- If nameplate becomes worn or damaged, order a replacement from your Yaskawa representative or the nearest Yaskawa sales office.
- Yaskawa is not responsible for any modification of the product by the end user. Modification of the product voids the warranty.

## NOTICE

**For UL/CE compliance, a separate A6T50 fuse must be installed drive models CIMR-V□4A0023J. For all other models drives, refer to the Quick Start Guide packaged with the drive for the type of fuse required.**

Failure to use the specified fuse can damage the drive.

## 2 Product Overview

---

### ◆ About This Product

This manual describes installation conditions and dimensions for the V1000 Finless drive. Use this product only after you have a full understanding of the manual and its contents.

This V1000 Finless drive is a component recognized by Underwriters Laboratories Inc.(UL). The installation procedure and instructions have been provided to fulfill the requirements as specified by the “Conditions of Acceptability”.

---

### ◆ Model Number and Nameplate Check

Please perform the following tasks after receiving the drive:

- Inspect the drive for damage.
- If the drive appears damaged upon receipt, contact the shipper immediately.
- Verify receipt of the correct model by checking the information on the nameplate.
- If you have received the wrong model or the drive does not function properly, contact your supplier.

### ■ Nameplate

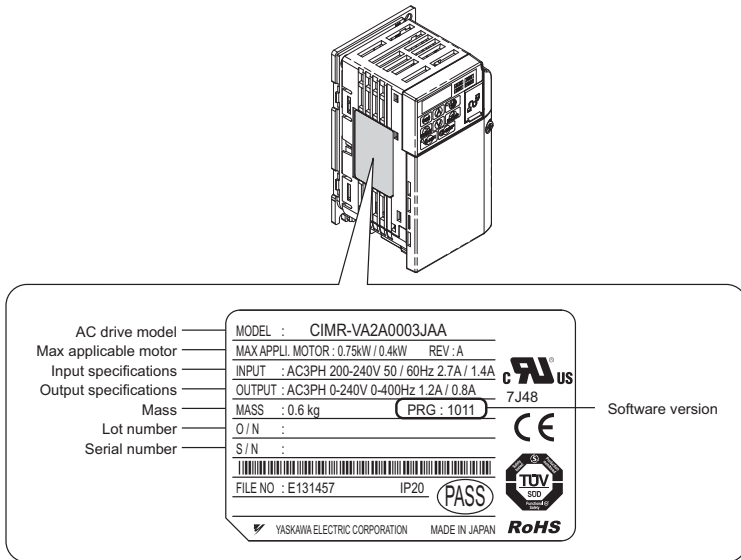
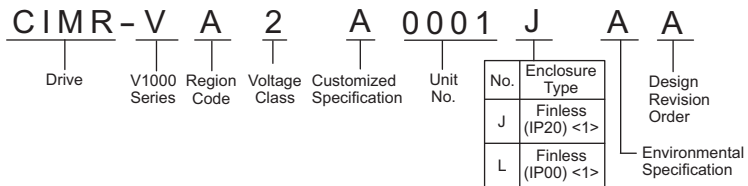

Figure 1 Nameplate Information

### ■ Drive Model Identification

The V1000 finless drive type is indicated by the letter “J” or “L” in the AC drive model designation code. Refer to the Quick Start Guide for complete model number information.



<1> The drive must be installed a control panel with a proper heat sink.

Figure 2 Understanding the Model Number

## 3 Conditions of Acceptability

### 3 Conditions of Acceptability

Adhere to the installation conditions specified in this guide to take full advantage of the finless design of this drive.

#### ◆ Installation Environment

The drive must be installed a control panel with a proper heat sink. The drive ambient temperature shall not exceed 50 °C (122 °F) for the drives installed location.

#### ◆ Heatsink Plate Temperature

The aluminum panel on the back of the drive is referred to as the “heatsink plate.” The heatsink plate temperature should never exceed the following values:

CIMR-V□BA□□□□□, CIMR-V□2A0001~0020, CIMR-V□4A0001~0011: 90 °C  
CIMR-V□2A0030~0069, CIMR-V□4A0018~0038: 80 °C

*Table 6* and *Table 7* lists the thermal characteristics of the drive.

Use parameter U4-08 to check the temperature of the heatsink plate as described below.

**NOTICE:** *The drive may be damaged if the temperature of the heatsink plate exceeds specified tolerance levels (90 °C or 80 °C, depending on the model). Excessive heat can also shorten the performance life of various drive components.*

#### ■ Checking and Monitoring Heatsink Plate Temperature

##### Checking Heatsink Plate Temperature Using the LED Operator

Scroll to parameter U4-08 (heatsink plate temperature).

When the temperature of the heatsink plate is 89 °C, U4-08 will display:

00089

**Note:** Parameter U4-08 is available in drive software version 1011 or later.

##### Checking Heatsink Plate Temperature Using an Analog Output

**Example:** When using Multi-Function Analog Output Terminal AM, set the parameters shown in *Table 1*.

**Table 1 Using Analog Output 1**

No.	Name	Description
H4-01	Analog Output Terminal AM Function Selection	00408 (heatsink plate temperature)
H4-02	Analog Output Terminal AM Gain	100.0%
H4-03	Analog Output Terminal AM Bias	0.0%



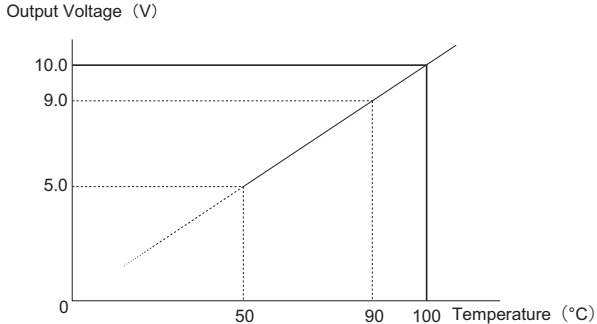

**Figure 3 Output of Heatsink Plate Temperature by Analog Output**

- Note:**
1. Accuracy of the temperature reading may vary  $\pm 5$  °C between 50 and 100 °C.
  2. The heatsink temperature is affected by the ambient temperature. Never exceed the allowable maximum heatsink plate temperature.

### ■ Drive Overheat Alarm (oH)

Use parameter L8-02 to cause the drive output an alarm when the heatsink plate exceeds the specified temperature.

L8-03 determines the action taken by the drive when an oH alarm is triggered. Refer to the V1000 Technical Manual for more details.

---

### ◆ Installation to Metallic Surface

The mating surface shall have the following properties:

- Surface flatness shall not exceed 0.2 mm across the entire mating surface.
- Surface roughness shall not exceed 25 S.

**Note:** A surface roughness of 25 S means “Ra” (average roughness) is not greater than 6.3 and “Ry” (maximum peak) is not greater than 25  $\mu\text{m}$ .

---

### ◆ Thermal Compound

Apply a thermal compound between the heatsink plate and the mating surface. The thermal compound assists in drive heat dissipation.

Yaskawa recommends the thermal compounds in [Table 2](#).

### 3 Conditions of Acceptability

**Table 2 Recommended Heatsink Plate Thermal Compounds**

Manufacturer	Type	Model	Required Amount
Shin-Etsu Chemical Inc.	Oil-based compound	G746	100 to 250 $\mu\text{m}$ (0.0039 to 0.0098 in) (Varies in accordance with the flatness of the metal panel.)
Dow Corning Toray Inc.	Silicone compound for heat dissipation	SC4471CV	

Spread the required amount of thermal compound over the clean heatsink plate. Firmly press the V1000 finless drive against the metal panel and hold it in place against the heatsink plate for a few seconds. Wipe away any excess thermal compound from around the heatsink plate edges.

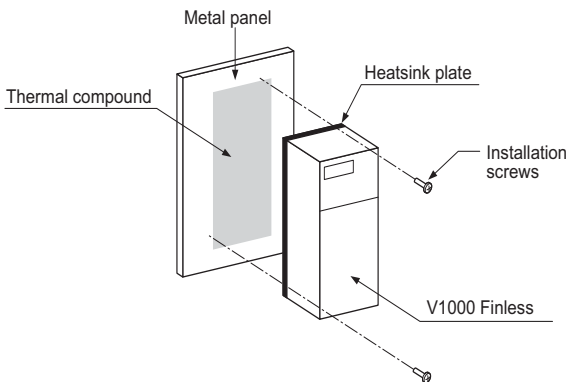

**Figure 4 Application of Thermal Compound**

**Note:** Surface milling of the metal panel to within 0.05 mm (0.0019 in) flatness is required if use of less thermal compound is desired.  
Ensure the V1000 finless drive is firmly pressed against the metal panel for a few seconds to ensure proper thermal transfer.

### ◆ Drive Heatsink Plate Installation Screw Size and Tightening Torque

Screw size and torque specifications for heatsink plate installation screws that hold the drive to a metal back panel are listed in [Table 3](#).

**Table 3 Screw Size and Tightening Torque**

Voltage Class	Model CIMR-V□	Screw Size	Tightening Torque N·m (ft·lbf)
Single-Phase 200 V class	BA0001 ~ BA0012	M4	1.0 to 1.3 (0.74 to 0.96)

### 3 Conditions of Acceptability

Voltage Class	Model CIMR-V□	Screw Size	Tightening Torque N·m (ft·lbf)
Three-phase 200V class	2A0001 ~ 2A0020	M4	1.0 to 1.3 (0.74 to 0.96)
	2A0030 ~ 2A0056	M5	2.0 to 2.5 (1.48 to 1.84)
	2A0069	M6	4.0 to 5.0 (2.95 to 3.69)
Three-phase 400V class	4A0001 ~ 4A0011	M4	1.0 to 1.3 (0.74 to 0.96)
	4A0018 ~ 4A0038	M5	2.0 to 2.5 (1.48 to 1.84)

**NOTICE:** Tighten all screws according to specified torques. Failure to do so may inhibit drive cooling and possible damage the drive.

### ◆ Installation Spacing

**Table 4** illustrates correct installation spacing for proper airflow, and wiring. The drive should be installed so that the heatsink plate rests flat against the metal back panel to ensure proper cooling.

**Table 4 Correct Installation Spacing**

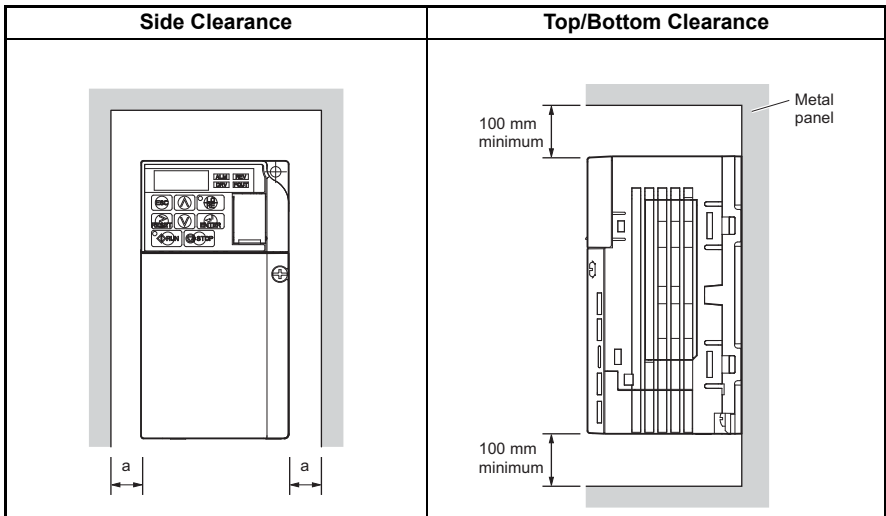

### 3 Conditions of Acceptability

**Table 5 Correct Installation Spacing**

Voltage Class	Drive Model CIMR-V□	Side Clearance (a) mm / (in)
Single-Phase 200 V Class	BA0001 to BA0012	30 / (1.18)
Three-Phase 200 V Class	2A0001 to 2A0069	
Three-Phase 400 V Class	4A0001 to 4A0038	

**NOTICE:** Do not install V1000 Finless drives using the Side-by-Side method available in standard V1000 drive models. Improper drive cooling may result in damage to the drive. Install V1000 Finless drives with a minimum side-by-side clearance of 30 mm (1.18 in).

#### ■ Ambient Temperature Derating

Parameters L8-12 (Ambient Temperature Setting) and L8-35 (Installation Method Selection) must be set according to the installation conditions if the ambient temperature is higher than 35°C. Refer to [Figure 5](#) for drive derating according to ambient temperature.

Parameter L8-12 = 40°C (default). The setting range is -10 to 50°C.

Operating the V1000 Finless drive between -10 and 35°C allows 100% continuous current without derating. Drive operation between 35 and 50°C requires drive derating according to [Figure 5](#).

The drive can be used with 100% rating between -10 and 50°C ambient temperature if the airflow around the unit is 0.5 m/s or more. In this case set L8-35 = 0 (Installation method = IP20 standard drive).

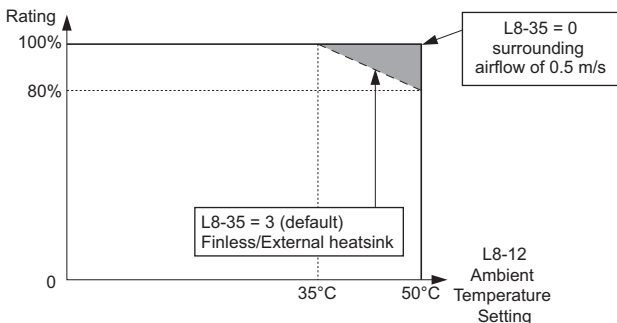

**Figure 5 Ambient Temperature and Drive Derating**

#### ◆ V1000 Finless Drive Watt Loss Thermal Characteristics

##### ■ Normal Duty

Table 6 Drive Watt Loss (Normal Duty Rating)

200 V Single-Phase Class														
Model CIMR-V□BA		0001	0002	0003	0006	–	0010	0012	–	–	–	–		
Rated Output Current (A)		1.2	1.9	3.3	6.0	–	9.6	12.0	–	–	–	–		
Generated Heat Loss	Heatsink Plate (W)	5.0	7.6	14.6	30.1	–	51.7	61.3	–	–	–	–		
	Internal (W)	8.0	9.7	14.4	19.4	–	29.8	37.1	–	–	–	–		
	Total (W)	13.5	17.3	29.0	49.5	–	81.5	98.4	–	–	–	–		
200 V Three-Phase Class														
Model CIMR-V□2A		0001	0002	0004	0006	0008	0010	0012	0018	0020	0030	0040	0056	0069
Rated Output Current (A)		1.2	1.9	3.5	6.0	8.0	9.6	12.0	17.5	19.6	30.0	40.0	56.0	69.0
Generated Heat Loss	Heatsink Plate (W)	5.0	7.6	15.8	27.5	44.6	51.7	61.3	89.8	98.7	238.2	266.7	357.9	477.3
	Internal (W)	8.0	9.5	13.6	17.2	24.0	25.8	30.4	44.1	46.3	85.8	108.6	145.2	185.8
	Total (W)	13.0	17.1	29.4	44.7	68.6	77.5	91.7	133.9	145.0	324.0	375.3	503.1	663.1
400 V Three-Phase Class														
Model CIMR-V□4A		0001	0002	0004	0005	–	0007	0009	–	0011	0018	0023	0031	0038
Rated Output Current (A)		1.2	2.1	4.1	5.4	–	6.9	8.8	–	11.1	17.5	23.0	31.0	38.0
Generated Heat Loss	Heatsink Plate (W)	10.0	18.5	30.5	44.5	–	58.5	63.7	–	81.7	181.2	213.4	287.5	319.2
	Internal (W)	9.6	13.9	16.8	21.8	–	28.5	31.4	–	46.0	78.4	101.8	139.4	138.8
	Total (W)	19.6	32.4	47.3	66.3	–	87.0	95.1	–	127.7	259.6	315.2	426.9	458.0

Note: Carrier frequency is set to 2 kHz.

### 3 Conditions of Acceptability

#### ■ Heavy Duty

Table 7 Drive Watt Loss (Heavy Duty Rating)

200 V Single-Phase Class														
Model CIMR-V□BA		0001	0002	0003	0006	–	0010	0012	–	–	–	–	–	
Rated Output Current (A)		<1>	<1>	<1>	<1>	–	<2>	<2>	–	–	–	–	–	
Generated Heat Loss	Heatsink Plate (W)	4.3	7.9	16.1	33.7	–	54.8	70.7	–	–	–	–	–	
	Internal (W)	7.4	8.9	11.5	16.8	–	25.9	34.1	–	–	–	–	–	
	Total (W)	11.7	16.8	27.6	50.5	–	80.7	104.8	–	–	–	–	–	
200 V Three-Phase Class														
Model CIMR-V□2A		0001	0002	0004	0006	0008	0010	0012	0018	0020	0030	0040	0056	0069
Rated Output Current (A)		<1>	<1>	<1>	<1>	<1>	<2>	<2>	<2>	<2>	<2>	<2>	<2>	<2>
Generated Heat Loss	Heatsink Plate (W)	4.3	7.9	16.1	27.4	48.7	54.8	70.7	92.6	110.5	213.3	239.5	347.6	473.9
	Internal (W)	7.3	8.8	11.5	15.9	22.2	23.8	30.0	38.8	43.3	68.1	79.6	113.8	156.7
	Total (W)	11.6	16.7	27.6	43.3	70.9	78.6	100.7	131.4	153.8	281.4	319.1	461.4	630.6
400 V Three-Phase Class														
Model CIMR-V□4A		0001	0002	0004	0005	–	0007	0009	–	0011	0018	0023	0031	0038
Rated Output Current (A)		<1>	<2>	<2>	<2>	–	<2>	<2>	–	<2>	<2>	<2>	<2>	<2>
Generated Heat Loss	Heatsink Plate (W)	19.2	28.9	42.3	70.7	–	81.0	84.6	–	107.2	166.0	207.1	266.9	319.1
	Internal (W)	11.4	14.9	17.9	26.2	–	30.7	32.9	–	41.5	61.7	75.0	102.1	115.4
	Total (W)	30.6	43.8	60.2	96.9	–	111.7	117.5	–	148.7	227.7	282.1	369.0	434.5

<1> Carrier frequency is set to 10 kHz.

<2> Carrier frequency is set to 8 kHz.

# 4 Periodic Maintenance

---

## ◆ Replacement

Estimated drive performance life is based on specific usage conditions. These conditions are provided for the purpose of maximizing useful drive life and performance. Drive performance and/or useful life are affected by application in harsh environments or rigorous use.

### ■ Conditions for Estimating Performance Life

The estimated performance life of the drive is 10 years under the following conditions:

- Drive ambient temperature: Yearly average of 35°C
- Load factor: 80% max.
- Operation time: 24 hours a day

Drive performance life may be less than 10 years if drive use exceeds the conditions above.

# 5 Dimensions

**Table 8 V1000 Finless Dimensions for Models BA0001~2A0006 (metric)**

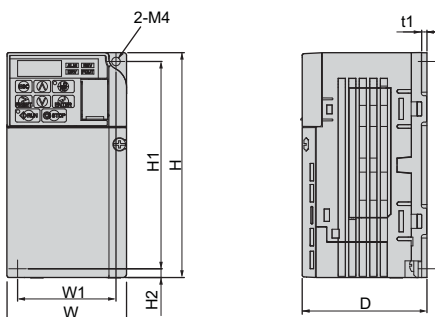

Voltage Class	Drive Model CIMR-V□	Dimensions (mm)							Weight (kg)
		W	H	D	W1	H1	H2	t1	
Single-Phase 200 V class	BA0001	68	128	71	56	118	5	3	0.6
	BA0002	68	128	71	56	118	5	3	0.6
	BA0003	68	128	81	56	118	5	3	0.8
Three-Phase 200 V class	2A0001	68	128	71	56	118	5	3	0.6
	2A0002	68	128	71	56	118	5	3	0.6
	2A0004	68	128	71	56	118	5	3	0.7
	2A0006	68	128	71	56	118	5	3	0.7

**Table 9 V1000 Finless Dimensions for Models BA0001~2A0006 (U.S. units)**

Voltage Class	Drive Model CIMR-V□	Dimensions (in)							Weight (lb.)
		W	H	D	W1	H1	H2	t1	
Single-Phase 200 V class	BA0001	2.68	5.04	2.80	2.21	4.65	0.20	0.12	1.32
	BA0002	2.68	5.04	2.80	2.21	4.65	0.20	0.12	1.32
	BA0003	2.68	5.04	3.19	2.21	4.65	0.20	0.12	1.76
Three-Phase 200 V class	2A0001	2.68	5.04	2.80	2.21	4.65	0.20	0.12	1.32
	2A0002	2.68	5.04	2.80	2.21	4.65	0.20	0.12	1.32
	2A0004	2.68	5.04	2.80	2.21	4.65	0.20	0.12	1.54
	2A0006	2.68	5.04	2.80	2.21	4.65	0.20	0.12	1.54

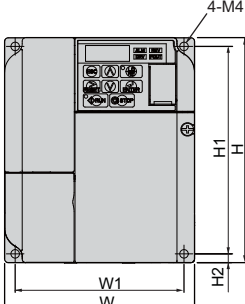
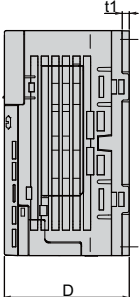

**Table 10 V1000 Finless Dimensions for Models BA0006~4A0009 (metric)**

Voltage Class	Drive Model CIMR-V□	Dimensions (mm)							
		W	H	D	W1	H1	H2	t1	Weight (kg)
Single-Phase 200 V class	BA0006	108	128	79.5	96	118	5	4	1.1
	BA0010	108	128	91	96	118	5	4	1.1
Three-Phase 200 V class	2A0008	108	128	71	96	118	5	4	1.0
	2A0010	108	128	71	96	118	5	4	1.0
	2A0012	108	128	79.5	96	118	5	4	1.0
Three-Phase 400 V class	4A0001	108	128	71	96	118	5	4	0.9
	4A0002	108	128	71	96	118	5	4	0.9
	4A0004	108	128	79.5	96	118	5	4	1.0
	4A0005	108	128	96	96	118	5	4	1.0
	4A0007	108	128	96	96	118	5	4	1.1
	4A0009	108	128	96	96	118	5	4	1.1

## 5 Dimensions

Table 11 V1000 Finless Dimensions for Models BA0006~4A0009 (U.S. units)

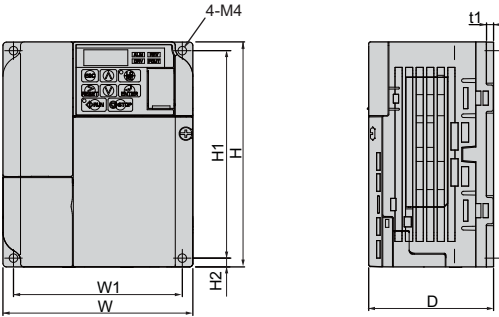

Voltage Class	Drive Model CIMR-V□	Dimensions (in)							Weight (lb.)
		W	H	D	W1	H1	H2	t1	
Single-Phase 200 V class	BA0006	4.26	5.04	3.13	3.78	4.65	0.20	0.16	2.43
	BA0010	4.26	5.04	3.59	3.78	4.65	0.20	0.16	2.43
Three-Phase 200 V class	2A0008	4.26	5.04	2.80	3.78	4.65	0.20	0.16	2.20
	2A0010	4.26	5.04	2.80	3.78	4.65	0.20	0.16	2.20
	2A0012	4.26	5.04	3.13	3.78	4.65	0.20	0.16	2.20
Three-Phase 400 V class	4A0001	4.26	5.04	2.80	3.78	4.65	0.20	0.16	1.98
	4A0002	4.26	5.04	2.80	3.78	4.65	0.20	0.16	1.98
	4A0004	4.26	5.04	3.13	3.78	4.65	0.20	0.16	2.20
	4A0005	4.26	5.04	3.78	3.78	4.65	0.20	0.16	2.20
	4A0007	4.26	5.04	3.78	3.78	4.65	0.20	0.16	2.43
	4A0009	4.26	5.04	3.78	3.78	4.65	0.20	0.16	2.43

**Table 12 V1000 Finless Dimensions for Models BA0012~4A0011(metric)**

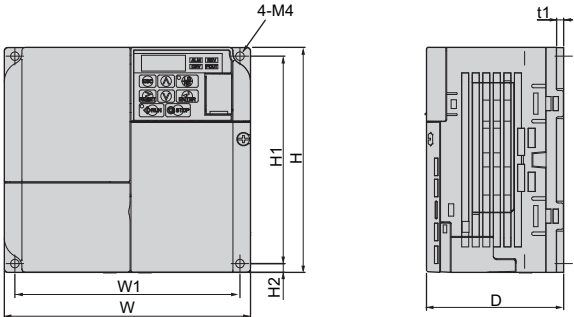

Voltage Class	Drive Model CIMR-V□	Dimensions (mm)							Weight (kg)
		W	H	D	W1	H1	H2	t1	
Single-Phase 200 V class	BA0012	140	128	98	128	118	5	4	1.4
Three-Phase 200 V class	2A0018	140	128	78	128	118	5	4	1.3
	2A0020	140	128	78	128	118	5	4	1.3
Three-Phase 400 V class	4A0011	140	128	78	128	118	5	4	1.3

**Table 13 V1000 Finless Dimensions for Models BA0012~4A0011 (U.S. units)**

Voltage Class	Drive Model CIMR-V□	Dimensions (in)							Weight (lb.)
		W	H	D	W1	H1	H2	t1	
Single-Phase 200 V class	BA0012	5.52	5.04	3.86	5.04	4.65	0.20	0.16	3.09
Three-Phase 200 V class	2A0018	5.52	5.04	3.07	5.04	4.65	0.20	0.16	2.87
	2A0020	5.52	5.04	3.07	5.04	4.65	0.20	0.16	2.87
Three-Phase 400 V class	4A0011	5.52	5.04	3.07	5.04	4.65	0.20	0.16	2.87

## 5 Dimensions

**Table 14 V1000 Finless Dimensions for Models 2A0030~4A0038 (metric)**

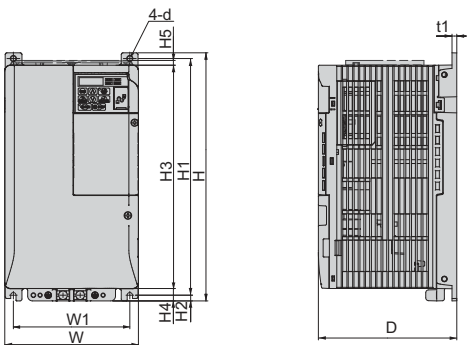

Voltage Class	Drive Model CIMR-V□	Dimensions (mm)											Weight (kg)
		W	H	D	W1	H1	H2	H3	H4	H5	d	t1	
Three-Phase 200 V class	2A0030	140	260	145	122	248	6	234	13	5	M5	5	3.2
	2A0040	140	260	145	122	248	6	234	13	5	M5	5	3.2
	2A0056	180	300	147	160	284	8	270	15	5	M5	5	4.6
	2A0069	220	350	152	192	336	7	320	15	5	M6	5	7.0
Three-Phase 400 V class	4A0018	140	260	145	122	248	6	234	13	5	M5	5	3.1
	4A0023	140	260	145	122	248	6	234	13	5	M5	5	3.2
	4A0031	180	300	147	160	284	8	270	15	5	M5	5	4.3
	4A0038	180	300	147	160	284	8	270	15	5	M5	5	4.6

**Table 15 V1000 Finless Dimensions for Models 2A0030~4A0038 (U.S. units)**

Voltage Class	Drive Model CIMR-V□	Dimensions (in)											Weight (lb.)
		W	H	D	W1	H1	H2	H3	H4	H5	d	t1	
Three-Phase 200 V class	2A0030	5.51	10.24	5.71	4.81	9.77	0.24	9.22	0.51	0.20	M5	0.20	7.06
	2A0040	5.51	10.24	5.71	4.81	9.77	0.24	9.22	0.51	0.20	M5	0.20	7.06
	2A0056	7.09	11.82	5.79	6.30	11.19	0.36	10.64	0.59	0.20	M5	0.20	10.14
	2A0069	8.69	13.79	5.99	7.56	13.24	0.28	12.61	0.59	0.20	M6	0.20	15.43
Three-Phase 400 V class	4A0018	5.51	10.24	5.71	4.81	9.77	0.24	9.22	0.51	0.20	M5	0.20	6.83
	4A0023	5.51	10.24	5.71	4.81	9.77	0.24	9.22	0.51	0.20	M5	0.20	7.06
	4A0031	7.09	11.82	5.79	6.30	11.19	0.36	10.64	0.59	0.20	M5	0.20	9.48
	4A0038	7.09	11.82	5.79	6.30	11.19	0.36	10.64	0.59	0.20	M5	0.20	10.14

## 6 Selecting an External Heatsink

This section describes the selection of a suitable external heatsink when using a V1000 Finless drive.

### ◆ Data Required for Heatsink Selection

The table below shows data that are needed to select a heatsink that suits drive and application.

Symbol	Description
$P_{Loss}$	Drive heat loss <i>Refer to V1000 Finless Drive Watt Loss Thermal Characteristics on page 13</i> to check the amount of heat loss from the heatsink plate of the drive.
$T_{HSP\_max}$	Maximum heatsink plate temperature This is the temperature at the surface of the heatsink plate. It can be monitored with U4-08. The maximum allowable value depends on drive model. CIMR-V□BA□□□□, CIMR-V□2A0001~0020, CIMR-V□4A0001~0011: 90°C CIMR-V□2A0030~0069, CIMR-V□4A0018~0038: 80°C
$T_{Amb}$	External heatsink ambient temperature (air temperature around heatsink)
$R\theta_{HSP}$	Heatsink plate thermal resistance This value is 0.05 K/W
$R\theta_{HSP-EHS}$	Thermal resistance between the heatsink plate and the external heatsink Can be calculated by $R\theta_{HSP-EHS} = \frac{d_{Comp}}{\lambda_{comp} \cdot A_{th}}$
	$A_{th}$ Heat transfer area between drive heatsink plate and external heatsink Note: Due to uneven heat generation across the heatsink plate (by arrangement of internal components) the effective area for heat transfer is only ~70% of heatsink plate area. This must be considered when calculating the thermal resistance. Refer to <i>Dimensions on page 16</i> for values of H and W to calculate the area of the heatsink plate.
	$\lambda_{Comp}$ Thermal conductivity of the heatsink thermal compound
	$d_{Comp}$ Thickness of the thermal compound
$R\theta_{EHS}$	Thermal resistance of the external heatsink

## 6 Selecting an External Heatsink

### ◆ External Heatsink Selection

Figure 6 shows the heat transfer principle from the drive heatsink plate to the heatsink ambient air.

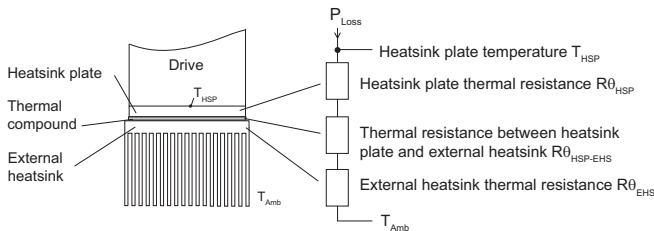

Figure 6 Thermal Equivalent Circuit

For a given ambient temperature the heatsink plate temperature must not exceed the maximum allowable value. As the  $R_{\theta_{HSP}}$  and  $R_{\theta_{HSP-EHS}}$  are essentially fixed, this condition must be satisfied with proper heatsink selection.

#### ■ Select an External Heatsink by the Thermal Resistance

Use the formula below to calculate the maximum thermal resistance  $R_{\theta_{EHS\_max}}$ .

$$R_{\theta_{EHS\_max}} = \left( \frac{T_{HSP\_max} - T_{Amb}}{P_{Loss}} - R_{\theta_{HSP}} - R_{\theta_{HSP-EHS}} \right)$$

Select a heatsink with a smaller thermal resistance than  $R_{\theta_{EHS\_max}}$ . The heatsink height and width should be close to the drive dimensions. If the selected heatsink has a thermal resistance that is too high, then choose a heatsink with a different shape (e.g. longer or more fins). Compare the actual mounting conditions with the ones mentioned for the  $R_{\theta_{EHS}}$  value in the heatsink specifications and apply reduction factors if necessary. Also remember that the heatsink cooling ability can reduce by time due to dirt.

**NOTICE:** If the heatsink height and width are much larger than the drive heatsink plate dimensions or if multiple drives are installed on one heatsink, it may be necessary to apply correction factors to the thermal resistance value given in the heatsink specification. Consult the heatsink manufacturer.

#### ■ Check the Feasibility of a Given Heatsink

If a heatsink is given or the selection is limited by the installation conditions (space available etc.) use the formula below to calculate the actual heatsink plate temperature.

$$T_{HSP} = P_{Loss} \cdot (R_{\theta_{HSP}} + R_{\theta_{HSP-EHS}} + R_{\theta_{EHS}}) + T_{Amb}$$

If  $T_{HSP}$  is smaller than the maximum allowable heatsink plate temperature, the selected heatsink can be used. For verification of temperature, refer to [Checking and Monitoring Heatsink Plate Temperature on page 8](#).

## 6 Selecting an External Heatsink

**NOTICE:** Due to uneven compound thickness, uneven heat generation across the heatsink plate or other factors, the actual heatsink plate temperature (monitored in U4-08) can be slightly different from the calculated value. An oH drive fault may occur if the heatsink plate temperature exceeds the maximum allowable value.

### ◆ Heatsink Selection Example

This example shows heatsink selection for a CIMR-V□2A0006 drive in Normal Duty (ND) mode. The data required are listed in the table below.

Item	Value	
$P_{Loss}$	27.5 W	
$T_{HSP\_max}$	90°C	
$T_{Amb}$	40°C	
$R\theta_{HSP}$	0.05 K/W	
$R\theta_{HSP\_EHS}$	$A_{th}$	H = 128 mm, D = 68 mm, $A_{th} = 0.7 \cdot 0.128 \text{ m} \cdot 0.068 \text{ m} = 6.1 \cdot 10^{-3} \text{ m}^2$
	$\lambda_{Comp}$	0.8 W/(m·K) Thermal conductivity of “Thermal Compound G746” (Shin-Etsu Chemical Co., Ltd)
	$d_{Comp}$	Recommended compound thickness: 100 μm
	$R\theta_{HSP\_EHS} = \frac{100 \text{ μm}}{0.8 \text{ W}/(\text{m}\cdot\text{K}) \times 6.1 \times 10^{-3} \text{ m}^2} = 0.02 \text{ K/W}$	

## 6 Selecting an External Heatsink

---

### ■ Heatsink Selection by Thermal Resistance

Substituting the example values into the formula gives:

$$R\theta_{\text{EHS\_max}} = \left( \frac{90^{\circ}\text{C} - 40^{\circ}\text{C}}{27.5 \text{ W}} - 0.05 \text{ K/W} - 0.02 \text{ K/W} \right) = 1.74 \text{ K/W}$$

The heatsink must have a thermal resistance lower than 1.7 K/W. When selecting the heatsink apply a safety margin to the calculated value in order to ensure tripless drive operation, even if the installation conditions change (temporary higher temperature, loss of cooling ability of the external heatsink due to dust, etc.).

### ■ Feasibility Check of a Selected Heatsink

If for example a heatsink with  $R\theta_{\text{EHS}} = 1.6 \text{ K/W}$  is selected, the heatsink temperature will be:

$$T_{\text{HSP}} = 27.5 \text{ W} \cdot (0.05 \text{ K/W} + 0.02 \text{ K/W} + 1.6 \text{ K/W}) + 40^{\circ}\text{C} = 85.9^{\circ}\text{C}$$

The selected heatsink can be used, but considering that the heatsink area is probably larger than the drive footprint and the ambient conditions could change (reduced heatsink cooling ability by dirt, etc.), a heatsink with a lower  $R\theta_{\text{EHS}}$  (e.g.  $R\theta_{\text{EHS}} = 1.1 \text{ K/W}$ , resulting in  $T_{\text{HSP}} = 72.2^{\circ}\text{C}$ ) should be chosen.













## 7 Revision History

The revision dates and the numbers appear on the bottom of the back cover.

MANUAL NO. TOBP C710606 21B

Published in Japan July 2007 07-4 

Place of publication | Date of publication | Date of original publication | Revision number

Date of Publication	Rev. No.	Section	Revised Content
January 2013		Back cover	Revision: Address
December 2011		Back cover	Revision: Address
November 2011		All Chapters	Corrections: Reviewed and corrected entire documentation.
June 2011		Front cover, back cover	Revision: Format
September 2010		Chapter 3	Revision: Thermal Compound
July 2010		Back cover	Revision: Address
December 2009		Revision History	Revision: Example of the revision dates and the numbers
July 2008		Back cover	Revision: Revision number
June 2008		Chapter 1	Corrections: Drive Model Identification
		Chapter 2	Corrections: Installation Environment
March 2008		All Chapters	New: Protective enclosure data (IP00) New models: 3-phase 200 V: CIMR-V□2A0030 - 2A0069 3-phase 400 V: CIMR-V□4A0018 - 4A0038
		Chapter 2	Corrections: Settings for H4-01 in Table 1. New: Warning for the heatsink plate temperature Overheat prealarm
		Chapter 3	New: Maintenance information
		Chapter 6	Revision: Selecting an External Heatsink
July 2007		Chapter 2	Addition: Checking the Temperature of Heatsink Plate of Drive (software version 1011 or later)
		Chapter 4	Addition: Selecting an External Heatsink
April 2007	–	–	First edition

# YASKAWA AC Drive - V1000

## Compact Vector Control Drive Finless Type Installation Guide

---

### DRIVE CENTER (INVERTER PLANT)

2-13-1, Nishimiyachi, Yukufashi, Fukuoka, 824-8511, Japan  
Phone: 81-930-25-3844 Fax: 81-930-25-4369  
<http://www.yaskawa.co.jp>

### YASKAWA ELECTRIC CORPORATION

New Pier Takeshiba South Tower, 1-16-1, Kaigan, Minatoku, Tokyo, 105-6891, Japan  
Phone: 81-3-5402-4502 Fax: 81-3-5402-4580  
<http://www.yaskawa.co.jp>

### YASKAWA AMERICA, INC.

2121 Norman Drive South, Waukegan, IL 60085, U.S.A.  
Phone: (800) YASKAWA (827-5292) or 1-847-887-7000 Fax: 1-847-887-7310  
<http://www.yaskawa.com>

### YASKAWA ELÉTRICO DO BRASIL LTDA.

Avenda Fagundes Filho, 620 Bairro Saudes, São Paulo, SP04304-000, Brazil  
Phone: 55-11-3585-1100 Fax: 55-11-5581-8795  
<http://www.yaskawa.com.br>

### YASKAWA EUROPE GmbH

Hauptstrasse 185, 65760 Eschborn, Germany  
Phone: 49-6196-569-300 Fax: 49-6196-569-398  
<http://www.yaskawa.eu.com>

### YASKAWA ELECTRIC UK LTD.

1 Hunt Hill Orchardton Woods, Cumbernauld, G68 9LF, United Kingdom  
Phone: 44-1236-735000 Fax: 44-1236-458182  
<http://www.yaskawa.co.uk>

### YASKAWA ELECTRIC KOREA CORPORATION

9F Kyobo Securities Bldg., 26-4, Yeouido-dong, Yeongdeungpo-gu, Seoul, 150-737, Korea  
Phone: 82-2-784-7844 Fax: 82-2-784-8495  
<http://www.yaskawa.co.kr>

### YASKAWA ELECTRIC (SINGAPORE) PTE. LTD.

151 Lorong Chuan, #04-01, New Tech Park, 556741, Singapore  
Phone: 65-6282-3003 Fax: 65-6289-3003  
<http://www.yaskawa.com.sg>

### YASKAWA ELECTRIC (CHINA) CO., LTD.

12F, Carlton Bld., No.21 HuangHe Road, HuangPu District, Shanghai 200003, China  
Phone: 86-21-5385-2200 Fax: 86-21-5385-2399  
<http://www.yaskawa.com.cn>

### YASKAWA ELECTRIC (CHINA) CO., LTD. BEIJING OFFICE

Room 1011, Tower W3 Oriental Plaza, No. 1 East Chang An Ave.,  
Dong Cheng District, Beijing, 100738, China  
Phone: 86-10-8518-4086 Fax: 86-10-8518-4082

### YASKAWA ELECTRIC TAIWAN CORPORATION

9F, 16, Nanking E. Rd., Sec. 3, Taipei, 104, Taiwan  
Phone: 886-2-2502-5003 Fax: 886-2-2505-1280

### YASKAWA ELECTRIC INDIA PRIVATE LIMITED

#17/A Electronics City, Hosur Road Bangalore 560 100 (Karnataka), India  
Phone: 91-80-4244-1900 Fax: 91-80-4244-1901  
<http://www.yaskawaindia.in>

---



YASKAWA ELECTRIC CORPORATION

In the event that the end user of this product is to be the military and said product is to be employed in any weapons systems or the manufacture thereof, the export will fall under the relevant regulations as stipulated in the Foreign Exchange and Foreign Trade Regulations. Therefore, be sure to follow all procedures and submit all relevant documentation according to any and all rules, regulations and laws that may apply.

Specifications are subject to change without notice for ongoing product modifications and improvements.

© 2007-2013 YASKAWA ELECTRIC CORPORATION. All rights reserved.

MANUAL NO. TOBP C710606 21E

Published in Japan January 2013 07-4 ◊-0  
12-7-9