

SUBJECT: Application Note	PRODUCT: CM049	DOC#: AN.AFD.23
TITLE: Setting the CM049 BACnet Device Object Instance Identifier		08/01/2011

Application Note:

Setting the CM049 BACnet Device Object Instance Identifier

Applicable Options(s): CM049
Applicable Drive(s): E7, P7

This page intentionally left blank

Table of Contents

Overview	1
Intended Audience	1
Device Address	1
BACnetObjectIdentifier	1
CM049.....	2
<i>Overview</i>	<i>2</i>
<i>Set Device Address</i>	<i>2</i>
<i>Verify CM049 Version</i>	<i>2</i>
<i>Set Device Object Instance Identifier.....</i>	<i>2</i>
<i>Device Object Instance Identifier Setting Tools.....</i>	<i>2</i>
CAS BACnet Explorer™	3
<i>Install/Run</i>	<i>3</i>
<i>Settings</i>	<i>4</i>
<i>Setup Network.....</i>	<i>4</i>
<i>Setup Preferences.....</i>	<i>4</i>
<i>Discover</i>	<i>5</i>
<i>Add Device Object.....</i>	<i>5</i>
<i>Device Object Properties</i>	<i>5</i>
<i>Send the message.....</i>	<i>5</i>
<i>Modify the Object Identifier</i>	<i>6</i>
<i>WriteProperty Values.....</i>	<i>6</i>
<i>Refresh the Display</i>	<i>7</i>
<i>Verified Device Object Instance Identifier.....</i>	<i>8</i>

Table of Figures

FIGURE 1 – SAMPLE BACNET MS/TP NETWORK.....	1
FIGURE 2 – SAMPLE MS/TP SETUP.....	3
FIGURE 3 – CAS BACNET EXPLORER MAIN DIALOG BOX.....	3
FIGURE 4 – NETWORK SETTINGS DIALOG BOX.....	4
FIGURE 5 – PREFERENCES SETTINGS DIALOG BOX.....	4
FIGURE 6 – ADD DEVICE OBJECT.....	5
FIGURE 7 – DEVICE OBJECT PROPERTIES.....	5
FIGURE 8 – WRITEPROPERTY.....	6
FIGURE 9 – WRITEPROPERTY VALUES.....	6
FIGURE 10 – REFRESH THE DISPLAY.....	7
FIGURE 11 – VERIFIED DEVICE OBJECT INSTANCE IDENTIFIER.....	8

References

Yaskawa America, Inc. – www.yaskawa.com

TM.E7.01	E7 Drive User Manual
TM.E7.02	E7 Drive Programming Manual

TM.P7.01	P7 Drive User Manual
TM.P7.02	P7 Drive Programming Manual

IG.AFD.23	CM049 Installation Guide
-----------	--------------------------

Chipkin Automation Systems, Inc. – www.chipkin.com
CAS BACnet Explorer™

Cimetrics™ – www.cimetrics.com
BACnet Explorer

Visual Test Shell (VTS) – www.sourceforge.com

BACnet® is a registered trademark of American Society of Heating, Refrigerating and Air-Conditioning Engineers (ASHRAE).

Overview

This document contains a basic description of the BACnet Device Object Instance Identifier and how it is programmed in the Yaskawa CM049 BACnet option.

Intended Audience

This document is intended for those involved in commissioning a BACnet system and assumes that the reader is familiar with Yaskawa AC Drives, BACnet Objects and Properties and their programming. Familiarity with the CM049 installation guide, IG.AFD.23, is highly recommended.

Device Address

A BACnet MS/TP master device must have an address between 1 and the Device Object Max_Master property, a maximum of 127. This value is the BACnet MAC address and the device DADR (Destination Address). It must be unique on the local MS/TP network.

BACnetObjectIdentifier

All BACnet objects must have an instance identifier that is unique within the device. The Device Object must have an instance identifier that is unique system wide. The Device Object Instance Identifier is of type BACnetObjectIdentifier and must be a value between 1 and 4,194,302 (1 and 3F FFFh) inclusive. Address 4,194,303 (3F FFFh) is reserved.

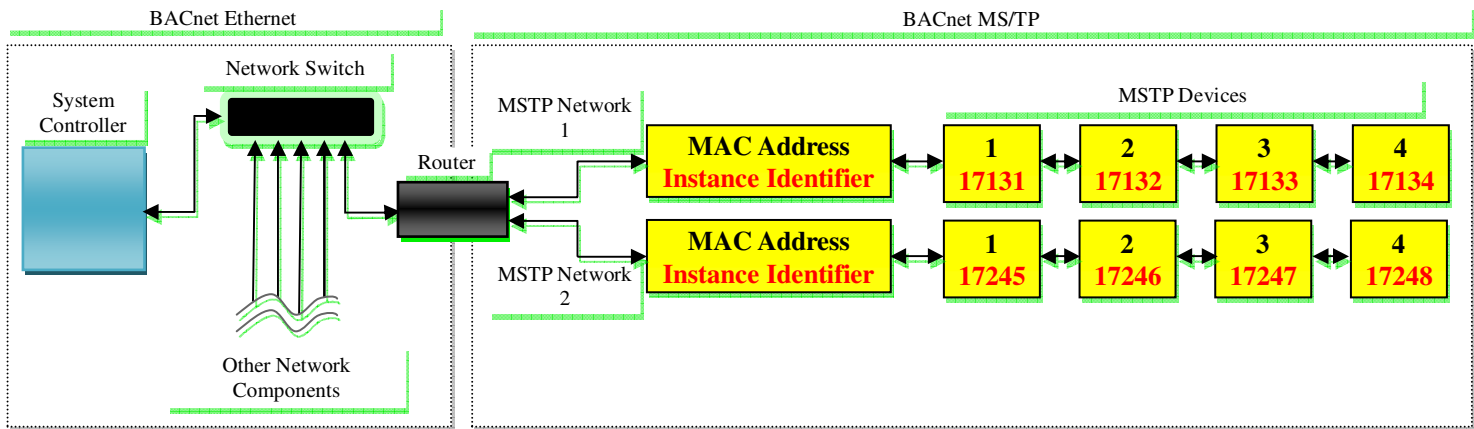

Figure 1 – Sample BACnet MS/TP Network

CM049

Overview

The CM049 is the BACnet interface for the Yaskawa 7 series AC Drives. It is an option card that mounts on the drive's control board and connects to the BACnet MS/TP network. The CM049 then connects to the drive's RS485 communications terminals. Refer to IG.AFD.23 for CM049 installation instructions.

If the CM049 Device Object Instance Identifier has not previously been programmed, it is set to the MAC address as set by the dip switches upon power up.

Set Device Address

The CM049 MAC address is set via the dip switches on the front of the card. Switches 1 through 7 represent the MAC address in hexadecimal. Switches 8 through 10 set the baud rate at which the CM049 will communicate on the BACnet network. No two devices on the MS/TP segment may have the same MAC address. Power cycle the drive to enable the address and baud rate.

Verify CM049 Version

The version of the CM049 that supports programmable Device Object Instance Identifier is VST800201 or later/ Send a ReadProperty message to the Device Object, Application_Software_Version property. The response should be "VST80020x". Consult your Yaskawa representative if the response is otherwise.

Set Device Object Instance Identifier

The Device Object Instance Identifier is used to identify the device on the network. No two devices may have the same Device Object Instance Identifier. The CM049 Device Object Instance Identifier must be set over the MS/TP network. A WriteProperty message is sent to the Device Object, object_identifier property with the desired values. If the current Device Object Instance Identifier is not known, send a ReadProperty message to the CM049 Device Object, Object Identifier property with a Device Object Instance Identifier of 4,194,303.

Device Object Instance Identifier Setting Tools

There are many tools available for setting the Device Object Instance Identifier. VTS, Visual Test Shell, is the current testing tool recommended by the BTL and is available from SourceForge.net as a free download. Chipkin Automation Systems, Inc. and Cimetrix, Inc. are two companies that provide both hardware and software interfaces to BACnet networks. Chipkin's *CAS BACnet Explorer*TM will be used in the examples shown below.

CAS BACnet Explorer™

CAS BACnet Explorer™ is a software tool that may be purchased from Chipkin Automation Systems, Inc., www.chipkin.com, that allows reading and writing property values over BACnet networks. In the example below the connection is made directly to the MS/TP network containing the device that is to have its Device Object Instance Identifier programmed. Any RS232/USB to RS485 converter may be used to connect to the MS/TP network.

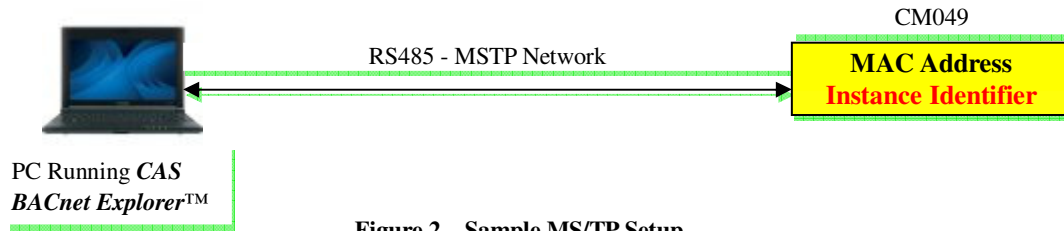

Figure 2 – Sample MS/TP Setup

Install/Run

Run the CAS BACnet Explorer installation program. Once installed, run the program. A dialog box similar to the one shown below will be displayed.

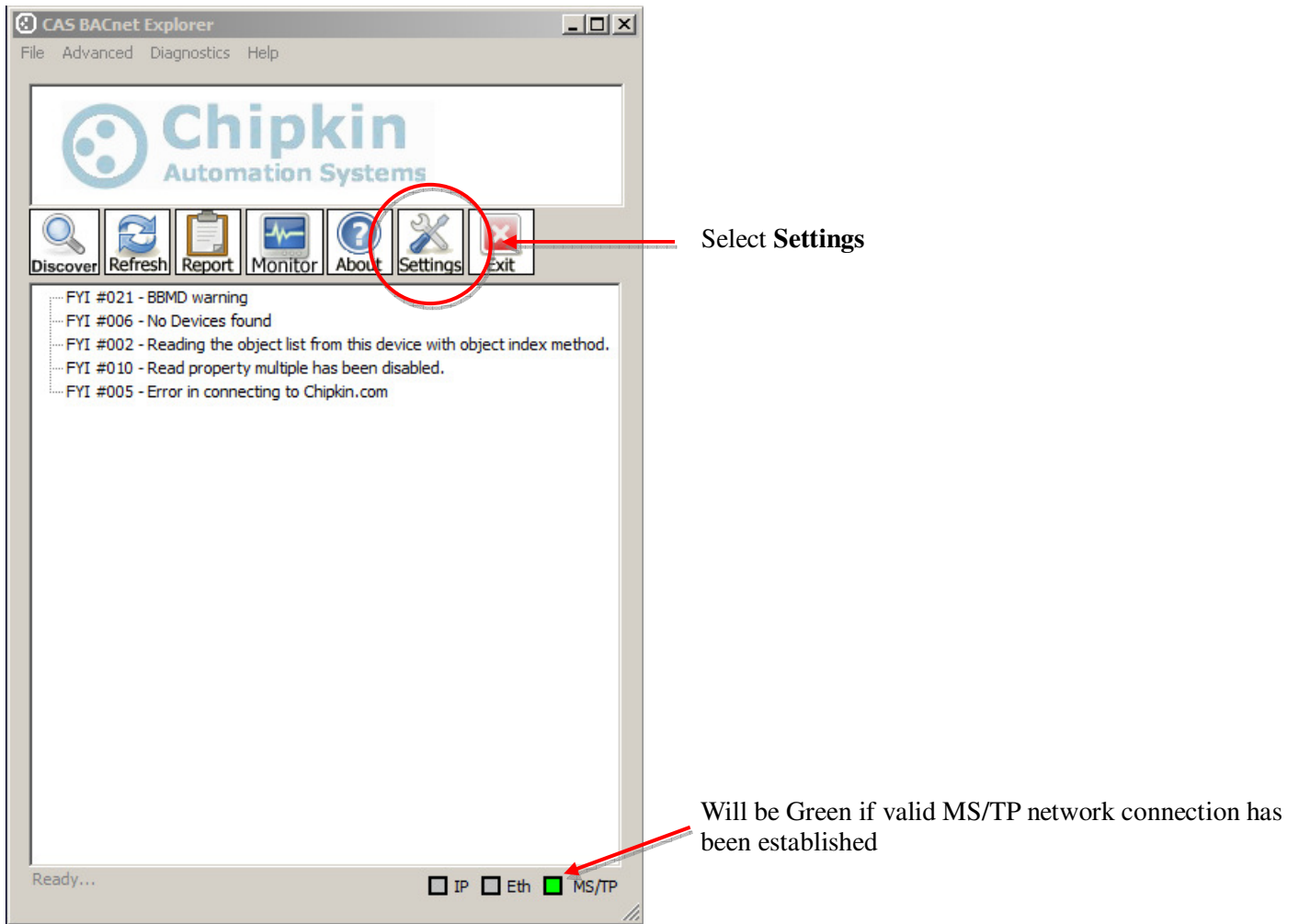

Figure 3 – CAS BACnet Explorer Main Dialog Box

Settings

Select the **Settings** button from the row of buttons at the top of the main dialog box opening the dialog box shown below.

Setup Network

1: Select **Network** from the menu to the left.

2: Select the type of network **BACnet MS/TP** is selected for this example.

3: Select the communication port that is connected to the MS/TP network.

4: Set the baud rate.

5: Set the MAC address used for the PC running the software.

6: Select **Apply**

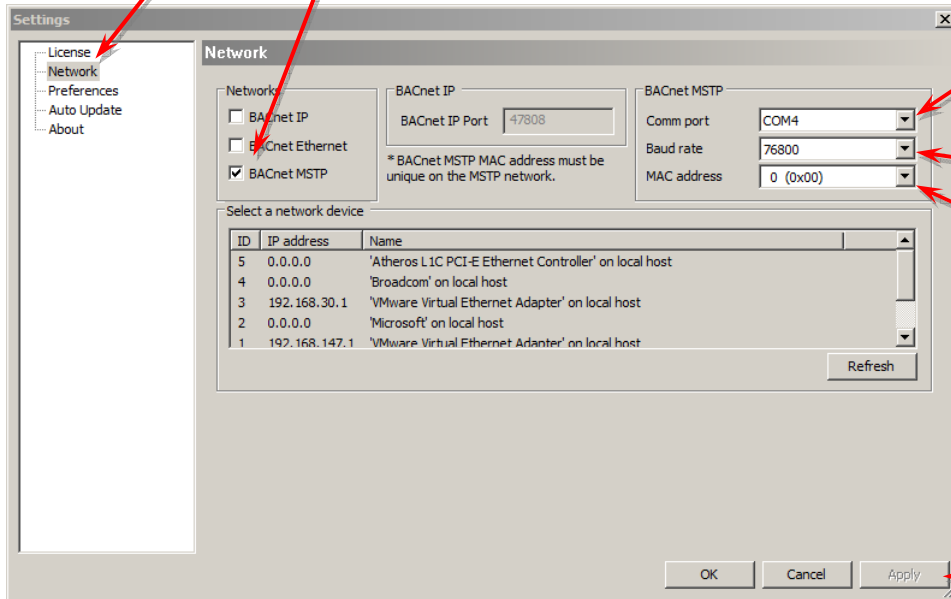

Figure 4 – Network Settings Dialog Box

Setup Preferences

1: Select **Preferences** from the menu to the left.

2: Uncheck **ReadPropertyMultiple** as it is not supported in the CM049.

3: Select **Apply** then **OK**

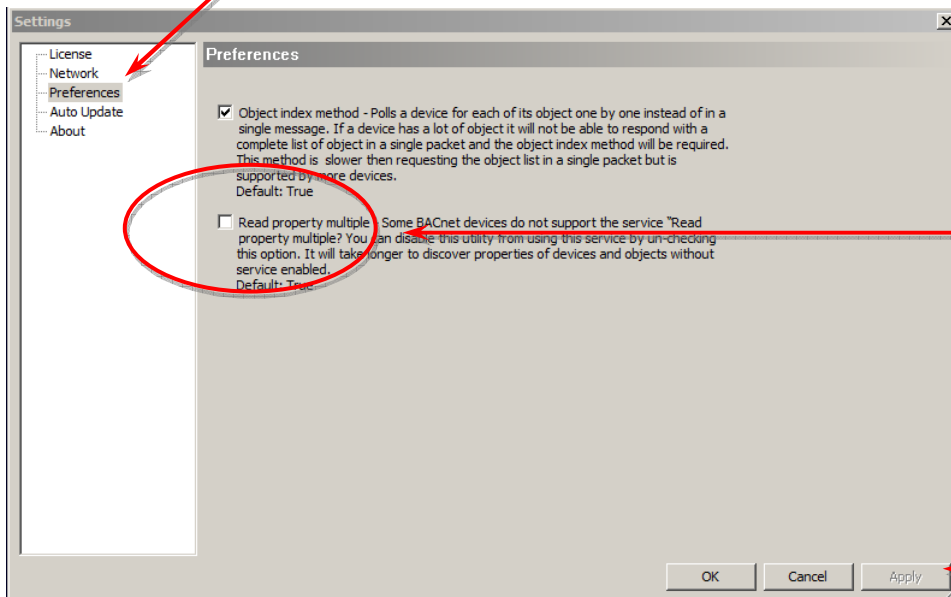

Figure 5 – Preferences Settings Dialog Box

Discover

Select **Discover** from the main dialog box button bar.

Add Device Object

Select **Manually Add Device Object**

Figure 6 – Add Device Object

Device Object Properties

1: Select **BACnet MSTP** as the **Network Type**

2: Select the **Device** as the **Object Type**

3: Enter the **MAC Address** of the device to be programmed

4: Enter the desired **Device Instance**. 4194303 is shown here as the actual Device Instance is not known.

5: Verify the information entered and select **Add**

Figure 7 – Device Object Properties

Send the message

Select the **Send** button from the **Discover - Add Device Object** dialog as shown in Figure 6 above.

Modify the Object Identifier

The dialog box below shows the device object that we selected in the dialog boxes above. To change the Object Identifier property:

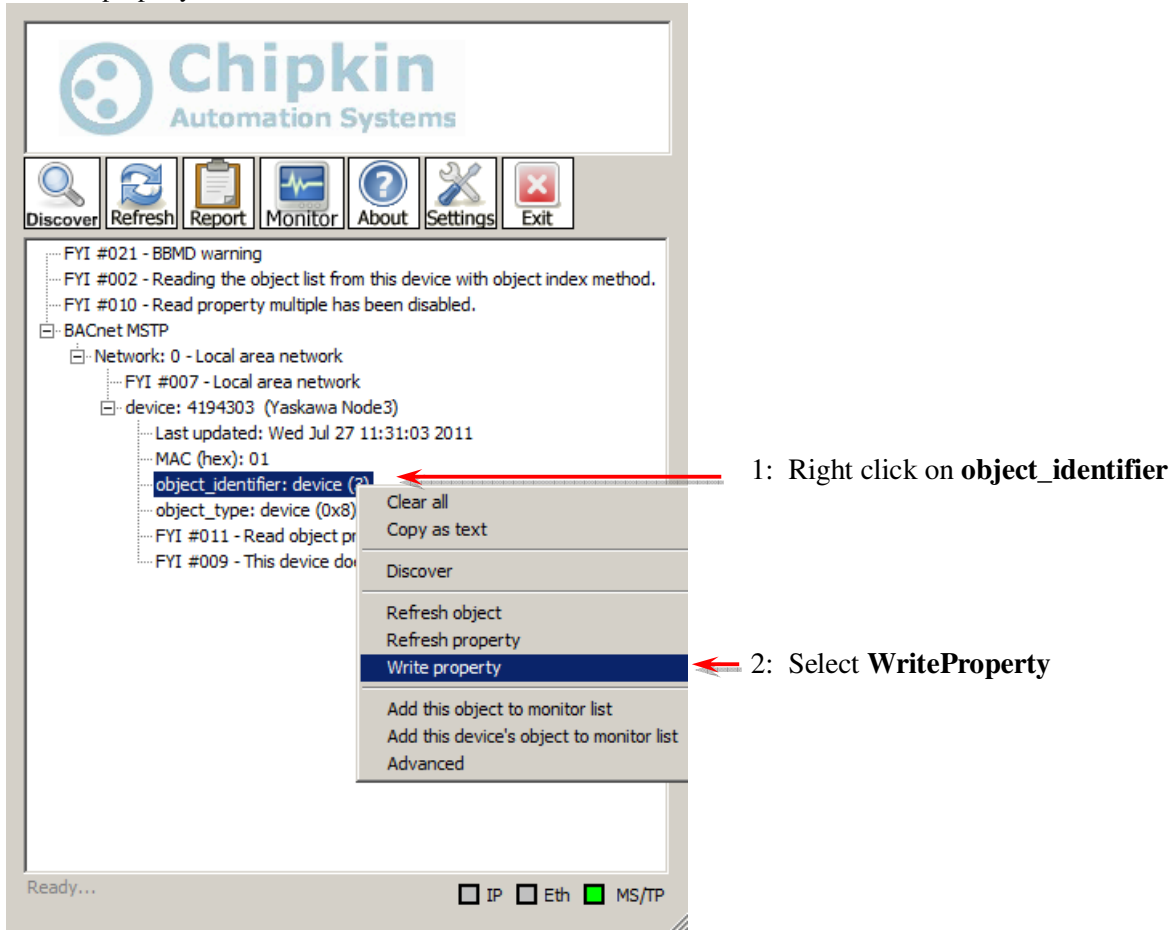

Figure 8 – WriteProperty

WriteProperty Values

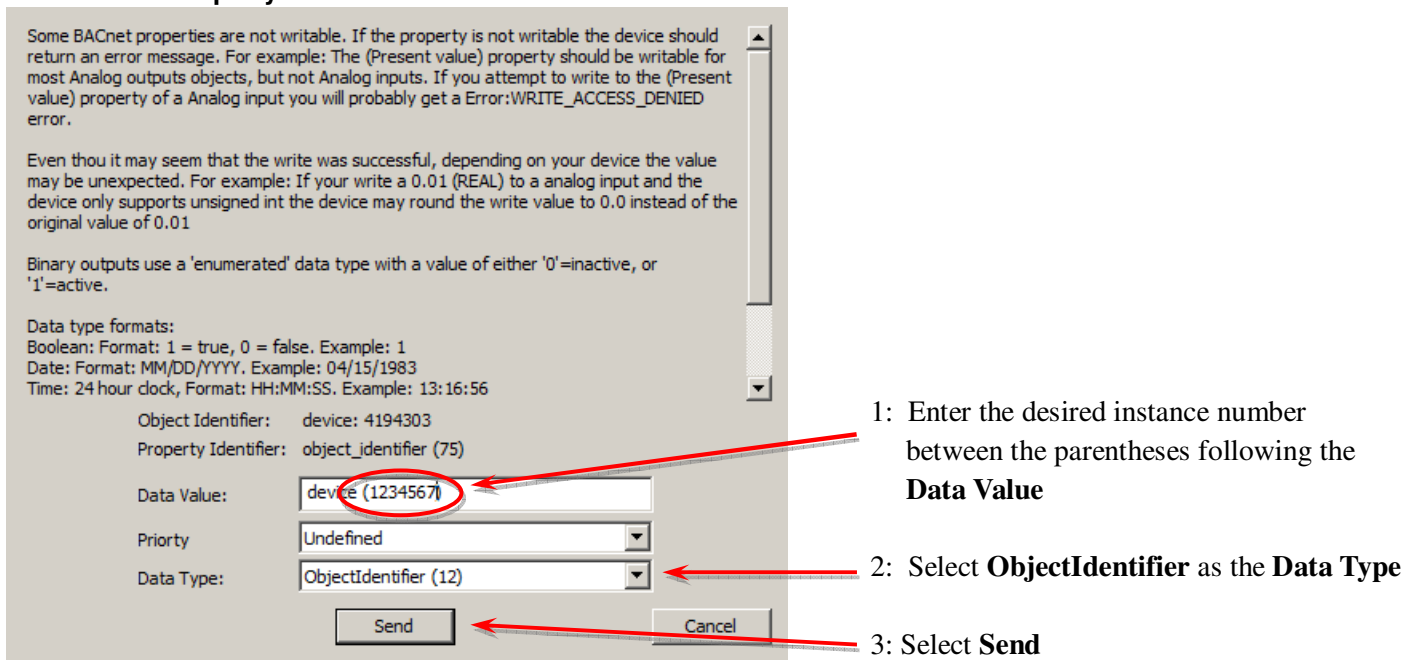

Figure 9 – WriteProperty Values

Refresh the Display

Verify that the `object_identifier` has been properly changed.

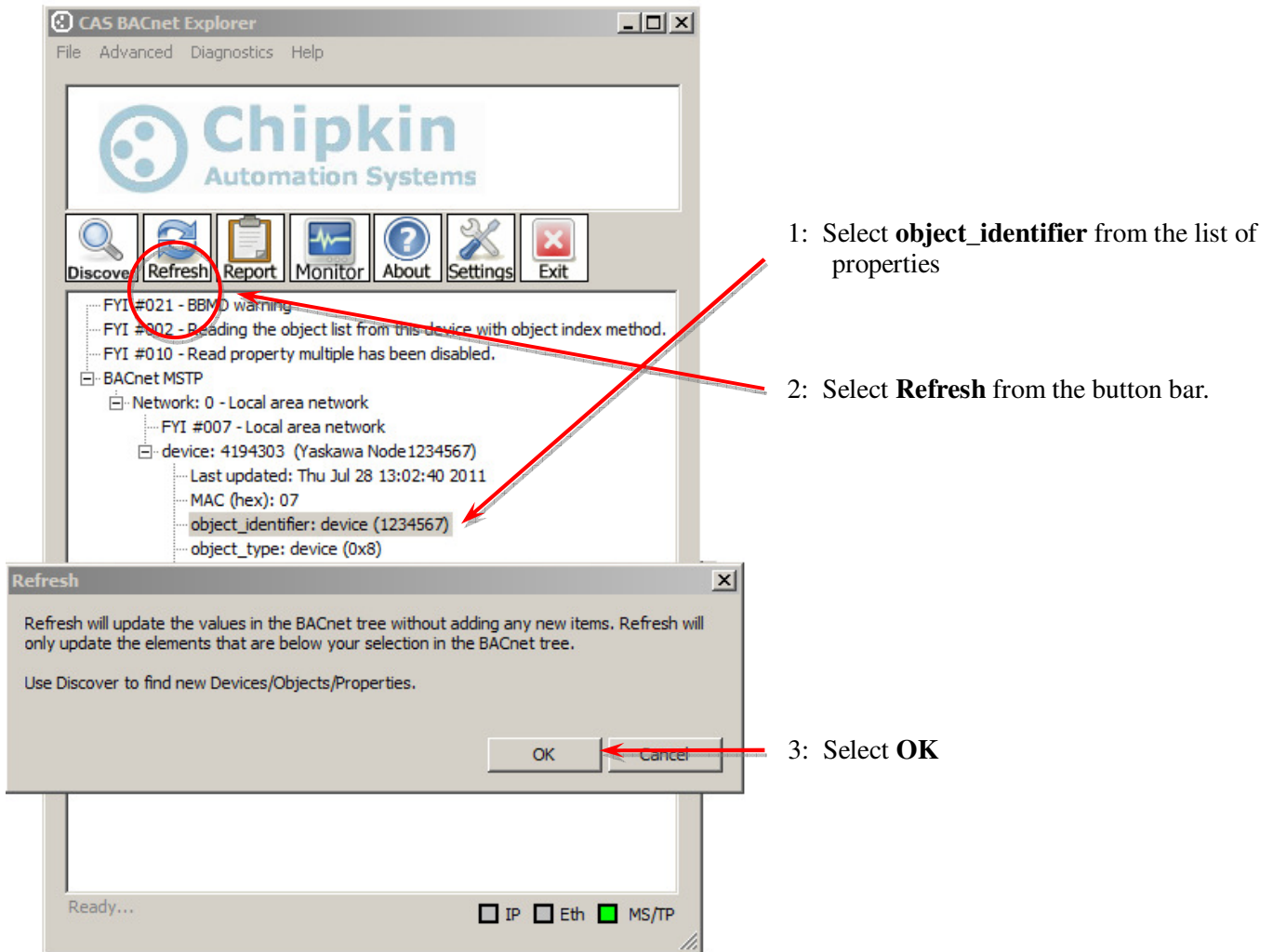

Figure 10 – Refresh the Display

Verified Device Object Instance Identifier

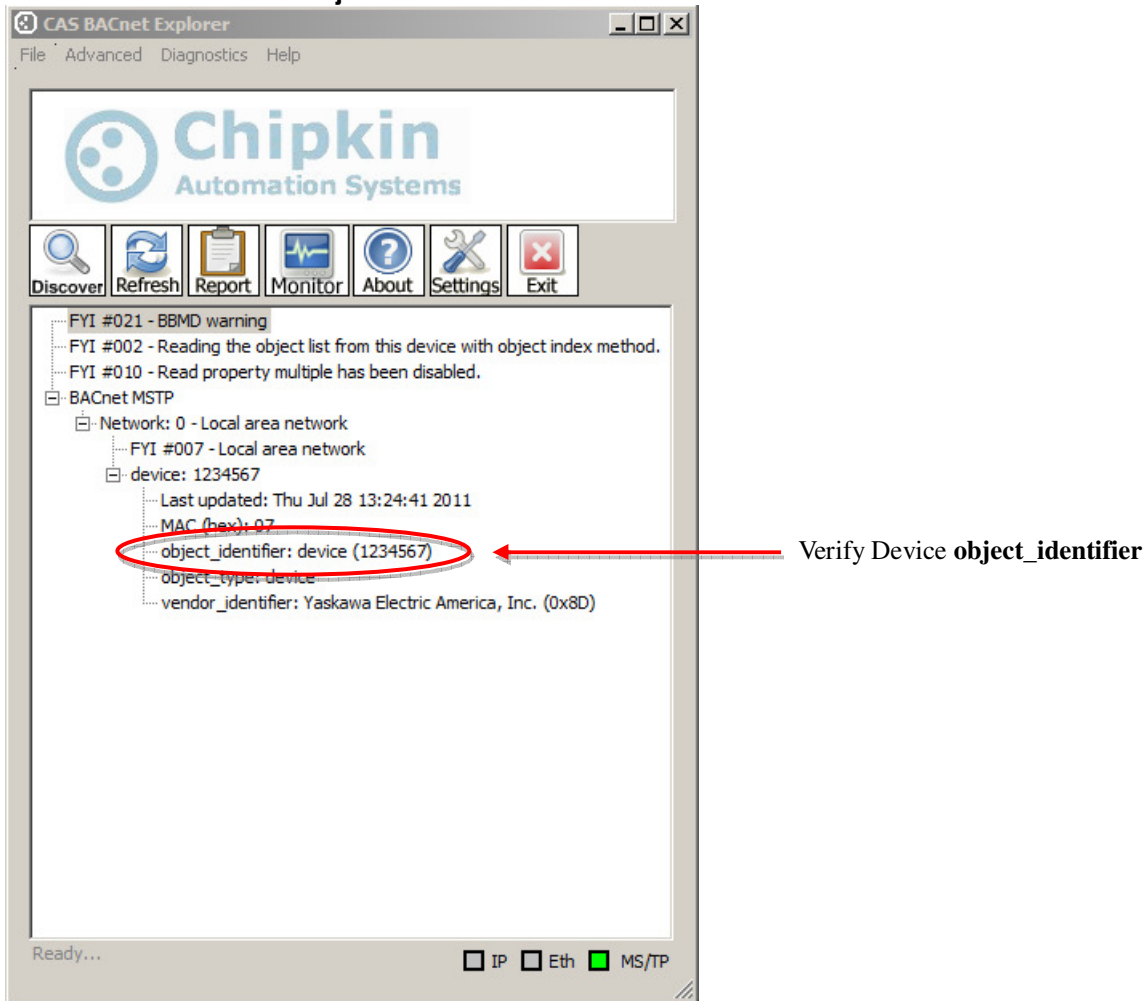

Figure 11 – Verified Device Object Instance Identifier

This page intentionally left blank

USE OF TECHNICAL INFORMATION!

Technical content and illustrations are provided as technical advice to augment the information in manual, not supercede it. The information described in this document is subject to change without notice. Yaskawa assumes no responsibility for errors or omissions or damages resulting from the use of the information contained in any technical document. All warnings, cautions and product instruction for product use must be followed. Qualified personnel should carry out installation, operation and maintenance.¹