

# YASKAWA

# HV600 DRIVE

## TECHNICAL REFERENCE

AC DRIVE FOR HVAC FAN  
AND PUMP APPLICATIONS

### CATALOG CODE:

HV60Uxxxxxxx

### CAPACITIES:

208 V class: 2.2 to 75 kW (3 to 100 HP)

480 V class: 2.2 to 186 kW (3 to 250 HP)

PDF

[yaskawa.com/SIEPC71061732](http://yaskawa.com/SIEPC71061732)



Simplify Drive Installation  
Get DriveWizard® Mobile



<https://www.yaskawa.com/dwm>

DOCUMENT NUMBER: SIEPC71061732

---

**This Page Intentionally Blank**



# Table of Contents

i.	Preface and General Precautions . . . . .	15
i.1	Receiving . . . . .	16
	Glossary . . . . .	16
	About Registered Trademarks . . . . .	16
i.2	Using the Product Safely . . . . .	17
	Explanation of Signal Words . . . . .	17
	General Safety . . . . .	17
	Warning Label Content and Location . . . . .	19
	Cybersecurity . . . . .	21
i.3	Warranty Information . . . . .	22
	Exclusion of Liability . . . . .	22
1.	Receiving . . . . .	23
1.1	Section Safety . . . . .	24
1.2	Catalog Code and Nameplate Check . . . . .	25
	Nameplate . . . . .	25
	How to Read Catalog Codes . . . . .	25
	Features and Advantages of Control Methods . . . . .	27
2.	Mechanical Installation . . . . .	29
2.1	Section Safety . . . . .	30
2.2	Installation Environment . . . . .	32
2.3	Installation Position and Distance . . . . .	33
	Single Drive Installation . . . . .	33
	Side-by-Side Installation . . . . .	33
	Installing More than One Drive Adjacent to Each Other without Derating . . . . .	35
	Remove the Top Protective Cover: 2011 to 2114, 4005 to 4052, and 4077 to 4124 . . . . .	35
	Remove the Top Protective Cover: 2143, 2169, and 4156 . . . . .	36
2.4	Moving the Drive . . . . .	37
	Using the Hanging Brackets to Move the Drive . . . . .	37
	Instructions on Drive Suspension . . . . .	37
2.5	Remove and Reattach the Keypad . . . . .	40
	Remove the Keypad . . . . .	40
	Reattach the Keypad . . . . .	40
2.6	Install the Keypad in a Control Panel or Another Device . . . . .	41
	Operate the Keypad from a Remote Location . . . . .	41
	Connect the Keypad from a Remote Location . . . . .	41
2.7	Removing/Reattaching Covers . . . . .	46
	Removing/Reattaching the Cover Using Procedure A . . . . .	46

	Removing/Reattaching the Cover Using Procedure B .....	47
	Removing/Reattaching the Cover Using Procedure C .....	50
2.8	Change the Drive Enclosure Type .....	54
2.9	Installation Methods .....	55
	Standard Installation .....	55
	External Heatsink Installation .....	55
<b>3.</b>	<b>Electrical Installation .....</b>	<b>57</b>
3.1	Section Safety .....	58
3.2	Electrical Installation .....	60
	Standard Connection Diagram .....	60
3.3	Main Circuit Wiring .....	65
	Motor and Main Circuit Connections .....	65
	Configuration of Main Circuit Terminal Block .....	68
	Main Circuit Terminal Functions .....	75
	Wire Selection .....	75
	Main Circuit Terminal and Motor Wiring .....	84
	Protection of Main Circuit Terminals .....	86
3.4	Main Circuit Terminal Block Wiring Procedure .....	87
	Notes on Wiring the Main Circuit Terminal Block of Models 2011 to 2059 and 4005 to 4065 .....	87
	Notes on Wiring the Main Circuit Terminal Block of Models 2075 to 2114 and 4077 to 4124 .....	89
	Wiring the Main Circuit Terminal Block Using Procedure A .....	89
	Wiring the Main Circuit Terminal Block Using Procedure B .....	90
	Wiring the Main Circuit Terminal Block Using Procedure C .....	92
	Wiring the Main Circuit Terminal Block Using Procedure D .....	94
	Wiring the Main Circuit Terminal Block Using Procedure E .....	96
	Wiring the Main Circuit Terminal Block Using Procedure F .....	97
	Wiring the Main Circuit Terminal Block Using Procedure G .....	98
	Wiring the Main Circuit Terminal Block Using Procedure H .....	99
3.5	Control Circuit Wiring .....	102
	Control Circuit Connection Diagram .....	102
	Control Circuit Terminal Block Functions .....	103
	Control Circuit Terminal Configuration .....	107
	Wiring the Control Circuit Terminal .....	110
	Switches and Jumpers on the Terminal Board .....	112
3.6	Control I/O Connections .....	114
	Set Sinking Mode/Sourcing Mode .....	114
	Set Input Signals for MFAI Terminals A1 and A2 .....	114
	Set Output Signals for MFAO Terminals FM, AM .....	115
	Switch ON Termination Resistor for RS-485 Communications .....	115
3.7	Connect the Drive to a PC .....	117
3.8	External Interlock .....	118
	Drive Ready .....	118
3.9	Drive Wiring Protection .....	119
	Installing a Ground Fault Circuit Interrupter (GFCI) .....	119
	Installing a Molded-Case Circuit Breaker (MCCB) or Ground Fault Circuit Interrupter (GFCI) .....	119
3.10	Motor Protection .....	120
	Installing a Magnetic Contactor (MC) at the Input Side of the Drive .....	120
	Installing a Thermal Overload Relay on the Drive Output .....	120

3.11	Improve the Power Factor	122
	Connecting an AC Reactor	122
3.12	Prevent Switching Surge	123
3.13	Protect the Drive during Failures	124
	Short Circuit Protection Requirements for UL Listing	124
3.14	Wiring Checklist	126
3.15	Motor Application Precautions	128
	Precautions for Existing Standard Motors	128
	Precaution When You Use IE3 Premium Efficiency Motors	129
	Precautions for PM Motors	129
	Precautions for Specialized Motors	129
	Notes on the Power Transmission Mechanism	130
4.	Startup Procedure and Test Run	131
4.1	Section Safety	132
4.2	Drive Main Switch	133
	Use and Lock the Main Switch	133
4.3	Keypad: Names and Functions	135
	LCD Display	136
	AUTO LED and HAND LED Indications	137
	Keypad Mode and Menu Displays	139
4.4	LED Status Ring	141
4.5	Start-up Procedures	143
	Flowchart A: Connect and Run the Motor with Minimum Setting Changes	143
	Sub-Chart A-1: Induction Motor Auto-Tuning and Test Run Procedure	144
	Sub-Chart A-2: PM Motor Auto-Tuning and Test Run Procedure	144
	Subchart A-3: EZ Open Loop Vector Control Test Run Procedure	145
4.6	Items to Check before Starting Up the Drive	147
	Check before Energizing the Drive	147
	Check after Energizing the Drive	147
	Make the Initial Settings	148
4.7	Keypad Operation	149
	Home Screen Display Selection	149
	Show the Monitors	150
	Set Custom Monitors	151
	Show Custom Monitors	152
	Set the Monitors to Show as a Bar Graph	152
	Show Monitors as Bar Graphs	154
	Set the Monitors to Show as Analog Gauges	154
	Show Monitors as an Analog Gauge	155
	Set Monitor Items to Show as a Trend Plot	156
	Show Monitor Items as a Trend Plot	160
	Change Parameter Settings	161
	Examine User Custom Parameters	162
	Save a Backup of Parameters	163
	Write Backed-up Parameters to the Drive	164
	Verify Keypad Parameters and Drive Parameters	166
	Delete Parameters Backed Up to the Keypad	167
	Checking Modified Parameters	168
	Restore Modified Parameters to Defaults	170
	Show Fault History	171
	Auto-Tuning the Drive	172

	Set the Keypad Language Display .....	174
	Set the Date and Time .....	175
	Disable the Initial Setup Screen .....	177
	Start Data Logging .....	178
	Configuring the Data Log Content .....	179
	Set Backlight to Automatically Turn OFF .....	181
	Show Information about the Drive .....	183
	Write Automatically Backed-up Parameters to the Drive .....	184
4.8	Automatic Parameter Settings Optimized for Specific Applications (Application Presets) .....	185
4.9	Auto-Tuning .....	187
	Auto-Tuning for Induction Motors .....	187
	Auto-Tuning for Motor Parameters for PM Motor .....	187
	Auto-Tuning in EZ Open Loop Vector Control Method .....	189
	Precautions before Auto-Tuning .....	190
4.10	Test Run .....	192
	No-Load Test Run .....	192
	Do a No-Load Test Run .....	192
	Actual-Load Test Run .....	193
	Do an Actual-Load Test Run .....	193
4.11	Fine Tuning during Test Runs (Adjust the Control Function) .....	194
	V/f Control .....	194
	Open Loop Vector Control for PM Motors .....	195
	EZ Open Loop Vector Control Method .....	196
4.12	Test Run Checklist .....	197
5.	Standards Compliance .....	199
5.1	Section Safety .....	200
5.2	European Standards .....	202
	EU Declaration of Conformity .....	202
	CE Low Voltage Directive Compliance .....	202
	EMC Directive .....	207
5.3	UL Standards .....	216
	Area of Use .....	216
	Wire the Main Circuit Terminal Block .....	216
	Ferrules and Closed-Loop Crimp Terminals .....	216
	Short Circuit Protection Requirements for UL Listing .....	222
	Low Voltage Wiring for Control Circuit Terminals .....	223
	Drive Motor Overload and Overheat Protection .....	223
5.4	China RoHS Compliance .....	228
	Information on Hazardous Substances in This Product .....	228
5.5	对应中国RoHS指令 .....	229
	本产品中含有有害物质的信息 .....	229
5.6	Safe Disable Input .....	230
	Safe Disable Specifications .....	230
	Notes .....	231
	Using the Safe Disable Function .....	231
5.7	Seismic Standards .....	237
	IBC/HCAI Seismic Mounting Requirements .....	237
	Concrete Masonry Attachment Detail .....	238
6.	Network Communications .....	239

6.1	Section Safety . . . . .	240
6.2	Fieldbus Network Support . . . . .	241
6.3	BACnet Communications . . . . .	242
	Configure Master/Slave . . . . .	242
	Communication Specifications . . . . .	242
	Communication with the PLC . . . . .	243
	Drive Operations by Serial Communications . . . . .	244
	BACnet Objects Supported . . . . .	245
	Accessing Drive Parameters and the Enter Command . . . . .	254
	Self-Diagnostics . . . . .	255
	BACnet Protocol Implementation Conformance Statement . . . . .	256
6.4	APOGEE FLN (P1) Communications . . . . .	259
	APOGEE FLN Set-Up . . . . .	259
	Communication Specifications . . . . .	259
	Communication with the PLC . . . . .	259
	Slope and Intercept Conversion . . . . .	261
	APOGEE FLN Point Database . . . . .	263
	Cable Loss Configuration and Behavior . . . . .	266
	Mailbox Functions . . . . .	267
	Troubleshooting Checklist . . . . .	268
6.5	Metasys N2 Communications . . . . .	269
	Configure Master/Slave . . . . .	269
	Communication Specifications . . . . .	269
	Communication with the PLC . . . . .	269
	Drive Operations by Serial Communications . . . . .	271
	Communications Timing . . . . .	273
	Metasys N2 Point Database . . . . .	274
	Mailbox Functions . . . . .	277
	Self-Diagnostics . . . . .	278
6.6	MEMOBUS/Modbus Communications . . . . .	279
	Configure Master/Slave . . . . .	279
	Communication Specifications . . . . .	279
	Communication with the PLC . . . . .	279
	Drive Operations by Serial Communications . . . . .	281
	Communications Timing . . . . .	281
	Message Format . . . . .	282
	Examples of Messages for Commands/Responses . . . . .	285
	Enter Command . . . . .	289
	Self-Diagnostics . . . . .	290
	Communications Data Table . . . . .	291
	Error Codes . . . . .	309
7.	Troubleshooting . . . . .	311
7.1	Section Safety . . . . .	312
7.2	Types of Faults, Minor Faults, Alarms, and Errors . . . . .	314
7.3	List of Fault, Minor Fault, Alarm, and Error Codes . . . . .	315
7.4	Fault . . . . .	322
7.5	Minor Faults/Alarms . . . . .	345
7.6	Parameter Setting Errors . . . . .	358
7.7	Auto-Tuning Errors . . . . .	363
7.8	Backup Function Operating Mode Display and Errors . . . . .	366
7.9	Diagnosing and Resetting Faults . . . . .	368

	Fault and Power Loss Occur at the Same Time	368
	Fault Occurs Without Power Loss	368
	Fault Reset	368
7.10	Troubleshooting Without Fault Display	370
	Typical Problems	370
	The Parameter Settings Will Not Change	370
	The Motor Does Not Rotate After Entering Run Command	371
	The Motor Rotates in the Opposite Direction from the Run Command	372
	The Motor Rotates in Only One Direction	372
	The Motor Is Too Hot	372
	oPE02 Error Occurs When Decreasing the Motor Rated Current Setting	373
	The Correct Auto-Tuning Mode Is Not Available	373
	The Motor Stalls during Acceleration or Accel/Decel Time Is Too Long	373
	The Drive Frequency Reference Is Different than the Controller Frequency Reference Command	374
	The Motor Speed Is Not Stable When Using a PM Motor	374
	There Is Too Much Motor Oscillation and the Rotation Is Irregular	374
	There Is Audible Noise from the Drive or Motor Cables when You Energize the Drive	374
	The Ground Fault Circuit Interrupter (GFCI) Trips During Run	375
	Motor Rotation Causes Unexpected Audible Noise from Connected Machinery	375
	Motor Rotation Causes Oscillation or Hunting	375
	PID Output Fault	375
	The Starting Torque Is Not Sufficient	375
	The Motor Rotates after the Drive Output Is Shut Off	376
	The Output Frequency Is Lower Than the Frequency Reference	376
	The Motor Is Making an Audible Noise	376
	The Motor Will Not Restart after a Loss of Power	376
8.	Periodic Inspection and Maintenance	377
8.1	Section Safety	378
8.2	Inspection	380
	Recommended Daily Inspection	380
	Recommended Periodic Inspection	380
8.3	Maintenance	383
8.4	Replace Cooling Fans and Circulation Fans	385
	Cooling Fans and Circulation Fans by Drive Model	385
	Fan Replacement (Procedure A)	385
	Fan Replacement (Procedure B)	390
	Fan Replacement (Procedure C)	396
	Fan Replacement (Procedure D)	401
	Fan Replacement (Procedure E)	404
8.5	Replace the Keypad Battery	411
8.6	Storage Guidelines	413
9.	Disposal	415
9.1	Section Safety	416
9.2	Disposal Instructions	417
9.3	WEEE Directive	418
10.	Specifications	419
10.1	Section Safety	420
10.2	Model Specifications (208 V Class)	421

10.3	Model Specifications (480 V Class)	422
10.4	Common Drive Specifications	424
10.5	Drive Watt Loss	427
10.6	Drive Derating	429
	Carrier Frequency Settings and Rated Current Values	429
	Derating Depending on Ambient Temperature	430
	Altitude Derating	432
10.7	Drive Exterior and Mounting Dimensions	433
	Drive Models and Exterior/Mounting Dimensions	433
	IP20/UL Open Type	434
	IP20/UL Type1	436
	IP55/UL Type 12	441
	IP55/UL Type 12 with Main Switch	446
10.8	Knock-Out Hole Dimensions	452
	Drive Models and Knock-Out Hole Dimensions	452
	IP20/UL Type1	453
	IP55/UL Type 12	456
	IP55/UL Type 12 with Main Switch	458
10.9	Peripheral Devices and Options	461
<b>11.</b>	<b>Parameter List</b>	<b>463</b>
11.1	Section Safety	464
11.2	How to Read the Parameter List	465
	Icons and Terms that Identify Parameters and Control Methods	465
11.3	Parameter Groups	466
11.4	A: Initialization Parameters	468
	A1: Initialization	468
	A2: User Parameters	469
11.5	b: Application	472
	b1: Operation Mode Selection	472
	b2: DC Injection Braking and Short Circuit Braking	473
	b3: Speed Search	474
	b4: Timer Function	476
	b5: PID Control	476
	b8: Energy Saving	480
11.6	C: Tuning	482
	C1: Accel & Decel Time	482
	C2: S-Curve Characteristics	482
	C3: Slip Compensation	483
	C4: Torque Compensation	483
	C5: Auto Speed Regulator (ASR)	484
	C6: Carrier Frequency	484
11.7	d: Reference Settings	485
	d1: Frequency Reference	485
	d2: Reference Limits	485
	d3: Jump Frequency	486
	d4: Frequency Ref Up/Down & Hold	486
	d6: Field Weakening	486
	d7: Offset Frequency	487
11.8	E: Motor Parameters	488
	E1: V/f Pattern for Motor 1	488

	E2: Motor Parameters . . . . .	489
	E3: V/f Pattern for Motor 2 . . . . .	489
	E4: Motor 2 Parameters . . . . .	490
	E5: PM Motor Settings . . . . .	490
	E9: Motor Setting . . . . .	491
11.9	F: Options . . . . .	492
	F6: Communication Options . . . . .	492
	F7: Ethernet Options . . . . .	493
11.10	H: Terminal Functions . . . . .	497
	H1: Digital Inputs . . . . .	497
	H2: Digital Outputs . . . . .	505
	H3: Analog Inputs . . . . .	515
	H4: Analog Outputs . . . . .	519
	H5: Serial Communication . . . . .	520
	H7: Virtual Inputs / Outputs . . . . .	522
11.11	L: Protection Functions . . . . .	524
	L1: Motor Protection . . . . .	524
	L2: Power Loss Ride Through . . . . .	525
	L3: Stall Prevention . . . . .	526
	L4: Speed Detection . . . . .	527
	L5: Fault Restart . . . . .	528
	L6: Torque Detection . . . . .	529
	L7: Torque Limit . . . . .	530
	L8: Drive Protection . . . . .	530
	L9: Drive Protection 2 . . . . .	532
11.12	n: Special Adjustment . . . . .	533
	n1: Hunting Prevention . . . . .	533
	n3: High Slip/Overexcite Braking . . . . .	533
	n7: EZ Drive . . . . .	534
	n8: PM Motor Control Tuning . . . . .	534
11.13	o: Keypad-Related Settings . . . . .	538
	o1: Keypad Display . . . . .	538
	o2: Keypad Operation . . . . .	541
	o3: Copy Keypad Function . . . . .	542
	o4: Maintenance Monitors . . . . .	543
	o5: Log Function . . . . .	543
11.14	q: DriveWorksEZ Parameters . . . . .	545
	q1-01 to qx-xx: Reserved for DriveWorksEZ . . . . .	545
11.15	r: DWEZ Connection 1-20 . . . . .	546
	r1-01 to r1-40: DriveWorksEZ Connection Parameters 1 to 20 (Upper / Lower) . . . . .	546
11.16	S: Special Applications . . . . .	547
	S1: Dynamic Noise Control . . . . .	547
	S2: Sequence Run Timers . . . . .	547
	S3: PI2 Control . . . . .	551
	S5: Hand/Off/Auto Operation . . . . .	553
	S6: Protection . . . . .	554
11.17	T: Motor Tuning . . . . .	557
	T0: Tuning Mode Selection . . . . .	557
	T1: Induction Motor Auto-Tuning . . . . .	557
	T2: PM Motor Auto-Tuning . . . . .	557
	T4: EZ Tuning . . . . .	558
11.18	U: Monitors . . . . .	560



U1: Operation Status Monitors	560
U2: Fault Trace	562
U3: Fault History	564
U4: Maintenance Monitors	567
U5: PID Monitors	570
U6: Operation Status Monitors	572
U8: DriveWorksEZ Monitors	574
UA: Network Multiplexing	577
UC: BACnet Diagnostic Monitors	577
11.19 Y: Application Features	579
Y1: Application Basics	579
Y2: PID Sleep and Protection	581
Y4: Application Advanced	582
Y9: Network Multiplex Options	584
YA: Preset Setpoint	589
YC: Foldback Features	589
YF: PI Auxiliary Control	589
11.20 Parameters that Change from the Default Settings with A1-02 [Control Method Selection]	594
11.21 Parameters Changed by E1-03 [V/f Pattern Selection]	597
11.22 Defaults by o2-04 [Drive Model (kVA) Selection]	600
208 V Class	600
480 V Class	602
12. Parameter Details	607
12.1 Section Safety	608
12.2 A: Initialization Parameters	609
A1: Initialization	609
A2: User Parameters	624
12.3 b: Application	625
b1: Operation Mode Selection	625
b2: DC Injection Braking and Short Circuit Braking	635
b3: Speed Search	638
b4: Timer Function	647
b5: PID Control	649
b8: Energy Saving	668
12.4 C: Tuning	671
C1: Accel & Decel Time	671
C2: S-Curve Characteristics	674
C3: Slip Compensation	674
C4: Torque Compensation	676
C5: Auto Speed Regulator (ASR)	677
C6: Carrier Frequency	681
12.5 d: References	684
d1: Frequency Reference	684
d2: Reference Limits	688
d3: Jump Frequency	689
d4: Frequency Ref Up/Down & Hold	691
d6: Field Weakening	692
d7: Offset Frequency	692
12.6 E: Motor Parameters	694
E1: V/f Pattern for Motor 1	694

	E2: Motor Parameters	702
	E3: V/f Pattern for Motor 2	704
	E4: Motor 2 Parameters	706
	E5: PM Motor Settings	708
	E9: Motor Setting	710
12.7	F: Options	713
	F6, F7: Communication Options and Ethernet Options	713
12.8	H: Terminal Functions	727
	H1: Digital Inputs	727
	MFDI Setting Value	732
	H2: Digital Outputs	752
	H2 MFDO Parameters	755
	MFDO Setting Values	758
	H3: Analog Inputs	774
	H3: MFAI Parameters	776
	MFAI Setting Value	779
	H4: Analog Outputs	786
	H5: Memobus/Modbus Communication	789
	H7: Virtual Inputs / Outputs	795
12.9	L: Protection Functions	800
	L1: Motor Protection	800
	L2: Power Loss Ride Through	805
	L3: Stall Prevention	811
	L4: Speed Detection	818
	L5: Fault Restart	820
	L6: Torque Detection	826
	L7: Torque Limit	831
	L8: Drive Protection	833
	L9: Drive Protection 2	839
12.10	n: Special Adjustment	840
	n1: Hunting Prevention	840
	n3: High Slip Braking (HSB) and Overexcitation Braking	841
	n7: EZ Drive	844
	n8: PM Motor Control Tuning	846
12.11	o: Keypad-Related Settings	854
	o1: Keypad Display Selection	854
	o2: Keypad Operation	866
	o3: Copy Function	869
	o4: Maintenance Mon Settings	871
	o5: Log Function	874
12.12	S: Special Applications	880
	S1: Dynamic Noise Control	880
	S2: Sequence Run Timers	881
	S3: PI2 Control	890
	S5: Hand/Off/Auto Operation	895
	S6: Protection	901
12.13	T: Auto-Tuning	910
	T0: Tuning Mode Selection	910
	T1: Induction Motor Auto-Tuning	910
	T2: PM Motor Auto-Tuning	912
	T4: EZ Tuning	914
12.14	Y: Application Features	917
	Y1: Application Basics	917

---

Y2: PID Sleep and Protection .....	923
Y4: Application Advanced .....	926
Y9: Network Multiplex Options .....	931
YA: Preset Setpoint .....	945
YC: Foldback Features .....	946
YF: PI Auxiliary Control .....	947
Index .....	956
Revision History .....	965



# Preface and General Precautions

---

This chapter gives information about important safety precautions for the use of this product. Failure to obey these precautions can cause serious injury or death, or damage to the product or related devices and systems. Yaskawa must not be held responsible for any injury or equipment damage as a result of the failure to observe these precautions and instructions.

<b>i.1</b>	<b>Receiving</b> .....	<b>16</b>
<b>i.2</b>	<b>Using the Product Safely</b> .....	<b>17</b>
<b>i.3</b>	<b>Warranty Information</b> .....	<b>22</b>

## i.1 Receiving

These instructions contain the information necessary to use the product correctly. Read and understand the safety information and precautions before you start to use the product.

### ◆ Glossary

Phrase	Definition
Drive	YASKAWA AC Drive HV600
EDM	External Device Monitor
EZOLV	EZ Open Loop Vector Control
IPM motor	Interior Permanent Magnet motors
MFAI	Multi-Function Analog Input
MFAO	Multi-Function Analog Output
MFDI	Multi-Function Digital Input
MFDO	Multi-Function Digital Output
OLV/PM	Open Loop Vector Control for Permanent Magnet Motors
PM motor	Permanent Magnet Synchronous motor (generic name for IPM motors and SPM motors)
SIL	Safety Integrity Level
SPM motor	Surface Permanent Magnet motors
V/f	V/f Control

### ◆ About Registered Trademarks

- APOGEE FLN is a registered trademark of Siemens Building Technologies, Inc.
- APOGEE Anywhere is a trademark of Siemens Building Technologies, Inc.
- BACnet is a trademark of the American Society of Heating, Refrigerating, and Air-Conditioning Engineers (ASHRAE).
- EtherNet/IP is a registered trademark of Open DeviceNet Vendor Association, Inc. (ODVA).
- LonWorks and LonTalk are registered trademarks of Echelon Corporation.
- Metasys N2 is a trademark of Johnson Controls, Inc.
- Modbus is a registered trademark of Schneider Electric SA.
- PROFINET is a registered trademark of PROFIBUS International.
- Other company names and product names in this document are trademarks or registered trademarks of the respective companies.

## i.2 Using the Product Safely

### ◆ Explanation of Signal Words

#### **⚠ WARNING**

**Read and understand this manual before you install, operate, or do maintenance on the drive. Install the drive as specified by this manual and local codes.**

The symbols in this section identify safety messages in this manual. If you do not obey these safety messages, the hazards can cause serious injury, death, or damage to the products and related equipment and systems.

These identifier words categorize and emphasize important safety precautions in these instructions.

#### **⚠ DANGER**

**This signal word identifies a hazard that will cause serious injury or death if you do not prevent it.**

#### **⚠ WARNING**

**This signal word identifies a hazard that can cause death or serious injuries if you do not prevent it.**

#### **⚠ CAUTION**

**This signal word identifies a hazardous situation, which, if not avoided, can cause minor or moderate injury.**

#### **NOTICE**

**This signal word identifies a property damage message that is not related to personal injury.**

### ◆ General Safety

#### **General Precautions**

- Some figures in the instructions include options and drives without covers or safety shields to more clearly show the inside of the drive. Replace covers and shields before operation. Use options and drives only as specified by the instructions.
- The figures in this manual are examples only. All figures do not apply to all products included in this manual.
- Yaskawa can change the products, specifications, and content of the instructions without notice to make the product and/or the instructions better.
- If you damage or lose these instructions, contact a Yaskawa representative or the nearest Yaskawa sales office on the rear cover of the manual, and tell them the document number on the front cover to order new copies.

#### **⚠ DANGER**

**Do not ignore the safety messages in this manual.**

If you ignore the safety messages in this manual, it will cause serious injury or death. The manufacturer is not responsible for injuries or damage to equipment.

#### **Electrical Shock Hazard**

**Do not examine, connect, or disconnect wiring on an energized drive. Before servicing, disconnect all power to the equipment and wait for the time specified on the warning label at a minimum. The internal capacitor stays charged after the drive is de-energized. The charge indicator LED extinguishes when the DC bus voltage decreases below 50 Vdc. When all indicators are OFF, remove the covers before measuring for dangerous voltages to make sure that the drive is safe.**

If you do work on the drive when it is energized, it will cause serious injury or death from electrical shock.

## **⚠ WARNING**

### **Crush Hazard**

**Test the system to make sure that the drive operates safely after you wire the drive and set parameters.**

If you do not test the system, it can cause damage to equipment or serious injury or death.

### **Sudden Movement Hazard**

**Before you do a test run, make sure that the setting values for virtual input and output function parameters are correct. Virtual input and output functions can have different default settings and operation than wired input and output functions.**

Incorrect function settings can cause serious injury or death.

**Remove all personnel and objects from the area around the drive, motor, and machine and attach covers, couplings, shaft keys, and machine loads before you energize the drive.**

If personnel are too close or if there are missing parts, it can cause serious injury or death.

**Examine the I/O signals and internal sequence with the engineer who made the DriveWorksEZ program before you operate the drive.**

If you do not know how the drive will operate, it can cause serious injury or death. When you use DriveWorksEZ to make custom programming, the drive I/O terminal functions change from factory settings and the drive will not operate as written in this manual.

### **Electrical Shock Hazard**

**Do not modify the drive body or drive circuitry.**

Modifications to drive body and circuitry can cause serious injury or death, will cause damage to the drive, and will void the warranty. Yaskawa is not responsible for modifications of the product made by the user.

**Only let approved personnel install, wire, maintain, examine, replace parts, and repair the drive.**

If personnel are not approved, it can cause serious injury or death.

**Do not remove covers or touch circuit boards while the drive is energized.**

If you touch the internal components of an energized drive, it can cause serious injury or death.

**After the drive blows a fuse or trips a GFCI, do not immediately energize the drive or operate peripheral devices. Wait for the time specified on the warning label at a minimum and make sure that all indicators are OFF. Then check the wiring and peripheral device ratings to find the cause of the problem. If you do not know the cause of the problem, contact Yaskawa before you energize the drive or peripheral devices.**

If you do not fix the problem before you operate the drive or peripheral devices, it can cause serious injury or death.

**Disconnect all power to the drive and remove all wires to do maintenance on the drive.**

If you only turn OFF the built-in Main Switch before you do maintenance, there can be high voltage on input terminals R/L1, S/L2, and T/L3 of the Main Switch and touching energized terminals will cause serious injury or death.

### **Damage to Equipment**

**Do not apply incorrect voltage to the main circuit of the drive. Operate the drive in the specified range of the input voltage on the drive nameplate.**

Voltages that are higher than the permitted nameplate tolerance can cause damage to the drive.

### **Fire Hazard**

**Install sufficient branch circuit short circuit protection as specified by applicable codes and this manual. The drive is suitable for circuits that supply not more than 100,000 RMS symmetrical amperes, 240 Vac maximum (208 V Class), 480 Vac maximum (480 V Class).**

Incorrect branch circuit short circuit protection can cause serious injury or death.



**⚠ CAUTION****Crush Hazard**

**Tighten terminal cover screws and hold the case safely when you move the drive.**

If the drive or covers fall, it can cause moderate injury.

**NOTICE**

**Use an inverter-duty motor or vector-duty motor with reinforced insulation and windings applicable for use with an AC drive.**

If the motor does not have the correct insulation, it can cause a short circuit or ground fault from insulation deterioration.

**Damage to Equipment**

**When you touch the drive and circuit boards, make sure that you observe correct electrostatic discharge (ESD) procedures.**

If you do not follow procedures, it can cause ESD damage to the drive circuitry.

**Do not do a withstand voltage test or use a megohmmeter or megger insulation tester on the drive.**

These tests can cause damage to the drive.

**Do not operate a drive or connected equipment that has damaged or missing parts.**

You can cause damage to the drive and connected equipment.

**Do not use steam or other disinfectants to fumigate wood for packaging the drive. Use alternative methods, for example heat treatment, before you package the components.**

Gas from wood packaging fumigated with halogen disinfectants, for example fluorine, chlorine, bromine, iodine or DOP gas (phthalic acid ester), can cause damage to the drive.

**Do not energize and de-energize the drive more frequently than one time each 30 minutes.**

If you frequently energize and de-energize the drive, it can cause drive failure.

**Do not cycle the Main Switch more than 6000 times.**

If you cycle the Main Switch more times than the limit, it will cause the contact failure, or you cannot open or close the Main Switch.

**Make sure that you stop the motor before you turn ON/OFF the Main Switch.**

If you turn ON/OFF the Main Switch during run, it can cause Main Switch failure.

**◆ Warning Label Content and Location**

The drive warning labels are in the locations shown in [Figure i.1](#) and [Figure i.2](#). Use the drive as specified by this information.

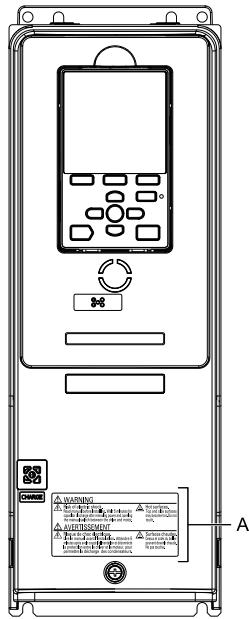

<p><b>⚠ WARNING</b></p> <p><b>⚡ Risk of electric shock.</b> Read manual before installing. Wait 5 minutes for capacitor discharge after removing power and opening the manual switch between the drive and motor.</p>		<p><b>🔥 Hot surfaces.</b> Top and side surfaces may become hot. Do not touch.</p>	
<p><b>⚠ AVERTISSEMENT</b></p> <p><b>⚡ Risque de choc électrique.</b> Lire le manuel avant l'installation. Attendez 5 minutes après avoir coupé l'alimentation et déconnecté la protection entre le driver et le moteur, pour permettre la décharge des condensateurs.</p>		<p><b>🔥 Surfaces chaudes.</b> Dessus et côtés du boîtier peuvent devenir chauds. Ne pas toucher.</p>	

A - Warning label

Figure i.1 Warning Label Content and Location (Models: 2xxxxB/F/V and 4xxxxB/F/V without Main Switch)

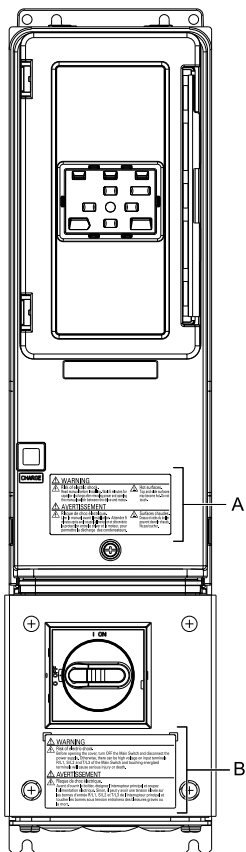

<p><b>⚠ WARNING</b></p> <p><b>⚡ Risk of electric shock.</b> Read manual before installing. Wait 5 minutes for capacitor discharge after removing power and opening the manual switch between the drive and motor.</p>		<p><b>🔥 Hot surfaces.</b> Top and side surfaces may become hot. Do not touch.</p>	
<p><b>⚠ AVERTISSEMENT</b></p> <p><b>⚡ Risque de choc électrique.</b> Lire le manuel avant l'installation. Attendez 5 minutes après avoir coupé l'alimentation et déconnecté la protection entre le driver et le moteur, pour permettre la décharge des condensateurs.</p>		<p><b>🔥 Surfaces chaudes.</b> Dessus et côtés du boîtier peuvent devenir chauds. Ne pas toucher.</p>	

<p><b>⚠ WARNING</b></p> <p><b>⚡ Risk of electric shock.</b> Before opening the cover, turn OFF the Main Switch and disconnect the power supply. Otherwise, there can be high voltage on input terminals R/L1, S/L2 and T/L3 of the Main Switch and touching energized terminals will cause serious injury or death.</p>	
<p><b>⚠ AVERTISSEMENT</b></p> <p><b>⚡ Risque de choc électrique.</b> Avant d'ouvrir le boîtier, éteignez l'interrupteur principal et coupez l'alimentation électrique. Sinon, il peut y avoir une tension élevée sur les bornes d'entrée R/L1, S/L2 et T/L3 de l'interrupteur principal et toucher les bornes sous tension entraînera des blessures graves ou la mort.</p>	

A - Warning label

B - Warning label for Main Switch

Figure i.2 Warning Label Content and Location (Models: 2xxxxT and 4xxxxT with Main Switch)

**◆ Cybersecurity**

This product is designed to connect and communicate information and data through a network interface. It is the sole responsibility of the customer to provide and continuously guarantee a secure connection between the product and the customer's network or if applicable, any other network. The customer must establish and maintain the appropriate measures (such as, but not limited to, the installation of firewalls, the application of authentication measures, the encryption of data, the installation of antivirus programs, etc.) to protect the product, the network, its system and the interface against all types of security breaches, unauthorized access, interference, intrusion, leakage and/or theft of data or information. Yaskawa and its affiliates are not responsible for damages and/or losses related to such security breaches, any unauthorized access, interference, intrusion, leakage and/or theft of data or information.

## **i.3 Warranty Information**

---

### **◆ Exclusion of Liability**

- This product is not designed and manufactured for use in life-support machines or systems.
- Contact a Yaskawa representative or your Yaskawa sales representative if you are considering the application of this product for special purposes, such as machines or systems used for passenger cars, medicine, airplanes and aerospace, nuclear power, electric power, or undersea relaying.

### **⚠ WARNING**

#### **Injury to Personnel**

**When you use this product in applications where its failure could cause the loss of human life, a serious accident, or physical injury, you must install applicable safety devices.**

If you do not correctly install safety devices, it can cause serious injury or death.

## Receiving

---

This chapter gives information about the different drive models and features, and how to examine the drive when you receive it.

<b>1.1</b>	<b>Section Safety .....</b>	<b>24</b>
<b>1.2</b>	<b>Catalog Code and Nameplate Check.....</b>	<b>25</b>

## 1.1 Section Safety

 **DANGER**

**Do not ignore the safety messages in this manual.**

If you ignore the safety messages in this manual, it will cause serious injury or death. The manufacturer is not responsible for injuries or damage to equipment.

## 1.2 Catalog Code and Nameplate Check

Please examine these items after you received the drive:

- Examine the drive for damage or missing parts. Immediately contact the shipping company if the drive is damaged. The Yaskawa warranty does not cover damage from shipping.
- Examine the catalog code in the “C/C” section of the drive nameplate to make sure that you received the correct model.
- If you received a product different than what you ordered or your product has a defect, contact Yaskawa or your nearest sales representative.

### ◆ Nameplate

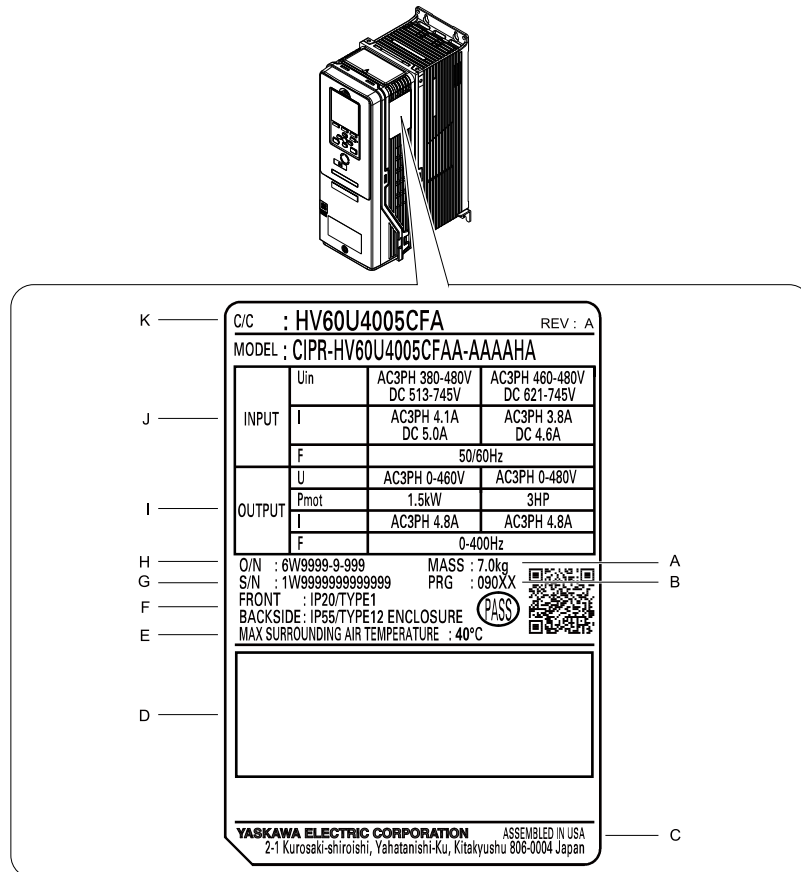

- |   |                                  |
|---|----------------------------------|
| <b>A - Weight</b>   | <b>G - Serial number</b>         |
| <b>B - Drive software version</b>   | <b>H - Lot number</b>            |
| <b>C - The address of the head office of Yaskawa Electric Corporation</b> | <b>I - Output specifications</b> |
| <b>D - Accreditation standards</b>  | <b>J - Input specifications</b>  |
| <b>E - Surrounding air temperature</b>                                    | <b>K - Catalog code</b>          |
| <b>F - Protection design</b>  |                                  |

Figure 1.1 Nameplate Location

### ◆ How to Read Catalog Codes

Use the information in [Figure 1.2](#) and [Table 1.1](#) to read the drive catalog codes.

## 1.2 Catalog Code and Nameplate Check

**HV60 U 4 005 C F A**  
 |   |   |   |   |   |   |  
 1   2   3   4   5   6   7

**Figure 1.2 Drive Catalog Code**

**Table 1.1 Catalog Code Details**

No.	Description
1	Product series
2	Region code U: the Americas T: Asia (Singapore and India)
3	Input power supply voltage • 2: Three-Phase 200 Vac to 240 Vac • 4: Three-Phase 380 Vac to 480 Vac
4	Rated output current <b>Note:</b> Refer to the rated output current list for more information.
5	EMC filter C: Built-in EMC filter for C2
6	Protection design • B: IP20/UL Open Type • F: IP20/UL Type 1 • V: IP55/UL Type 12 • T: IP55/UL Type 12 with Main Switch <sup>*1</sup>
7	Environmental specification A: Standard

\*1 IP55/UL Type 12 drives with Main Switch are certified as IP55 Category 2 as specified by IEC60529.

### ■ Rated Output Current

Table 1.2 and Table 1.3 give the rated output current values.

**Note:**

- These output current values are applicable for drives that operate at standard specifications.
- Derate the current in applications that:
  - Increase the carrier frequency
  - Have high ambient temperature
  - Use side-by-side installation.

**Table 1.2 Output Current for Three-Phase AC 208 V Class Models (NEMA Rating)**

Model	Maximum Applicable Motor Output kW (HP)	Rated Output Current A
2011	2.2 (3)	10.6
2017	3.7 (5)	16.7
2024	5.5 (7.5)	24.2
2031	7.5 (10)	30.8
2046	11 (15)	46.2
2059	15 (20)	59.4
2075	18.5 (25)	74.8
2088	22 (30)	88
2114	30 (40)	114
2143	37 (50)	143
2169	45 (60)	169
2211	55 (75)	211
2273	75 (100)	273



Table 1.3 Output Current for Three-Phase AC 480 V Class Models (NEMA Rating)

Model	Maximum Applicable Motor Output kW (HP)	Rated Output Current A
4005	2.2 (3)	4.8
4008	3.7 (5)	7.6
4011	5.6 (7.5)	11
4014	7.5 (10)	14
4021	11.2 (15)	21
4027	15 (20)	27
4034	18.6 (25)	34
4040	22 (30)	40
4052	30 (40)	52
4065	37 (50)	65
4077	45 (60)	77
4096	56 (75)	96
4124	75 (100)	124
4156	93 (125)	156
4180	112 (150)	180
4240	150 (200)	240
4302	186 (250)	302

## ◆ Features and Advantages of Control Methods

This drive has three available control methods from which to select for different applications. [Table 1.4](#) and [Table 1.5](#) give information about the features of each control method.

Table 1.4 Features and Advantages of V/f Control Method

Control Method Selection	V/f Control (V/f)	Notes
Controlled Motor	Induction Motor	-
Parameter Setting	A1-02 = 0	-
Basic Control	V/f	-
Main Applications	General-purpose variable speed control to connect more than one motor to one drive.	-
Maximum Output Frequency	400 Hz	-
Speed Control Range	1:40	This is the range of variable control. When you connect and operate motors in this mode, think about the increase in motor temperature.
Starting Torque	140%/3 Hz	This is the motor torque that the drive can supply at low speed during start-up and the related output frequency (rotation speed). You must think about drive capacity and motor capacity when a large quantity of torque is necessary at low speed.
Auto-Tuning <sup>*/</sup>	Rotational and Line-to-Line Resistance (usually not necessary)	Automatically tunes electrical motor parameters.
Torque Limits <sup>*/</sup>	No	Controls maximum motor torque to prevent damage to machines and loads.
Speed Search <sup>*/</sup>	Yes	Immediately estimates (or detects) motor speed and direction when coasting to a stop to quickly start-up the drive without stopping the motor.
Automatic Energy-saving Control <sup>*/</sup>	Yes	Automatically adjusts the voltage applied to motors to maximize motor efficiency for all load sizes.
High Slip Braking (HSB) <sup>*/</sup>	Yes	Increases motor loss to let the motor decelerate faster than usual without a braking resistor. Motor characteristics have an effect on this function.
KEB Ride-Thru Function <sup>*/</sup>	Yes	Quickly and safely stops the motor or continues to operate the motor without coasting during power loss. After the power comes back on, automatically starts operation at the previous speed.

## 1.2 Catalog Code and Nameplate Check

Control Method Selection	V/f Control (V/f)	Notes
Controlled Motor	Induction Motor	-
Overexcitation Deceleration <sup>*/</sup>	Yes	Sets the V/f higher than the setting value during deceleration to increase motor loss and decrease deceleration time.
Overvoltage Suppression Function <sup>*/</sup>	Yes	Adjusts speed during regeneration to prevent overvoltage.

\*1 Note these points when you use this function:

- When you can decouple the motor and machine for a test run, use Rotational Auto-Tuning. If there are problems with vibration in the operating speed range, you must make adjustments in the *d3-xx parameters*.
- Motor loss increases during overexcitation braking and high-slip braking. Use a maximum braking frequency of 5% ED (Duty Cycle) and a maximum braking time of 90 seconds. After you start high-slip braking, you cannot restart the motor until it stops. Use overexcitation braking to decelerate over a shorter time at a pre-determined speed.

**Table 1.5 Features and Advantages of OLV/PM and EZOLV Control Methods**

Control Method Selection	PM Open Loop Vector Control (OLV/PM)	EZ Open Loop Vector Control (EZOLV)	Notes
Controlled Motor	PM Motor	SynRM (Synchronous Reluctance Motors)	-
Parameter Setting	A1-02 = 5	A1-02 = 8	-
Basic Control	PM Open Loop Vector Control (no speed controller)	Open Loop Current Vector Control	-
Main Applications	<ul style="list-style-type: none"> <li>• General-purpose variable speed control for PM motors</li> <li>• Applications in which a high level of responsiveness and accurate speed control are not necessary.</li> </ul>	Low-speed torque applications Example: Fans and pumps	-
Maximum Output Frequency	400 Hz	120 Hz	-
Speed Control Range	1:20	1:10	This is the range of variable control. When you connect and operate motors in this mode, think about the increase in motor temperature.
Starting Torque	100%/10% speed	100%/10% speed	This is the motor torque that the drive can supply at low speed during start-up and the related output frequency (rotation speed). However, you must think about drive capacity and motor capacity when a large quantity of torque is necessary at low speed.
Auto-Tuning <sup>*/</sup>	Stationary, Stator Resistance, Rotational	Line-to-Line Resistance	Automatically tunes electrical motor parameters.
Torque Limits <sup>*/</sup>	No	Yes	Controls maximum motor torque to prevent damage to machines and loads.
Speed Search <sup>*/</sup>	Yes	Yes (Speed Search will not operate in the opposite direction of the Run command.)	Immediately estimates (or detects) motor speed and direction when coasting to a stop to quickly start-up the drive without stopping the motor.
Automatic Energy-saving Control <sup>*/</sup>	No	Yes	Automatically adjusts the voltage applied to motors to maximize motor efficiency for all load sizes.
High Slip Braking (HSB)	No (induction motor-specific function)	No	Increases motor loss to let the motor decelerate faster than usual without a braking resistor. Motor characteristics have an effect on this function.
KEB Ride-Thru Function <sup>*/</sup>	Yes	Yes	Quickly and safely stops the motor or continues to operate the motor without coasting during power loss. After the power comes back on, automatically starts operation at the previous speed.
Overexcitation Deceleration	No (induction motor-specific function)	No	Sets the V/f higher than the setting value during deceleration to increase motor loss and decrease deceleration time.
Overvoltage Suppression Function <sup>*/</sup>	Yes	Yes	Adjusts speed during regeneration to prevent overvoltage.

\*1 Note these points when you use this function:

- When you can decouple the motor and machine for a test run, use Rotational Auto-Tuning. If there are problems with vibration in the operating speed range, you must make adjustments in the *d3-xx parameters*.
- For vector control, use a 1:1 drive to motor ratio. You cannot use vector control when more than one motor is connected to one drive. Select a drive capacity so that the motor rated current is 50% to 100% of the drive rated current. If the carrier frequency is too high, the drive rated current is derated.

# Mechanical Installation

---

This chapter explains how to properly mount and install the drive.

<b>2.1</b>	<b>Section Safety .....</b>	<b>30</b>
<b>2.2</b>	<b>Installation Environment .....</b>	<b>32</b>
<b>2.3</b>	<b>Installation Position and Distance .....</b>	<b>33</b>
<b>2.4</b>	<b>Moving the Drive.....</b>	<b>37</b>
<b>2.5</b>	<b>Remove and Reattach the Keypad.....</b>	<b>40</b>
<b>2.6</b>	<b>Install the Keypad in a Control Panel or Another Device.....</b>	<b>41</b>
<b>2.7</b>	<b>Removing/Reattaching Covers.....</b>	<b>46</b>
<b>2.8</b>	<b>Change the Drive Enclosure Type.....</b>	<b>54</b>
<b>2.9</b>	<b>Installation Methods .....</b>	<b>55</b>

## 2.1 Section Safety

### WARNING

#### Electrical Shock Hazard

**Only let approved personnel install, wire, maintain, examine, replace parts, and repair the drive.**

If personnel are not approved, it can cause serious injury or death.

**Do not modify the drive body or drive circuitry.**

Modifications to drive body and circuitry can cause serious injury or death, will cause damage to the drive, and will void the warranty. Yaskawa is not responsible for modifications of the product made by the user.

#### Fire Hazard

**Do not put flammable or combustible materials on top of the drive and do not install the drive near flammable or combustible materials. Attach the drive to metal or other noncombustible material.**

Flammable and combustible materials can start a fire and cause serious injury or death.

**When you install the drive in an enclosure, use a cooling fan or cooler to decrease the temperature around the drive. Make sure that the intake air temperature to the drive is 50 °C (122 °F) or less for IP20/UL Open Type drives, and 40 °C (104 °F) or less for IP20/UL Type 1 drives.**

If the air temperature is too hot, the drive can become too hot and cause a fire and serious injury or death.

#### Crush Hazard

**Only approved personnel can operate a crane or hoist to move the drive.**

If unapproved personnel operate a crane or hoist, it can cause serious injury or death from falling equipment.

**Before you hang the drive vertically, use screws to correctly attach the drive front cover and other drive components.**

If you do not secure the front cover, it can fall and cause minor injury.

**When you use a crane or hoist to lift the drive during installation or removal, prevent more than 1.96 m/s<sup>2</sup> (0.2 G) vibration or impact.**

Too much vibration or impact can cause serious injury or death from falling equipment.

**When you lift the drive during installation or removal, do not try to turn the drive over and do not ignore the hanging drive.**

If you move a hanging drive too much or if you ignore it, the drive can fall and cause serious injury or death.

**Use a crane or hoist to move large drives when necessary.**

If you try to move a large drive without a crane or hoist, it can cause serious injury or death.

### CAUTION

#### Crush Hazard

**Tighten terminal cover screws and hold the case safely when you move the drive.**

If the drive or covers fall, it can cause moderate injury.

### NOTICE

**Do not let unwanted objects, for example metal shavings or wire clippings, fall into the drive during drive installation. Put a temporary cover over the drive during installation. Remove the temporary cover before start-up.**

Unwanted objects inside of the drive can cause damage to the drive.

#### Damage to Equipment

**When you touch the drive and circuit boards, make sure that you observe correct electrostatic discharge (ESD) procedures.**

If you do not follow procedures, it can cause ESD damage to the drive circuitry.

**NOTICE**

**Install vibration-proof rubber on the base of the motor or use the frequency jump function in the drive to prevent specific frequencies that vibrate the motor.**

Motor or system resonant vibration can occur in fixed speed machines that are converted to variable speed. Too much vibration can cause damage to equipment.

**You can use the drive with an explosion-proof motor, but the drive is not explosion-proof. Install the drive only in the environment shown on the nameplate.**

If you install the drive in a dangerous environment, it can cause damage to the drive.

**Do not lift the drive with the covers removed.**

If the drive does not have covers, you can easily cause damage to the internal parts of the drive.

## 2.2 Installation Environment

The installation environment is important for the lifespan of the product and to make sure that the drive performance is correct. Make sure that the installation environment agrees with these specifications.

Environment	Conditions
Area of Use	Indoors
Power Supply	Overvoltage Category III
Ambient Temperature Setting	IP20/UL Type 1 and IP55/UL Type 12: -10 °C to +40 °C (14 °F to 104 °F) IP20/UL Open Type/Heatsink External Mounting: -10 °C to +50 °C (14 °F to 122 °F) <ul style="list-style-type: none"> <li>• When you install the drive in an enclosure, use a cooling fan or air conditioner to keep the internal air temperature in the permitted range.</li> <li>• Do not let the drive freeze.</li> <li>• You can use IP20/UL Open Type and IP20/UL Type 1 drives at a maximum of 60 °C (140 °F) when you derate the output current.</li> <li>• You can use IP55/UL Type 12 drives at a maximum of 50 °C (122 °F) when you derate the output current.</li> </ul>
Humidity	95% RH or less Do not let condensation form on the drive.
Storage Temperature	-20 °C to +70 °C (-4 °F to +158 °F) (short-term temperature during transportation)
Surrounding Area	Pollution degree 2 or less Install the drive in an area without: <ul style="list-style-type: none"> <li>• Oil mist, corrosive or flammable gas, or dust</li> <li>• Metal powder, oil, water, or other unwanted materials</li> <li>• Radioactive materials or flammable materials, including wood</li> <li>• Harmful gas or fluids</li> <li>• Salt</li> <li>• Direct sunlight</li> </ul> Keep wood and other flammable materials away from the drive.
Altitude	1000 m (3281 ft) maximum <b>Note:</b> Derate the output current by 1% for each 100 m (328 ft) to install the drive in altitudes between 1000 m to 4000 m (3281 ft to 13123 ft). It is not necessary to derate the rated voltage in these conditions: <ul style="list-style-type: none"> <li>• When you install the drive at 2000 m (6562 ft) or lower</li> <li>• When you install the drive between 2000 m to 4000 m (6562 ft to 13123 ft) and ground the neutral point on the power supply.</li> </ul>
Vibration	<ul style="list-style-type: none"> <li>• For models 2xxxxB/F/V and 4xxxxB/F/V without Main Switch:               <ul style="list-style-type: none"> <li>– 10 Hz to 20 Hz: 1 G (9.8 m/s<sup>2</sup>, 32.15 ft/s<sup>2</sup>)</li> <li>– 20 Hz to 55 Hz:                   <ul style="list-style-type: none"> <li>2011 to 2031, 4005 to 4034: 0.6 G (5.9 m/s<sup>2</sup>, 19.36 ft/s<sup>2</sup>)</li> <li>2046 to 2273, 4040 to 4302: 0.2 G (1.96 m/s<sup>2</sup>, 6.43 ft/s<sup>2</sup>)</li> </ul> </li> </ul> </li> <li>• For models 2xxxxT and 4xxxxT with Main Switch:               <ul style="list-style-type: none"> <li>– 10 Hz to 20 Hz: 1 G (9.8 m/s<sup>2</sup>, 32.15 ft/s<sup>2</sup>)</li> <li>– 20 Hz to 55 Hz: 0.2 G (1.96 m/s<sup>2</sup>, 6.43 ft/s<sup>2</sup>)</li> </ul> </li> </ul>
Installation Orientation	Install the drive vertically for sufficient airflow to cool the drive.

**NOTICE:** Do not let unwanted objects, for example metal shavings or wire clippings, fall into the drive during drive installation. Put a temporary cover over the drive during installation. Remove the temporary cover before start-up. Unwanted objects inside of the drive can cause damage to the drive.

**Note:**

Do not put drive peripheral devices, transformers, or other electronics near the drive. Shield the drive from electrical interference if components must be near the drive. The drive or the devices around the drive may malfunction due to electrical interference.

## 2.3 Installation Position and Distance

Install the drive vertically for sufficient airflow to cool the drive.

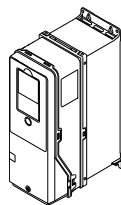

A

A - Vertical installation

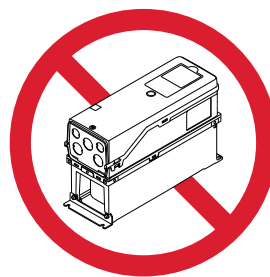

B

B - Horizontal installation

Figure 2.1 Installation Position

### ◆ Single Drive Installation

Use the clearances specified in Figure 2.2 to install the drive. Make sure that there is sufficient space for wiring and airflow.

**NOTICE: Damage to Equipment.** Remove the top protective cover from the drive when you install IP20/UL Type 1 models 2011 to 2169, 4005 to 4052, and 4077 to 4156 in an enclosure or when you install the drive with the heatsink external to the enclosure. If you do not remove the cover, the drive temperature will increase and it can cause damage to the drive.

**NOTICE: Damage to Equipment.** Do not remove the top protective cover of model 4065. If you remove the cover, the drive temperature will increase and it can cause damage to the drive.

#### Note:

When you install models 2011 to 2169 and 4005 to 4156 in an enclosure or when you install the drive with the heatsink external to the enclosure, set L8-35 = 0 [Installation Method Selection = IP20/UL Open Type].

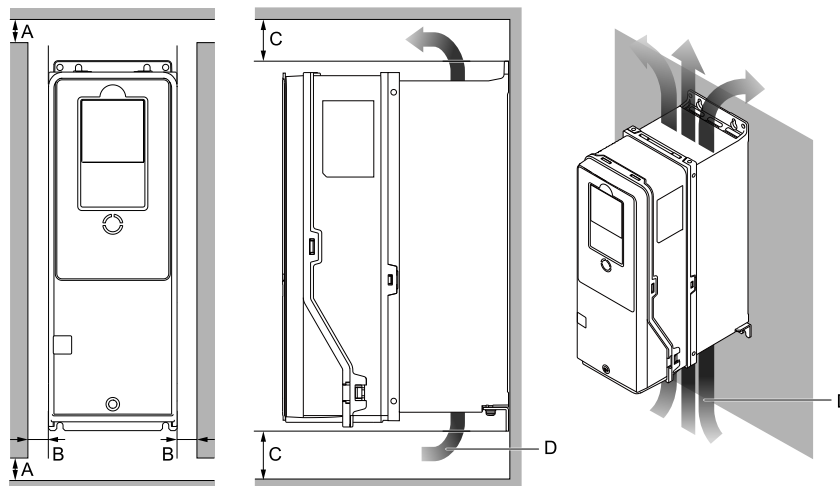

A - 50 mm (2 in) minimum  
B - 30 mm (1.2 in) minimum \*1

C - 120 mm (4.7 in) minimum \*2  
D - Airflow direction

Figure 2.2 Single Drive Installation Distances

\*1 For IP55/UL Type 12 enclosure drives, 50 mm (2 in) minimum is necessary to remove the front cover.

\*2 This is the distance from a drive component or mounting bracket that has the maximum height. The highest component of the drive is different for different models.

### ◆ Side-by-Side Installation

Side-by-Side Installation lets you install more than one drive in the minimum mounting space. This method helps you to use and set up a more compact control panel.

## 2.3 Installation Position and Distance

You can install drive models 2011 to 2114 and 4005 to 4124 side-by-side at ambient temperature 40 °C (104 °F).

**Note:**

You cannot install the drives that have IP55/UL Type 12 protection level side-by-side.

When you install IP20/UL Type 1 models 2011 to 2114 and 4005 to 4124 side-by-side:

- Use the clearances specified in [Figure 2.3](#). Make sure that there is sufficient space.
- Set  $L8-35 = 1$  [*Installation Method Selection = Side-by-Side Mounting*].
- Set the derating for the ambient temperature. Refer to [Derating Depending on Ambient Temperature on page 430](#) for more information.

**NOTICE: Damage to Equipment.** Remove the top protective covers from all drives when you install IP20/UL Type 1 models 2011 to 2114, 4005 to 4052, and 4077 to 4124 side-by-side. If you do not remove the covers, the drive temperature will increase and it can cause damage to the drives.

**NOTICE: Damage to Equipment.** Do not remove the top protective cover of model 4065. If you remove the cover, the drive temperature will increase and it can cause damage to the drive.

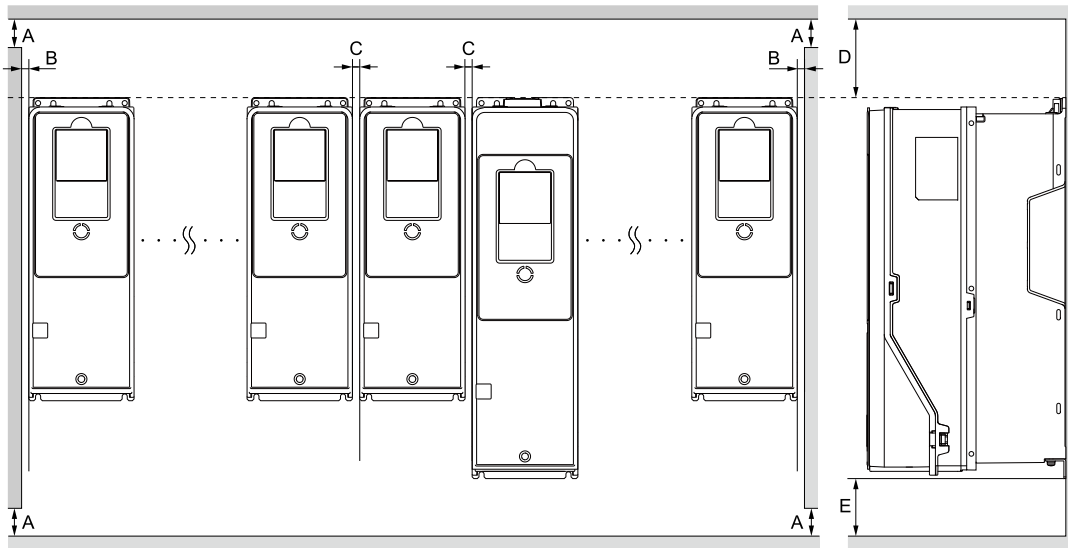

**A - 50 mm (2 in) minimum**

**B - 2 mm (0.08 in) minimum**

**C - 2 mm (0.08 in) minimum**

**D - 300 mm (11.8 in) minimum**

**E - 120 mm (4.7 in) minimum**

**Figure 2.3 Installation Distances for More than One Drive (Side-by-Side)**

**Note:**

Align the tops of drives that have different dimensions to help when you replace cooling fans.



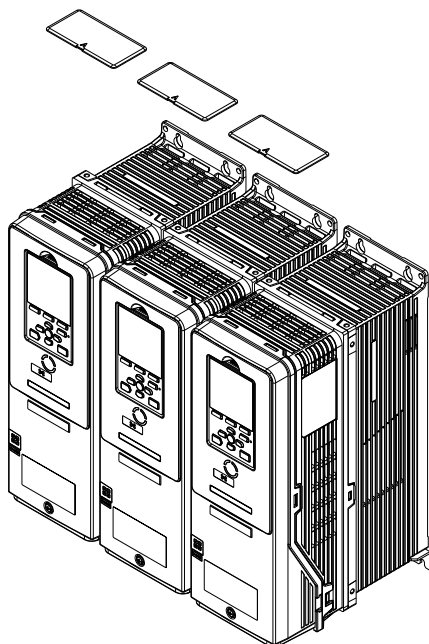
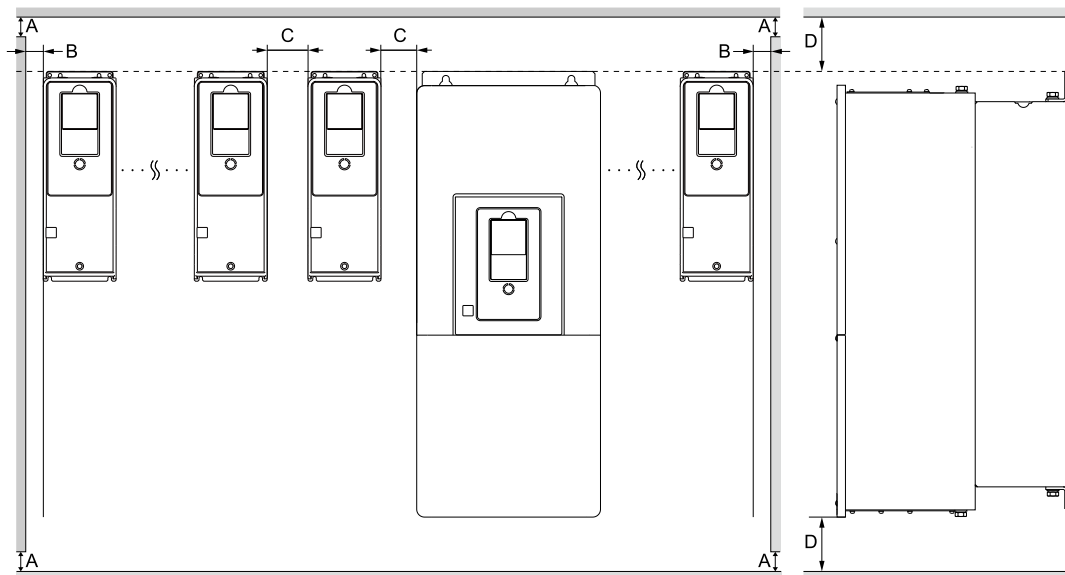

Figure 2.4 IP20/UL Type 1 Drives Installed Side-by-Side

### ◆ Installing More than One Drive Adjacent to Each Other without Derating

Use the clearances specified in Figure 2.5. Make sure that there is sufficient space.



A - 50 mm (2 in) minimum  
B - 30 mm (1.2 in) minimum

C - 60 mm (2.4 in) minimum  
D - 120 mm (4.7 in) minimum

Figure 2.5 Installation Distances for More than One Drive without Derating

**Note:**

Align the tops of drives that have different dimensions to help when you replace cooling fans.

### ◆ Remove the Top Protective Cover: 2011 to 2114, 4005 to 4052, and 4077 to 4124

**NOTICE:** *Damage to Equipment.* Do not remove the top protective cover of model 4065. If you remove the cover, the drive temperature will increase and it can cause damage to the drive.

## 2.3 Installation Position and Distance

---

Put the end of a straight-edge screwdriver into the small hole on the front edge of the top protective cover, then carefully apply pressure to remove the cover from the drive.

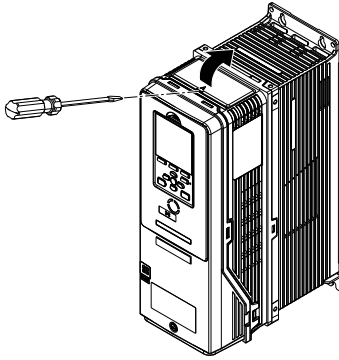

Figure 2.6 Remove the Top Protective Cover (2011 to 2114, 4005 to 4052, and 4077 to 4124)

---

### ◆ Remove the Top Protective Cover: 2143, 2169, and 4156

Remove the screws to remove the top protective cover from the drive.

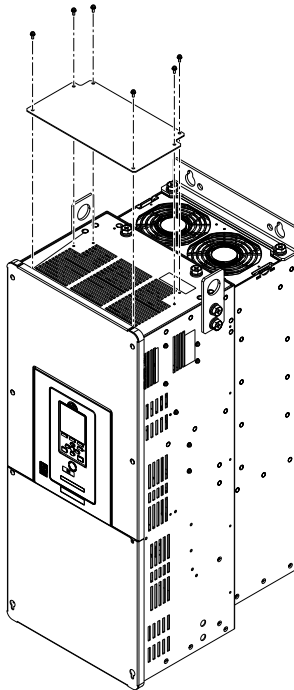

Figure 2.7 Remove the Top Protective Cover (2143, 2169, and 4156)

## 2.4 Moving the Drive

Obey local laws and regulations when you move and install this product.

**CAUTION!** *Crush Hazard. Tighten terminal cover screws and hold the case safely when you move the drive. If the drive or covers fall, it can cause moderate injury.*

Drive Weight	Persons Necessary to Move the Drive
< 15 kg (33 lbs.)	1
≥ 15 kg (33 lbs.)	2 + using appropriate lifting equipment

Refer to [Using the Hanging Brackets to Move the Drive on page 37](#) for information about how to use suspension systems, wires, or hanging metal brackets to move the drive.

### ◆ Using the Hanging Brackets to Move the Drive

Use the hanging brackets attached to the drive to temporarily lift the drive when you install the drive to a control panel or wall or when you replace the drive. Do not let the drive stay vertically or horizontally suspended or move the drive over a long distance while it is suspended.

Before you install the drive, make sure that you read these precautions:

**WARNING!** *Crush Hazard. Before you hang the drive vertically, use screws to correctly attach the drive front cover and other drive components. If you do not secure the front cover, it can fall and cause minor injury.*

**WARNING!** *Crush Hazard. When you use a crane or hoist to lift the drive during installation or removal, prevent more than 1.96 m/s<sup>2</sup> (0.2 G) vibration or impact. Too much vibration or impact can cause serious injury or death from falling equipment.*

**WARNING!** *Crush Hazard. When you lift the drive during installation or removal, do not try to turn the drive over and do not ignore the hanging drive. If you move a hanging drive too much or if you ignore it, the drive can fall and cause serious injury or death.*

**WARNING!** *Crush Hazard. When you install the drive, do not hold the front cover. Install the drive with holding the heatsink. If you hold the front cover, the cover will come off and the drive will fall, then it can cause injury.*

### ◆ Instructions on Drive Suspension

Use the procedures in this section to use wires to suspend the drive.

Models		Suspension Method
2xxxxB/F/V and 4xxxxB/F/V	2xxxxT and 4xxxxT	
2046 - 2273 4040 - 4302	2046 - 2114 4040 - 4096	Vertical Suspension
2075 - 2273 4077 - 4302	2046 - 2114 4040 - 4096	Horizontal Suspension

### ■ Vertical Suspension

To use the hanging brackets to vertically suspend the drive, lift the drive with this procedure:

1. Put wire through the two holes in the hanging brackets.

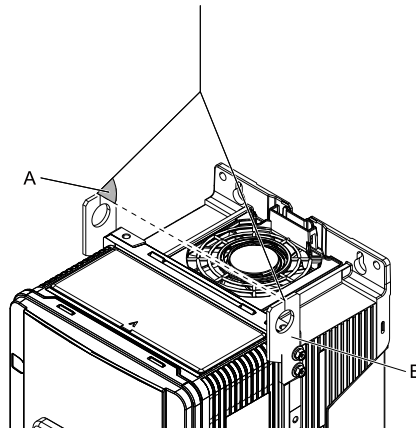

A - Suspension angle of at least 50 degrees

B - Hanging bracket (2)

**Figure 2.8 Vertical Suspension**

2. Use a crane to gradually wind up the wire. Visually make sure that there is sufficient tension in the wire, then lift the drive to its correct location.
3. Prepare the control panel for installation, then lower the drive.

**Note:**

When you lower the drive, stop before the drive touches the floor, then slowly lower it the remaining distance.

### ■ Horizontal Suspension

When horizontal suspension is necessary, use this procedure to hang the drive:

1. Put the drive on the ground horizontally.

**NOTICE:** When you attach a horizontal lifting cable or chain to the drive, use a jig or pad between the wire and the drive. The wire can scratch the drive and cause damage to the drive.

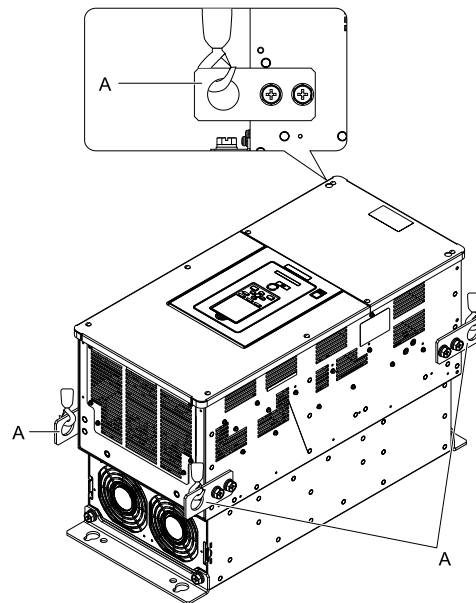

A - Hanging bracket (4)

**Figure 2.9 Horizontal Suspension**

2. Connect wires to the four hanging brackets.

### 3. Use a crane to lift the drive.

**Note:**

You can use the same procedure for IP55/UL Type 12 drives with Main Switch. Use the hanging brackets in the locations shown here.

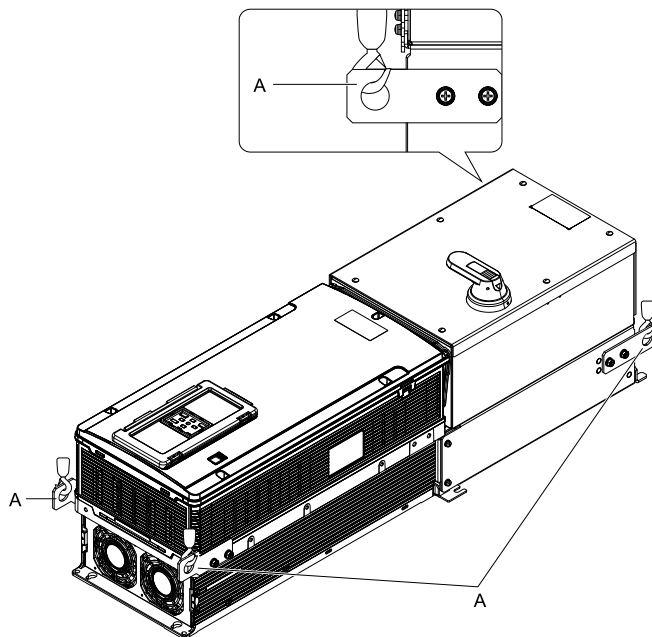

**A - Hanging bracket (4)**

## 2.5 Remove and Reattach the Keypad

**NOTICE:** You must remove the keypad before you remove or reattach the front cover. Before you reattach the keypad, make sure that you attach the front cover into position. If you keep the keypad connected to the drive when you remove the front cover, it can cause an unsatisfactory connection and incorrect operation.

---

### ◆ Remove the Keypad

Push down the tab on the top of the keypad, then pull the keypad forward to remove it from the drive.

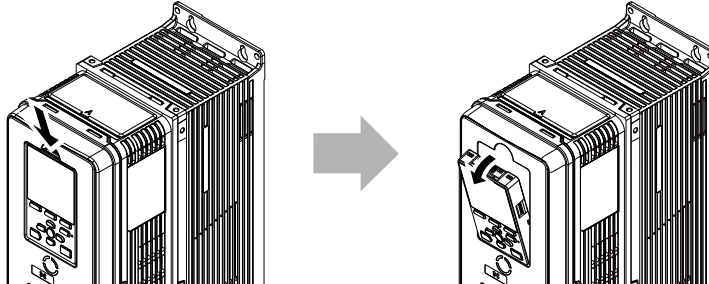

Figure 2.10 Remove the Keypad

---

### ◆ Reattach the Keypad

Put the bottom of the keypad into position first, then carefully push on the top of the keypad until the hook clicks into place.

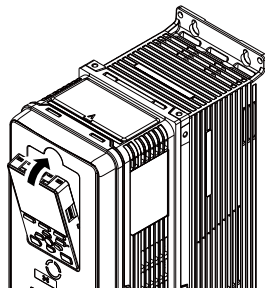

Figure 2.11 Reattach the Keypad

## 2.6 Install the Keypad in a Control Panel or Another Device

### ◆ Operate the Keypad from a Remote Location

You can remove the keypad from the drive and connect it to a remote control extension cable 3 m (9.8 ft) long to make operation easier when you cannot access the drive. It is not necessary to open or close the panel door to operate a drive that is in a control panel. To order optional accessories, contact Yaskawa or your nearest sales representative.

Name	Option Model	Intended Use
Keypad Remote Cable	UWR0051: 1 m (3.3 ft) UWR0052: 3 m (9.8 ft)	To connect the keypad and drive. This option is an RJ-45, 8-pin straight-through UTP CAT5e cable.
Installation Support Set A	900-192-933-001	To attach the keypad to the control panel. This option uses screws.
Installation Support Set B	900-192-933-002	To attach the keypad to the control panel. This option uses nut clamps. Use this option when weld studs are located in the control panel.

### ◆ Connect the Keypad from a Remote Location

Use the information in [Table 2.1](#) to install the keypad in the best location for your application.

**Table 2.1 Keypad Installation Method**

Installation Method	Features	Necessary Tools and Installation Support Sets
Outside of the control panel	Simplified installation is possible. Separate installation support sets are not necessary.	Phillips screwdriver #2 (M3)
Inside of the control panel	Keypad does not extend farther than the front of the control panel.	<ul style="list-style-type: none"> <li>Phillips screwdriver #2 (M3, M4)</li> <li>Installation support set A (for mounting with screws, model: 900-192-933-001)</li> </ul>
		<ul style="list-style-type: none"> <li>Phillips screwdriver #2 (M3)</li> <li>Wrench (M4)</li> <li>Installation support set B (for mounting with nut clamp, model: 900-192-933-002)</li> </ul>

#### Note:

Installation support sets are sold separately. If there are weld studs inside the control panel, use installation support set B. Contact Yaskawa or your nearest sales representative to make an order.

**NOTICE:** Do not let unwanted objects, for example metal shavings or wire clippings, fall into the drive during drive installation. Put a temporary cover over the drive during installation. Remove the temporary cover before start-up. Unwanted objects inside of the drive can cause damage to the drive.

### ■ External Keypad Dimensions

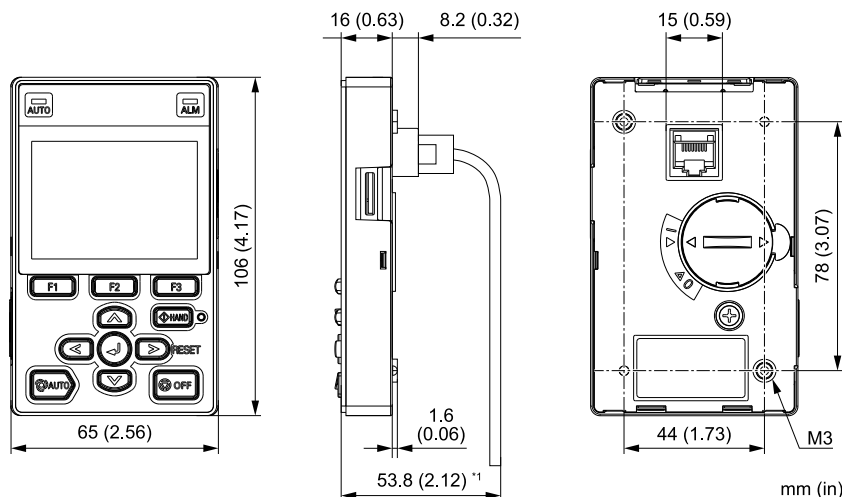

**Figure 2.12 Exterior and Mounting Dimensions**

\*1 Minimum bending radius

■ Install to the Outside of a Control Panel

1. Use the panel cut-out dimensions in Figure 2.13 to cut an opening in the control panel for the keypad.

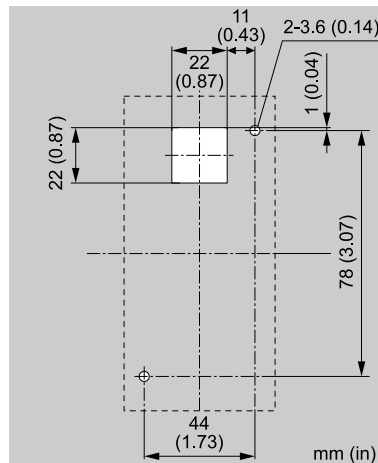
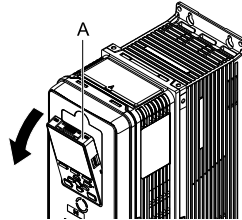

Figure 2.13 Panel Cut-Out Dimensions to Attach Outside of Control Panel

2. Remove the keypad from the drive.



A - Keypad

Figure 2.14 Remove the Keypad

3. Put the keypad on the outside of the control panel.

Use M3 screws (6 mm (0.24 in) depth cross-recessed pan head screws) to attach the keypad from the inside. Tighten the screws to a tightening torque of 0.49 N·m to 0.73 N·m (4.34 lbf·in to 6.46 lbf·in).

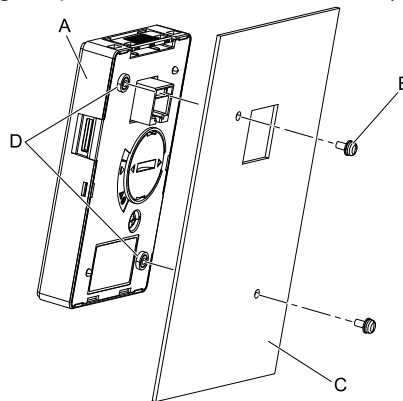

A - Keypad

B - M3 screws

C - Enclosure panel

D - Screw mounting hole

Figure 2.15 Mount to the Outside of Control Panel



- Use the remote control extension cable to connect the keypad to the drive.

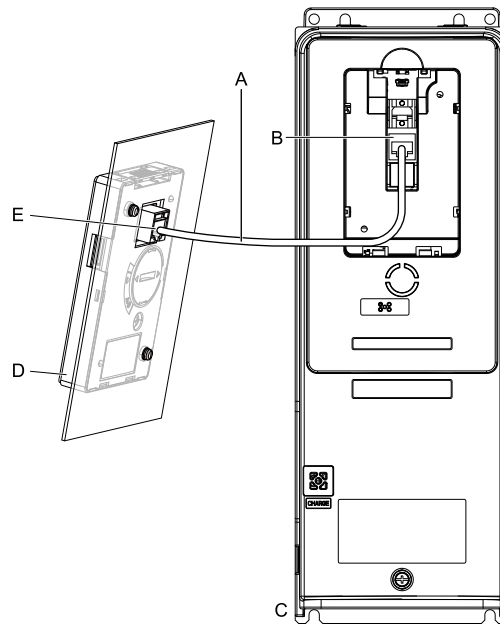

A - Remote control extension cable  
 B - Communications connector  
 C - Drive

D - Keypad  
 E - Cable connector

Figure 2.16 Use the Remote Control Extension Cable to Connect the Drive to the Keypad

### ■ Install to the Inside of a Control Panel

To attach the keypad inside of the control panel, you must purchase an installation support set, which is sold separately. Contact Yaskawa or your nearest sales representative to order mounting brackets and mounting hardware.

**Note:**

- The installation procedure and panel cut-out dimensions are the same for mounting brackets A and B.
- Use a gasket between the control panel and the keypad in environments with a large quantity of dust or other unwanted airborne material.

- Use the panel cut-out dimensions in Figure 2.17 to cut an opening in the control panel for the keypad.

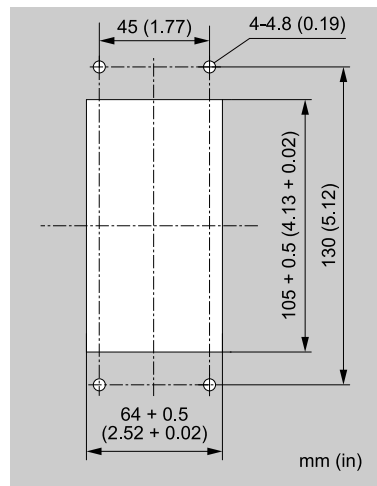
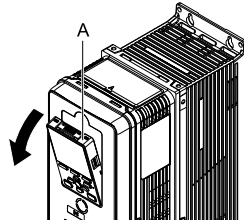

Figure 2.17 Panel Cut-Out Dimensions to Attach Inside Control Panel

## 2.6 Install the Keypad in a Control Panel or Another Device

2. Remove the keypad from the drive.



A - Keypad

**Figure 2.18 Remove the Keypad**

3. Use the screws supplied with the mounting bracket, and attach the keypad to the mounting bracket.  
Use the screws supplied with the installation support set, and tighten them to a tightening torque of 0.49 N·m to 0.73 N·m (4.34 lbf·in to 6.46 lbf·in).

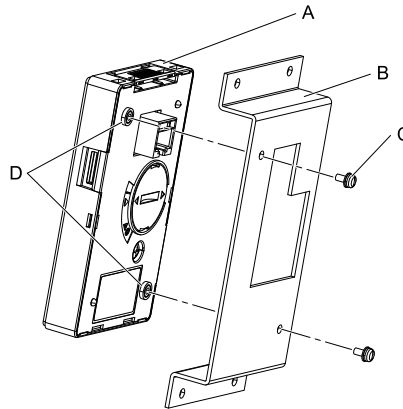

A - Keypad

B - Mounting bracket A

C - M3 screws

D - Screw mounting hole

**Figure 2.19 Attach Keypad to Mounting Bracket**

4. Position the mounting bracket to which the keypad has been attached in the control panel, and use the screws to mount it from the outside.  
Tighten the screws to a tightening torque of 0.98 N·m to 1.33 N·m (8.67 lbf·in to 11.77 lbf·in).

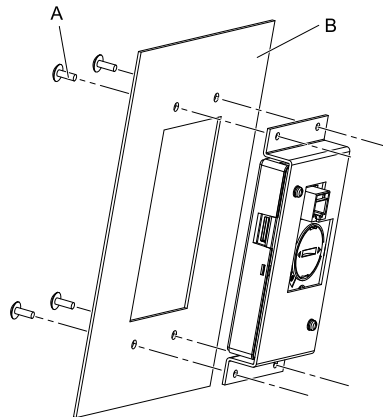

A - M4 screw

B - Enclosure panel

**Figure 2.20 Mount Mounting Bracket to the Interior of the Control Panel**

5. Use the remote control extension cable to connect the keypad to the drive.

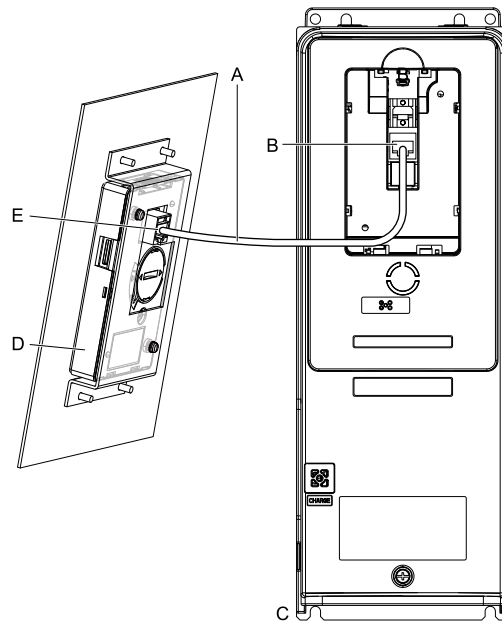

A - Remote control extension cable  
 B - Communications connector  
 C - Drive

D - Keypad  
 E - Cable connector

Figure 2.21 Use the Remote Control Extension Cable to Connect the Drive to the Keypad

## 2.7 Removing/Reattaching Covers

This section gives information about how to remove and reattach the front cover and terminal cover for wiring and inspection.

Different drive models have different procedures to remove and reattach the covers. Refer to [Table 2.2](#) for more information.

**Table 2.2 Procedures to Remove Covers by Drive Model**

Model	IP20/UL Type 1 and IP20/UL Open Type		IP55/UL Type 12 and IP55/UL Type 12 with Main Switch	
	Procedure	Reference	Procedure	Reference
2011 - 2114 4005 - 4124	Procedure A	46	Procedure C	50
2143 - 2273 4156 - 4302	Procedure B	47	-	-

### ◆ Removing/Reattaching the Cover Using Procedure A

**DANGER! Electrical Shock Hazard.** Do not examine, connect, or disconnect wiring on an energized drive. Before servicing, disconnect all power to the equipment and wait for the time specified on the warning label at a minimum. The internal capacitor stays charged after the drive is de-energized. The charge indicator LED extinguishes when the DC bus voltage decreases below 50 Vdc. When all indicators are OFF, remove the covers before measuring for dangerous voltages to make sure that the drive is safe. If you do work on the drive when it is energized, it will cause serious injury or death from electrical shock.

#### ■ Remove the Front Cover

1. Remove the keypad from the drive.

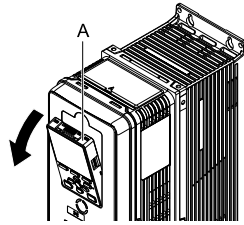

A - Keypad

Figure 2.22 Remove the Keypad

2. Loosen the front cover screw.

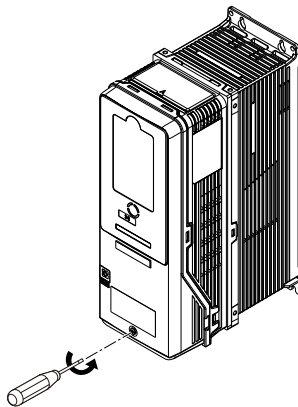

Figure 2.23 Loosen the Front Cover Screw

3. Push on the tabs in the sides of the front cover then pull the front cover forward to remove it from the drive.

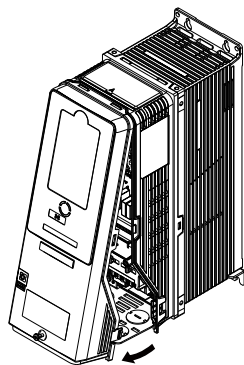

Figure 2.24 Remove the Front Cover

### ■ Reattach the Front Cover

1. Wire the drive and other peripheral devices.
2. Reverse the steps to reattach the cover.

**Note:**

- Make sure that you did not pinch wires or signal lines between the front cover and the drive before you reattach the cover.
- Make sure that the tabs on the sides of the front cover correctly click into the hook.
- Tighten the screws to a tightening torque of 0.98 N·m to 1.33 N·m (8.67 lbf·in to 11.77 lbf·in).

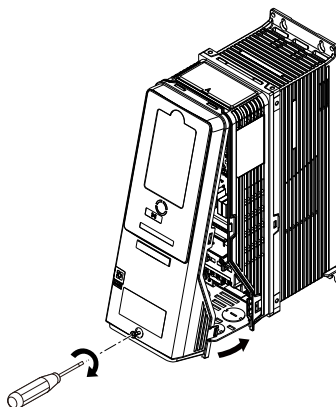

Figure 2.25 Reattach the Front Cover

3. Reattach the keypad to its initial position.

### ◆ Removing/Reattaching the Cover Using Procedure B

**DANGER! Electrical Shock Hazard.** Do not examine, connect, or disconnect wiring on an energized drive. Before servicing, disconnect all power to the equipment and wait for the time specified on the warning label at a minimum. The internal capacitor stays charged after the drive is de-energized. The charge indicator LED extinguishes when the DC bus voltage decreases below 50 Vdc. When all indicators are OFF, remove the covers before measuring for dangerous voltages to make sure that the drive is safe. If you do work on the drive when it is energized, it will cause serious injury or death from electrical shock.

### ■ Remove the Terminal Cover

1. Loosen the screws on the terminal cover, then pull down on the cover.

**CAUTION! Crush Hazard.** Loosen the cover screws. Do not fully remove them. If you fully remove the cover screws, the terminal cover can fall and cause moderate injury.

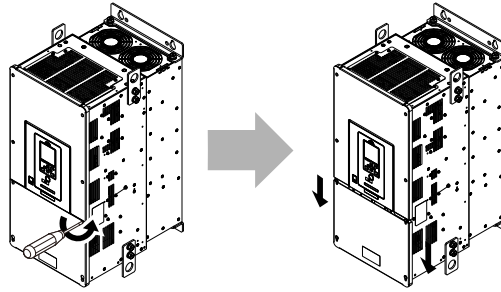

**Figure 2.26 Loosen the Terminal Cover Mounting Screws**

2. Pull the terminal cover away from the drive.

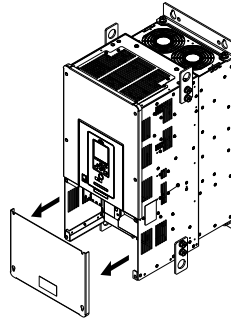

**Figure 2.27 Remove the Terminal Cover**

### ■ Remove the Front Cover

1. Remove the keypad from the drive.

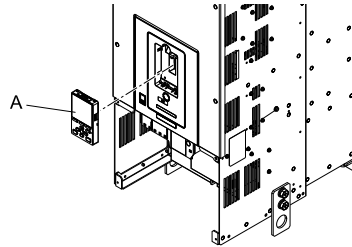

A - Keypad

**Figure 2.28 Remove the Keypad**

2. Loosen the front cover screws.

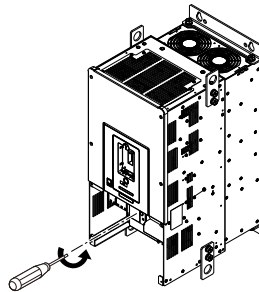

**Figure 2.29 Loosen the Front Cover Screws**

3. Pull part A of the front cover forward to remove the cover from the drive.

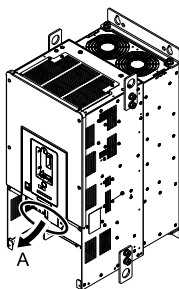

A - Pull forward to remove the front cover.

Figure 2.30 Pull Forward to Remove the Front Cover

4. Remove the front cover from the drive.

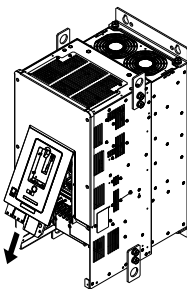
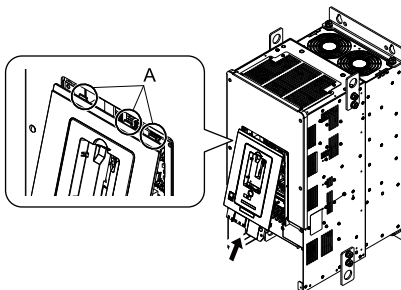

Figure 2.31 Remove the Front Cover

### ■ Reattach the Front Cover

Wire the drive and other peripheral devices then reattach the front cover.

1. Move the front cover to connect the hooks at the top of the front cover to the drive.



A - Hooks

Figure 2.32 Reattach the Front Cover

2. Move the front cover while pushing on the hooks on the left and right sides of the front cover until it clicks into position.

**Note:**

Make sure that you did not pinch wires or signal lines between the front cover and the drive before you reattach the cover.

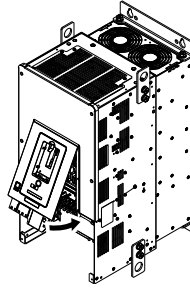

Figure 2.33 Reattach the Front Cover

3. Reattach the keypad to its initial position.

### ■ Reattach the Terminal Cover

Wire the drive and other peripheral devices then reattach the terminal cover.

**Note:**

- Make sure that you do not pinch wires or signal lines between the wiring cover and the drive before you reattach the cover.
- Tighten the screws to a tightening torque of 0.98 N·m to 1.33 N·m (8.67 lbf·in to 11.77 lbf·in).

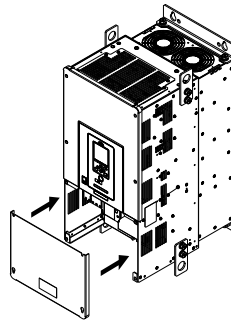

Figure 2.34 Reattach the Terminal Cover

---

## ◆ Removing/Reattaching the Cover Using Procedure C

**DANGER! Electrical Shock Hazard.** Do not examine, connect, or disconnect wiring on an energized drive. Before servicing, disconnect all power to the equipment and wait for the time specified on the warning label at a minimum. The internal capacitor stays charged after the drive is de-energized. The charge indicator LED extinguishes when the DC bus voltage decreases below 50 Vdc. When all indicators are OFF, remove the covers before measuring for dangerous voltages to make sure that the drive is safe. If you do work on the drive when it is energized, it will cause serious injury or death from electrical shock.

### ■ Remove the Front Cover

1. Push in the two tabs on the right side of the IP55/UL Type 12 keypad cover door and pull the door to the left to open.

**NOTICE: Damage to Equipment.** Do not open the IP55/UL Type 12 keypad cover door too far. If you open the door too far, it will fall off.

**NOTICE: Damage to Equipment.** When the IP55/UL Type 12 keypad cover door is open, do not push the keypad key cover. If you push the keypad key cover, it will fall off.



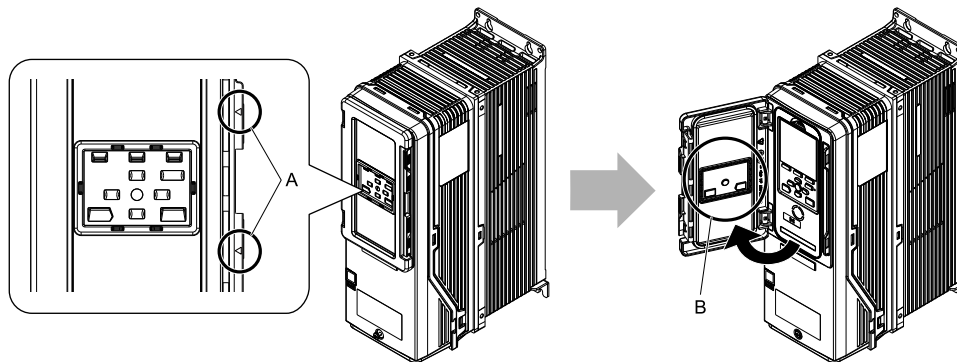

A - Tabs

B - Keypad key cover

Figure 2.35 Open the IP55/UL Type 12 Keypad Cover Door

- Remove the keypad from the drive.

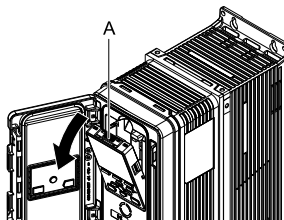

A - Keypad

Figure 2.36 Remove the Keypad

- Loosen the front cover screw.

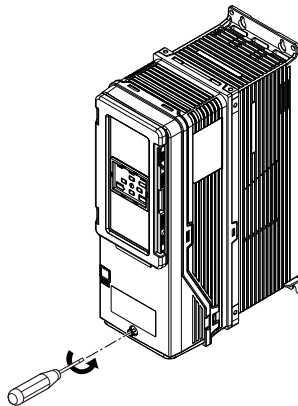

Figure 2.37 Loosen the Front Cover Screw

- Push in the tabs on the sides of the front cover and pull the front cover forward to remove it from the drive.

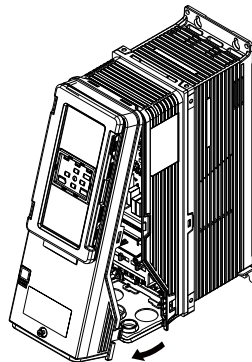

Figure 2.38 Remove the Front Cover

■ Reattach the Front Cover

1. Wire the drive and other peripheral devices.
2. Reverse the steps to reattach the cover. Reattach the cover carefully and make sure that the gasket on the conduit bracket does not twist.

**Note:**

- Make sure that you did not pinch wires or signal lines between the front cover and the drive before you reattach the cover.
- Make sure that the tabs on the sides of the front cover correctly click into the hook.
- Tighten the screws to a tightening torque of 0.98 N-m to 1.33 N-m (8.67 lbf-in to 11.77 lbf-in).

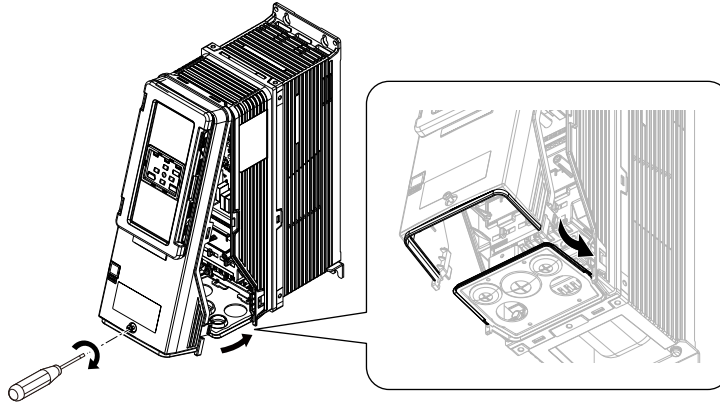

Figure 2.39 Reattach the Front Cover

3. Open the IP55/UL Type 12 keypad cover door and reattach the keypad to its initial position, then close the door until the two tabs click into position.

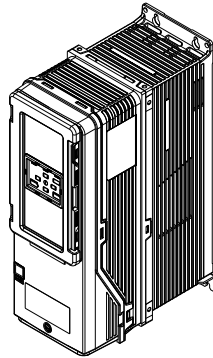
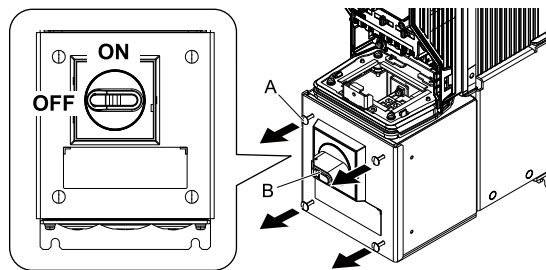

Figure 2.40 Reattach the Keypad and Close the Keypad Cover Door

■ Remove the Main Switch Cover

1. Make sure that the Main Switch Disconnect Handle is in the OFF position, then loosen the captive front cover screws on the Main Switch.



A - Screws

B - Main Switch Disconnect Handle

Figure 2.41 Loosen the Screws on the Main Switch Cover

- Pull the cover forward to remove it from the drive.

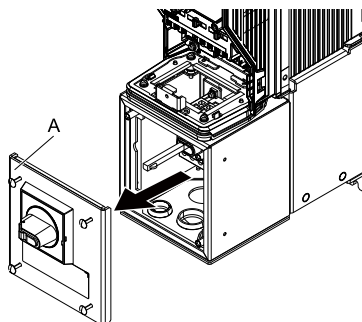

A - Main Switch cover

Figure 2.42 Remove the Main Switch Cover

### ■ Reattach the Main Switch Cover

- Make sure that the Main Switch Disconnect Handle is in the OFF position, then reverse the steps to reattach the cover.

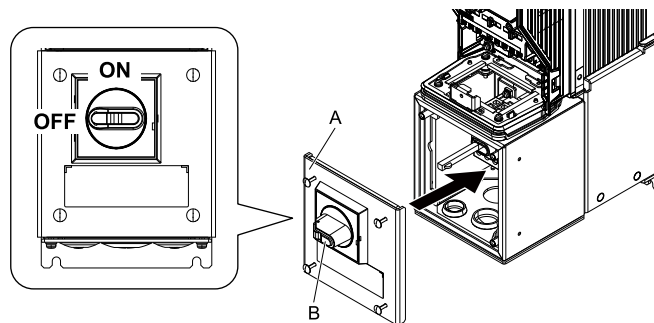

A - Main Switch cover

B - Main Switch Disconnect Handle

Figure 2.43 Reattach the Main Switch Cover

- Tighten the screws on the Main Switch cover.

#### Note:

Tighten the screws to a tightening torque of 0.98 N·m to 1.33 N·m (8.67 lbf·in to 11.77 lbf·in).

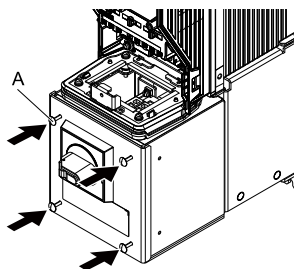

A - Screws

Figure 2.44 Tighten the Screws on the Main Switch Cover

## 2.8 Change the Drive Enclosure Type

To change the enclosure type of IP20/UL Open Type drives to IP20/UL Type 1 drives, you must install a UL Type 1 kit.

Install the kit before you wire the drive.

Different drives use different UL Type 1 kits. Refer to [Table 2.3](#) to find the kit for your drive. Refer to the reference manual for more information about how to install the kit to the drive. Contact Yaskawa or your nearest sales representative for more information about UL Type 1 kits.

**Note:**

When you install a UL Type 1 kit on an IP20/UL Open Type drive, set  $L8-35 = 2$  [*Installation Method Selection = IP20/UL Type 1*].

**Table 2.3 UL Type 1 Kits by Drive Model**

Drive Model	Option Model	Reference Manual
2211, 2273 4180, 4240	900-192-121-009	TOBPC72060002
4302	900-192-121-010	

## 2.9 Installation Methods

The drive installation methods include standard installation and external heatsink installation.

### ◆ Standard Installation

Refer to [Drive Exterior and Mounting Dimensions on page 433](#) for more information about external dimensions and installation methods.

### ◆ External Heatsink Installation

You can install the drive with the heatsink external to the enclosure panel. This installation method is “heatsink external mounting”. An optional mounting kit is necessary for heatsink external mounting. The optional kits change the protection design of the part of the heatsink that mounted external to IP20/UL Type 1 or IP55/UL Type 12.

**Note:**

For drive models 2xxxxT and 4xxxxT with Main Switch, you cannot do heatsink external mounting.

Different drives use different mounting kits. Refer to [Table 2.4](#) to find the kit for your drive. Refer to the reference manual for more information about how to install the kit to the drive.

**Note:**

When you install models 2011 to 2169 and 4005 to 4156 with the heatsink external to the enclosure, set  $L8-35 = 0$  [Installation Method Selection = IP20/UL Open Type].

**Table 2.4 Heatsink External Mounting Kits for IP20/UL Open Type and IP20/UL Type 1 Drives**

Drive Model	IP20/UL Type 1 Heatsink External Mounting Kit		IP55/UL Type 12 Heatsink External Mounting Kit	
	Model	Reference Manual	Model	Reference Manual
2011, 2017 4005 - 4014	ZPSA-600-EH1-FR1	TOEPC72060011	ZPSD-600-EH12-FR1	TOEPC72060012
2024, 2031 4021 - 4034	ZPSA-600-EH1-FR2		ZPSD-600-EH12-FR2	
2046, 2059 4040 - 4065	ZPSA-600-EH1-FR3		ZPSD-600-EH12-FR3	
2075 - 2114 4077 - 4124	ZPSA-600-EH1-FR4		ZPSD-600-EH12-FR4	
2143, 2169 4156	- */		ZPSD-600-EH12-FR6	
2211, 2273 4180, 4240			ZPSD-600-EH12-FR9	
4302			ZPSD-600-EH12-FR10	

\*1 Use the mounting brackets included with the drive.



# Electrical Installation

---

This chapter explains how to wire the control circuit terminals, motor, and power supply.

<b>3.1</b>	<b>Section Safety .....</b>	<b>58</b>
<b>3.2</b>	<b>Electrical Installation .....</b>	<b>60</b>
<b>3.3</b>	<b>Main Circuit Wiring .....</b>	<b>65</b>
<b>3.4</b>	<b>Main Circuit Terminal Block Wiring Procedure .....</b>	<b>87</b>
<b>3.5</b>	<b>Control Circuit Wiring .....</b>	<b>102</b>
<b>3.6</b>	<b>Control I/O Connections .....</b>	<b>114</b>
<b>3.7</b>	<b>Connect the Drive to a PC .....</b>	<b>117</b>
<b>3.8</b>	<b>External Interlock .....</b>	<b>118</b>
<b>3.9</b>	<b>Drive Wiring Protection .....</b>	<b>119</b>
<b>3.10</b>	<b>Motor Protection .....</b>	<b>120</b>
<b>3.11</b>	<b>Improve the Power Factor .....</b>	<b>122</b>
<b>3.12</b>	<b>Prevent Switching Surge .....</b>	<b>123</b>
<b>3.13</b>	<b>Protect the Drive during Failures .....</b>	<b>124</b>
<b>3.14</b>	<b>Wiring Checklist .....</b>	<b>126</b>
<b>3.15</b>	<b>Motor Application Precautions .....</b>	<b>128</b>

## 3.1 Section Safety

### DANGER

#### Electrical Shock Hazard

**Do not examine, connect, or disconnect wiring on an energized drive. Before servicing, disconnect all power to the equipment and wait for the time specified on the warning label at a minimum. The internal capacitor stays charged after the drive is de-energized. The charge indicator LED extinguishes when the DC bus voltage decreases below 50 Vdc. When all indicators are OFF, remove the covers before measuring for dangerous voltages to make sure that the drive is safe.**

If you do work on the drive when it is energized, it will cause serious injury or death from electrical shock.

### WARNING

#### Electrical Shock Hazard

**Do not operate the drive when covers are missing. Replace covers and shields before you operate the drive. Use the drive only as specified by the instructions.**

Some figures in this section include drives without covers or safety shields to more clearly show the inside of the drive. If covers or safety shields are missing from the drive, it can cause serious injury or death.

**Ground the neutral point on the power supply of the drives to comply with the EMC Directive before you turn on the EMC filter.**

If you turn ON the EMC filter, but you do not ground the neutral point, it can cause serious injury or death.

**Make sure that the protective ground wire complies with technical standards and local safety regulations. The IEC/EN 61800-5-1:2007 standard specifies that you must wire the power supply to automatically de-energize when the protective ground wire disconnects. You can also connect a protective ground wire that has a minimum cross-sectional area of 10mm<sup>2</sup> (copper wire) or 16 mm<sup>2</sup> (aluminum wire). For drive models on which you cannot use a protective ground wire of 10 mm<sup>2</sup> or more, install two protective ground wires that have the same cross-sectional area.**

If you do not obey the standards and regulations, it can cause serious injury or death. The leakage current of the drive will be more than 3.5 mA.

**When there is a DC component in the protective earthing conductor, the drive can cause a residual current. When a residual current operated protective or monitoring device prevents direct or indirect contact, always use a type B Ground Fault Circuit Interrupter (GFCI) as specified by IEC/EN 60755.**

If you do not use the correct GFCI, it can cause serious injury or death.

**Do not wear loose clothing or jewelry when you do work on the drive. Tighten loose clothing and remove all metal objects, for example watches or rings.**

Loose clothing can catch on the drive and jewelry can conduct electricity and cause serious injury or death.

**Do not remove covers or touch circuit boards while the drive is energized.**

If you touch the internal components of an energized drive, it can cause serious injury or death.

**Only let approved personnel install, wire, maintain, examine, replace parts, and repair the drive.**

If personnel are not approved, it can cause serious injury or death.

**Do not modify the drive body or drive circuitry.**

Modifications to drive body and circuitry can cause serious injury or death, will cause damage to the drive, and will void the warranty. Yaskawa is not responsible for modifications of the product made by the user.

#### Fire Hazard

**Tighten all terminal screws to the correct tightening torque.**

Connections that are too loose or too tight can cause incorrect operation and damage to the drive. Incorrect connections can also cause death or serious injury from fire.



**⚠ WARNING**

**Tighten screws at an angle in the specified range shown in this manual.**

If you tighten the screws at an angle not in the specified range, you can have loose connections that can cause damage to the terminal block or start a fire and cause serious injury or death.

**Damage to Equipment**

**Do not apply incorrect voltage to the main circuit of the drive. Operate the drive in the specified range of the input voltage on the drive nameplate.**

Voltages that are higher than the permitted nameplate tolerance can cause damage to the drive.

**Arc Flash Hazard**

**Obey local codes and Arc Flash safety requirements contained in the Standard for Electrical Safety in the Workplace NFPA 70E (2009 Edition or later) and the Workplace Electrical Safety, Canadian Standards Association (CSA) Z462-12. Obey safe work procedures and use applicable personal protective equipment (PPE).**

If you do not obey these requirements and procedures, it can cause serious injury or death.

**NOTICE**

**Do not let unwanted objects, for example metal shavings or wire clippings, fall into the drive during drive installation. Put a temporary cover over the drive during installation. Remove the temporary cover before start-up.**

Unwanted objects inside of the drive can cause damage to the drive.

**Damage to Equipment**

**When you touch the drive and circuit boards, make sure that you observe correct electrostatic discharge (ESD) procedures.**

If you do not follow procedures, it can cause ESD damage to the drive circuitry.

**Select a motor that is compatible with the load torque and speed range. When 100% continuous torque is necessary at low speed, use an inverter-duty motor or vector-duty motor. When you use a standard fan-cooled motor, decrease the motor torque in the low-speed range.**

If you operate a standard fan-cooled motor at low speed and high torque, it will decrease the cooling effects and can cause heat damage.

**Obey the speed range specification of the motor as specified by the manufacturer. When you must operate the motor outside of its specifications, contact the motor manufacturer.**

If you continuously operate oil-lubricated motors outside of the manufacturer specifications, it can cause damage to the motor bearings.

**When the input voltage is 440 V or higher or the wiring distance is longer than 100 m (328 ft), make sure that the motor insulation voltage is sufficient or use an inverter-duty motor or vector-duty motor with reinforced insulation.**

Motor winding and insulation failure can occur.

**Make sure that all connections are correct after you install the drive and connect peripheral devices.**

Incorrect connections can cause damage to the drive.

**Note:**

- Torque characteristics are different than when you operate the motor directly from line power. Make sure that you understand the load torque characteristics for the application.
- The current rating of submersible motors is usually higher than the current rating of standard motors for a given motor power. Make sure that the rated output current of the drive is equal to or more than the current rating of the motor. If the motor wire length is longer than 100 m (328 ft), select the correct wire gauge to adjust for a loss in voltage and prevent a loss of motor torque.
- Do not use unshielded wire for control wiring. Use shielded, twisted-pair wires and ground the shield to the ground terminal of the drive. Unshielded wire can cause electrical interference and unsatisfactory system performance.

### 3.2 Electrical Installation

**DANGER!** *Electrical Shock Hazard. Do not examine, connect, or disconnect wiring on an energized drive. Before servicing, disconnect all power to the equipment and wait for the time specified on the warning label at a minimum. The internal capacitor stays charged after the drive is de-energized. The charge indicator LED extinguishes when the DC bus voltage decreases below 50 Vdc. When all indicators are OFF, remove the covers before measuring for dangerous voltages to make sure that the drive is safe. If you do work on the drive when it is energized, it will cause serious injury or death from electrical shock.*

**WARNING!** *Electrical Shock Hazard. De-energize the drive and wait 5 minutes minimum until the Charge LED turns off. Remove the front cover and terminal cover to do work on wiring, circuit boards, and other parts. Use terminals for their correct function only. Incorrect wiring, incorrect ground connections, and incorrect repair of protective covers can cause death or serious injury.*

**WARNING!** *Electrical Shock Hazard. Correctly ground the drive before you turn on the EMC filter switch. If you touch electrical equipment that is not grounded, it can cause serious injury or death.*

**WARNING!** *Electrical Shock Hazard. Use the terminals for the drive only for their intended purpose. Refer to the technical manual for more information about the I/O terminals. Wiring and grounding incorrectly or modifying the cover may damage the equipment or cause injury.*

---

#### ◆ Standard Connection Diagram

**WARNING!** *Sudden Movement Hazard. Set the MFDI parameters before you close control circuit switches. Incorrect Run/Stop circuit sequence settings can cause serious injury or death from moving equipment.*

**WARNING!** *Sudden Movement Hazard. Correctly wire the start/stop and safety circuits before you energize the drive. If you momentarily close a digital input terminal, it can start a drive that is programmed for 3-Wire control and cause serious injury or death from moving equipment.*

**WARNING!** *Sudden Movement Hazard. When you use a 3-Wire sequence, set A1-03 = 3330 [Initialize Parameters = 3-Wire Initialization] and make sure that b1-17 = 0 [Run Command at Power Up = Disregard Existing RUN Command]. If you do not correctly set the drive parameters for 3-Wire operation before you energize the drive, the motor can suddenly rotate in reverse when you energize the drive.*

**WARNING!** *Sudden Movement Hazard. Check the I/O signals and the external sequences for the drive before you set the Application Preset function. When you set the Application Preset function (A1-06 ≠ 0), it changes the I/O terminal functions for the drive and it can cause equipment to operate unusually. This can cause serious injury or death.*

**WARNING!** *Fire Hazard. Install sufficient branch circuit short circuit protection as specified by applicable codes and this manual. The drive is suitable for circuits that supply not more than 100,000 RMS symmetrical amperes, 240 Vac maximum (208 V Class), 480 Vac maximum (480 V Class). Incorrect branch circuit short circuit protection can cause serious injury or death.*

**NOTICE:** *When the input voltage is 440 V or higher or the wiring distance is longer than 100 m (328 ft), make sure that the motor insulation voltage is sufficient or use an inverter-duty motor or vector-duty motor with reinforced insulation. Motor winding and insulation failure can occur.*

**Note:**

Do not connect the AC control circuit ground to the drive enclosure. Incorrect ground wiring can cause the control circuit to operate incorrectly.

■ Standard Drive Connection Diagram (Models: 2xxxxB/F/V and 4xxxxB/F/V without Main Switch)

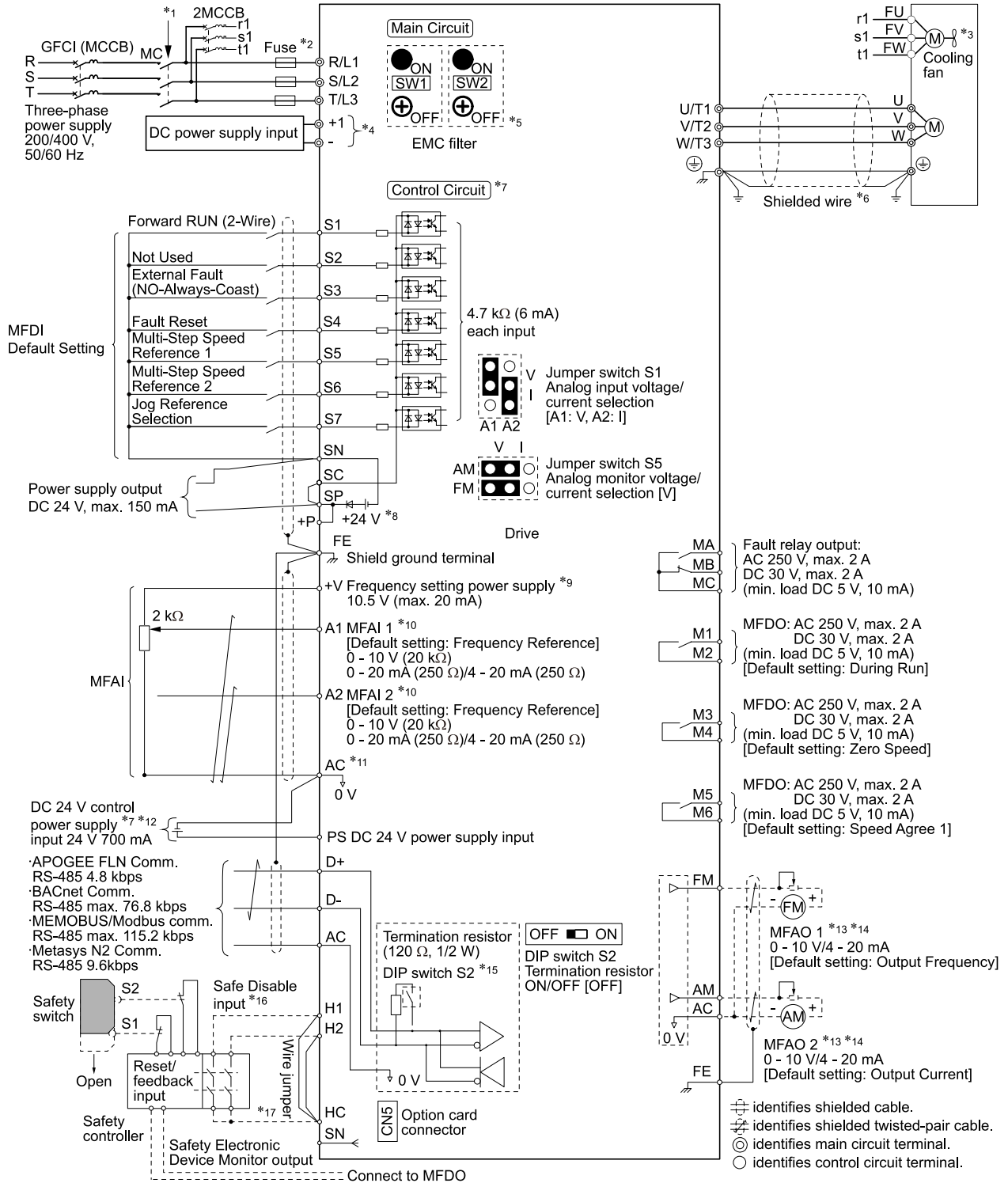

Figure 3.1 Standard Drive Connection Diagram

- \*1 Set the wiring sequence to de-energize the drive with the fault relay output. If the drive outputs a fault during fault restart when you use the fault restart function, set L5-02 = 1 [Fault Contact at Restart Select = Always Active] to de-energize the drive. Be careful when you use a cut-off sequence. The default setting for L5-02 is 0 [Active Only when Not Restarting].
- \*2 Use branch circuit protection devices as recommended in this manual.
- \*3 Cooling fan wiring is not necessary for self-cooling motors.

## 3.2 Electrical Installation

---

- \*4 Connect DC power supply input to terminals - and +1.

**WARNING! Fire Hazard.** Only connect factory-recommended devices or circuits to drive terminals - and +1. Do not connect AC power to these terminals. Incorrect wiring can cause damage to the drive and serious injury or death from fire.

- \*5 **NOTICE: Damage to Equipment.** When you use the drive with a non-grounding, high-resistance grounding, or asymmetric-grounding network, put the EMC Filter screw or screws in the OFF position to disable the built-in EMC filter. If you do not disable the built-in EMC filter, it will cause damage to the drive.

- \*6 Use braided shield cable for the drive and motor wiring, or run the wiring through a metal conduit.

- \*7 Connect a 24 V power supply to terminals PS-AC to operate the control circuit while the main circuit power supply is OFF.

- \*8 To set the MFDI power supply (Sinking/Sourcing Mode or internal/external power supply), install or remove a jumper between terminals SC-SP or SC-SN depending on the application.

**NOTICE: Damage to Equipment.** Do not close the circuit between terminals SP-SN. If you close the circuits between terminals SC-SP and terminals SC-SN at the same time, it will cause damage to the drive.

- Sinking Mode, Internal power supply: Install the jumper to close the circuit between terminals SC-SP.

**NOTICE: Damage to Equipment.** Do not close the circuit between terminals SC-SN. If you close the circuits between terminals SC-SP and terminals SC-SN at the same time, it will cause damage to the drive.

- Sourcing Mode, Internal power supply: Install the jumper to close the circuit between terminals SC-SN.

**NOTICE: Damage to Equipment.** Do not close the circuit between terminals SC-SP. If you close the circuits between terminals SC-SP and terminals SC-SN at the same time, it will cause damage to the drive.

- External power supply: Remove the jumper from the MFDI terminals. It is not necessary to close the circuit between terminals SC-SP and terminals SC-SN.

- \*9 The maximum output current capacity for terminal +V on the control circuit is 20 mA.

**NOTICE: Damage to Equipment.** Do not install a jumper between terminals +V and AC. A closed circuit between these terminals will cause damage to the drive.

- \*10 Jumper switch S1 sets terminals A1 and A2 for voltage or current input signal. The default setting for S1 is voltage input ("V" side) for A1 and current input ("I" side) for A2.

- \*11 **NOTICE: Do not ground the AC control circuit terminals and only connect the AC terminals according to the product instructions.** If you connect the AC terminals incorrectly, it can cause damage to the drive.

- \*12 Connect the positive lead from an external 24 Vdc power supply to terminal PS and the negative lead to terminal AC.

**NOTICE: Connect terminals PS and AC correctly for the 24 V power supply.** If you connect the wires to the incorrect terminals, it will cause damage to the drive.

- \*13 Use multi-function analog monitor outputs with analog frequency meters, ammeters, voltmeters, and wattmeters. Do not use monitor outputs with feedback-type signal devices.

- \*14 Jumper switch S5 sets terminal FM and AM for voltage or current output. The default setting for S5 is voltage output ("V" side).

- \*15 Set DIP switch S2 to "ON" to enable the termination resistor in the last drive in a MEMOBUS/Modbus network.

- \*16 Use only Sourcing Mode for Safe Disable input.

- \*17 Disconnect the jumpers between H1 and HC and H2 and HC to use the Safe Disable input.

■ Standard Drive Connection Diagram (Models: 2xxxxT and 4xxxxT with Main Switch)

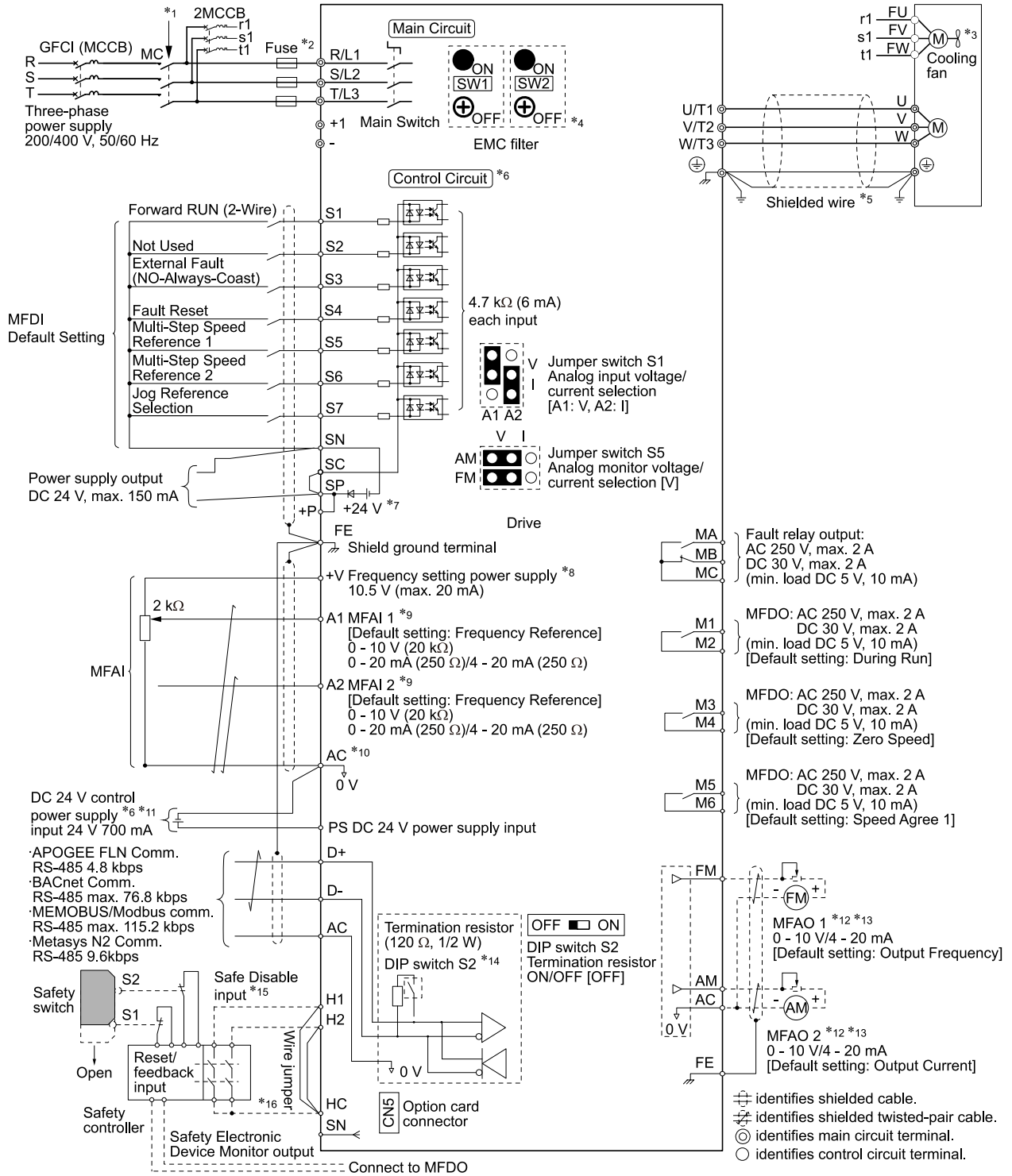

Figure 3.2 Standard Drive Connection Diagram

- \*1 Set the wiring sequence to de-energize the drive with the fault relay output. If the drive outputs a fault during fault restart when you use the fault restart function, set L5-02 = 1 [Fault Contact at Restart Select = Always Active] to de-energize the drive. Be careful when you use a cut-off sequence. The default setting for L5-02 is 0 [Active Only when Not Restarting].
- \*2 Use branch circuit protection devices as recommended in this manual.
- \*3 Cooling fan wiring is not necessary for self-cooling motors.
- \*4 **NOTICE: Damage to Equipment.** When you use the drive with a non-grounding, high-resistance grounding, or asymmetric-grounding network, put the EMC Filter screw or screws in the OFF position to disable the built-in EMC filter. If you do not disable the built-in EMC filter, it will cause damage to the drive.
- \*5 Use braided shield cable for the drive and motor wiring, or run the wiring through a metal conduit.

## 3.2 Electrical Installation

---

- \*6 Connect a 24 V power supply to terminals PS-AC to operate the control circuit while the main circuit power supply is OFF.
- \*7 To set the MFDI power supply (Sinking/Sourcing Mode or internal/external power supply), install or remove a jumper between terminals SC-SP or SC-SN depending on the application.
- NOTICE: Damage to Equipment. Do not close the circuit between terminals SP-SN. If you close the circuits between terminals SC-SP and terminals SC-SN at the same time, it will cause damage to the drive.**
- Sinking Mode, Internal power supply: Install the jumper to close the circuit between terminals SC-SP.  
**NOTICE: Damage to Equipment. Do not close the circuit between terminals SC-SN. If you close the circuits between terminals SC-SP and terminals SC-SN at the same time, it will cause damage to the drive.**
  - Sourcing Mode, Internal power supply: Install the jumper to close the circuit between terminals SC-SN.  
**NOTICE: Damage to Equipment. Do not close the circuit between terminals SC-SP. If you close the circuits between terminals SC-SP and terminals SC-SN at the same time, it will cause damage to the drive.**
  - External power supply: Remove the jumper from the MFDI terminals. It is not necessary to close the circuit between terminals SC-SP and terminals SC-SN.
- \*8 The maximum output current capacity for terminal +V on the control circuit is 20 mA.
- NOTICE: Damage to Equipment. Do not install a jumper between terminals +V and AC. A closed circuit between these terminals will cause damage to the drive.**
- \*9 Jumper switch S1 sets terminals A1 and A2 for voltage or current input signal. The default setting for S1 is voltage input ("V" side) for A1 and current input ("I" side) for A2.
- \*10 **NOTICE: Do not ground the AC control circuit terminals and only connect the AC terminals according to the product instructions. If you connect the AC terminals incorrectly, it can cause damage to the drive.**
- \*11 Connect the positive lead from an external 24 Vdc power supply to terminal PS and the negative lead to terminal AC.
- NOTICE: Connect terminals PS and AC correctly for the 24 V power supply. If you connect the wires to the incorrect terminals, it will cause damage to the drive.**
- \*12 Use multi-function analog monitor outputs with analog frequency meters, ammeters, voltmeters, and wattmeters. Do not use monitor outputs with feedback-type signal devices.
- \*13 Jumper switch S5 sets terminal FM and AM for voltage or current output. The default setting for S5 is voltage output ("V" side).
- \*14 Set DIP switch S2 to "ON" to enable the termination resistor in the last drive in a MEMOBUS/Modbus network.
- \*15 Use only Sourcing Mode for Safe Disable input.
- \*16 Disconnect the jumpers between H1 and HC and H2 and HC to use the Safe Disable input.

## 3.3 Main Circuit Wiring

This section gives information about the functions, specifications, and procedures necessary to safely and correctly wire the main circuit in the drive.

**NOTICE: Damage to Equipment.** Do not energize and de-energize the drive more frequently than one time each 30 minutes. If you frequently energize and de-energize the drive, it can cause drive failure.

**Note:**

Soldered wire connections can become loose over time and cause unsatisfactory drive performance.

### ◆ Motor and Main Circuit Connections

**WARNING! Electrical Shock Hazard.** Do not connect terminals R/L1, S/L2, T/L3, U/T1, V/T2, W/T3, -, or +1 to the ground terminal. If you connect these terminals to earth ground, it can cause damage to the drive or serious injury or death.

### ■ Wiring the Main Circuit and Motor (Models: 2xxxxB/F/V and 4xxxxB/F/V without Main Switch)

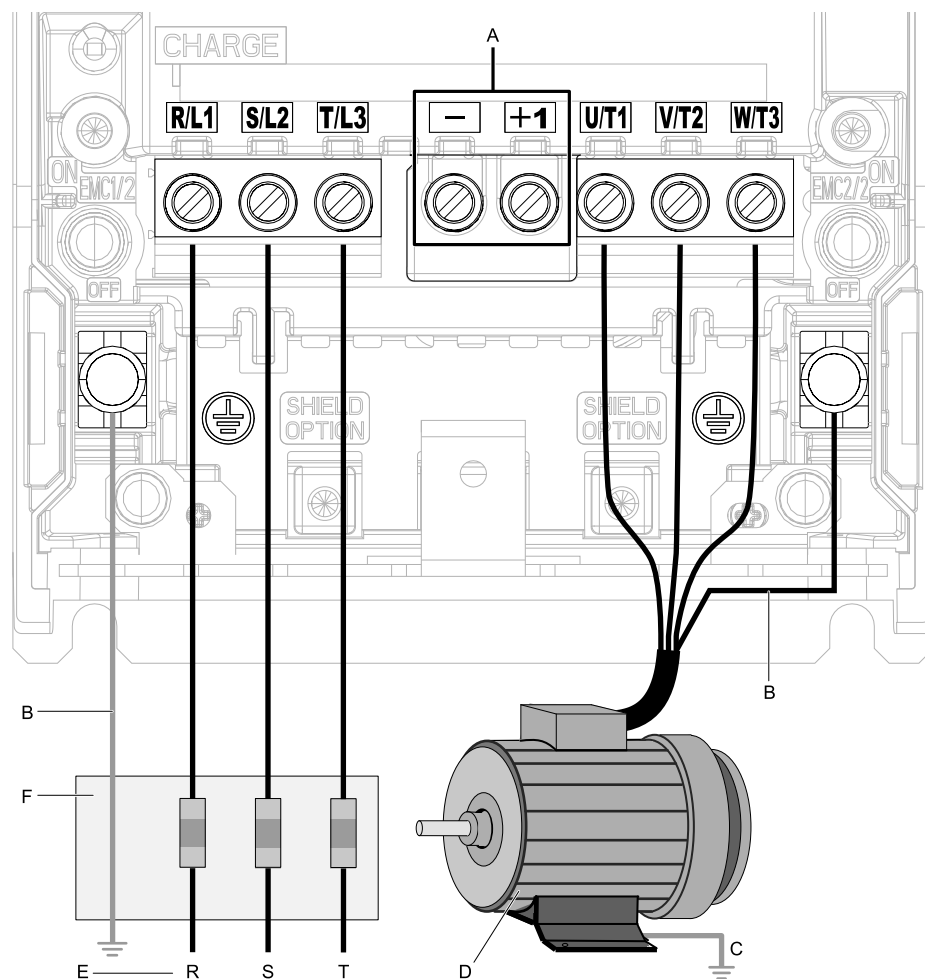

**Note:**

The location of terminals are different for different drive models.

**A - DC bus terminal**

**B - Connect to the drive ground terminal.**

**C - Ground the motor case.**

**D - Three-Phase Motor**

**E - Use R, S, T for input power supply.**

**F - Input Protection (Fuses or Circuit Breakers)**

■ **Wiring the Main Circuit and Motor (Models: 2xxxxT and 4xxxxT with Main Switch)**

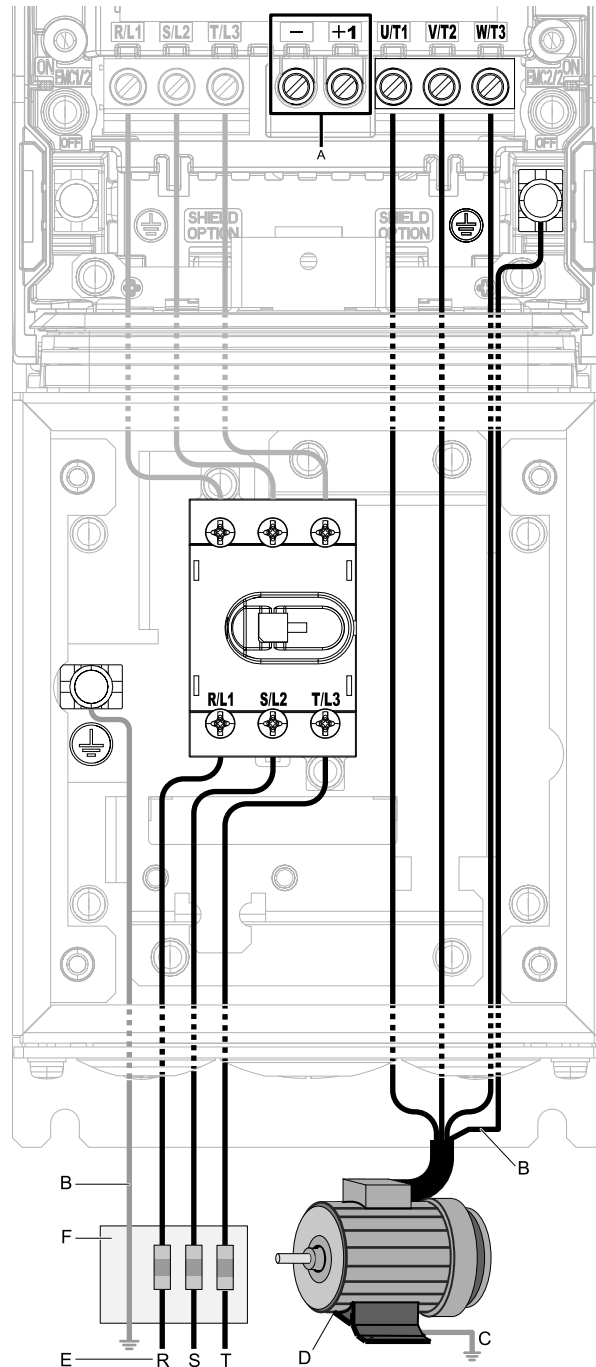

**Note:**

The location of terminals are different for different drive models.

- A - DC bus terminal <sup>\*1</sup>**
- B - Connect to the drive ground terminal.**
- C - Ground the motor case.**
- D - Three-Phase Motor**
- E - Use R, S, T for input power supply.**
- F - Input Protection (Fuses or Circuit Breakers)**

**Figure 3.3 Wiring the Main Circuit and Motor**

<sup>\*1</sup> You cannot use terminals - and +1 on IP55/UL Type 12 drives with Main Switch.

For drive models 2011xT to 2059xT and 4005xT to 4065xT with Main Switch, the tightening torques for the R/L1, S/L2, and T/L3 terminal screws are on a sticker next to the Main Switch terminal block.



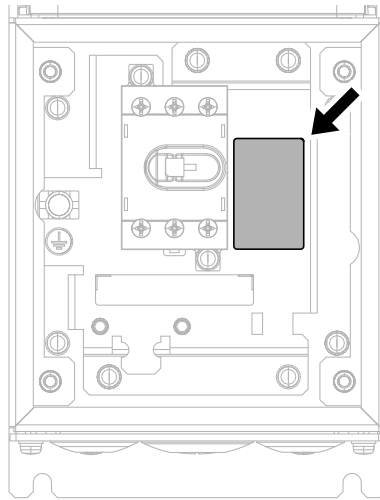

**Figure 3.4 Tightening Torque Display Location (Inside of Main Switch Cover)**

For models 2075xT to 2114xT and 4077xT to 4096xT, the torques for the R/L1, S/L2, and T/L3 terminal screws are on a sticker on the metallic plate of the Main Switch terminal block.

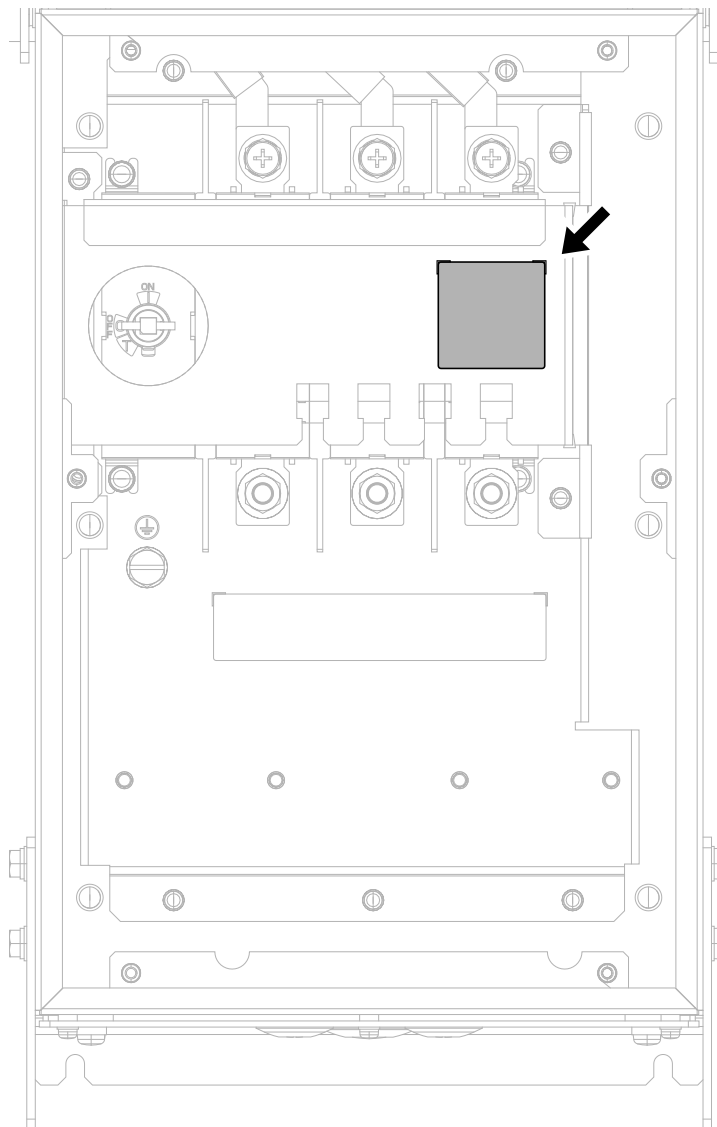

**Figure 3.5 Tightening Torque Display Location (Inside of Main Switch Cover)**

### ◆ Configuration of Main Circuit Terminal Block

Use [Table 3.1](#) or [Table 3.2](#) to find the correct figure for the main circuit terminal block of your drive.

**Table 3.1 Configuration of Main Circuit Terminal Block (Models: 2xxxxB/F/V and 4xxxxB/F/V)**

Model	Shape of Terminal <sup>*1</sup>	Figure
2011, 2017, 4005 - 4014	European terminal	<a href="#">Figure 3.6</a>
2024, 2031, 4021 - 4034	European terminal	<a href="#">Figure 3.7</a>
2046, 2059, 4040 - 4065	European terminal	<a href="#">Figure 3.8</a>
2075 - 2114, 4077 - 4124	Screw terminal	<a href="#">Figure 3.9</a>
2143, 2169, 4156	Screw terminal	<a href="#">Figure 3.10</a>
2211, 2273, 4180, 4240	Screw terminal	<a href="#">Figure 3.11</a>
4302	Screw terminal	<a href="#">Figure 3.12</a>

\*1 The ground terminal is a screw terminal.

**Table 3.2 Configuration of Main Circuit Terminal Block (Models: 2xxxxT and 4xxxxT)**

Model	Shape of Terminal <sup>*1</sup>	Figure
2011, 2017, 4005 - 4014	European terminal	<a href="#">Figure 3.13</a>
2024, 2031, 4021 - 4034	European terminal	<a href="#">Figure 3.14</a>
2046, 2059, 4040 - 4065	European terminal	<a href="#">Figure 3.15</a>
2075 - 2114, 4077 - 4096	Screw terminal	<a href="#">Figure 3.16</a>

\*1 The ground terminal is a screw terminal.

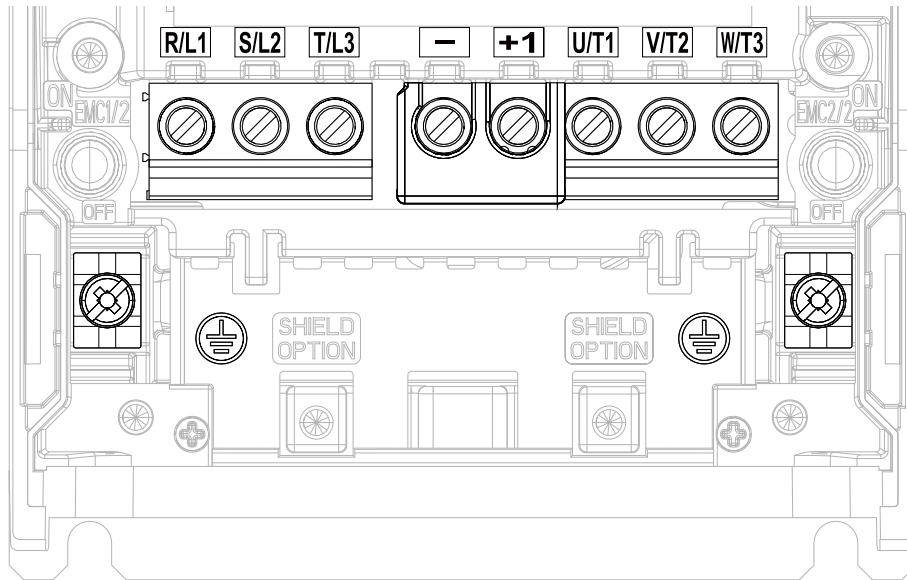

**Figure 3.6 Configuration of Main Circuit Terminal Block (2011, 2017, 4005 - 4014)**

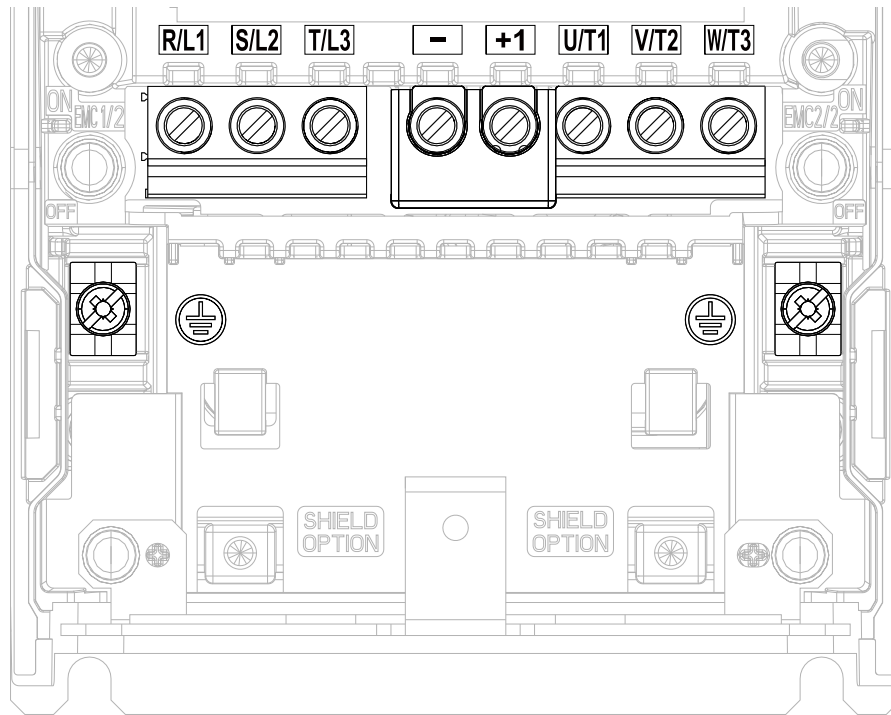

Figure 3.7 Configuration of Main Circuit Terminal Block (2024, 2031, 4021 - 4034)

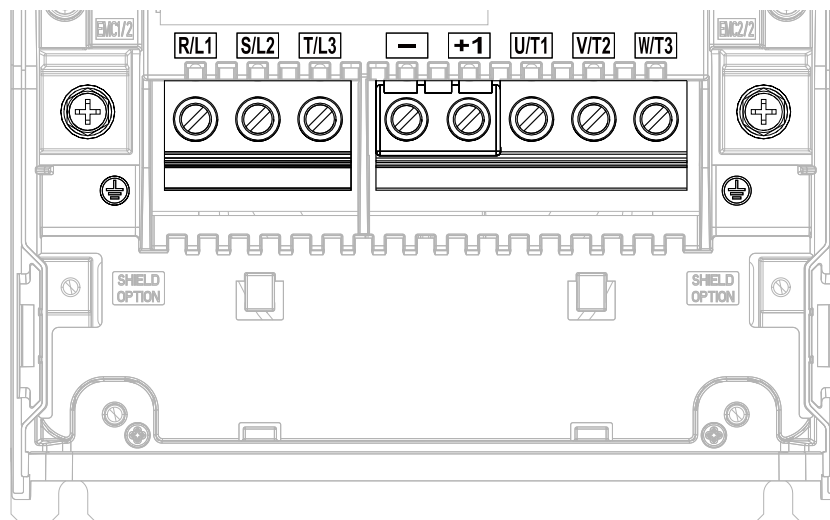

Figure 3.8 Configuration of Main Circuit Terminal Block (2046, 2059, 4040 - 4065)

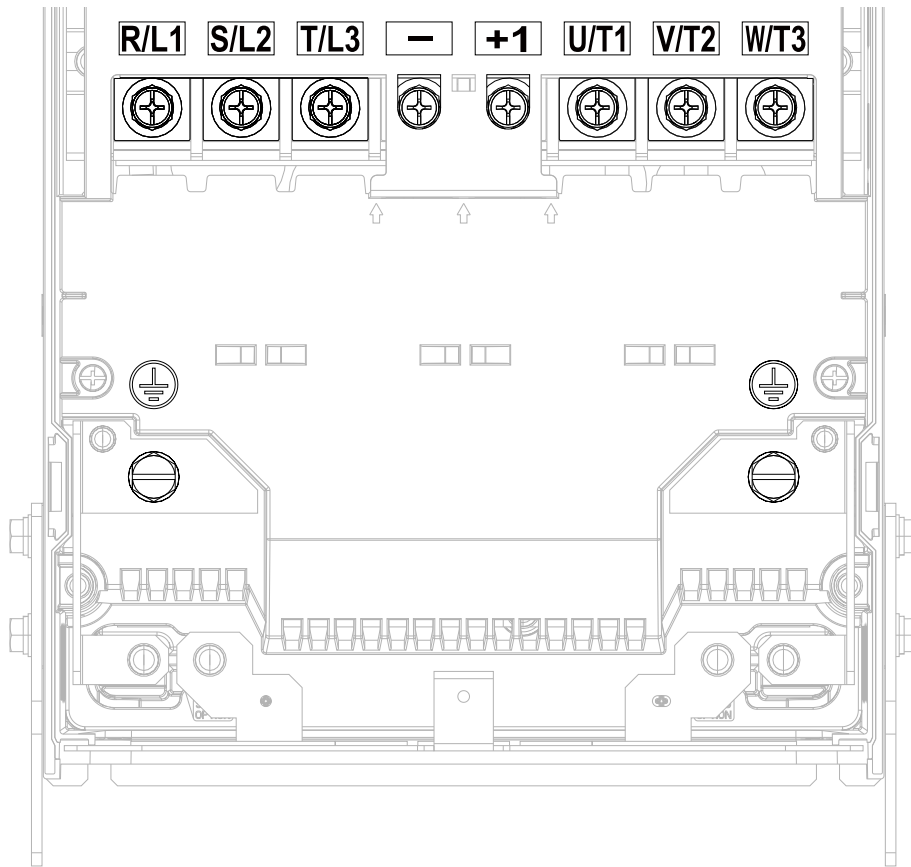

Figure 3.9 Configuration of Main Circuit Terminal Block (2075 - 2114, 4077 - 4124)

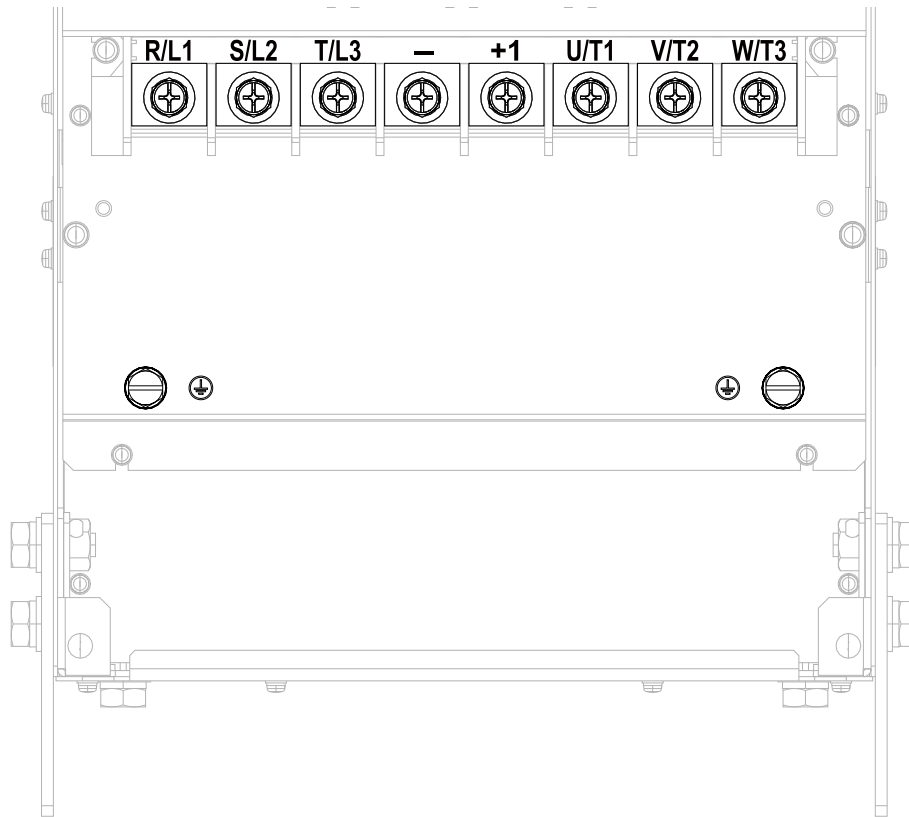

Figure 3.10 Configuration of Main Circuit Terminal Block (2143, 2169, 4156)

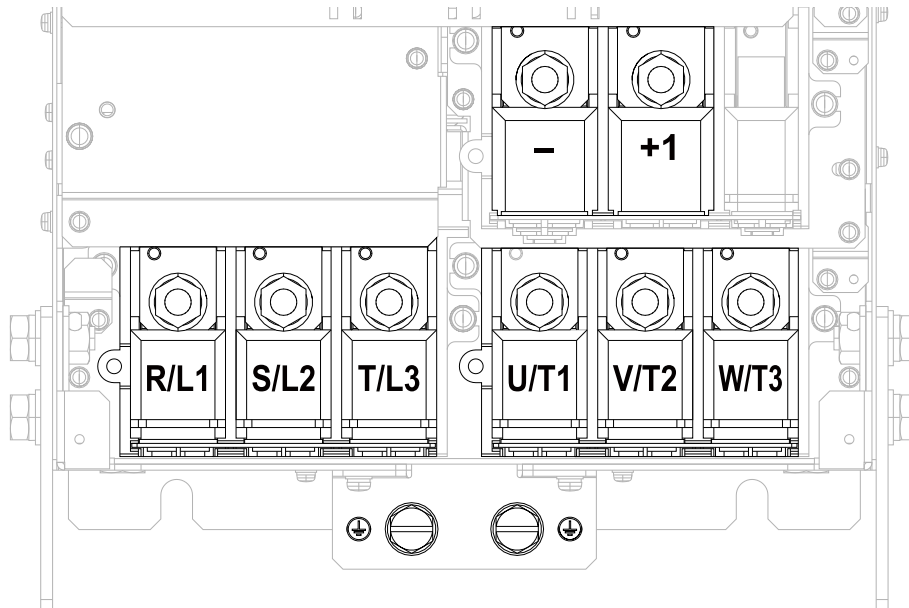

Figure 3.11 Configuration of Main Circuit Terminal Block (2211, 2273, 4180, 4240)

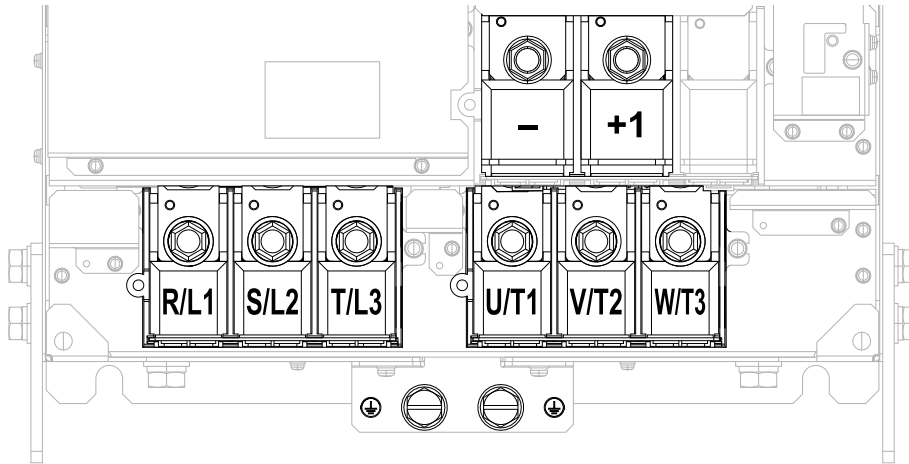

Figure 3.12 Configuration of Main Circuit Terminal Block (4302)

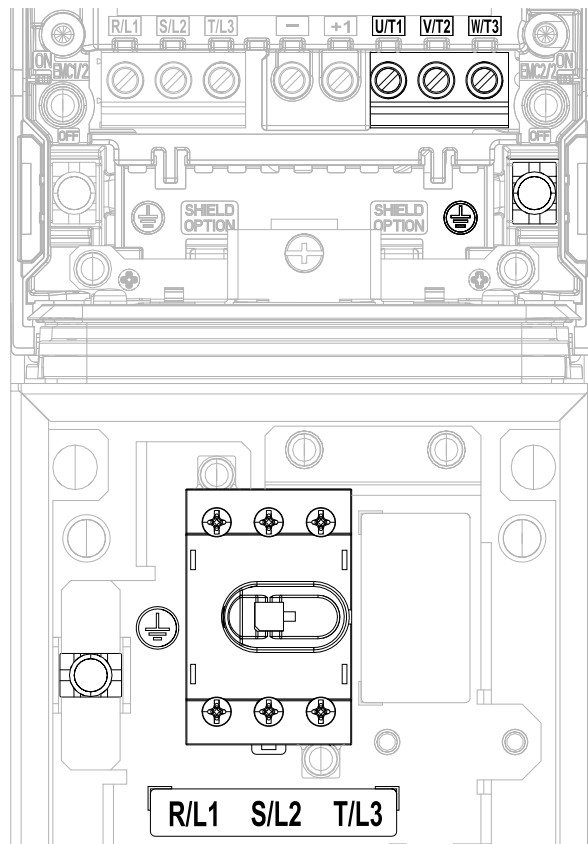

Figure 3.13 Configuration of Main Circuit Terminal Block (2011xT, 2017xT, 4005xT - 4014xT)

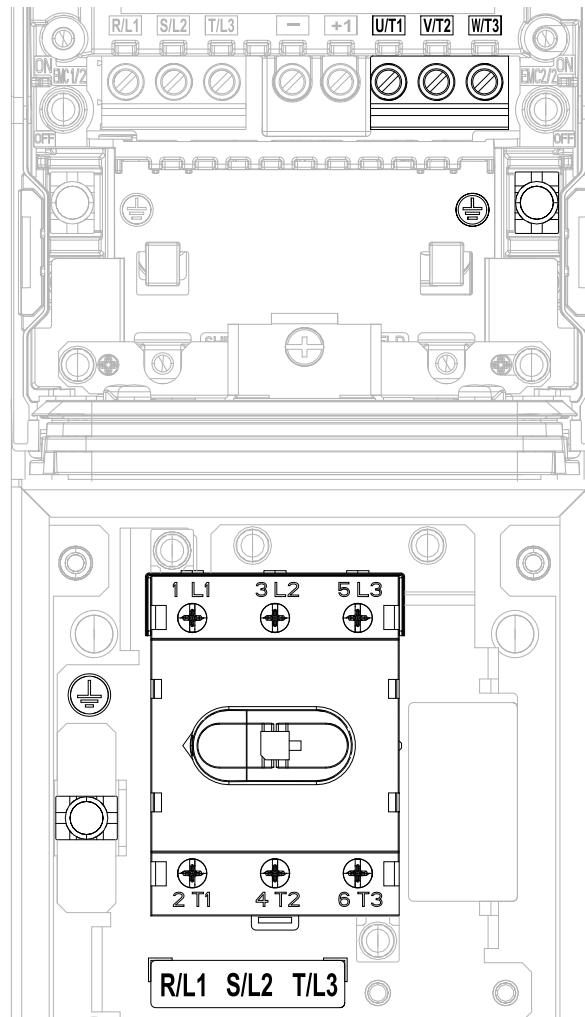

Figure 3.14 Configuration of Main Circuit Terminal Block (2024xT, 2031xT, 4021xT - 4034xT)

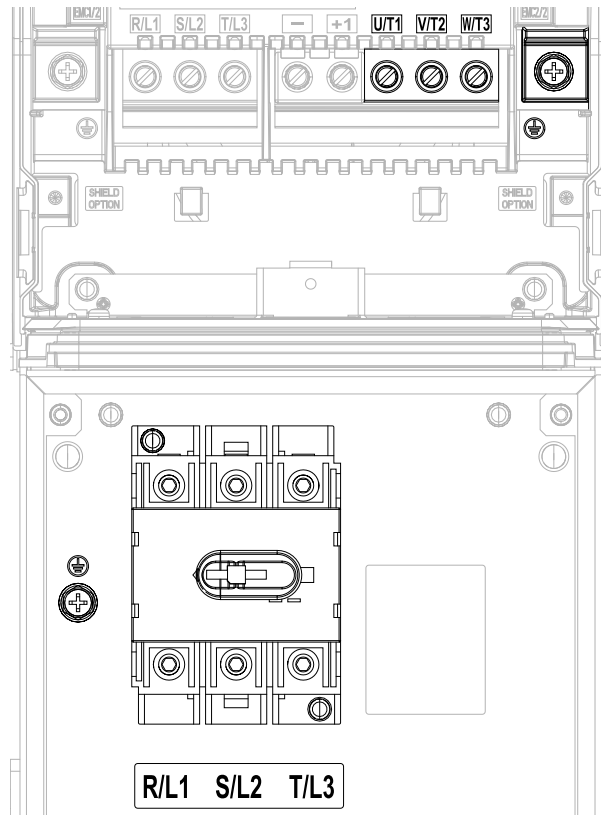

Figure 3.15 Configuration of Main Circuit Terminal Block (2046xT, 2059xT, 4040xT - 4065xT)

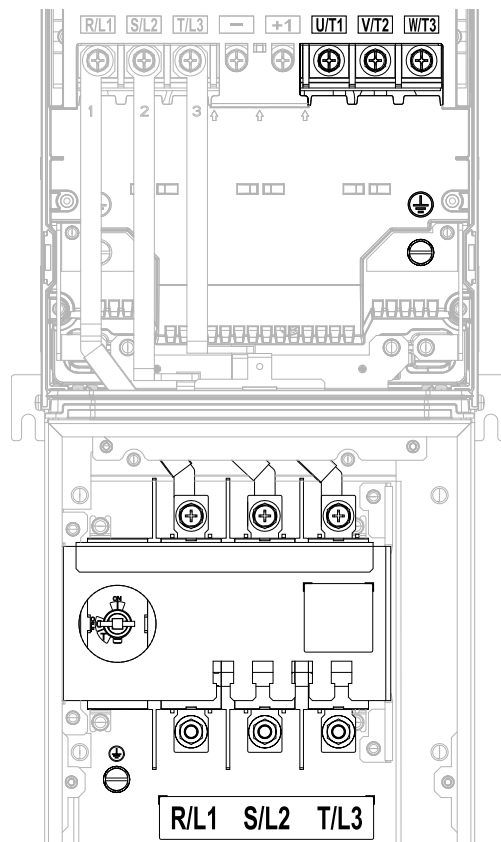

Figure 3.16 Configuration of Main Circuit Terminal Block (2075xT - 2114xT, 4077xT - 4096xT)



## ◆ Main Circuit Terminal Functions

Refer to [Table 3.3](#) for the functions of drive main circuit terminals.

**Table 3.3 Main Circuit Terminal Functions**

Terminal	Function
R/L1	Line side
S/L2	
T/L3	
U/T1	Load side
V/T2	
W/T3	
-	DC input terminal <i>*1</i>
+1	
⊕	Ground terminal

\*1 You cannot use terminals - and +1 on IP55/UL Type 12 drives with Main Switch.

## ◆ Wire Selection

Select the correct wires for main circuit wiring.

Refer to [Main Circuit Wire Gauges and Tightening Torques on page 206](#) for wire gauges and tightening torques as specified by European standards.

Refer to [Wire Gauge and Torque Specifications for UL Listing on page 75](#) for wire gauges and tightening torques as specified by UL standards.

### ■ Wire Selection Precautions

**WARNING! Electrical Shock Hazard.** Make sure that the protective ground wire complies with technical standards and local safety regulations. The IEC/EN 61800-5-1:2007 standard specifies that you must wire the power supply to automatically de-energize when the protective ground wire disconnects. You can also connect a protective ground wire that has a minimum cross-sectional area of 10mm<sup>2</sup> (copper wire) or 16 mm<sup>2</sup> (aluminum wire). For drive models on which you cannot use a protective ground wire of 10 mm<sup>2</sup> or more, install two protective ground wires that have the same cross-sectional area. If you do not obey the standards and regulations, it can cause serious injury or death. The leakage current of the drive will be more than 3.5 mA.

Think about line voltage drop before you select wire gauges. Select wire gauges that drop the voltage by 2% or less of the rated voltage. Increase the wire gauge and the cable length when the risk of voltage drop increases. Calculate line voltage drop with this formula:

Line voltage drop (V) =  $\sqrt{3} \times \text{wire resistance } (\Omega/\text{km}) \times \text{wiring distance } (\text{m}) \times \text{motor rated current } (\text{A}) \times 10^{-3}$ .

### ■ Precautions during Wiring

Use terminals +1 and - to connect a regenerative converter or regenerative unit.

### ■ Wire Gauge and Torque Specifications for UL Listing

**WARNING! Electrical Shock Hazard.** Make sure that the protective ground wire complies with technical standards and local safety regulations. The IEC/EN 61800-5-1:2007 standard specifies that you must wire the power supply to automatically de-energize when the protective ground wire disconnects. You can also connect a protective ground wire that has a minimum cross-sectional area of 10mm<sup>2</sup> (copper wire) or 16 mm<sup>2</sup> (aluminum wire). For drive models on which you cannot use a protective ground wire of 10 mm<sup>2</sup> or more, install two protective ground wires that have the same cross-sectional area. If you do not obey the standards and regulations, it can cause serious injury or death. The leakage current of the drive will be more than 3.5 mA.

Refer to [Three-Phase 208 V Class Wire Gauges and Torques \(Models: 2xxxxB/F/V without Main Switch\) on page 76](#) and [Three-Phase 480 V Class Wire Gauges and Torques \(Models: 4xxxxB/F/V without Main Switch\) on page 78](#) or [Three-Phase 208 V Class Wire Gauges and Torques \(Models: 2xxxxT with Main Swith\) on page 81](#) and [Three-Phase 480 V Class Wire Gauges and Torques \(Models: 4xxxxT with Main Switch\) on page 83](#) for the recommended wire gauges and tightening torques of the main circuit terminals.

### 3.3 Main Circuit Wiring









**Note:**

The recommended wires for the main circuit are 600 V, Class 2 vinyl-insulated copper wires with a continuous maximum operating temperature of 75 °C (167 °F). Assume these conditions:





















- Ambient temperature: 40 °C (104 °F) or lower
- Wiring distance: 100 m (3281 ft) or shorter
- Normal Duty Rated current value

#### Screw Shapes

**Table 3.4 Icons to Identify Screw Shapes**















Icon	Screw Shape	Icon	Screw Shape
	Phillips/slot combo (+/-)		Hex bolt (slotted)
	Slotted (-)		Hex self-locking nut
	Pozidriv #2		Hex socket cap (WAF: 4 mm)
	Hex bolt (cross-slotted)		Hex bolt and hex self-locking nut

#### Three-Phase 208 V Class Wire Gauges and Torques (Models: 2xxxxB/F/V without Main Switch)

Model	Terminals	Recommended Gauge AWG, kcmil	Applicable Gauge AWG, kcmil (mm <sup>2</sup> ) *1	IP20 Applicable Gauge *2 (mm <sup>2</sup> ) *1	Wire Stripping Length *3 mm	Terminal Screw Size and Shape	Tightening Torque N·m (lbf·in)
2011	R/L1, S/L2, T/L3	14	14 - 8 (2.5 - 10)	-	10	M4 	1.5 - 1.7 (13.5 - 15)
	U/T1, V/T2, W/T3	14	14 - 8 (2.5 - 10)	-	10	M4 	1.5 - 1.7 (13.5 - 15)
	-, +1	14	14 - 8 (2.5 - 10)	-	10	M4 	1.5 - 1.7 (13.5 - 15)
		12	14 - 8 (2.5 - 10)	-	-	M5 	2.0 - 2.5 (17.7 - 22.1)
2017	R/L1, S/L2, T/L3	12	14 - 8 (2.5 - 10)	-	10	M4 	1.5 - 1.7 (13.5 - 15)
	U/T1, V/T2, W/T3	10	14 - 8 (2.5 - 10)	-	10	M4 	1.5 - 1.7 (13.5 - 15)
	-, +1	10	14 - 8 (2.5 - 10)	-	10	M4 	1.5 - 1.7 (13.5 - 15)
		10	14 - 8 (2.5 - 10)	-	-	M5 	2.0 - 2.5 (17.7 - 22.1)
2024	R/L1, S/L2, T/L3	10	14 - 8 (2.5 - 10)	-	10	M4 	1.5 - 1.7 (13.5 - 15)
	U/T1, V/T2, W/T3	8	14 - 8 (2.5 - 10)	-	10	M4 	1.5 - 1.7 (13.5 - 15)
	-, +1	8	14 - 8 (2.5 - 10)	-	10	M4 	1.5 - 1.7 (13.5 - 15)
		10	14 - 8 (2.5 - 10)	-	-	M5 	2.0 - 2.5 (17.7 - 22.1)
2031	R/L1, S/L2, T/L3	8	14 - 8 (2.5 - 10)	-	10	M4 	1.5 - 1.7 (13.5 - 15)
	U/T1, V/T2, W/T3	8	14 - 8 (2.5 - 10)	-	10	M4 	1.5 - 1.7 (13.5 - 15)
	-, +1	8	14 - 8 (2.5 - 10)	-	10	M4 	1.5 - 1.7 (13.5 - 15)
		10	14 - 8 (2.5 - 10)	-	-	M5 	2.0 - 2.5 (17.7 - 22.1)

Model	Terminals	Recommended Gauge AWG, kcmil	Applicable Gauge AWG, kcmil (mm <sup>2</sup> ) *1	IP20 Applicable Gauge *2 (mm <sup>2</sup> ) *1	Wire Stripping Length *3 mm	Terminal Screw Size and Shape	Tightening Torque N·m (lbf·in)
2046	R/L1, S/L2, T/L3	8	14 - 4 (2.5 - 25)	-	18	M5	4.1 - 4.5 (36 - 40)
	U/T1, V/T2, W/T3	6	14 - 4 (2.5 - 25)	-	18	M5	4.1 - 4.5 (36 - 40)
	-, +1	6	14 - 4 (2.5 - 25)	-	18	M5	4.1 - 4.5 (36 - 40)
		8	14 - 4 (2.5 - 25)	-	-	M6	4.0 - 5.0 (35.4 - 44.3)
2059	R/L1, S/L2, T/L3	4	14 - 4 (2.5 - 25)	-	18	M5	4.1 - 4.5 (36 - 40)
	U/T1, V/T2, W/T3	4	14 - 4 (2.5 - 25)	-	18	M5	4.1 - 4.5 (36 - 40)
	-, +1	4	14 - 4 (2.5 - 25)	-	18	M5	4.1 - 4.5 (36 - 40)
		6	14 - 4 (2.5 - 25)	-	-	M6	4.0 - 5.0 (35.4 - 44.3)
2075	R/L1, S/L2, T/L3	4	8 - 2/0 (10 - 70)	-	-	M8	5.4 - 6.0 (47.8 - 53.1)
	U/T1, V/T2, W/T3	3 or 2	8 - 2/0 (10 - 70)	-	-	M8	5.4 - 6.0 (47.8 - 53.1)
	-, +1	2	8 - 2/0 (10 - 70)	-	-	M8	5.4 - 6.0 (47.8 - 53.1)
		6	8 - 2/0 (10 - 70)	-	-	M8	9.0 - 11 (79.7 - 97.4)
2088	R/L1, S/L2, T/L3	3 or 2	8 - 2/0 (10 - 70)	-	-	M8	5.4 - 6.0 (47.8 - 53.1)
	U/T1, V/T2, W/T3	2	8 - 2/0 (10 - 70)	-	-	M8	5.4 - 6.0 (47.8 - 53.1)
	-, +1	1	8 - 2/0 (10 - 70)	-	-	M8	5.4 - 6.0 (47.8 - 53.1)
		6	8 - 2/0 (10 - 70)	-	-	M8	9.0 - 11 (79.7 - 97.4)
2114	R/L1, S/L2, T/L3	1/0	8 - 2/0 (10 - 70)	-	-	M8	5.4 - 6.0 (47.8 - 53.1)
	U/T1, V/T2, W/T3	1/0	8 - 2/0 (10 - 70)	-	-	M8	5.4 - 6.0 (47.8 - 53.1)
	-, +1	2/0	8 - 2/0 (10 - 70)	-	-	M8	5.4 - 6.0 (47.8 - 53.1)
		6	8 - 2/0 (10 - 70)	-	-	M8	9.0 - 11 (79.7 - 97.4)
2143	R/L1, S/L2, T/L3	2/0	6 - 4/0 (16 - 95)	-	-	M8	13.5 - 15 (119.5 - 132.8)
	U/T1, V/T2, W/T3	3/0	6 - 4/0 (16 - 95)	-	-	M8	13.5 - 15 (119.5 - 132.8)
	-, +1	3/0	6 - 4/0 (16 - 95)	-	-	M8	13.5 - 15 (119.5 - 132.8)
		4	6 - 4/0 (16 - 95)	-	-	M8	9.0 - 11 (79.7 - 97.4)

### 3.3 Main Circuit Wiring











Model	Terminals	Recommended Gauge AWG, kcmil	Applicable Gauge AWG, kcmil (mm <sup>2</sup> ) *1	IP20 Applicable Gauge *2 (mm <sup>2</sup> ) *1	Wire Stripping Length *3 mm	Terminal Screw Size and Shape	Tightening Torque N·m (lbf·in)
2169	R/L1, S/L2, T/L3	3/0	6 - 4/0 (16 - 95)	-	-	M8 	13.5 - 15 (119.5 - 132.8)
	U/T1, V/T2, W/T3	4/0	6 - 4/0 (16 - 95)	-	-	M8 	13.5 - 15 (119.5 - 132.8)
	-, +1	1/0 × 2	6 - 4/0 (16 - 95)	-	-	M8 	13.5 - 15 (119.5 - 132.8)
		4	6 - 4/0 (16 - 95)	-	-	M8 	9.0 - 11 (79.7 - 97.4)
2211	R/L1, S/L2, T/L3	1/0 × 2	3 - 4/0 × 2P (25 - 95 × 2P)	2/0 - 4/0 × 2P (70 - 95 × 2P)	-	M10 	18 - 20 (159.3 - 177)
	U/T1, V/T2, W/T3	1/0 × 2	3 - 4/0 × 2P (25 - 95 × 2P)	2/0 - 4/0 × 2P (70 - 95 × 2P)	-	M10 	18 - 20 (159.3 - 177)
	-, +1	1/0 × 2	2 - 250 × 2P (35 - 120 × 2P)	4/0 - 250 × 2P (95 - 120 × 2P)	-	M10 	18 - 20 (159.3 - 177)
		3 or 2	4 - 350 (25 - 185)	-	-	M10 	18 - 23 (159 - 204)
2273	R/L1, S/L2, T/L3	2/0 × 2	3 - 4/0 × 2P (25 - 95 × 2P)	2/0 - 4/0 × 2P (70 - 95 × 2P)	-	M10 	18 - 20 (159.3 - 177)
	U/T1, V/T2, W/T3	2/0 × 2	3 - 4/0 × 2P (25 - 95 × 2P)	2/0 - 4/0 × 2P (70 - 95 × 2P)	-	M10 	18 - 20 (159.3 - 177)
	-, +1	3/0 × 2	2 - 250 × 2P (35 - 120 × 2P)	4/0 - 250 × 2P (95 - 120 × 2P)	-	M10 	18 - 20 (159.3 - 177)
		2	4 - 350 (25 - 185)	-	-	M10 	18 - 23 (159 - 204)

\*1 The metric wire gauge values are provided as reference information from equivalent AWG sizes and not exactly the same sizes as the AWG/kcmil values. Obey local safety regulations for wire sizes and make sure that the ferrule or crimp terminals are correct for your size.

\*2 For IP20 protection, use wires that are in the range of applicable gauges.

\*3 Remove insulation from the ends of wires to expose the length of wire shown.

#### Three-Phase 480 V Class Wire Gauges and Torques (Models: 4xxxxB/F/V without Main Switch)

Model	Terminal	Recommended Gauge AWG, kcmil	Applicable Gauge AWG, kcmil (mm <sup>2</sup> ) *1	IP20 Applicable Gauge *2 (mm <sup>2</sup> ) *1	Wire Stripping Length *3 mm	Terminal Screw Size and Shape	Tightening Torque N·m (lbf·in)
4005	R/L1, S/L2, T/L3	14	14 - 8 (2.5 - 10)	-	10	M4 	1.5 - 1.7 (13.5 - 15)
	U/T1, V/T2, W/T3	14	14 - 8 (2.5 - 10)	-	10	M4 	1.5 - 1.7 (13.5 - 15)
	-, +1	14	14 - 8 (2.5 - 10)	-	10	M4 	1.5 - 1.7 (13.5 - 15)
		14	14 - 8 (2.5 - 10)	-	-	M5 	2.0 - 2.5 (17.7 - 22.1)
4008	R/L1, S/L2, T/L3	14	14 - 8 (2.5 - 10)	-	10	M4 	1.5 - 1.7 (13.5 - 15)
	U/T1, V/T2, W/T3	14	14 - 8 (2.5 - 10)	-	10	M4 	1.5 - 1.7 (13.5 - 15)
	-, +1	14	14 - 8 (2.5 - 10)	-	10	M4 	1.5 - 1.7 (13.5 - 15)
		14	14 - 8 (2.5 - 10)	-	-	M5 	2.0 - 2.5 (17.7 - 22.1)

Model	Terminal	Recommended Gauge AWG, kcmil	Applicable Gauge AWG, kcmil (mm <sup>2</sup> ) *1	IP20 Applicable Gauge *2 (mm <sup>2</sup> ) *1	Wire Stripping Length *3 mm	Terminal Screw Size and Shape	Tightening Torque N·m (lbf·in)
4011	R/L1, S/L2, T/L3	14	14 - 8 (2.5 - 10)	-	10	M4 ⊖	1.5 - 1.7 (13.5 - 15)
	U/T1, V/T2, W/T3	14	14 - 8 (2.5 - 10)	-	10	M4 ⊖	1.5 - 1.7 (13.5 - 15)
	-, +1	14	14 - 8 (2.5 - 10)	-	10	M4 ⊖	1.5 - 1.7 (13.5 - 15)
	⊕	12	14 - 8 (2.5 - 10)	-	-	M5 ⊕	2.0 - 2.5 (17.7 - 22.1)
4014	R/L1, S/L2, T/L3	14	14 - 8 (2.5 - 10)	-	10	M4 ⊖	1.5 - 1.7 (13.5 - 15)
	U/T1, V/T2, W/T3	12	14 - 8 (2.5 - 10)	-	10	M4 ⊖	1.5 - 1.7 (13.5 - 15)
	-, +1	12	14 - 8 (2.5 - 10)	-	10	M4 ⊖	1.5 - 1.7 (13.5 - 15)
	⊕	10	14 - 8 (2.5 - 10)	-	-	M5 ⊕	2.0 - 2.5 (17.7 - 22.1)
4021	R/L1, S/L2, T/L3	10	14 - 8 (2.5 - 10)	-	10	M4 ⊖	1.5 - 1.7 (13.5 - 15)
	U/T1, V/T2, W/T3	10	14 - 8 (2.5 - 10)	-	10	M4 ⊖	1.5 - 1.7 (13.5 - 15)
	-, +1	10	14 - 8 (2.5 - 10)	-	10	M4 ⊖	1.5 - 1.7 (13.5 - 15)
	⊕	10	14 - 8 (2.5 - 10)	-	-	M5 ⊕	2.0 - 2.5 (17.7 - 22.1)
4027	R/L1, S/L2, T/L3	10	14 - 8 (2.5 - 10)	-	10	M4 ⊖	1.5 - 1.7 (13.5 - 15)
	U/T1, V/T2, W/T3	8	14 - 8 (2.5 - 10)	-	10	M4 ⊖	1.5 - 1.7 (13.5 - 15)
	-, +1	8	14 - 8 (2.5 - 10)	-	10	M4 ⊖	1.5 - 1.7 (13.5 - 15)
	⊕	10	14 - 8 (2.5 - 10)	-	-	M5 ⊕	2.0 - 2.5 (17.7 - 22.1)
4034	R/L1, S/L2, T/L3	8	14 - 8 (2.5 - 10)	-	10	M4 ⊖	1.5 - 1.7 (13.5 - 15)
	U/T1, V/T2, W/T3	8	14 - 8 (2.5 - 10)	-	10	M4 ⊖	1.5 - 1.7 (13.5 - 15)
	-, +1	8	14 - 8 (2.5 - 10)	-	10	M4 ⊖	1.5 - 1.7 (13.5 - 15)
	⊕	10	14 - 8 (2.5 - 10)	-	-	M5 ⊕	2.0 - 2.5 (17.7 - 22.1)
4040	R/L1, S/L2, T/L3	8	14 - 4 (2.5 - 25)	-	18	M5 ⊖	4.1 - 4.5 (36 - 40)
	U/T1, V/T2, W/T3	8	14 - 4 (2.5 - 25)	-	18	M5 ⊖	4.1 - 4.5 (36 - 40)
	-, +1	6	14 - 4 (2.5 - 25)	-	18	M5 ⊖	4.1 - 4.5 (36 - 40)
	⊕	8	14 - 4 (2.5 - 25)	-	-	M6 ⊕	4.0 - 5.0 (35.4 - 44.3)

### 3.3 Main Circuit Wiring

Model	Terminal	Recommended Gauge AWG, kcmil	Applicable Gauge AWG, kcmil (mm <sup>2</sup> ) *1	IP20 Applicable Gauge *2 (mm <sup>2</sup> ) *1	Wire Stripping Length *3 mm	Terminal Screw Size and Shape	Tightening Torque N·m (lbf·in)
4052	R/L1, S/L2, T/L3	6	14 - 4 (2.5 - 25)	-	18	M5 ⊖	4.1 - 4.5 (36 - 40)
	U/T1, V/T2, W/T3	6	14 - 4 (2.5 - 25)	-	18	M5 ⊖	4.1 - 4.5 (36 - 40)
	-, +1	4	14 - 4 (2.5 - 25)	-	18	M5 ⊖	4.1 - 4.5 (36 - 40)
	⊕	8	14 - 4 (2.5 - 25)	-	-	M6 ⊕	4.0 - 5.0 (35.4 - 44.3)
4065	R/L1, S/L2, T/L3	4	14 - 4 (2.5 - 25)	-	18	M5 ⊖	4.1 - 4.5 (36 - 40)
	U/T1, V/T2, W/T3	4	14 - 4 (2.5 - 25)	-	18	M5 ⊖	4.1 - 4.5 (36 - 40)
	-, +1	4	14 - 4 (2.5 - 25)	-	18	M5 ⊖	4.1 - 4.5 (36 - 40)
	⊕	6	14 - 4 (2.5 - 25)	-	-	M6 ⊕	4.0 - 5.0 (35.4 - 44.3)
4077	R/L1, S/L2, T/L3	4	8 - 2/0 (10 - 70)	-	-	M8 ⊕	5.4 - 6.0 (47.8 - 53.1)
	U/T1, V/T2, W/T3	3 or 2	8 - 2/0 (10 - 70)	-	-	M8 ⊕	5.4 - 6.0 (47.8 - 53.1)
	-, +1	2	8 - 2/0 (10 - 70)	-	-	M8 ⊕	5.4 - 6.0 (47.8 - 53.1)
	⊕	6	8 - 2/0 (10 - 70)	-	-	M8 ⊖	9.0 - 11 (79.7 - 97.4)
4096	R/L1, S/L2, T/L3	2	8 - 2/0 (10 - 70)	-	-	M8 ⊕	5.4 - 6.0 (47.8 - 53.1)
	U/T1, V/T2, W/T3	1	8 - 2/0 (10 - 70)	-	-	M8 ⊕	5.4 - 6.0 (47.8 - 53.1)
	-, +1	1	8 - 2/0 (10 - 70)	-	-	M8 ⊕	5.4 - 6.0 (47.8 - 53.1)
	⊕	6	8 - 2/0 (10 - 70)	-	-	M8 ⊖	9.0 - 11 (79.7 - 97.4)
4124	R/L1, S/L2, T/L3	1/0	8 - 2/0 (10 - 70)	-	-	M8 ⊕	5.4 - 6.0 (47.8 - 53.1)
	U/T1, V/T2, W/T3	2/0	8 - 2/0 (10 - 70)	-	-	M8 ⊕	5.4 - 6.0 (47.8 - 53.1)
	-, +1	2/0	8 - 2/0 (10 - 70)	-	-	M8 ⊕	5.4 - 6.0 (47.8 - 53.1)
	⊕	4	8 - 2/0 (10 - 70)	-	-	M8 ⊖	9.0 - 11 (79.7 - 97.4)
4156	R/L1, S/L2, T/L3	2/0	6 - 4/0 (16 - 95)	-	-	M8 ⊕	13.5 - 15 (119.5 - 132.8)
	U/T1, V/T2, W/T3	3/0	6 - 4/0 (16 - 95)	-	-	M8 ⊕	13.5 - 15 (119.5 - 132.8)
	-, +1	4/0	6 - 4/0 (16 - 95)	-	-	M8 ⊕	13.5 - 15 (119.5 - 132.8)
	⊕	4	6 - 4/0 (16 - 95)	-	-	M8 ⊖	9.0 - 11 (79.7 - 97.4)

Model	Terminal	Recommended Gauge AWG, kcmil	Applicable Gauge AWG, kcmil (mm <sup>2</sup> ) *1	IP20 Applicable Gauge *2 (mm <sup>2</sup> ) *1	Wire Stripping Length *3 mm	Terminal Screw Size and Shape	Tightening Torque N-m (lbf-in)
4180	R/L1, S/L2, T/L3	1/0 × 2	3 - 4/0 × 2P (25 - 95 × 2P)	2/0 - 4/0 × 2P (70 - 95 × 2P)	-	M10	18 - 20 (159.3 - 177)
	U/T1, V/T2, W/T3	1/0 × 2	3 - 4/0 × 2P (25 - 95 × 2P)	2/0 - 4/0 × 2P (70 - 95 × 2P)	-	M10	18 - 20 (159.3 - 177)
	-, +1	1/0 × 2	2 - 250 × 2P (35 - 120 × 2P)	4/0 - 250 × 2P (95 - 120 × 2P)	-	M10	18 - 20 (159.3 - 177)
		3 or 2	4 - 350 (25 - 185)	-	-	M10	18 - 23 (159 - 204)
4240	R/L1, S/L2, T/L3	1/0 × 2	3 - 4/0 × 2P (25 - 95 × 2P)	2/0 - 4/0 × 2P (70 - 95 × 2P)	-	M10	18 - 20 (159.3 - 177)
	U/T1, V/T2, W/T3	1/0 × 2	3 - 4/0 × 2P (25 - 95 × 2P)	2/0 - 4/0 × 2P (70 - 95 × 2P)	-	M10	18 - 20 (159.3 - 177)
	-, +1	2/0 × 2	2 - 250 × 2P (35 - 120 × 2P)	4/0 - 250 × 2P (95 - 120 × 2P)	-	M10	18 - 20 (159.3 - 177)
		2	4 - 350 (25 - 185)	-	-	M10	18 - 23 (159 - 204)
4302	R/L1, S/L2, T/L3	3/0 × 2	2/0 - 300 × 2P (70 - 150 × 2P)	250 - 300 × 2P (120 - 150 × 2P)	-	M12	31.5 - 35 (279 - 310)
	U/T1, V/T2, W/T3	3/0 × 2	2/0 - 300 × 2P (70 - 150 × 2P)	250 - 300 × 2P (120 - 150 × 2P)	-	M12	31.5 - 35 (279 - 310)
	-, +1	4/0 × 2	4/0 - 400 × 2P (95 - 185 × 2P)	300 - 400 × 2P (150 - 185 × 2P)	-	M12	31.5 - 35 (279 - 310)
		1/0	1 - 350 (50 - 185)	-	-	M12	32 - 40 (283 - 354)

\*1 The metric wire gauge values are provided as reference information from equivalent AWG sizes and not exactly the same sizes as the AWG/kcmil values. Obey local safety regulations for wire sizes and make sure that the ferrule or crimp terminals are correct for your size.

























\*2 For IP20 protection, use wires that are in the range of applicable gauges.

\*3 Remove insulation from the ends of wires to expose the length of wire shown.

### Three-Phase 208 V Class Wire Gauges and Torques (Models: 2xxxxT with Main Switch)

Model	Terminals *1	Recommended Gauge AWG, kcmil	Applicable Gauge AWG, kcmil (mm <sup>2</sup> ) *2	Wire Stripping Length *3 mm	Terminal Screw Size and Shape	Tightening Torque N-m (lbf-in)
2011	R/L1, S/L2, T/L3	14	14 - 8 (2.5 - 10)	9 - 10	M3.5	0.8 (7.0)
	U/T1, V/T2, W/T3	14	14 - 8 (2.5 - 10)	10	M4	1.5 - 1.7 (13.5 - 15)
		12	14 - 8 (2.5 - 10)	-	M5	2.0 - 2.5 (17.7 - 22.1)
2017	R/L1, S/L2, T/L3	12	14 - 8 (2.5 - 10)	9 - 10	M3.5	0.8 (7.0)
	U/T1, V/T2, W/T3	10	14 - 8 (2.5 - 10)	10	M4	1.5 - 1.7 (13.5 - 15)
		10	14 - 8 (2.5 - 10)	-	M5	2.0 - 2.5 (17.7 - 22.1)
2024	R/L1, S/L2, T/L3	10	14 - 4 (2.5 - 25)	AWG 14 - AWG 10: 13 - 14.5 AWG 8 - AWG 4: 10 - 12 *4	M5	2.0 (18.0)
	U/T1, V/T2, W/T3	8	14 - 8 (2.5 - 10)	10	M4	1.5 - 1.7 (13.5 - 15)
		10	14 - 8 (2.5 - 10)	-	M5	2.0 - 2.5 (17.7 - 22.1)

### 3.3 Main Circuit Wiring

Model	Terminals *1	Recommended Gauge AWG, kcmil	Applicable Gauge AWG, kcmil (mm <sup>2</sup> ) *2	Wire Stripping Length *3 mm	Terminal Screw Size and Shape	Tightening Torque N·m (lbf·in)
2031	R/L1, S/L2, T/L3	8	14 - 4 (2.5 - 25)	AWG 14 - AWG 10: 13 - 14.5 AWG 8 - AWG 4: 10 - 12 *4	M5 	2.0 (18.0)
	U/T1, V/T2, W/T3	8	14 - 8 (2.5 - 10)	10	M4 	1.5 - 1.7 (13.5 - 15)
		10	14 - 8 (2.5 - 10)	-	M5 	2.0 - 2.5 (17.7 - 22.1)
2046	R/L1, S/L2, T/L3	8	8 - 1/0 (10 - 50)	18 - 21	M8 	6.2 (55.0)
	U/T1, V/T2, W/T3	6	14 - 4 (2.5 - 25)	18	M5 	4.1 - 4.5 (36 - 40)
		8	14 - 4 (2.5 - 25)	-	M6 	4.0 - 5.0 (35.4 - 44.3)
2059	R/L1, S/L2, T/L3	4	8 - 1/0 (10 - 50)	18 - 21	M8 	6.2 (55.0)
	U/T1, V/T2, W/T3	4	14 - 4 (2.5 - 25)	18	M5 	4.1 - 4.5 (36 - 40)
		6	14 - 4 (2.5 - 25)	-	M6 	4.0 - 5.0 (35.4 - 44.3)
2075	R/L1, S/L2, T/L3	4	8 - 2/0 (10 - 70)	-	M8 	15 - 22 (132.8 - 194.7)
	U/T1, V/T2, W/T3	3 or 2	8 - 2/0 (10 - 70)	-	M8 	5.4 - 6.0 (47.8 - 53.1)
		6	8 - 2/0 (10 - 70)	-	M8 	9.0 - 11 (79.7 - 97.4)
2088	R/L1, S/L2, T/L3	3 or 2	8 - 2/0 (10 - 70)	-	M8 	15 - 22 (132.8 - 194.7)
	U/T1, V/T2, W/T3	2	8 - 2/0 (10 - 70)	-	M8 	5.4 - 6.0 (47.8 - 53.1)
		6	8 - 2/0 (10 - 70)	-	M8 	9.0 - 11 (79.7 - 97.4)
2114	R/L1, S/L2, T/L3	1/0	8 - 2/0 (10 - 70)	-	M8 	15 - 22 (132.8 - 194.7)
	U/T1, V/T2, W/T3	1/0	8 - 2/0 (10 - 70)	-	M8 	5.4 - 6.0 (47.8 - 53.1)
		6	8 - 2/0 (10 - 70)	-	M8 	9.0 - 11 (79.7 - 97.4)

\*1 You cannot use terminals - and +1 on IP55/UL Type 12 drives with Main Switch.





























\*2 The metric wire gauge values are provided as reference information from equivalent AWG sizes and not exactly the same sizes as the AWG/kcmil values. Obey local safety regulations for wire sizes and make sure that the ferrule or crimp terminals are correct for your size.

\*3 Remove insulation from the ends of wires to expose the length of wire shown.





















\*4 The wire stripping length is different for different wire gauges.



## Three-Phase 480 V Class Wire Gauges and Torques (Models: 4xxxxT with Main Switch)

Model	Terminal <sup>*1</sup>	Recommended Gauge AWG, kcmil	Applicable Gauge AWG, kcmil (mm <sup>2</sup> ) <sup>*2</sup>	Wire Stripping Length <sup>*3</sup> mm	Terminal Screw Size and Shape	Tightening Torque N·m (lbf·in)
4005	R/L1, S/L2, T/L3	14	14 - 8 (2.5 - 10)	9 - 10	M3.5 	0.8 (7.0)
	U/T1, V/T2, W/T3	14	14 - 8 (2.5 - 10)	10	M4 	1.5 - 1.7 (13.5 - 15)
		14	14 - 8 (2.5 - 10)	-	M5 	2.0 - 2.5 (17.7 - 22.1)
4008	R/L1, S/L2, T/L3	14	14 - 8 (2.5 - 10)	9 - 10	M3.5 	0.8 (7.0)
	U/T1, V/T2, W/T3	14	14 - 8 (2.5 - 10)	10	M4 	1.5 - 1.7 (13.5 - 15)
		14	14 - 8 (2.5 - 10)	-	M5 	2.0 - 2.5 (17.7 - 22.1)
4011	R/L1, S/L2, T/L3	14	14 - 8 (2.5 - 10)	9 - 10	M3.5 	0.8 (7.0)
	U/T1, V/T2, W/T3	14	14 - 8 (2.5 - 10)	10	M4 	1.5 - 1.7 (13.5 - 15)
		12	14 - 8 (2.5 - 10)	-	M5 	2.0 - 2.5 (17.7 - 22.1)
4014	R/L1, S/L2, T/L3	14	14 - 8 (2.5 - 10)	9 - 10	M3.5 	0.8 (7.0)
	U/T1, V/T2, W/T3	12	14 - 8 (2.5 - 10)	10	M4 	1.5 - 1.7 (13.5 - 15)
		10	14 - 8 (2.5 - 10)	-	M5 	2.0 - 2.5 (17.7 - 22.1)
4021	R/L1, S/L2, T/L3	10	14 - 4 (2.5 - 25)	AWG 14 - AWG 10: 13 - 14.5 AWG 8 - AWG 4: 10 - 12 <sup>*4</sup>	M5 	2.0 (18.0)
	U/T1, V/T2, W/T3	10	14 - 8 (2.5 - 10)	10	M4 	1.5 - 1.7 (13.5 - 15)
		10	14 - 8 (2.5 - 10)	-	M5 	2.0 - 2.5 (17.7 - 22.1)
4027	R/L1, S/L2, T/L3	10	14 - 4 (2.5 - 25)	AWG 14 - AWG 10: 13 - 14.5 AWG 8 - AWG 4: 10 - 12 <sup>*4</sup>	M5 	2.0 (18.0)
	U/T1, V/T2, W/T3	8	14 - 8 (2.5 - 10)	10	M4 	1.5 - 1.7 (13.5 - 15)
		10	14 - 8 (2.5 - 10)	-	M5 	2.0 - 2.5 (17.7 - 22.1)
4034	R/L1, S/L2, T/L3	8	14 - 4 (2.5 - 25)	AWG 14 - AWG 10: 13 - 14.5 AWG 8 - AWG 4: 10 - 12 <sup>*4</sup>	M5 	2.0 (18.0)
	U/T1, V/T2, W/T3	8	14 - 8 (2.5 - 10)	10	M4 	1.5 - 1.7 (13.5 - 15)
		10	14 - 8 (2.5 - 10)	-	M5 	2.0 - 2.5 (17.7 - 22.1)

### 3.3 Main Circuit Wiring

Model	Terminal <sup>*1</sup>	Recommended Gauge AWG, kcmil	Applicable Gauge AWG, kcmil (mm <sup>2</sup> ) <sup>*2</sup>	Wire Stripping Length <sup>*3</sup> mm	Terminal Screw Size and Shape	Tightening Torque N·m (lbf·in)
4040	R/L1, S/L2, T/L3	8	8 - 1/0 (10 - 50)	18 - 21	M8 	6.2 (55.0)
	U/T1, V/T2, W/T3	8	14 - 4 (2.5 - 25)	18	M5 	4.1 - 4.5 (36 - 40)
		8	14 - 4 (2.5 - 25)	-	M6 	4.0 - 5.0 (35.4 - 44.3)
4052	R/L1, S/L2, T/L3	6	8 - 1/0 (10 - 50)	18 - 21	M8 	6.2 (55.0)
	U/T1, V/T2, W/T3	6	14 - 4 (2.5 - 25)	18	M5 	4.1 - 4.5 (36 - 40)
		8	14 - 4 (2.5 - 25)	-	M6 	4.0 - 5.0 (35.4 - 44.3)
4065	R/L1, S/L2, T/L3	4	8 - 1/0 (10 - 50)	18 - 21	M8 	6.2 (55.0)
	U/T1, V/T2, W/T3	4	14 - 4 (2.5 - 25)	18	M5 	4.1 - 4.5 (36 - 40)
		6	14 - 4 (2.5 - 25)	-	M6 	4.0 - 5.0 (35.4 - 44.3)
4077	R/L1, S/L2, T/L3	4	8 - 2/0 (10 - 70)	-	M8 	15 - 22 (132.8 - 194.7)
	U/T1, V/T2, W/T3	3 or 2	8 - 2/0 (10 - 70)	-	M8 	5.4 - 6.0 (47.8 - 53.1)
		6	8 - 2/0 (10 - 70)	-	M8 	9.0 - 11 (79.7 - 97.4)
4096	R/L1, S/L2, T/L3	2	8 - 2/0 (10 - 70)	-	M8 	15 - 22 (132.8 - 194.7)
	U/T1, V/T2, W/T3	1	8 - 2/0 (10 - 70)	-	M8 	5.4 - 6.0 (47.8 - 53.1)
		6	8 - 2/0 (10 - 70)	-	M8 	9.0 - 11 (79.7 - 97.4)

\*1 You cannot use terminals - and +1 on IP55/UL Type 12 drives with Main Switch.

\*2 The metric wire gauge values are provided as reference information from equivalent AWG sizes and not exactly the same sizes as the AWG/kcmil values. Obey local safety regulations for wire sizes and make sure that the ferrule or crimp terminals are correct for your size.

\*3 Remove insulation from the ends of wires to expose the length of wire shown.

\*4 The wire stripping length is different for different wire gauges.

### ◆ Main Circuit Terminal and Motor Wiring

This section outlines the various steps, precautions, and checkpoints to wire the main circuit terminals and motor terminals.

**WARNING! Fire Hazard.** Do not connect main power supply wiring to drive motor terminals U/T1, V/T2, and W/T3. Connect main power supply wiring to main circuit input terminals R/L1, S/L2, and T/L3. Incorrect wiring can cause serious injury or death from fire.

**WARNING! Sudden Movement Hazard.** Make sure that you align the phase order for the drive and motor when you connect the motor to drive output terminals U/T1, V/T2, and W/T3. If the phase order is incorrect, it can cause the motor to run in reverse. If the motor accidentally runs in reverse, it can cause serious injury or death.

**NOTICE:** Do not connect phase-advancing capacitors, LC/RC noise filters, or leakage breakers (GFCI) to the motor circuit. If you connect these devices to the output circuits, it can cause damage to the drive and connected equipment.

### ■ Cable Length Between Drive and Motor

When the wiring between the drive and the motor is too long, voltage drop along the motor cable can decrease motor torque, usually at low frequency output. If you use a long motor cable to connect motors in parallel, this is also a problem. Drive output current increases when the leakage current from the cable increases. An increase in leakage current can cause overcurrent and decrease the precision of current detection.

Use the values in [L8-27: Overcurrent Detection Gain on page 837](#) to adjust the drive carrier frequency. If the system configuration makes the motor wiring distance more than 100 m (328 ft), do not use metal conduits or use isolated cables for each phase to decrease stray capacitance.

**Table 3.5 Carrier Frequency against Cable Length Between Drive and Motor**

Wiring Distance between the Drive and Motor	100 m (328 ft) Maximum
Carrier Frequency	2 kHz or less

**Note:**

- For drive models 2011, 2017 and 4005 to 4014:
  - Shorter than 10 m: No carrier frequency derating from default setting (5 kHz) is necessary.
  - 10 m to 50 m: 5 kHz to 2 kHz is necessary.
  - 50 m and longer: 2 kHz
- To set the carrier frequency in a drive that is operating more than one motor, calculate the cable length as the total distance of wiring to all connected motors.
- When you connect to a PM motor, it can be necessary to adjust the overcurrent detection. Refer to [L8-27: Overcurrent Detection Gain on page 837](#) for more information.

## ■ Ground Wiring

Follow these precautions to wire the ground for one drive or a series of drives.

**WARNING! Electrical Shock Hazard.** Make sure that the protective ground wire complies with technical standards and local safety regulations. The IEC/EN 61800-5-1:2007 standard specifies that you must wire the power supply to automatically de-energize when the protective ground wire disconnects. You can also connect a protective ground wire that has a minimum cross-sectional area of 10mm<sup>2</sup> (copper wire) or 16 mm<sup>2</sup> (aluminum wire). For drive models on which you cannot use a protective ground wire of 10 mm<sup>2</sup> or more, install two protective ground wires that have the same cross-sectional area. If you do not obey the standards and regulations, it can cause serious injury or death. The leakage current of the drive will be more than 3.5 mA.

**WARNING! Electrical Shock Hazard.** Ground the neutral point on the power supply of the drives to comply with the EMC Directive before you turn on the EMC filter. If you turn ON the EMC filter, but you do not ground the neutral point, it can cause serious injury or death.

**WARNING! Electrical Shock Hazard.** Use a ground wire that complies with technical standards on electrical equipment and use the minimum length of ground wire. Incorrect equipment grounding can cause serious injury or death from dangerous electrical potentials on the equipment chassis.

**Note:**

- Only use the drive grounding wire to ground the drive. Do not share the ground wire with other devices, for example, welding machines or large-current electrical equipment. Incorrect equipment grounding can cause incorrect operation of drives and equipment.
- To connect more than one drive to the same grounding circuit, use the instructions in the manual. Incorrect equipment grounding can cause incorrect operation of drives and equipment.

When you install more than one drive, refer to [Figure 3.17](#). Do not loop the grounding wire.

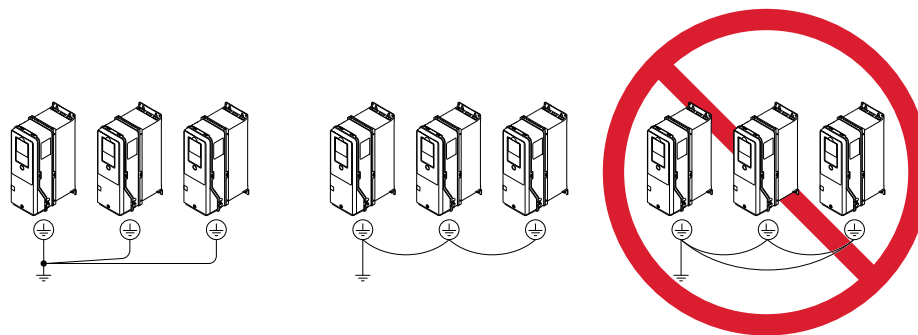

**Figure 3.17 Wiring More than One Drive**

## ■ Wiring the Main Circuit Terminal Block

**WARNING! Electrical Shock Hazard.** Before you wire the main circuit terminals, make sure that MCCB and MC are OFF. If you touch electrical equipment when MCCB and MC are ON, it can cause serious injury or death.

## ■ Main Circuit Configuration

The figures in this section show the different schematics of the drive main circuit. The connections change when the drive capacity changes. The DC power supply for the main circuit also supplies power to the control circuit.

### 3.3 Main Circuit Wiring

**NOTICE:** Do not use the negative DC bus terminal “-” as a ground terminal. This terminal is at high DC voltage potential. Incorrect wiring connections can cause damage to the drive.

Model	Figure
<p>2xxxxB/F/V and 4xxxxB/F/V without Main Switch 2011 to 2273 4005 to 4302</p>	
<p>2xxxxT and 4xxxxT with Main Switch 2011 to 2114 4005 to 4096</p>	<p><b>Note:</b> For drive models 2xxxxT and 4xxxxT with Main Switch, you cannot use terminals - and +1.</p>

#### ◆ Protection of Main Circuit Terminals

When you wire the main circuit terminals, do not let cable ends go near terminals or the drive. If you use crimped terminals, make sure that you also use insulation caps.

## 3.4 Main Circuit Terminal Block Wiring Procedure

**DANGER! Electrical Shock Hazard.** Do not examine, connect, or disconnect wiring on an energized drive. Before servicing, disconnect all power to the equipment and wait for the time specified on the warning label at a minimum. The internal capacitor stays charged after the drive is de-energized. The charge indicator LED extinguishes when the DC bus voltage decreases below 50 Vdc. When all indicators are OFF, remove the covers before measuring for dangerous voltages to make sure that the drive is safe. If you do work on the drive when it is energized, it will cause serious injury or death from electrical shock.

**WARNING! Electrical Shock Hazard.** Make sure that there is an electrical bond between the metallic conduit and the metallic conduit mounting bracket after installation is complete. If there is not an electrical bond, it can cause injury or death from electrical shock.

The procedures to wire the main circuit terminal block are different for different drive models. Refer to [Table 3.6](#) for procedures by drive model.

**Table 3.6 Types of Wiring Procedure for the Main Circuit Terminal Block**

Model	IP20/UL Open Type or IP20/UL Type 1 Models: 2xxxxB/F and 4xxxxB/F		IP55/UL Type 12 Models: 2xxxxV and 4xxxxV		IP55/UL Type 12 with Main Switch Models: 2xxxxT and 4xxxxT	
	Procedure	Reference	Procedure	Reference	Procedure	Reference
2011 - 2059 4005 - 4065	Procedure A	89	Procedure E	96	Procedure G	98
2075 - 2114 4077 - 4124	Procedure B	90	Procedure F	97	Procedure H	99
2143, 2169 4156	Procedure C	92	-	-	-	-
2211 - 2273 4180 - 4302	Procedure D	94	-	-	-	-

### ◆ Notes on Wiring the Main Circuit Terminal Block of Models 2011 to 2059 and 4005 to 4065

Read these safety messages and notes before you wire the main circuit terminal block.

**WARNING! Fire Hazard.** Do not use bent or crushed wires. Remove the damaged end of the wire before you use it. Incorrect connections can cause death or serious injury from fire.

**WARNING! Fire Hazard.** If you use stranded wire, make sure that all of the wire strands are in the connection. Also, do not twist the stranded wire too much. Incorrect connections can cause death or serious injury from fire.

**NOTICE:** Do not solder stranded wire. Soldered wire connections can become loose over time and cause unsatisfactory drive performance.

**NOTICE:** If you use power tools to tighten the terminal screws, use a low speed setting (300 min<sup>-1</sup> (r/min) to 400 min<sup>-1</sup> (r/min)). High speeds can cause damage to the terminal screws.

**NOTICE:** Do not tighten the terminal screws at an angle of 5 degrees or more. Incorrect positioning can cause damage to the terminal screws.

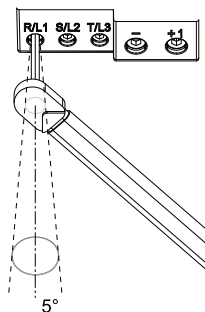
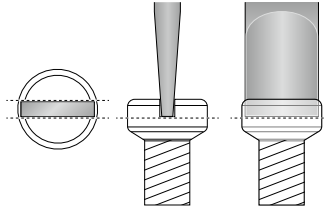

**Figure 3.18 Permitted Angle**

### 3.4 Main Circuit Terminal Block Wiring Procedure

**Note:**

- Use UL Listed vinyl-coated insulated copper wires for operation with a continuous maximum permitted temperature of 75 °C at 600 V.
- Remove all unwanted objects that are near the terminal block connections.
- Remove the insulation from the connection wires to the wire stripping lengths shown in the manual.
- Put the wire all the way into the terminal block. Remove the insulation from the wire to the recommended wire stripping length to fit the wire with insulation in the plastic housing.
- Use a torque driver, torque ratchet, or torque wrench for the screws. A slotted driver or a hex tool will be necessary to wire the screw clamp terminal. Use applicable tools as specified by the recommended conditions in the product manual.
- Users can purchase wiring tools from Yaskawa. Contact Yaskawa or your nearest sales representative for more information.
- Wire gauges on existing drive models to be replaced may not match wire gauge ranges on new drives. Contact Yaskawa or your nearest sales representative for more information about the connection procedures.
- Put the bit all the way into the hex socket to tighten the hex socket cap screw.
- When tightening slotted screws, hold the straight-edge screwdriver perpendicularly to the screw. Take care to ensure that the tip of the straight-edge screwdriver is aligned with the screw groove.





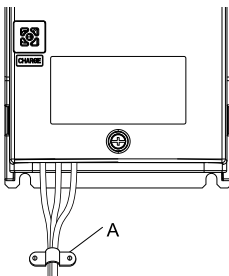
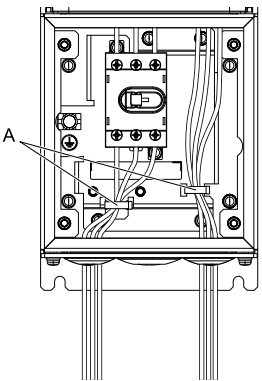
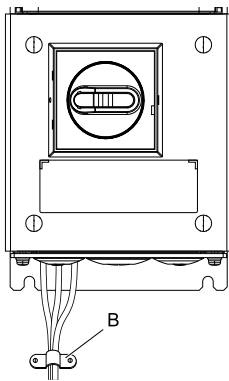

**Figure 3.19 Tightening Slotted Screws**

- After connecting the wires to the terminal block, lightly pull on the wires to make sure that they do not come out of the terminals.
- Remove the correct section of the wiring cover to make wiring easier.
- Do not let strain on the wiring cause damage. Use a strain relief near the wiring to release the tension. Refer to [Table 3.7](#) for an example.

**Table 3.7 Strain Relief Example**

Models: 2xxxxB/F/V and 4xxxxB/F/V without Main Switch	Models: 2xxxxT and 4xxxxT with Main Switch	
 <p><b>A - Cable clamp</b></p>	 <p><b>A - Cable ties</b></p>	 <p><b>B - Cable clamp</b></p>

**Table 3.8 Recommended Wiring Tools**

Screw Size and Shape	Adapter	Bit Model Manufacturer: PHOENIX CONTACT	Torque Driver Model (Adjustable Tightening Torque)
M3,5 	Pozidriv screw driver #2	-	-
M4 	Bit	SF-BIT-SL 1,0X4,0-70	TSD-M 3NM (0.2 - 3 N·m (1.8 - 26.6 lbf·in))
M5 *1 	Bit	SF-BIT-SL 1,2X6,5-70	TSD-M 3NM (0.2 - 3 N·m (1.8 - 26.6 lbf·in))
M5 	Pozidriv screw driver #2	-	-

\*1 For M5 screw size and the tightening torque is more than 3 N·m, use a torque wrench with the recommended bit.

## ◆ Notes on Wiring the Main Circuit Terminal Block of Models 2075 to 2114 and 4077 to 4124

### Note:

- After the wiring, do not twist or shake the electrical wires too much.
- Be sure to use only wires with the correct size, stripped wire length, and tightening torque as specified by Yaskawa.
- Use tools that fit the shape of the screw head to tighten and loosen the terminal block screws.
- Make sure that there are no loose stranded wires or frayed wires after wiring is complete.

## ◆ Wiring the Main Circuit Terminal Block Using Procedure A

### ■ Main Circuit Terminal Block Wiring Procedure

1. Remove the keypad and front cover.
2. Remove the screws that attach the conduit bracket and remove the conduit bracket from the drive.

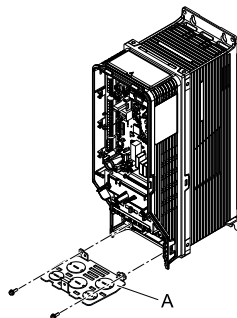

A - Conduit bracket

Figure 3.20 Remove the Conduit Bracket

3. Put the end of a straight-edge screwdriver into the center hole and move it up and down to remove the knock-out hole.

**WARNING!** *Injury to Personnel. Carefully move the screwdriver to remove the knock-out holes. If you use too much pressure on the circular metal plates, they can eject and cause injury.*

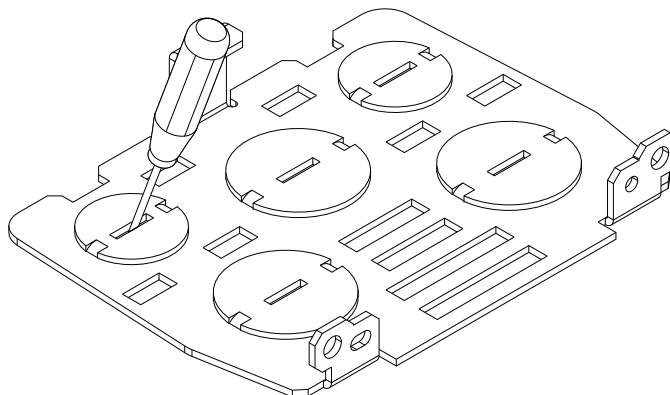

4. Use a file to make the rough surface of the knock-out hole edge smooth.

5. Put the conduit bracket in its initial position.

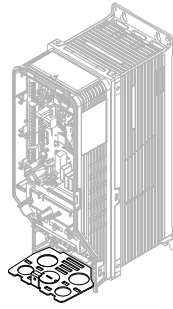
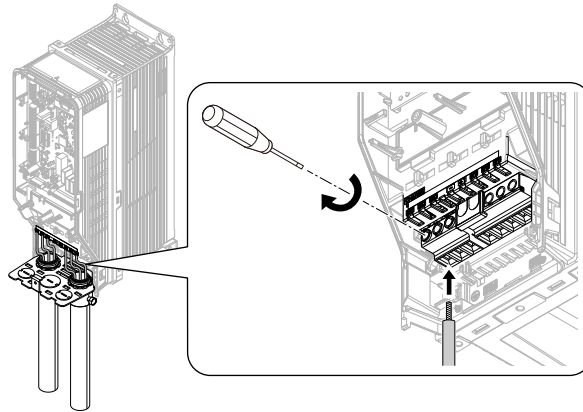

**Figure 3.21 Reattach the Conduit Bracket**

6. Put the ends of prepared wires through the conduits and into the terminal block, then tighten the terminal screws to the specified torque.

**Note:**

- When you use terminals - and +1 and these terminals have covers, remove them to install the wire.
- Install the included rubber grommets or use conduits to keep the IP20 protection level and to prevent damage to the wires. To comply with UL standards, you must use conduits for wiring.



**Figure 3.22 Install the Electrical Wires**

7. Install the front cover and the keypad to their initial positions.

---

## ◆ Wiring the Main Circuit Terminal Block Using Procedure B

### ■ Main Circuit Terminal Block Wiring Procedure

1. Remove the keypad and front cover.
2. Remove the screws that attach the conduit bracket and remove the conduit bracket from the drive.

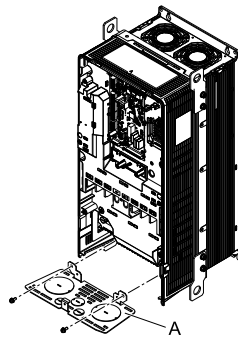

A - Conduit bracket

**Figure 3.23 Remove the Conduit Bracket**



- Put the end of a straight-edge screwdriver into the center hole and move it up and down to remove the knock-out hole.

**WARNING!** *Injury to Personnel. Carefully move the screwdriver to remove the knock-out holes. If you use too much pressure on the circular metal plates, they can eject and cause injury.*

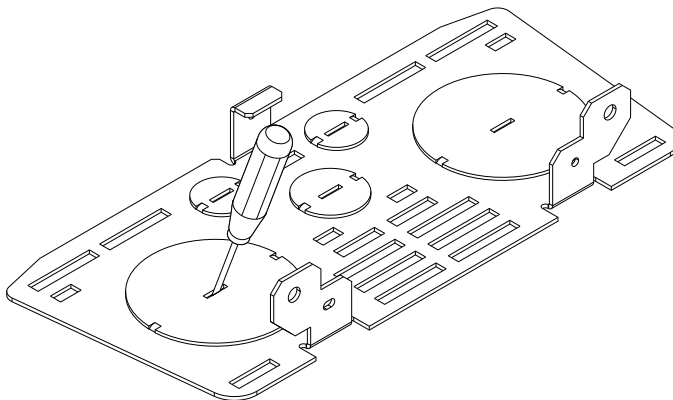

- Use a file to make the rough surface of the knock-out hole edge smooth.
- Put the conduit bracket in its initial position.

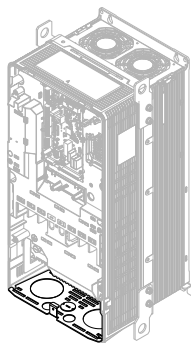

**Figure 3.24 Reattach the Conduit Bracket**

- Remove the terminal block bolt.

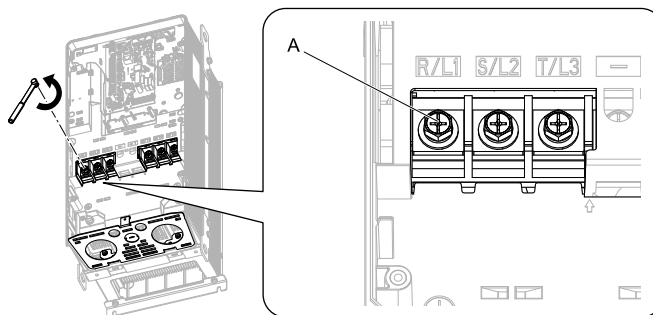

**A - Bolt**

**Figure 3.25 Remove the Terminal Block Bolts**

- Put the ends of wires with closed-loop crimp terminals through the conduits.

**Note:**

- When you use terminals - and +1 and these terminals have covers, remove them to install the wire.
- Install the included rubber grommets or use conduits to keep the IP20 protection level and to prevent damage to the wires. To comply with UL standards, you must use conduits for wiring.

### 3.4 Main Circuit Terminal Block Wiring Procedure

---

8. Align the closed-loop crimp terminals with the bolt holes on main circuit terminal block.

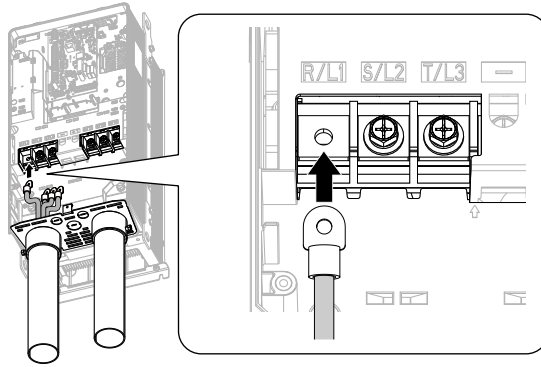

**Figure 3.26 Install the Electrical Wires**

9. Tighten the bolts to the specified torque.

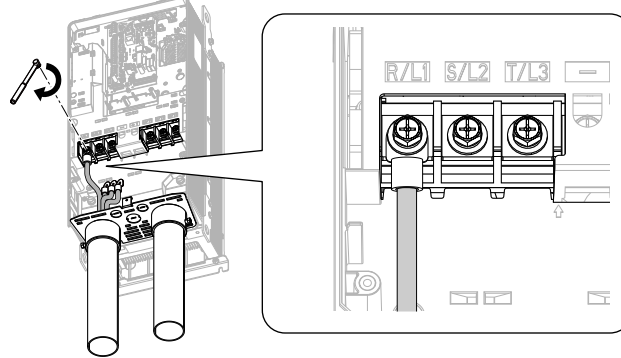

**Figure 3.27 Tighten the Terminal Block Bolts**

10. Put the terminal cover back in its initial position.

---

### ◆ Wiring the Main Circuit Terminal Block Using Procedure C

#### ■ Main Circuit Terminal Block Wiring Procedure

1. Remove the terminal cover.

- Remove the screws that attach the conduit bracket and remove the conduit bracket from the drive.

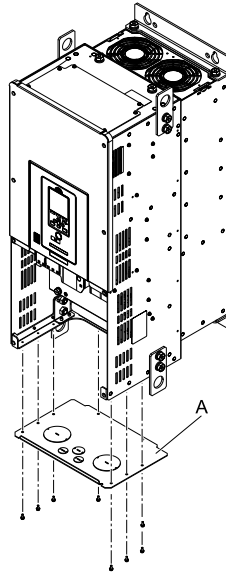

A - Conduit bracket

Figure 3.28 Remove the Conduit Bracket

- Put the end of a straight-edge screwdriver into the center hole and move it up and down to remove the knock-out hole.

**WARNING!** *Injury to Personnel. Carefully move the screwdriver to remove the knock-out holes. If you use too much pressure on the circular metal plates, they can eject and cause injury.*

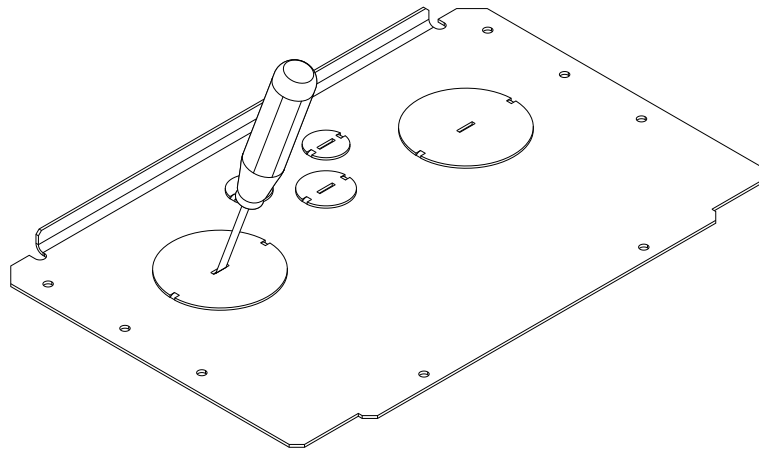

- Use a file to make the rough surface of the knock-out hole edge smooth.
- Put the conduit bracket in its initial position.

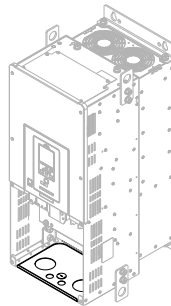
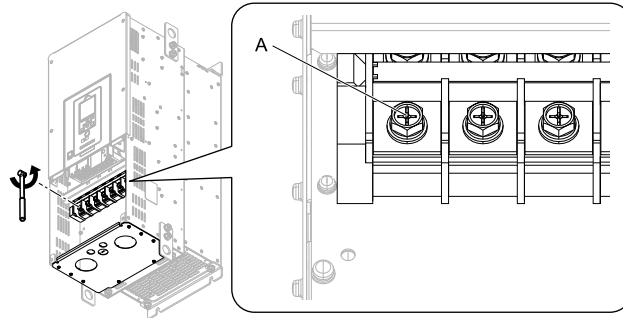

Figure 3.29 Reattach the Conduit Bracket

6. Remove the terminal block bolt.



A - Bolt

**Figure 3.30 Remove the Terminal Block Bolts**

7. Put the ends of wires with closed-loop crimp terminals through the conduits.

**Note:**

Install the included rubber grommets or use conduits to keep the IP20 protection level and to prevent damage to the wires. To comply with UL standards, you must use conduits for wiring.

8. Align the closed-loop crimp terminals with the bolt holes on main circuit terminal block.

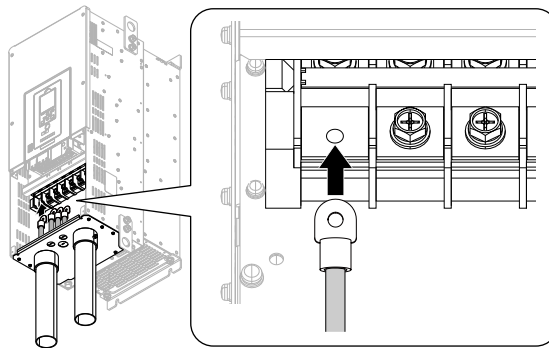

**Figure 3.31 Install the Electrical Wires**

9. Tighten the bolts to the specified torque.

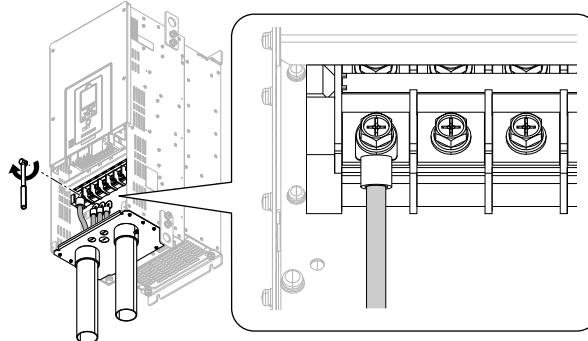

**Figure 3.32 Tighten the Terminal Block Bolts**

10. Put the terminal cover back in its initial position.

## ◆ Wiring the Main Circuit Terminal Block Using Procedure D

### ■ Main Circuit Terminal Block Wiring Procedure

1. Remove the terminal cover.

- Remove the screws on the terminal block cover and pull the terminal block cover away from the drive. Pull the wiring cover away from the drive. Do not discard the wiring cover.

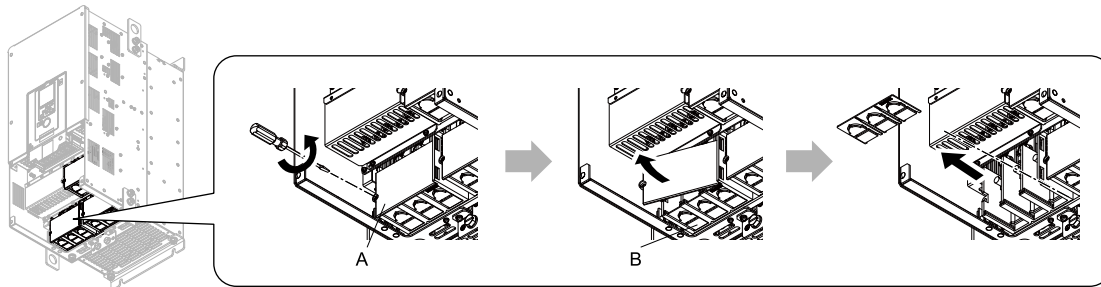

A - Terminal block cover

B - Wiring cover

Figure 3.33 Remove the Wiring Cover

- Remove the terminal block nuts.

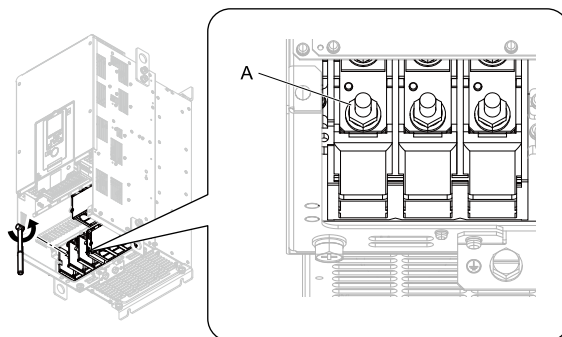

A - Nut

Figure 3.34 Remove the Terminal Block Nuts

- Put the ends of wires with closed-loop crimp terminals on the main circuit terminal block studs.

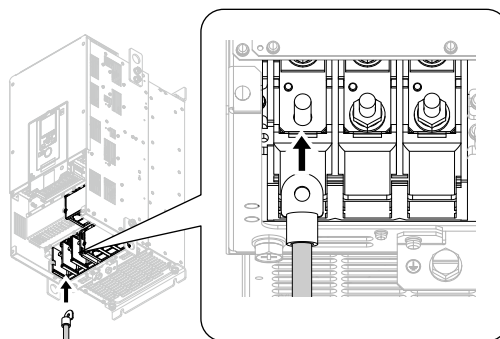

Figure 3.35 Install the Electrical Wires

- Tighten the nuts to the specified torque.

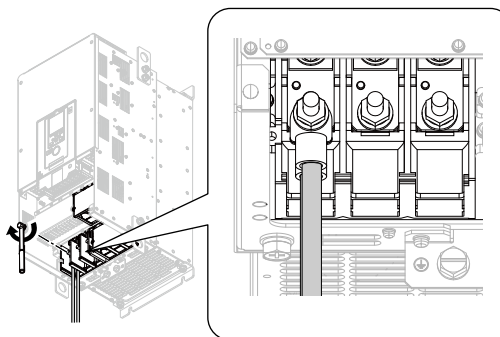
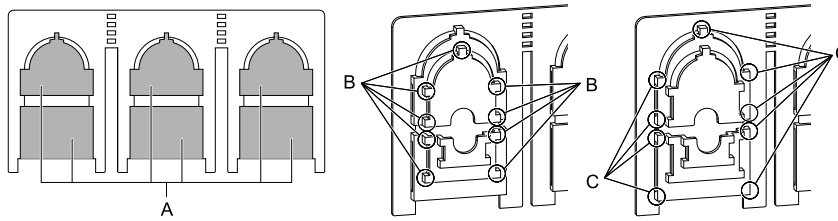

Figure 3.36 Tighten the Terminal Block Nuts

### 3.4 Main Circuit Terminal Block Wiring Procedure

6. Check the signal from the wired terminal and use a diagonal-cutting pliers to remove areas of the wiring cover cutaway section.  
Cut the correct areas shown in [Figure 3.37](#) for your wire gauges.



**A - Cutaway section**

**B - Use a diagonal-cutting pliers to clip this area for small wires.**

**C - Use a diagonal-cutting pliers to clip this area for large wires.**

**Figure 3.37 Clip the Cutaway Section of the Wiring Cover**

**Note:**

- Different drive models have different wiring covers.
- Remove only the areas of the wiring cover that apply to the wired terminals. If you remove areas that do not apply to the wired terminal, the drive will not keep its IP20 protective level.
- Make sure that you hold the cutaway section tightly when you remove pieces of the cutaway section. Pieces of the cutaway section can fly out and cause injury.
- Remove sharp edges from the wiring cover cutaway section to prevent damage to the wires.
- If you use the wiring cover correctly, but you use wires that are not specified by Yaskawa, the drive will not necessarily keep its IP20 protective level.
- When you use the recommended gauge for the electrical wires, it is not necessary to attach the wiring cover of the main circuit power input terminal and the drive output terminal. If you use the applicable gauge for the electrical wires, you must attach the wiring cover.

7. Attach the wiring cover and terminal block cover to their initial positions and tighten the screws on the terminal block cover.

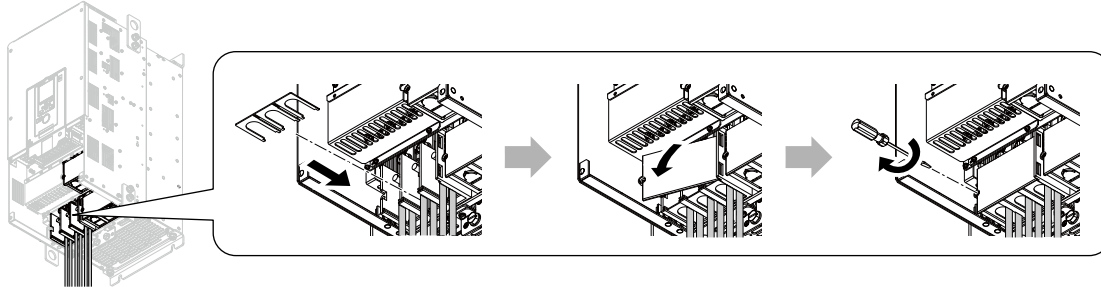

**Figure 3.38 Reattach the Wiring Cover**

8. Put the terminal cover back in its initial position.

## ◆ Wiring the Main Circuit Terminal Block Using Procedure E

### ■ Main Circuit Terminal Block Wiring Procedure

1. Remove the keypad and front cover.
2. Put the ends of prepared wires through the conduits and into the terminal block, then tighten the terminal screws to the specified torque.

**Note:**

When you use terminals - and +1 and these terminals have covers, remove them to install the wire.

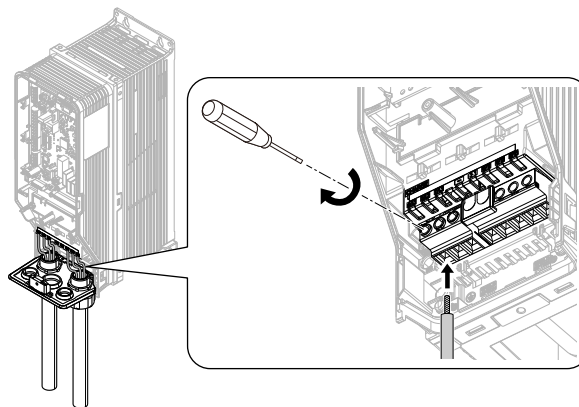
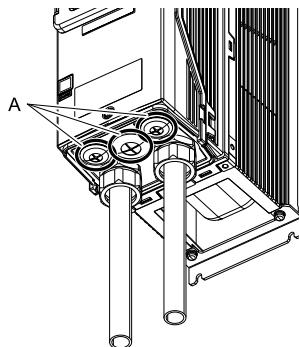

**Figure 3.39 Install the Electrical Wires**

3. Install the front cover and the keypad to their initial positions.

**Note:**

- For knock-out holes that you do not use for control circuit wiring, install the included rubber waterproofing grommets. For knock-out holes that you do use for control circuit wiring, install the correct conduit to keep the protection level.
- The knock-out holes for main circuit wiring do not have rubber grommets. Install the correct conduit to keep the IP55/UL Type 12 protection level.



A - Rubber grommets

## ◆ Wiring the Main Circuit Terminal Block Using Procedure F

### ■ Main Circuit Terminal Block Wiring Procedure

1. Remove the keypad and front cover.
2. Remove the terminal block bolt.

**Note:**

When you use terminals - and +1 and these terminals have covers, remove them to install the wire.

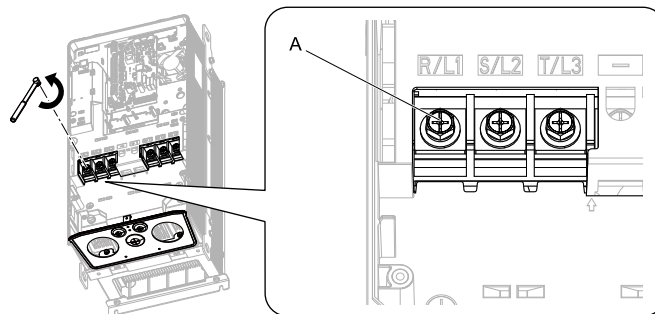

A - Bolt

**Figure 3.40 Remove the Terminal Block Bolts**

3. Put the ends of wires with closed-loop crimp terminals through the conduits.

- Align the closed-loop crimp terminals with the bolt holes on main circuit terminal block.

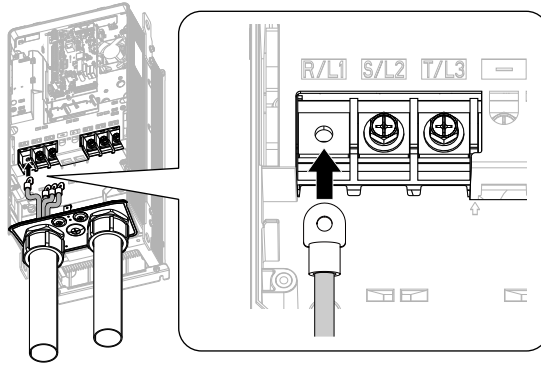

**Figure 3.41 Install the Electrical Wires**

- Tighten the bolts to the specified torque.

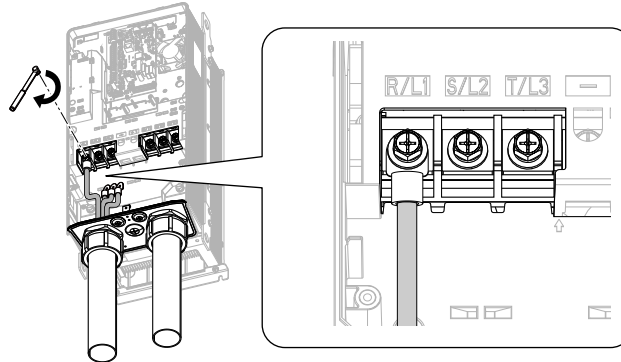
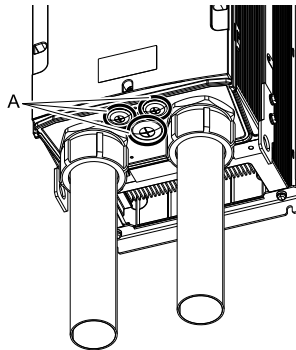

**Figure 3.42 Tighten the Terminal Block Bolts**

- Install the front cover and the keypad to their initial positions.

**Note:**

- For knock-out holes that you do not use for control circuit wiring, install the included rubber waterproofing grommets. For knock-out holes that you do use for control circuit wiring, install the correct conduit to keep the protection level.
- The knock-out holes for main circuit wiring do not have rubber grommets. Install the correct conduit to keep the IP55/UL Type 12 protection level.



A - Rubber grommets

## ◆ Wiring the Main Circuit Terminal Block Using Procedure G

### ■ Main Circuit Terminal Block Wiring Procedure

- Remove the keypad and front cover of the Main Switch.



- Put the ends of prepared wires through the knock-out holes on the conduit bracket and into the Main Switch terminal, then tighten the Main Switch terminal screws to the specified torque.

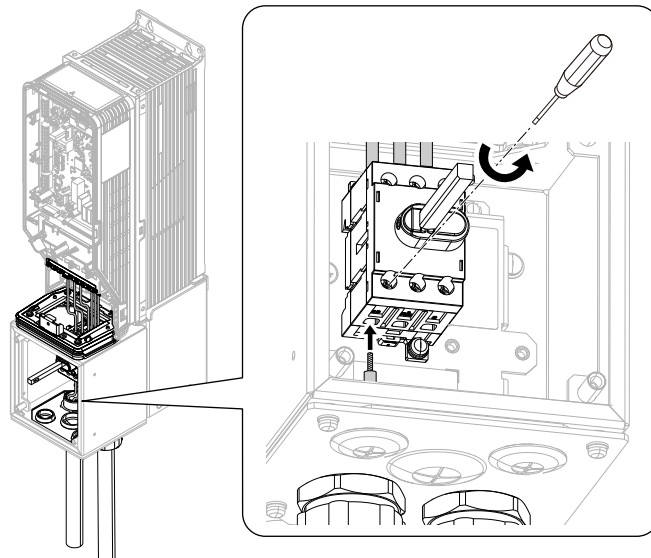
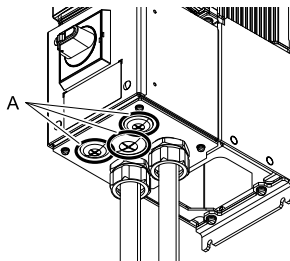

**Figure 3.43 Install the Electrical Wire**

- Install the front cover of the Main Switch and the keypad to their initial positions.

**Note:**

- For knock-out holes that you do not use for control circuit wiring, install the included rubber waterproofing grommets. For knock-out holes that you do use for control circuit wiring, install the correct conduit to keep the protection level.
- The knock-out holes for main circuit wiring do not have rubber grommets. Install the correct conduit to keep the IP55/UL Type 12 protection level.



**A - Rubber grommets**

## ◆ Wiring the Main Circuit Terminal Block Using Procedure H

### ■ Main Circuit Terminal Block Wiring Procedure

Prepare these recommended tools to remove and install the closed-loop crimp terminals:

- A deep socket wrench on the nut side
- A straight box wrench with these specifications on the bolt side
  - Size: 13 mm (0.51 in)
  - Length: Less than 180 mm (7.09 in)

- Remove the keypad and the Main Switch front cover.

### 3.4 Main Circuit Terminal Block Wiring Procedure

2. Hold the terminal block bolts with the box wrench and remove the terminal block nuts.

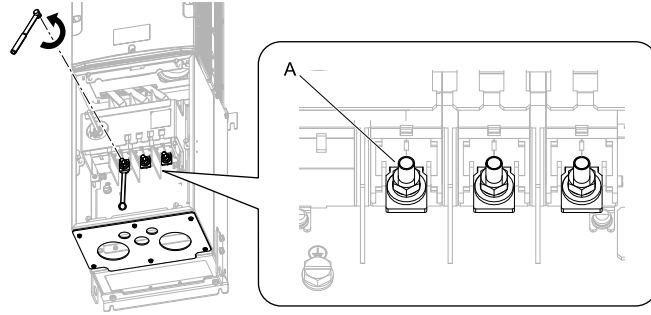

**A - Nut and bolt**

**Figure 3.44 Remove the Terminal Block Nuts**

**Note:**

The terminal block bolts are not easy to see. Make sure that you put the box wrench on the terminal block bolts correctly.

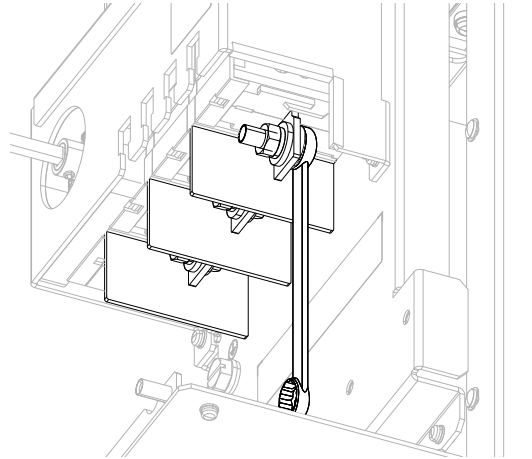

3. Put the ends of wires with closed-loop crimp terminals through the knock-out holes on the conduit bracket.
4. Put the terminal block bolts through the openings in the closed-loop crimp terminals.

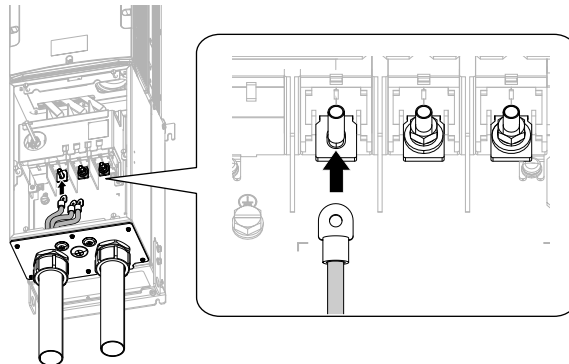

**Figure 3.45 Install the Electrical Wires**

5. Hold the terminal block bolts with the box wrench and tighten the terminal block nuts to a correct torque.

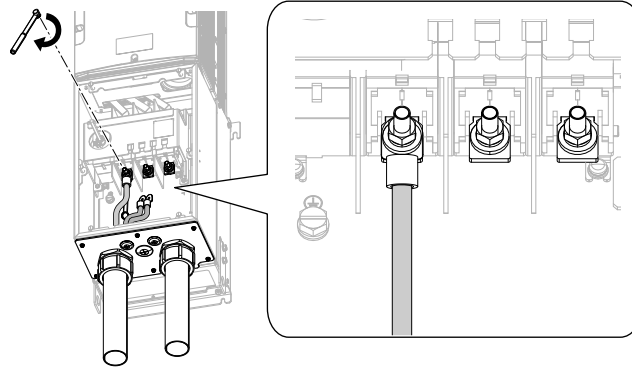
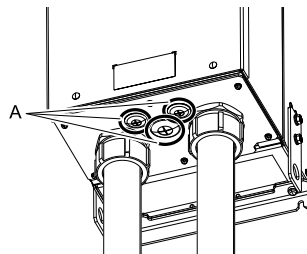

**Figure 3.46 Tighten the Main Switch Terminal Block Nuts**

6. Install the Main Switch front cover and the keypad to their initial positions.

**Note:**

- For knock-out holes that you do not use for control circuit wiring, install the included rubber waterproofing grommets. For knock-out holes that you do use for control circuit wiring, install the correct conduit to keep the protection level.
- The knock-out holes for main circuit wiring do not have rubber grommets. Install the correct conduit to keep the IP55/UL Type 12 protection level.



**A - Rubber grommets**

# 3.5 Control Circuit Wiring

This section gives information about how to correctly wire the control circuit.

## ◆ Control Circuit Connection Diagram

Wire the drive control circuit as shown in Figure 3.47.

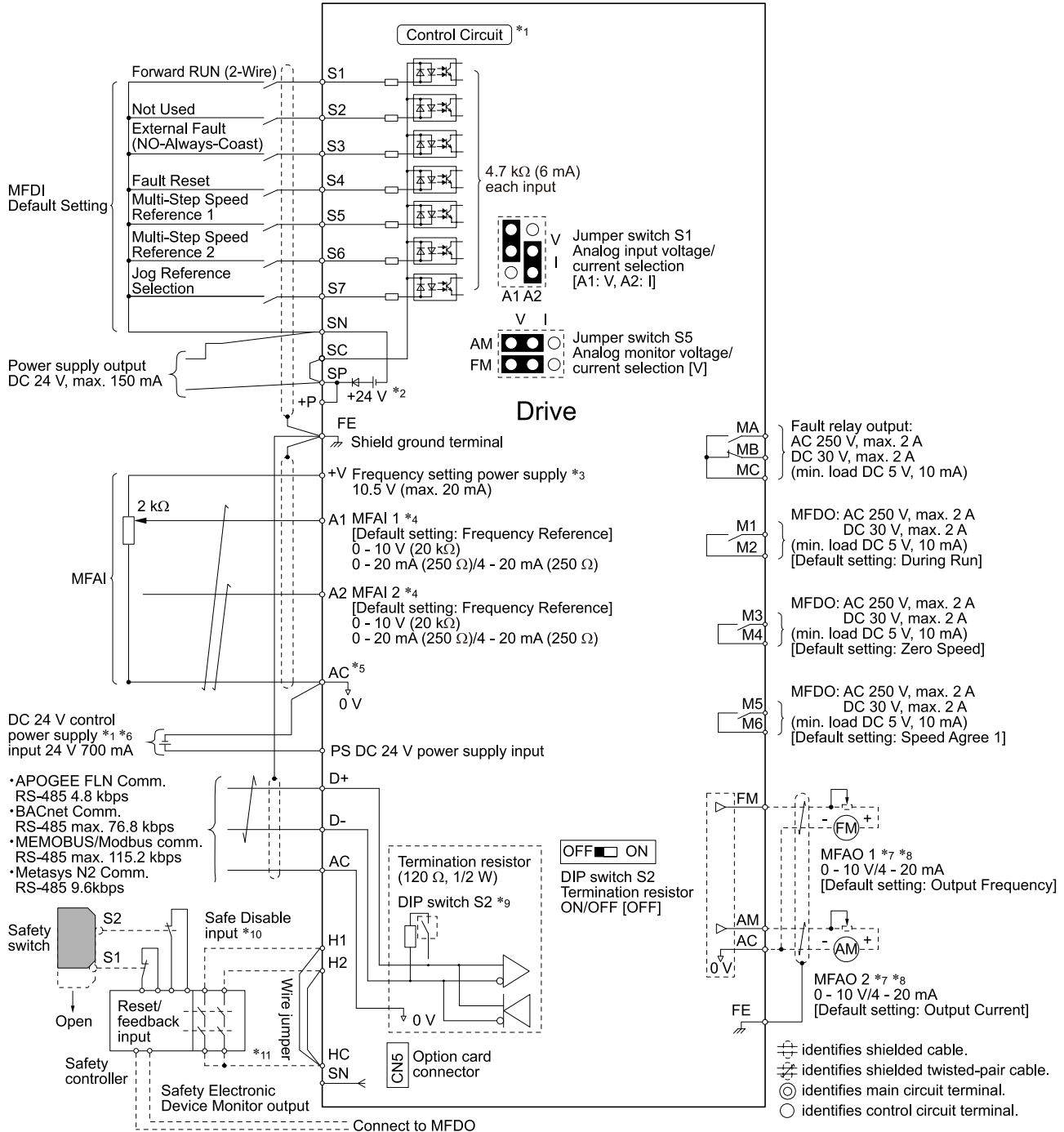

Figure 3.47 Control Circuit Connection Diagram

\*1 Connect a 24 V power supply to terminals PS-AC to operate the control circuit while the main circuit power supply is OFF.

- \*2 To set the MFDI power supply (Sinking/Sourcing Mode or internal/external power supply), install or remove a jumper between terminals SC-SP or SC-SN depending on the application.
- NOTICE: Damage to Equipment.** Do not close the circuit between terminals SP-SN. If you close the circuits between terminals SC-SP and terminals SC-SN at the same time, it will cause damage to the drive.
- Sinking Mode, Internal power supply: Install the jumper to close the circuit between terminals SC-SP.  
**NOTICE: Damage to Equipment.** Do not close the circuit between terminals SC-SN. If you close the circuits between terminals SC-SP and terminals SC-SN at the same time, it will cause damage to the drive.
  - Sourcing Mode, Internal power supply: Install the jumper to close the circuit between terminals SC-SN.  
**NOTICE: Damage to Equipment.** Do not close the circuit between terminals SC-SP. If you close the circuits between terminals SC-SP and terminals SC-SN at the same time, it will cause damage to the drive.
  - External power supply: Remove the jumper from the MFDI terminals. It is not necessary to close the circuit between terminals SC-SP and terminals SC-SN.
- \*3 The maximum output current capacity for terminal +V on the control circuit is 20 mA.  
**NOTICE: Damage to Equipment.** Do not install a jumper between terminals +V and AC. A closed circuit between these terminals will cause damage to the drive.
- \*4 Jumper S1 sets terminals A1 and A2 for voltage or current input signal. The default setting for S1 is voltage input (“V” side) for A1 and current input (“I” side) for A2.
- \*5 **NOTICE: Do not ground the AC control circuit terminals and only connect the AC terminals according to the product instructions. If you connect the AC terminals incorrectly, it can cause damage to the drive.**
- \*6 Connect the positive lead from an external 24 Vdc power supply to terminal PS and the negative lead to terminal AC.  
**NOTICE: Connect terminals PS and AC correctly for the 24 V power supply. If you connect the wires to the incorrect terminals, it will cause damage to the drive.**
- \*7 Use multi-function analog monitor outputs with analog frequency meters, ammeters, voltmeters, and wattmeters. Do not use monitor outputs with feedback-type signal devices.
- \*8 Jumper switch S5 sets terminal FM and AM for voltage or current output. The default setting for S5 is voltage output (“V” side).
- \*9 Set DIP switch S2 to “ON” to enable the termination resistor in the last drive in a MEMOBUS/Modbus network.
- \*10 Use only Sourcing Mode for Safe Disable input.
- \*11 Disconnect the jumpers between H1 and HC and H2 and HC to use the Safe Disable input.

## ◆ Control Circuit Terminal Block Functions

*Hx-xx parameters* set functions for the multi-function input and output terminals.

**WARNING! Sudden Movement Hazard.** Correctly wire and test all control circuits to make sure that the control circuits operate correctly. If you use a drive that has incorrect control circuit wiring or operation, it can cause death or serious injury.

**WARNING! Sudden Movement Hazard.** Check the I/O signals and the external sequences for the drive before you set the Application Preset function. When you set the Application Preset function (A1-06 ≠ 0), it changes the I/O terminal functions for the drive and it can cause equipment to operate unusually. This can cause serious injury or death.

**NOTICE: Damage to Equipment.** Do not energize and de-energize the drive more frequently than one time each 30 minutes. If you frequently energize and de-energize the drive, it can cause drive failure.

**NOTICE: Damage to Equipment.** Do not cycle the Main Switch more than 6000 times. If you cycle the Main Switch more times than the limit, it will cause the contact failure, or you cannot open or close the Main Switch.

**NOTICE: Damage to Equipment.** Make sure that you stop the motor before you turn ON/OFF the Main Switch. If you turn ON/OFF the Main Switch during run, it can cause Main Switch failure.

## ■ Input Terminals

Refer to [Table 3.9](#) for a list of input terminals and functions.

Table 3.9 Multi-function Input Terminals

Type	Terminal	Name (Default)	Function (Signal Level)
MFDI	S1	MFDI selection 1 (ON: Forward RUN (2-Wire) OFF: Stop)	Multi-Function Digital Input <ul style="list-style-type: none"> <li>• Photocoupler</li> <li>• 24 V, 6 mA</li> </ul> <b>Note:</b> Install the wire jumpers between terminals SC-SP and SC-SN to set the MFDI power supply (sinking/sourcing mode or internal/external power supply). <ul style="list-style-type: none"> <li>• Sinking Mode: Install a jumper between terminals SC and SP.</li> </ul> <b>NOTICE: Damage to Equipment. Do not close the circuit between terminals SC-SN. If you close the circuits between terminals SC-SP and terminals SC-SN at the same time, it will cause damage to the drive.</b> <ul style="list-style-type: none"> <li>• Sourcing Mode: Install a jumper between terminals SC and SN.</li> </ul> <b>NOTICE: Damage to Equipment. Do not close the circuit between terminals SC-SP. If you close the circuits between terminals SC-SP and terminals SC-SN at the same time, it will cause damage to the drive.</b> <ul style="list-style-type: none"> <li>• External power supply: No jumper necessary between terminals SC-SN and terminals SC-SP.</li> </ul>
	S2	MFDI selection 2 (Not Used)	
	S3	MFDI selection 3 (External Fault (NO-Always-Coast))	
	S4	MFDI selection 4 (Fault Reset)	
	S5	MFDI selection 5 (Multi-Step Speed Reference 1)	
	S6	MFDI selection 6 (Multi-Step Speed Reference 2)	
	S7	MFDI selection 7 (Jog Reference Selection)	
	SN	MFDI power supply 0 V	
	SC	MFDI selection common	
	SP	MFDI power supply +24 Vdc	
Safe Disable Input	H1	Safe Disable input 1	Safe Disable Input <p>Remove the jumper between terminals H1-HC and H2-HC to use the Safe Disable input.</p> <ul style="list-style-type: none"> <li>• 24 V, 6 mA</li> <li>• ON: Normal operation</li> <li>• OFF: Coasting motor</li> <li>• Internal impedance 4.7 kΩ</li> <li>• OFF Minimum OFF time of 2 ms.</li> </ul>
	H2	Safe Disable input 2	
	HC	Safe Disable function common	
Master Frequency Reference	+V	Power supply for frequency setting	Power Supply for Multi-Function Analog Input <ul style="list-style-type: none"> <li>• 10.5 V (allowable current 20 mA maximum)</li> </ul>
	A1	MFAI1 (Frequency Reference)	Voltage input or current input <p>Select terminal A1 with Jumper switch S1 and H3-01 [Terminal A1 Signal Level Select].</p> <ul style="list-style-type: none"> <li>• 0 V to 10 V/100% (input impedance: 20 kΩ)</li> <li>• 4 mA to 20 mA/100%, 0 mA to 20 mA/100% (input impedance: 250 Ω)</li> </ul>
	A2	MFAI2 (Combined to terminal A1)	Voltage input or current input <p>Select terminal A2 with Jumper switch S1 and H3-09 [Terminal A2 Signal Level Select]</p> <ul style="list-style-type: none"> <li>• 0 V to 10 V/100% (input impedance: 20 kΩ)</li> <li>• 4 mA to 20 mA/100%, 0 mA to 20 mA/100% (input impedance: 250 Ω)</li> </ul>
	AC	Frequency reference common	Signal Ground for Multi-Function Analog Input <ul style="list-style-type: none"> <li>• 0 V</li> </ul>
	FE	Connecting shielded cable	Frame Earth

## ■ Output Terminals

Refer to [Table 3.10](#) and [Table 3.11](#) for a list of output terminals and functions.

Table 3.10 Control Circuit Output Terminals

Type	Terminal	Name (Default)	Function (Signal Level)
Fault Relay Output	MA	N.O. output (Fault)	Drive Fault Signal Output <ul style="list-style-type: none"> <li>Relay output</li> <li>30 Vdc, 10 mA to 2 A</li> <li>250 Vac, 10 mA to 2 A</li> <li>Minimum load: 5 V, 10 mA (Reference value)</li> </ul>
	MB	N.C. output (Fault)	
	MC	Digital output common	
MFDO	M1	MFDO (During Run)	Multi Function Digital Output <ul style="list-style-type: none"> <li>Relay output</li> <li>30 Vdc, 10 mA to 2 A</li> <li>250 Vac, 10 mA to 2 A</li> <li>Minimum load: 5 V, 10 mA (Reference value)</li> </ul> <b>Note:</b> Do not set functions that frequently switch ON/OFF to MFDO (M1 to M6) because this will decrease the performance life of the relay contacts. Yaskawa estimates switching life at 200,000 times (assumes 1 A, resistive load).
	M2		
	M3	MFDO (Zero Speed)	
	M4		
	M5	MFDO (Speed Agree 1)	
	M6		

Table 3.11 Control Circuit Monitor Output Terminals

Type	Terminal	Name (Default)	Function (Signal Level)
Monitor Output	FM	MFAO 1 (Output frequency)	Multi Function Analog Output Select voltage or current output. <ul style="list-style-type: none"> <li>0 V to 10 V/0% to 100%</li> <li>4 mA to 20 mA (receiver recommended impedance: 250 Ω)</li> </ul> <b>Note:</b> Select with jumper switch S5 and H4-07 [Terminal FM Signal Level Select] or H4-08 [Terminal AM Signal Level Select].
	AM	MFAO 2 (Output current)	
	AC	Monitor common	
External Power Supply Output	+P	External power supply	Power supply for external devices. <ul style="list-style-type: none"> <li>24 V (150 mA maximum)</li> </ul>

## External Power Supply Input Terminals

Refer to Table 3.12 for a list of the functions of the external power supply input terminals.

Table 3.12 External Power Supply Input Terminals

Type	Terminal	Name (Default)	Function
External Power Supply Input Terminals	PS	External 24 V power supply input	Supplies backup power to the drive control circuit, keypad, and option board. 21.6 VDC to 26.4 VDC, 700 mA
	AC	External 24 V power supply ground	0 V

### Alarm Display When You Use External 24 V Power Supply

When you use an external 24 V power supply, the drive detects an alarm as shown in Table 3.13 if you set o2-23 [External 24V Powerloss Detection] and o2-26 [Alarm Display at Ext. 24V Power] for the main circuit power supply. Set the alarm display as necessary.

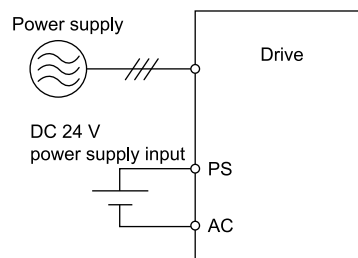

**Table 3.13 Power Supply and Alarm Display**

Main Circuit Power Supply	External 24 V Power Supply	o2-23 [External 24V Powerloss Detection]	o2-26 [Alarm Display at Ext. 24V Power]	Alarm Display
ON	ON	-	-	-
ON	OFF	0 [Disabled]	-	-
		1 [Enabled]	-	L24v [Loss of External Power 24 Supply]
OFF	ON	-	0 [Disabled]	"Ready" LED light flashes quickly
		-	1 [Enabled]	EP24v [External Power 24V Supply]

**Operation When Using External 24 V Power Supply**

To operate the drive, de-energize the main circuit power supply and connect an external 24 V power supply to terminals PS-AC.

Function	Operation	Solution
Keypad	The keypad operates the same as when the main circuit power supply is ON. The drive will not detect oPr [Keypad Connection Fault].	-
Data Log	The data log function operates the same as when the main circuit power supply is ON. *1	-
Communications by Communication Option or MEMOBUS/Modbus Communication Terminals	Communication operates the same as when the main circuit power supply is ON.	-
MFAI	MFAI operates the same as when the main circuit power supply is ON.	-
MFAO	MFAO operates the same as when the main circuit power supply is ON.	-
MFDI	MFDI does not operate when the main circuit power supply of the drive is OFF.	Connect the external 24 V power supply to the MFDI selection common terminal (SC). *2
MFDO Multi-Function Photocoupler Output Fault Relay Output Terminal	MFDO operates the same as when the main circuit power supply is ON. The operations of MFDO terminals and fault relay output terminals set for H2-xx = E [Fault] are different for different drive software versions.	-

\*1 When you use an external 24 V power supply, the operation of the data log function is different for different drive software versions. On drives with software versions PRG: 01014 and later, you can continue the data log function.

**Note:**

The "PRG" column on the nameplate on the right side of the drive identifies the software version. You can also use U1-25 [SoftwareNumber FLASH] to identify the software version.

\*2 When you use MFDI, wire the terminals as shown in [Wiring MFDI Terminals on page 106](#).

**Note:**

Yaskawa recommends that you use different external power supplies for the external power supply input terminals (PS-AC) and MFDI selection common terminal (SC)/Input signal common terminal (SC).

**Wiring MFDI Terminals**

If you de-energize the main circuit power supply, the MFDI terminals will not operate, even when you connect the external 24 V power supply to terminals PS-AC. When you set N.O. functions to H1-xx [MFDI Function Selection], MFDI terminals always deactivate. When you set N.C. functions, MFDI terminals always activate. Connect the external 24 V power supply to the MFDI selection common terminal (SC).



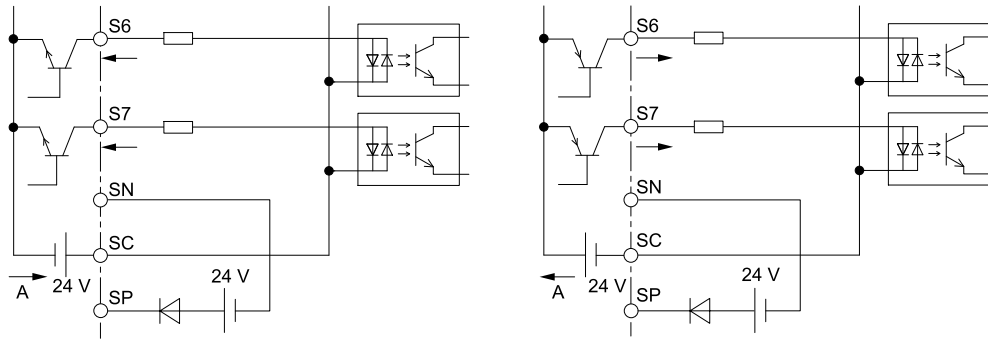

A - External power supply

Figure 3.48 Wiring MFDI Terminals

### Serial Communication Terminals

Refer to [Table 3.14](#) for a list of serial communication terminals and functions.

Table 3.14 Serial Communication Terminals

Type	Terminal	Terminal Name	Function (Signal Level)	
Serial Communication	D+	Communication input/output (+)	<ul style="list-style-type: none"> <li>APOGEE FLN communications</li> <li>BACnet communications</li> <li>MEMOBUS/ Modbus communications</li> <li>Metasys N2 communications</li> </ul> Use an RS-485 cable to connect the drive. <b>Note:</b> Set DIP switch S2 to ON to enable the termination resistor in the last drive in an APOGEE FLN, BACnet, MEMOBUS/ Modbus, or Metasys N2 network.	<ul style="list-style-type: none"> <li>RS-485</li> <li>APOGEE FLN communications: 4.8 kbps</li> <li>BACnet communications: Maximum 76.8 kbps</li> <li>MEMOBUS/Modbus communications: Maximum 115.2 kbps</li> <li>Metasys N2 communications: 9.6 kbps</li> </ul>
	D-	Communication output (-)		
	AC	Signal ground	0 V	
	FE	Option card ground		-

### Control Circuit Terminal Configuration

The control circuit terminals are in the positions shown in [Figure 3.49](#).

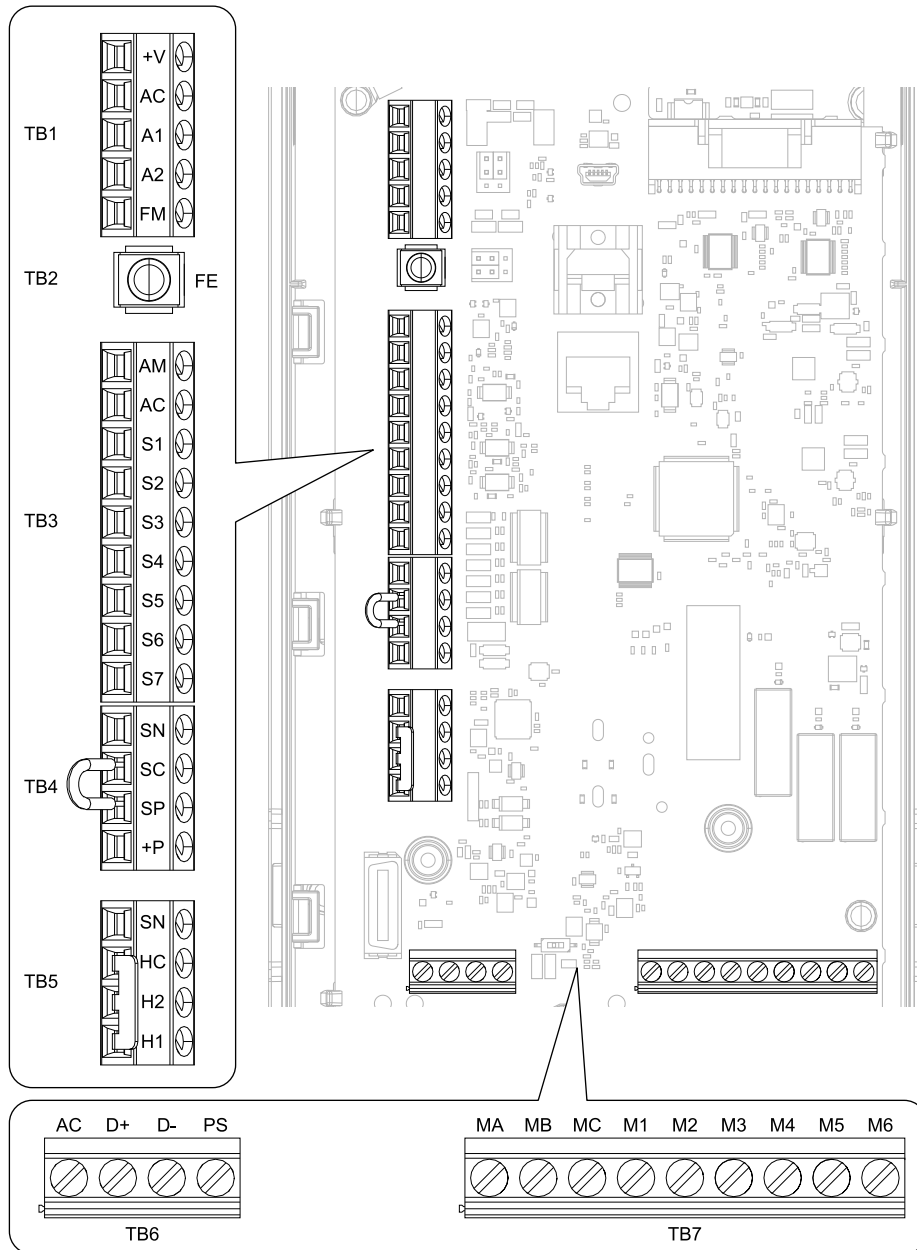

**Figure 3.49 Control Circuit Terminal Arrangement**

The tightening torque for the terminal screws is shown on the reverse side or the lower front side of the front cover.

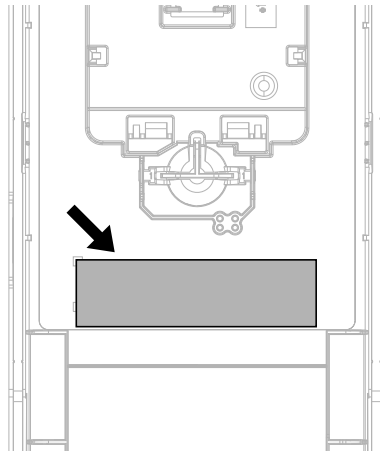

Figure 3.50 Tightening Torque Display Location (Reverse Side of Front Cover)

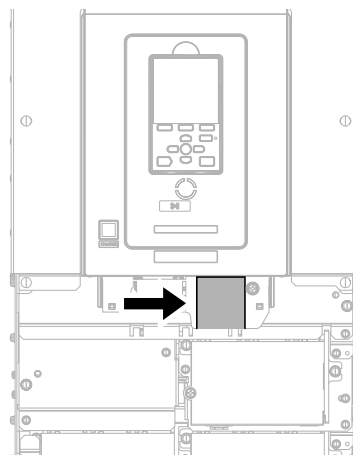

Figure 3.51 Tightening Torque Display Location (Lower Front Side of Front Cover)

■ Control Circuit Wire Gauges and Tightening Torques

Use the tables in this section to select the correct wires. Use shielded wire to wire the control circuit terminal block. Use crimp ferrules on the wire ends to make the wiring procedure easier and more reliable.

Table 3.15 Control Circuit Wire Gauges and Tightening Torques

Terminal Block	Terminal	Screw Size	Tightening Torque N·m (lbf·in)	Bare Wire		Crimp Ferrule	
				Recommended Gauge mm <sup>2</sup> (AWG)	Applicable Gauge mm <sup>2</sup> (AWG)	Recommended Gauge mm <sup>2</sup> (AWG)	Applicable Gauge mm <sup>2</sup> (AWG)
TB1	+V, AC, A1, A2, FM	M3	0.5 - 0.6 (4.4 - 5.3)	0.75 (18)	Stranded wire: 0.25 - 1.5 (24 - 16) Solid wire: 0.25 - 1.5 (24 - 16)	0.75 (18)	0.25 - 1.5 (24 - 16)
TB3	AM, AC, S1 - S7						
TB4	SN, SC, SP, +P						
TB5	SN, HC, H1, H2						
TB6	AC, D+, D-, PS						
TB7	MA, MB, MC, M1 - M6						
TB2	FE		1.0 - 1.2 (8.85 - 10.62)	0.75 (18)	Stranded wire: 0.12 - 0.75 (26 - 18) Solid wire: 0.2 - 1.5 (26 - 16)	0.75 (18)	0.25 - 1.5 (24 - 16)

#### Crimp Ferrules

Attach an insulated sleeve when you use crimp ferrules. Refer to [Table 3.16](#) for the recommended external dimensions and model numbers of the crimp ferrules.

Use the CRIMPFOX 6, a crimping tool made by PHOENIX CONTACT.

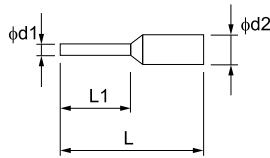

Figure 3.52 External Dimensions of Crimp Ferrules

Table 3.16 Crimp Ferrule Models and Sizes

Wire Gauge mm <sup>2</sup> (AWG)	Model	L (mm)	L1 (mm)	φd1 (mm)	φd2 (mm)
0.25 (24)	AI 0.25-8YE	12.5	8	0.8	2.0
0.34 (22)	AI 0.34-8TQ	12.5	8	0.8	2.0
0.5 (20)	AI 0.5-8WH AI 0.5-8OG	14	8	1.1	2.5
0.75 (18)	AI 0.75-8 GY	14	8	1.3	2.8

#### ◆ Wiring the Control Circuit Terminal

**WARNING! Electrical Shock Hazard.** Do not remove covers or touch circuit boards while the drive is energized. If you touch the internal components of an energized drive, it can cause serious injury or death.

**NOTICE:** Do not let wire shields touch other signal lines or equipment. Insulate the wire shields with electrical tape or shrink tubing. If you do not insulate the wire shields, it can cause a short circuit and damage the drive.

**Note:**

- Isolate control circuit wiring from main circuit wiring (terminals R/L1, S/L2, T/L3, U/T1, V/T2, W/T3, -, +1) and other high-power wiring. If the control circuit wires are adjacent to the main circuit wires, electrical interference can cause the drive or the devices around the drive to malfunction.
- Isolate contact output terminals MA, MB, MC and M1-M6 from other control circuit wiring. If the output terminal wires are adjacent to other control circuit wires, electrical interference can cause the drive or devices around the drive to malfunction.
- Use a UL Listed Class 2 Power Supply to connect external power to the control terminals. If the power supply for peripheral devices is incorrect, it can cause a decrease in drive performance.
- Connect the shield of shielded cable to the applicable ground terminal. If the grounding is not correct, electrical interference can cause the drive or devices around the drive to malfunction.

Correctly ground the drive terminals and complete main circuit wiring before you wire the control circuit. Remove the keypad and front cover.

1. Refer to [Figure 3.53](#) and wire the control circuit.

**WARNING! Fire Hazard.** Tighten all terminal screws to the correct tightening torque. Connections that are too loose or too tight can cause incorrect operation and damage to the drive. Incorrect connections can also cause death or serious injury from fire.

**Note:**

- Use shielded wires and shielded twisted-pair wires for the control circuit terminal wiring. If the grounding is not correct, electrical interference can cause the drive or devices around it to malfunction.
- Do not use control circuit wiring that is longer than 50 m (164 ft) to supply the frequency reference with an analog signal from a remote source. Wiring that is too long can cause unsatisfactory system performance.

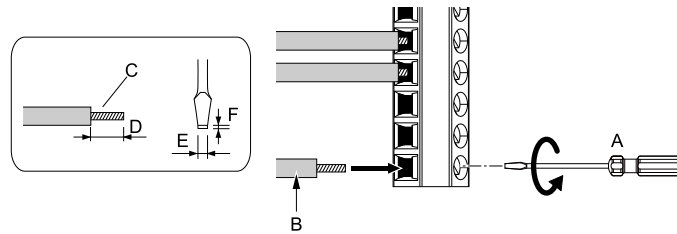

- A** - Loosen the screws and put the wire into the opening on the terminal block.
- B** - Wire with a crimp ferrule attached, or use wire that is not soldered with the core wires lightly twisted.
- C** - Pull back the shielding and lightly twist the end with your fingers to keep the ends from fraying.
- D** - If you do not use crimp ferrules, remove approximately 5.5 mm (0.21 in) of the covering at the end of the wire.
- E** - Blade width of 2.5 mm (0.1 in) or less
- F** - Blade depth of 0.4 mm (0.01 in) or less

**Figure 3.53** Wiring Procedure for the Control Circuit

**WARNING!** Fire Hazard. Tighten all terminal screws to the correct tightening torque. Connections that are too loose or too tight can cause incorrect operation and damage to the drive. Incorrect connections can also cause death or serious injury from fire.

**NOTICE:** Do not solder the core wire. Soldered wire connections can become loose over time and cause unsatisfactory drive performance.

**Note:**

- Refer to [Figure 3.54](#) for information to prepare terminal ends of the shielded wire.
- Prepare the wire ends of shielded twisted-pair wires as shown in [Figure 3.54](#) to use an analog reference from an external frequency setting potentiometer to set the frequency. Connect the shield to terminal FE of the drive.

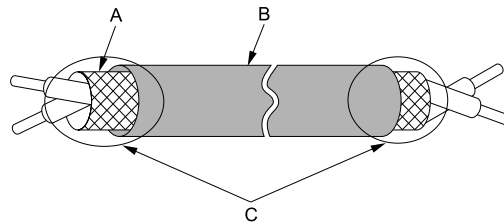

- A** - Connect the shield to terminal FE of the drive.
- B** - Sheath
- C** - Insulate with electrical tape or shrink tubing.

**Figure 3.54** Prepare the Ends of Shielded Wire

**Note:**

If you use multi-conductor shielded cable that is too thick to put through the hook on the drive, you can remove the cable sheath.

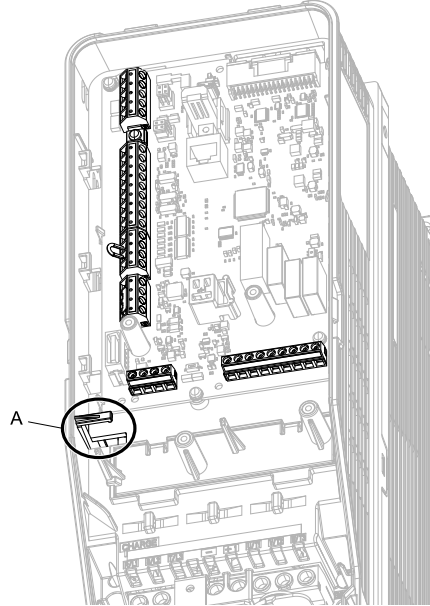

**A - Hook**

2. Put the cables through the clearance of the drive and knock-out holes.

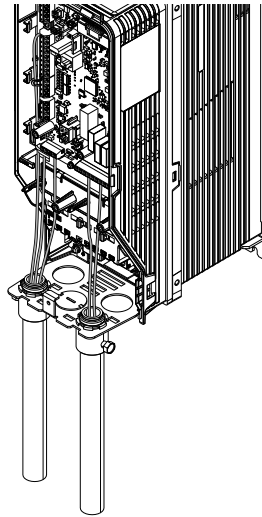

**Figure 3.55 Control Circuit Wiring**

3. Install the front cover and the keypad to their initial positions.

---

### ◆ Switches and Jumpers on the Terminal Board

The terminal board has switches to adapt the drive I/Os to the external control signals as shown in [Figure 3.56](#). Set the switches to select the functions for each terminal.

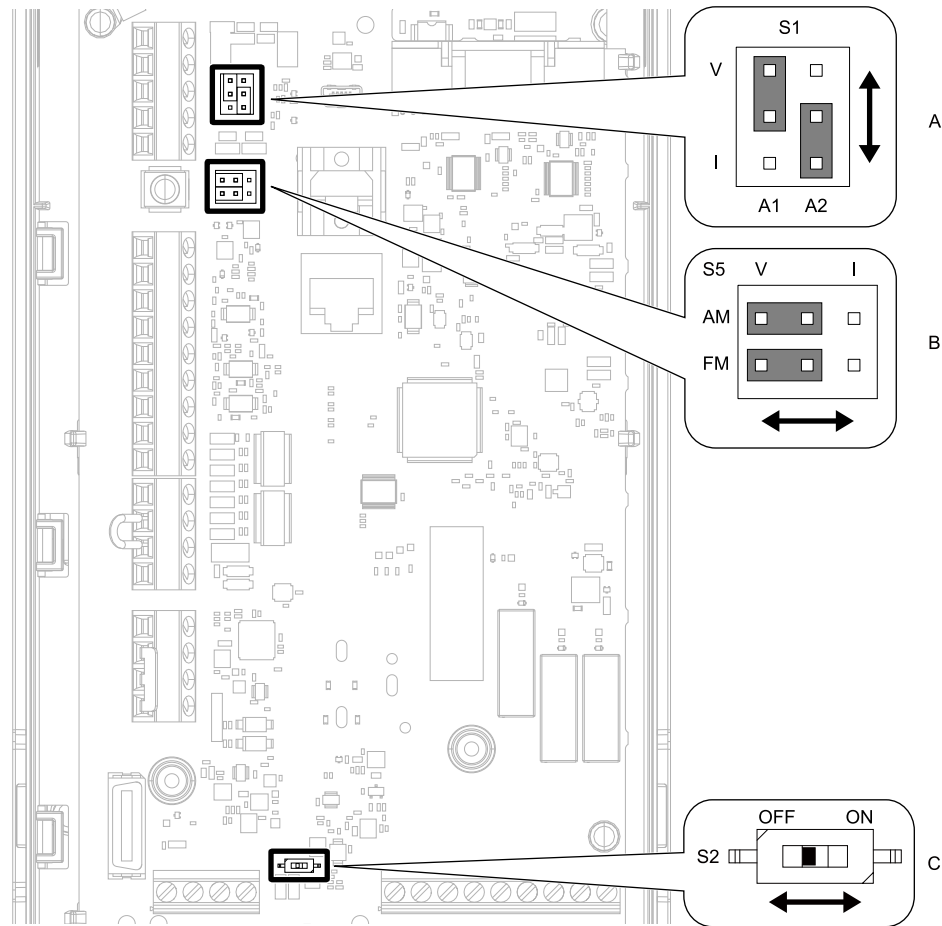

Figure 3.56 Locations of Switches

Table 3.17 I/O Terminals and Switches Functions

Position	Switch	Terminal	Function	Default Setting
A	Jumper switch S1	A1, A2	Sets terminals A1 and A2 to voltage or current output.	A1: V (voltage input) A2: I (current input)
B	Jumper switch S5	FM, AM	Sets terminals FM and AM to voltage or current output.	FM: V (voltage output) AM: V (voltage output)
C	DIP switch S2	-	Enables and disables the termination resistor of these communications: <ul style="list-style-type: none"> <li>• APOGEE FLN</li> <li>• BACnet</li> <li>• MEMOBUS/Modbus</li> <li>• Metasys N2</li> </ul>	OFF

## 3.6 Control I/O Connections

This section gives information about the settings for the listed control circuit I/O signals.

- MFDI (terminals S1 to S7)
- MFDO (terminals M1 to M6)
- MFAI (terminals A1, A2)
- MFAO (terminals FM, AM)
- RS-485 communications (terminals D+, D-, AC)

### ◆ Set Sinking Mode/Sourcing Mode

Close the circuit between terminals SC-SP and SC-SN to set the sinking mode/sourcing mode and the internal/external power supply for the MFDI terminals. The default setting for the drive is internal power supply sinking mode.

**NOTICE:** *Damage to Equipment.* Do not close the circuit between terminals SP-SN. If you close the circuits between terminals SC-SP and terminals SC-SN at the same time, it will cause damage to the drive.

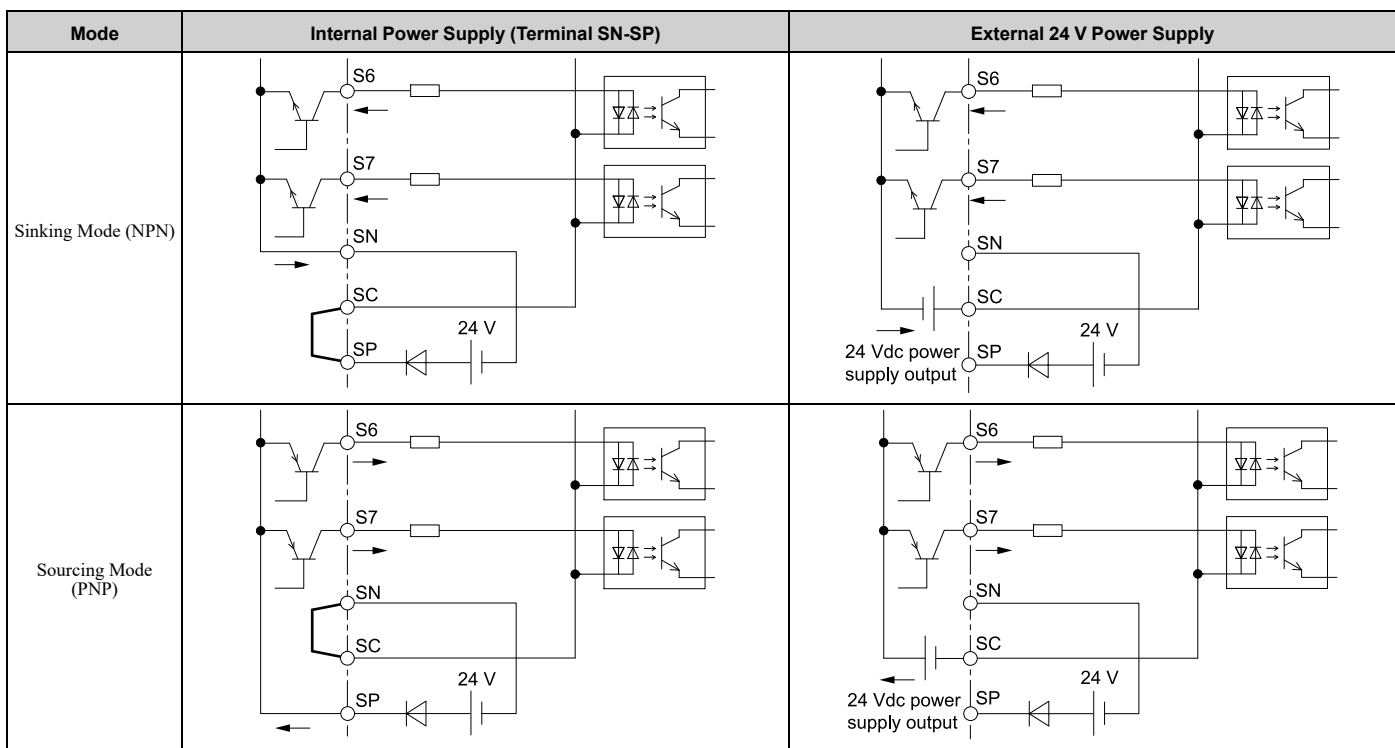

### ◆ Set Input Signals for MFAI Terminals A1 and A2

Use terminals A1 and A2 to input a voltage or a current signal. Set the signal type as shown in [Table 3.18](#).

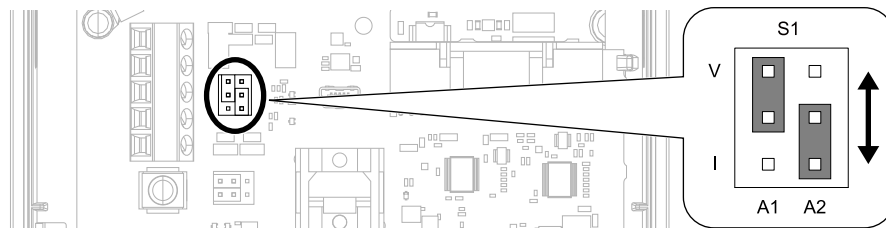
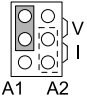

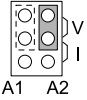
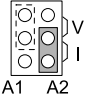

Figure 3.57 Location of Jumper Switch S1



Table 3.18 MFAI Terminals A1 and A2 Signal Settings

Terminal	Types of Input Signals	Jumper Switch S1	Parameter	
			No.	Signal Level
A1	Voltage input (Default)		H3-01	0: 0 V to 10 V/0% to 100% (input impedance: 20 kΩ)
	Current input			2: 4 mA to 20 mA/0% to 100% (input impedance: 250 Ω) 3: 0 mA to 20 mA/0% to 100% (input impedance: 250 Ω)
A2	Voltage input		H3-09	0: 0 V to 10 V/0% to 100% (input impedance: 20 kΩ)
	Current input (Default)			2: 4 mA to 20 mA/0% to 100% (input impedance: 250 Ω) 3: 0 mA to 20 mA/0% to 100% (input impedance: 250 Ω)

**Note:**

Set H3-02, H3-10 = 0 [Terminal A1 Function Selection, Terminal A2 Function Selection = Frequency Reference] to set A1 and A2 to frequency reference. The drive will add the analog input values together to make the frequency reference.

### ◆ Set Output Signals for MFAO Terminals FM, AM

Set the signal type for terminals AM and FM to voltage or current output. Use jumper switch S5 and H4-07, H4-08 [Terminal FM Signal Level Select, Terminal AM Signal Level Select] to set the signal type.

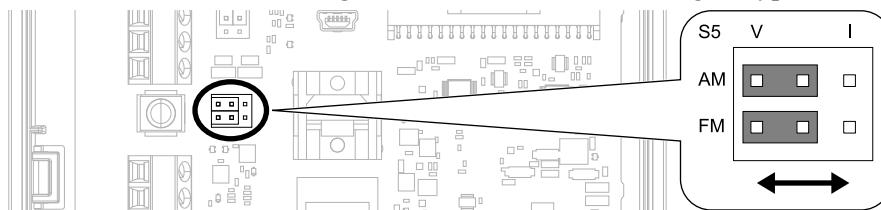
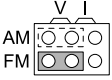
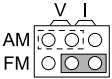
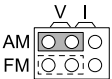
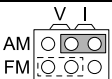

Figure 3.58 Location of Jumper Switch S5

Terminal	Types of Output Signals	Jumper Switch S5	Parameter	
			No.	Signal Level
FM	Voltage output (Default)		H4-07	0: 0 V to 10 V
	Current output			2: 4 mA to 20 mA
AM	Voltage output (Default)		H4-08	0: 0 V to 10 V
	Current output			2: 4 mA to 20 mA

### ◆ Switch ON Termination Resistor for RS-485 Communications

When the drive is the last slave in these communications, set DIP switch S2 to the ON position:

- APOGEE FLN
- BACnet
- MEMOBUS/Modbus
- Metasys N2

This drive has a built-in termination resistor for the RS-485 interface.

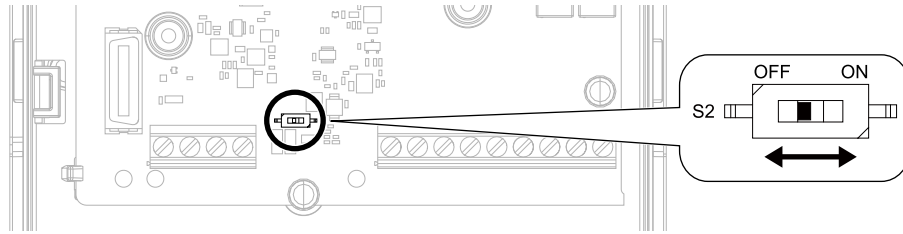

**Figure 3.59 Location of DIP Switch S2**

**Table 3.19 RS-485 Communications Termination Resistor Setting**

DIP Switch S2	Description
ON	The built-in termination resistor is ON.
OFF (Default)	The built-in termination resistor is OFF.

## 3.7 Connect the Drive to a PC

The drive has a mini-B type USB port.

You can use a USB cable (USB 2.0, type: A - mini-B) to connect the drive to a type-A USB port on a PC. Remove the keypad to connect the USB cable to the port on the drive. After you connect the drive to the PC, you can use Yaskawa DriveWizard HVAC software to monitor drive performance and manage parameter settings.

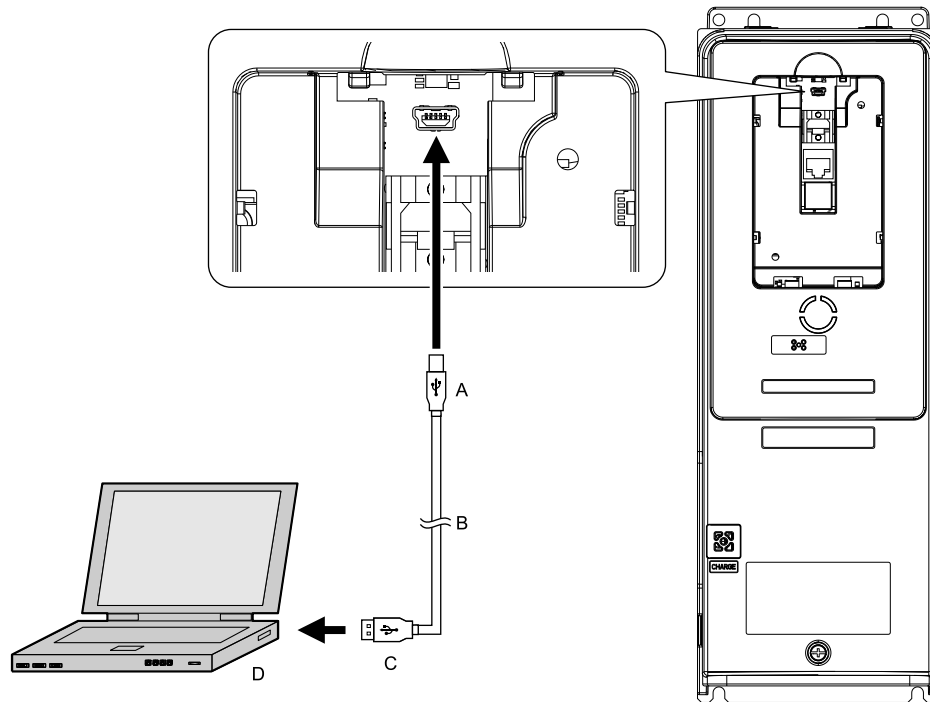

A - Mini-B type connector  
B - USB 2.0, type A - mini-B cable

C - Type-A connector  
D - PC

**Figure 3.60 Connect to a PC (USB)**

Yaskawa recommends that you use a USB cable with connectors connected with shielded wires.

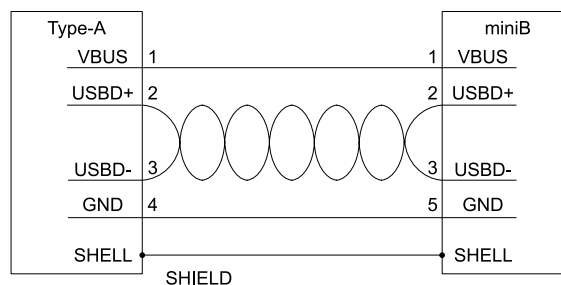

**Figure 3.61 Recommended USB Cable**

### 3.8 External Interlock

For applications that will have unwanted effects on the system if the drive stops, make an interlock between fault relay output (MA, MB, MC) and the MFDO Drive Ready signal.

---

#### ◆ Drive Ready

When the drive is operating or is prepared to accept a Run command, the MFDO terminal to which *Drive Ready* [H2-xx = 6] is set will enter the ON status.

In these conditions, Drive Ready is OFF and the drive ignores Run commands:

- The drive is de-energized
- During a fault
- There is problem with the control power supply
- There is a parameter setting error that will not let the drive run, although a Run command is entered
- An overvoltage or undervoltage fault occurs when the Run command is entered
- The drive is in Programming Mode.

## 3.9 Drive Wiring Protection

### ◆ Installing a Ground Fault Circuit Interrupter (GFCI)

When the drive output switches at high speeds, it causes high frequency leakage current. To prevent electrical shock and fires caused by ground fault protection that is not sufficient, install a GFCI.

Use a high frequency GFCI at the power input side of the drive and make sure that each drive has a minimum cumulative sensitivity amperage of 30 mA. The specialized breaker detects only the leakage current from frequency bands that are dangerous to humans.

If a device does not have protection against high frequencies, high frequency leakage currents can cause the device to malfunction. If you have a malfunction on a device that is not protected, decrease the carrier frequency of the drive, switch to a better breaker, or use a GFCI with a minimum cumulative sensitivity amperage of 200 mA for each drive.

These conditions can have an effect on leakage current:

- Drive capacity
- Carrier frequency
- Wiring distance and types of motor cables
- EMI/RFI filter

To prevent damage and injury to personnel and drives, use a high-frequency GFCI that is rated for AC and DC power supplies.

**Note:**

Yaskawa recommends these GFCIs, which are designed to operate with high frequencies:

- Mitsubishi Electric Corporation, NV series
- Schneider Electric, NS series

You can use a molded-case circuit breaker (MCCB) as a replacement for a GFCI that is upstream in the power supply system.

### ◆ Installing a Molded-Case Circuit Breaker (MCCB) or Ground Fault Circuit Interrupter (GFCI)

Install a molded-case circuit breaker (MCCB) or a ground fault circuit interrupter (GFCI) for line protection between the power supply and main circuit power supply input terminals R/L1, S/L2, and T/L3. The MCCB or GFCI gives overload protection and also prevents damage to the main circuit and the devices that are wired to the main circuit.

Use the information in this section to select the correct MCCB or GFCI and to safely connect the device.

- The capacity of the MCCB or GFCI must be 1.5 to 2 times the rated output current of the drive. Use an MCCB or GFCI as an alternative to overheat protection (150% for one minute at the rated output current) to prevent drive faults.
- When you connect more than one drive or the drive and other device to an MCCB or GFCI, refer to [Figure 3.62](#), use a magnetic contactor (MC), and set a sequence that de-energizes the drive when it outputs errors.

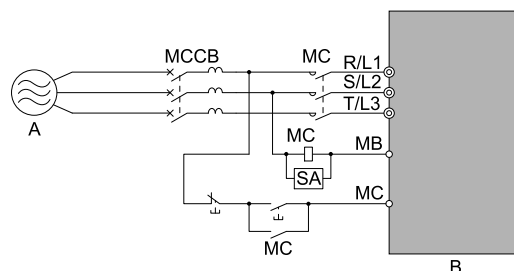

A - Power Supply

B - Drive

Figure 3.62 Connect an MCCB

**WARNING!** *Electrical Shock Hazard. Use an MCCB, GFCI, or Magnetic Contactor (MC) to de-energize the drive before you wire the main circuit terminal. If the main circuit terminal is energized during wiring, it will cause serious injury or death.*

## 3.10 Motor Protection

### ◆ Installing a Magnetic Contactor (MC) at the Input Side of the Drive

You can use an MC as an alternative to a molded case circuit breaker (MCCB) when:

- A condition triggered the protective functions of the drive
- An emergency stop occurred and the sequence de-energized the drive.

If an MC on the input side of the drive (primary side) stops the drive, regenerative braking will not operate, and the drive will coast to stop.

**NOTICE:** *When you connect electromagnetic switches or magnetic contactors to the output motor circuits, make sure that you sequence them correctly. If the output motor circuit sequence is incorrect, it can cause damage to the drive.*

**NOTICE:** *Damage to Equipment. Do not energize and de-energize the drive more frequently than one time each 30 minutes. If you frequently energize and de-energize the drive, it can cause drive failure.*

**Note:**

- When machinery must not restart after recovery from a momentary power loss that occurred during run, install an MC at the input side of the drive and set a sequence that does not automatically set the Run command to ON after recovery of power.
- When it is necessary to stop momentary power loss, for example to maintain a circuit that has momentary power loss, use a delayed-release MC.
- Use an MC to make sure that you can fully remove power to the drive when necessary. Wire the MC to open when a fault output terminal is triggered.

### ◆ Installing a Thermal Overload Relay on the Drive Output

A thermal overload relay disconnects the power line to the motor during a motor overload condition to prevent damage to the motor.

Install a thermal overload relay between the drive and motor in these conditions:

- When you operate more than one motor with one drive
- When you operate the motor directly from the power line with a power line bypass

When you operate one motor with one drive, it is not necessary to install a thermal overload relay. The drive has electronic motor overload protection in the drive software.

**Note:**

- When you install a thermal overload relay, set parameter  $L1-01 = 0$  [*Motor Overload (oL1) Protection = Disabled*].
- Set up a sequence that will trip an external fault (coast to stop) for the contacts of the thermal overload relay.

### ■ General Precautions When Using Thermal Overload Relays

When you use a motor thermal overload relay on the drive output to prevent nuisance trips and overheating of the motor at low speeds, be sure to think about these application precautions:

- Operation of a low speed motor
- When you operate more than one motor with one drive
- Length of the motor cables
- Nuisance tripping because of high drive carrier frequency

#### Operation of a Low Speed Motor

Usually, you use thermal overload relays on general-purpose motors (standard motors). When a drive drives a general-purpose motor, the motor current is approximately 5% to 10% more than with a commercial power supply. When a motor with a shaft-driven fan operates at low speeds, the cooling capacity decreases. This can cause the motor to overheat when the load current is in the motor rated value. Enable the electronic thermal protection in the drive when possible to prevent this problem.

The electronic thermal overload function uses the relation between the speed and heat characteristics in the variable speed control range to simulate the cooling ability of general-purpose motors and forced-vented motors to prevent damage to the motor.

### When You Operate More than One Motor with One Drive

To disable the overload protection function of the electronic thermal protector of the drive, set  $LI-01 = 0$  [*Motor Overload (oLI) Protection = Disabled*].

**Note:**

If you operate more than one motor from one drive, you cannot use the electronic thermal protection of the drive.

### Length of the Motor Cables

If you use long motor cables with a high carrier frequency, the increased leakage current can cause nuisance tripping of the thermal relay. To prevent this, decrease the carrier frequency or increase the tripping level of the thermal overload relay.

### Nuisance Tripping Because of High Drive Carrier Frequency

High carrier frequency PWM drives make current waveforms that can increase the temperature in overload relays. It may be necessary to increase the trip level setting when encountering nuisance triggering of the relay.

**WARNING! Fire Hazard.** Before you increase the detection level of the thermal relay, make sure that a secondary problem is not the cause of the overload. Make sure that you know the local codes for electrical wiring, then adjust the electrothermal settings. Incorrect thermal relay adjustment and incorrect wiring can cause serious injury or death.

## 3.11 Improve the Power Factor

### ◆ Connecting an AC Reactor

AC reactors decrease surges in current and improve the power factor on the input side of the drive.

Connect an AC reactor to the input side (primary side) in these conditions:

- To decrease harmonic current or improve the power factor of the power supply
- When there is switching of phase advancing capacitor
- With a large capacity power supply transformer (600 kVA or more).

**Note:**

- When you connect a thyristor converter (for example, a DC drive) to the same power supply system, use an AC reactor for all power supply conditions.
- The main circuit terminal block for the drive and the terminal block for the AC reactor have different shapes. The drive has a European-style terminal block and the AC reactor has a circular terminal block. Use caution when you prepare the ends of the wires.

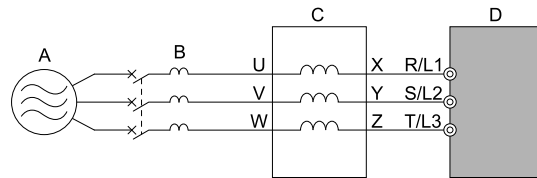

**A - Power supply**  
**B - MCCB**

**C - AC reactor**  
**D - Drive**

**Figure 3.63 AC Reactor Connection Example**

**Note:**

When you connect an AC reactor to the output side (secondary side) of the drive, set  $C6-02 = 1$  [Carrier Frequency Selection = 2.0 kHz].



## 3.12 Prevent Switching Surge

### ◆ Connect a Surge Protective Device

A surge protective device decreases the surge voltage generated when you switch an inductive load near the drive. Inductive loads include:

- Magnetic contactors
- Electromagnetic relays
- Magnetic valves
- Solenoids
- Magnetic brakes.

Always use a surge protective device or diode with inductive loads.

**Note:**

Do not connect a surge protective device to the drive output side.

## 3.13 Protect the Drive during Failures

### ◆ Short Circuit Protection Requirements for UL Listing

**WARNING! Electrical Shock Hazard.** After the input protective device trips, do not immediately energize the drive or operate peripheral devices. Wait for the time specified on the warning label at a minimum and make sure that all indicators are OFF. Then check the wiring and peripheral device ratings to find the cause of the problem. If you do not know the cause of the problem, contact Yaskawa before you energize the drive or peripheral devices. If you do not fix the problem before you operate the drive or peripheral devices, it can cause serious injury or death.

### ■ UL Compliance

Install one of the types of short circuit protection devices in [Table 3.20](#) or [Table 3.21](#) to comply with UL 508C.

Semiconductor protective type fuses are recommended, but the tables also show alternative short circuit protection devices.

#### Molded Case Circuit Breaker (MCCB) Ratings

- Maximum MCCB rating is 250% of the drive full load output amp (FLA) rating.
- When you use MCCBs you must mount the drive in a ventilated enclosure according to the minimum enclosure volume specified in this document.

**Note:**

When you use MCCBs, current limiting type are recommended, but not required.

#### Semiconductor Fuse Ratings

When you use semiconductor fuses as UL listed drive protection, the drives and fuses must be in the same enclosure.

#### Non-Semiconductor Fuse Ratings

Maximum CC, J, or T fuse rating is 175% of the drive full load output amp (FLA) rating.

#### Short Circuit Current Rating (SCCR)

The maximum SCCR provided by drive and fuse, or drive and MCCB combinations in this document, is 100,000 RMS symmetrical amps.

- 240 V models: Use the protection specified in this document to prepare the drive for use on a circuit capable of delivering not more than 100,000 RMS symmetrical amps and not more than 240 Vac.
- 480 V models: Use the protection specified in this document to prepare the drive for use on a circuit capable of delivering not more than 100,000 RMS symmetrical amps and not more than 480 Vac.

### Electric Code Compliance

The user must provide short circuit protection to protect input branch circuits as specified by the National Electric Code (NEC), the Canadian Electric Code, Part 1 (CEC), and local codes.

### Required Short Circuit Protection

**Table 3.20 Required Short Circuit Protection for HV600 AC Drives (240 V Class)**

Protected Enclosure Not Required			Ventilated Protected Enclosure Required		
Drive Catalog Code HV60U	Semiconductor Fuse Part Number <i>Manufacturer: Eaton/ Bussmann</i>	Class CC, J, or T Fuse <sup>*J</sup> Maximum Amps	MCCB Maximum Amps	MCP Part Number <i>Manufacturer: Schneider</i>	Enclosure Volume Minimum (in <sup>3</sup> )
2011	FWH-40B	17.5	25	HLL36030M71	3056
2017	FWH-45B	25	40	HLL36030M71	3056
2024	FWH-80B	40	60	HLL36050M72	3056
2031	FWH-125B	50	75	HLL36050M72	3056
2046	FWH-125B	80	110	HLL36100M73	5520
2059	FWH-175B	100	125	HLL36100M73	5520
2075	FWH-200B	125	175	HLL36150M74	5520
2088	FWH-225A	150	200	HLL36150M74	5520
2114	FWH-225A	200	250	HLL36150M74	5520

Protected Enclosure Not Required			Ventilated Protected Enclosure Required		
Drive Catalog Code HV60U	Semiconductor Fuse Part Number <i>Manufacturer: Eaton/Bussmann</i>	Class CC, J, or T Fuse <sup>*1</sup> Maximum Amps	MCCB Maximum Amps	MCP Part Number <i>Manufacturer: Schneider</i>	Enclosure Volume Minimum (in <sup>3</sup> )
2143	FWH-250A	250	350	JLL36250M75	14657
2169	FWH-275A	250	400	JLL36250M75	14657
2211	FWH-600A	350	500	LLL36400M37X	14657
2273	FWH-800A	450	600	LLL36400M37X	14657

\*1 Class T fuses are fast-acting (non-time-delay) only. You can substitute a Class J time-delay fuse for a Class J non-time-delay fuse.

**Table 3.21 Required Short Circuit Protection for HV600 AC Drives (480 V Class)**

Protected Enclosure Not Required			Ventilated Protected Enclosure Required			
Drive Catalog Code HV60U	Semiconductor Fuse Part Number <i>Manufacturer: Eaton/Bussmann</i>	Class CC, J, or T Fuse <sup>*1</sup> Maximum Amps	MCCB Maximum Amps	MCP Part Number <i>Manufacturer: Schneider</i>	Enclosure Volume Minimum (in <sup>3</sup> )	
					External Heatsink	Internal Heatsink
4005	FWH-25A14F	8	15	HLL36030M71	3056	3056
4006	FWH-30A14F	9	15	HLL36030M71	3056	3056
4008	FWH-30A14F	12	15	HLL36030M71	3056	3056
4011	FWH-40B	17.5	25	HLL36030M71	3056	3056
4014	FWH-45B	20	35	HLL36030M71	3056	3056
4021	FWH-60B	35	50	HLL36030M71	3056	3056
4027	FWH-80B	45	60	HLL36050M72	3056	3056
4034	FWH-100B	60	80	HLL36050M72	3056	3056
4040	FWH-125B	70	100	HLL36100M73	5520	5520
4052	FWH-150B	90	125	HLL36100M73	5520	5520
4065	FWH-200B	110	150	HLL36100M73	5520	5520
4077	FWH-225A	125	175	HLL36100M73	5520	5520
4096	FWH-225A	150	225	HLL36150M74	5520	5520
4124	FWH-225A	200	300	JLL36250M75	5520	5520
4156	FWH-325A	250	350	JLL36250M75	21582	14657
4180	FWH-500A	300	450	JLL36250M75	52800 <sup>*2</sup>	14657
4240	FWH-600A	400	600	LLL36400M37X	52800 <sup>*2</sup>	14657
4302	FWH-700A	500	700	LLL36400M37X	52800 <sup>*2</sup>	52800

\*1 Class T fuses are fast-acting (non-time-delay) only. You can substitute a Class J time-delay fuse for a Class J non-time-delay fuse.

\*2 External heatsink installations on models 4180, 4240, and 4302 require a heatsink shroud and filter.



Checked	No.	Item to Check
	8	Make sure that none of the wires on the terminal block touch other terminals or connections.
	9	Isolate the control circuit wiring from main circuit wiring with a duct or inside the control panel.
	10	Make sure that control circuit wiring is not longer than 50 m (164 ft).
	11	Make sure that Safe Disable input wiring is not longer than 30 m (98 ft).

## 3.15 Motor Application Precautions

### ◆ Precautions for Existing Standard Motors

#### ■ Low-Speed Range

When a drive operates a standard motor, it will lose more power compared to operating the motor with a commercial power supply. In the low speed range, the temperature of the motor increases quickly because the motor cannot decrease its temperature when the speed decreases. In these conditions, decrease the load torque of the motor in the low-speed range. Figure 3.64 shows the permitted load characteristics for a Yaskawa standard motor. When 100% continuous torque is necessary at low speeds, use a motor designed to operate with a drive.

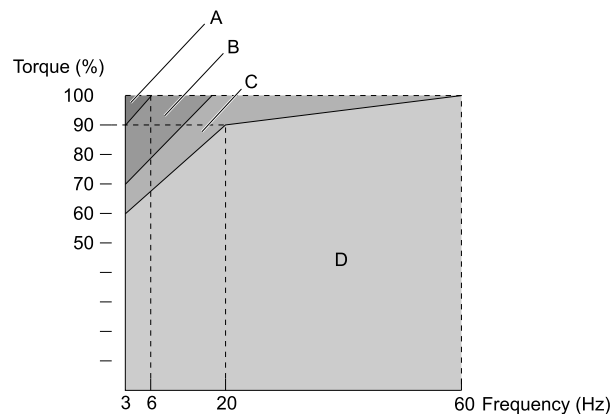

A - 25% ED (or 15 min)

B - 40% ED (or 20 min)

C - 60% ED (or 40 min)

D - Continuous operation

Figure 3.64 Permitted Load Characteristics for a Yaskawa Standard Motors

#### ■ Insulation Withstand Voltage

Consider motor voltage tolerance levels and motor insulation in applications with an input voltage of over 440 V or particularly long wiring distances. Use an insulated drive motor.

**NOTICE:** Use an inverter-duty motor or vector-duty motor with reinforced insulation and windings applicable for use with an AC drive. If the motor does not have the correct insulation, it can cause a short circuit or ground fault from insulation deterioration.

#### ■ High-Speed Operation

If you operate a motor higher than its rated speed, you can have problems with the motor bearing durability and dynamic balance of the machine. Contact the motor or machine manufacturer.

#### ■ Torque Characteristics

When you operate a motor with a drive, the torque characteristics are different than when you operate the motor directly from line power. Make sure that you know about the load torque characteristics for your application.

#### ■ Vibration

Vibrations can occur in these conditions:

- Resonance with the natural frequency of machinery  
Use caution if you add a variable-speed drive to applications that operate the motor from line power at a constant speed. If resonance occurs, install shock-absorbing rubber around the base of the motor and enable the Jump frequency control.
- The motor is not balanced  
Use caution if the motor speed is higher than the rated motor speed.
- Subsynchronous resonance  
Subsynchronous resonance can occur with long motor shafts and in applications such as turbines, blowers, and fans with high inertia loads.

## ■ Audible Noise

The audible noise of the motor changes when the carrier frequency setting changes. When you use a high carrier frequency, audible noise from the motor is equivalent to the motor noise generated when you operate from line power. If you operate at speeds that are more than the rated rotation speed, the unwanted motor noise increases.

## ◆ Precaution When You Use IE3 Premium Efficiency Motors

IE3 motors have different motor characteristics from IE1 and other motors. Set the parameters as specified by the motor characteristics. If the drive detects *oC* [Overcurrent] or *ov* [Overvoltage] during speed search after the drive restores power after a momentary power loss, set these parameters:

- *b3-03* [Speed Search Deceleration Time] = default value × 2
- *L2-03* [Minimum Baseblock Time] = default value × 2
- *L2-04* [Powerloss V/f Recovery Ramp Time] = default value × 2

## ◆ Precautions for PM Motors

- Contact Yaskawa or your nearest sales representative to use a non-Yaskawa PM motor.
- You cannot operate a PM motor from a commercial power supply. If you must operate from a commercial power supply, use an induction motor.
- You cannot operate more than one PM motor from one drive. Use an induction motor and a variable-speed control drive.
- In Open Loop Vector Control for PM motor (OLV/PM), the motor can operate in the reverse direction for 1/2 turn (electrical angle) at start up.
- The quantity of generated starting torque changes when the control method and motor type change. Verify the starting torque, permitted load characteristics, impact load tolerance, and speed control range before you set up the motor with the drive. Contact Yaskawa or your nearest sales representative to use a motor that does not meet these specifications.
- Do not use a PM motor for applications with a load inertia moment that is more than 50 times of the motor inertia moment.
- When you use a holding brake in OLV/PM control, release the brake before you start the motor. If you do not set the correct timing, it can cause a decrease in speed. Do not use these configurations in applications with heavy loads, for example conveyors or elevators.
- To restart a coasting motor that is rotating faster than 200 Hz in OLV/PM Control, wait until the motor frequency decreases to be slower than 200 Hz, then use the Speed Search function.  
If the motor wiring length is long, stop the motor and start to operate it again.
- You can also use EZ Open Loop Vector Control (EZOLV) to operate synchronous reluctance motors (SynRM). Contact Yaskawa or your nearest sales representative for more information.
- If *oC* [Overcurrent] or *STPo* [Motor Step-Out Detected] occur during restart, retry Speed Search and use the Short Circuit Braking function when starting to adjust the motor.

## ◆ Precautions for Specialized Motors

### ■ Pole Change Motors

The rated current of pole change motors is different than standard motors. Check the maximum current of the motor before you select a drive. Always stop the motor before you switch between the number of motor poles. If you change the number of poles while the motor is rotating, the overvoltage from regeneration or the overcurrent protection circuitry will make the motor coast to stop.

### ■ Submersible Motors

The rated current of a submersible motor is more than the rated current of a standard motor. Use a sufficiently large motor cable that will not let voltage drop decrease the maximum torque level.

### ■ Explosion-Proof Motors

You must test the motor and the drive together for explosion-proof certification. You must also test existing installations of explosion-proof motors. The drive is not designed for explosion-proof areas. Install the drive in a safe location.

The encoder used with pressure-resistant explosion-proof motors is intrinsically safe. When wiring between the drive and encoder, always connect through a specialized pulse coupler.

### ■ Geared Motors

The continuous speed range is different for different lubricating methods and manufacturers. For oil lubrication, continuous operation in the low-speed range can cause burnout. Contact the manufacturer for more information about applications where operating at more than the rated frequency is necessary.

### ■ Single-Phase Motors

Variable speed drives are not designed to operate with single-phase motors. The drive is for use with three-phase motors only. If you use capacitors to start the motor, it can cause a high frequency current to flow to the capacitors and can damage the capacitors. A split-phase start or a repulsion start can burn out the starter coils because the internal centrifugal switch is not activated.

### ■ Motors with Brakes

If you use a drive to operate a motor that has a brake connected to the output side, low voltage levels can cause the brake to possibly not release at start. Use a motor with a brake that has a dedicated source of power for the brake. Connect the brake power supply to the power supply side of the drive. Motors with built-in brakes make noise when operating at low speeds.

---

### ◆ Notes on the Power Transmission Mechanism

For power transmission machinery that uses oil to lubricate gearboxes, transmissions, or reduction gears, make sure that you use precaution if you operate the machinery continuously at low speed. Oil does not lubricate the system as well at low speeds. If you operate at frequencies higher than the rated frequency, it can cause problems with the power transmission mechanism. These problems include audible noise, decreased service life, and decreased durability.



## Startup Procedure and Test Run

---

4.1	Section Safety .....	132
4.2	Drive Main Switch.....	133
4.3	Keypad: Names and Functions.....	135
4.4	LED Status Ring.....	141
4.5	Start-up Procedures .....	143
4.6	Items to Check before Starting Up the Drive .....	147
4.7	Keypad Operation .....	149
4.8	Automatic Parameter Settings Optimized for Specific Applications (Application Presets).....	185
4.9	Auto-Tuning .....	187
4.10	Test Run .....	192
4.11	Fine Tuning during Test Runs (Adjust the Control Function).....	194
4.12	Test Run Checklist .....	197

## 4.1 Section Safety

### DANGER

#### Electrical Shock Hazard

**Do not examine, connect, or disconnect wiring on an energized drive. Before servicing, disconnect all power to the equipment and wait for the time specified on the warning label at a minimum. The internal capacitor stays charged after the drive is de-energized. The charge indicator LED extinguishes when the DC bus voltage decreases below 50 Vdc. When all indicators are OFF, remove the covers before measuring for dangerous voltages to make sure that the drive is safe.**

If you do work on the drive when it is energized, it will cause serious injury or death from electrical shock.

### WARNING

#### Electrical Shock Hazard

**Do not operate the drive when covers are missing. Replace covers and shields before you operate the drive. Use the drive only as specified by the instructions.**

Some figures in this section include drives without covers or safety shields to more clearly show the inside of the drive. If covers or safety shields are missing from the drive, it can cause serious injury or death.

**Do not remove covers or touch circuit boards while the drive is energized.**

If you touch the internal components of an energized drive, it can cause serious injury or death.

### NOTICE

#### Sudden Movement Hazard

**Deactivate the Run command before you switch from Programming Mode to Drive Mode.**

If you switch from Programming Mode to Drive Mode and there is an active Run command, the motor will rotate and the equipment can suddenly start.

## 4.2 Drive Main Switch

Table 4.1 Main Switch and Drive Status

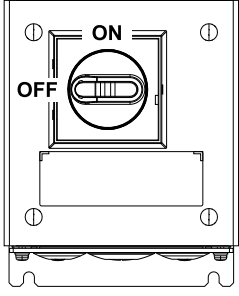
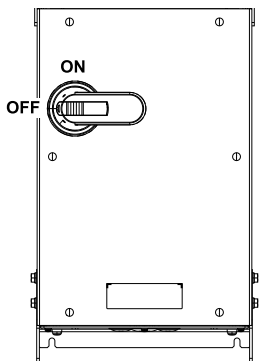
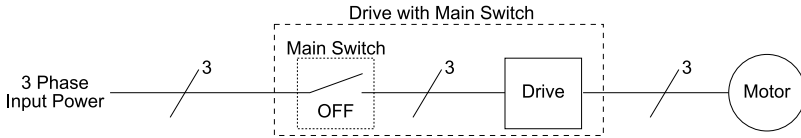
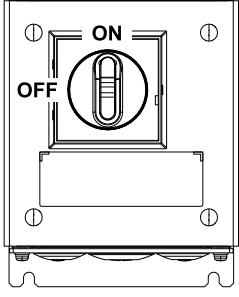
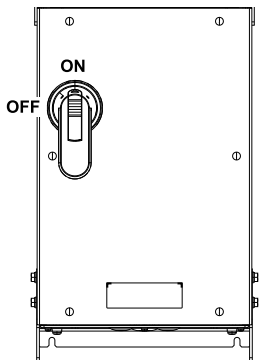
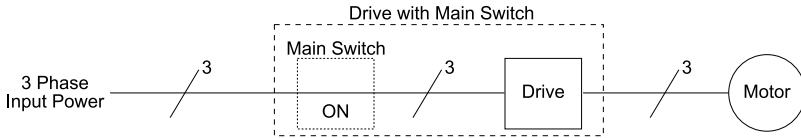
Main Switch Status		Drive Status
2011 - 2031 4005 - 4034	2046 - 2114 4040 - 4096	
		 <p>3 Phase Input Power — 3 — Main Switch (OFF) — 3 — Drive — 3 — Motor</p>
		 <p>3 Phase Input Power — 3 — Main Switch (ON) — 3 — Drive — 3 — Motor</p>

### ◆ Use and Lock the Main Switch

When you must touch the motors or machines, for example in maintenance, use the Main Switch to de-energize the drive and lock the Main Switch Disconnect Handle in the OFF position as specified by this procedure.

**Note:**

Yaskawa recommends that you de-energize the drive before you turn the Main Switch from ON to OFF.

**WARNING! Electrical Shock Hazard.** Disconnect all power to the drive and remove all wires to do maintenance on the drive. If you only turn OFF the built-in Main Switch before you do maintenance, there can be high voltage on input terminals R/L1, S/L2, and T/L3 of the Main Switch and touching energized terminals will cause serious injury or death.

**NOTICE: Damage to Equipment.** Do not energize and de-energize the drive more frequently than one time each 30 minutes. If you frequently energize and de-energize the drive, it can cause drive failure.

**NOTICE: Damage to Equipment.** Do not cycle the Main Switch more than 6000 times. If you cycle the Main Switch more times than the limit, it will cause the contact failure, or you cannot open or close the Main Switch.

**NOTICE: Damage to Equipment.** Make sure that you stop the motor before you turn ON/OFF the Main Switch. If you turn ON/OFF the Main Switch during run, it can cause Main Switch failure.

1. Stop the drive and make sure that the motor is completely stopped.

- Turn the Main Switch from ON to OFF.

**Table 4.2 Turn OFF the Main Switch**

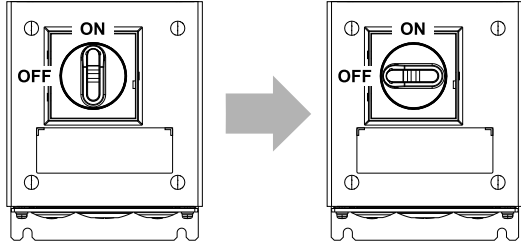
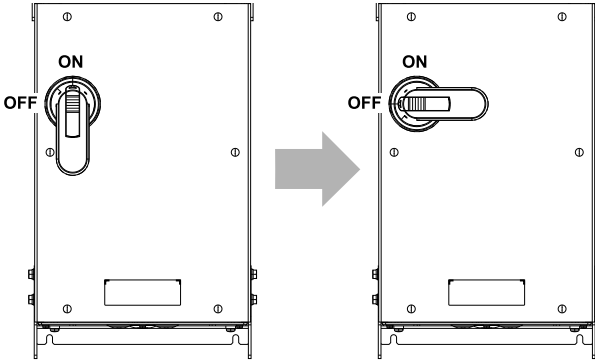
Model	Main Switch Status
2011 - 2031 4005 - 4034	
2046 - 2114 4040 - 4096	

- Put a lock through the hole of the Main Switch.

**Note:**

The lock is not included with the drive.

**Table 4.3 Lock the Main Switch**

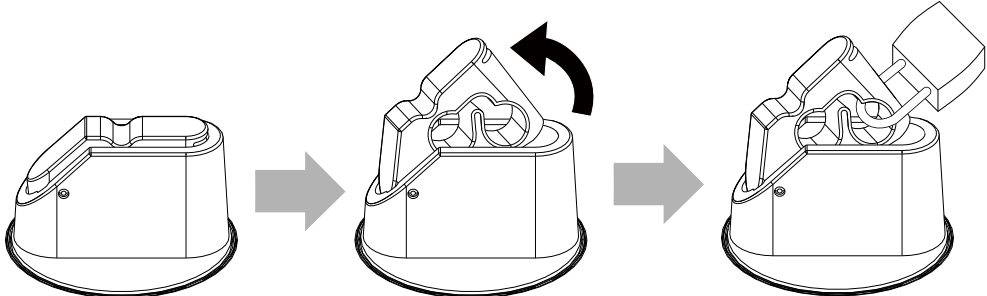
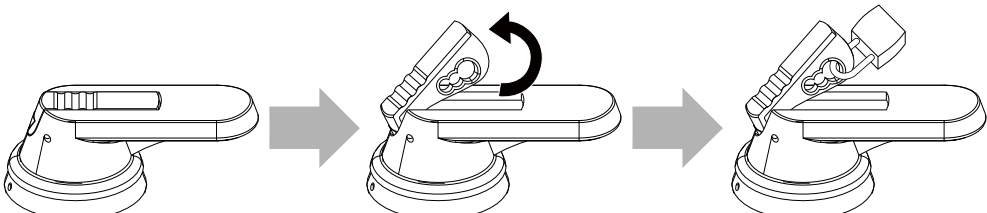
Model	Main Switch Status
2011 - 2031 4005 - 4034	
2046 - 2114 4040 - 4096	

# 4.3 Keypad: Names and Functions

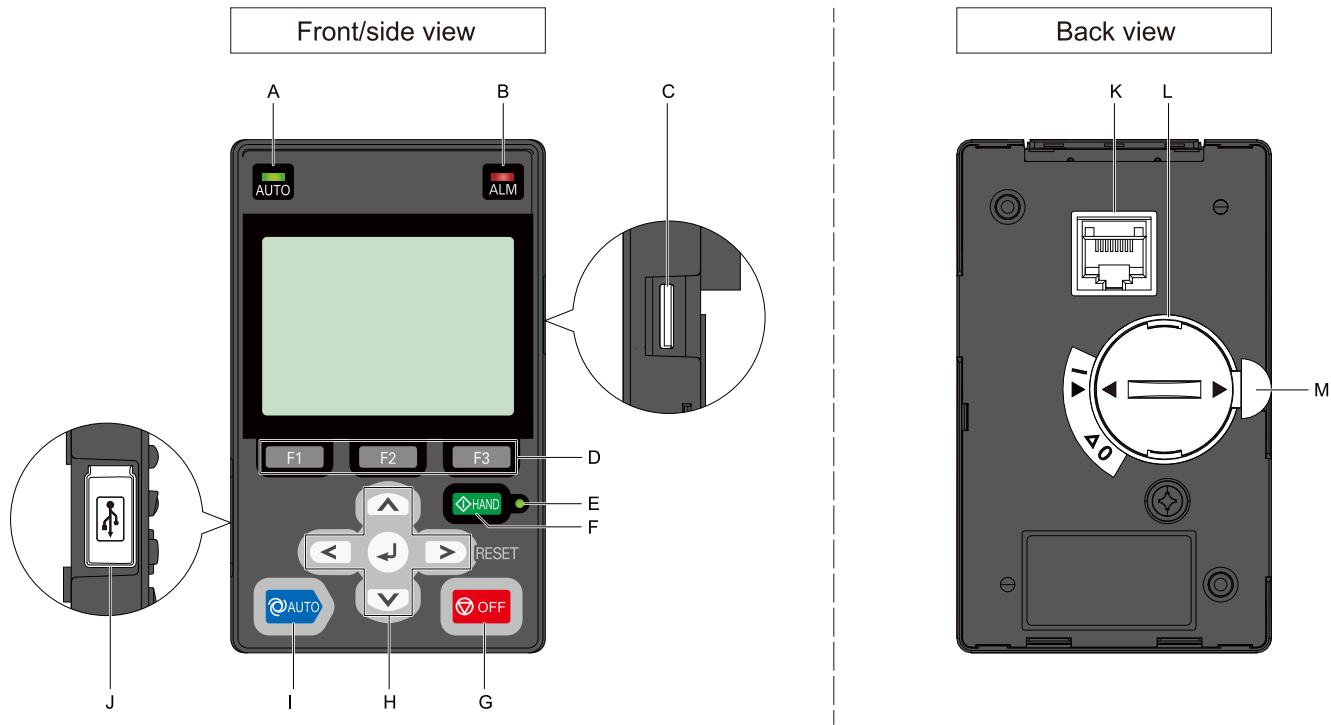

Figure 4.1 Keypad







Table 4.4 Keypad: Names and Functions

No.	Name	Function
A	AUTO LED <sup>*/</sup> 	Illuminates to show that the drive is in AUTO Mode.
B	ALM LED 	Illuminates when the drive detects a fault. Flashes when the drive detects: <ul style="list-style-type: none"> <li>An alarm</li> <li>An oPE parameter setting error</li> <li>A fault or alarm during Auto-Tuning</li> </ul> The LED turns off when there are no drive faults or alarms.
C	microSD Card Insertion Slot	The insertion point for a microSD card.
D	Function Keys (F1, F2, F3) 	The menu shown on the keypad sets the functions for function keys. The name of each function is in the lower half of the display window.
E	HAND LED <sup>*/</sup> 	Illuminates to show that the drive is in HAND Mode.
F	HAND Key 	Sets drive operation to HAND Mode. The drive uses the S5-01 [HAND Frequency Reference Selection] setting.
G	OFF Key 	Stops drive operation. <b>Note:</b> The OFF key has highest priority. Push  to stop the motor even when a Run command is active at an external Run command source. Set o2-02 = 0 [STOP Key Function Selection = Disabled] to disable  priority.

Startup Procedure and Test Run

4

## 4.3 Keypad: Names and Functions

No.	Name	Function
H	Left Arrow Key 	Moves the cursor to the left.
	Up Arrow Key/Down Arrow Key 	<ul style="list-style-type: none"> <li>Scrolls up or down to display the next item or the previous item.</li> <li>Selects parameter numbers, and increments or decrements setting values.</li> </ul>
	Right Arrow Key (RESET) 	<ul style="list-style-type: none"> <li>Moves the cursor to the right.</li> <li>Continues to the next screen.</li> <li>Clears drive faults.</li> </ul>
	ENTER Key 	<ul style="list-style-type: none"> <li>Enters parameter values and settings.</li> <li>Selects menu items to move the user between keypad displays.</li> <li>Selects each mode, parameter, and set value.</li> </ul>
I	AUTO Key 	<p>Sets drive operation to AUTO Mode. The drive uses the <i>b1-01 [Frequency Reference Selection 1]</i> and <i>b1-02 [Run Command Selection 1]</i> settings.</p> <p><b>Note:</b> Push  on the keypad to set the drive to HAND Mode before you use the keypad to operate the motor.</p>
J	USB Terminal	Insertion point for a mini USB cable. Uses a USB cable (USB standard 2.0, type A - mini-B) to connect the keypad to a PC.
K	RJ-45 Connector	Uses an RJ-45 8-pin straight through UTP CAT5e extension cable or keypad connector to connect to the drive.
L	Clock Battery Cover	<p>Cover for the clock battery.</p> <p><b>Note:</b></p> <ul style="list-style-type: none"> <li>The battery included with the keypad is for operation check. It may be exhausted earlier than the expected battery life described in the manual.</li> <li>Refer to "Maintenance &amp; Troubleshooting Manual (TOEPYAIHV6001)" for more information about replacement procedure.</li> </ul> <p>To replace the battery, use a Hitachi Maxell "CR2016 Lithium Manganese Dioxide Lithium Battery" or an equivalent battery with these properties:</p> <ul style="list-style-type: none"> <li>Nominal voltage: 3 V</li> <li>Operating temperature range: -20 °C to +85 °C (-4 °F to +185 °F)</li> </ul>
M	Insulation Sheet	An insulating sheet is attached to the keypad battery to prevent battery drain. Remove the insulation sheet before you use the keypad for the first time.

\*1 Refer to [AUTO LED and HAND LED Indications on page 137](#) for more information about AUTO LED and HAND LED indications.

## ◆ LCD Display

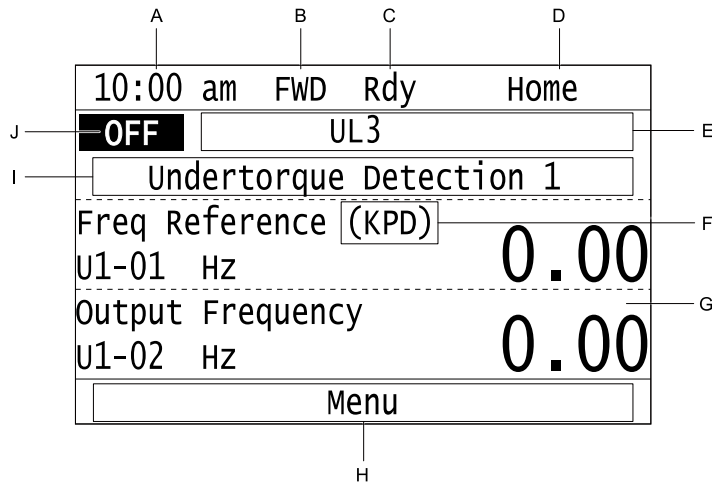



Figure 4.2 LCD Display Indications

Table 4.5 LCD Display Indications and Meanings



Symbol	Name	Description
A	Time display area	Shows the current time. Set the time on the default settings screen.
B	Forward/Reverse run indication	<p>Shows direction of motor rotation.</p> <ul style="list-style-type: none"> <li>FWD: Shown when set to Forward run.</li> <li>REV: Shown when set to Reverse run.</li> </ul> <p><b>Note:</b> In DriveWorksEZ operation, FWD or REV flash.</p>

Symbol	Name	Description
C	Ready	The screen will show Rdy when the drive is ready for operation or when the drive is running.
D	Mode display area	Shows the name of the current mode or screen.
E	Alarm codes and drive status messages display area <sup>*1</sup>	Shows an alarm code or message of drive status.
F	Frequency reference source indication	Shows the current frequency reference source. <ul style="list-style-type: none"> <li>• KPD: keypad</li> <li>• AI: analog input terminal (terminals A1 or A2)</li> <li>• COM: serial communications</li> <li>• OPT: option card</li> </ul>
G	Data display area	Shows parameter values, monitor values, and details of the results of operations.
H	Function keys 1 to 3 (F1 to F3)	The function names shown in this area will change when the selected screen changes. Push one of the function keys  to  on the keypad to do the function.
I	Alarm and message texts display area <sup>*1</sup>	Shows a fault, minor fault, alarm, or error name and message text. <p><b>Note:</b> When the drive must show an alarm and a message on the keypad at the same time, the keypad will switch between the alarm code and message text in 2-second intervals.</p>
J	HOA mode or alternative Run command source indication	<ul style="list-style-type: none"> <li>• OFF: The drive is operating in OFF Mode.</li> <li>• AUTO: The drive is operating in AUTO Mode.</li> <li>• HAND: The drive is operating in HAND Mode.</li> <li>• JOG: The drive is operating in JOG Mode.</li> <li>• EMOV: The drive is operating in Emergency Override Mode.</li> </ul>

\*1 Refer to [Status Monitor Display on page 855](#) for more information about the Status Monitor display.

## ◆ AUTO LED and HAND LED Indications

Table 4.6 AUTO LED and HAND LED Indications

 AUTO LED	 HAND LED	Status
OFF	OFF	OFF Mode
OFF	ON	HAND Mode
OFF	Long blink (50% duty)	HAND Mode <ul style="list-style-type: none"> <li>• When the Frequency Reference is 0 or during deceleration</li> <li>• During PI Sleep</li> </ul>
OFF	Double blink	HAND Mode When you clear the Run command and enter the Run command again during the time set in C1-02 [Deceleration Time 1]
ON	OFF	AUTO Mode
Long blink (50% duty)	OFF	AUTO Mode <ul style="list-style-type: none"> <li>• When the Frequency Reference is 0 or during deceleration</li> <li>• During PI Sleep</li> </ul>
Double blink	OFF	AUTO Mode When an MFDI sends a Fast Stop signal to stop the drive

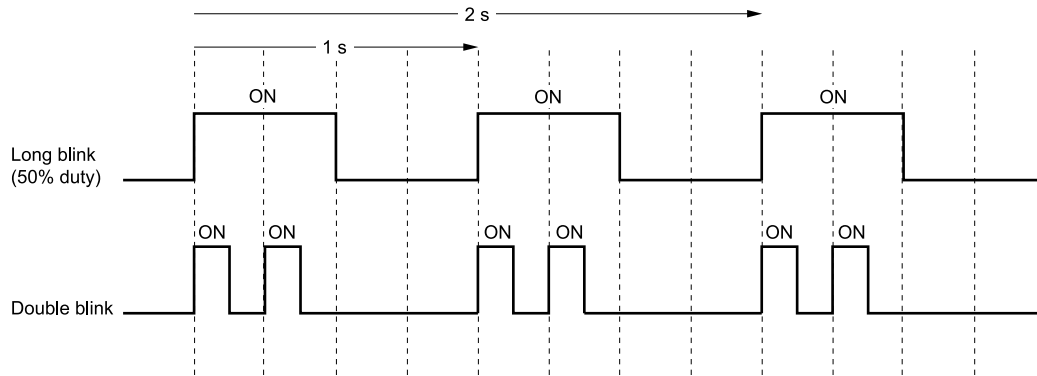

Figure 4.3 AUTO LED and HAND LED Timing Status

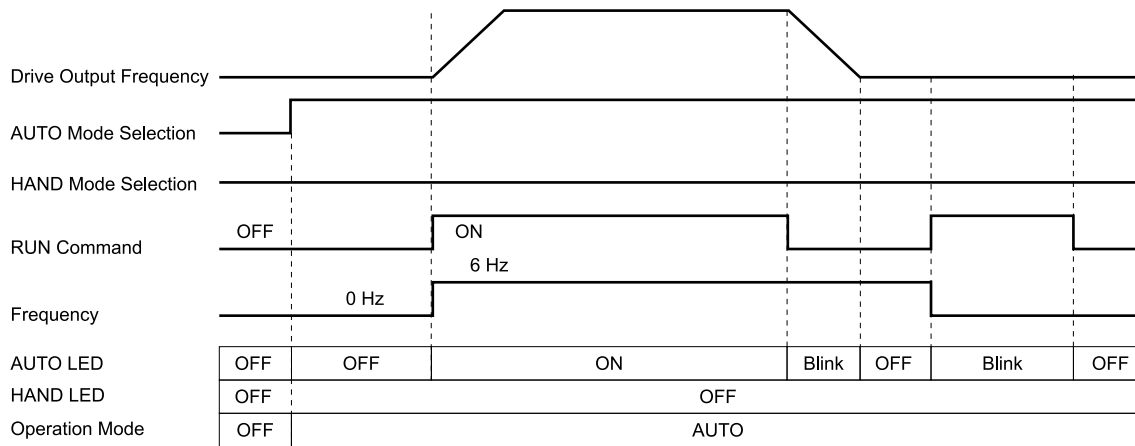

Figure 4.4 LEDs and Drive Operation in AUTO and HAND Modes



◆ Keypad Mode and Menu Displays

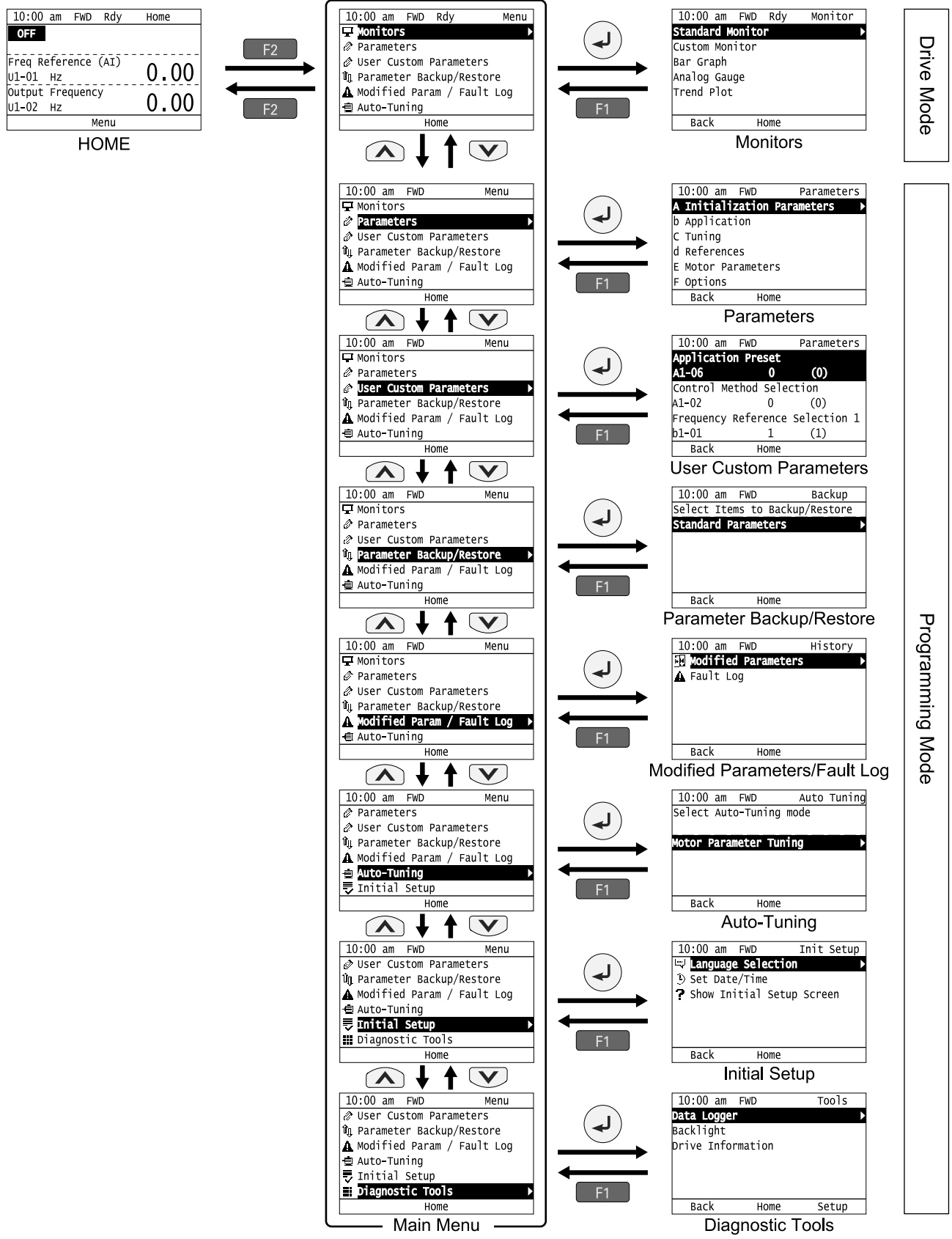



Figure 4.5 Keypad Functions and Display Levels

## 4.3 Keypad: Names and Functions

### Note:

- Energize the drive with factory defaults to show the Initial Setup screen. Push **F2** (Home) to show the HOME screen.  
–Select [No] from the [Show Initial Setup Screen] setting to not display the Initial Setup screen.
- Push  from the Home screen to show drive monitors.
- Push  to set *d1-01 [Reference 1]* when you set *b1-01 = 0 [Frequency Reference Selection 1 = Keypad]* and the Home screen shows *U1-01 [Frequency Reference]*.
- The keypad will show [Rdy] when the drive is in Drive Mode. The drive is prepared to accept a Run command.
- The drive will not accept a Run command in Programming Mode in the default setting. Set *b1-08 [Run Command Select in PRG Mode]* to accept or reject a Run command from an external source while in Programming Mode.  
–Set *b1-08 = 0 [Disregard RUN while Programming]* to reject the Run command from an external source while in Programming Mode (default).  
–Set *b1-08 = 1 [Accept RUN while Programming]* to accept the Run command from an external source while in Programming Mode.  
–Set *b1-08 = 2 [Allow Programming Only at Stop]* to prevent changes from Drive Mode to Programming Mode while the drive is operating.

**Table 4.7 Drive Mode Screens and Functions**

Mode	Keypad Screen	Function
Drive Mode	Monitors	Sets monitor items to display.
Programming Mode	Parameters	Changes parameter settings.
	User Custom Parameters	Shows the User Parameters.
	Parameter Backup/Restore	Saves parameters to the keypad as backup.
	Modified Parameters/Fault Log	Shows modified parameters and fault history.
	Auto-Tuning	Auto-Tunes the drive.
	Initial Setup	Changes initial settings.
	Diagnostic Tools	Sets data logs and backlight.

## 4.4 LED Status Ring

The LED Status Ring on the drive cover shows the drive operating status.

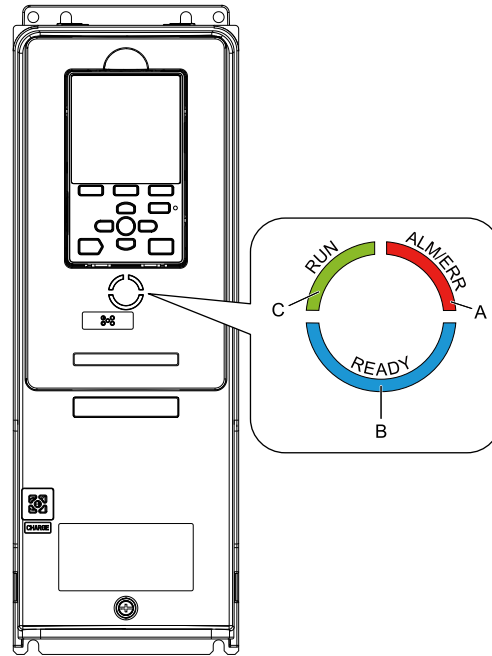

A - ALM/ERR  
B - Ready

C - RUN

LED	Status	Description
A	ALM/ERR	Illuminated The drive detects a fault.
	Flashing <i>*I</i>	The drive detects: <ul style="list-style-type: none"> <li>An alarm</li> <li>An oPE parameter setting error</li> <li>An Auto-Tuning error</li> </ul> <b>Note:</b> If the drive detects a fault and an alarm at the same time, the LED will illuminate to identify a fault.
	OFF	There are no drive faults or alarms.
B	Ready	Illuminated The drive is operating or is prepared for operation.
	Flashing <i>*I</i>	The drive is in <i>STo</i> [ <i>Safe Torque OFF</i> ] condition.
	Flashing Quickly <i>*I</i>	The voltage of the main circuit power supply dropped, and only the external 24 V power supply is providing the power to the drive.
	OFF	<ul style="list-style-type: none"> <li>The drive detects a fault.</li> <li>There is no fault and the drive received a Run command, but the drive cannot operate. For example, in Programming Mode.</li> </ul>

## 4.4 LED Status Ring

LED	Status	Description	
C	RUN	Illuminated	The drive is in regular operation.
		Flashing <sup>*1</sup>	<ul style="list-style-type: none"> <li>The drive is decelerating to stop.</li> <li>The drive received a Run command with a frequency reference of 0 Hz.</li> <li>The drive received a DC Injection Braking command.</li> </ul>
		Flashing Quickly <sup>*1</sup>	<ul style="list-style-type: none"> <li>The drive received a Run command from the MFDI terminals when <math>b1-02 = 0</math> [Run Command Selection 1 = Keypad] and you changed the setting to <math>b1-02 = 1</math> or <math>7</math> [Digital Input or AUTO Command + Term Run].</li> <li>The drive received a Run command from the MFDI terminals when the drive is not in Drive Mode.</li> <li>The drive received a Fast Stop command.</li> <li>The safety function shuts off the drive output.</li> <li>The user pushed  on the keypad when the drive is operated from a REMOTE source.</li> <li>The drive is energized with an active Run command and <math>b1-17 = 0</math> [Run Command at Power Up = Disregard Existing RUN Command].</li> <li>The drive is set to coast-to-stop with timer (<math>b1-03 = 3</math> [Stopping Method Selection = Coast to Stop with Timer]), and the Run command is disabled then enabled during the Run wait time.</li> </ul>
		OFF	The motor is stopped.

\*1 Refer to [Figure 4.6](#) for the difference between “flashing” and “flashing quickly”.

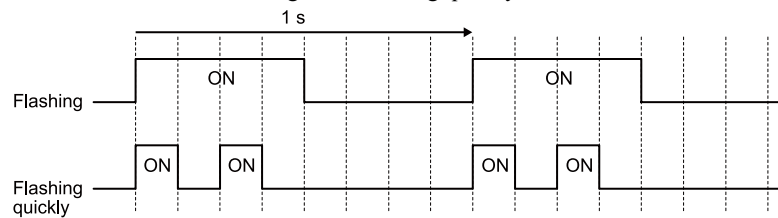

**Figure 4.6 LED Flashing Statuses**

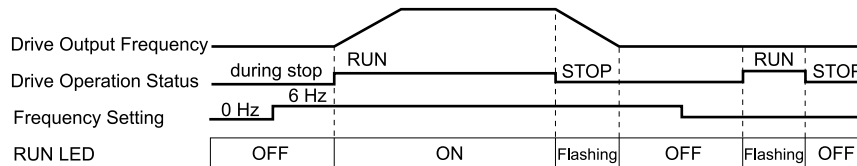

**Figure 4.7 Relation between RUN LED and Drive Operation**

## 4.5 Start-up Procedures

This section gives the basic steps necessary to start up the drive.

Use the flowcharts in this section to find the most applicable start-up method for your application.

This section gives information about only the most basic settings.

**Note:**

Refer to the *A1-06* section to use an Application Preset to set up the drive.

### ◆ Flowchart A: Connect and Run the Motor with Minimum Setting Changes

Flowchart A shows a basic start-up sequence to connect and run a motor with a minimum of setting changes. Settings can change when the application changes.

Use the drive default parameter settings for basic applications where high precision is not necessary.

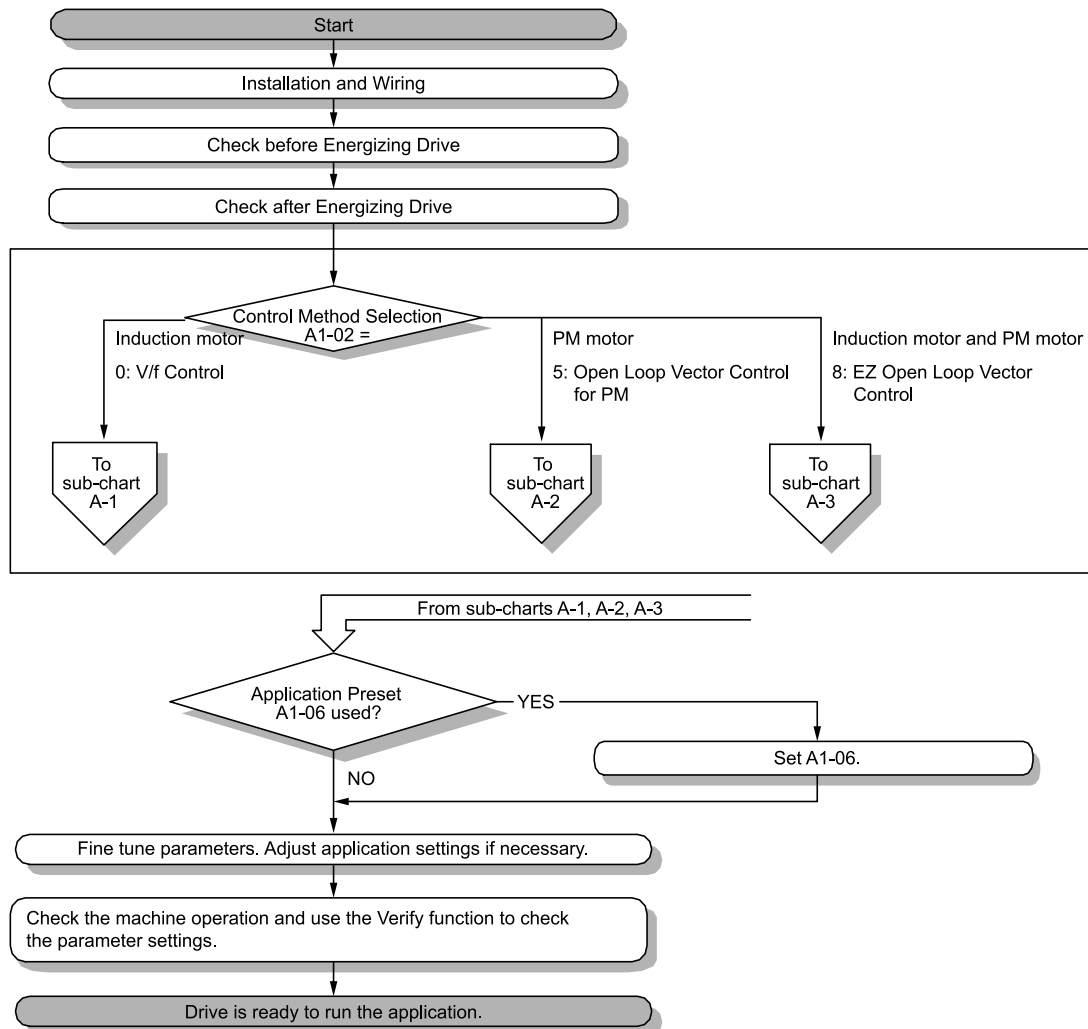

Figure 4.8 Basic Steps before Startup

### ◆ Sub-Chart A-1: Induction Motor Auto-Tuning and Test Run Procedure

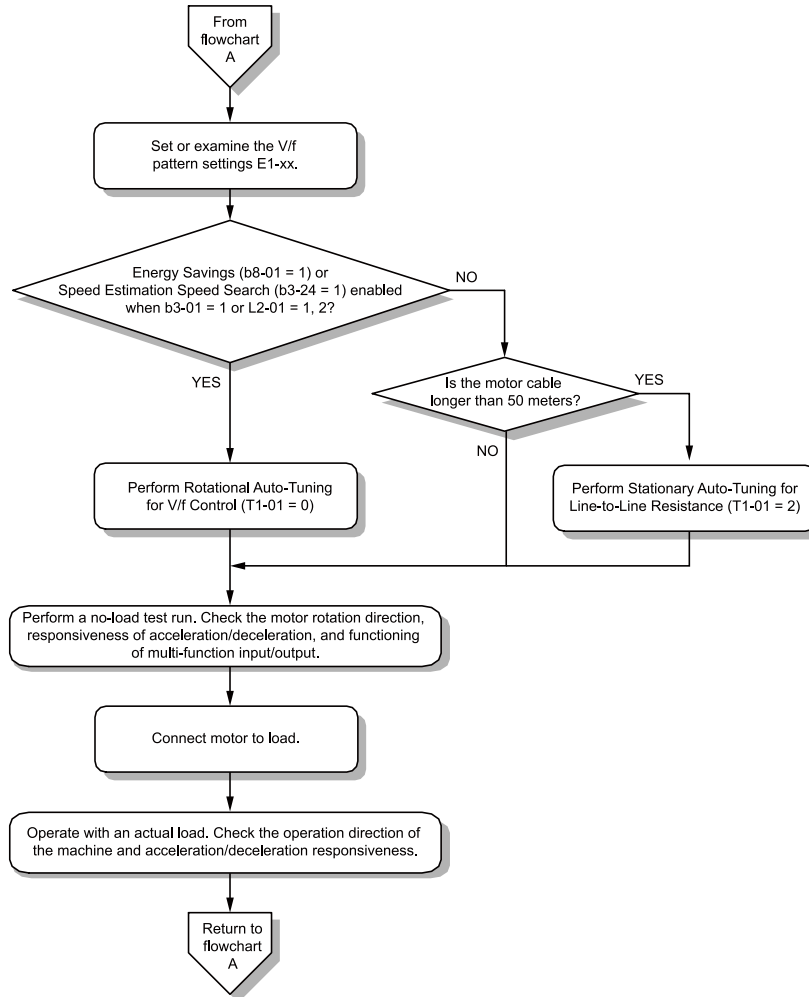
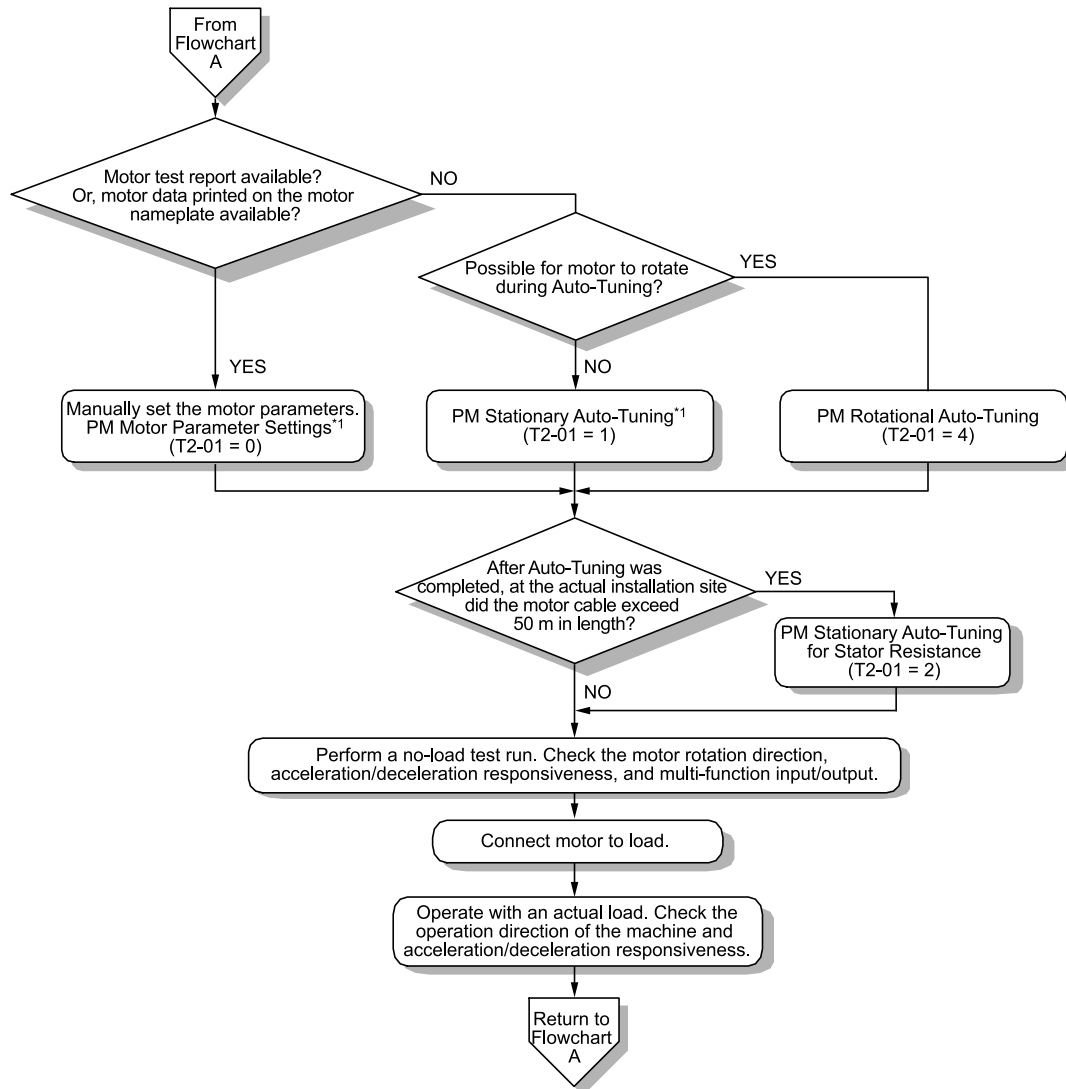

Figure 4.9 Induction Motor Auto-Tuning and Test Run Procedure

### ◆ Sub-Chart A-2: PM Motor Auto-Tuning and Test Run Procedure

Sub-Chart A-2 gives the basic steps to start up the drive for a PM motor.

**WARNING! Crush Hazard.** Test the system to make sure that the drive operates safely after you wire the drive and set parameters. If you do not test the system, it can cause damage to equipment or serious injury or death.



**Figure 4.10 PM Motor Auto-Tuning and Test Run Procedure**

\*1 For PM motors, set *E5-01 [PM Motor Code Selection] = FFFF*.

### ◆ Subchart A-3: EZ Open Loop Vector Control Test Run Procedure

Subchart A-3 gives the setup procedure to run a PM motor in EZ Open Loop Vector Control.

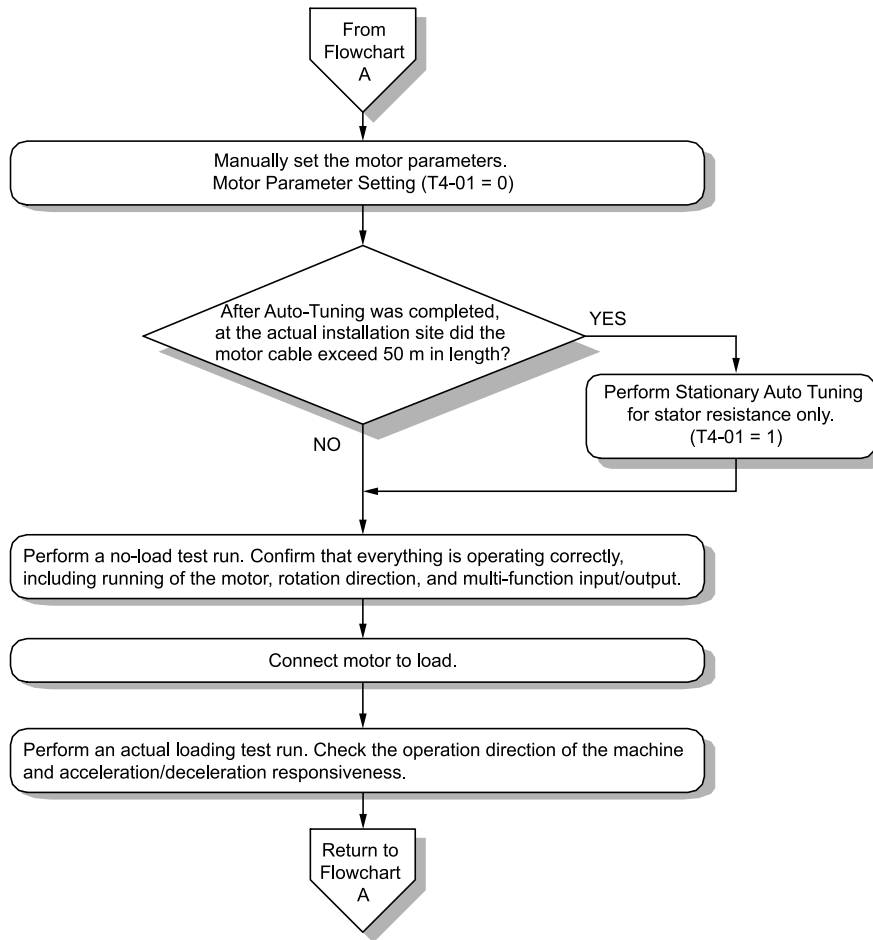

Figure 4.11 Procedure for Test Run of EZ Open Loop Vector Control Method



## 4.6 Items to Check before Starting Up the Drive

### ◆ Check before Energizing the Drive

Examine the items in [Table 4.8](#) before you energize the drive.

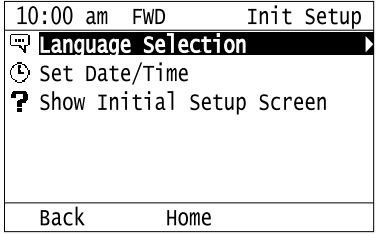
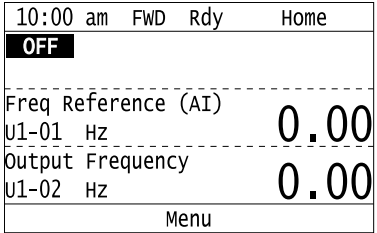
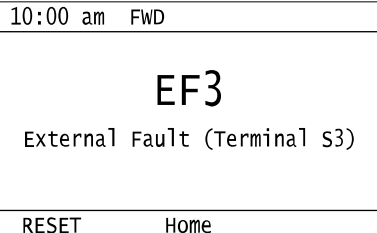



**Table 4.8 Items to Check before Energizing the Drive**

Items to Check	Description
Input Power Supply Voltage	The voltage of the input power supply must be: 208 V class: three-phase 200 Vac to 240 Vac 50/60 Hz, 270 Vdc to 340 Vdc 480 V class: three-phase 380 Vac to 480 Vac 50/60 Hz, 510 Vdc to 680 Vdc
	Correctly and safely wire power supply input terminals R/L1, S/L2, T/L3 (use terminals +1 and - for DC power supply input).
	Correctly ground the drive and motor.
Connection between Drive Output Terminals and Motor Terminals	Make sure that you connected drive output terminals U/T1, V/T2, and W/T3 in the correct sequence to agree with motor terminals U, V, and W without loosened screws.
Control Circuit Terminal Wiring	Make sure that you connected the drive control circuit terminals in the correct sequence to agree with devices and switches without loosened screws.
Control Circuit Terminal Status	Turn OFF the inputs from all devices and switches connected to the drive control circuit terminals.
Connection between Machinery and Motor	Disengage all couplings and belts that connect the motor and machinery.

### ◆ Check after Energizing the Drive

Examine the items in [Table 4.9](#) after you energize the drive. The keypad will show these screens depending on the drive status.

**Table 4.9 Display Status after Energizing the Drive**

Status	Display	Description
During Usual Operation	 <p>Initial Setup Screen or</p>  <p>HOME Screen</p>	<ul style="list-style-type: none"> <li>The data display area will show the Initial Setup screen or the HOME screen</li> <li>Energize the drive with factory defaults to show the Initial Setup screen. Select [No] from the [Show Initial Setup Screen] settings to show the HOME screen without showing the Initial Setup screen.</li> </ul>
When the Drive Detects a Fault		<p>The display changes depending on the fault. Refer to "Troubleshooting" to remove the cause of the fault.  will illuminate.</p> <p><b>Note:</b> If the screen shows a different screen, do these steps to show the fault content again:</p> <ol style="list-style-type: none"> <li>Push  from the HOME screen.</li> <li>Push  (Home) from a different screen than the HOME screen.</li> </ol>

## 4.6 Items to Check before Starting Up the Drive

### Note:

Make sure that you use a keypad with FLASH number 1004 or later. Keypads with FLASH numbers 1003 and earlier will not show characters correctly.

## ◆ Make the Initial Settings

The keypad will show the Initial Setup screen when you energize the drive for the first time. You can set the date and time or the language to show on the keypad.

### Note:

If the keypad does not show the Initial Setup screen, select [Initial Setup] from the Main Menu to show the Initial Setup screen.

1. Make the initial settings for each item.

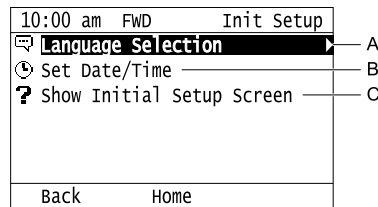

**A - Language Selection**

**C - Show Initial Setup Screen**

**B - Set Date/Time**

### Note:

If you select [Yes] from the [Show Initial Setup Screen] setting, the keypad will show the Initial Setup screen each time the drive is energized.

If you select [NO], the keypad will not show the Initial Setup screen each time the drive is energized, starting with the next time.

2. Push **F2** (Home).

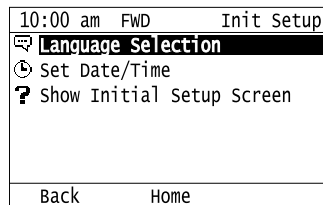

The display shows the HOME screen.

## 4.7 Keypad Operation

### Note:

Make sure that you use a keypad with FLASH number 1004 or later. Keypads with FLASH numbers 1003 and earlier will not show characters correctly.

### ◆ Home Screen Display Selection

This section gives information about the functions that you can control from the HOME screen and the content shown on the HOME screen.



10:00 am	FWD	Rdy	Home
OFF			
-----			
Freq Reference (AI)			
U1-01	Hz	0.00	
Output Frequency			
U1-02	Hz	0.00	
Menu			

### ■ View Monitors Shown in Home Screen

This figure shows monitor data in the data display area of the HOME screen.

10:00 am	FWD	Rdy	Home
OFF			
-----			
Freq Reference (AI)			
U1-01	Hz	0.00	
Output Frequency			
U1-02	Hz	0.00	
Menu			



Monitor

- To change what the screen shows, change the setting for *o1-40* [*Home Screen Display Selection*].
- When *o1-40* = 0 [*Custom Monitor*], and there is more than one screen, use  or  to switch between screens.







### ■ Show the Standard Monitor

Push  to show the standard monitor (*Ux-xx*). Push  (Home) to go back to the HOME screen.

### Note:

When a fault, minor fault, or an error occurs, push  to show the content of the fault. Push  again to show the standard monitor (*Ux-xx*).



### ■ Change the Frequency Reference Value

1. Push  to access the screen to change the frequency.
2. Push  or  to select the digit, then push  or  to change the value.
3. Push  to keep the changes.

### Note:

The HOME screen must show *U1-01* [*Frequency Reference*] or you must set *b1-01* = 0 [*Frequency Reference Selection 1 = Keypad*] to use this function.

### ■ Show the Main Menu

Push  to show the main menu. Push  (Home) to go back to the HOME screen.

10:00 am	FWD	Rdy	Menu
Monitors			
Parameters			
User Custom Parameters			
Parameter Backup/Restore			
Modified Param / Fault Log			
Auto-Tuning			
Home			

## ◆ Show the Monitors

This section shows how to show the standard monitors (*Ux-xx*).

1. Push **F2** (Home) to show the HOME screen.

**Note:**

- When the drive is in HOME Mode, the screen shows [Home] in the upper right-hand corner of the screen.
- If the screen does not show [Home] for **F2**, push **F1** (Back), and then push **F2** to show [Home].

2. Push **F2** (Menu).

10:00 am FWD Rdy Home	
<b>OFF</b>	
-----	
Freq Reference (AI)	0.00
U1-01 Hz	
Output Frequency	0.00
U1-02 Hz	
Menu	

3. Push **▲** or **▼** to select [Monitors], then push **↵**.

10:00 am FWD Rdy Menu
<b>Monitors</b>
Parameters
User Custom Parameters
Parameter Backup/Restore
Modified Param / Fault Log
Auto-Tuning
Home

4. Push **▲** or **▼** to select [Standard Monitor], then push **↵**.

10:00 am FWD Rdy Monitor
<b>Standard Monitor</b>
Custom Monitor
Bar Graph
Analog Gauge
Trend Plot
Back Home

5. Push **▲** or **▼** to select the monitor group, then push **↵**.

10:00 am FWD Rdy Monitor
<b>U1 Operation Status Monitors</b>
U2 Fault Trace
U3 Fault History
U4 Maintenance Monitors
U5 PID Monitors
U6 Operation Status Monitors
Back Home

6. Push **▲** or **▼** to change the monitor number to show the monitor item.

**Note:**

Push **←** to go back to the previous page.

10:00 am FWD Rdy Monitor	
Terminal A1 Level	0.00
U1-13 %	
Terminal A2 Level	0.00
U1-14 %	
SFS Output Frequency	0.00
U1-16 %	
Home	

## ◆ Set Custom Monitors

You can select and register a maximum of 12 monitoring items to regularly show on the keypad. This procedure shows how to set the motor speed to [Custom Monitor 1].

1. Push **F2** (Home) to show the HOME screen.

**Note:**

- The keypad will show [Home] in the top right corner when the HOME screen is active.
- If the keypad does not show [Home] on **F2**, push **F1** (Back) to show [Home] on **F2**.

2. Push **F2** (Menu).

10:00 am	FWD	Rdy	Home
<b>OFF</b>			
-----			
Freq Reference (AI)			0.00
U1-01	Hz		
Output Frequency			0.00
U1-02	Hz		
Menu			

3. Push **▲** or **▼** to select [Monitors], then push **↵**.

10:00 am	FWD	Rdy	Menu
<b>Monitors</b>			
Parameters			
User Custom Parameters			
Parameter Backup/Restore			
Modified Param / Fault Log			
Auto-Tuning			
Home			

4. Push **▲** or **▼** to select [Custom Monitor], then push **F3** (Setup).

10:00 am	FWD	Rdy	Monitor
Standard Monitor			
<b>Custom Monitor</b>			
Bar Graph			
Analog Gauge			
Trend Plot			
Back		Home Setup	

5. Push **▲** or **▼** to select [Custom Monitor 1], then push **↵**.

10:00 am	FWD		Setup
<b>Custom Monitor 1</b>			
Custom Monitor 2			
Custom Monitor 3			
Custom Monitor 4			
Custom Monitor 5			
Custom Monitor 6			
Back		Home	

6. Push **▲** or **▼** to select the monitor number to register, then push **↵**.

Set the x-xx part of monitor *Ux-xx*. For example, to show monitor *U1-05*, set it to "105" as shown in this figure.

10:00 am	FWD		Parameters
Custom Monitor 1			
01-24		<b>105</b>	
Motor Speed			
Default : 101			
Back		Default	

The configuration procedure is complete.

### ◆ Show Custom Monitors

The procedure in this section shows how to show the registered custom monitors.

1. Push **F2** (Home) to show the HOME screen.

**Note:**

- The keypad will show [Home] in the top right corner when the HOME screen is active.
- If [Home] is not shown on **F2**, push **F1** (Back) to show [Home] on **F2**.

2. Push **F2** (Menu).

10:00 am FWD Rdy Home	
<b>OFF</b>	
-----	
Freq Reference (AI)	0.00
U1-01 Hz	
Output Frequency	0.00
U1-02 Hz	
Menu	

3. Push **▲** or **▼** to select [Monitors], then push **↵**.

10:00 am FWD Rdy Menu	
<b>Monitors</b>	▶
Parameters	
User Custom Parameters	
Parameter Backup/Restore	
Modified Param / Fault Log	
Auto-Tuning	
Home	

4. Push **▲** or **▼** to select [Custom Monitor], then push **↵**.

10:00 am FWD Rdy Monitor	
Standard Monitor	
<b>Custom Monitor</b>	▶
Bar Graph	
Analog Gauge	
Trend Plot	
Back	Home Setup

The keypad shows the selected monitor as shown in this figure.

10:00 am FWD Rdy Monitor	
Motor Speed	20.00
U1-05 Hz	
Output Power	15.0
U1-08 kw	
Terminal A1 Level	30.0
U1-13 %	
Home	

- When there are a minimum of two screens, push **▲** or **▼** to switch between screens.
- If you registered only one custom monitor to [Custom Monitor 1], the screen will show only one monitor. If you registered custom monitors only to [Custom Monitor 1] and [Custom Monitor 2], the screen will show only two monitors.

### ◆ Set the Monitors to Show as a Bar Graph

The procedure in this section shows how to show the frequency reference monitor as a bar graph.

1. Push **F2** (Home) to show the HOME screen.

**Note:**

- The keypad will show [Home] in the top right corner when the HOME screen is active.
- If [Home] is not shown on **F2**, push **F1** (Back) to show [Home] on **F2**.

2. Push **F2** (Menu).

10:00 am	FWD	Rdy	Home
<b>OFF</b>			
-----			
Freq Reference (AI)		0.00	
U1-01	Hz		
Output Frequency		0.00	
U1-02	Hz		
Menu			

3. Push **▲** or **▼** to select [Monitors], then push **↵**.

10:00 am	FWD	Rdy	Menu
<b>Monitors</b>			
Parameters			
User Custom Parameters			
Parameter Backup/Restore			
Modified Param / Fault Log			
Auto-Tuning			
Home			

4. Push **▲** or **▼** to select [Bar Graph], then push **F3** (Setup).

10:00 am	FWD	Rdy	Monitor
Standard Monitor			
Custom Monitor			
<b>Bar Graph</b>			
Analog Gauge			
Trend Plot			
Back Home Setup			

5. Push **▲** or **▼** to select the location to store the monitor, then push **↵**.

10:00 am	FWD	Setup
<b>Custom Monitor 1</b>		
Custom Monitor 2		
Custom Monitor 3		
Back Home		

6. Push **↵**.

10:00 am	FWD	Setup
Custom Monitor 1		
<b>Custom Monitor 1</b>		
o1-24	101	(101)
1st Monitor Area Selection		
o1-41	0	(0)
Back Home		

7. Push **▲** or **▼** to select the monitor number to register, then push **↵**.

Enter the three digits in "x-xx" part of monitor  $U_x\text{-xx}$  to identify which monitor to output. For example, to show monitor U1-01 [Frequency Reference], set it to "101" as shown in this figure.

10:00 am	FWD	Parameters
Custom Monitor 1		
o1-24	<b>101</b>	
Frequency Reference		
Default : 101		
Back Default		

The configuration procedure is complete.

### ◆ Show Monitors as Bar Graphs

The procedure in this section shows how to show a specific monitor as a bar graph. You can show a maximum of three.

1. Push **F2** (Home) to show the HOME screen.

**Note:**

- When the drive is in HOME Mode, the screen shows [Home] in the upper right-hand corner of the screen.
- If the screen does not show [Home] for **F2**, push **F1** (Back), and then push **F2** to show [Home].

2. Push **F2** (Menu).

10:00 am	FWD	Rdy	Home
<b>OFF</b>			
-----			
Freq Reference (AI)			0.00
U1-01	Hz		
Output Frequency			0.00
U1-02	Hz		
Menu			

3. Push **▲** or **▼** to select [Monitors], then push **↵**.

10:00 am	FWD	Rdy	Menu
<b>Monitors</b>			
Parameters			
User Custom Parameters			
Parameter Backup/Restore			
Modified Param / Fault Log			
Auto-Tuning			
Home			

4. Push **▲** or **▼** to select [Display Bar Graph], then push **↵**.

10:00 am	FWD	Rdy	Monitor
Standard Monitor			
Custom Monitor			
<b>Bar Graph</b>			
Analog Gauge			
Trend Plot			
Back Home Setup			

The screen will show the monitors as shown in this figure.

10:00 am	FWD	Rdy	Monitor
U1-01			
	-100%	30.00Hz	100%
U1-02			
	-100%	30.00Hz	100%
U1-03			
	-100%	3.00A	100%
Home			

### ◆ Set the Monitors to Show as Analog Gauges

The procedure in this section shows how to show the frequency reference monitor as an analog gauge.

1. Push **F2** (Home) to show the HOME screen.

**Note:**

- The keypad will show [Home] in the top right corner when the HOME screen is active.
- If [Home] is not shown on **F2**, push **F1** (Back) to show [Home] on **F2**.



2. Push **F2** (Menu).

10:00 am	FWD	Rdy	Home
<b>OFF</b>			
-----			
Freq Reference (AI)		0.00	
U1-01	Hz		
Output Frequency		0.00	
U1-02	Hz		
Menu			

3. Push **▲** or **▼** to select [Monitors], then push **↵**.

10:00 am	FWD	Rdy	Menu
<b>Monitors</b>			
Parameters			
User Custom Parameters			
Parameter Backup/Restore			
Modified Param / Fault Log			
Auto-Tuning			
Home			

4. Push **▲** or **▼** to select [Analog Gauge], then push **F3** (Setup).

10:00 am	FWD	Rdy	Monitor
Standard Monitor			
Custom Monitor			
Bar Graph			
<b>Analog Gauge</b>			
Trend Plot			
Back Home Setup			

5. Push **↵**.

10:00 am	FWD	Setup	
Analog Gauge			
<b>Custom Monitor 1</b>			
o1-24	101	(101)	
Analog Gauge Area Selection			
o1-55	1	(1)	
Back Home			

6. Push **▲** or **▼** to select the monitor number to register, then push **↵**.

Enter the three digits in "x-xx" part of monitor *Ux-xx* to identify which monitor to output. For example, to show monitor *U1-01* [Frequency Reference], set it to "101" as shown in this figure.

10:00 am	FWD	Parameters	
Custom Monitor 1			
o1-24	<b>101</b>		
Frequency Reference			
Default : 101			
Back Default			

The configuration procedure is complete.

## ◆ Show Monitors as an Analog Gauge

The following explains how to display the contents selected for a monitor as an analog gauge.

1. Push **F2** (Home) to show the HOME screen.

### Note:

- The keypad will show [Home] in the top right corner when the HOME screen is active.
- If [Home] is not on **F2**, push **F1** (Back) to show [Home] on **F2**.

2. Push **F2** (Menu).

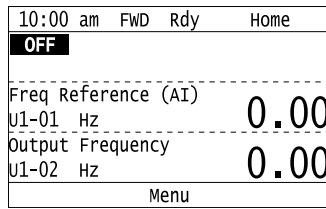

3. Push **▲** or **▼** to select [Monitors], then push **↵**.

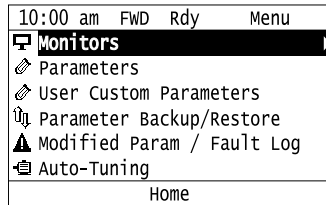

4. Push **▲** or **▼** to select [Analog Gauge], then push **↵**.

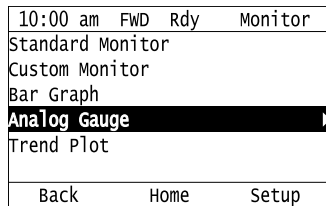

It will be displayed as follows.

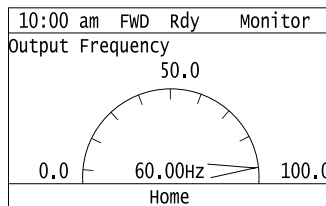

### ◆ Set Monitor Items to Show as a Trend Plot

You must set the items in this figure to display as a trend plot.

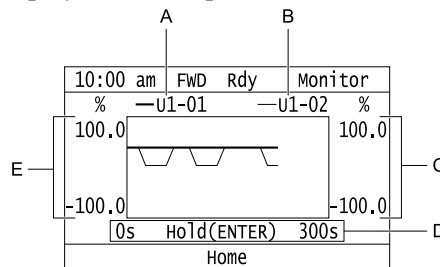

- A - Monitor Parameter 1 (set with [Custom Monitor 1])
- B - Monitor Parameter 2 (set with [Custom Monitor 2])
- C - Trend Plot 2 Scale Maximum/Minimum Value
- D - Trend Plot Time Scale
- E - Trend Plot 1 Scale Maximum/Minimum Value

### ■ Select Monitor Items to Show as a Trend Plot

The procedure in this section shows how to show the frequency reference monitor as a trend plot.

1. Push **F2** (Home) to show the HOME screen.

**Note:**

- The keypad will show [Home] in the top right corner when the HOME screen is active.
- If [Home] is not shown on **F2**, push **F1** (Back) to show [Home] on **F2**.

2. Push **F2** (Menu).

10:00 am	FWD	Rdy	Home
<b>OFF</b>			
-----			
Freq Reference (AI)		0.00	
U1-01	Hz		
Output Frequency		0.00	
U1-02	Hz		
Menu			

3. Push **▲** or **▼** to select [Monitors], then push **↵**.

10:00 am	FWD	Rdy	Menu
<b>Monitors</b>			
Parameters			
User Custom Parameters			
Parameter Backup/Restore			
Modified Param / Fault Log			
Auto-Tuning			
Home			

4. Push **▲** or **▼** to select [Trend Plot], then push **F3** (Setup).

10:00 am	FWD	Rdy	Monitor
Standard Monitor			
Custom Monitor			
Bar Graph			
Analog Gauge			
<b>Trend Plot</b>			
Back Home Setup			

5. Push **▲** or **▼** to select [Custom Monitor 1], then push **↵**.

10:00 am	FWD	Setup	
<b>Custom Monitor 1</b>			
Custom Monitor 2			
Trend Plot Time Scale Setting			
Back Home			

6. Push **↵**.

10:00 am	FWD	Setup	
Custom Monitor 1			
<b>Custom Monitor 1</b>			
o1-24	101	(101)	
Trend Plot 1 Scale Minimum Value			
o1-47	-100.0	(-100.0)%	
Back Home			

7. Push **▲** or **▼** to select the monitor number to register, then push **↵**.

When the *U parameters* are on the display as “Ux-xx”, the three digits in “x-xx” identify which monitor to output. For example, to show monitor U1-01 [Frequency Reference], set it to “101” as shown in this figure.

10:00 am FWD	Parameters
Custom Monitor 1	
o1-24	<b>101</b>
Frequency Reference	
Default : 101	
Back	Default

8. Push or to select [Trend Plot 1 Scale Minimum Value], then push .

10:00 am FWD	Setup
Custom Monitor 1	
<b>Trend Plot 1 Scale Minimum Value</b>	
o1-47	<b>-100.0 (-100.0)%</b>
Trend Plot 1 Scale Maximum Value	
o1-48	100.0 ( 100.0)%
Back	Home

9. Push or to select the specified digit, then push or to select the correct number.

10:00 am FWD	Parameters
Trend Plot 1 Scale Minimum Value	
o1-47	<b>-100.0 %</b>
Default : -100.0%	
Range : -300.0~ 99.9	
Back	Default Min/Max

- Push (Default) to set the parameters to the factory default.
- Push (Min/Max) to move between the minimum value and maximum value.

10. Push to keep the changes.

10:00 am FWD	Parameters
Trend Plot 1 Scale Minimum Value	
o1-47	<b>0020.0 %</b>
Default : -100.0%	
Range : -300.0~ 99.9	
Back	Default Min/Max

11. Push or to select [Trend Plot 1 Scale Maximum Value], then push .

10:00 am FWD	Setup
Custom Monitor 1	
Trend Plot 1 Scale Minimum Value	
o1-47	20.0 (-100.0)%
<b>Trend Plot 1 Scale Maximum Value</b>	
o1-48	<b>100.0 ( 100.0)%</b>
Back	Home

12. Push or to select the specified digit, then push or to select the correct number.

10:00 am FWD	Parameters
Trend Plot 1 Scale Maximum Value	
o1-48	<b>0100.0 %</b>
Default : 100.0%	
Range : 20.1~ 300.0	
Back	Default Min/Max

- Push (Default) to set the parameters to the factory default.
- Push (Min/Max) to move between the minimum value and maximum value.

13. Push  to keep the changes.

10:00 am	FWD	Parameters
Trend Plot 1 Scale Maximum Value		
01-48	0080.0	%
Default : 100.0%		
Range : 20.1~ 300.0		
Back	Default	Min/Max

14. Push  (Back).



If necessary, use the same procedure to set [Custom Monitor 2].

## ■ Set the Time Scale for the Trend Plot Monitor

The procedure in this section shows how to set the time scale for the trend plot monitor.

1. Push  (Home) to show the HOME screen.







### Note:

- The keypad will show [Home] in the top right corner when the HOME screen is active.
- If [Home] is not shown on , push  (Back) to show [Home] on .

2. Push  (Menu).

10:00 am	FWD	Rdy	Home
<b>OFF</b>			
-----			
Freq Reference (AI)			
U1-01 Hz	0.00		
-----			
Output Frequency			
U1-02 Hz	0.00		
-----			
Menu			

3. Push  or  to select [Monitors], then push .

10:00 am	FWD	Rdy	Menu
 <b>Monitors</b> ▶			
 Parameters			
 User Custom Parameters			
 Parameter Backup/Restore			
 Modified Param / Fault Log			
 Auto-Tuning			
-----			
Home			

4. Push  or  to select [Trend Plot], then push  (Setup).

10:00 am	FWD	Rdy	Monitor
Standard Monitor			
Custom Monitor			
Bar Graph			
Analog Gauge			
<b>Trend Plot</b> ▶			
-----			
Back	Home	Setup	

5. Push  or  to select [Trend Plot Time Scale Setting], then push .

10:00 am	FWD	Setup
1st Monitor Setting		
2nd Monitor Setting		
<b>Trend Plot Time Scale Setting</b> ▶		
-----		
Back	Home	

6. Push or to select the specified digit, then push or to select the correct number.

10:00 am	FWD	Parameters
Trend Plot Time Scale Setting		
01-51	<b>0</b> 300	sec
Default : 300sec		
Range : 1~3600		
Back	Default	Min/Max

- Push (Default) to set the parameters to the factory default.
- Push (Min/Max) to move between the minimum value and maximum value.

7. Push to keep the changes.

10:00 am	FWD	Parameters
Trend Plot Time Scale Setting		
01-51	<b>1</b> 300	sec
Default : 300sec		
Range : 1~3600		
Back	Default	Min/Max

The configuration procedure is complete.

### ◆ Show Monitor Items as a Trend Plot

The procedure in this section shows how to show the selected monitor data as a trend plot.

1. Push (Home) to show the HOME screen.

**Note:**

- The keypad will show [Home] in the top right corner when the HOME screen is active.
- If [Home] is not shown on , push (Back) to show [Home] on .

2. Push (Menu).

10:00 am	FWD	Rdy	Home
<b>OFF</b>			
-----			
Freq Reference (AI)		0.00	
U1-01 Hz		-----	
Output Frequency		0.00	
U1-02 Hz		-----	
Menu			

3. Push or to select [Monitors], then push .

10:00 am	FWD	Rdy	Menu
<b>Monitors</b> ▶			
Parameters			
User Custom Parameters			
Parameter Backup/Restore			
Modified Param / Fault Log			
Auto-Tuning			
Home			

4. Push or to select [Trend Plot], then push .

10:00 am	FWD	Rdy	Monitor
Standard Monitor			
Custom Monitor			
Bar Graph			
Analog Gauge			
<b>Trend Plot</b> ▶			
-----			
Back	Home	Setup	

The screen will show the monitors as shown in this figure.

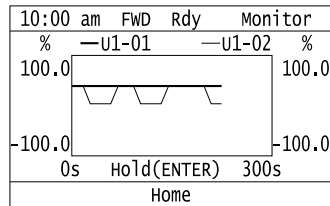
**Note:**

Push (Hold) to switch between Pause and Restart for the monitor display. The “Hold (ENTER)” message flashes while you pause monitoring.

## ◆ Change Parameter Settings

This example shows how to change the setting value for *C1-01 [Acceleration Time 1]*. Do the steps in this procedure to set parameters for the application.

1. Push (Home) to show the HOME screen.

**Note:**

- When the drive is in HOME Mode, the screen shows [Home] in the upper right-hand corner of the screen.
- If [Home] is not shown above the , push (Back).

2. Push (Menu).

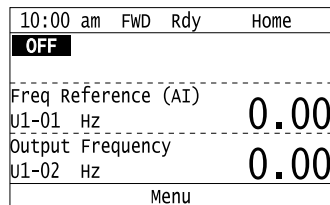

3. Push or to select [Parameters], then push .

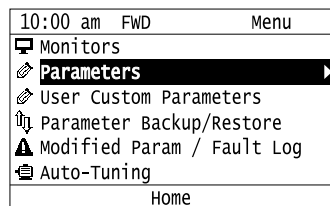

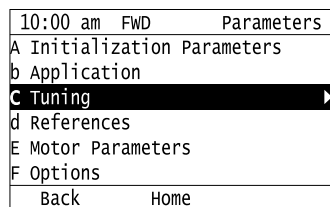

4. Push or to select [C Tuning], then push .



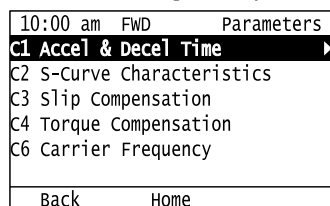



5. Push or to select [C1 Accel & Decel Time], then push .





6. Push  or  to select C1-01, then push .

10:00 am	FWD	Parameters
<b>Acceleration Time 1</b>		
C1-01	30.0	(30.0)sec
Deceleration Time 1		
C1-02	30.0	(30.0)sec
Acceleration Time 2		
C1-03	30.0	(30.0)sec
Back	Home	



7. Push  or  to select the specified digit, then push  or  to select the correct number.

10:00 am	FWD	Parameters
Acceleration Time 1		
C1-01		
	<b>00</b>	<b>30.0 sec</b>
Default : 30.0sec		
Range : 0.1~6000.0		
Back	Default	Min/Max

- Push  (Default) to set the parameters to factory defaults.
- Push  (Min/Max) to show the minimum value or the maximum value on the display.

8. Push  to keep the changes.

10:00 am	FWD	Parameters
Acceleration Time 1		
C1-01		
	<b>00</b>	<b>20.0 sec</b>
Default : 30.0sec		
Range : 0.1~6000.0		
Back	Default	Min/Max

9. Continue to change parameters, then push  (Back),  (Home) to go back to the home screen after you change all the applicable parameters.

## ◆ Examine User Custom Parameters



The User Custom Parameters show the parameters set in A2-01 to A2-32 [User Parameter 1 to User Parameter 32] to let you quickly access and change settings to these parameters.

**Note:**

The User Custom Parameters always show A1-06 [Application Selection] at the top of the list. The A2-01 to A2-32 settings change when the A1-06 setting changes, which makes it easier to set and reference the necessary parameter settings.

1. Push  (Home) to show the HOME screen.

**Note:**

- The keypad will show [Home] in the top right corner when the HOME screen is active.
- If [Home] is not shown on , push  (Back) to show [Home] on .



2. Push  (Menu).

10:00 am	FWD	Rdy	Home
<b>OFF</b>			
-----			
Freq Reference (AI)			
U1-01	Hz	0.00	
Output Frequency			
U1-02	Hz	0.00	
Menu			



3. Push  or  to select [User Custom Parameters], then push .





10:00 am FWD	Menu
Monitors	
Parameters	
<b>User Custom Parameters</b>	
Parameter Backup/Restore	
Modified Param / Fault Log	
Auto-Tuning	
Home	

4. Push  or  to show the parameter to examine.

10:00 am FWD	Parameters
Application Preset	
<b>A1-06</b>	<b>0 (0)</b>
Control Method Selection	
A1-02	0 (0)
Frequency Reference Selection 1	
b1-01	1 (1)
Back	Home

5. To change the parameter settings, push  or  to select the parameter, then push .

10:00 am FWD	Parameters
Application Preset	
A1-06	0 (0)
<b>Control Method Selection</b>	
<b>A1-02</b>	<b>0 (0)</b>
Frequency Reference Selection 1	
b1-01	1 (1)
Back	Home

6. Push  or  to select the digit, then push  or  to change the value.

10:00 am FWD	Parameters
Control Method Selection	
A1-02	<b>0</b>
V/f Control	
Default : 0	
Back	Default

7. Change the value, push .

10:00 am FWD	Parameters
Control Method Selection	
A1-02	<b>5</b>
PM Open Loop Vector	
Default : 0	
Back	Default

The parameter setting procedure is complete.

## ◆ Save a Backup of Parameters

You can save a backup of the drive parameters to the keypad. The keypad can store parameter setting values for a maximum of four drives in different storage areas. Backups of the parameter settings can save time when you set parameters after you replace a drive. When you set up more than one drive, you can copy the parameter settings from a drive that completed a test run to the other drives.

### Note:

- Stop the motor before you back up parameters.
- The drive will not accept a Run command while it makes a backup.
- The DriveWorksEZ PC software password is necessary to back up *qx-xx* [DriveWorksEZ Parameter] and *rx-xx* [DWEZ Connection Parameter]. If you enter an incorrect password, the drive detects *PWEr* [DWEZ Password Mismatch].

## 4.7 Keypad Operation

1. Push **F2** (Home) to show the HOME screen.

**Note:**

- When the drive is in HOME Mode, the screen shows [Home] in the upper right-hand corner of the screen.
- If the screen does not show [Home] for **F2**, push **F1** (Back), and then push **F2** to show [Home].

2. Push **F2** (Menu).

10:00 am FWD Rdy Home	
<b>OFF</b>	
-----	
Freq Reference (AI)	
U1-01 Hz	0.00
Output Frequency	
U1-02 Hz	0.00
-----	
Menu	

3. Push **▲** or **▼** to select [Parameter Backup/Restore], then push **↵**.

10:00 am FWD Menu
Monitors
Parameters
User Custom Parameters
<b>Parameter Backup/Restore</b>
Modified Param / Fault Log
Auto-Tuning
Home

4. Push **▲** or **▼** to select the items to back up, then push **↵**.

10:00 am FWD Backup
Select Items to Backup/Restore
<b>Standard Parameters</b>
Back Home

5. Push **▲** or **▼** to select [Backup (drive → keypad)], then push **↵**.

10:00 am FWD Backup
Select Desired Action
<b>Backup (drive → keypad)</b>
Restore (keypad → drive)
Verify (check for mismatch)
Erase (backup data of keypad)
Back Home

6. Push **▲** or **▼** to select a memory location, then push **↵**.

10:00 am FWD Backup
Select Backup/Restore Location
<b>#1 No Data</b>
#2 No Data
#3 No Data
#4 No Data
Back Home

The keypad shows “End” when the backup procedure completes successfully.

### ◆ Write Backed-up Parameters to the Drive

You can back up parameters on the keypad and write them to different drives.

**Note:**

- Always stop the drive before you start to restore the parameter backups.
- The drive will not accept a Run command while it restores parameters.

1. Push **F2** (Home) to show the HOME screen.

**Note:**

- When the drive is in HOME Mode, the screen shows [Home] in the upper right-hand corner of the screen.
- If the screen does not show [Home] for **F2**, push **F1** (Back), and then push **F2** to show [Home].

2. Push **F2** (Menu).

10:00 am	FWD	Rdy	Home
<b>OFF</b>			
-----			
Freq Reference (AI)			0.00
U1-01	Hz		
Output Frequency			0.00
U1-02	Hz		
-----			
Menu			

3. Push **▲** or **▼** to select [Parameter Backup/Restore], then push **↵**.

10:00 am	FWD		Menu
Monitors			
Parameters			
User Custom Parameters			
<b>Parameter Backup/Restore</b>			<b>▶</b>
Modified Param / Fault Log			
Auto-Tuning			
-----			
Home			

4. Push **▲** or **▼** to select the item to restore, then push **↵**.

10:00 am	FWD		Backup
Select Items to Backup/Restore			
<b>Standard Parameters</b>			<b>▶</b>
-----			
Back Home			

5. Push **▲** or **▼** to select [Restore (keypad → drive)], then push **↵**.

10:00 am	FWD		Backup
Select Desired Action			
-----			
Backup (drive → keypad)			
<b>Restore (keypad → drive)</b>			<b>▶</b>
Verify (check for mismatch)			
Erase (backup data of keypad)			
-----			
Back Home			

6. Push **▲** or **▼** to select the backed-up parameter data, then push **↵**.

10:00 am	FWD		Backup
Select Backup/Restore Location			
<b>#1 2020/01/01 13:00 0-65</b>			<b>▶</b>
#2	No Data		
#3	No Data		
#4	No Data		
-----			
Back Home			

The keypad will show the “End” message when the write process is complete.

## 4.7 Keypad Operation

**Note:**

Different settings and conditions will change the keypad display.

		A	B	C
	10:00 am FWD	Backup		
	Select Backup/Restore Location			
F	#1	2020/01/01 14:10	0-65	▶
	#2	2020/01/01 02:10pm	5-65	*
E	#3	----/--/-- --:--	8-65	*
D	#4	No Data		
	Back		Home	

**A - A1-02 [Control Method Selection] settings**

**D - Parameter backup data is not registered**

**B - o2-04 [Drive Model (KVA) Selection] settings (2 or 3 digits)**

**E - Backup data does not contain the date Information**

**C - Presence of DriveWorksEZ parameter backup**

**F - Backup date**

### ◆ Verify Keypad Parameters and Drive Parameters

This procedure verifies that the parameter setting values that were backed up in the keypad agree with the parameter setting values in the drive.

**Note:**

- Always stop the drive before you start to verify the parameters.
- The drive will not accept a Run command while it verifies parameters.

1. Push **F2** (Home) to show the HOME screen.

**Note:**

- When the drive is in HOME Mode, the screen shows [Home] in the upper right-hand corner of the screen.
- If the screen does not show [Home] for **F2**, push **F1** (Back), and then push **F2** to show [Home].

2. Push **F2** (Menu).

10:00 am FWD Rdy	Home
<b>OFF</b>	
-----	
Freq Reference (AI)	
U1-01 Hz	0.00
Output Frequency	
U1-02 Hz	0.00
Menu	

3. Push **▲** or **▼** to select [Parameter Backup/Restore], then push **↵**.



10:00 am FWD	Menu
Monitors	
Parameters	
User Custom Parameters	
<b>Parameter Backup/Restore</b>	▶
Modified Param / Fault Log	
Auto-Tuning	
Home	

4. Push **▲** or **▼** to select the item to verify, then push **↵**.

10:00 am FWD	Backup
Select Items to Backup/Restore	
<b>Standard Parameters</b>	▶
Back	Home

5. Push  or  to select [Verify (drive → keypad)], then push .

10:00 am	FWD	Backup
Select desired action.		
Backup (drive → keypad)		
Restore (keypad → drive)		
<b>Verify (check for mismatch)</b> ▶		
Erase (backup data of keypad)		
Back	Home	

6. Push  or  to select the data to verify, then push .

10:00 am	FWD	Backup
Select Backup/Restore Location		
<b>#1 2020/01/01 13:00 0-65</b> ▶		
#2 No Data		
#3 No Data		
#4 No Data		
Back	Home	

The keypad shows “End” when the parameter settings backed up in the keypad agree with the parameter settings copied to the drive.

**Note:**



The keypad shows *vFyE [Parameters do not Match]* when the parameter settings backed up in the keypad do not agree with the parameter settings copied to the drive. Push one of the keys to return to the screen in Step 6.

## ◆ Delete Parameters Backed Up to the Keypad

This procedure deletes the parameters that were backed up to the keypad.

1. Push  (Home) to show the HOME screen.

**Note:**

- When the drive is in HOME Mode, the screen shows [Home] in the upper right-hand corner of the screen.
- If the screen does not show [Home] for , push  (Back), and then push  to show [Home].

2. Push  (Menu).

10:00 am	FWD	Rdy	Home
<b>OFF</b>			
-----			
Freq Reference (AI)		0.00	
U1-01	Hz		
Output Frequency		0.00	
U1-02	Hz		
Menu			

3. Push  or  to select [Parameter Backup/Restore], then push .

10:00 am	FWD	Menu
Monitors		
Parameters		
User Custom Parameters		
<b>Parameter Backup/Restore</b> ▶		
Modified Param / Fault Log		
Auto-Tuning		
Home		

4. Push or to select the item to verify, then push .

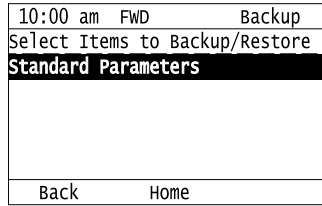

5. Push or to select [Delete (keypad)], then push .

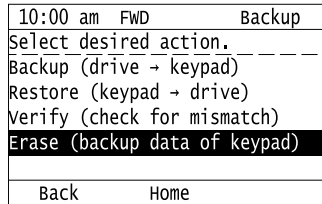

6. Push or to select the data to delete, then push .

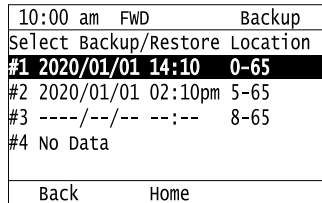

The keypad will show the “End” message when the write process is complete.

## ◆ Checking Modified Parameters

### ■ Modified Parameters Screen Displays

The keypad display for Modified Parameters screen changes when the *A1-06 [Application Preset]* and *A1-07 [DriveWorksEZ Function Selection]* settings change:

A1-06 Settings	A1-07 Settings	Keypad Display	Description
0	0	<p>10:00 am FWD Modified                      User Modified Parameters  <b>Standard:</b> ▶  <b>2 Parameters Modified</b>                      Back Home</p>	When you set <i>A1-06 = 0 [No Preset Selected]</i> and <i>A1-07 = 0 [DWEZ Disabled]</i> , the Modified Parameters screen will only show [Standard].
1 - 8	0	<p>10:00 am FWD Modified                      User Modified Parameters  <b>Standard:</b> ▶  <b>8 Parameters Modified</b>                      Application Presets:                      2 Parameters Modified                      Back Home</p>	When you set an application macro ( <i>A1-06 ≠ 0</i> ), the Modified Parameters screen will show the Standard menu and Application Presets menu. <ul style="list-style-type: none"> <li>Standard: This menu shows all parameters modified by the <i>A1-06</i> setting and any standard drive parameters modified after you changed the <i>A1-06</i> setting.</li> <li>Application Presets: This menu only shows parameters not set by <i>A1-06</i>.</li> </ul>
0 - 8	1	<p>10:00 am FWD Modified                      User Modified Parameters  <b>Application Presets:</b> ▶  <b>2 Parameters Modified</b>                      DWEZ:                      6 Parameters Modified                      Back Home</p>	When <i>A1-07 = 1 [DWEZ Enabled]</i> , the keypad will also show the DWEZ menu selection. If the modified parameters are returned back to Application Preset default, causing the numbers of parameters modified for Application Preset to be 0, the user will be returned back to the User Modified Parameters menu screen with the Standard list selected.

## ■ Check Modified Parameters

This procedure will show all parameters that are not at their default values. This helps find settings have been changed, and is very useful when you replace a drive. This lets you quickly access and re-edit changed parameters. The keypad will show “0 Parameters” when all parameters are at their default values.

1. Push **F2** (Home) to show the HOME screen.

### Note:

- The keypad will show [Home] in the top right corner when the HOME screen is active.
- If [Home] is not shown on **F2**, push **F1** (Back) to show [Home] on **F2**.

2. Push **F2** (Menu).

10:00 am	FWD	Rdy	Home
<b>OFF</b>			
-----			
Freq Reference (AI)			0.00
U1-01	Hz		
Output Frequency			0.00
U1-02	Hz		
-----			
Menu			

3. Push **▲** or **▼** to select [Modified Param / Fault Log], then push **↵**.

10:00 am	FWD	Menu
☰	Monitors	
☞	Parameters	
☞	User Custom Parameters	
☞	Parameter Backup/Restore	
⚠	<b>Modified Param / Fault Log</b>	▶
☞	Auto-Tuning	
-----		
Home		

4. Push **▲** or **▼** to select [Modified Parameters], then push **↵**.

10:00 am	FWD	History
☞	<b>Modified Parameters</b>	▶
⚠	Fault Log	
-----		
Back	Home	

5. Push **↵**.





10:00 am	FWD	Modified
User Modified Parameters		
<b>Standard:</b>		
<b>2 Parameters Modified</b>		
-----		
Back	Home	

6. Push **▲** or **▼** to show the parameter to check.

10:00 am	FWD	Modified
<b>Acceleration Time 1</b>		
<b>c1-01</b>	20.0	(30.0)sec
Motor Rated Current (FLA)		
E2-01	97.2	(77.0)A
-----		
Back	Home	

7. To re-edit a parameter, push  or , select the parameter to edit, then push .

10:00 am	FWD	Modified
<b>Acceleration Time 1</b>		
C1-01	20.0	(30.0)sec
Motor Rated Current (FLA)		
E2-01	97.2	(77.0)A
Back	Home	

8. Push  or  to select the digit, then push  or  to change the value.

10:00 am	FWD	Parameters
Acceleration Time 1		
C1-01	<b>00</b> 20.0	sec
Default : 30.0sec		
Range : 0.1~6000.0		
Back	Default	Min/Max

9. When you are done changing the value, push .

10:00 am	FWD	Parameters
Acceleration Time 1		
C1-01	00 <b>10</b> .0	sec
Default : 30.0sec		
Range : 0.1~6000.0		
Back	Default	Min/Max



The parameter revision procedure is complete.

### ◆ Restore Modified Parameters to Defaults

This procedure will set all parameters with changed values to their default settings.

1. Push  (Home) to show the HOME screen.







**Note:**

- The keypad will show [Home] in the top right corner when the HOME screen is active.
- If [Home] is not shown on , push  (Back) to show [Home] on .

2. Push  (Menu).



10:00 am	FWD	Rdy	Home
<b>OFF</b>			
-----			
Freq Reference (AI)			
U1-01	Hz	0.00	
-----			
Output Frequency			
U1-02	Hz	0.00	
-----			
Menu			

3. Push  or  to select [Modified Param / Fault Log], then push .

10:00 am	FWD	Menu
	Monitors	
	Parameters	
	User Custom Parameters	
	Parameter Backup/Restore	
	<b>Modified Param / Fault Log</b>	
	Auto-Tuning	
-----		
Home		





4. Push  or  to select [Modified Parameters], then push .

10:00 am	FWD	History
	<b>Modified Parameters</b>	
	Fault Log	
Back	Home	

5. Push .

10:00 am	FWD	Modified
User Modified Parameters		
<b>Standard:</b>		
<b>2 Parameters Modified</b>		
Back	Home	

6. Push  or  to select the parameters to return to their default settings, then push .

10:00 am	FWD	Modified
<b>Acceleration Time 1</b>		
C1-01	20.0	(30.0)sec
Motor Rated Current (FLA)		
E2-01	97.2	(77.0)A
Back	Home	

7. Push  (Default).

10:00 am	FWD	Parameters
Acceleration Time 1		
C1-01	<b>0020.0</b>	sec
Default : 30.0sec		
Range : 0.1~6000.0		
Back	Default	Min/Max

8. Push .

10:00 am	FWD	Parameters
Acceleration Time 1		
C1-01	<b>0030.0</b>	sec
Default : 30.0sec		
Range : 0.1~6000.0		
Back	Default	Min/Max

The modified parameters are now set to default values.

## ◆ Show Fault History



You can examine a maximum of 10 fault codes and dates and times that the faults occurred.

**Note:**

- To monitor the date and time of faults, you must first set the date and time on the keypad.
- If the keypad does not have a clock battery, you must set the date and time each time you energize the drive.

1. Push  (Home) to show the HOME screen.

**Note:**

- The keypad will show [Home] in the top right corner when the HOME screen is active.
- If [Home] is not shown on , push  (Back) to show [Home] on .

2. Push **F2** (Menu).

10:00 am FWD Rdy	Home
<b>OFF</b>	
-----	
Freq Reference (AI)	0.00
U1-01 Hz	
Output Frequency	0.00
U1-02 Hz	
Menu	

3. Push **▲** or **▼** to select [Modified Parameters/Fault History], then push **↵**.

10:00 am FWD	Menu
Monitors	
Parameters	
User Custom Parameters	
Parameter Backup/Restore	
<b>▲ Modified Param / Fault Log ▶</b>	
Auto-Tuning	
Home	

4. Push **▲** or **▼** to select [Fault History], then push **↵**.

10:00 am FWD	History
Modified Parameters	
<b>▲ Fault Log ▶</b>	
Back Home	

5. Push **▲** or **▼** to show the fault history you will examine.

10:00 am FWD	History
Fault History Log	
01 ov	2020/01/01 14:00
Overvoltage	
02 oc	2020/01/01 13:00
Overcurrent	
Back Home	

## ◆ Auto-Tuning the Drive

Auto-Tuning uses motor characteristics to automatically set drive parameters.

Refer to the motor nameplate or the motor test report for the necessary information for Auto-Tuning.

VARTISPEED									
3-PHASE PERMANENT MAGNET MOTOR									
TYPE S3T4-					POLES E5-04				
PROTECTION					COOLING				
kW	V	Hz	RATING	A	r/min	r <sub>i</sub>	E5-05		
E5-02	E1-05			E5-03	E1-04,06	Ld	E5-06		
						Lq	E5-07		
						Ke	E5-09		
INS.	COOLANT TEMP.	°C	ALTITUDE	m	Δθ				
STD			MASS	kg	Δθ'				
BRG NO	DRIVE		BPP		Ki				
SER NO	END		END		Kt				
YASKAWA ELECTRIC CORPORATION					JAPAN	Si			

Figure 4.12 Motor Nameplate (Example)

**WARNING! Sudden Movement Hazard.** Before you do Auto-Tuning, remove all personnel and objects from the area around the drive, motor, and load. The drive and motor can start suddenly during Auto-Tuning and cause serious injury or death.

**WARNING! Electrical Shock Hazard.** During Auto-Tuning, the motor will receive high voltage when the motor is stopped. Do not touch the motor until Auto-Tuning is complete. If you touch a motor that is energized, it can cause serious injury or death.

**WARNING! Sudden Movement Hazard.** Before you do Rotational Auto-Tuning, disconnect the load from the motor. The load can move suddenly and cause serious injury or death.

This procedure shows how to do Rotational Auto-Tuning.



1. Push **F2** (Home) to show the HOME screen.







**Note:**

- When the drive is in HOME Mode, the screen shows [Home] in the upper right-hand corner of the screen.
- If the screen does not show [Home] for **F2**, push **F1** (Back), and then push **F2** to show [Home].

2. Push **F2** (Menu).



10:00 am	FWD	Rdy	Home
<b>OFF</b>			
-----			
Freq Reference (AI)			0.00
U1-01	Hz		
Output Frequency			0.00
U1-02	Hz		
Menu			

3. Push  or  to select [Auto-Tuning], then push .

10:00 am	FWD	Menu
 Parameters		
 User Custom Parameters		
 Parameter Backup/Restore		
 Modified Param / Fault Log		
 <b>Auto-Tuning</b>		
 Initial Setup		
Home		





4. Push .

10:00 am	FWD	Auto Tuning
Select Auto-Tuning mode		
<b>Motor Parameter Tuning</b>		
		
Back Home		

5. Push  or  to select [Rotational Auto-Tuning], then push .

10:00 am	FWD	Auto Tuning
Select the Auto-Tuning mode.		
<b>Rotational Auto-Tuning</b>		
		
Stationary Line-Line Resistance		
Back Home		

6. Follow the messages shown on the keypad to input the necessary Auto-Tuning data.

Example: Push  or  to select the specified digit, then push  or  to change the number. Push  to save the change and move to the next entry field.

10:00 am	FWD	Auto Tuning
Enter motor rated power.		
<b>007.50 HP</b>		
Range : 0.00~650.00		
Back Home		

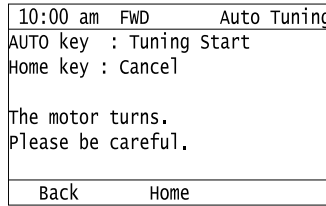

7. Follow the messages shown on the keypad to do the next steps.

8. When the keypad shows the Auto-Tuning start screen, push .





Auto-Tuning starts.

When doing Rotational Auto-Tuning, the motor will stay stopped for approximately one minute with power energized and then the motor will start to rotate.

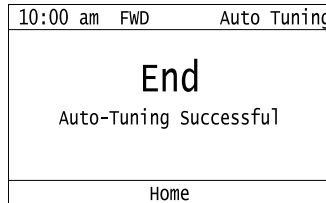

9. When the keypad shows this screen after Auto-Tuning is complete for 1 or 2 minutes, push  or .

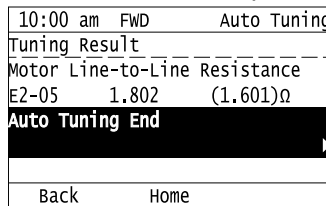

The keypad will show a list of the changed parameters as the result of Auto-Tuning.

10. Push  or  in the parameter change confirmation screen to check the changed parameters, then select [Auto-Tuning Successful] at the bottom of the screen and push .



To change a parameter again, push  or  to select the parameter to change, then push  to show the parameter setting screen.

Auto-Tuning is complete.

**Note:**

If the drive detects an error or you push  before Auto-Tuning is complete, Auto-Tuning will stop and the keypad will show an error code. *Endx* identifies that Auto-Tuning was successful with calculation errors. Find and repair the cause of the error and do Auto-Tuning again, or set the motor parameters manually. You can use the drive in the application if you cannot find the cause of the *Endx* error. *Er-xx* identifies that Auto-Tuning was not successful. Find and repair the cause of the error and do Auto-Tuning again.

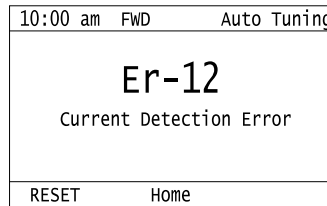
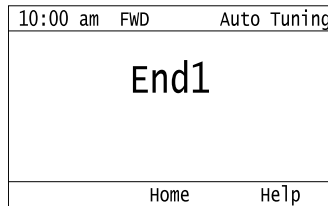



### ◆ Set the Keypad Language Display

The procedure in this section shows how to set the language shown on the keypad.



1. Push  (Home) to show the HOME screen.







**Note:**



- The keypad will show [Home] in the top right corner when the HOME screen is active.
- If [Home] is not shown on , push  (Back), to show [Home] on .



2. Push **F2** (Menu).



10:00 am	FWD	Rdy	Home
<b>OFF</b>			
-----			
Freq Reference (AI)		0.00	
U1-01	Hz		
Output Frequency		0.00	
U1-02	Hz		
Menu			

3. Push  or  to select [Initial Settings], then push .

10:00 am	FWD	Menu	
	User Custom Parameters		
	Parameter Backup/Restore		
	Modified Param / Fault Log		
	Auto-Tuning		
	<b>Initial Setup</b>		
	Diagnostic Tools		
Home			

4. Push  or  to select [Language Selection], then push .

10:00 am	FWD	Init Setup	
	<b>Language Selection</b>		
	Set Date/Time		
	Show Initial Setup Screen		
Back		Home	

5. Push  or  to select the language, then push .

10:00 am	FWD	Rdy	Init Setup
Language Selection			
<b>English</b>			
日本語 (Japanese)			
Deutsch			
Français			
Italiano			
Back		Home	

The procedure to set the keypad language is complete.

## ◆ Set the Date and Time

The procedure in this section shows how to set the date and time.

### Note:

- Refer to [Replace the Keypad Battery on page 411](#) for information about the battery installation procedure. The drive can detect an alarm when the battery dies or when you do not set the clock. Set *o4-24 = 1 [bAT Detection selection = Enable (Alarm Detected)]* to enable this alarm.
- If the keypad does not have a clock battery, you must set the date and time each time you energize the drive.

1. Push **F2** (Home) to show the HOME screen.







### Note:



- The keypad will show [Home] in the top right corner when the HOME screen is active.
- If [Home] is not shown on **F2**, push **F1** (Back) to show [Home] on **F2**.





2. Push **F2** (Menu).



10:00 am	FWD	Rdy	Home
<b>OFF</b>			
-----			
Freq Reference (AI)		0.00	
U1-01	Hz		
Output Frequency		0.00	
U1-02	Hz		
Menu			

3. Push  or  to select [Initial Setup], then push .



10:00 am	FWD	Menu
	User Custom Parameters	
	Parameter Backup/Restore	
	Modified Param / Fault Log	
	Auto-Tuning	
	<b>Initial Setup</b>	
	Diagnostic Tools	
Home		

4. Push  or  to select [Set Date/Time], and push .

10:00 am	FWD	Init Setup
	Language Selection	
	<b>Set Date/Time</b>	
	Show Initial Setup Screen	
Back Home		

5. Push  or  to select the format of date display, then push .

10:00 am	FWD	Init Setup
<b>YYYY/MM/DD</b>	<b>(2020/01/01)</b>	
DD/MM/YYYY	(01/01/2020)	
MM/DD/YYYY	(01/01/2020)	
Back Home		

6. Push  or  to select the format of time display, then push .





10:00 am	FWD	Init Setup
24 Hour Clock	(00:00)	
<b>12 Hour Clock</b>	<b>(12:00 am)</b>	
12 Hour JP Clock	(00:00 am)	
Back Home		

7. Push  or  to select a number from Year/Month/Day, then push  or  to change the value.

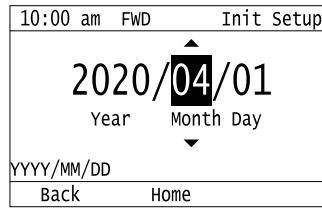
10:00 am	FWD	Init Setup
2020/01/01		
Year Month Day		
YYYY/MM/DD		
Back Home		

8. When you are done changing the value, push .



9. Push  or  to select the hour or minute, then push  or  to change the value.

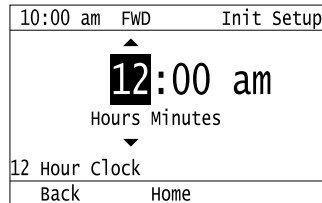

10. When you are done setting the time, push .

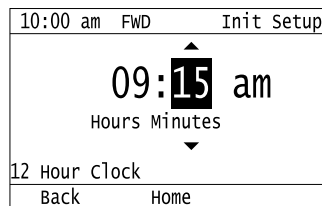



The procedure for setting the date and time is complete.

## ◆ Disable the Initial Setup Screen

Do the steps in this procedure to not show the initial start-up screen when the drive is energized.



1. Push  (Home) to show the HOME screen.

### Note:

- When the drive is in HOME Mode, the screen shows [Home] in the upper right-hand corner of the screen.
- If the screen does not show [Home] for , push  (Back), and then push  to show [Home].

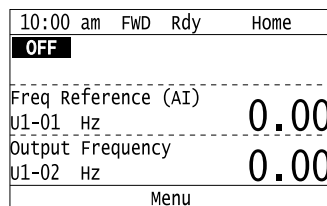
2. Push  (Menu).



3. Push  /  to select [Initial Setup], then push .

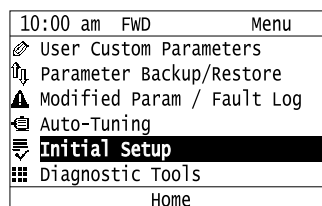

4. Push / to select [Show Initial Setup Screen], then push .

10:00 am	FWD	Init Setup
Language Selection		
Set Date/Time		
<b>Show Initial Setup Screen</b>		
Back	Home	

5. Push / to select [No], then push .

10:00 am	FWD	Init Setup
Show Initial Setup Screen		
No		
<b>Yes</b>		
Back	Home	

- [No]: The keypad will not show the Initial Setup Screen when the drive is energized.
- [Yes]: The keypad will show the Initial Setup Screen when the drive is energized.

### ◆ Start Data Logging

The data log function saves drive status information. Monitors *Ux-xx* are the source of log information. The procedure in this section shows how to start logging data.

You can record a maximum of 10 monitors.

1. Insert a microSD card in the keypad.
2. Push (Home) to show the HOME screen.

**Note:**

- When the drive is in HOME Mode, the screen shows [Home] in the upper right-hand corner of the screen.
- If the screen does not show [Home] for , push (Back), and then push to show [Home].



3. Push (Menu).

10:00 am	FWD	Rdy	Home
<b>OFF</b>			
-----			
Freq Reference (AI)		0.00	
U1-01	Hz		
Output Frequency		0.00	
U1-02	Hz		
-----			
Menu			

4. Push or to select [Diagnostic Tools], then push .

10:00 am	FWD	Menu
User Custom Parameters		
Parameter Backup/Restore		
Modified Param / Fault Log		
Auto-Tuning		
Initial Setup		
<b>Diagnostic Tools</b>		
-----		
Home		



5. Push  or  to select [Data Logger], then push .

10:00 am	FWD	Tools
Data Logger		
Backlight		
Drive Information		
Back	Home	Setup

6. Push  or  to select [Yes] or [No], then push .

10:00 am	FWD	Tools
Begin Data Logging?		
No		
Yes		
Back	Home	

- [Yes]: Data logging starts.
- [No]: Data logging will not start.

If the drive was logging data when you entered the command, the keypad looks like this:

10:00 am	FWD	Tools
End Data Logging?		
No		
Yes		
Start Time :2020/01/01 00:00		
Period :00:10:00		
Back	Home	



## ◆ Configuring the Data Log Content

### ■ Set Monitor to Log

The procedure in this section shows how to set the monitor for which to log data.

1. Push  (Home) to show the HOME screen.

#### Note:



- When the drive is in HOME Mode, the screen shows [Home] in the upper right-hand corner of the screen.
- If the screen does not show [Home] for , push  (Back), and then push  to show [Home].

2. Push  (Menu).

10:00 am	FWD	Rdy	Home
OFF			
-----			
Freq Reference (AI)			0.00
U1-01	Hz		
Output Frequency			0.00
U1-02	Hz		
-----			
Menu			

3. Push  or  to select [Diagnostic Tools], then push .



10:00 am	FWD	Menu
User Custom Parameters		
Parameter Backup/Restore		
Modified Param / Fault Log		
Auto-Tuning		
Initial Setup		
Diagnostic Tools		
Home		

4. Push  or  to select [Data Logger], then push  (Setup).

10:00 am	FWD	Tools
<b>Data Logger</b>		
Backlight		
Drive Information		
Back	Home	Setup

5. Push  or  to select [Log Monitor], then push .

10:00 am	FWD	Setup
<b>Log Monitor</b>		
Log Sampling Interval		
Back	Home	

6. Push  or  to select the save-destination monitor parameter, then push .

10:00 am	FWD	Setup
Log Monitor		
<b>Log Monitor Data 1</b>		
05-03	101	(101)
Log Monitor Data 2		
05-04	102	(102)
Back	Home	

7. Push  or  to select the monitor number to be logged, then push .

10:00 am	FWD	Parameters
Log Monitor Data 1		
05-03	<b>101</b>	
Frequency Reference		
Default : 101		
Back	Default	



The configuration procedure is complete.

### ■ Set the Sampling Time

The procedure in this section shows how to set the sampling time for data logging.

1. Push  (Home) to show the HOME screen.

**Note:**

- When the drive is in HOME Mode, the screen shows [Home] in the upper right-hand corner of the screen.
- If the screen does not show [Home] for , push  (Back), and then push  to show [Home].

2. Push  (Menu).

10:00 am	FWD	Rdy	Home
<b>OFF</b>			
-----			
Freq Reference (AI)			
U1-01	Hz	0.00	
-----			
Output Frequency			
U1-02	Hz	0.00	
-----			
Menu			

3. Push  or  to select [Diagnostic Tools], then push .

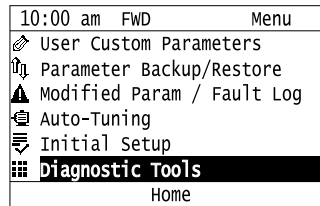



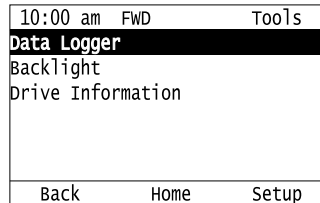

4. Push  or  to select [Data Logger], then push  (Setup).

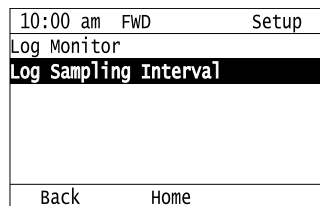

5. Push  or  to select [Log Sampling Interval], then push .



6. Push  or  to select the digit, then push  or  to change the value.

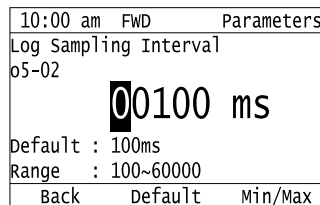

7. When you complete changing the value, push .

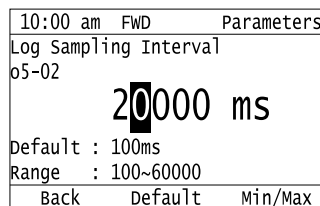



The procedure to set the sampling time is complete.

## ◆ Set Backlight to Automatically Turn OFF

You can set the backlight of the keypad screen to automatically turn OFF after a set length of time since the last key operation on the keypad. The procedure in this section shows how to turn ON and turn OFF the backlight.

1. Push  (Home) to show the HOME screen.



### Note:

- The keypad will show [Home] in the top right corner when the HOME screen is active.
- If [Home] is not shown on , push  (Back) to show [Home] on .

## 4.7 Keypad Operation

2. Push **F2** (Menu).

10:00 am FWD Rdy	Home
<b>OFF</b>	
-----	
Freq Reference (AI)	0.00
U1-01 Hz	
Output Frequency	0.00
U1-02 Hz	
Menu	

3. Push  or  to select [Diagnostic Tools], then push .

10:00 am FWD	Menu
↳ User Custom Parameters	
↑↓ Parameter Backup/Restore	
⚠ Modified Param / Fault Log	
🔧 Auto-Tuning	
📄 Initial Setup	
<b>🔧 Diagnostic Tools</b>	
Home	

4. Push  or  to select [Backlight], then push .

10:00 am FWD	Tools
Data Logger	
<b>Backlight</b>	
Drive Information	
Back	Home Setup

5. Push  or  to select [ON] or [OFF], then push .

10:00 am FWD	Tools
LCD backlight ON/OFF selection	
OFF	
<b>ON</b>	
Back	Home

- [ON]: Backlight is always ON
- [OFF]: Backlight turns OFF after set length of time.

6. Push **F3** (Setup).

10:00 am FWD	Tools
Data Logger	
<b>Backlight</b>	
Drive Information	
Back	Home Setup

7. Push .

10:00 am FWD	Setup
Energy Saving	
<b>LCD Backlight Off-Delay</b>	
o1-38	60 (60)sec
Back	Home

8. Push or to select the digit, then push or to change the value.

10:00 am	FWD	Parameters
LCD Backlight Off-Delay		
01-38		
060 sec		
Default : 60sec		
Range : 10~300		
Back	Default	Min/Max

9. When you are done changing the value, push .

10:00 am	FWD	Parameters
LCD Backlight Off-Delay		
01-38		
030 sec		
Default : 60sec		
Range : 10~300		
Back	Default	Min/Max

The procedure to set the backlight to turn OFF automatically is complete.

## ◆ Show Information about the Drive

The procedure in this section shows how to show the drive model, maximum applicable motor output, rated output current, software version, and the serial number on the keypad.

1. Push (Home) to show the HOME screen.

**Note:**

- The keypad will show [Home] in the top right corner when the HOME screen is active.
- If [Home] is not shown on , push (Back) to show [Home] on .

2. Push (Menu).

10:00 am	FWD	Rdy	Home
OFF			
-----			
Freq Reference (AI)		0.00	
U1-01	Hz		
Output Frequency		0.00	
U1-02	Hz		
Menu			

3. Push or to select [Diagnostic Tools], then push .

10:00 am	FWD	Menu
User Custom Parameters		
Parameter Backup/Restore		
Modified Param / Fault Log		
Auto-Tuning		
Initial Setup		
Diagnostic Tools ▶		
Home		

4. Push or to select [Drive Information], then push .

10:00 am	FWD	Tools
Data Logger		
Backlight		
Drive Information ▶		
Back	Home	

The keypad will show the drive information.

10:00 am	FWD	Tools
	HV600	A
	200V, 3.0HP	B
	10, 60A	C
	<VSEA01010>	D
	S/N: J0065F575310100	E
Back	Home	

A - Drive Series

B - Maximum Applicable Motor Output

C - Rated Output Current

D - Drive Software Version



E - Serial Number

### ◆ Write Automatically Backed-up Parameters to the Drive



You can automatically back up parameters to the keypad connected to the drive and write those parameters to a drive from the same drive series as specified by the settings of *o3-06 [Auto Parameter Backup Selection]* and *o3-07 [Auto Parameter Backup Interval]*.

**Note:**

- Set *o3-06 = 1 [Auto Parameter Backup Selection = Enabled]* in each drive to which you will write the parameters.
- This operation is not available when the parameters in the keypad and the parameters on the other drives are set to the same values.

1. Connect the keypad to the drive.
2. Push  or  to select [Yes], then push .

10:00 am	FWD	Backup
Drive and keypad mismatch. Should the parameters be restored?		
-----		
No		
Yes 		

3. Push  or  to select [Yes], then push .

10:00 am	FWD	Backup
Starting restore. Are you sure you want to start?		
-----		
No		
Yes 		

The keypad will show the “End” message when the write process is complete.

## 4.8 Automatic Parameter Settings Optimized for Specific Applications (Application Presets)

The drive has application presets to set the necessary parameters for different applications to their best values. To examine the parameters that *A1-06* [Application Preset] automatically changed, use [User Custom Parameters] on the Main menu.

**Note:**

Make sure that you set *A1-03* = 2220, 3330 [Initialize Parameters = 2-Wire Initialization, 3-Wire Initialization] to initialize parameters before you set *A1-06*.

This section shows the procedure to set an application preset.

1. Push **F2** (Home) to show the HOME screen.

**Note:**

- The keypad will show [Home] in the top right corner when the HOME screen is active.
- If [Home] is not shown on **F2**, push **F1** (Back) to show [Home] on **F2**.

2. Push **F2** (Menu).

10:00 am	FWD	Rdy	Home
<b>OFF</b>			
-----			
Freq Reference (AI)			
U1-01	Hz	0.00	
Output Frequency			
U1-02	Hz	0.00	
Menu			

3. Push **▲** or **▼** to select [Parameters], then push **↵**.



10:00 am	FWD	Menu
Monitors		
<b>Parameters</b>		
User Custom Parameters		
Parameter Backup/Restore		
Modified Param / Fault Log		
Auto-Tuning		
Home		

4. Push **▲** or **▼** to select [A Initialization Parameters], then push **↵**.



10:00 am	FWD	Parameters
<b>A Initialization Parameters</b>		
b Application		
C Tuning		
d References		
E Motor Parameters		
F Options		
Back	Home	

5. Push **▲** or **▼** to select [A1 Initialization], then push **↵**.

10:00 am	FWD	Parameters
<b>A1 Initialization</b>		
A2 User Parameters		
Back	Home	

6. Push  or  to select A1-06, then push .

10:00 am	FWD	Parameters
Password		
A1-04	0	(0)
<b>Application Preset</b>		
A1-06	1	(0)
DriveWorksEZ Function Selection		
A1-07	0	(0)
Back	Home	

7. Push  or  to change the value, then push .

10:00 am	FWD	Parameters
Application Preset		
A1-06	<b>3</b>	
Return Fan w/ PI Control		
Default : 0		
Back	Default	

The parameter setting procedure is complete.

**Note:**

- You cannot change the value set in A1-06. To select an application preset, first set A1-03 = 2220 to initialize parameters and then make a selection to A1-06. If initializing all parameters will cause a problem, it is not necessary to change settings.
- When the drive changes to the A1-06 setting, it will also reset the parameters automatically registered to A2-17 to A2-32 [User Parameters 17 to 32] when A2-33 = 1 [User Parameter Auto Selection = Enabled: Auto Save Recent Params].



## 4.9 Auto-Tuning

Auto-Tuning uses motor characteristics to automatically set drive parameters for vector control. Think about the type of motor, drive control method, and the motor installation environment and select the best Auto-Tuning method.

The keypad will show the messages with prompts to input the necessary parameter information. These prompts are specified by the selected Auto-Tuning method and the control method setting in *A1-02*.

### ◆ Auto-Tuning for Induction Motors

This section gives information about Auto-Tuning for induction motors. Auto-Tuning sets motor parameters *E1-xx*, *E2-xx* (*E3-xx*, *E4-xx* for motor 2).

#### Note:

Do Stationary Auto-Tuning if you cannot do Rotational Auto-Tuning. There can be large differences between the measured results and the motor characteristics when Auto-Tuning is complete. Examine the parameters for the measured motor characteristics after you do Stationary Auto-Tuning.

**Table 4.10 Types of Auto-Tuning for Induction Motors**

Mode	Parameter Settings	Application Conditions and Benefits	Applicable Control Method (A1-02 Setting)
			V/f (0)
Rotational Auto-Tuning	T1-01 = 0	<ul style="list-style-type: none"> <li>When you can decouple the motor and load the motor can rotate freely while Auto-Tuning.</li> <li>When operating motors that have fixed output characteristics.</li> <li>When it is necessary to use motors that have high-precision control.</li> <li>When you cannot decouple the motor and load, but the motor load is less than 30%.</li> </ul>	x
Line-to-Line Resistance	T1-01 = 2	<ul style="list-style-type: none"> <li>After Auto-Tuning, the wiring distance between the drive and motor changed by 50 m or more.</li> <li>When the wiring distance is 50 m or more in the V/f Control mode.</li> <li>When the motor output and drive capacity are different.</li> </ul>	x

### ■ Input Data for Induction Motor Auto-Tuning

To do Auto-Tuning, input data for the items in [Table 4.11](#) that have an “x”. Before starting Auto-Tuning, prepare the motor test report or record the information on the motor nameplate as a reference.

**Table 4.11 Input Data for Induction Motor Auto-Tuning**

Input Data	Parameter	Unit	Auto-Tuning Mode (T1-01 Setting)	
			Rotational Auto-Tuning (0)	Line-to-Line Resistance (2)
Motor Rated Power	T1-02	HP	x	x
Motor Rated Voltage	T1-03	V	x	-
Motor Rated Current	T1-04	A	x	x
Motor Base Frequency	T1-05	Hz	x	-
Number of Motor Poles	T1-06	-	x	-
Motor Base Speed	T1-07	min <sup>-1</sup>	x	-
Motor Iron Loss	T1-11	W	x */	-

\*1 Input this value when *A1-02* = 0 [Control Method Selection = V/f Control].

### ◆ Auto-Tuning for Motor Parameters for PM Motor

This section gives information about Auto-Tuning for PM motors. Auto-Tuning sets motor parameters *E1-xx*, *E5-xx*.

Table 4.12 Auto-Tuning for PM Motors

Mode	Parameter Settings	Application Conditions and Benefits	Applicable Control Method (A1-02 Setting)
			OLV/PM (5)
PM Motor Parameter Settings	T2-01 = 0	<ul style="list-style-type: none"> <li>When the information from the motor test report or motor nameplate is available.</li> <li>Rotational/Stationary Auto-Tuning that energizes the motor is not done. Manually input the necessary motor parameters.</li> </ul>	x
PM Stationary Auto-Tuning	T2-01 = 1	<ul style="list-style-type: none"> <li>When the information from the motor test report or motor nameplate is not available.</li> </ul> <p><b>Note:</b> With Stationary Auto-Tuning, the energized drive stays stopped for approximately 1 minute. During this time, the drive automatically measures the necessary motor parameters.</p>	x
PM Stationary Auto-Tuning for Stator Resistance	T2-01 = 2	<ul style="list-style-type: none"> <li>After Auto-Tuning, the wiring distance between the drive and motor changed by 50 m or more.</li> <li>When the motor output and drive capacity are different.</li> </ul>	x
PM Rotational Auto-Tuning	T2-01 = 4	<ul style="list-style-type: none"> <li>When the information from the motor test report or motor nameplate is not available.</li> <li>When you can decouple the motor and load the motor can rotate freely while Auto-Tuning.</li> <li>Values measured during Auto-Tuning are automatically set to the motor parameters.</li> </ul>	x
High Frequency Injection Auto-Tuning	T2-01 = 5	<ul style="list-style-type: none"> <li>Automatically determines the control parameters required to set <math>n8-35 = 1</math> [Initial Pole Detection Method = High Frequency Injection].</li> <li>Applicable to IPM motors only.</li> <li>Perform tuning with the motor connected to the drive.</li> </ul> <p><b>Note:</b> When you want to set <math>n8-35 = 1</math>, perform High Frequency Injection Auto-Tuning. Configure the drive with the data from the motor nameplate before performing High Frequency Injection Auto-Tuning. High Frequency Injection Auto-Tuning automatically makes adjustments while it is stopped but still energized.</p>	x

### ■ Input Data for PM Motor Auto-Tuning

To do Auto-Tuning, input data for the items in Table 4.13 and Table 4.14 that have an “x”. Before starting Auto-Tuning, prepare the motor test report or record the information on the motor nameplate as a reference.

Table 4.13 Input Data for PM Motor Auto-Tuning

Input Data	Parameter	Unit	Auto-Tuning Mode (T2-01 Setting)			
			PM Motor Parameter Settings (0)	PM Stationary Auto-Tuning (1)	PM Stationary Auto-Tuning for Stator Resistance (2)	
Control Method Selection	A1-02	-	5	5	5	
PM Motor Code Selection	T2-02	-	Motor Code of Yaskawa Motor *1	FFFF *2	-	-
PM Motor Type	T2-03	-	-	-	x	-
PM Motor Rated Power	T2-04	HP	-	x	x	-
PM Motor Rated Voltage	T2-05	V	-	x	x	-
PM Motor Rated Current	T2-06	A	-	x	x	x
PM Motor Base Frequency	T2-07	Hz	-	x	x	-
Number of PM Motor Poles	T2-08	-	-	x	x	-
PM Motor Stator Resistance	T2-10	Ω	x	x	-	-
PM Motor d-Axis Inductance	T2-11	mH	x	x	-	-
PM Motor q-Axis Inductance	T2-12	mH	x	x	-	-
Back-EMF Units Selection	T2-13	-	x	x	-	-

Input Data	Parameter	Unit	Auto-Tuning Mode (T2-01 Setting)		
			PM Motor Parameter Settings (0)	PM Stationary Auto-Tuning (1)	PM Stationary Auto-Tuning for Stator Resistance (2)
Control Method Selection	A1-02	-	5	5	5
PM Motor Code Selection	T2-02	-	Motor Code of Yaskawa Motor */	FFFF *2	-
Back-EMF Voltage Constant (Ke)	T2-14	*3	x	x	-
Pull-In Current Level	T2-15	%	-	-	x

\*1 Set the motor code for a Yaskawa PM motor.

\*2 Set the motor code to FFFF for a PM motor from a different manufacturer.

\*3 Changes when the value set in T2-13 changes.

**Table 4.14 Input Data for PM Motor Auto-Tuning**

Input Data	Parameter	Unit	Auto-Tuning Mode (T2-01 Setting)	
			PM Rotational Auto-Tuning (4)	High Frequency Injection Auto-Tuning (5)
Control Method Selection	A1-02	-	5	5
PM Motor Code Selection	T2-02	-	-	-
PM Motor Type	T2-03	-	x	-
PM Motor Rated Power	T2-04	HP	x	-
PM Motor Rated Voltage	T2-05	V	x	-
PM Motor Rated Current	T2-06	A	x	-
PM Motor Base Frequency	T2-07	Hz	x	-
Number of PM Motor Poles	T2-08	-	x	-
PM Motor Stator Resistance	T2-10	Ω	-	-
PM Motor d-Axis Inductance	T2-11	mH	-	-
PM Motor q-Axis Inductance	T2-12	mH	-	-
Back-EMF Units Selection	T2-13	-	-	-
Back-EMF Voltage Constant (Ke)	T2-14	*1	-	-
Pull-In Current Level	T2-15	%	x	-

\*1 Changes when the value set in T2-13 changes.

## ◆ Auto-Tuning in EZ Open Loop Vector Control Method

This section gives information about the Auto-Tuning mode for EZ Open Loop Vector Control. Auto-Tuning will set the E9-xx parameters.

**Table 4.15 EZ Tuning Mode Selection**

Mode	Parameter Settings	Application Conditions and Benefits	Applicable Control Method (A1-02 Setting)
Motor Parameter Setting	T4-01 = 0	<ul style="list-style-type: none"> <li>Applicable when driving SynRM (Synchronous Reluctance Motors).</li> <li>Suitable for derating torque applications, for example fans and pumps.</li> </ul>	EZOLV (8)
Line-to-Line Resistance	T4-01 = 1	<ul style="list-style-type: none"> <li>After Auto-Tuning, the wiring distance between the drive and motor changed by 50 m or more.</li> <li>When the motor output and drive capacity are different.</li> </ul>	EZOLV (8)

## ■ Auto-Tuning Input Data in EZ Open Loop Vector Control Method

To do Auto-Tuning, input data for the items in [Table 4.16](#) that have an “x”. Before starting Auto-Tuning, prepare the motor test report or record the information on the motor nameplate as a reference.

**Table 4.16 Auto-Tuning Input Data in EZ Open Loop Vector Control Method**

Input Data	Parameter	Unit	Auto-Tuning Mode (T4-01 Setting)	
			Motor Parameter Setting (0)	Line-to-Line Resistance (1)
Motor Type Selection	T4-02	-	x	-
Motor Max Revolutions	T4-03	min <sup>-1</sup>	x	-
Motor Rated Revolutions	T4-04	min <sup>-1</sup>	x	-
Motor Rated Frequency	T4-05	Hz	x	-
Motor Rated Voltage	T4-06	V	x	-
PM Motor Rated Current (FLA)	T4-07	A	x	x
PM Motor Rated Power (kW)	T4-08	kW	x	-
Number of Motor Poles	T4-09	-	x	-

## ◆ Precautions before Auto-Tuning

Examine the topics in this section before you start Auto-Tuning.

### ■ Prepare for Basic Auto-Tuning

- You must input data from the motor nameplate or motor test report to do Auto-Tuning. Make sure that this data is available before Auto-Tuning the drive.
- For best performance, make sure that the drive input supply voltage is equal to or more than the motor rated voltage.

#### Note:

Better performance is possible when you use a motor with a rated voltage that is less than the input supply voltage (by 20 V for 208 V class models or by 40 V for 480 V class models). This is very important when operating the motor at more than 90% of base speed, where high torque precision is necessary. If the input power supply is equal to the motor rated voltage, the drive output voltage will not be sufficient, and performance will decrease.

- Push  on the keypad to cancel Auto-Tuning.
- If a Safe Disable input signal is input to the drive during Auto-Tuning, Auto-Tuning measurements will not complete successfully. If this occurs, cancel the Auto-Tuning, then do it again.
- [Table 4.17](#) shows the status of input/output terminals during Auto-Tuning.

**Table 4.17 Status of Input/Output Terminals during Auto-Tuning**

Auto-Tuning Type	Mode		Multi-Function Inputs	Multi-Function Outputs <sup>*1</sup>
Induction Motor Auto-Tuning	Rotational	Rotational Auto-Tuning	Disabled	Functions the same as during usual operation.
	Stationary	Line-to-Line Resistance	Disabled	Keeps the status at the start of Auto-Tuning.
PM Motor Auto-Tuning	Rotational	PM Rotational Auto-Tuning	Disabled	Functions the same as during usual operation.
		PM Motor Parameter Settings	Disabled	Keeps the status at the start of Auto-Tuning.
	Stationary	PM Stationary Auto-Tuning	Disabled	Keeps the status at the start of Auto-Tuning.
		PM Stationary Auto-Tuning for Stator Resistance	Disabled	Keeps the status at the start of Auto-Tuning.
EZ Tuning	Stationary	Motor Parameter Setting	Disabled	Keeps the status at the start of Auto-Tuning.
		Line-to-Line Resistance	Disabled	Keeps the status at the start of Auto-Tuning.

\*1 A terminal to which  $H2-xx = E$  [MFDO Function Selection = Fault] is assigned functions the same as during usual operation.

**WARNING! Crush Hazard.** Wire a sequence that will not let a multi-function output terminal open the holding brake during Stationary Auto-Tuning. If the holding brake is open during Stationary Auto-Tuning, it can cause serious injury or death.

**WARNING! Sudden Movement Hazard.** Before you do Rotational Auto-Tuning, disconnect the load from the motor. The load can move suddenly and cause serious injury or death.

**WARNING! Injury to Personnel.** Rotational Auto-Tuning rotates the motor at 50% or more of the motor rated frequency. Make sure that there are no issues related to safety in the area around the drive and motor. Increased motor frequency can cause serious injury or death.

**WARNING! Electrical Shock Hazard.** During Auto-Tuning, the motor will receive high voltage when the motor is stopped. Do not touch the motor until Auto-Tuning is complete. If you touch a motor that is energized, it can cause serious injury or death.

### ■ Precautions before Rotational Auto-Tuning

**WARNING! Electrical Shock Hazard.** During Auto-Tuning, the motor will receive high voltage when the motor is stopped. Do not touch the motor until Auto-Tuning is complete. If you touch a motor that is energized, it can cause serious injury or death.

- Before you do Rotational Auto-Tuning to prevent drive malfunction, uncouple the motor from the load. If you do Rotational Auto-Tuning with the motor connected to a load that is more than 30% of the motor duty rating, the drive will not correctly calculate the motor parameters and the motor can operate incorrectly.
- When the load is 30% or less of the motor duty rating, you can do Auto-Tuning with the motor connected to a load.
- Make sure that the motor magnetic brake is released.
- Make sure that external force from the machine will not cause the motor to rotate.

### ■ Precautions before Stationary Auto-Tuning

- Make sure that the motor magnetic brake is not open.
- Make sure that external force from the machine will not cause the motor to rotate.

**WARNING! Electrical Shock Hazard.** During Auto-Tuning, the motor will receive high voltage when the motor is stopped. Do not touch the motor until Auto-Tuning is complete. If you touch a motor that is energized, it can cause serious injury or death.

### ■ Precautions before Stationary Auto-Tuning for Line-to-Line Resistance and Stator Resistance Auto-Tuning

In V/f control, when the motor cable is 50 meters (164 feet) or longer, do Stationary Auto-Tuning for Line-to-Line Resistance.

**WARNING! Electrical Shock Hazard.** During Auto-Tuning, the motor will receive high voltage when the motor is stopped. Do not touch the motor until Auto-Tuning is complete. If you touch a motor that is energized, it can cause serious injury or death.

## 4.10 Test Run

After you Auto-Tune the drive, the next step is to do a test run.

**WARNING! Crush Hazard.** Test the system to make sure that the drive operates safely after you wire the drive and set parameters. If you do not test the system, it can cause damage to equipment or serious injury or death.

### ◆ No-Load Test Run

Before connecting the motor to the machine, make sure that you check the operation status of the motor.

#### ■ Precautions before Operation

Before rotating the motor, check these items:

- Check for safety issues near the drive, motor, and machine.
- Make sure that all emergency stop circuits and machine safety mechanisms are operating correctly.

#### ■ Items to Check before Operation

Check these items before operation:

- Is the motor rotating in the forward direction?
- Is the motor rotating smoothly (no unusual sounds or unusual vibrations)?
- Does the motor accelerate/decelerate smoothly?



### ◆ Do a No-Load Test Run

Do these steps for a no-load test run:

1. Energize the drive, or push **F2** to show the HOME screen.  
If [Home] is not shown on **F2**, push **F1** (Back) to show [Home] on **F2**.
2. Push  to show *S5-05 [HAND Frequency Reference]*, and set it to 6.00 Hz.



#### Note:

The Run command from AUTO Mode must be OFF.

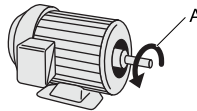
3. Push **F2** to show the HOME screen again.
4. Push  to give the drive a Run command from HAND Mode.  
When *o2-24 = 0 or 1 [LED Light Function Selection = Enable Status Ring & Keypad LED or LED Status Ring Disable]*,  illuminates and the motor runs at 6.00 Hz in the forward direction.
5. Make sure that the motor is rotating in the correct direction and that the drive does not show a fault.  
If the drive detects a fault, remove the cause.



#### A - Forward Rotation of Motor (Counter Clockwise Direction as Seen from Load Shaft)

6. Push  to increase the frequency reference value.  
Change the setting value in increments of 10 Hz if necessary and examine the response.
7. Each time you increase the setting value, use *U1-03 [Output Current]* to check the drive output current.  
When the output current of the drive is not more than the motor rated current, the status is correct.  
Example: 6 Hz → 20 Hz → 30 Hz → 40 Hz → 50 Hz → 60 Hz
8. Make sure that the motor rotates correctly, then push .

 is OFF and the motor coasts to stop.

## ◆ Actual-Load Test Run

Test the operation without a load, then connect the motor and machine to do a test run.

### ■ Precautions before Operation

Before rotating the motor, check these items:











- Check for safety issues near the drive, motor, and machine.
- Make sure that all emergency stop circuits and machine safety mechanisms are operating correctly.
- Make sure that the motor is fully stopped.
- Connect the motor with the machine.  
Make sure that there are no loose installation screws and that the motor load shafts and machine junctions are correctly secured.
- Keep the keypad near you to push  immediately if there is unusual or incorrect operation.

### ■ Items to Check before Operation

- Make sure that the direction of the machine operation is correct (The motor must rotate in the correct direction).
- Make sure that the motor accelerates and decelerates smoothly.

## ◆ Do an Actual-Load Test Run

Connect the motor and machine, then do the test run with the same procedure you used for the no-load test run.

- Make sure that *U1-03 [Output Current]* is not too high.
  1. Energize the drive, or push  (Home) to show the HOME screen.  
If [Home] is not shown on , push  (Back) to show [Home] on .
  2. Set *S5-05 [HAND Frequency Reference]* to 6.00 Hz.
  3. Push  to show the HOME screen again.
  4. Push  to give the drive a Run command from HAND Mode.  
When *o2-24 = 0* or *1 [LED Light Function Selection = Enable Status Ring & Keypad LED or LED Status Ring Disable]*,  illuminates and the motor runs at 6.00 Hz in the forward direction.
  5. Make sure that the motor is rotating in the correct direction and that the drive does not show a fault.  
If the drive detects a fault, remove the cause.
  6. Push  to increase the frequency reference value.  
Change the setting value in increments of 10 Hz if necessary and examine the response.
  7. Each time you increase the setting value, use *U1-03 [Output Current]* to check the drive output current.  
When the output current of the drive is not more than the motor rated current, the status is correct.  
Example: 6 Hz → 20 Hz → 30 Hz → 40 Hz → 50 Hz → 60 Hz
  8. Make sure that the motor rotates correctly, then push .  
 is OFF and the motor coasts to stop.
  9. Change the frequency reference and direction of motor rotation, and make sure that there are no unusual sounds or vibrations.
  10. If there are hunting or oscillation errors caused by control function or mechanical resonant, adjust the settings to stop the errors.

## 4.11 Fine Tuning during Test Runs (Adjust the Control Function)

This section gives information about the adjustment procedures to stop hunting or oscillation errors caused by control function during a test run. Adjust the applicable parameters as specified by your control method and drive status.

- [V/f Control on page 194](#)
- [Open Loop Vector Control for PM Motors on page 195](#)
- [EZ Open Loop Vector Control Method on page 196](#)

**Note:**

This section only lists frequently adjusted parameters. If you must adjust parameters that have a higher degree of precision, contact Yaskawa.

### ◆ V/f Control

**Table 4.18 Parameters for Fine Tuning the Drive (V/f)**

Issue	Parameter Number	Possible Solutions	Default	Recommended Setting
Hunting or oscillation at mid-range speeds (10 Hz to 40 Hz)	n1-02 [Hunting Prevention Gain Setting]	<ul style="list-style-type: none"> <li>• If torque is not sufficient with heavy loads, decrease the setting value.</li> <li>• If hunting or oscillation occur with light loads, increase the setting value.</li> <li>• If hunting occurs with a low-inductance motor, for example a motor with a larger frame size or a high-frequency motor, lower the setting value.</li> </ul>	1.00	0.10 - 2.00
<ul style="list-style-type: none"> <li>• The volume of the motor excitation sound is too high.</li> <li>• Hunting or oscillation at low speeds (10 Hz or lower), or at mid-range speeds (10 Hz to 40 Hz)</li> </ul>	C6-02 [Carrier Frequency Selection]	<ul style="list-style-type: none"> <li>• If the volume of the motor excitation sound is too high, increase the carrier frequency.</li> <li>• If hunting or oscillation occur at low or mid-range speeds, decrease the carrier frequency.</li> </ul>	1 (2 kHz) *1	1 to upper limit value
<ul style="list-style-type: none"> <li>• Unsatisfactory motor torque and speed response</li> <li>• Hunting or oscillation</li> </ul>	C4-02 [Torque Compensation Delay Time]	<ul style="list-style-type: none"> <li>• If torque or speed response are slow, decrease the setting value.</li> <li>• If hunting or oscillation occur, increase the setting value.</li> </ul>	200 ms *2	100 - 1000 ms
<ul style="list-style-type: none"> <li>• Torque at low speeds (10 Hz or lower) is not sufficient.</li> <li>• Hunting or oscillation</li> </ul>	C4-01 [Torque Compensation Gain]	<ul style="list-style-type: none"> <li>• If torque at low speeds (10 Hz or lower) is not sufficient, increase the setting value.</li> <li>• If hunting or oscillation occur with light loads, decrease the setting value.</li> </ul>	1.00	0.50 - 1.50
<ul style="list-style-type: none"> <li>• Torque at low speeds (10 Hz or lower) is not sufficient.</li> <li>• Large initial vibration at start up.</li> </ul>	<ul style="list-style-type: none"> <li>• E1-08 [Mid Point A Voltage]</li> <li>• E1-10 [Minimum Output Voltage]</li> </ul>	<ul style="list-style-type: none"> <li>• If torque at low speeds (10 Hz or lower) is not sufficient, increase the setting value.</li> <li>• If there is large initial vibration at start up, decrease the setting value</li> </ul>	<ul style="list-style-type: none"> <li>• E1-08: 15.0 V *3</li> <li>• E1-10: 9.0 V *3</li> </ul>	Default setting +/- 5 V *4
Speed precision is unsatisfactory. (V/f Control)	C3-01 [Slip Compensation Gain]	Set E2-01 [Motor Rated Current], E2-02 [Motor Rated Slip], and E2-03 [Motor No-Load Current], then adjust C3-01.	0.0 (no slip compensation)	0.5 - 1.5

\*1 The default setting changes when the settings for o2-04 [Drive Model (KVA) Selection] change.

\*2 The default setting changes when the settings for A1-02 [Control Method Selection] and o2-04 [Drive Model (KVA) Selection] change.

\*3 The default setting changes when the settings for A1-02 [Control Method Selection] and E1-03 [V/f Pattern Selection] change.

\*4 Recommended settings are for 208 V class drives. Multiply the voltage by 2 for 480 V class drives.

### ■ Precaution When You Use IE3 Premium Efficiency Motors

IE3 motors have different motor characteristics from IE1 and other motors. Set the parameters as specified by the motor characteristics. If the drive detects oC [Overcurrent] or ov [Overvoltage] during speed search after the drive restores power after a momentary power loss, set these parameters:

- b3-03 [Speed Search Deceleration Time] = default value × 2
- L2-03 [Minimum Baseblock Time] = default value × 2
- L2-04 [Powerloss V/f Recovery Ramp Time] = default value × 2



◆ Open Loop Vector Control for PM Motors

Table 4.19 Parameters for Fine Tuning the Drive (A1-02 = 5[OLV/PM])

Issue	Parameter Number	Possible Solutions	Default	Recommended Setting
Unsatisfactory motor performance	E1-xx parameters, E5-xx parameters	<ul style="list-style-type: none"> <li>Check the settings for E1-06, E1-04 [Base Frequency, Maximum Output Frequency].</li> <li>Check the E5-xx and make sure that all motor data has been set correctly.</li> </ul> <p><b>Note:</b> Do not set E5-05 [PM Motor Resistance (ohms/phase)] to a line-to-line resistance value.</p> <ul style="list-style-type: none"> <li>Do Auto-Tuning.</li> </ul>	-	-
Unsatisfactory motor torque and speed response	n8-55 [Motor to Load Inertia Ratio]	Adjust to match the load inertia ratio of the motor and machine.	0	Near the actual load inertia ratio.
	n8-45 [Speed Feedback Detection Gain]	Decrease the setting value in increments of 0.05.	0.80	-
	C4-01 [Torque Compensation Gain]	Adjust the setting value. <b>Note:</b> Setting this value too high can cause overcompensation and motor oscillation.	0.00	1.00
<ul style="list-style-type: none"> <li>Oscillation when the motor starts.</li> <li>Motor stalls.</li> </ul>	n8-51 [Pull-in Current @ Accel/Decel]	Increase the setting value in increments of 5%.	50%	-
	<ul style="list-style-type: none"> <li>b2-02 [DC Injection Braking Current]</li> <li>b2-03 [DC Inject Braking Time at Start]</li> </ul>	Use DC Injection Braking at start. <b>Note:</b> This can cause the motor to rotate in reverse for approximately 1/8 of a turn at start.	<ul style="list-style-type: none"> <li>b2-02: 50%</li> <li>b2-03: 0.00 s</li> </ul>	<ul style="list-style-type: none"> <li>b2-02: Adjust as necessary.</li> <li>b2-03: 0.5 s</li> </ul>
	n8-55 [Motor to Load Inertia Ratio]	Increase the setting value. <b>Note:</b> When operating a single motor or with a minimum amount of inertia, setting this value too high can cause motor oscillation.	0	Near the actual load inertia ratio.
There is too much current during deceleration.	n8-79 [Pull-in Current at Deceleration]	Set $n8-79 < n8-51$ .	50% <b>Note:</b> When $n8-79 = 0$ , the drive will apply the $n8-51$ setting to the pull-in current during deceleration.	Decrease in increments of 5%.
Stalling or oscillation occurs when load is applied during constant speed	n8-47 [Pull-in Current Comp Filter Time]	Decrease the setting value in increments of 0.2 s.	5.0 s	-
	n8-48 [Pull-in/Light Load Id Current]	Increase the setting value in increments of 5%.	30%	-
	n8-55 [Motor to Load Inertia Ratio]	Increase the setting value. <b>Note:</b> When operating a single motor or with a minimum amount of inertia, setting this value too high can cause motor oscillation.	0	Near the actual load inertia ratio.
Hunting or oscillation	n8-45 [Speed Feedback Detection Gain]	Increase the setting value in increments of 0.05.	0.80	-
The drive detects STPo [Motor Step-Out Detected] fault when the load is not too high.	<ul style="list-style-type: none"> <li>E5-09 [PM Back-EMF V<sub>peak</sub> (mV/(rad/s))]</li> <li>E5-24 [PM Back-EMF L-L V<sub>rms</sub> (mV/rpm)]</li> </ul>	<ul style="list-style-type: none"> <li>Adjust the setting value.</li> <li>Examine the motor code on the motor nameplate or the data sheet, then set correct values for E5-09 or E5-24.</li> </ul>	*1	<ul style="list-style-type: none"> <li>Yaskawa motor Set the motor code from the motor nameplate.</li> <li>Motor from another manufacturer Set the values from the test report.</li> </ul>
The drive detected stalling or STPo [Motor Step-Out Detected] at high speed and maximum output voltage.	n8-62 [Output Voltage Limit Level]	Set to a value lower than the actual input voltage.	<ul style="list-style-type: none"> <li>200.0 V</li> <li>400.0 V</li> </ul>	-

\*1 The default setting changes when the settings for E5-01 [Motor Code Selection] and o2-04 [Drive Model (KVA) Selection] change.

◆ EZ Open Loop Vector Control Method

Table 4.20 Parameters for Fine Tuning the Drive (A1-02 = 8[EZOLV])

Issue	Parameter Number	Possible Solutions	Default	Recommended Setting
<ul style="list-style-type: none"> <li>Unsatisfactory motor torque and speed response</li> <li>Hunting or oscillation</li> </ul>	<ul style="list-style-type: none"> <li>High speed C5-01 [ASR Proportional Gain 1]</li> <li>Low speed C5-03 [ASR Proportional Gain 2]</li> </ul>	<ul style="list-style-type: none"> <li>If torque or speed response are slow, increase the setting value in increments of 5.00.</li> <li>If hunting or oscillation occur, decrease the setting value.</li> </ul>	10.00	10.00 to 50.00 <i>*1</i>
	<ul style="list-style-type: none"> <li>High speed C5-02 [ASR Integral Time 1]</li> <li>Low speed C5-04 [ASR Integral Time 2]</li> </ul>	<ul style="list-style-type: none"> <li>If torque or speed response are slow, decrease the setting value.</li> <li>If hunting or oscillation occur, increase the setting value.</li> </ul>	0.500 s	0.300 s to 1.000 s <i>*1</i>
The drive cannot find ASR proportional gain or integral time for low speed or high speed.	C5-07 [ASR Gain Switchover Frequency]	Change the ASR proportional gain and ASR integral time to conform to the output frequency.	0.0%	0.0% to maximum rotation speed
Hunting or oscillation	C5-06 [ASR Delay Time]	If the rigidity of the machine is unsatisfactory and vibration is possible, increase the setting value in increments of 0.010.	0.004 s	0.004 s to 0.020 s <i>*1</i>
Step-out	E9-xx parameters	Refer to the motor nameplate or test report and set E9-xx correctly.	-	-
Oscillation when the motor starts.	n8-51 [Accel / Decel Pull-In Current]	Increase the setting value.	80%	Increase in increments of 5%.
Motor stalls.	L7-01 to L7-04 [Torque Limit]	Increase the setting value.	200%	Increase in increments of 10%.

\*1 The best values for a no-load operation are different than the best values for actual loading operation.

## 4.12 Test Run Checklist

Examine the items in this checklist and check each item before a test run.

Checked	No.	Description
	1	Correctly install and wire the drive as specified by this manual.
	2	Energize the drive.
	3	Set the voltage for the power supply in E1-01 [Input AC Supply Voltage].

Check the applicable items as specified by your control method.



**WARNING! Sudden Movement Hazard.** Correctly wire the start/stop and safety circuits before you energize the drive. If you momentarily close a digital input terminal, it can start a drive that is programmed for 3-Wire control and cause serious injury or death from moving equipment.

**Table 4.21 V/f Control [A1-02 = 0]**

Checked	No.	Description
	4	Select the best V/f pattern for your application and motor characteristics. Example: For a motor with a rated frequency of 60 Hz, set E1-03 = 1 [V/f Pattern Selection = Const Trq, 60Hz base, 60Hz max] as a standard V/f pattern.

**Table 4.22 PM Open Loop Vector Control [A1-02 = 5]**

Checked	No.	Description
	5	Set E5-01 to E5-24 [PM Motor Settings].

Checked	No.	Description
	6	The keypad will show "Rdy" after starting to operate the motor.
	7	To give the Run command and frequency reference from the keypad, push  to set the drive to HAND Mode. <b>Note:</b> When in HAND Mode,  illuminates.
	8	If the motor rotates in the opposite direction during test run, switch two of the motor cables (U/T1, V/T2, W/T3).
	9	Set E2-01 [Motor Rated Current (FLA)] and L1-01 [Motor Overload (oL1) Protection] correctly for motor thermal protection.
	10	To supply the Run command and frequency reference from REMOTE source, make sure that the drive is in OFF Mode in HOME screen.
	11	When terminal A1 is used for the frequency reference: <ul style="list-style-type: none"> <li>• Voltage input <ul style="list-style-type: none"> <li>– Set Jumper switch S1 on the drive to "V".</li> <li>– Set H3-01 = 0 [Terminal A1 Signal Level Select = 0 to 10V (Lower Limit at 0)].</li> <li>– Set H3-02 = 0 [Terminal A1 Function Selection = Frequency Reference].</li> </ul> </li> <li>• Current input <ul style="list-style-type: none"> <li>– Set Jumper switch S1 on the drive to "I".</li> <li>– Set H3-01 = 2, 3 [Terminal A1 Signal Level Select = 4 to 20 mA, 0 to 20 mA].</li> <li>– Set H3-02 = 0 [Terminal A1 Function Selection = Frequency Reference].</li> </ul> </li> </ul>

## 4.12 Test Run Checklist

Checked	No.	Description
	12	<p>When terminal A2 is used for the frequency reference:</p> <ul style="list-style-type: none"> <li>• Voltage input <ul style="list-style-type: none"> <li>– Set Jumper switch S1 on the drive to “V”.</li> <li>– Set H3-09 = 0 [Terminal A2 Signal Level Select = 0 to 10V (Lower Limit at 0)].</li> <li>– Set H3-10 = 0 [Terminal A2 Function Selection = Frequency Reference].</li> </ul> </li> <li>• Current input <ul style="list-style-type: none"> <li>– Set Jumper switch S1 on the drive to “I”.</li> <li>– Set H3-09 = 2, 3 [Terminal A2 Signal Level Select = 4 to 20 mA, 0 to 20 mA].</li> <li>– Set H3-10 = 0 [Terminal A2 Function Selection = Frequency Reference].</li> </ul> </li> </ul>
	13	<p>Make sure that the frequency reference reaches the necessary minimum and maximum values.  → If drive operation is incorrect, make these adjustments:</p> <p>Gain adjustment: Set the maximum voltage and current values, then adjust the analog input gain until the frequency reference reaches the necessary value. (For terminal A1 input: H3-03, for terminal A2 input: H3-11)</p> <p>Bias adjustment: Set the maximum voltage/current values, then adjust the analog input bias until the frequency reference reaches the necessary minimum value. (For terminal A1 input: H3-04, for terminal A2 input: H3-12)</p>

# Standards Compliance

---

This chapter gives information about how to make the machines and devices that use this product comply with European standards and UL standards.

<b>5.1</b>	<b>Section Safety .....</b>	<b>200</b>
<b>5.2</b>	<b>European Standards.....</b>	<b>202</b>
<b>5.3</b>	<b>UL Standards.....</b>	<b>216</b>
<b>5.4</b>	<b>China RoHS Compliance.....</b>	<b>228</b>
<b>5.5</b>	<b>对应中国RoHS指令.....</b>	<b>229</b>
<b>5.6</b>	<b>Safe Disable Input.....</b>	<b>230</b>
<b>5.7</b>	<b>Seismic Standards.....</b>	<b>237</b>

## 5.1 Section Safety

### DANGER

#### Electrical Shock Hazard

**Do not examine, connect, or disconnect wiring on an energized drive. Before servicing, disconnect all power to the equipment and wait for the time specified on the warning label at a minimum. The internal capacitor stays charged after the drive is de-energized. The charge indicator LED extinguishes when the DC bus voltage decreases below 50 Vdc. When all indicators are OFF, remove the covers before measuring for dangerous voltages to make sure that the drive is safe.**

If you do work on the drive when it is energized, it will cause serious injury or death from electrical shock.

### WARNING

#### Electrical Shock Hazard

**Do not operate the drive when covers are missing. Replace covers and shields before you operate the drive. Use the drive only as specified by the instructions.**

Some figures in this section include drives without covers or safety shields to more clearly show the inside of the drive. If covers or safety shields are missing from the drive, it can cause serious injury or death.

**Always ground the motor-side grounding terminal.**

If you do not ground the equipment correctly, it can cause serious injury or death if you touch the motor case.

**Do not remove covers or touch circuit boards while the drive is energized.**

If you touch the internal components of an energized drive, it can cause serious injury or death.

**Only let approved personnel install, wire, maintain, examine, replace parts, and repair the drive.**

If personnel are not approved, it can cause serious injury or death.

**Do not wear loose clothing or jewelry when you do work on the drive. Tighten loose clothing and remove all metal objects, for example watches or rings.**

Loose clothing can catch on the drive and jewelry can conduct electricity and cause serious injury or death.

**Do not modify the drive body or drive circuitry.**

Modifications to drive body and circuitry can cause serious injury or death, will cause damage to the drive, and will void the warranty. Yaskawa is not responsible for modifications of the product made by the user.

#### Fire Hazard

**Tighten all terminal screws to the correct tightening torque.**

Connections that are too loose or too tight can cause incorrect operation and damage to the drive. Incorrect connections can also cause death or serious injury from fire.

**Tighten screws at an angle in the specified range shown in this manual.**

If you tighten the screws at an angle not in the specified range, you can have loose connections that can cause damage to the terminal block or start a fire and cause serious injury or death.

#### Damage to Equipment

**Do not apply incorrect voltage to the main circuit of the drive. Operate the drive in the specified range of the input voltage on the drive nameplate.**

Voltages that are higher than the permitted nameplate tolerance can cause damage to the drive.

#### Fire Hazard

**Do not put flammable or combustible materials on top of the drive and do not install the drive near flammable or combustible materials. Attach the drive to metal or other noncombustible material.**

Flammable and combustible materials can start a fire and cause serious injury or death.

**⚠ WARNING****Crush Hazard**

**Wear eye protection when you do work on the drive.**

If you do not use correct safety equipment, it can cause serious injury or death.

**Electrical Shock Hazard**

**After the drive blows a fuse or trips a GFCI, do not immediately energize the drive or operate peripheral devices. Wait for the time specified on the warning label at a minimum and make sure that all indicators are OFF. Then check the wiring and peripheral device ratings to find the cause of the problem. If you do not know the cause of the problem, contact Yaskawa before you energize the drive or peripheral devices.**

If you do not fix the problem before you operate the drive or peripheral devices, it can cause serious injury or death.

**NOTICE****Damage to Equipment**

**When you touch the drive and circuit boards, make sure that you observe correct electrostatic discharge (ESD) procedures.**

If you do not follow procedures, it can cause ESD damage to the drive circuitry.

**Do not break the electrical connection between the drive and the motor when the drive is outputting voltage.**

Incorrect equipment sequencing can cause damage to the drive.

**Make sure that all connections are correct after you install the drive and connect peripheral devices.**

Incorrect connections can cause damage to the drive.

**Note:**

Do not use unshielded cable for control wiring. Use shielded, twisted-pair wires and ground the shield to the ground terminal of the drive. Unshielded wire can cause electrical interference and unsatisfactory system performance.

## 5.2 European Standards



**Figure 5.1 CE Mark**

The CE Mark identifies that the product meets environmental and safety standards in the European Union. Products manufactured, sold, or imported in the European Union must display the CE Mark.

European Union standards include standards for electrical appliances (Low Voltage Directive), standards for electrical noise (EMC Directive), and standards for machinery (Machinery Directive).

This product displays the CE Mark in accordance with the Low Voltage Directive, the EMC Directive, and the Machinery Directive.

**Table 5.1 Harmonized Standard**

European Directive	Harmonized Standard
Low Voltage Directive 2014/35/EU	EN 61800-5-1:2007/A1:2017
EMC Directive 2014/30/EU	EN 61800-3:2004/A1:2012 First environment restricted distribution
Machinery Directive 2006/42/EC	<ul style="list-style-type: none"> <li>• EN 61800-5-2:2017 (SIL3)</li> <li>• EN 62061:2005/A2:2015 (SIL CL3)</li> <li>• EN ISO 13849-1:2015 (PL e (Cat.III))</li> </ul>

The customer must display the CE Mark on the final device containing this product. Customers must verify that the final device complies with EU standards.

### ◆ EU Declaration of Conformity

Go to [www.yaskawa.com](http://www.yaskawa.com) and search for “EU Declaration of Conformity” to get an original copy of the EU Declaration of Conformity.

Yaskawa declares that this product complies with the following directives and standards at our sole responsibility.

### ◆ CE Low Voltage Directive Compliance

It has been confirmed that this product complies with the CE Low Voltage Directive by conducting a test according to IEC/EN 61800-5-1:2007.

The following conditions must be satisfied for machines and devices incorporating this product to comply with the CE Low Voltage Directive.

#### ■ Area of Use

Install this product in a location with Overvoltage Category III and pollution degree 2 or less.

#### ■ Guarding Against Debris

When you install IP20/UL Open Type drives (model: 2xxxxB, 4xxxxB), use an enclosure panel that does not let unwanted material enter the drive from above or below.

#### ■ Electrical Installation

Refer to [Figure 5.2](#) or [Figure 5.3](#) for an example of a drive that is wired to comply with the CE Low Voltage Directive.



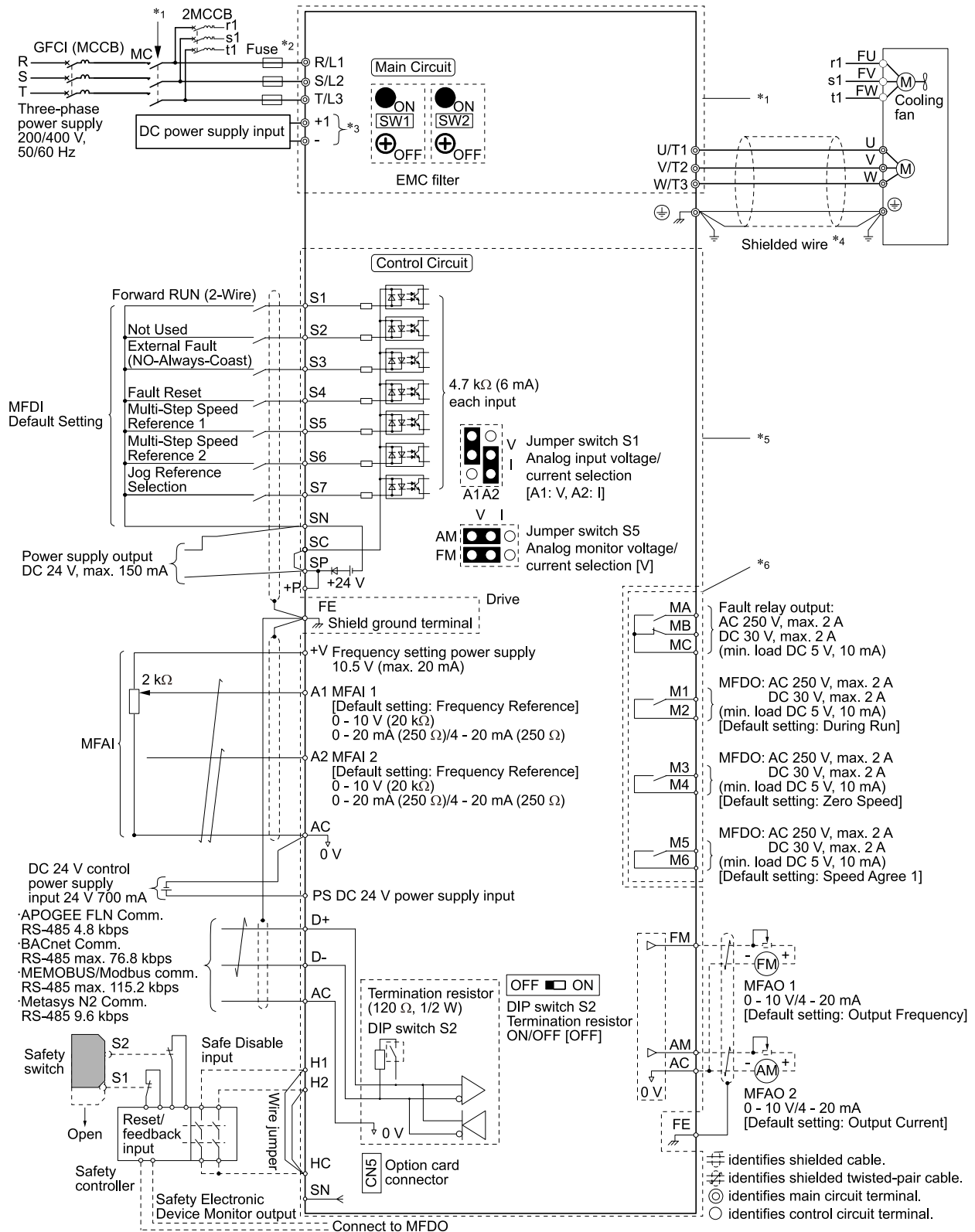

**Figure 5.2 Wiring Diagram for CE Low Voltage Directive Compliance (Models: 2xxxxB/F/V and 4xxxxB/F/V without Main Switch)**

- \*1 For circuit protection, the main circuit is separated from the surface case that can touch the main circuit.
- \*2 To comply with LVD standard requirement, set L8-05 = 1 [Input Phase Loss Protection Sel = Enabled] to protect the drive from the high current caused by Input Phase Loss condition.

## 5.2 European Standards

---

- \*3 Use terminals - and +1 to connect options to the drive.

**WARNING! Sudden Movement Hazard.** Make sure that the polarity is correct before you send a Run command. If the drive incorrectly detects the polarity, the drive can rotate in the direction opposite of the Run command and cause serious injury or death.

- \*4 Use braided shield cable for the drive and motor wiring, or run the wiring through a metal conduit.
- \*5 The control circuit is a Safety Extra-Low Voltage circuit. Separate this circuit from other circuits with reinforced insulation. Make sure to connect the Safety Extra-Low Voltage circuit as specified.
- \*6 Reinforced insulation separates the output terminals from other circuits. When the drive output is 250 Vac 1 A maximum or 30 Vdc 1 A maximum, you can also connect circuits that are not Safety Extra-Low Voltage circuits.

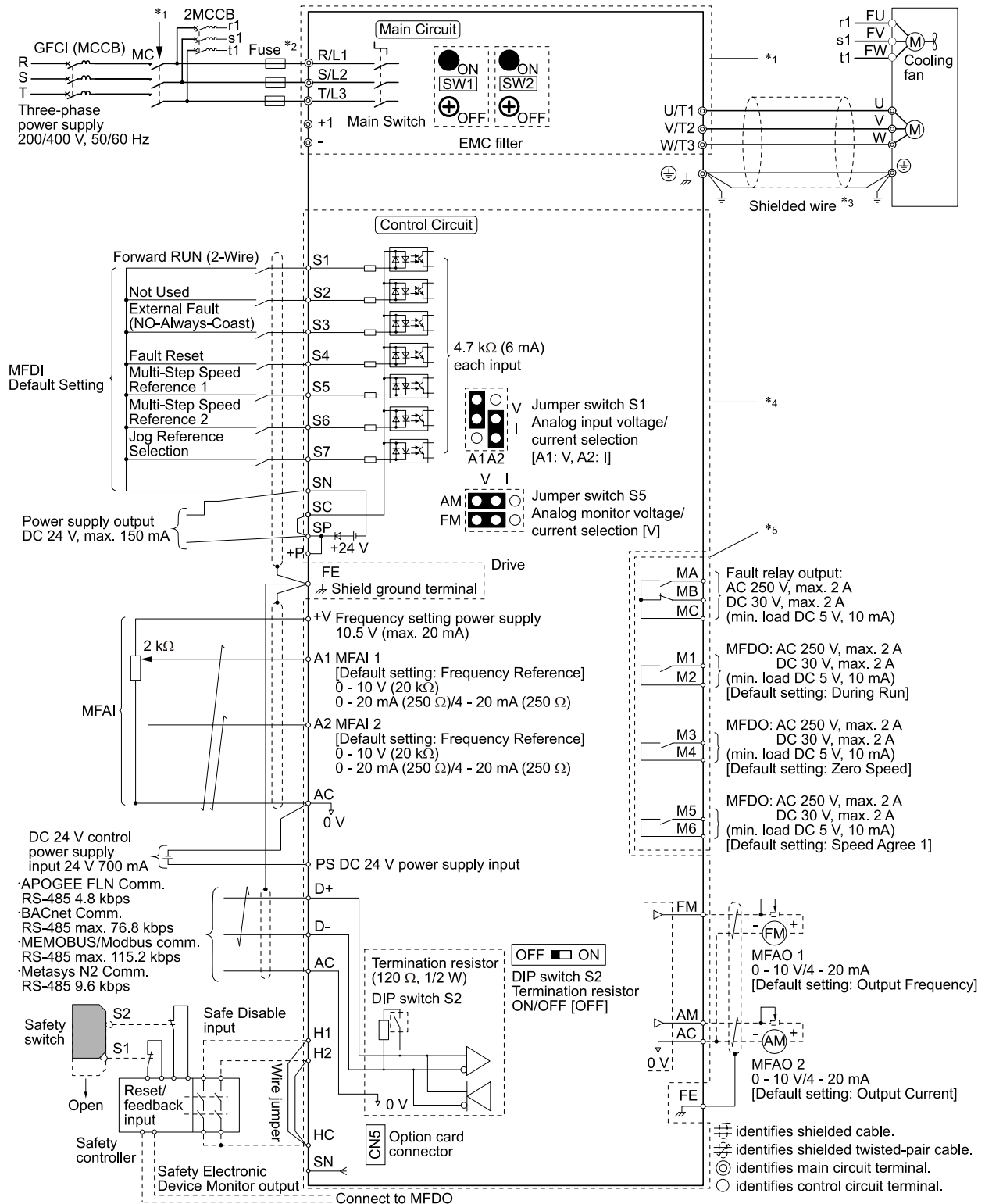

**Figure 5.3 Wiring Diagram for CE Low Voltage Directive Compliance (Models: 2xxxxT and 4xxxxT with Main Switch)**

- \*1 For circuit protection, the main circuit is separated from the surface case that can touch the main circuit.
- \*2 To comply with LVD standard requirement, set L8-05 = 1 [Input Phase Loss Protection Sel = Enabled] to protect the drive from the high current caused by Input Phase Loss condition.
- \*3 Use braided shield cable for the drive and motor wiring, or run the wiring through a metal conduit.
- \*4 The control circuit is a Safety Extra-Low Voltage circuit. Separate this circuit from other circuits with reinforced insulation. Make sure to connect the Safety Extra-Low Voltage circuit as specified.
- \*5 Reinforced insulation separates the output terminals from other circuits. When the drive output is 250 Vac 1 A maximum or 30 Vdc 1 A maximum, you can also connect circuits that are not Safety Extra-Low Voltage circuits.

## ■ Main Circuit Wire Gauges and Tightening Torques

**WARNING! Electrical Shock Hazard.** Only connect 12-pulse output, 18-pulse output, or DC power input to terminals - and +1. Incorrect wiring can cause damage to the drive and serious injury or death from fire.

Refer to *Three-Phase 208 V Class Wire Gauges and Torques (Models: 2xxxxB/F/V without Main Switch) on page 76* and *Three-Phase 480 V Class Wire Gauges and Torques (Models: 4xxxxB/F/V without Main Switch) on page 78* or *Three-Phase 208 V Class Wire Gauges and Torques (Models: 2xxxxT with Main Switch) on page 81* and *Three-Phase 480 V Class Wire Gauges and Torques (Models: 4xxxxT with Main Switch) on page 83* for the recommended wire gauges and tightening torques of the main circuit terminals.

### Note:

The recommended wires for the main circuit are 600 V, Class 2 vinyl-insulated copper wires with a continuous maximum operating temperature of 75 °C (167 °F). Assume these conditions:

- Ambient temperature: 40 °C (104 °F) or lower
- Wiring distance: 100 m (3281 ft) or shorter
- Normal Duty Rated current value

## ■ Connect a Fuse and a GFCI to the Input Side (Primary Side)

The drive circuit protection must comply with IEC/EN 61800-5-1:2007 for protection against a short circuit in the internal circuitry. Yaskawa recommends connecting a semiconductor protection fuse and a Ground Fault Circuit Interrupter (GFCI) on the input side for branch circuit protection.

**WARNING! Electrical Shock Hazard.** After the drive blows a fuse or trips a GFCI, do not immediately energize the drive or operate peripheral devices. Wait for the time specified on the warning label at a minimum and make sure that all indicators are OFF. Then check the wiring and peripheral device ratings to find the cause of the problem. If you do not know the cause of the problem, contact Yaskawa before you energize the drive or peripheral devices. If you do not fix the problem before you operate the drive or peripheral devices, it can cause serious injury or death.

**Table 5.2 Factory-Recommended Semiconductor Protection Fuses (208 V Class)**

Drive Model	Semiconductor Protection Fuse Model Manufacturer: EATON/Bussmann	Drive Model	Semiconductor Protection Fuse Model Manufacturer: EATON/Bussmann
2011	FWH-40B	2088	FWH-225A
2017	FWH-50B	2114	FWH-225A
2024	FWH-80B	2143	FWH-250A
2031	FWH-100B	2169	FWH-275A
2046	FWH-125B	2211	FWH-600A
2059	FWH-225A	2273	FWH-800A
2075	FWH-225A		

**Table 5.3 Factory-Recommended Semiconductor Protection Fuses (480 V Class)**

Drive Model	Semiconductor Protection Fuse Model Manufacturer: EATON/Bussmann	Drive Model	Semiconductor Protection Fuse Model Manufacturer: EATON/Bussmann
4005	FWH-25A14F	4065	FWH-225A
4008	FWH-30A14F	4077	FWH-225A
4011	FWH-40B	4096	FWH-225A
4014	FWH-50B	4124	FWH-225A
4021	FWH-60B	4156	FWH-325A
4027	FWH-80B	4180	FWH-500A
4034	FWH-100B	4240	FWH-600A
4040	FWH-125B	4302	FWH-700A
4052	FWH-150B		

Table 5.4 Factory-Recommended GFCI (208 V Class)

Drive Model	GFCI Model Manufacturer: Mitsubishi Electric	Rated Current A	Rated Leakage Current mA
2011	NV32-SV	20	500
2017	NV32-SV	32	500
2024	NV63-SV	50	500
2031	NV63-SV	60	500
2046	NV125-SV	100	500
2059	NV125-SV	125	500
2075	NV250-SV	150	500
2088	NV250-SV	175	500
2114	NV250-SV	225	500
2143	NV400-SW	300	500
2169	NV400-SW	350	500
2211	NV630-SEW	500	500
2273	NV630-SEW	500	500

Table 5.5 Factory-Recommended GFCI (480 V Class)

Drive Model	GFCI Model Manufacturer: Mitsubishi Electric	Rated Current A	Rated Leakage Current mA
4005	NV32-SV	15	500
4008	NV32-SV	15	500
4011	NV32-SV	20	500
4014	NV32-SV	30	500
4021	NV63-SV	50	500
4027	NV63-SV	63	500
4034	NV63-SV	63	500
4040	NV125-SV	100	500
4052	NV125-SV	125	500
4065	NV125-SV	125	500
4077	NV250-SV	150	500
4096	NV250-SV	200	500
4124	NV250-SV	250	500
4156	NV400-SEW	300	500
4180	NV400-SEW	350	500
4240	NV630-SW	500	500
4302	NV630-SW	600	500

## ◆ EMC Directive

Drives with built-in EMC filters were tested in accordance with European standard IEC/EN 61800-3, and comply with the EMC Directive.

### ■ Install a Drive to Conform to the EMC Directive

Use this procedure to install drives that comply with the EMC Directive when the drive is a single unit or installed in a larger device.

1. Install the drive on a grounded metal plate.

2. Wire the drive and motor.
3. Ground the wire shielding on the drive side and motor side.

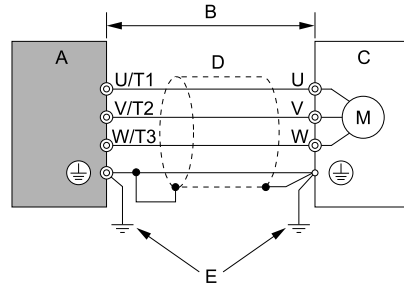

- |                                   |                           |
|-----------------------------------|---------------------------|
| <b>A - Drive</b>                  | <b>D - Metal conduit</b>  |
| <b>B - 100 m (328 ft) maximum</b> | <b>E - Grounding wire</b> |
| <b>C - Motor</b>                  |                           |

**Figure 5.4 Wiring the Drive and Motor**

**Note:**

- Use a braided shield cable for the drive and motor wiring or put the wires through a metal conduit.
- The maximum wiring length between the drive and motor is 100 m (328 ft). Keep the wire as short as possible.
- Keep the grounding wire as short as possible.

4. Use a cable clamp to ground the motor cable to the metal plate.

**Note:**

Make sure that the protective ground wire complies with technical specifications and local safety standards.

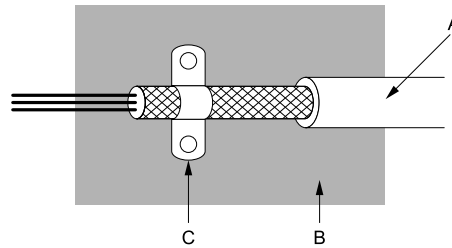

- |                                 |                                     |
|---------------------------------|-------------------------------------|
| <b>A - Braided shield cable</b> | <b>C - Cable clamp (conductive)</b> |
| <b>B - Metal plate</b>          |                                     |

**Figure 5.5 Ground the shield**

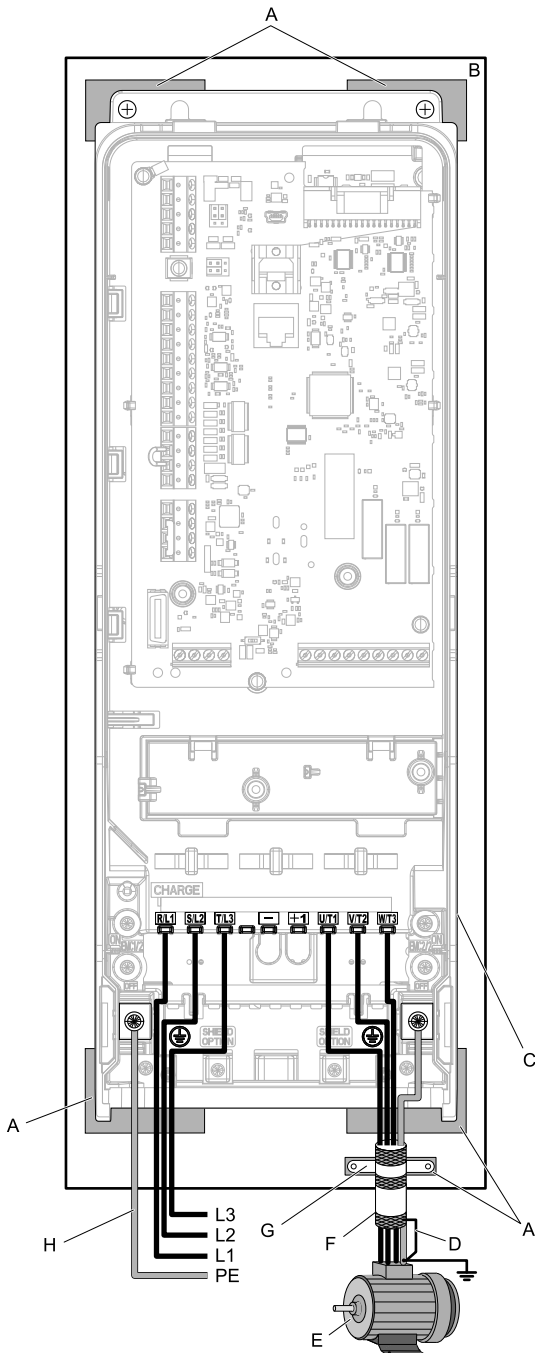

- A - Grounding surface (Remove any paint or sealant.)
- B - Metal plate
- C - Drive
- D - Shielded wire
- E - Motor
- F - Motor cable
- G - Cable clamp
- H - Grounding wire

Figure 5.6 Install a Drive with a Built-in EMC Filter (Models: 2xxxxB/F/V and 4xxxxB/F/V without Main Switch)

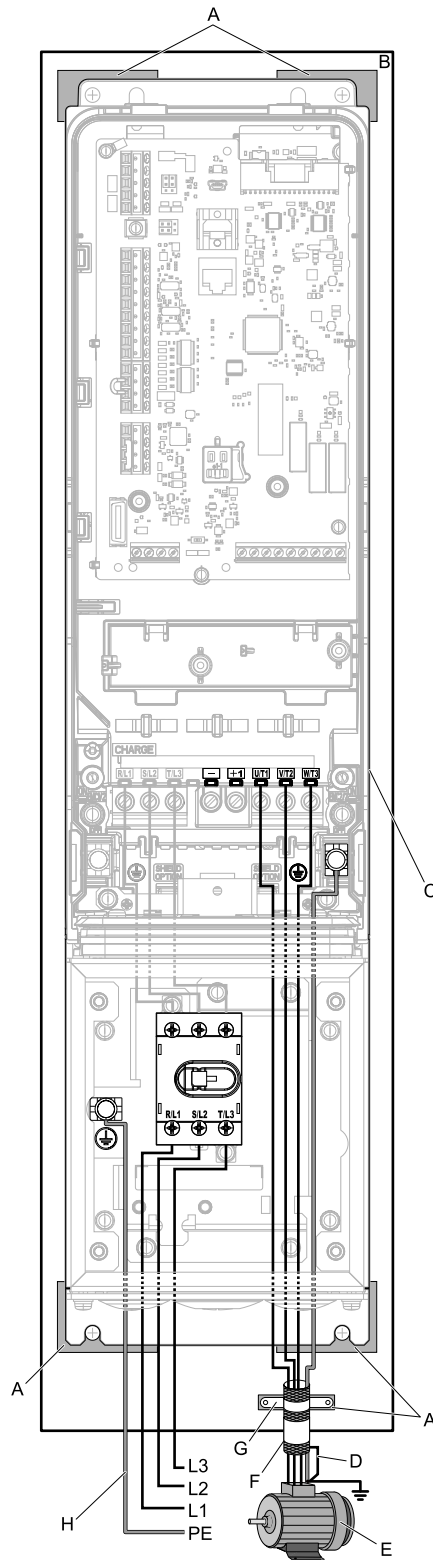

- A - Grounding surface (Remove any paint or sealant.)
- B - Metal plate
- C - Drive
- D - Shielded wire
- E - Motor
- F - Motor cable
- G - Cable clamp
- H - Grounding wire

Figure 5.7 Install a Drive with a Built-in EMC Filter (Models: 2xxxxT and 4xxxxT with Main Switch)



## Ground Wiring

**WARNING! Electrical Shock Hazard.** Do not remove covers or touch circuit boards while the drive is energized. If you touch the internal components of an energized drive, it can cause serious injury or death.

**WARNING! Electrical Shock Hazard.** Ground the neutral point on the power supply of the drives to comply with the EMC Directive before you turn on the EMC filter. If you turn ON the EMC filter, but you do not ground the neutral point, it can cause serious injury or death.

### Enable the Internal EMC Filter

Move the screws to turn ON and OFF (enable and disable) the EMC filter.

Make sure that you apply a symmetric grounding network and install the both screws in the ON position to enable the built-in EMC filter in compliance with the EMC Directive. The default position of the EMC filter switch screws is the OFF position.

**WARNING! Electrical Shock Hazard.** Disconnect all power to the drive, wait for the time specified on the warning label, and check the drive for dangerous voltages before you remove covers or touch EMC filter screws. If you touch the screws when there are dangerous voltages, it will cause serious injury or death.

**WARNING! Electrical Shock Hazard.** Do not remove covers or touch circuit boards while the drive is energized. If you touch the internal components of an energized drive, it can cause serious injury or death.

**WARNING! Electrical Shock Hazard.** Ground the neutral point on the power supply of the drives to comply with the EMC Directive before you turn on the EMC filter. If you turn ON the EMC filter, but you do not ground the neutral point, it can cause serious injury or death.

**WARNING! Electrical Shock Hazard.** Connect the ground cable correctly. If you touch electrical equipment that is not grounded, it can cause serious injury or death.

**NOTICE:** To disable the internal EMC filter, move the screws from ON to OFF and then tighten to the specified torque. If you fully remove the screws or tighten the screws to an incorrect torque, it can cause drive failure.

**NOTICE:** Move the EMC switch screw or screws to the OFF position for networks that are not symmetrically grounded. If the screws are not in the correct position, it can cause damage to the drive.

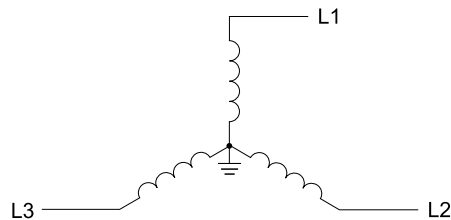

Figure 5.8 Symmetric Grounding

**NOTICE: Damage to Equipment.** When you use the drive with a non-grounding, high-resistance grounding, or asymmetric-grounding network, put the EMC Filter screw or screws in the OFF position to disable the built-in EMC filter. If you do not disable the built-in EMC filter, it will cause damage to the drive.

Table 5.6 shows asymmetric grounding networks.

Table 5.6 Asymmetric Grounding

Type of Grounding	Diagram
Grounded at the corner of the delta connection	<p>The diagram shows a delta (Δ) connection of three inductors. The top inductor is labeled L1, the bottom-left is L3, and the bottom-right is L2. One of the corners of the delta, specifically the bottom-right corner, is connected to a ground symbol.</p>
Grounded at the middle of the side	<p>The diagram shows a delta (Δ) connection of three inductors. The top inductor is labeled L1, the bottom-left is L3, and the bottom-right is L2. The midpoint of the bottom side (between L3 and L2) is connected to a ground symbol.</p>

## 5.2 European Standards

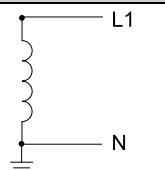
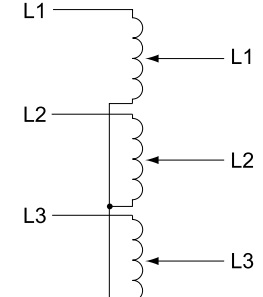
Type of Grounding	Diagram
Single-phase, grounded at the end point	
Three-phase variable transformer without solidly grounded neutral	

**Table 5.7 EMC Filter Switch Location**

Model	Switch Location Diagram
2011, 2017, 4005 - 4014	<a href="#">Figure 5.9</a>
2024, 2031, 4021 - 4034	<a href="#">Figure 5.10</a>
2046, 2059, 4040 - 4065	<a href="#">Figure 5.11</a>
2075 - 2114, 4077 - 4124	<a href="#">Figure 5.12</a>
2143, 2169, 4156	<a href="#">Figure 5.13</a>
2211, 2273 4180, 4240	<a href="#">Figure 5.14</a>
4302	<a href="#">Figure 5.15</a>

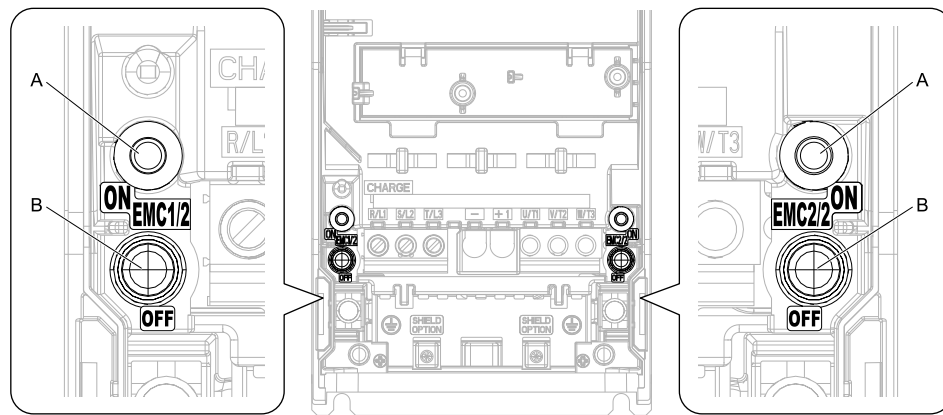

A - SW (ON)

B - Screw (OFF)

**Figure 5.9 EMC Filter Switch Location 1**

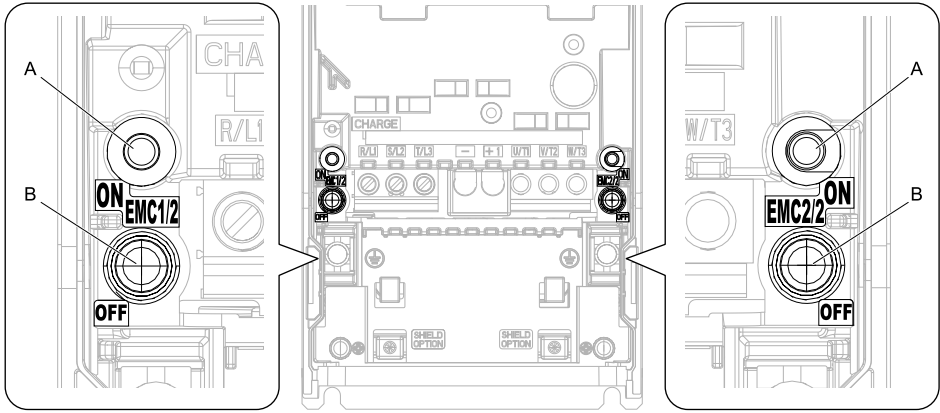

A - SW (ON)

B - Screw (OFF)

Figure 5.10 EMC Filter Switch Location 2

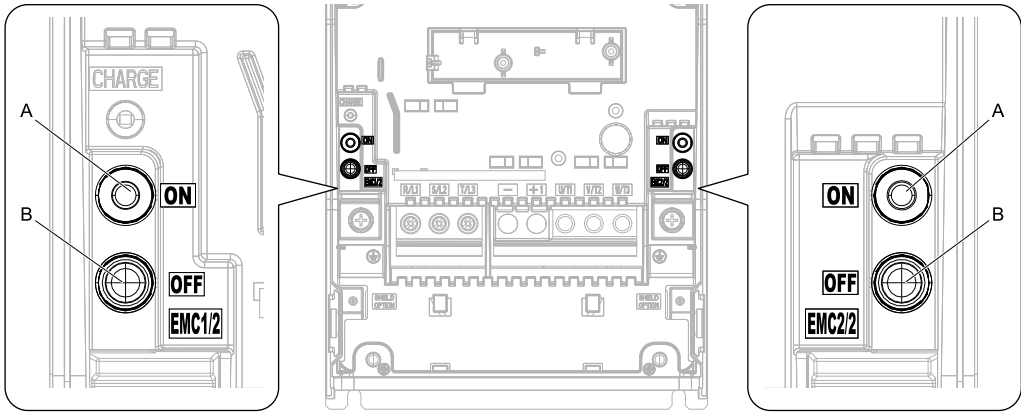

A - SW (ON)

B - Screw (OFF)

Figure 5.11 EMC Filter Switch Location 3

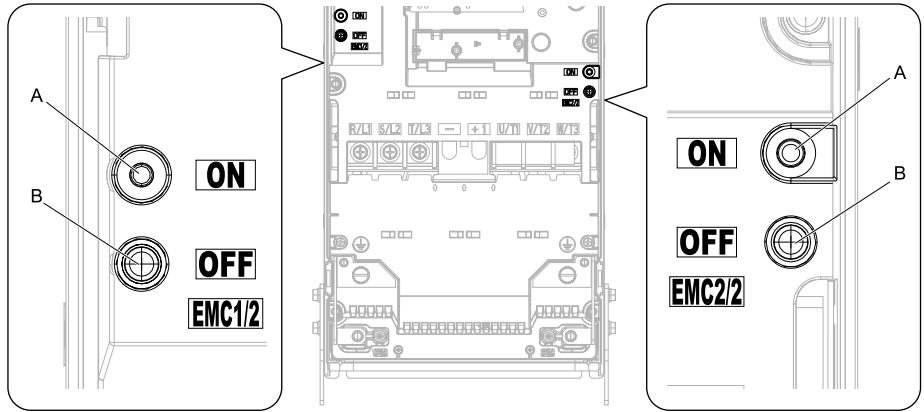

A - SW (ON)

B - Screw (OFF)

Figure 5.12 EMC Filter Switch Location 4

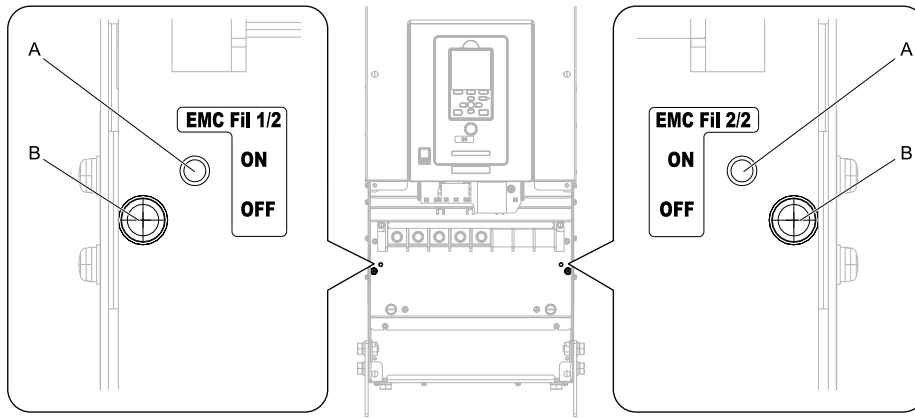

A - SW (ON)

B - Screw (OFF)

Figure 5.13 EMC Filter Switch Location 5

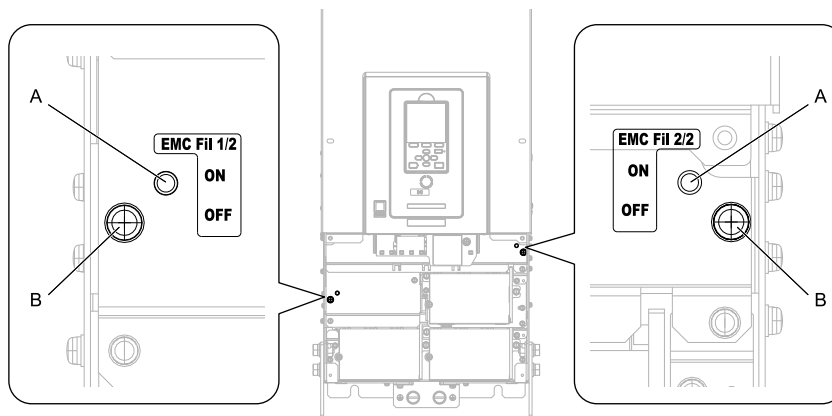

A - SW (ON)

B - Screw (OFF)

Figure 5.14 EMC Filter Switch Location 6

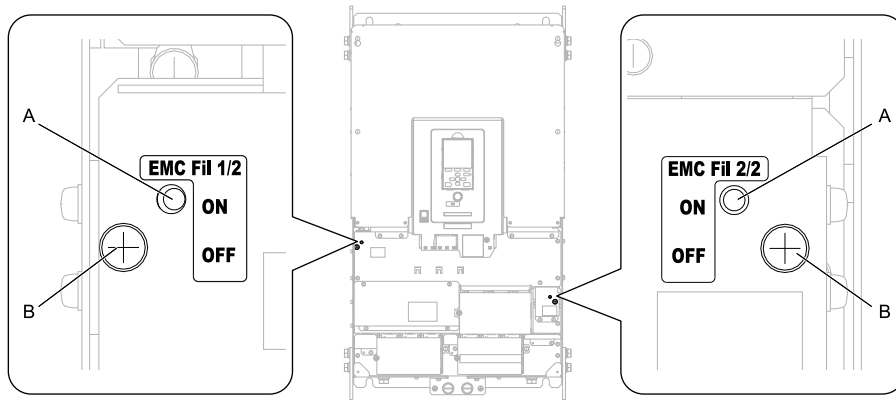

A - SW (ON)

B - Screw (OFF)

Figure 5.15 EMC Filter Switch Location 7

If you lose an EMC filter switch screw, use [Table 5.8](#) to find the correct replacement screw and install the new screws with the correct tightening torque.

**NOTICE:** Only use the screws specified in this manual. If you use screws that are not approved, it can cause damage to the drive.

**Table 5.8 Screw Sizes and Tightening Torques**

<b>Model</b>	<b>Screw Size</b>	<b>Tightening Torque N·m</b>
2011 - 2059, 4005 - 4065	M4 × 20	1.0 - 1.3
2075 - 2114, 4077 - 4124	M4 × 30	1.0 - 1.3
2143 - 2273, 4156 - 4302	M5 × 25	2.0 - 2.5

## 5.3 UL Standards



Figure 5.16 UL/cUL Mark

The UL/cUL Mark identifies that this product conforms to rigid safety standards. This mark appears on products in the United States and Canada. It shows UL approval, which identifies that the product complies with safety standards after careful inspection and assessment. You must use UL Listed or UL Recognized parts for all primary components that are built into electrical equipment that has UL approval.

This product has been tested in accordance with UL standard UL508C, and has been verified to be in compliance with UL standards.

Machines and devices integrated with this product must satisfy the following conditions for compliance with UL standards.

### ◆ Area of Use

Install this product in a location with Overvoltage Category III and pollution degree 2 or less.

### ■ Ambient Temperature Setting

Maintain the ambient temperature within the following ranges according to the enclosure type.

- IP20/UL Type 1 and IP55/UL Type 12: -10 °C to +40 °C (14 °F to 104 °F)
- IP20/UL Open Type: -10 °C to +50 °C (14 °F to 122 °F)

### ◆ Wire the Main Circuit Terminal Block

Wire the main circuit terminal block correctly as specified by the instructions in this manual.

To comply with UL standards on drive models 2075 to 2273 and 4077 to 4302, use UL Listed closed-loop crimp terminals. Use the tools recommend by the terminal manufacturer to crimp the closed-loop crimp terminal. Refer to [Ferrules and Closed-Loop Crimp Terminals on page 216](#) for more information about UL Listed closed-loop crimp terminals.

To select the correct wire gauge, refer to [Three-Phase 208 V Class Wire Gauges and Torques \(Models: 2xxxxB/F/V without Main Switch\) on page 76](#) and [Three-Phase 480 V Class Wire Gauges and Torques \(Models: 4xxxxB/F/V without Main Switch\) on page 78](#) or [Three-Phase 208 V Class Wire Gauges and Torques \(Models: 2xxxxT with Main Switch\) on page 81](#) and [Three-Phase 480 V Class Wire Gauges and Torques \(Models: 4xxxxT with Main Switch\) on page 83](#).

Refer to [Main Circuit Terminal Block Wiring Procedure on page 87](#) for more information about wiring procedures and precautions.

### ◆ Ferrules and Closed-Loop Crimp Terminals

To comply with UL standards on drive models 2075 to 2273 and 4077 to 4302, use UL Listed closed-loop crimp terminals. Use the tools recommend by the terminal manufacturer to crimp the closed-loop crimp terminal. Yaskawa recommends closed-loop crimp terminals from PANDUIT Corp.

Install UL Recognized heat-shrinkable tubes to the closed-loop crimp terminals. If you do not use the tubes with the closed-loop crimp terminals, the insulating distance will be too short and it can cause short circuits.

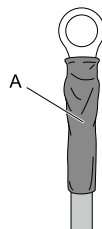

### A - UL Recognized heat-shrinkable tube

Comply with local standards for correct wire gauges in the region where the drive is used.

Refer to [Table 5.9](#) or [Table 5.10](#) to select ferrules and crimp terminals as specified by drive model and wire gauge.

#### Note:

To comply with UL standards, use UL Listed vinylcoated insulated copper wires for operation with a continuous maximum permitted temperature of 75 °C at 600 V.

**Table 5.9 Ferrules and Closed-Loop Crimp Terminals (Models: 2xxxxB/F/V and 4xxxxB/F/V without Main Switch)**

Model	Terminals	Recommended Gauge AWG, kcmil	Ferrule <sup>*1</sup>	Crimp Terminal Part Number Manufacturer: PANDUIT Corp.		
				Type LCA	Type P	Type S
2011	R/L1, S/L2, T/L3	14	F80-10	N/A	N/A	N/A
	U/T1, V/T2, W/T3	14	F80-10	N/A	N/A	N/A
	-, +1	14	F80-10	N/A	N/A	N/A
	⊕	12	N/A	LCA10-14-L	P10-14R-L	N/A
2017	R/L1, S/L2, T/L3	12	F81-10	N/A	N/A	N/A
	U/T1, V/T2, W/T3	10	F82-10	N/A	N/A	N/A
	-, +1	10	F82-10	N/A	N/A	N/A
	⊕	10	N/A	LCA10-14-L	P10-14R-L	N/A
2024	R/L1, S/L2, T/L3	10	F82-10	N/A	N/A	N/A
	U/T1, V/T2, W/T3	8	F83-12	N/A	N/A	N/A
	-, +1	8	F83-12	N/A	N/A	N/A
	⊕	10	N/A	LCA10-14-L	P10-14R-L	N/A
2031	R/L1, S/L2, T/L3	8	F83-12	N/A	N/A	N/A
	U/T1, V/T2, W/T3	8	F83-12	N/A	N/A	N/A
	-, +1	8	F83-12	N/A	N/A	N/A
	⊕	10	N/A	LCA10-14-L	P10-14R-L	N/A
2046	R/L1, S/L2, T/L3	8	F83-18	N/A	N/A	N/A
	U/T1, V/T2, W/T3	6	F84-18	N/A	N/A	N/A
	-, +1	6	F84-18	N/A	N/A	N/A
	⊕	8	N/A	LCA8-14-L	P8-14R-Q	S8-14R-Q
2059	R/L1, S/L2, T/L3	4	F85-18	N/A	N/A	N/A
	U/T1, V/T2, W/T3	4	F85-18	N/A	N/A	N/A
	-, +1	4	F85-18	N/A	N/A	N/A
	⊕	6	N/A	LCA6-14-L	P6-14R-E	S6-14R-E

## 5.3 UL Standards

Model	Terminals	Recommended Gauge AWG, kcmil	Ferrule <sup>*1</sup>	Crimp Terminal Part Number Manufacturer: PANDUIT Corp.		
				Type LCA	Type P	Type S
2075	R/L1, S/L2, T/L3	4	N/A	LCA4-56-L	P4-56R-E	S4-56R-E
	U/T1, V/T2, W/T3	3 or 2	N/A	LCA4-56-L or LCA2-56-Q	P2-56R-X <sup>*2</sup>	S2-56R-X <sup>*2</sup>
	-, +1	2	N/A	LCA2-56-Q	P2-56R-X	S2-56R-X
	⊕	6	N/A	LCA6-56-L	P6-56R-E	S6-56R-E
2088	R/L1, S/L2, T/L3	3 or 2	N/A	LCA4-56-L or LCA2-56-Q	P2-56R-X <sup>*2</sup>	S2-56R-X <sup>*2</sup>
	U/T1, V/T2, W/T3	2	N/A	LCA2-56-Q	P2-56R-X	S2-56R-X
	-, +1	1	N/A	LCA1-56-E	N/A	S2-56R-X
	⊕	6	N/A	LCA6-56-L	P6-56R-E	S6-56R-E
2114	R/L1, S/L2, T/L3	1/0	N/A	LCA1/0-56-X	N/A	S1/0-56R-X
	U/T1, V/T2, W/T3	1/0	N/A	LCA1/0-56-X	N/A	S1/0-56R-X
	-, +1	2/0	N/A	LCA2/0-56-X	N/A	S2/0-56R-X
	⊕	6	N/A	LCA6-56-L	P6-56R-E	S6-56R-E
2143	R/L1, S/L2, T/L3	2/0	N/A	LCA2/0-56-X	N/A	S2/0-56R-X
	U/T1, V/T2, W/T3	3/0	N/A	LCA3/0-56-X	N/A	S3/0-56R-5
	-, +1	3/0	N/A	LCA3/0-56-X	N/A	S3/0-56R-5
	⊕	4	N/A	LCA4-56-L	P4-56R-E	S4-56R-E
2169	R/L1, S/L2, T/L3	3/0	N/A	LCA3/0-56-X	N/A	S3/0-56R-5
	U/T1, V/T2, W/T3	4/0	N/A	LCA4/0-56-X	N/A	S4/0-56R-5
	-, +1	1/0 × 2	N/A	LCA1/0-56-X	N/A	S1/0-56R-X
	⊕	4	N/A	LCA4-56-L	P4-56R-E	S4-56R-E
2211	R/L1, S/L2, T/L3	1/0 × 2	N/A	LCA1/0-12-X	N/A	S1/0-12R-X
	U/T1, V/T2, W/T3	1/0 × 2	N/A	LCA1/0-12-X	N/A	S1/0-12R-X
	-, +1	1/0 × 2	N/A	LCA1/0-12-X	N/A	S1/0-12R-X
	⊕	3 or 2	N/A	LCA4-12-L or LCA2-12-Q	P2-12R-X <sup>*2</sup>	S2-12R-X <sup>*2</sup>
2273	R/L1, S/L2, T/L3	2/0 × 2	N/A	LCA2/0-12-X	N/A	S2/0-76R-X or S2/0-12R-X
	U/T1, V/T2, W/T3	2/0 × 2	N/A	LCA2/0-12-X	N/A	S2/0-76R-X or S2/0-12R-X
	-, +1	3/0 × 2	N/A	LCA3/0-12-X	N/A	S3/0-76R-5 or S3/0-12R-5
	⊕	2	N/A	LCA2-12-Q	P2-12R-X	S2-12R-X
4005	R/L1, S/L2, T/L3	14	F80-10	N/A	N/A	N/A
	U/T1, V/T2, W/T3	14	F80-10	N/A	N/A	N/A
	-, +1	14	F80-10	N/A	N/A	N/A
	⊕	14	N/A	LCA10-14-L	P10-14R-L	N/A



Model	Terminals	Recommended Gauge AWG, kcmil	Ferrule */	Crimp Terminal Part Number Manufacturer: PANDUIT Corp.		
				Type LCA	Type P	Type S
4008	R/L1, S/L2, T/L3	14	F80-10	N/A	N/A	N/A
	U/T1, V/T2, W/T3	14	F80-10	N/A	N/A	N/A
	-, +1	14	F80-10	N/A	N/A	N/A
	⊕	14	N/A	LCA10-14-L	P10-14R-L	N/A
4011	R/L1, S/L2, T/L3	14	F80-10	N/A	N/A	N/A
	U/T1, V/T2, W/T3	14	F80-10	N/A	N/A	N/A
	-, +1	14	F80-10	N/A	N/A	N/A
	⊕	12	N/A	LCA10-14-L	P10-14R-L	N/A
4014	R/L1, S/L2, T/L3	14	F80-10	N/A	N/A	N/A
	U/T1, V/T2, W/T3	12	F81-10	N/A	N/A	N/A
	-, +1	12	F81-10	N/A	N/A	N/A
	⊕	10	N/A	LCA10-14-L	P10-14R-L	N/A
4021	R/L1, S/L2, T/L3	10	F82-10	N/A	N/A	N/A
	U/T1, V/T2, W/T3	10	F82-10	N/A	N/A	N/A
	-, +1	10	F82-10	N/A	N/A	N/A
	⊕	10	N/A	LCA10-14-L	P10-14R-L	N/A
4027	R/L1, S/L2, T/L3	10	F82-10	N/A	N/A	N/A
	U/T1, V/T2, W/T3	8	F83-12	N/A	N/A	N/A
	-, +1	8	F83-12	N/A	N/A	N/A
	⊕	10	N/A	LCA10-14-L	P10-14R-L	N/A
4034	R/L1, S/L2, T/L3	8	F83-12	N/A	N/A	N/A
	U/T1, V/T2, W/T3	8	F83-12	N/A	N/A	N/A
	-, +1	8	F83-12	N/A	N/A	N/A
	⊕	10	N/A	LCA10-14-L	P10-14R-L	N/A
4040	R/L1, S/L2, T/L3	8	F83-18	N/A	N/A	N/A
	U/T1, V/T2, W/T3	8	F83-18	N/A	N/A	N/A
	-, +1	6	F84-18	N/A	N/A	N/A
	⊕	8	N/A	LCA8-14-L	P8-14R-Q	S8-14R-Q
4052	R/L1, S/L2, T/L3	6	F84-18	N/A	N/A	N/A
	U/T1, V/T2, W/T3	6	F84-18	N/A	N/A	N/A
	-, +1	4	F85-18	N/A	N/A	N/A
	⊕	8	N/A	LCA8-14-L	P8-14R-Q	S8-14R-Q
4065	R/L1, S/L2, T/L3	4	F85-18	N/A	N/A	N/A
	U/T1, V/T2, W/T3	4	F85-18	N/A	N/A	N/A
	-, +1	4	F85-18	N/A	N/A	N/A
	⊕	6	N/A	LCA6-14-L	P6-14R-E	S6-14R-E

## 5.3 UL Standards

Model	Terminals	Recommended Gauge AWG, kcmil	Ferrule <sup>*1</sup>	Crimp Terminal Part Number Manufacturer: PANDUIT Corp.		
				Type LCA	Type P	Type S
4077	R/L1, S/L2, T/L3	4	N/A	LCA4-56-L	P4-56R-E	S4-56R-E
	U/T1, V/T2, W/T3	3 or 2	N/A	LCA4-56-L or LCA2-56-Q	P2-56R-X <sup>*2</sup>	S2-56R-X <sup>*2</sup>
	-, +1	2	N/A	LCA2-56-Q	P2-56R-X	S2-56R-X
	⊕	6	N/A	LCA6-56-L	P6-56R-E	S6-56R-E
4096	R/L1, S/L2, T/L3	2	N/A	LCA2-56-Q	P2-56R-X	S2-56R-X
	U/T1, V/T2, W/T3	1	N/A	LCA1-56-E	N/A	S2-56R-X
	-, +1	1	N/A	LCA1-56-E	N/A	S2-56R-X
	⊕	6	N/A	LCA6-56-L	P6-56R-E	S6-56R-E
4124	R/L1, S/L2, T/L3	1/0	N/A	LCA1/0-56-X	N/A	S1/0-56R-X
	U/T1, V/T2, W/T3	2/0	N/A	LCA2/0-56-X	N/A	S2/0-56R-X
	-, +1	2/0	N/A	LCA2/0-56-X	N/A	S2/0-56R-X
	⊕	4	N/A	LCA4-56-L	P4-56R-E	S4-56R-E
4156	R/L1, S/L2, T/L3	2/0	N/A	LCA2/0-56-X	N/A	S2/0-56R-X
	U/T1, V/T2, W/T3	3/0	N/A	LCA3/0-56-X	N/A	S3/0-56R-5
	-, +1	4/0	N/A	LCA4/0-56-X	N/A	S4/0-56R-5
	⊕	4	N/A	LCA4-56-L	P4-56R-E	S4-56R-E
4180	R/L1, S/L2, T/L3	1/0 × 2	N/A	LCA1/0-12-X	N/A	S1/0-12R-X
	U/T1, V/T2, W/T3	1/0 × 2	N/A	LCA1/0-12-X	N/A	S1/0-12R-X
	-, +1	1/0 × 2	N/A	LCA1/0-12-X	N/A	S1/0-12R-X
	⊕	3 or 2	N/A	LCA4-12-L or LCA2-12-Q	P2-12R-X <sup>*2</sup>	S2-12R-X <sup>*2</sup>
4240	R/L1, S/L2, T/L3	1/0 × 2	N/A	LCA1/0-12-X	N/A	S1/0-12R-X
	U/T1, V/T2, W/T3	1/0 × 2	N/A	LCA1/0-12-X	N/A	S1/0-12R-X
	-, +1	2/0 × 2	N/A	LCA2/0-12-X	N/A	S2/0-76R-X or S2/0-12R-X
	⊕	2	N/A	LCA2-12-Q	P2-12R-X	S2-12R-X
4302	R/L1, S/L2, T/L3	3/0 × 2	N/A	LCA3/0-12-X	N/A	S3/0-12R-5
	U/T1, V/T2, W/T3	3/0 × 2	N/A	LCA3/0-12-X	N/A	S3/0-12R-5
	-, +1	4/0 × 2	N/A	LCA4/0-12-X	N/A	S4/0-12R-5
	⊕	1/0	N/A	LCA1/0-12-X	N/A	S1/0-12R-X

\*1 Use recommended ferrule or bare wire.

\*2 The recommended wire gauge for this part is AWG 2.

Table 5.10 Ferrules and Closed-Loop Crimp Terminals (Models: 2xxxxT and 4xxxxT with Main Switch)

Model	Terminals *1	Recommended Gauge AWG, kcmil	Ferrule *2	Crimp Terminal Part Number Manufacturer: PANDUIT Corp.		
				Type LCA	Type P	Type S
2011	R/L1, S/L2, T/L3	14	F80-10	N/A	N/A	N/A
	U/T1, V/T2, W/T3	14	F80-10	N/A	N/A	N/A
	⊕	12	N/A	LCA10-14-L	P10-14R-L	N/A
2017	R/L1, S/L2, T/L3	12	F81-10	N/A	N/A	N/A
	U/T1, V/T2, W/T3	10	F82-10	N/A	N/A	N/A
	⊕	10	N/A	LCA10-14-L	P10-14R-L	N/A
2024	R/L1, S/L2, T/L3	10	F82-15	N/A	N/A	N/A
	U/T1, V/T2, W/T3	8	F83-12	N/A	N/A	N/A
	⊕	10	N/A	LCA10-14-L	P10-14R-L	N/A
2031	R/L1, S/L2, T/L3	8	F83-15	N/A	N/A	N/A
	U/T1, V/T2, W/T3	8	F83-12	N/A	N/A	N/A
	⊕	10	N/A	LCA10-14-L	P10-14R-L	N/A
2046	R/L1, S/L2, T/L3	8	F83-18	N/A	N/A	N/A
	U/T1, V/T2, W/T3	6	F84-18	N/A	N/A	N/A
	⊕	8	N/A	LCA8-14-L	P8-14R-Q	S8-14R-Q
2059	R/L1, S/L2, T/L3	4	F85-18	N/A	N/A	N/A
	U/T1, V/T2, W/T3	4	F85-18	N/A	N/A	N/A
	⊕	6	N/A	LCA6-14-L	P6-14R-E	S6-14R-E
2075	R/L1, S/L2, T/L3	4	N/A	LCA4-56-L	P4-56R-E	S4-56R-E
	U/T1, V/T2, W/T3	3 or 2	N/A	LCA4-56-L or LCA2-56-Q	P2-56R-X *3	S2-56R-X *3
	⊕	6	N/A	LCA6-56-L	P6-56R-E	S6-56R-E
2088	R/L1, S/L2, T/L3	3 or 2	N/A	LCA4-56-L or LCA2-56-Q	P2-56R-X *3	S2-56R-X *3
	U/T1, V/T2, W/T3	2	N/A	LCA2-56-Q	P2-56R-X	S2-56R-X
	⊕	6	N/A	LCA6-56-L	P6-56R-E	S6-56R-E
2114	R/L1, S/L2, T/L3	1/0	N/A	LCA1/0-56-X	N/A	S1/0-56R-X
	U/T1, V/T2, W/T3	1/0	N/A	LCA1/0-56-X	N/A	S1/0-56R-X
	⊕	6	N/A	LCA6-56-L	P6-56R-E	S6-56R-E
4005	R/L1, S/L2, T/L3	14	F80-10	N/A	N/A	N/A
	U/T1, V/T2, W/T3	14	F80-10	N/A	N/A	N/A
	⊕	14	N/A	LCA10-14-L	P10-14R-L	N/A
4008	R/L1, S/L2, T/L3	14	F80-10	N/A	N/A	N/A
	U/T1, V/T2, W/T3	14	F80-10	N/A	N/A	N/A
	⊕	14	N/A	LCA10-14-L	P10-14R-L	N/A

## 5.3 UL Standards

Model	Terminals *1	Recommended Gauge AWG, kcmil	Ferrule *2	Crimp Terminal Part Number Manufacturer: PANDUIT Corp.		
				Type LCA	Type P	Type S
4011	R/L1, S/L2, T/L3	14	F80-10	N/A	N/A	N/A
	U/T1, V/T2, W/T3	14	F80-10	N/A	N/A	N/A
	⊕	12	N/A	LCA10-14-L	P10-14R-L	N/A
4014	R/L1, S/L2, T/L3	14	F80-10	N/A	N/A	N/A
	U/T1, V/T2, W/T3	12	F81-10	N/A	N/A	N/A
	⊕	10	N/A	LCA10-14-L	P10-14R-L	N/A
4021	R/L1, S/L2, T/L3	10	F82-15	N/A	N/A	N/A
	U/T1, V/T2, W/T3	10	F82-10	N/A	N/A	N/A
	⊕	10	N/A	LCA10-14-L	P10-14R-L	N/A
4027	R/L1, S/L2, T/L3	10	F82-15	N/A	N/A	N/A
	U/T1, V/T2, W/T3	8	F83-12	N/A	N/A	N/A
	⊕	10	N/A	LCA10-14-L	P10-14R-L	N/A
4034	R/L1, S/L2, T/L3	8	F83-15	N/A	N/A	N/A
	U/T1, V/T2, W/T3	8	F83-12	N/A	N/A	N/A
	⊕	10	N/A	LCA10-14-L	P10-14R-L	N/A
4040	R/L1, S/L2, T/L3	8	F83-18	N/A	N/A	N/A
	U/T1, V/T2, W/T3	8	F83-18	N/A	N/A	N/A
	⊕	8	N/A	LCA8-14-L	P8-14R-Q	S8-14R-Q
4052	R/L1, S/L2, T/L3	6	F84-18	N/A	N/A	N/A
	U/T1, V/T2, W/T3	6	F84-18	N/A	N/A	N/A
	⊕	8	N/A	LCA8-14-L	P8-14R-Q	S8-14R-Q
4065	R/L1, S/L2, T/L3	4	F85-18	N/A	N/A	N/A
	U/T1, V/T2, W/T3	4	F85-18	N/A	N/A	N/A
	⊕	6	N/A	LCA6-14-L	P6-14R-E	S6-14R-E
4077	R/L1, S/L2, T/L3	4	N/A	LCA4-56-L	P4-56R-E	S4-56R-E
	U/T1, V/T2, W/T3	3 or 2	N/A	LCA4-56-L or LCA2-56-Q	P2-56R-X *3	S2-56R-X *3
	⊕	6	N/A	LCA6-56-L	P6-56R-E	S6-56R-E
4096	R/L1, S/L2, T/L3	2	N/A	LCA2-56-Q	P2-56R-X	S2-56R-X
	U/T1, V/T2, W/T3	1	N/A	LCA1-56-E	N/A	S2-56R-X
	⊕	6	N/A	LCA6-56-L	P6-56R-E	S6-56R-E

\*1 You cannot use terminals - and +1 on IP55/UL Type 12 drives with Main Switch.

\*2 Use recommended ferrule or bare wire.

\*3 The recommended wire gauge for this part is AWG 2.

### ◆ Short Circuit Protection Requirements for UL Listing

Refer to *Protect the Drive during Failures on page 124* to comply with UL 508C.

## ◆ Low Voltage Wiring for Control Circuit Terminals

You must provide low voltage wiring as specified by the National Electric Code (NEC), the Canadian Electric Code, Part I (CEC), and local codes. Yaskawa recommends the NEC class 1 circuit conductor. Use the UL Listed class 2 power supply for external power supply.

**Table 5.11 Control Circuit Terminal Power Supplies**

Input/Output	Terminals	Power Supply Specifications
Digital input	S1 to S7, SN, SC, SP	Uses the LVLC power supply in the drive. Use the UL Listed class 2 power supply for external power supply.
Analog input	A1 to A2, AC, +V	Uses the LVLC power supply in the drive. Use the UL Listed class 2 power supply for external power supply.
Analog output	FM, AM, AC	Uses the LVLC power supply in the drive.
Safe disable input	H1, H2, HC	Uses the LVLC power supply in the drive. Use the UL Listed class 2 power supply for external power supply.
Serial communication input/output	D+, D-, AC	Uses the LVLC power supply in the drive. Use the UL Listed class 2 power supply for external power supply.
24 V external power supply input/output	PS, AC, +P	Use the UL Listed class 2 power supply.

## ◆ Drive Motor Overload and Overheat Protection

The drive motor overload and overheat protection function complies with the National Electric Code (NEC) and the Canadian Electric Code, Part I (CEC).

Set the Motor Rated Current and *L1-01 through L1-04 [Motor Overload Protection Select]* correctly to enable motor overload and overheat protection.

Refer to the control method and set the motor rated current with *E2-01 [Motor Rated Current (FLA)]*, *E5-03 [PM Motor Rated Current (FLA)]*, or *E9-06 [Motor Rated Current (FLA)]*.

### ■ E2-01: Motor Rated Current (FLA)

No. (Hex.)	Name	Description	Default (Range)
E2-01 (030E)	Motor Rated Current (FLA)	<input type="checkbox"/> V/f <input checked="" type="checkbox"/> OLV/PM <input type="checkbox"/> EZOLV Sets the motor rated current in amps.	Determined by o2-04 (10% to 200% of the drive rated current)

**Note:**

- If *E2-01* < *E2-03 [Motor No-Load Current]* the drive will detect *oPE02 [Parameter Range Setting Error]*.
- The default settings and setting ranges are in these units:  
–0.01 A: 2011 to 2046, 4005 to 4014  
–0.1 A: 2059 to 2273, 4021 to 4302

The value set for *E2-01* becomes the reference value for motor protection and the torque limit. Enter the motor rated current as written on the motor nameplate. The value of *E2-01* is automatically set to the value input for “Motor Rated Current” by the Auto-Tuning process.

### ■ E5-03: PM Motor Rated Current (FLA)

No. (Hex.)	Name	Description	Default (Range)
E5-03 (032B)	PM Motor Rated Current (FLA)	<input type="checkbox"/> V/f <input checked="" type="checkbox"/> OLV/PM <input type="checkbox"/> EZOLV Sets the PM motor rated current (FLA).	Determined by o2-04 (10% to 200% of the drive rated current)

**Note:**

When the drive model changes, the display units for this parameter also change.

- 0.01 A: 2011 to 2046, 4005 to 4014
- 0.1 A: 2059 to 2273, 4021 to 4302

The drive automatically sets *E5-03* to the value input for “PM Motor Rated Current” after you do these types of Auto-Tuning:

- PM Motor Parameter Settings
- PM Stationary Auto-Tuning
- PM StaTun for Stator Resistance
- PM Rotational Auto-Tuning

### ■ E9-06: Motor Rated Current (FLA)

No. (Hex.)	Name	Description	Default (Range)
E9-06 (11E9)	Motor Rated Current (FLA)	<div style="display: flex; gap: 5px;"> <span>V/f</span> <span>OLV/PM</span> <span><b>EZOLV</b></span> </div> Sets the motor rated current in amps.	Determined by E9-01 and o2-04 (10% to 200% of the drive rated current)

**Note:**

When the drive model changes, the display units for this parameter also change.

- 0.01 A: 2011 to 2046, 4005 to 4014
- 0.1 A: 2059 to 2273, 4021 to 4302

The setting value of *E9-06* is the reference value for motor protection. Enter the motor rated current shown on the motor nameplate. Auto-Tuning the drive will automatically set *E9-06* to the value input for “Motor Rated Current”.

### ■ L1-01: Motor Overload (oL1) Protection

No. (Hex.)	Name	Description	Default (Range)
L1-01 (0480)	Motor Overload (oL1) Protection	<div style="display: flex; gap: 5px;"> <span>V/f</span> <span>OLV/PM</span> <span><b>EZOLV</b></span> </div> Sets the motor overload protection with electronic thermal protectors.	Determined by A1-02 (0 - 4)

This parameter enables and disables the motor overload protection with electronic thermal protectors.

The cooling capability of the motor changes when the speed control range of the motor changes. Use an electronic thermal protector that aligns with the permitted load characteristics of the motor to select motor protection.

The electronic thermal protector of the drive uses these items to calculate motor overload tolerance and supply overload protection for the motor:

- Output Current
- Output Frequency
- Motor thermal characteristics
- Time characteristics

If the drive detects motor overload, the drive will trigger an *oL1* [*Motor Overload*] and stop the drive output.

Set *H2-01 = 1F* [*Term M1-M2 Function Selection = Motor Overload Alarm (oL1)*] to set a motor overload alarm. If the motor overload level is more than 90% of the *oL1* detection level, the output terminal turns ON and triggers an overload alarm.

#### 0 : Disabled

Disable motor protection when motor overload protection is not necessary or when the drive is operating more than one motor.

Refer to [Figure 5.17](#) for an example of the circuit configuration to connect more than one motor to one drive.

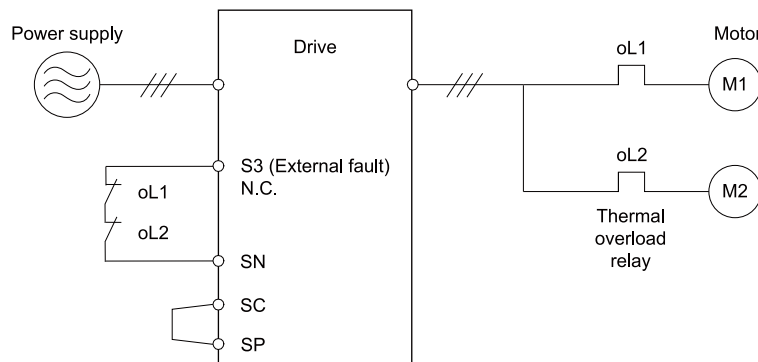

**Figure 5.17 Protection Circuit Configuration to Connect More than One Motor to One Drive**

**NOTICE:** When you connect more than one motor to one drive or when the motor amp rating is higher than the drive amp rating, set L1-01 = 0 [Motor Overload (oL1) Protection = Disabled] and install thermal overload relays for each motor. The electronic thermal protection of the drive will not function and it can cause damage to the motor.

**1 : Variable Torque**

Use this setting for general-purpose motors with a 60 Hz base frequency.

The overload tolerance decreases as motor speed decreases because the cooling fan speed decreases and the ability of the motor to cool decreases in the low speed range.

The overload tolerance characteristics of the motor change the trigger point for the electronic thermal protector. This provides motor overheat protection from low speed to high speed across the full speed range.

Load Tolerance	Cooling Capability	Overload Characteristics (at 100% motor load)
	<p>This motor is designed to operate with commercial line power. Operate at a 60 Hz base frequency to maximize the motor cooling ability.</p>	<p>If the motor operates at frequencies less than 60 Hz, the drive will detect oL1. The drive triggers a fault relay output and the motor coasts to stop.</p>

**4 : PM Variable Torque**

Use this setting for PM motors with derated torque characteristics.

The overload tolerance decreases as motor speed decreases because the cooling fan speed decreases and the ability of the motor to cool decreases in the low speed range.

The overload tolerance characteristics of the motor change the trigger point for the electronic thermal protector. This provides motor overheat protection from low speed to high speed across the full speed range.

Load Tolerance	Cooling Capability	Overload Characteristics (at 100% motor load)
	<p>This motor is designed to withstand increased temperatures during continuous operation at rated speed and rated torque.</p>	<p>If the motor operates continuously at lower speed than rated rotation speed at more than 100% torque, the drive will detect oL1. The drive triggers a fault relay output and the motor coasts to stop.</p>

Standards Compliance

■ **L1-02: Motor Overload Protection Time**

No. (Hex.)	Name	Description	Default (Range)
L1-02 (0481)	Motor Overload Protection Time	<span style="border: 1px solid black; padding: 2px;">V/f</span> <span style="border: 1px solid black; padding: 2px;">OLV/PM</span> <span style="border: 1px solid black; padding: 2px;">EZOLV</span> Sets the operation time for the electronic thermal protector of the drive to prevent damage to the motor. Usually it is not necessary to change this setting.	1.0 min (0.1 - 5.0 min)

Set the overload tolerance time to the length of time that the motor can operate at 150% load from continuous operation at 100% load.

When the motor operates at 150% load continuously for 1 minute after continuous operation at 100% load (hot start), the default setting triggers the electronic thermal protector.

Figure 5.18 shows an example of the electronic thermal protector operation time. Motor overload protection operates in the range between a cold start and a hot start.

This example shows a general-purpose motor operating at the base frequency with L1-02 set to 1.0 min.

- **Cold start**  
Shows the motor protection operation time characteristics when the overload occurs immediately after starting operation from a complete stop.
- **Hot start**  
Shows the motor protection operation time characteristics when overload occurs from continuous operation below the motor rated current.

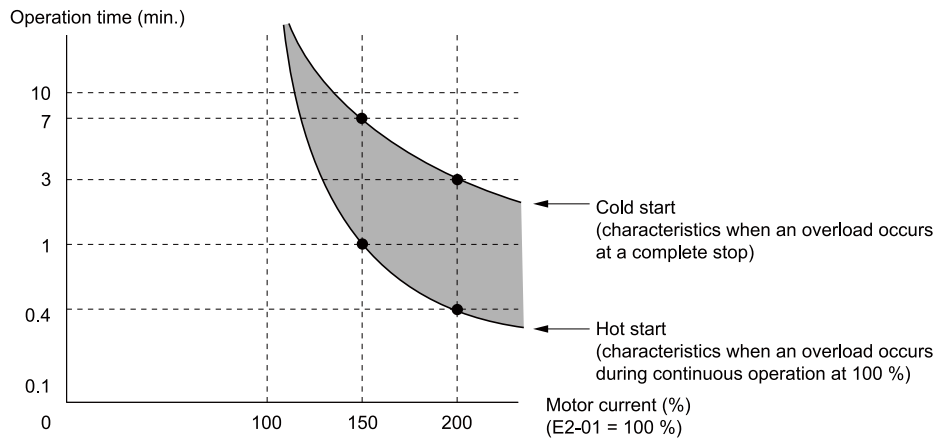

Figure 5.18 Protection Operation Time for a General-purpose Motor at Rated Output Frequency

■ **L1-03: Motor Thermistor oH Alarm Select**

No. (Hex.)	Name	Description	Default (Range)
L1-03 (0482)	Motor Thermistor oH Alarm Select	<span style="border: 1px solid black; padding: 2px;">V/f</span> <span style="border: 1px solid black; padding: 2px;">OLV/PM</span> <span style="border: 1px solid black; padding: 2px;">EZOLV</span> Sets drive operation when the PTC input signal entered into the drive is at the oH3 [Motor Overheat (PTC Input)] detection level.	3 (0 - 3)

**0 : Ramp to Stop**

The drive ramps the motor to stop in the deceleration time. Fault relay output terminal MA-MC turns ON and MB-MC turns OFF.

**1 : Coast to Stop**

The output turns OFF and the motor coasts to stop. Fault relay output terminal MA-MC turns ON, and MB-MC turns OFF.

**2 : Fast Stop (Use C1-09)**

The drive stops the motor in the deceleration time set in C1-09 [Fast Stop Time]. Fault relay output terminal MA-MC turns ON, and MB-MC turns OFF.

**3 : Alarm Only**

The keypad shows oH3, and operation continues. The output terminal set for Alarm [H2-01 to H2-03 = 10] turns ON.



## ■ L1-04: Motor Thermistor oH Fault Select

No. (Hex.)	Name	Description	Default (Range)
L1-04 (0483)	Motor Thermistor oH Fault Select	<div style="display: flex; gap: 5px;"> <span style="background-color: black; color: white; padding: 2px;">V/f</span> <span style="background-color: black; color: white; padding: 2px;">OLV/PM</span> <span style="background-color: black; color: white; padding: 2px;">EZOLV</span> </div> <p>Sets the drive operation when the PTC input signal to the drive is at the <i>oHA</i> [Motor Overheat Fault (PTC Input)] detection level.</p>	1 (0 - 2)

### 0 : Ramp to Stop

The drive ramps the motor to stop in the deceleration time. Fault relay output terminal MA-MC turns ON, and MB-MC turns OFF.

### 1 : Coast to Stop

The output turns OFF and the motor coasts to stop. Fault relay output terminal MA-MC turns ON, and MB-MC turns OFF.

### 2 : Fast Stop (Use C1-09)

The drive stops the motor in the deceleration time set in *C1-09* [Fast Stop Time]. Fault relay output terminal MA-MC turns ON, and MB-MC turns OFF.

## 5.4 China RoHS Compliance



**Figure 5.19 China RoHS Mark**

The China RoHS mark is displayed on products containing six specified hazardous substances that are in excess of regulatory limits, based on the “Administrative Measures for the Restriction of the Use of Hazardous Substances in Electrical and Electronic Products” and “Marking for the Restricted Use of Hazardous Substances in Electronic and Electrical Products” (SJ/T 11364-2014), which were promulgated on January 26, 2016. The number displayed in the center of the mark indicates the environment-friendly use period (number of years) in which electrical and electronic products that are being produced, sold, or imported to China can be used. The date of manufacture of the electrical and electronic product is the starting date of the environment-friendly use period for the product. The six specified hazardous substances contained in the product will not leak outside of the product during normal use within this period and will have no serious impact on the environment, the human body, or property.

The environment-friendly use period for this product is 15 years. This period is not the product warranty period.

### ◆ Information on Hazardous Substances in This Product

Table 5.12 shows the details on hazardous substances contained in this product.

**Table 5.12 Contents of Hazardous Substances in This Product**

Parts Name	Hazardous Substances					
	Lead (Pb)	Mercury (Hg)	Cadmium (Cd)	Hexavalent Chromium (Cr(VI))	Polybrominated Biphenyls (PBB)	Polybrominated Diphenyl Ethers (PBDE)
Circuit Board	×	○	○	○	○	○
Electronic Parts	×	○	○	○	○	○
Brass Screw	×	○	○	○	○	○
Aluminum Die Casting	×	○	○	○	○	○

This table has been prepared in accordance with the provisions outlined in SJ/T 11364.

○: Indicates that said hazardous substance contained in all of the homogeneous materials for this part is below or equal to the limit requirement of GB/T 26572.

×: Indicates that said hazardous substance contained in at least one of the homogeneous materials used for this part is above the limit requirement of GB/T 26572.

**Note:**

This product complies with EU RoHS directives. In this table, "×" indicates that hazardous substances that are exempt from EU RoHS directives are contained.

## 5.5 对应中国RoHS指令



图 5.20 中国RoHS标志

中国RoHS标志依据2016年1月26日公布的《电器电子产品有害物质限制使用管理办法》，以及《电子电气产品有害物质限制使用标识要求》（SJ/T 11364-2014）作成。电子电气产品中特定6种有害物质的含量超过规定值时，应标识此标志。中间的数字为在中国生产销售以及进口的电子电气产品的环保使用期限（年限）。电子电气产品的环保使用期限从生产日期算起。在期限内，正常使用产品的过程中，不会有特定的6种有害物质外泄进而对环境、人和财产造成深刻影响。

本产品的环保使用期限为15年。但需要注意的是环保使用期限并非产品的质量保证期限。

### ◆ 本产品中含有有害物质的信息

本产品中所含有有害物质的详细信息如表 5.13 所示。

表 5.13 本产品中有害物质的名称及含量

部件名称	有害物质					
	铅 (Pb)	汞 (Hg)	镉 (Cd)	六价铬 (Cr(VI))	多溴联苯 (PBB)	多溴二苯醚 (PBDE)
实装基板	×	○	○	○	○	○
电子元件	×	○	○	○	○	○
黄铜螺钉	×	○	○	○	○	○
铝压铸	×	○	○	○	○	○

本表格依据SJ/T 11364的规定编制。  
 ○:表示该有害物质在该部件所有均质材料中的含量均在GB/T 26572规定的限量要求以下。  
 ×:表示该有害物质至少在该部件的某一均质材料中的含量超出GB/T 26572规定的限量要求。  
 (注) 本产品符合欧盟RoHS指令。上表中的“×”表示含有欧盟RoHS指令豁免的有害物质。

## 5.6 Safe Disable Input



**Figure 5.21 TUV Mark**

The TUV mark identifies that the product complies with the safety standards.

This section gives precautions to support the Safe Disable input. Contact Yaskawa for more information.

The safety function complies with the standards shown in [Table 5.14](#).

**Table 5.14 Applied Safety Standards and Unified Standards**

Safety Standards	Unified Standards
Functional Safety	<ul style="list-style-type: none"> <li>• IEC 61800-5-2:2016 (SIL3)</li> <li>• EN 61800-5-2:2017 (SIL3)</li> <li>• EN 61508:2010 (SIL3)</li> <li>• IEC 61508:2010 (SIL3)</li> <li>• EN 62061:2005/A1:2013 (SIL CL3)</li> <li>• IEC 62061:2005+AMD1:2012+AMD2:2015 CSV (SIL CL3)</li> </ul>
Machine Safety	<ul style="list-style-type: none"> <li>• EN ISO 13849-1:2015 (Cat.III, PL e)</li> <li>• ISO 13849-1:2015 (Cat.III, PL e)</li> </ul>
EMC	<ul style="list-style-type: none"> <li>• IEC 61000-6-7:2014</li> <li>• EN 61000-6-7:2015</li> <li>• IEC 61326-3-1:2017</li> <li>• EN 61326-3-1:2017</li> </ul>
LVD	<ul style="list-style-type: none"> <li>• IEC 61800-5-1:2007+AMD1:2016</li> <li>• EN 61800-5-1:2007/A1:2017</li> </ul>

**Note:**

SIL = Safety Integrity Level.

### ◆ Safe Disable Specifications

The Safe Disable input provides the stop function that complies with “Safe Torque Off” as specified by IEC 61800-5-2:2016/EN 61800-5-2:2017. The Safe Disable input meets the requirements of EN ISO 13849-1 and IEC/EN 61508. It also has a safety status monitor to detect safety circuit errors.

When you install the drive as a component in a system, you must make sure that the system complies with the applicable safety standards.

Refer to [Table 5.15](#) for safety function specifications.

**Table 5.15 Safe Disable Specifications**

Item	Description
Input/Output	<ul style="list-style-type: none"> <li>• Input: 2 Safe Disable input (H1, H2) Signal ON level: 18 Vdc to 28 Vdc Signal OFF level: -4 Vdc to +4 Vdc</li> <li>• Output: 1 MFDO safety monitor output for external device monitor (EDM)</li> </ul>
Response time from when the input opens to when the drive output stops	3 ms or less
Response time from when the H1 and H2 terminal inputs open to when the EDM signal operates	20 ms or less
Failure probability	Less frequent operation request mode
	Frequent operation request mode or continuous mode
Performance level	The Safe Disable input complies with the performance level requirements of EN ISO 13849-1.

Item	Description
HFT (hardware fault tolerance)	N = 1
Type of subsystem	Type B

**Note:**

EDM = External Device Monitoring

PFD = Probability of Failure on Demand

PFH = Probability of Dangerous Failure per Hour

## ◆ Notes

**DANGER!** Sudden Movement Hazard. When you use the Safe Disable function in the safety system of a machine, do a full risk assessment for the system to make sure that all parts of the system comply with applicable safety standards. Incorrect application of the Safe Disable function can cause serious injury or death.

**DANGER!** Sudden Movement Hazard. If the output circuit of the drive is damaged and the Safe Disable function turns OFF the drive output to a permanent magnet (PM) motor, the motor can rotate 180 electrical degrees. Prevent damage to equipment and injury to personnel during this condition. Sudden motor movement can cause serious injury or death. It is possible for current to flow through the motor winding in these conditions.

**DANGER!** Electrical Shock Hazard. You cannot depend on the Safe Disable function to prevent electrical shock. Disconnect all power to the drive and wait for the time specified on the warning label before you remove covers. Check the drive for dangerous voltages before servicing or repair work. If you do work on the drive when it is energized and there is no cover over the electronic circuits, it can cause serious injury or death.

**WARNING!** Sudden Movement Hazard. Although the Safe Disable function is in operation, gravity or other external forces in the vertical axis can move the motor. Incorrect application of the Safe Disable function can cause serious injury or death.

**WARNING!** Sudden Movement Hazard. Do not use the drive output signals to control external holding brakes or dynamic brakes for functional safety. Use a system that conforms to the functional safety requirements. Incorrect application of the Safe Disable function can cause serious injury or death. Systems that use drive output signals (including EDM) for safety are not safe because drive output signals are not safety components.

**WARNING!** Sudden Movement Hazard. Connect the Safe Disable inputs to the devices as specified by the safety requirements. If you connect the Safe Disable inputs incorrectly, it can cause serious injury or death.

**WARNING!** Sudden Movement Hazard. To use the Safe Disable inputs, remove the jumpers between terminals H1-HC and H2-HC. If the Safe Disable circuit does not work correctly, it can cause serious injury or death.

**WARNING!** Sudden Movement Hazard. When you clear the Safe Disable input, make sure that the Safe Disable Monitor output operates correctly as the specification for Safe Disable function. If the Safe Disable circuit does not operate correctly, it can cause serious injury or death.

**WARNING!** Sudden Movement Hazard. Regularly examine the Safe Disable input and all other safety features. A system that does not operate correctly can cause serious injury or death.

**WARNING!** Sudden Movement Hazard. Only let approved personnel who know about the drive, instruction manual, and safety standards wire, examine, and maintain the Safe Disable input. If personnel are not approved, it can cause serious injury or death.

**WARNING!** Sudden Movement Hazard. Only use the Safe Disable Monitor (multi-function output terminal set to the EDM function) to monitor the Safe Disable status or to find a malfunction in the Safe Disable inputs. The monitor output is not a safety output. If you use the Safe Disable Monitor incorrectly, it can cause death or serious injury.

**Note:**

- Drives that have a built-in safety function must be replaced 10 years after first use.
- A maximum of 3 ms will elapse from when terminals H1 or H2 shut off until the drive switches to the “Safe Torque Off” status. Set the OFF status for terminals H1 and H2 to hold for at least 3 ms. The drive may not be able to switch to the “Safe Torque Off” status if terminals H1 and H2 are only open for less than 2 ms.

## ◆ Using the Safe Disable Function

### ■ Safe Disable Circuit

The Safe Disable circuit has two isolated channels (terminals H1 and H2) that stop the output transistors. The input can use the internal power supply of the drive.

Set the EDM function to one of the MFDO terminals [ $H2-xx = 21$  or  $121$ ] to monitor the status of the Safe Disable function. This is the “Safe Disable monitor output function”.

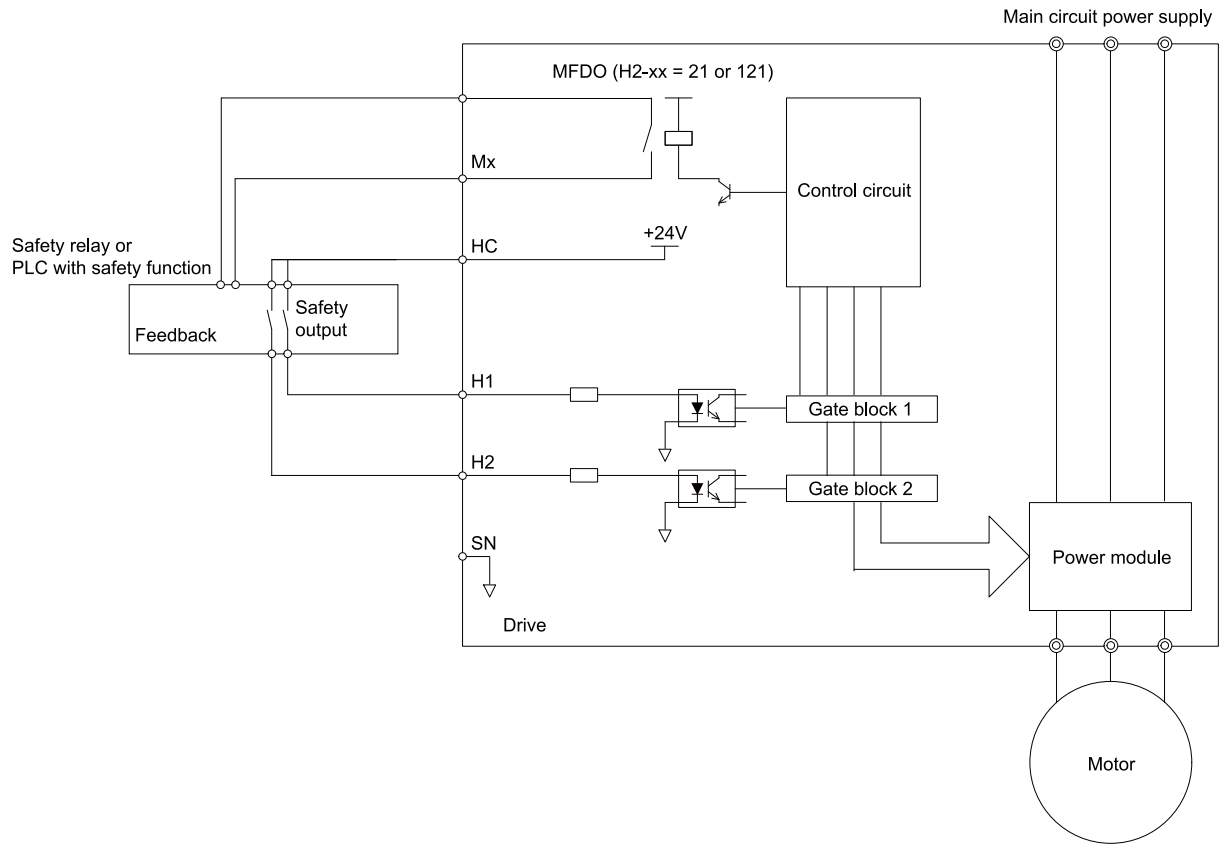

Figure 5.22 Safe Disable Function Wiring Example

■ Connect Safe Disable Input Contacts to Multiple Drives

To Use the Drive Internal Power Supply

Figure 5.23 shows an example of how to connect Safe Disable contacts.

Use terminals HC-SN on drive 1 to supply the power for the Safe Disable function on the applicable drives. These conditions limit the number of drives that you can connect:

- Internal power supply capacity
- Number of MFDIs used
- Supply current to the external sensors

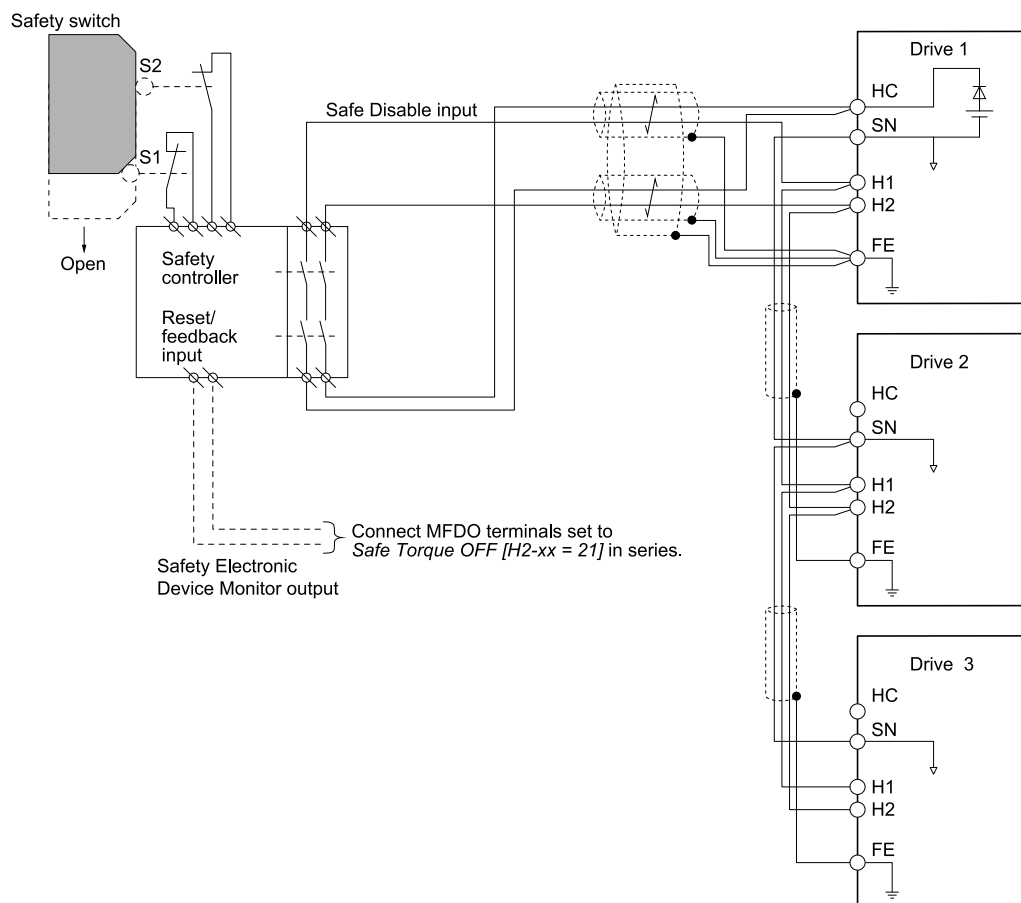

Figure 5.23 Connection Example to Use the Internal Power Supply

#### To Use 24 V External Power Supply

Figure 5.24 shows an example of how to connect Safe Disable contacts. These conditions limit the number of drives that you can connect:

- External power supply capacity
- Number of MFDIs used
- Supply current to the external sensors

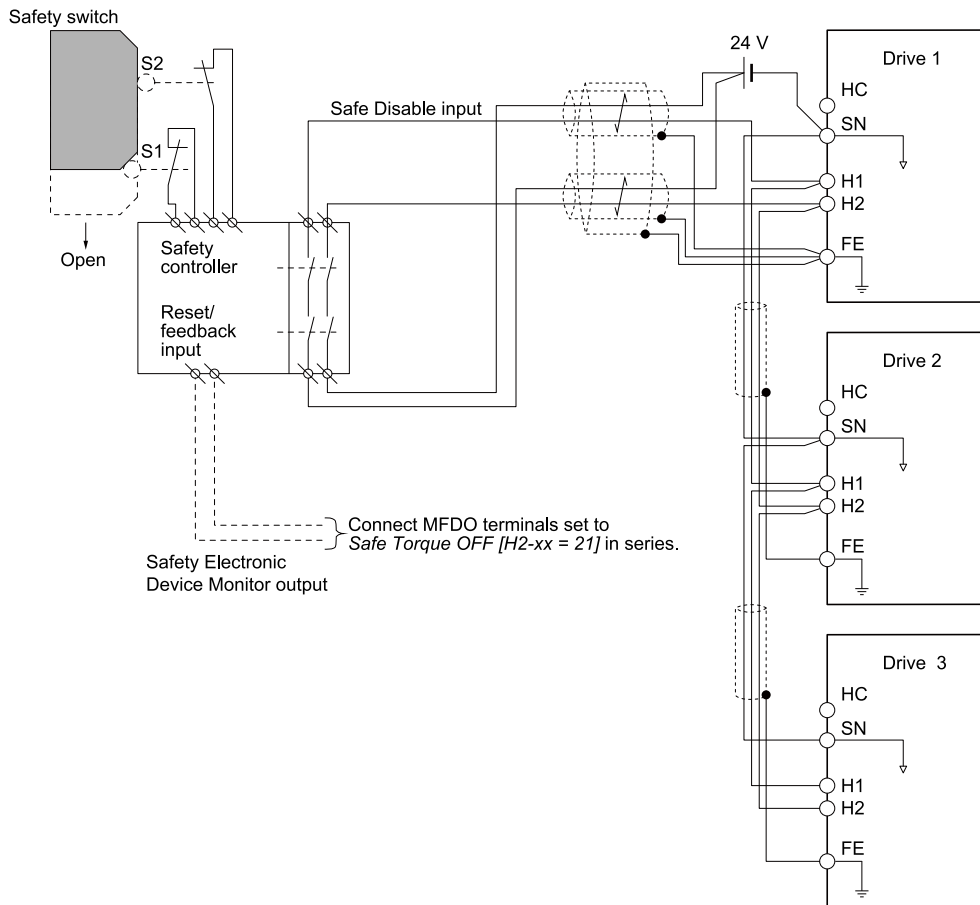

Figure 5.24 Connection Example to Use 24 V External Power Supply

The Number of Possible Drives to Connect

Power Supply	MFDI	24 V Output	+P Output	Number of Drives
Internal power supply (Drive 1)	Yes (7-channel input)	Yes <sup>*1</sup>	Yes <sup>*1</sup>	1
		No	No	26
	No	Yes <sup>*1</sup>	Yes <sup>*1</sup>	4
		No	No	29
External power supply		-		Different for different external power supply capacities <sup>*2</sup>

\*1 This is when you use a maximum of 150 mA.

\*2 24 V, 12 mA is necessary for each drive.

Use this formula to calculate the number of units to connect:

$$n = (I_{Omax} - I_{MFDI} \times n_{MFDI} - I_{sensor} - I_{+P}) / I_{safety}$$

- n: Number of units to connect
- $I_{Omax}$ : Maximum current that can be supplied from the power supply (354 mA for the internal power supply)
- $I_{MFDI}$ : Current consumed per MFDI (6 mA)
- $n_{MFDI}$ : Maximum number of MFDIs that can be activated at the same time (maximum of 7-channel)
- $I_{sensor}$ : Current externally supplied for sensor power supply (maximum of 150 mA)
- $I_{+P}$ : Current externally supplied for sensor power supply (maximum of 150 mA)
- $I_{safety}$ : Current consumed by Safe Disable terminals H1 and H2 (12 mA)

**Note:**

Round the values to the first decimal place.



## ■ Enabling and Disabling the Drive Output (“Safe Torque Off”)

Refer to [Figure 5.25](#) for an example of drive operation when the drive changes from “Safe Torque Off” status to usual operation.

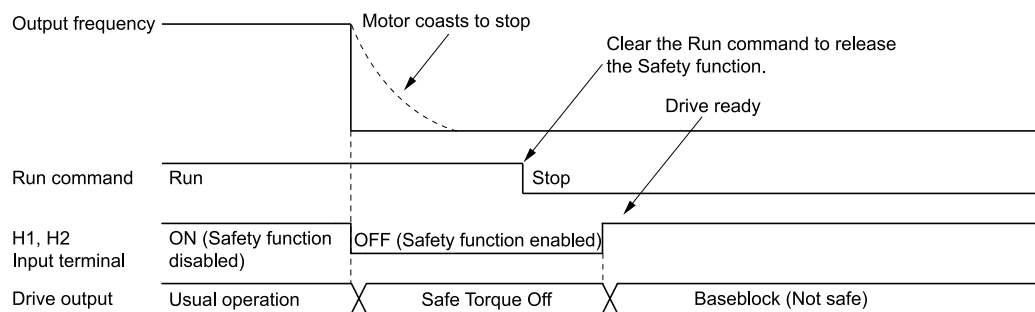

Figure 5.25 Safe Disable Operation

### Switching from Usual Operation to “Safe Torque Off”

Turn OFF (open) safety input terminal H1 or H2 to enable the Safe Disable function. When the Safe Disable function is enabled while the motor is operating, the drive output and motor torque turn off and the motor always coasts to stop. The *b1-03 [Stopping Method Selection]* setting does not have an effect on the stopping method.

The “Safe Torque Off” status is only possible with the Safe Disable function. Clear the Run command to stop the drive. Turning off drive output (a baseblock condition) ≠ “Safe Torque Off”.

#### Note:

- When it is necessary to ramp to stop the motor, do not turn off terminals H1 and H2 until the motor fully stops. This will prevent the motor from coasting to stop during usual operation.
- A maximum of 3 ms will elapse from when terminals H1 or H2 shut off until the drive switches to the “Safe Torque Off” status. Set the OFF status for terminals H1 and H2 to hold for at least 2 ms. The drive may not be able to switch to the “Safe Torque Off” status if terminals H1 and H2 are only open for less than 2 ms.

### Going from “Safe Torque Off” to Usual Operation

The safety input will only release when there is no Run command.

- During Stop  
When the Safe Disable function is triggered during stop, close the circuit between terminals H1-HC and H2-HC to disable “Safe Torque Off”. Enter the Run command after the drive stops correctly.
- During Run  
When the Safe Disable function is triggered during run, close the circuit between terminals H1-HC and H2-HC to disable “Safe Torque Off” after clearing the Run command. Enter the Stop command, then enter the Run command when terminals H1 and H2 are ON or OFF.

## ■ Safe Disable Monitor Output Function and Keypad Display

Refer to [Table 5.16](#) for information about the relation between the input channel status, Safety monitor output status, and drive output status.

Table 5.16 Safe Disable Input and External Device Monitor (EDM) Terminal Status

Input Channel Status	Input 1 (H1-HC)	ON (Close the circuit)	OFF (Open)	ON (Close the circuit)	OFF (Open)
	Input 2 (H2-HC)	ON (Close the circuit)	ON (Close the circuit)	OFF (Open)	OFF (Open)
MFDO Terminal (H2-xx = 21)	MFDO Terminal (H2-xx = 21)	OFF	OFF	OFF	ON
	MFDO Terminal (H2-xx = 121)	ON	ON	ON	OFF
Drive Output Status		Baseblock (Drive ready)	Safety status (STo)	Safety status (STo)	Safety status (STo)
Keypad Display		Normally displayed	SToF (Flashing)	SToF (Flashing)	STo (Flashing)
LED Status Ring		Ready: Illuminated	ALM/ERR: Flashing	ALM/ERR: Flashing	Ready: Flashing
MEMOBUS Register 0020 (Hex.)		bit C: 0 bit D: 0	bit C: 1 bit D: 0	bit C: 1 bit D: 0	bit C: 0 bit D: 1

### Safety Function Status Monitor

The drive Safety monitor output sends a feedback signal about the status of the Safety function. The Safety monitor output is one of the possible settings available for the MFDO terminals. If there is damage to the Safe Disable circuit, a controller (PLC or safety relay) must read this signal as an input signal to hold the “Safe Torque Off” status. This will help verify the condition of the safety circuit. Refer to the manual for the safety device for more information about the Safety function.

You can use the MFDO function settings to switch the polarity of the Safety monitor output signal. Refer to [Table 5.16](#) for setting instructions.

### Keypad Display

If the two input channels are OFF (Open), the keypad will flash *STo* [*Safe Torque OFF*].

If there is damage to the Safe disable circuit or the drive, the keypad will flash *SToF* [*Safe Torque OFF Hardware*] when one input channel is OFF (Open) and the other is ON (Close the circuit). When you use the Safe disable circuit correctly, the keypad will not show *SToF*.

If there is damage to the drive, the keypad will show *SCF* [*Safety Circuit Fault*] when the drive detects a fault in the Safe disable circuit. Refer to the chapter on Troubleshooting for more information.

### ■ Validating the Safe Disable Function

After you replace parts or do maintenance on the drive, first complete all necessary wiring to start the drive, then test the Safe Disable input with these steps. Keep a record of the test results.

1. When the two input channels are OFF (Open), make sure that the keypad flashes *STo* [*Safe Torque OFF*], and make sure that the motor is not running.
2. Monitor the ON/OFF status of the input channels and make sure that MFDO set to the EDM function operates as shown in [Table 5.16](#).

If one or more of these items are true, the ON/OFF status of the MFDO may not display correctly on the keypad:

- Incorrect parameter settings.
- A problem with an external device.
- The external wiring has a short circuit or is disconnected.
- There is damage to the device.

Find the cause and repair the problem to correctly display the status.

3. Make sure that the EDM signal operates during usual operation as shown in [Table 5.16](#).

## 5.7 Seismic Standards

The Yaskawa drives in this manual are capable of structurally and operationally withstanding the seismic response criteria as defined in the International Building Code (IBC), ASCE7, and California Department of Health Care Access and Information (HCAI).

The models in this manual were tested in compliance with AC-156 to meet the IBC seismic certification as shown on the certification labels.



Figure 5.26 Seismic Certification Label Example for Drives

### ◆ IBC/HCAI Seismic Mounting Requirements

Use the attachment hardware in [Table 5.17](#) and [Table 5.18](#) depending on your enclosure type to install your drive to meet the IBC/HCAI seismic mounting requirements.

### ■ IP20/UL Type 1 or IP20/UL Open Type Attachment Methods and Hardware Specifications

Table 5.17 IP20/UL Type 1 or IP20/UL Open Type Attachment Methods and Hardware Specifications

Model	Attachment Method	Attachment Hardware		
		Quantity	Specifications	
2011 to 2031 4005 to 4034	Direct to Steel	4	Anchor Material	ASTM A307
			Anchor Diameter	3/16 in
2046 to 2114 4040 to 4124	Direct to Steel	4	Anchor Material	ASTM A307
			Anchor Diameter	1/4 in
	Direct to Concrete <sup>*/</sup>	4	Anchor Material	Hilti KH-EZ Screw Anchor
			Anchor Diameter	1/4 in
			Minimum Embedment	2.50 in
			Critical Edge Distance	4.0 in
CMU	1500 PSI CMU with 2000 PSI grout			
2143 to 2273 4156 to 4240	Direct to Steel	4	Anchor Material	ASTM A307
			Anchor Diameter	3/8 in
	Direct to Concrete <sup>*/</sup>	4	Anchor Material	Hilti KH-EZ Screw Anchor
			Anchor Diameter	3/8 in
			Minimum Embedment	3.25 in
			Critical Edge Distance	6.0 in
CMU	1500 PSI CMU with 2000 PSI grout			

## 5.7 Seismic Standards

Model	Attachment Method	Attachment Hardware		
		Quantity	Specifications	
4302	Direct to Steel	4	Anchor Material	ASTM A307
			Anchor Diameter	1/2 in
	Direct to Concrete <sup>*1</sup>	4	Anchor Material	Hilti KH-EZ Screw Anchor
			Anchor Diameter	1/2 in
			Minimum Embedment	4.25 in
			Critical Edge Distance	8.0 in
CMU	1500 PSI CMU with 2000 PSI grout			

\*1 Refer to *Concrete Masonry Attachment Detail on page 238* for Direct to Concrete installations.

### ■ IP55/UL Type 12 Enclosures (with and without Switch)

Table 5.18 IP55/UL Type 12 Attachment Methods and Hardware Specifications

Model	Attachment Method	Attachment Hardware		
		Quantity	Specifications	
2011 to 2031 4005 to 4034	Direct to Steel	4	Anchor Material	ASTM A307
			Anchor Diameter	3/16 in
2046 to 2114 4040 to 4124	Direct to Steel	4	Anchor Material	ASTM A307
			Anchor Diameter	1/4 in
	Direct to Concrete <sup>*1</sup>	4	Anchor Material	Hilti KH-EZ Screw Anchor
			Anchor Diameter	1/4 in
			Minimum Embedment	2.50 in
			Critical Edge Distance	4.0 in
CMU	1500 PSI CMU with 2000 PSI grout			

\*1 Refer to *Concrete Masonry Attachment Detail on page 238* for Direct to Concrete installations.

### ◆ Concrete Masonry Attachment Detail

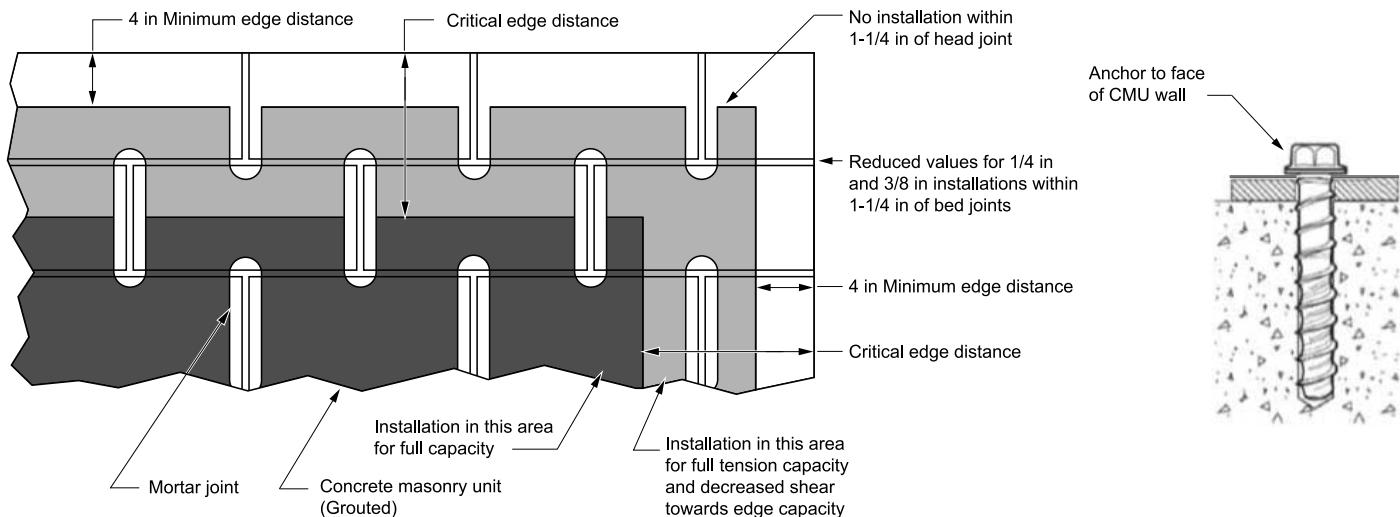

#### Note:

Anchorage Installation is restricted to shaded areas as per ESR 3056.

# Network Communications

---

<b>6.1</b>	<b>Section Safety .....</b>	<b>240</b>
<b>6.2</b>	<b>Fieldbus Network Support .....</b>	<b>241</b>
<b>6.3</b>	<b>BACnet Communications.....</b>	<b>242</b>
<b>6.4</b>	<b>APOGEE FLN (P1) Communications.....</b>	<b>259</b>
<b>6.5</b>	<b>Metasys N2 Communications .....</b>	<b>269</b>
<b>6.6</b>	<b>MEMOBUS/Modbus Communications.....</b>	<b>279</b>

## 6.1 Section Safety

 **DANGER**

**Do not ignore the safety messages in this manual.**

If you ignore the safety messages in this manual, it will cause serious injury or death. The manufacturer is not responsible for injuries or damage to equipment.

## 6.2 Fieldbus Network Support

You can use the PLC to control and monitor the drive through the network. The drive has a standard RS-485 interface (serial communications). Install a separately sold communication option on the drive to support other network communications.

### ◆ Available Communication Options

Refer to [Table 6.1](#) for the fieldbus networks that are compatible with the drive. Contact Yaskawa or your nearest sales representative to order a communication option.

**Note:**

Some fieldbus connector may not fit the space of the drive. Contact Yaskawa or your nearest sales representative for information about the applicable connector type.

**Table 6.1 Available Fieldbus Network**

Type of Communications	Option Models	Type of Communications	Option Models
LonWorks	SI-W3	EtherNet/IP	SI-EN3 JOHB-SMP3
Modbus TCP/IP	SI-EM3 JOHB-SMP3	BACnet/IP	JOHB-SMP3
PROFINET	SI-EP3 JOHB-SMP3		

## 6.3 BACnet Communications

This section gives detailed information about the parameters, error codes, and communication procedures for BACnet communications.

### ◆ Configure Master/Slave

You can monitor and control the drives from a controller on a Building Automation and Control network (BACnet) with RS-485 technology and Master-Slave/Token-Passing (MS-TP) protocol. The drives agree with the device profile of the BACnet Application Specific Controller (B-ASC).

A maximum of 127 drives can communicate on a single BACnet MS-TP network depending on network conditions. When more drives or BACnet devices are necessary, a BACnet router is necessary to let another MS-TP network be available with a possible maximum of another 127 drives.

You can use drive parameters to set the MSTP MAC address, MSTP baud rate, and Device Object ID. You can also use parameters to set Device object properties Max Masters and Max Info Frames. Set other Device Object properties, for example Device Object Name and Device Object Location, through the BACnet network after you connect the drive and the drive is communicating.

When you set the addressing, a controller can start communication to the drive. The drive will do the specified function and send a response back to the controller. The drive will usually respond immediately, but can delay its response until it gets the token for commands that can take longer local processing time.

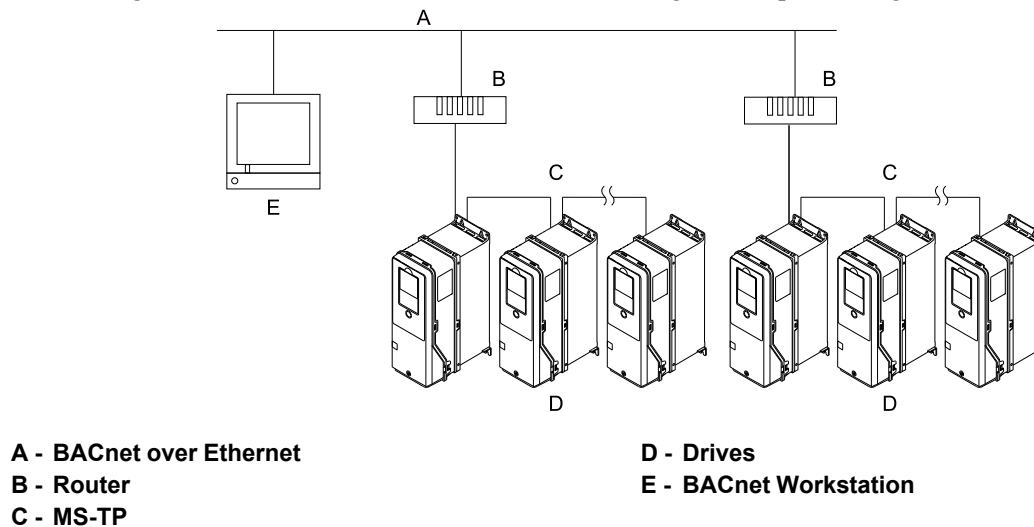

Figure 6.1 Connection Example of Multiple Drives to a BACnet Workstation

### ◆ Communication Specifications

Table 6.2 lists the specifications for the BACnet communications.

Table 6.2 BACnet Specifications

Item	Specifications
Interface	Master-Slave/Token-Passing (MS-TP)
	RS-485
Communication parameter	Communications speed: 9.6, 19.2, 38.4, 76.8 kbps
	Data length: 8 bit (fixed)
	Parity: even, odd, none
	Stop Bit: 1 bit (fixed)
Communication protocol	BACnet MS-TP
Number of possible units to connect	Maximum: 127 units for each MS-TP network segment depending on network conditions.



## ◆ Communication with the PLC

This section gives information about the settings for the termination resistor and how to connect to BACnet communications.

### ■ Connect Communications Cable

Use this procedure to start communication between the PLC and drive.

1. De-energize the drive then connect the communications cable to the PLC and the drive. The drive uses terminal TB6 for serial communications.

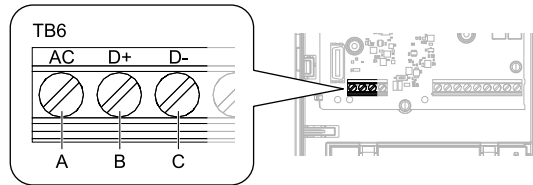

**A - Terminal AC: Signal ground**

**B - Terminal D+: Communication input/output (+)**

**C - Terminal D-: Communication input/output (-)**

**Figure 6.2 Communications Cable Connection Terminal (TB6)**

#### Note:

Isolate the communications wiring from the main circuit wiring and other high-power wiring. Use shielded wires for the communications wiring and connect cable sheaths to the ground terminal of the drive. Incorrect wiring procedures could cause drive malfunction because of electrical interference.

2. Install the termination resistor on the network termination slave drive. Set the DIP switch S2 to the ON position to enable the termination resistor on the drive.
3. Energize the drive.
4. Use the drive keypad to set the necessary communications parameters *H5-01 to H5-12*.
  - *H5-01 [Drive Node Address]*
  - *H5-02 [Communication Speed Selection]*
  - *H5-04 [Stopping Method after Com Error]*
  - *H5-05 [Comm Fault Detection Select]*
  - *H5-08 [Communication Protocol Selection]*
  - *H5-09 [CE Detection Time]*
  - *H5-12 = 0 [Run Command Method Selection = FWD/Stop, REV/Stop]*
5. De-energize the drive and wait for the keypad display to turn off or set *H5-20 = 1 [Communication Parameters Reload = Reload Now]*.
6. Energize the drive.

The drive is prepared to start communication with the PLC.

### ■ Set the Termination Resistor

You must enable the termination resistor on the serial terminals of the drives on the two physical ends of the network to use serial communications. Use DIP switch S2 on the terminal block to enable and disable the built-in termination resistor. Refer to [Figure 6.3](#) for an example of how to set DIP switch S2. Use the tip of a tweezers or a jig with a tip width of 0.8 mm (0.03 in) to set the DIP switch. When you install the drive in the terminal of the communication line, set DIP switch S2 to ON. Set DIP switch S2 to OFF on all other drives.

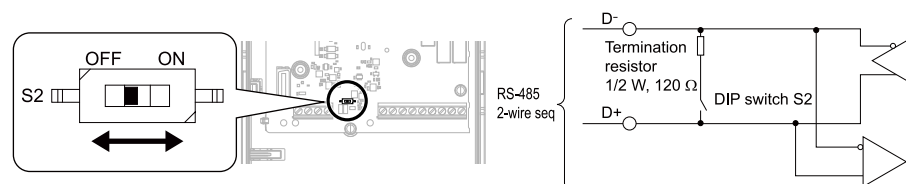

**Figure 6.3 Serial Communication Terminal and DIP Switch S2**

## ■ Wiring Diagram for More than One Drive

Figure 6.4 shows how to wire more than one connected drive with using serial communications.

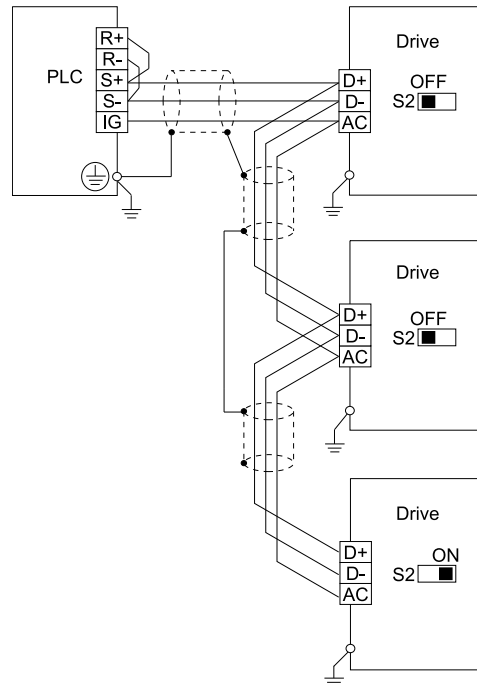

Figure 6.4 Wiring Diagram for More than One Drive

### Note:

Set DIP switch S2 to the ON position on the last drive of the serial communication network to enable the termination resistor.

## ◆ Drive Operations by Serial Communications

Drive parameters will apply to the settings when the drive is running during serial communications. This section gives information about the available functions and their related parameters.

### ■ Executable Functions

A PLC can do these operations with serial communications. Parameter settings (except *H5-xx*) do not have an effect on the availability of these operations.

- Monitor the drive status and operate the drive
- Set and view parameters
- Fault Reset Procedure
- Multi-function input and output setting (The input command from serial communications and MFDI terminals (S1 to S7) are linked by a logical OR operation.)

### ■ Drive Control

To use external commands to set the frequency references and motor run/stop with serial communications, set these parameters as specified by the application:

- *b1-01* = 2 [*Frequency Reference Selection 1 = Serial Communications*]
- *b1-02* = 2 [*Run Command Selection 1 = Serial Communications*]
- *b1-02* = 7 [*AUTO Command + Term Run*]
- *b1-02* = 8 [*AUTO Command + Serial Run*]
- *b1-02* = 9 [*AUTO Command + Option Run*]

For more information about operation mode selection, refer to *b1-01* and *b1-02*.

## ◆ BACnet Objects Supported

### ■ Present Value Access

The Present Value (PV) of BACnet objects can always be read. Some PVs can also be written or commanded. A commandable PV is almost the same as the writable PV, but the value is actually written into a priority array. The value that has the highest priority in the array will be used by the drive.

**Table 6.3 Present Value Access Types and Descriptions**

PV Access	Name	Description
C	Commandable	Value written to a priority array. The highest priority value in the array is then written to the drive.
R	Readable	Value is read-only
W	Writable	Value written to the drive

### ■ Supported Properties of Objects

**Table 6.4 Object Properties**

Property	Object Type						
	Device	Analog Input (AI)	Analog Output (AO)	Analog Value (AV)	Binary Input (BI)	Binary Output (BO)	Binary Value (BV)
Object_Identifier	Yes	Yes	Yes	Yes	Yes	Yes	Yes
Object_Name	Yes	Yes	Yes	Yes	Yes	Yes	Yes
Location	Yes	-	-	-	-	-	-
Object_Type	Yes	Yes	Yes	Yes	Yes	Yes	Yes
System_Status	Yes	-	-	-	-	-	-
Vendor_Name	Yes	-	-	-	-	-	-
Vendor_Identifier	Yes	-	-	-	-	-	-
Model_Name	Yes	-	-	-	-	-	-
Firmware_Revision	Yes	-	-	-	-	-	-
Protocol_Version	Yes	-	-	-	-	-	-
Protocol_Revision	Yes	-	-	-	-	-	-
Protocol_Services_Supported	Yes	-	-	-	-	-	-
Protocol_Object_Types_Supported	Yes	-	-	-	-	-	-
Object_List	Yes	-	-	-	-	-	-
Max_ADPU_Length_Accepted	Yes	-	-	-	-	-	-
Segmentation_Supported	Yes	-	-	-	-	-	-
Local_Time	Yes	-	-	-	-	-	-
Local_Date	Yes	-	-	-	-	-	-
ADPU_Timeout	Yes	-	-	-	-	-	-
Number_Of_ADPU_Retries	Yes	-	-	-	-	-	-
Max_Masters	Yes	-	-	-	-	-	-
Max_Info_Frames	Yes	-	-	-	-	-	-
Device_Address_Binding	Yes	-	-	-	-	-	-
Database_Revision	Yes	-	-	-	-	-	-
Active_COV_Subscriptions	Yes	-	-	-	-	-	-
Present_Value	-	Yes	Yes	Yes	Yes	Yes	Yes
Status_Flags	-	Yes	Yes	Yes	Yes	Yes	Yes

## 6.3 BACnet Communications

Property	Object Type						
	Device	Analog Input (AI)	Analog Output (AO)	Analog Value (AV)	Binary Input (BI)	Binary Output (BO)	Binary Value (BV)
Event_State	-	-	-	-	-	-	-
Reliability	-	Yes	Yes	Yes	Yes	Yes	Yes
Out_Of_Service	-	Yes	Yes	Yes	Yes	Yes	Yes
Units	-	Yes	Yes	Yes	-	-	-
Priority_Array	-	-	Yes */	Yes */	-	Yes	Yes
Relinquish_Default	-	-	Yes */	Yes */	-	Yes	Yes
Polarity	-	-	-	-	Yes	Yes	-
Inactive_Text	-	-	-	-	Yes	Yes	Yes
Active_Text	-	-	-	-	Yes	Yes	Yes
COV_Increment *2	-	Yes	Yes	Yes	-	-	-
Property_List	Yes	Yes	Yes	Yes	Yes	Yes	Yes
Local Time	Yes	-	-	-	-	-	-
Local Date	Yes	-	-	-	-	-	-

\*1 For Commandable Object Instances only.

\*2 COV function is only available on objects that are not commandable and not writable.

### ■ Analog Input Objects

Object ID	Object Name (Network Display)	Modbus Address (Hex.)	Precision	Range	Units	PV Access
AI1	Analog Input 1 Level (Drv Anlog In 1 Level)	004E	xxxx . x	-	%	R
AI2	Analog Input 2 Level (Drv Anlog In 2 Level)	004F	xxxx . x	-	%	R
AI3	Not Used AI3 (Not Used AI003)	-	-	-	-	-
AI4	Not Used AI4 (Not Used AI004)	-	-	-	-	-
AI5	Not Used AI5 (Not Used AI005)	-	-	-	-	-
AI6	Display Format o1-03 (Display Format o1-03)	0502	xxxxx	-	-	R
AI7	Scale Format b5-20 (Scale Format b5-20)	01E2	xxxxx	-	-	R
AI8	Inverter Model o2-04 (Inverter Model o2-04)	0508	xxxxx	-	-	R
AI9	Rated Current n9-01 (Rated Current n9-01)	05D0	xxxx . x (for drives rated higher than 11 kVA) xxx . x (for drives rated 11 kVA or lower)	-	A	R

### ■ Analog Output Objects

Object ID	Object Name (Network Display)	Modbus Address (Hex.)	Precision	Range	Units	PV Access
AO1	Analog Output 1 Level (Drv Anlg Out1 Level)	0007	xxxx . x	0 - 100.0	%	C
AO2	Analog Output 2 Level (Drv Anlg Out2 Level)	0008	xxxx . x	0 - 100.0	%	C

## ■ Analog Value Objects

Table 6.5 Analog Value Objects

Object ID	Object Name (Network Display)	Modbus Address (Hex.)	Precision	Range	Units	PV Access
AV1	Operation Cmd (Bitmapped) <i>(Operation Cmd)</i> <ul style="list-style-type: none"> <li>• bit 0: Run Fwd</li> <li>• bit 1: Run Rev</li> <li>• bit 2: External Fault (EF0)</li> <li>• bit 3: Fault Reset</li> <li>• bit 4: Multi-Function Input 1 (ComRef when HI-01 = 40)</li> <li>• bit 5: Multi-Function Input 2 (ComCtrl when HI-02 = 41)</li> <li>• bit 6: Multi-Function Input 3</li> <li>• bit 7: Multi-Function Input 4</li> <li>• bit 8: Multi-Function Input 5</li> <li>• bit 9: Multi-Function Input 6</li> <li>• bit A: Multi-Function Input 7</li> <li>• bit B to F: Reserved</li> </ul> <b>Note:</b> When you use AV1, you must not use BV1 to BV11 or AV5.	0001	-	0 - 2047	Bitmapped	C
AV2	Frequency Command <i>(Frequency Cmd)</i>	0002	xxx . xx Determined by o1-03	0.00 - 600.00	Hz Determined by o1-03	C
AV3	PID Setpoint <i>(PI Setpoint Cmd)</i>	0006	xxx . xx	0.00 - 100.00	%	C
AV4	MF Output Cmd (Bitmapped) <i>(MF Output Cmd)</i> <ul style="list-style-type: none"> <li>• bit 0: Multi-Function Digital Output 1 (terminal M1-M2)</li> <li>• bit 1: Multi-Function Digital Output 2 (terminal M3-M4)</li> <li>• bit 2: Multi-Function Digital Output 3 (terminal M5-M6)</li> <li>• bit 3: Reserved</li> <li>• bit 4: Reserved</li> <li>• bit 5: Reserved</li> <li>• bit 6: Enables the function in bit 7</li> <li>• bit 7: Fault Contact Output (terminal MA-MB-MC)</li> <li>• bit 8 to F: Reserved</li> </ul> <b>Note:</b> When using AV4, do not use BO1 to BO3 or BV12.	0009	-	0 - 257	Bitmapped	C
AV5	Reference Select Cmd (Bitmapped) <i>(Reference Select Cmd)</i> <ul style="list-style-type: none"> <li>• bit 0: Reserved</li> <li>• bit 1: PID Setpoint Input</li> <li>• bit 2: Reserved</li> <li>• bit 3: Reserved</li> <li>• bit 4: PI2 Target Input</li> <li>• bit 5 to B: Reserved</li> <li>• bit C: Multi-Function Input 5</li> <li>• bit D: Multi-Function Input 6</li> <li>• bit E: Multi-Function Input 7</li> <li>• bit F: Reserved</li> </ul> <b>Note:</b> When you use AV5, you must not use AV1, BO4, or BV9 to BV11.	000F	-	0 - 32767	Bitmapped	C

## 6.3 BACnet Communications

Object ID	Object Name (Network Display)	Modbus Address (Hex.)	Precision	Range	Units	PV Access
AV6	Drive Status (Bitmapped) ( <i>Drive Status</i> ) <ul style="list-style-type: none"> <li>• bit 0: During Run</li> <li>• bit 1: During Reverse</li> <li>• bit 2: Drive Ready</li> <li>• bit 3: Drive Faulted</li> <li>• bit 4: Data Setting Error</li> <li>• bit 5: Multi-Function Digital Output 1 (terminal M1-M2)</li> <li>• bit 6: Multi-Function Digital Output 2 (terminal M3-M4)</li> <li>• bit 7: Multi-Function Digital Output 3 (terminal M5-M6)</li> <li>• bit 8 to D: Reserved</li> <li>• bit E: ComRef status</li> <li>• bit F: ComCtrl status</li> </ul>	0020	-	0 - 65535	Bitmapped	R
AV7	Fault Details (Bitmapped) ( <i>Fault Details</i> ) <ul style="list-style-type: none"> <li>• bit 0: oC [Overcurrent], GF [Ground Fault]</li> <li>• bit 1: ov [Overvoltage]</li> <li>• bit 2: oL2 [Drive Overload]</li> <li>• bit 3: oH1 [Heatsink Overheat], oH2 [External Overheat (H1-XX=B)]</li> <li>• bit 4 to 6: Reserved</li> <li>• bit 7: EF to EF7 [External Fault]</li> <li>• bit 8: CPFxx [Hardware Fault] (includes oFAxx)</li> <li>• bit 9: oL1 [Motor Overload], oL3 [Overtorque Detection 1], UL3 [Undertorque Detection 1]</li> <li>• bit A: Reserved</li> <li>• bit B: Uv [DC Bus Undervoltage]</li> <li>• bit C: Uv1 [DC Bus Undervoltage], Uv2 [Control Power Undervoltage], Uv3 [Soft Charge Answerback Fault]</li> <li>• bit D: LF [Output Phase Loss], PF [Input Phase Loss]</li> <li>• bit E: CE [Modbus Communication Error], bUS [Option Communication Error]</li> <li>• bit F: oPr [Keypad Connection Fault]</li> </ul>	0021	-	0 - 65535	Bitmapped	R
AV8	Data Link Status (Bitmapped) ( <i>Data Link Status</i> ) <ul style="list-style-type: none"> <li>• bit 0: Writing Data</li> <li>• bit 1: Reserved</li> <li>• bit 2: Reserved</li> <li>• bit 3: Upper or lower limit error</li> <li>• bit 4: Data conformity error</li> <li>• bit 5: Writing to EEPROM</li> <li>• bit 6 to F: Reserved</li> </ul>	0022	-	0 - 63	Bitmapped	R
AV9	Frequency Reference ( <i>Frequency Reference</i> )	0040	xxx . xx Determined by o1-03	-	Hz Determined by o1-03	R
AV10	Output Frequency ( <i>Output Frequency</i> )	0041	xxx . xx Determined by o1-03	-	Hz Determined by o1-03	R
AV11	Output Voltage ( <i>Output Voltage</i> )	0045	xxxx . x	-	V	R
AV12	Output Current ( <i>Output Current</i> )	0026	xxxx . x (for drives rated higher than 11 kVA) xxx . xx (for drives rated 11 kVA or lower)	-	A	R
AV13	Output Power ( <i>Output Power</i> )	0047	xxxx . x (for drives rated higher than 11 kVA) xxx . xx (for drives rated 11 kVA or lower)	-	kW	R
AV14	Torque Reference ( <i>Torque Reference</i> )	0048	xxxx . x	-	%	R

Object ID	Object Name (Network Display)	Modbus Address (Hex.)	Precision	Range	Units	PV Access
AV15	MF Input Status (MF Input Status)	-	-	0 - 127	Bitmapped	R
AV16	Drive Status 2 (Drive Status 2)	-	-	1 - 65535	Bitmapped	R
AV17	MF Output Status (MF Output Status)	-	-	0 - 135	Bitmapped	R
AV18	DC Bus Voltage (DC Bus Voltage)	0031	xxxx . x	-	V	R
AV19	PID Feedback Level (PI Feedback Level)	0038	xxxx . x	-	%	R
AV20	PID Input Level (PI Input Level)	0039	xxxx . x	-	%	R
AV21	PID Output Level (PI Output Level)	003A	xxxx . x	-	%	R
AV22	CPU Software (CPU Software)	005B	xxxxx	-	-	R
AV23	Flash Number (Flash Number)	004D	xxxxx	-	-	R
AV24	Comm Error Detail (Comm Error Detail)	003D	-	0 - 127	Bitmapped	R
AV25	kVA Setting (kVA Setting)	0508	xxxxx	-	-	R
AV26	Control Method (Control Method)	0043	xxxxx	-	-	R
AV27	Accel Time (Accel Time)	0200	xxxx . x	0.1 - 6000.0	s	W
AV28	Decel Time (Decel Time)	0201	xxxx . x	0.1 - 6000.0	s	W
AV29 *1	Param Number (Parameter Number)	-	xxxxx	0 - FFFF	-	W
AV30 *1	Param Data (Parameter Data)	-	xxxxx	0 - FFFF	-	W
AV31	Not Used AV31 (Not Used AV031)	-	-	-	-	R
AV32	Not Used AV32 (Not Used AV032)	-	-	-	-	R
AV33	Drive kWh Consumed (kWh Consumed)	005C - 005D	-	-	kWh	R
AV34	Not Used AV34 (Not Used AV034)	-	-	-	-	R
AV35	Drive Run Time (Drive Run Time)	004C	-	-	h	R
AV36	Out Freq in % (Output Freq in %)	003F	-	-	%	R
AV37	Out Freq in RPM (Output Freq in RPM)	003E	-	-	RPM	R
AV38	Torque Iq (U6-01) (Torque IQ (U6-01))	0051	-	-	%	R
AV39	Drive HOA Status (Drive HOA Status)	004B	-	-	-	R
AV40	Last Drive Fault (Last Drive Fault)	0081	-	-	-	R

## 6.3 BACnet Communications

Object ID	Object Name (Network Display)	Modbus Address (Hex.)	Precision	Range	Units	PV Access
AV41	Not Used AV41 (Not Used AV041)	-	-	-	-	R
AV42	Current Sys Fault (Current Sys Flt)	0080	-	-	-	R

\*1 Refer to [Accessing Drive Parameters and the Enter Command on page 254](#) for an explanation of how to read and write drive parameters not listed in the analog or binary objects.

### ■ Binary Input Objects

Object ID	Object Name (Network Display)	Modbus Address (Hex.)	Active Text	Inactive Text	PV Access
BI1	Drive Input Terminal 1 (Input Terminal 1)	002B: bit 0	ON	OFF	R
BI2	Drive Input Terminal 2 (Input Terminal 2)	002B: bit 1	ON	OFF	R
BI3	Drive Input Terminal 3 (Input Terminal 3)	002B: bit 2	ON	OFF	R
BI4	Drive Input Terminal 4 (Input Terminal 4)	002B: bit 3	ON	OFF	R
BI5	Drive Input Terminal 5 (Input Terminal 5)	002B: bit 4	ON	OFF	R
BI6	Drive Input Terminal 6 (Input Terminal 6)	002B: bit 5	ON	OFF	R
BI7	Drive Input Terminal 7 (Input Terminal 7)	002B: bit 6	ON	OFF	R
BI8	Drive Multi-Function Out 1 (Multi Function Out 1)	0020: bit 5	ON	OFF	R
BI9	Drive Multi-Function Out 2 (Multi Function Out 2)	0020: bit 6	ON	OFF	R
BI10	Not Used BI10 (Not Used BI010)	-	-	-	-
BI11	Not Used BI11 (Not Used BI011)	-	-	-	-
BI12	Not Used BI12 (Not Used BI012)	-	-	-	-
BI13	Not Used BI13 (Not Used BI013)	-	-	-	-
BI14	Not Used BI14 (Not Used BI014)	-	-	-	-
BI15	Not Used BI15 (Not Used BI015)	-	-	-	-
BI16	Not Used BI16 (Not Used BI016)	-	-	-	-
BI17	Not Used BI17 (Not Used BI017)	-	-	-	-
BI18	Not Used BI18 (Not Used BI018)	-	-	-	-
BI19	Not Used BI19 (Not Used BI019)	-	-	-	-
BI20	Not Used BI20 (Not Used BI020)	-	-	-	-
BI21	Not Used BI21 (Not Used BI021)	-	-	-	-



Object ID	Object Name (Network Display)	Modbus Address (Hex.)	Active Text	Inactive Text	PV Access
BI22	Not Used BI22 (Not Used BI022)	-	-	-	-
BI23	Not Used BI23 (Not Used BI023)	-	-	-	-
BI24	Not Used BI24 (Not Used BI024)	-	-	-	-
BI25	Not Used BI25 (Not Used BI025)	-	-	-	-
BI26	Not Used BI26 (Not Used BI026)	-	-	-	-
BI27	Not Used BI27 (Not Used BI027)	-	-	-	-
BI28	Drive Fault Status (Drive Fault Status)	004B: bit 7	ON	OFF	R
BI29	Drive Alarm Status (Drive Alarm Status)	004B: bit 6	ON	OFF	R
BI30	Not Used BI30 (Not Used BI030)	-	-	-	-

### Binary Output Objects

Object ID	Object Name (Network Display)	Modbus Address (Hex.)	Active Text	Inactive Text	PV Access
BO1	MF Output M1-M2 (MF Output, M1 - M2)	0009: bit 0	ON	OFF	C
BO2	MF Output M3-M4 (MF Output, M3 - M4)	0009: bit 1	ON	OFF	C
BO3	MF Output M5-M6 (MF Output, M5 - M6)	0009: bit 2	ON	OFF	C
BO4	Ref Sel: PID Setpoint (Ref Sel: PI Setpoint)	000F: bit 1	ON	OFF	C
BO5	Ref Sel: Term S5 IN (Ref Sel: Term S5 In)	000F: bit 8	ON	OFF	C
BO6	Ref Sel: Term S6 IN (Ref Sel: Term S6 In)	000F: bit 9	ON	OFF	C
BO7	Ref Sel: Term S7 IN (Ref Sel: Term S7 In)	000F: bit 10	ON	OFF	C

### Binary Value Objects

Object ID	Object Name (Network Display)	Modbus Address (Hex.)	Active Text	Inactive Text	PV Access
BV1	RUN FWD (Run FWD Cmd)	0001: bit 0	RUN	OFF	C
BV2	RUN REV (Run REV Cmd)	0001: bit 1	REV	OFF	C
BV3	EXT FAULT (Ext Fault Cmd)	0001: bit 2	FAULT	OFF	C
BV4	FAULT RESET (Fault Reset Cmd)	0001: bit 3	RESET	OFF	C
BV5	COM NET (Com Net Cmd)	Internal	COM	LOCAL	C
BV6	COM CNTRL (Com Cntrl Cmd)	Internal	COM	LOCAL	C

## 6.3 BACnet Communications

Object ID	Object Name (Network Display)	Modbus Address (Hex.)	Active Text	Inactive Text	PV Access
BV7	MF Input 3 Cmd (MF Input 3 Cmd)	0001: bit 6	ON	OFF	C
BV8	MF Input 4 Cmd (MF Input 4 Cmd)	0001: bit 7	ON	OFF	C
BV9	MF Input 5 Cmd (MF Input 5 Cmd)	0001: bit 8	ON	OFF	C
BV10	MF Input 6 Cmd (MF Input 6 Cmd)	0001: bit 9	ON	OFF	C
BV11	MF Input 7 Cmd (MF Input 7 Cmd)	0001: bit 10	ON	OFF	C
BV12	Set Fault Contact Cmd (Set Flt Contact Cmd)	0009: bit 6	ENABLE	OFF	C
BV13	RUN-STOP (RUN-STOP)	0020: bit 0	RUN	OFF	R
BV14	REV-FWD (REV-FWD)	0020: bit 1	REV	FWD	R
BV15	READY (READY)	0020: bit 2	READY	OFF	R
BV16	FAULT (FAULT)	0020: bit 3	FAULTED	OFF	R
BV17	Data Set Error (Data Set Error)	0020: bit 4	ERROR	OFF	R
BV18	Overcurrent - Ground Fault (OverCurrent- Gnd Flt)	0021: bit 0	OC-GF	OFF	R
BV19	Main Circuit Overvoltage (Main Ckt OverVoltage)	0021: bit 1	OV	OFF	R
BV20	Drive Overload (Drive OverLoad)	0021: bit 2	OL2	OFF	R
BV21	Drive Overheat (Drive OverHeat)	0021: bit 3	OH1-OH2	OFF	R
BV22	Fuse Blown (Fuse Blown)	0021: bit 5	PUF	OFF	R
BV23	PID Feedback Loss (PI Feedback Loss)	0021: bit 6	FBL	OFF	R
BV24	External Fault (External Fault)	0021: bit 7	EF0-EF	OFF	R
BV25	Hardware Error (Hardware Error)	0021: bit 8	CPF	OFF	R
BV26	Mtr Ovrld-OvrTorque (Mtr OvrLd-OvrTorque)	0021: bit 9	OL1-OL3	OFF	R
BV27	Overspeed (OverSpeed)	0021: bit 10	OS-DEV	OFF	R
BV28	Main CKT Undervoltage (Main Ckt UndrVoltage)	0021: bit 11	UV	OFF	R
BV29	MCU, Cntl Pwr Sy Err (MCU Cntrl Pwr Sy Err)	0021: bit 12	UV1-2-3	OFF	R
BV30	Output Phase Loss (Output Phase Loss)	0021: bit 13	LF	OFF	R
BV31	Communication Error (Communication Error)	0021: bit 14	CE	OFF	R
BV32	Operator Disconnect (Operator Disconnect)	0021: bit 15	OPR	OFF	R
BV33	Operating (Operating)	002C: bit 0	OPERATING	OFF	R

Object ID	Object Name (Network Display)	Modbus Address (Hex.)	Active Text	Inactive Text	PV Access
BV34	Zero Speed (Zero Speed)	002C: bit 1	ON	OFF	R
BV35	Frequency Agree (Frequency Agree)	002C: bit 2	ON	OFF	R
BV36	Desired Frequency Agree (Desired Freq Agree)	002C: bit 3	ON	OFF	R
BV37	Frequency Detect 1 (Frequency Detect 1)	002C: bit 4	ON	OFF	R
BV38	Frequency Detect 2 (Frequency Detect 2)	002C: bit 5	ON	OFF	R
BV39	Drive Startup Complete (Drv Startup Complete)	002C: bit 6	ON	OFF	R
BV40	Low Voltage Detect (Low Voltage Detect)	002C: bit 7	ON	OFF	R
BV41	Base Block (Base Block)	002C: bit 8	ON	OFF	R
BV42	Frequency Reference Mode (Frequency Ref Mode)	002C: bit 9	LOCAL	COM	R
BV43	Run Command Mode (Run Command Mode)	002C: bit 10	LOCAL	COM	R
BV44	Overtorque Detect (Over Torque Detect)	002C: bit 11	ON	OFF	R
BV45	Frequency Refer Lost (Frequency Ref Loss)	002C: bit 12	ON	OFF	R
BV46	Retry Error (Retry Error)	002C: bit 13	ON	OFF	R
BV47	Modbus Comms Error (Modbus Comms Error)	002C: bit 14	ON	OFF	R
BV48	Modbus Timeout Error (Modbus Timeout Error)	002C: bit 15	ON	OFF	R
BV49	CRC Error (CRC Error)	003D: bit 0	ON	OFF	R
BV50	Invalid Data Length (Invalid Data Length)	003D: bit 1	ON	OFF	R
BV51	Parity Error (Parity Error)	003D: bit 3	ON	OFF	R
BV52	Overrun Error (Overrun Error)	003D: bit 4	ON	OFF	R
BV53	Framing Error (Framing Error)	003D: bit 5	ON	OFF	R
BV54	Timeout Error (Timeout Error)	003D: bit 6	ON	OFF	R
BV55 *I	Parameter Accept (Parameter Accept)	Internal	ON	OFF	W
BV56 *I	Parameter Enter (Parameter Enter)	Internal	ON	OFF	W
BV57	Drive Comm Error (Drive Comms Error)	002C: bit F	ON	OFF	R
BV58	Not Used BV58 (Not Used BV058)	-	-	-	-
BV59	Not Used BV59 (Not Used BV059)	-	-	-	-
BV60	Emergency Override Drive Reverse (Em Over DRV REV CMD)	Internal	ON	OFF	C

Object ID	Object Name (Network Display)	Modbus Address (Hex.)	Active Text	Inactive Text	PV Access
BV61	Not Used BV61 (Not Used BV061)	-	-	-	-
BV62	Not Used BV62 (Not Used BV062)	-	-	-	-
BV63	Emergency Override Drive Forward (Em Over DRV FWD CMD)	Internal	ON	OFF	C

\*1 Refer to [Accessing Drive Parameters and the Enter Command on page 254](#) for an explanation of how to read and write drive parameters not listed in the analog or binary objects.

## ■ Device Object

The Device Object is the BACnet device to the network in this manual. The Device Object Instance ID and the Device Object Name are configurable. Refer to [Table 6.6](#) for more information.

**Table 6.6 Instance ID and Name of the Device Object**

Item	Description	Data Type
Device Object Instance ID	A unique internetwork-wide numerical value. To set this ID, set H5-14 [BACnet Device Obj ID LOW BITS] and H5-15 [BACnet Device Obj ID HIGH BITS].	22-bit value Range: 0 - 4, 194, 302
Device Object Name	A unique internetwork-wide character string that is writable from the BACnet network.	20-character strings

### Note:

Any changes to the parameter settings and any new string written will not take effect until you de-energize the drive.

## ◆ Accessing Drive Parameters and the Enter Command

### ■ Read Drive Parameters

To read the drive parameters that are not listed in the analog or digital objects, use AV29 and AV30 as shown in this procedure:

1. Write the desired Modbus register to AV29 in decimal value.
2. Read the decimal value at the given register from AV30.

For example, to read the Frequency Reference Upper Limit, read from parameter *d2-01* [Frequency Reference Upper Limit].

Parameter *d2-01* is located at Modbus register 0289H, which is decimal 649.

Set AV29 to "649."

Read AV30 to get the value.

### ■ Write Drive Parameters

To write the drive parameters that are not listed in the analog or digital objects, use AV29, AV30, and BV55 or BV56 as shown in this procedure:

1. In AV29, write the desired Modbus register number in decimal format.
2. In AV30, write the value that you want to put into the register set in AV29 in decimal format.

At this point the value is written to the drive, but the location is pending.

If necessary, write in more values this way, the drive will accept these settings by one of two methods:

- Set BV55 to "ON" to move data to active memory.
- Set BV56 to "ON" to move data into active memory and save to non-volatile memory.

For example, to reset the KWH Monitor, write a value of "1" to parameter *o4-12* [kWh Monitor Initialization].

Parameter *o4-12* is located at Modbus register 0512 (Hex.), which is decimal 1298.

Set AV29 to "1298."

Set AV30 to "1."

Set BV55 to “ON.”

## ■ Enter Command

Enter Commands are only necessary to use AV29 and AV30 to access drive parameters. Enter commands are not necessary to read or write to the other BACnet objects.

This section gives information about the Enter command.

### Types of Enter Commands

The drive supports two Enter commands shown in [Table 6.7](#).

**Table 6.7 Types of Enter Commands**

BACnet Object	Modbus Address (Hex.)	Description
BV55 (Write “ON”)	0910 (Write 0)	This updates the data on the RAM, but does not write data to the EEPROM. This process saves the parameter changes until you de-energize the drive.
BV56 (Write “ON”)	0900 (Write 0)	When you write parameter data to the EEPROM, you will enable the data on the RAM at the same time. This process saves the parameter changes until you de-energize the drive.

#### Note:

You can write the EEPROM to the drive a maximum of 100,000 times. Do not frequently execute the Enter command (0900 (Hex.)) that is written to EEPROM. The Enter command registers 0900 (Hex.) and 0910 (Hex.) are write-only. If these registers are read, the register address will not be applicable, but BACnet objects BV55 and BV56 can be read without error.

## ◆ Self-Diagnostics

The drive can use Self-Diagnostics to verify the hardware transceiver on the control circuit board. Self-Diagnostics connects the transmission terminal to the reception terminal on the control circuit and transmits the data to itself to make sure that the drive can communicate correctly.

Use this procedure to do Self-Diagnostics:

**DANGER! Electrical Shock Hazard.** Do not examine, connect, or disconnect wiring on an energized drive. Before servicing, disconnect all power to the equipment and wait for the time specified on the warning label at a minimum. The internal capacitor stays charged after the drive is de-energized. The charge indicator LED extinguishes when the DC bus voltage decreases below 50 Vdc. When all indicators are OFF, remove the covers before measuring for dangerous voltages to make sure that the drive is safe. If you do work on the drive when it is energized, it will cause serious injury or death from electrical shock.

1. Energize the drive.
2. Set H1-06 = 67 [Terminal S6 Function Selection = Communications Test Mode].
3. De-energize the drive.

4. Connect a jumper between control circuit terminals S6 and SN.

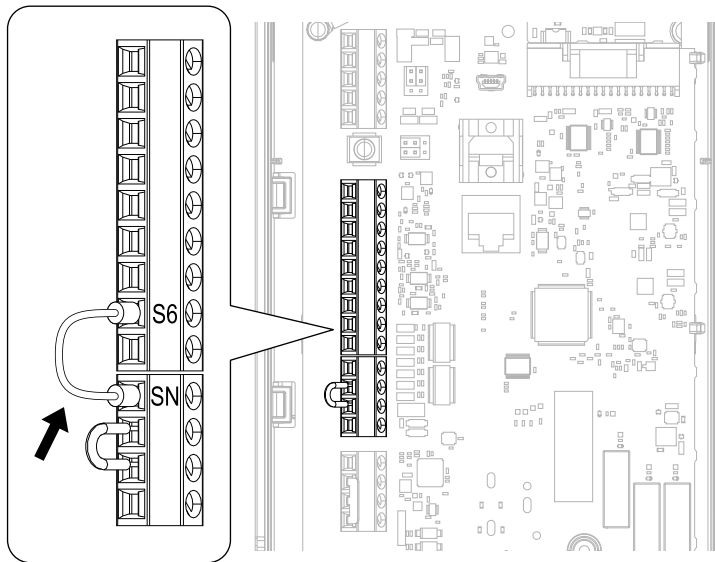

**Figure 6.5 Self-Diagnostics Jumper Terminals**

5. Energize the drive.
6. When normal, the keypad will show *PASS [Modbus Communication Test]*.

**Note:**

If there is an error, the keypad will show *CE [Modbus Communication Error]*. Disconnect the drive from the network and test the drive again. If the error stays, there is a possible hardware problem. If there is no error, there is a possible network wiring problem.

7. De-energize the drive.
8. Disconnect the wire jumper between terminals S6 and SN. Set terminal S6 to its initial function.

Self-Diagnostics is complete and the drive returns to its usual function.

### ◆ BACnet Protocol Implementation Conformance Statement

- Date: 11/03/2018
- Vendor Name: Yaskawa
- Product Name: AC Motor Controller
- Product Model Number: HV600
- Application Software Version: VSEA010xx
- Firmware Revision: 2.01
- BACnet Protocol Revision: 14
- Product Description:
 

The Yaskawa HV600 Drive is a high performance product specifically designed for commercial building automation applications. The Yaskawa BACnet feature connects the HV600 Drive to a standard BACnet MS/TP network. These products may be fully controlled and monitored over BACnet. All drive parameters are available for reading and writing.
- BACnet Standardized Device Profile (Annex L):
  - BACnet Cross-Domain Advanced Operator Workstation (B-XAWS)
  - BACnet Advanced Operator Workstation (B-AWS)
  - BACnet Operator Workstation (B-OWS)
  - BACnet Operator Display (B-OD)
  - BACnet Advanced Life Safety Workstation (B-ALSWS)
  - BACnet Life Safety Workstation (B-LSWS)
  - BACnet Life Safety Annunciator Panel (B-LSAP)
  - BACnet Advanced Access Control Workstation (B-AACWS)
  - BACnet Access Control Workstation (B-ACWS)

- BACnet Access Control Security Display (B-ACSD)
- BACnet Building Controller (B-BC)
- BACnet Advanced Application Controller (B-AAC)
- BACnet Application Specific Controller (B-ASC)
- BACnet Smart Actuator (B-SA)
- BACnet Smart Sensor (B-SS)
- BACnet Advanced Life Safety Controller (B-ALSC)
- BACnet Life Safety Controller (B-LSC)
- BACnet Advanced Access Control Controller (B-AACC)
- BACnet Access Control Controller (B-ACC)
- BACnet Router (B-RTR)
- BACnet Gateway (B-GW)
- BACnet Broadcast Management Device (B-BBMD)
- BACnet Access Control Door Controller (B-ACDC)
- BACnet Access Control Credential Reader (B-ACCR)
- BACnet General (B-GENERAL)
- List all BACnet Interoperability Building Blocks Supported (Annex K):
  - Data Sharing-ReadProperty-B (DS-RP-B)
  - Data Sharing-WriteProperty-B (DS-WP-B)
  - Data Sharing-ReadPropertyMultiple-B (DS-RPM-B)
  - Data Sharing-WritePropertyMultiple-B (DS-WPM-B)
  - Data Sharing-Change Of Value-B (DS-COV-B)
  - Data Sharing-Change Of Value Property-B (DS-COVP-B)
  - Device Management-Dynamic Device Binding-B (DM-DDB-B)
  - Device Management-Dynamic Object Binding-B (DM-DOB-B)
  - Device Management-DeviceCommunicationControl-B (DM-DCC-B)
  - Device Management-ReinitializeDevice-B (DM-RD-B)
  - Device Management-TimeSynchronization-B (DM-TS-B)
- Segmentation Capability:
  - Able to transmit segmented messages / Window Size:
  - Able to receive segmented messages / Window Size:
- Standard Object Types Supported:

Object Types	Descriptions
Device Object	Optional Writeable: – Max_Info_Frames – Max_Master
Analog Input Object	Optional properties supported: – COV_Increment Optional Writeable: – COV_Increment - supported on various instances
Analog Output Object	-
Analog Value Object	Optional properties supported: – COV_Increment Optional Writeable: – COV_Increment - supported on various instances
Binary Input Object	-
Binary Output Object	-
Binary Value Object	-

- Data Link Layer Options:

## 6.3 BACnet Communications

---

- ARCNET (ATA 878.1), 2.5 Mb. (Clause 8)
  - ARCNET (ATA 878.1), EIA-485 (Clause 8), baud rate(s):
  - BACnet IP, (Annex J)
  - BACnet IP, (Annex J), BACnet Broadcast Management Device (BBMD)
  - BACnet IP, (Annex J), Network Address Translation (NAT Traversal)
  - BACnet IPv6, (Annex U)
  - BACnet IPv6, (Annex U), BACnet Broadcast Management Device (BBMD)
  - BACnet/ZigBee (Annex O)
  - Ethernet, ISO 8802-3 (Clause 7)
  - LonTalk, ISO/IEC 14908.1 (Clause 11), medium:
    - MS/TP master (Clause 9), baud rate(s): 9600, 19200, 38400, 76800
    - MS/TP slave (Clause 9), baud rate(s)
  - Point-To-Point, EIA 232 (Clause 10), baud rate(s):
  - Point-To-Point, modem, (Clause 10), baud rate(s):
  - Other:
- Device Address Binding:  
Is static device binding supported? (This is currently necessary for two-way communication with MS/TP slaves and certain other devices.) Yes No
  - Networking Options:
    - Router, Clause 6 - List all routing configurations, e.g., ARCNET-Ethernet, Ethernet-MS/TP, etc.
    - Annex H, BACnet Tunneling Router over IP
  - Character Sets Supported:  
Indicating support for multiple character sets does not imply that they can all be supported simultaneously.
    - ISO 10646 (UTF-8)
    - IBM/Microsoft DBCS
    - ISO 8859-1
    - ISO 10646 (UCS-2)
    - ISO 10646 (UCS-4)
    - JIS X 0208
  - If this product is a communication gateway, describe the types of non-BACnet equipment/networks(s) that the gateway supports:  
Not supported  
If this product is a communication gateway which presents a network of virtual BACnet devices, a separate PICS shall be provided that describes the functionality of the virtual BACnet devices. That PICS shall describe a superset of the functionality of all types of virtual BACnet devices that can be presented by the gateway.
  - Network Security Options:
    - Non-secure Device - is capable of operating without BACnet Network Security
    - Secure Device - is capable of using BACnet Network Security (NS-SD BIBB)
      - Multiple Application-Specific Keys
      - Supports encryption (NS-ED BIBB)
      - Key Server (NS-KS BIBB)



## 6.4 APOGEE FLN (P1) Communications

This section gives detailed information about the parameters, error codes and communication procedures for APOGEE FLN (P1) communications.

### ◆ APOGEE FLN Set-Up

A Yaskawa America, Inc. representative is responsible for proper configuration of the drive for its primary application, while a Siemens Building Technologies, Inc. representative is responsible for field panel programming to make use of the drive functionality in the building automation system. As such, there must be coordination between the Yaskawa America and Siemens Building Technologies representatives to ensure that the programming of the drive is consistent with the particular application requirements. After verifying that the drive installation and wiring are correct, apply power to the drive. [Table 6.8](#) lists the parameters and values required for proper APOGEE FLN communication and control.

**Table 6.8 Drive APOGEE FLN Communication Parameter Settings**

Parameter No.	HOA Keypad Display	APOGEE FLN Setting
b1-01	Frequency Reference Selection 1	2: Serial Communications
b1-02	Run Command Selection 1	2: Serial Communications
H1-03	Terminal S3 Function Selection	70: Drive Enable 2
H5-01	Drive Node Address	Select the drive address (default = 1Fh (31 dec))
H5-02	Communication Speed Selection	2: 4800 bps or 3: 9600 bps
H5-08	Communication Protocol Selection	2: Apogee/P1

**NOTICE: Damage to Equipment.** Do not change the APOGEE FLN (P1) communication parameter settings. A Yaskawa representative must set the parameters to their correct values. Incorrect parameter settings can cause damage to the drive or building equipment.

### ◆ Communication Specifications

[Table 6.9](#) lists the specifications for the APOGEE FLN (P1).

**Table 6.9 APOGEE FLN (P1) Specifications**

Item	Specification
Interface	FLN
	RS-485
Communication parameter	Communication speed: 4.8 kbps, 9.6 kbps
	Data length: 8 bit (fixed)
	Parity: even, odd, none
	Stop bit: 1 bit (fixed)
Communication protocol	APOGEE FLN P1
Number of possible units to connect	Maximum: 127 units for each FLN network segment

### ◆ Communication with the PLC

This section gives information about the settings for the termination resistor and how to connect to APOGEE FLN (P1) communications.

#### ■ Connect Communications Cable

Use this procedure to start communication between the PLC and drive.

1. De-energize the drive then connect the communications cable to the PLC and the drive. The drive uses terminal TB6 for serial communications.

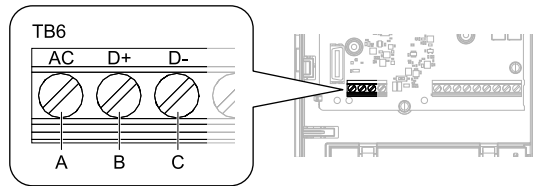

**A - Terminal AC: Signal ground**

**B - Terminal D+: Communication input/output (+)**

**C - Terminal D-: Communication input/output (-)**

**Figure 6.6 Communications Cable Connection Terminal (TB6)**

**Note:**

Isolate the communications wiring from the main circuit wiring and other high-power wiring. Use shielded wires for the communications wiring and connect cable sheaths to the ground terminal of the drive. Incorrect wiring procedures could cause drive malfunction because of electrical interference.

2. Install the termination resistor on the network termination slave drive. Set the DIP switch S2 to the ON position to enable the termination resistor on the drive.
3. Energize the drive.
4. Use the drive keypad to set the necessary communications parameters *H5-01 to H5-12*.
  - *H5-01 [Drive Node Address]*
  - *H5-02 [Communication Speed Selection]*
  - *H5-03 [Communication Parity Selection]*
  - *H5-04 [Stopping Method after Com Error]*
  - *H5-05 [Comm Fault Detection Select]*
  - *H5-06 [Drive Transmit Wait Time]*
  - *H5-08 [Communication Protocol Selection]*
  - *H5-09 [CE Detection Time]*
  - *H5-10 [Modbus Register 0025H Unit Sel]*
  - *H5-11 [Communications ENTER Func Select]*
  - *H5-12 [Run Command Method Selection]*
5. De-energize the drive and wait for the keypad display to turn off or set *H5-20 = 1 [Communication Parameters Reload = Reload Now]*.
6. Energize the drive.

The drive is prepared to start communication with the PLC.

### ■ Set the Termination Resistor

You must enable the termination resistor on the serial terminals of the drives on the two physical ends of the network to use serial communications. Use DIP switch S2 on the terminal block to enable and disable the built-in termination resistor. Refer to [Figure 6.7](#) for an example of how to set DIP switch S2. Use the tip of a tweezers or a jig with a tip width of 0.8 mm (0.03 in) to set the DIP switch. When you install the drive in the terminal of the communication line, set DIP switch S2 to ON. Set DIP switch S2 to OFF on all other drives.

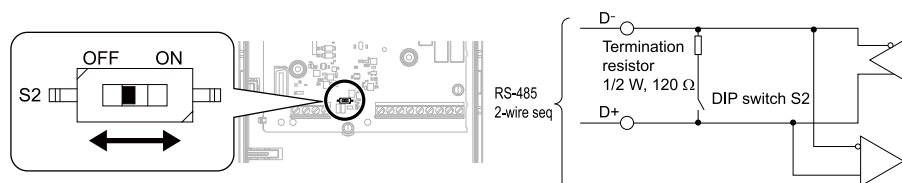

**Figure 6.7 Serial Communication Terminal and DIP Switch S2**

### ■ Wiring Diagram for More than One Drive

[Figure 6.8](#) shows how to wire more than one connected drive with using serial communications.

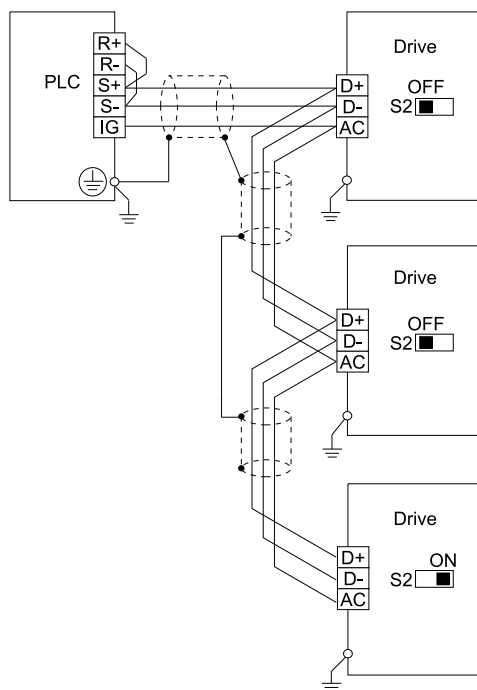

**Figure 6.8 Wiring Diagram for More than One Drive**

**Note:**

Set DIP switch S2 to the ON position on the last drive of the serial communication network to enable the termination resistor.

## ■ Recommended Cable

**Table 6.10 APOGEE FLN Cable Specifications**

Specification	Description
Cable configuration	Twisted shielded pair
Gauge	<ul style="list-style-type: none"> <li>Stranded wire: 0.2 mm<sup>2</sup> to 1.0 mm<sup>2</sup> (24 AWG to 16 AWG)</li> <li>Sold wire: 0.2 mm<sup>2</sup> to 1.5 mm<sup>2</sup> (24 AWG to 16 AWG)</li> </ul>
Wire lay	Minimum 6 twists per foot
Shields	100% foil with drain wire
NEC type	UL type CMP
Temperature	-20 °C to +60 °C

**Note:**

Cable lengths cannot be longer than 152 m (500 ft) at 4800 bps.

## ◆ Slope and Intercept Conversion

Several drive parameters are available for monitoring purposes. The available parameters include FREQUENCY OUTPUT (Point 3), SPEED (Point 5), CURRENT (Point 6), TORQUE (Point 7), POWER (Point 8), DRIVE TEMP (Point 9), KWH (Point 10), and RUN TIME (Point 12). These points can be unbundled for monitoring or used in various global control strategies.

## ■ Drive Controlled Feedback

The most typical application is Supervisory Control. The sensor for the control variable (for example, water temperature) is hard-wired to the drive and the control device (fan) is modulated using the PI control loop built into the drive. The setpoint for the control variable (water temperature set point) is unbundled and commanded by the field panel, based on the building control strategy implemented in PPCL.

When this strategy is used, the point to unbundle and command for the set point is INPUT REF 1 (Point 60). The control variable (for example, water temperature) can be monitored by unbundling PI FEEDBACK (Point 62). These

points are provided in units of percent, where 0% and 100% correspond to the range of the sensor being used to measure the control variable. These points have default units in Hz. If other units are required, unbundle these points with appropriate slopes and intercepts. The new intercept will be equal to the lowest value of the desired range.

The following formulas allow the user to define a new slope and intercept to convert the unit.

$$\text{New Slope} = \frac{(\text{Desired Range}) \times (\text{Slope of Existing Point})}{(\text{Range of Existing Point})}$$

$$\text{New Slope} = \frac{(60 - 0) \text{ Hz} \times (0.01)}{(100 - 0)\%} = 0.006$$

### Conversion Example

The drive is controlling a fan, which in turn is controlling the water temperature from a cooling tower. The temperature sensor has a range of -1 °C to +121 °C (30 °F to 250 °F). To unbundle the set point (INPUT REF 1), for commanding in degrees Fahrenheit, where 0 to 60 Hz is equal to -1 °C to +121 °C: New Intercept = 30 (the temperature that corresponds to 0%)

$$\text{New Slope} = \frac{(\text{Desired Range}) \times (\text{Slope of Existing Point})}{(\text{Range of Existing Point})}$$

$$\text{New Slope} = \frac{(250 - 30) \text{ °F} \times (0.1)}{(100 - 0)\%} = 0.22$$

#### Note:

1. Desired Range = Range Maximum - Range Minimum
2. Range of Existing Point = Existing Range Maximum - Existing Range Minimum

## ■ Field Panel Controlled Feedback

In this strategy, the sensor is connected to the APOGEE FLN network at a remote location, and the control loop is executed in PPCL. The drive speed command is passed from the field panel to the drive by commanding INPUT REF 1 (Point 60).

**NOTICE:** *Damage to Equipment. Yaskawa does not recommend a field panel controlled feedback strategy because it closes the loop over the network. If you use field panel controlled feedback, it will cause a delay in processor scan time and network traffic. It can cause a decrease or loss of control and cause damage to HVAC equipment.*

### Unbundle the Feedback

To unbundle the feedback (PI FEEDBACK) for monitoring in degrees Fahrenheit:

New Intercept = 30

$$\text{New Slope} = \frac{(\text{Desired Range}) \times (\text{Slope of Existing Point})}{(\text{Range of Existing Point})}$$

$$\text{New Slope} = \frac{(250 - 30) \text{ °F} \times (0.01)}{(100 - 0)\%} = 0.022$$

#### Note:

1. Desired Range = Range Maximum - Range Minimum
2. Range of Existing Point = Existing Range Maximum - Existing Range Minimum

## ■ Other Functionalities

Enable these functions during start-up of the drive:

- **Enable the Drive to Run**  
 RUN ENABLE (Point 35) can be commanded to require the drive to have a physical input (Terminal S3) set before the drive can run. This works in conjunction with CMD RUN.STOP (Point 24) or the CMD REV.STOP (Point 22). If RUN ENABLE (Point 35) is commanded ON then terminal S3 needs to be on and CMD RUN.STOP (Point 24) or CMD REV.STOP (point 22) needs to be commanded ON for the drive to run. If, on the other hand, RUN ENABLE (Point 35) is commanded OFF, then to run the drive CMD RUN.STOP (Point 24) or CMD REV.STOP (Point 22), is the only point that needs to be commanded ON.
- **Start and Stop the Drive**  
 CMD RUN.STOP (Point 24) can be commanded to run the drive in the forward direction. STOP.RUN (Point 23) shows the current status of the drive.
- **Change Directions**

CMD REV.STOP (Point 22) can be commanded to run the drive in the reverse direction. FWD.REV (Point 21) shows the current direction of the drive rotation.

**NOTICE:** *Damage to Equipment. Make sure that the motor direction is correct when you set b1-04 = 0 [Reverse Operation Selection = Reverse Enabled]. Incorrect motor direction can cause damage to HVAC equipment.*

- **Lock the Drive Panel**  
Locking the panel prevents the user from using the HAND and OFF keys locally at the drive panel. LOCK PANEL (Point 33) can be commanded to lock and unlock the panel.
- **Digital Outputs**  
MULTI OUT 1 (Point 40), MULTI OUT 2 (Point 41), and MULTI OUT 3 (Point 42) are physical digital outputs on the drive. Their purpose depends on how the drive has been set-up. The drive can be programmed so that these points can display various limits, warnings, and status conditions. Some examples include frequency limit, over current, and motor over temperature fault.
- **Loop Gain**  
PID P GAIN (Point 63) and PID I TIME (Point 64) are the gain and integral time parameters similar to the P and I gains in the APOGEE FLN Terminal Equipment Controllers. The PI loop of the drive is structured differently than the Siemens loop, so there is not a one-to-one correspondence between the gains.
- **Reading and Resetting Faults**  
OK.FAULT (Point 93) shows the current status of the drive. FAULT CODE (Point 17) contains the code for the most current fault. LST FLT CODE (Point 66) contains the code for the previous fault. See table below for descriptions of the fault codes. The drive can be reset back to OK mode by commanding RESET FAULT (Point 94) to RESET.

## ◆ APOGEE FLN Point Database

This section shows the APOGEE FLN point database for Application 2721.

### ■ APOGEE FLN Point List Summary

This database is for APOGEE FLN Application 2721 and features 92 logical points: 29 Logical Analog Inputs (LAI), 31 Logical Analog Outputs (LAO), 19 Logical Digital Inputs (LDI) and 13 Logical Digital Outputs (LDO). These points set, control, or monitor the operation of the drive.

Information to consider when referencing this table:

1. This application does not use the points that are not listed.
2. A single value in a column means that the value is the same in English units and in SI units.

**Table 6.11 APOGEE FLN Application 2721 Point Number Summary**

Point No.	Point Type	Point Name	Factory Default (SI Units)	Eng. Units (SI Units)	Slope (SI Units)	Intercept (SI Units)	On Text	Off Text	Parameter
01	LAO	CTRL ADDRESS	31	-	1	0	-	-	H5-01
02	LAO	APPLICATION	-	-	1	0	-	-	-
03 */	LAI	FREQ OUTPUT	0	Hz	0.01	0	-	-	U1-02
04 */	LAI	PCT OUTPUT	0	%	0.01	0	-	-	-
05 */	LAI	SPEED	0	RPM	0.01	0	-	-	-
06 */	LAI	CURRENT	0	A	0.01	0	-	-	U1-03
07 */	LAI	TORQUE	0	%	0.1	0	-	-	-
08 */	LAI	POWER	0	kW	0.1	0	-	-	U1-08
09 */	LAI	DRIVE TEMP	0	° C/F	1	0	-	-	U4-08
10 */	LAI	DRIVE KWH	0	kWh	0.1	0	-	-	U4-10
11 */	LAI	MWH	0	mWh	1	0	-	-	U4-11
12 */	LAI	RUN TIME	0	h	1	0	-	-	U4-01
13 */	LAI	DC BUS VOLT	0	V	1	0	-	-	U1-07
14 */	LAI	AC OUT VOLT	0	V	0.1	0	-	-	U1-06
15	LAI	PAR N9.01	0	A	0.01	0	-	-	-

## 6.4 APOGEE FLN (P1) Communications

Point No.	Point Type	Point Name	Factory Default (SI Units)	Eng. Units (SI Units)	Slope (SI Units)	Intercept (SI Units)	On Text	Off Text	Parameter
16 */	LAI	RUN TIMEX10K	0	10kh	1	0	-	-	U4-01
17 */	LAI	FAULT CODE	0	-	1	0	-	-	U2-01
18 */	LDI	MINOR FLT	NO FLT	-	1	0	FAULT	NO FLT	U1-12 (bit 6)
19 */	LDI	MAJOR FLT	NO FLT	-	1	0	FAULT	NO FLT	U1-12 (bit 7)
20	-	N/A	-	-	-	-	-	-	-
21 */	LDI	FWD.REV	FWD	-	1	0	REV	FWD	U1-12 (bit 2)
22 */	LDO	CMD.REV.STOP	STOP	-	1	0	REV	STOP	-
23 */	LDI	RUN.STOP	STOP	-	1	0	RUN	STOP	U1-12 (bit 0)
24 */	LDO	CMD.RUN.STOP	STOP	-	1	0	FWD	STOP	-
25 */	LDI	ZERO SPEED	OFF	-	1	0	ON	OFF	U1-12 (bit 1)
26 */	LDI	SPEED AGREE	NO AGR	-	1	0	AGREE	NO AGR	U1-12 (bit 4)
27 */	LDI	DRIVE READY	NOTRDY	-	1	0	READY	NOTRDY	U1-12 (bit 5)
28 */	LDI	LOC.REM MON	REMOTE	-	1	0	LOCAL	REMOTE	U1-12 (bit 13)
29 */	-	N/A	-	-	-	-	-	-	-
30	LAO	CURRENT LIM	0	A	0.01	0	-	-	E2-01
31	LAO	ACCEL TIME 1	0	s	0.1	0	-	-	C1-01
32	LAO	DECEL TIME 1	0	s	0.1	0	-	-	C1-02
33	LDO	LOCK PANEL	UNLOCK	-	1	0	LOCK	UNLOCK	-
34	-	N/A	-	-	-	-	-	-	-
35 *2	LDO	RUN ENABLE	STOP	-	1	0	ENABLE	STOP	-
36	LAO	STALL PRE RN	115	%	1	5	-	-	L3-06
37	LAO	STALL PRE AC	120	%	1	0	-	-	L3-02
38	LAO	FREQ UP LIM	100	%	0.1	0	-	-	d2-01
39	LAO	FREQ LOW LIM	0	%	0.1	0	-	-	d2-02
40 */	LDI	MULTI OUT 1	OFF	-	1	0	ON	OFF	U1-11 (bit 0)
41 */	LDI	MULTI OUT 2	OFF	-	1	0	ON	OFF	U1-11 (bit 1)
42 */	LDI	MULTI OUT 3	OFF	-	1	0	ON	OFF	U1-11 (bit 2)
43 */	LDI	SAFETY ILOCK	OFF	-	1	0	ON	OFF	U1-10 (bit 2)
44 */	LDO	MF INP 1	OFF	-	1	0	ON	OFF	-
45 */	LDO	MF INP 2	OFF	-	1	0	ON	OFF	-
46 */	LDO	MF INP 3	OFF	-	1	0	ON	OFF	-
47 */	LDO	MF INP 4	OFF	-	1	0	ON	OFF	-
48 */	LDO	MF INP 5	OFF	-	1	0	ON	OFF	-
49	LAO	JUMP FREQ 1	0	Hz	0.1	0	-	-	d3-01
50	LAO	JUMP FREQ 2	0	Hz	0.1	0	-	-	d3-02
51	LAO	JUMP FREQ 3	0	Hz	0.1	0	-	-	d3-03
52	LAO	JUMP FREQ BW	0	Hz	0.1	0	-	-	d3-04
53	LAO	NUM AUTOSTRT	0	-	1	0	-	-	L5-01
54	LAO	POWER LOSS RT	0.1	s	0.1	0	-	-	L2-02
55	LAO	RUN OP MODE	1	-	1	0	-	-	b1-02
56	LAO	REF OP MODE	1	-	1	0	-	-	b1-01

Point No.	Point Type	Point Name	Factory Default (SI Units)	Eng. Units (SI Units)	Slope (SI Units)	Intercept (SI Units)	On Text	Off Text	Parameter
57	LAO	OPER DISP MD	0	-	1	0	-	-	o1-03
58 */	LDI	MF IN 1 MON	OFF	-	1	0	ON	OFF	U1-10 (bit 2)
59 */	LDI	MF IN 2 MON	OFF	-	1	0	ON	OFF	U1-10 (bit 3)
60 */	LAO	INPUT REF 1	0	Hz	0.01	0	-	-	-
61	LAO	INPUT REF 2	0	Hz	0.01	0	-	-	d1-02
62 */	LAI	PID FEEDBACK	0	%	0.01	0	-	-	U5-01
63	LAO	PID P GAIN	2	-	0.01	0	-	-	b5-02
64	LAO	PID I TIM	1	s	0.1	0	-	-	b5-03
65	LDO	PID MODE SEL	DISABLE	-	1	0	ENABLE	DISABLE	b5-01
66 */	LAI	LST FLT CODE	0	-	1	0	-	-	U2-02
67 */	LAI	FREF FLT	0	Hz	0.01	0	-	-	U2-03
68 */	LAI	OUT FREQ FLT	0	Hz	0.01	0	-	-	U2-04
69 */	LAI	OUT CUR FLT	0	A	0.01	0	-	-	U2-05
70	LAO	RD PARAM NUM	1	-	1	0	-	-	-
71	LAI	RD PARAM DAT	0	-	1	0	-	-	-
72	LAO	WR PARAM NUM	1	-	1	0	-	-	-
73	LAO	WR PARAM DAT	0	-	1	0	-	-	-
74 */	LDI	MF IN 3 MON	OFF	-	1	0	ON	OFF	U1-10 (bit 4)
75 */	LAI	OUT VOLT FLT	0	V	0.1	0	-	-	U2-07
76 */	LAI	DC BUS FLT	0	V	1	0	-	-	U2-08
77 */	LAI	OUT PWR FLT	0	kW	0.1	0	-	-	U2-09
78 */	LDI	MF IN 4 MON	OFF	-	1	0	ON	OFF	U1-10 (bit 5)
79 */	LAI	PID DEVIATE	0	%	0.01	0	-	-	U5-02
80	LAO	PID I LIMIT	100	%	0.1	0	-	-	b5-04
81	LAO	PID UP LIMIT	100	%	0.1	0	-	-	b5-06
82	LAO	PID OFFS ADJ	100	%	0.1	-100	-	-	b5-07
83	LAO	PID PRI DYTM	0	s	0.1	0	-	-	b5-08
84	-	N/A	-	-	-	-	-	-	-
85	-	N/A	-	-	-	-	-	-	-
86	-	N/A	-	-	-	-	-	-	-
87 */	LAI	PID OUT CAP	0	%	0.01	0	-	-	U5-14
88 */	LAI	PID REF	0	%	0.01	0	-	-	U5-04
89 */	LAI	COMM ERR CD	0	-	1	0	-	-	U1-19
90	LDO	COMM FLT ENA	DISABLE	-	1	0	ENABLE	DISABLE	H5-05
91	LAO	CBL LOSS FREQ	0	Hz	0.01	0	-	-	d1-04
92	LAO	CBL LOSS TMR	2	s	0.1	0	-	-	H5-09
93 */	LDI	OK.FAULT	OK	-	1	0	FAULT	OK	U1-12 (bit 7)
94 */	LDO	RESET FAULT	NO	-	1	0	RESET	NO	-
95 */	LDI	DRV COMM ERR	NO FLT	-	1	0	FAULT	NO FLT	-
96 */	LDO	EXTERNAL FLT	OK	-	1	0	FAULT	OK	-
97 */	LDI	MF IN 5 MON	OFF	-	1	0	ON	OFF	U1-10 (bit 6)

## 6.4 APOGEE FLN (P1) Communications

Point No.	Point Type	Point Name	Factory Default (SI Units)	Eng. Units (SI Units)	Slope (SI Units)	Intercept (SI Units)	On Text	Off Text	Parameter
98	-	N/A	-	-	-	-	-	-	-
99 */	LAI	ERROR STATUS	0	-	1	0	-	-	U1-19

\*1 These point numbers can be unbundled at the field panel.

\*2 For point 35 to operate correctly, you must set  $H1-03 = 70$  [Terminal S3 Function Selection = Drive Enable 2].

### ◆ Cable Loss Configuration and Behavior

This section gives information about the configurable cable loss feature of the drive. This feature lets you configure the drive response to a loss of communication.

#### ■ Drive Behavior at Loss of Communication

After some interval without receiving a message, you can set the drive to response to one of these:

- Continue at last speed
- Continue at last speed with Alarm
- Continue at preset speed
- Ramp to Stop with EF0 fault
- Coast to Stop with EF0 fault

#### ■ APOGEE FLN Points

You can use three APOGEE FLN points to select the behavior:

- POINT 92 - CBL LOSS TMR
- POINT 91 - CBL LOSS FRQ
- POINT 90 - COMM FLT ENA

**Table 6.12 Cable Loss Behavior Summary**

Behavior	H5-04 [Communication Error Stop Method]	CBL LOSS TMR (Point 92)	CBL LOSS FRQ (Point 91)	COMM FLT ENA (Point 90)
Decelerate to stop (stop time in C1-02) EF0 fault	0 [Ramp to Stop]	Timeout interval	x	ON
Coast to stop EF0 fault	1 [Coast to Stop]	Timeout interval	x	ON
Emergency stop (stop time in C1-09) EF0 fault	2 [Fast Stop (Use C1-09)]	Timeout interval	x	ON
Continue at last speed	3 [Alarm Only]	0	x	x
Continue at last speed with alarm	3 [Alarm Only]	Timeout interval	x	ON
Continue at preset speed with alarm	4 [Run at H5-34 (CE Go-To-Freq)]	Timeout interval	Preset speed	ON

#### Note:

1. You must establish Communication for these features to function as described. If you energize the drive without a cable connected or with the master controller offline, a communications timeout does not occur.
2. For modes which describe the drive running after a communications timeout, a Run command must have been issued (RUN ENABLE (Point 35) = "ON" and either CMD RUN.FWD (Point 22) = "ON" or CMD RUN.REV (Point 24) = "ON") prior to loss of communications. For safety purposes, the drive will not automatically restart from a stopped condition. If a user requires the drive to restart automatically, additional external wiring is required to accomplish this (consult factory).

Upon expiration of the communications timeout interval, a CE [Modbus Communication Error] fault will be declared and will remain until communication is restored.

#### Continue at Last Speed

In this mode, CBL LOSS TMR (POINT 92) is set to 0, disabling the cable loss feature. The other two settings, CBL LOSS FRQ (POINT 91) and COMM FLT ENA (POINT 90), are ignored. If communication is lost, the drive maintains its last commanded state. The drive will not display an alarm or fault to indicate it has lost communication. This behavior can also be achieved by setting parameter  $H5-04 = 3$ . The drive will display an alarm and continue running. For this specific condition, the COMM FLT ENA (POINT 90) must be enabled and CBL LOSS TMR (POINT 91) should be set to a value other than 0. A CE drive alarm will be set.



**Continue at Preset Speed**

In this mode, CBL LOSS TMR (POINT 92) is set to the desired interval, CBL LOSS FRQ (POINT 91) is set to the desired preset speed and the parameter is set to  $H5-04 = 4$ . If the time between messages exceeds the timeout interval, the drive speed command, INPUT REF 1, (Point 60) is set to the CBL LOSS FRQ (POINT 91) and the drive continues running at this new speed. COMM FLT ENA (POINT 90) must be set to ON.

**Stop**

COMM FLT ENA (POINT 90) must be set to ON. In this mode, CBL LOSS TMR (POINT 92) is set to the desired interval and parameter  $H5-04$  is set to a value of 0, 1, or 2. If the time between messages is longer than the timeout interval, the speed command of the drive, INPUT REF 1, (Point 60) is set to 0. The stopping method is determined by the setting of  $H5-04$ . A CE drive fault will be set.  $H5-04 = 0$  selects Ramp to Stop.  $H5-04 = 1$  selects Coast to Stop. The deceleration time or the slope of the ramp is determined by the setting of drive parameter  $C1-02$ .  $H5-04 = 1$  selects Coast to Stop. The drive does not attempt to control the rate of deceleration.  $H5-04 = 2$  selects Fast Stop. The deceleration time is determined by the setting of drive parameter  $C1-09$ .

**Note:**

The behavior of the drive at cable loss is controlled by parameter  $H5-04$ . This drive parameter works with the points as described in the table above to determine how the drive will respond to a cable loss. If the cable loss fault is disabled, the drive will continue in its last state, if running the drive will continue to run at the last commanded frequency.

**Stop with Fault (CE)**

In this mode, CBL LOSS TMR (POINT 92) is set to the desired interval, COMM FLT ENA (POINT 90) or is set to "ON" and either CMD RUN.FWD (Point 22) or CMD RUN.REV (Point 24) is also set to "ON". If the time between messages exceeds the timeout interval, a "CE" fault is declared and the drive stops. The stopping method is controlled by the setting of  $H5-04$  and is described above. CBL LOSS FRQ (POINT 91) is ignored.

**Drive Fault Numbers**

Refer to [Minor Fault/Alarm Contents on page 308](#) for fault trace/history register contents information.

**◆ Mailbox Functions**

This section defines the APOGEE FLN points that read and write drive parameters.

**■ Reading a Drive Parameter**

These two are the points to read any drive parameter:

- #70: Specifies the parameter to be read from
- #71: Reports the value of the parameter specified in Point #70

When this point is read, it retrieves data from the parameter and sends it to the controller.

Example:

1. Writing a value of 387 (183H) to Point #70 specifies drive parameter  $b1-04$  [Reverse Operation Selection].
2. Reading Point #71 returns the current setting of  $b1-04$  to the controller.

**■ Writing to a Drive Parameter**

Two two are the points to write to any drive parameter:

- #72: Specifies the parameter to be written to
- #73: Entry location of the value to be written to the parameter specified in Point #72

When this point is written to, it will write the value to the drive. An enter or accept command does not need to be sent for the data to be taken by the drive. The behavior of the write is the same as with the keypad. If the drive is running, there are a limited number of drive parameters that can be written to.

Example:

1. Writing a value of 387 (183H) to Point #72 specifies drive parameter  $b1-04$  [Reverse Operation Selection].
2. Writing a value of 1 to Point #73 enables the drive for reverse run.

## ◆ Troubleshooting Checklist

Checked	No.	Item to Check
	1	Connect power to the drive and verify that the drive operates correctly in HAND Mode from the digital operator without being connected to the network. Record the drive model number at this time: Model Number:
	2	Record the control board part number: Control Board Part Number:
	3	All network devices have unique addresses and drives are addressed between 0 to 99 (0 to 63 hex). Drive Address:
	4	Set <i>b1-02 [Run Command Selection 1]</i> correctly. b1-02:
	5	Set <i>b1-01 [Frequency Reference Selection 1]</i> correctly. b1-01:
	6	Use the correct cable type. Mfg: P/N:
	7	All cable connections are correct per device schematic and are secure.
	8	All cables have been checked for continuity. There are no breaks or shorts.
	9	The network is correctly terminated.
	10	The shield is continuous throughout the network and is properly grounded on each end.
	11	The network cable is routed away from any high voltage cable(s) or source(s).
	12	All network devices have been tested for conformance with the APOGEE FLN specification.

## 6.5 Metasys N2 Communications

This section gives detailed information about the parameters, error codes and communication procedures for Metasys N2 communications.

### ◆ Configure Master/Slave

You can monitor and control the drive from a controller on a Metasys N2 network (N2) with RS-485 technology. The drives act as slaves on the N2 network.

A possible maximum of 255 drives can communicate on a single N2 network. When more drives or N2 devices are necessary, another N2 network is necessary.

You can use a drive parameter to set the N2 node address. This gives the physical address of the drive on the MS-TP network.

When you set the addressing, a controller can start communication to the drive. The drive will do the specified function and send a response back to the controller.

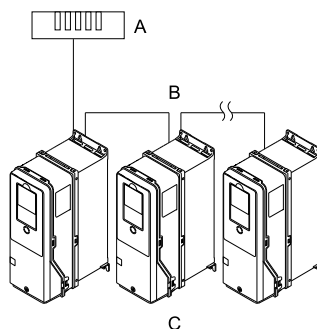

A - Metasys Field Controller  
B - N2

C - Drives

Figure 6.9 Connection Example of Multiple Drives to a Metasys N2 Network

### ◆ Communication Specifications

Table 6.13 lists the specifications for the Metasys N2 communications.

Table 6.13 Metasys N2 Specifications

Item	Specifications
Interface	RS-485
Communication parameter	Communication speed: 9.6 kbps
	Data length: 8 bit (fixed)
	Parity: none
	Stop bit: 1 bit (fixed)
Communication protocol	Metasys N2
Number of possible units to connect	Maximum: 255 units for each N2 network segment

### ◆ Communication with the PLC

This section explains how to connect the drive to an N2 network and the network termination required for a connection.

#### ■ Connect Communications Cable

Use this procedure to start communication between the PLC and drive.

1. De-energize the drive then connect the communications cable to the PLC and the drive. The drive uses terminal TB6 for serial communications.

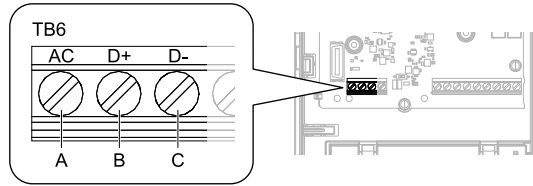

**A - Terminal AC: Signal ground**

**B - Terminal D+: Communication input/output (+)**

**C - Terminal D-: Communication input/output (-)**

**Figure 6.10 Communications Cable Connection Terminal (TB6)**

**Note:**

Isolate the communications wiring from the main circuit wiring and other high-power wiring. Use shielded wires for the communications wiring and connect cable sheaths to the ground terminal of the drive. Incorrect wiring procedures could cause drive malfunction because of electrical interference.

2. Install the termination resistor on the network termination slave drive. Set the DIP switch S2 to the ON position to enable the termination resistor on the drive.
3. Energize the drive.
4. Use the drive keypad to set the necessary communications parameters *H5-01 to H5-12*.
  - *H5-01 [Drive Node Address]*
  - *H5-02 [Communication Speed Selection]*
  - *H5-03 [Communication Parity Selection]*
  - *H5-04 [Stopping Method after Com Error]*
  - *H5-05 [Comm Fault Detection Select]*
  - *H5-06 [Drive Transmit Wait Time]*
  - *H5-08 [Communication Protocol Selection]*
  - *H5-09 [CE Detection Time]*
  - *H5-10 [Modbus Register 0025H Unit Sel]*
  - *H5-11 [Communications ENTER Func Select]*
  - *H5-12 [Run Command Method Selection]*
5. De-energize the drive and wait for the keypad display to turn off or set *H5-20 = 1 [Communication Parameters Reload = Reload Now]*.
6. Energize the drive.

The drive is prepared to start communication with the PLC.

### ■ Set the Termination Resistor

You must enable the termination resistor on the serial terminals of the drives on the two physical ends of the network to use serial communications. Use DIP switch S2 on the terminal block to enable and disable the built-in termination resistor. Refer to [Figure 6.11](#) for an example of how to set DIP switch S2. Use the tip of a tweezers or a jig with a tip width of 0.8 mm (0.03 in) to set the DIP switch. When you install the drive in the terminal of the communication line, set DIP switch S2 to ON. Set DIP switch S2 to OFF on all other drives.

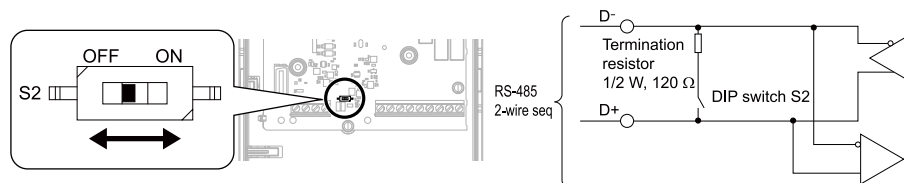

**Figure 6.11 Serial Communication Terminal and DIP Switch S2**

### ■ Wiring Diagram for More than One Drive

[Figure 6.12](#) shows how to wire more than one connected drive with using serial communications.

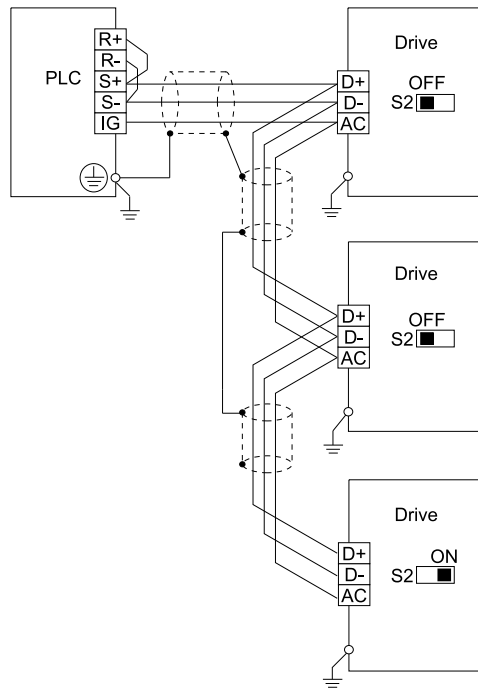

Figure 6.12 Wiring Diagram for More than One Drive

**Note:**

Set DIP switch S2 to the ON position on the last drive of the serial communication network to enable the termination resistor.

## ◆ Drive Operations by Serial Communications

Drive parameters will apply to the settings when the drive is running during serial communications. This section gives information about the available functions and their related parameters.

### ■ Executable Functions

A PLC can do these operations with serial communications. Parameter settings (except *H5-xx*) do not have an effect on the availability of these operations.

- Monitor the drive status and operate the drive
- Set and view parameters
- Fault Reset Procedure
- Multi-function input and output setting (The input command from serial communications and MFDI terminals (S1 to S7) are linked by a logical OR operation.)

### ■ Drive Control

To use external commands to set the frequency references and motor run/stop with serial communications, set these parameters as specified by the application:

- *b1-01* = 2 [*Frequency Reference Selection 1 = Serial Communications*]
- *b1-02* = 2 [*Run Command Selection 1 = Serial Communications*]
- *b1-02* = 7 [*AUTO Command + Term Run*]
- *b1-02* = 8 [*AUTO Command + Serial Run*]
- *b1-02* = 9 [*AUTO Command + Option Run*]

For more information about operation mode selection, refer to *b1-01* and *b1-02*.

### ■ Drive Functions

Enable these functions during start-up of the drive:

- Start and Stop the Drive

Set the Run Forward Command (BO 1) to run the drive in the forward direction. Set the Run Reverse Command (BO 2) to run the drive in the reverse direction. Run/Stop Monitor (BI 1) shows the current run status of the drive. Forward/Reverse Monitor (BI 2) shows the current direction.

**NOTICE:** *Damage to Equipment. Make sure that the motor direction is correct when you set b1-04 = 0 [Reverse Operation Selection = Reverse Enabled]. Incorrect motor direction can cause damage to HVAC equipment.*

- Lock the Drive Panel

Locking the panel prevents the user from using the HAND and OFF keys locally at the drive panel. Panel Lock (BO 10) can be commanded to lock and unlock the panel.

- Digital Inputs

Multi-Function Input S3 (BO 5) through Multi-Function Input S7 (BO 9) are physical digital inputs on the drive. They can be set either by external devices, such as limit or pressure switches, or by the network. Their function depends on how the drive has been programmed. Refer to the User Manual section on Multi-Function Inputs (*H1-03 to H1-07*) for detailed information on the use and programming of the multi-function inputs. The multi-function input status can be monitored through Multi-Function Input 1 Monitor (BI 14) through Multi-Function Input 5 Monitor (BI 19). The Multi-Function Input # Monitor state is the logical OR of the serial command value (BO 5 to BO 9) and the state of the external connection.

**Note:**

The multi-function inputs can be set by both external devices or over the network. Use caution when connecting the multi-function inputs to external devices to ensure correct system operation.

- Digital Outputs

Multi-Function Output 1 (BI 10) through Multi-Function Output 3 (BI 12) are physical digital outputs on the drive. Their function depends on how the drive has been programmed. Refer to the User Manual section on Multi-Function Outputs (*H2-01 to H2-03*) for more information about the use and programming of the multi-function outputs.

- Loop Gain

PI Proportional Gain (AO 4) and PI Integral Time (AO 5) are the gain and integral time parameters used by the drive. The PI loop is structured differently than the Metasys loop. Refer to the User Manual section on PID for information on how the PI loop functions.

- Reading and Resetting Faults

The Fault Monitor (BI 4) and Drive Ready Monitor (BI 3) show the current status of the drive. The Fault Code (AI 10) contains the code for the most current fault. The LST Fault Code (AI 19) contains the code for the previous fault. Refer to Alarm Register Contents on page 365 for descriptions of the fault codes. The drive faults can be reset through the Fault Reset Command (BO 4). The Fault Reset Command is only available when the Run Forward Command and the Run Reverse Command are both OFF.

### ■ Cable Loss Configuration and Behavior

This section gives the configurable cable loss feature of the drive. This feature offers a user maximum flexibility in determining drive response to a loss of communication.

- Drive Behavior at Loss of Communication

The drive can be configured to respond to an interval without receipt of a message in one of these methods:

- Continue at last speed
- Continue at last speed with alarm
- Continue at preset speed
- Ramp to Stop with *EF0* [*Option Card External Fault*]
- Coast to Stop with *EF0*
- Emergency Stop with *EF0*

- Metasys N2 I/O

Three Metasys N2 outputs are used to select the desired behavior:

- AO 21 - Cable Loss Timeout
- AO 22 - Cable Loss Speed
- BO 11 - Communication Fault

Table 6.14 Cable Loss Behavior Summary

Behavior	H5-04 [Communication Error Stop Method]	Cable Loss Timeout (AO 21)	Cable Loss Speed (AO 22)	Communication Fault Enable (BO 11)
Decelerate to stop (stop time in C1-02) with EF0 fault	0 [Ramp to Stop]	Timeout Interval	x	ON
Coast to stop with EF0 fault	1 [Coast to Stop]	Timeout Interval	x	ON
Emergency stop (stop time in C1-09) with EF0 fault	2 [Fast Stop (Use C1-09)]	Timeout Interval	x	ON
Continue at last speed	3 [Alarm Only]	0	x	x
Continue at last speed with alarm	3 [Alarm Only]	Timeout Interval	x	ON
Continue at preset speed with alarm	4 [Run at H5-34 (CE Go-To-Freq)]	Timeout Interval	Preset speed	ON

**Note:**

1. Communication must first be established and then lost for these features to function as described. If a drive is powered-up without a cable connected or with the master controller offline, a communications timeout does not occur.
2. For modes that describe the drive running after a communications timeout, a run command must have been issued (BO 1 = "ON" or BO 2 = "ON") prior to loss of communications. For safety purposes, the drive will not automatically restart from a stopped condition. If a user requires the drive to restart automatically, additional external wiring is required to accomplish this (consult factory).

Upon expiration of the communications timeout interval, the FAULT LED lights and remains lit until communication is restored.

- **Continue at Last Speed**

In this mode, Cable Loss Timeout (AO 21) is set to 0, disabling the cable loss feature. The other two settings Cable Loss Speed (AO 22) and Communication Fault Enable (BO 11) are ignored. If communication is lost, the drive simply maintains its last commanded state. The drive will not display an alarm or fault to indicate it has lost communication. This behavior can also be achieved by setting  $H5-04 = 3$ . The drive will display an alarm and continue running. For this specific condition, the Communication Fault Enable (BO 11) must be enabled and Cable Loss Timeout (AO 21) should be set to a value other than 0.

- **Continue at Preset Speed**

In this mode, Cable Loss Timeout (AO 21) is set to the desired interval, Cable Loss Speed (AO 22) is set to the desired preset speed and  $H5-04 = 4$ . If the time between messages exceeds the timeout interval, the drive speed command (AO 1) is set to the Cable Loss Speed (AO 22) and the drive continues running at this new speed. Communication Fault Enable (BO 11) must be set to "ON".

- **Stop with Fault (EF0)**

Communication Fault Enable (BO 11) must be set to "ON". In this mode, Cable Loss Timeout (AO 21) is set to the desired interval and parameter  $H5-04 = 0, 1, \text{ or } 2$ . If the time between messages exceeds the timeout interval, the drive will declare an EF0 fault and the drive speed command (AO 1) will be set to 0. The stopping method is determined by the setting of  $H5-04$ :

- $H5-04 = 0$  selects Ramp to Stop. The deceleration time or the slope of the ramp is determined by the setting of drive parameter C1-02
- $H5-04 = 1$  selects Coast to Stop. The drive does not attempt to control the rate of deceleration.
- $H5-04 = 2$  selects Emergency or Fast Stop. The deceleration time is determined by the setting of drive parameter C1-09.

**Note:**

The behavior of the drive at cable loss is controlled by  $H5-04$ . This drive parameter works with the points as described in the table above to determine how the drive will respond to a cable loss. If the cable loss fault is disabled, the drive will continue in its last state, if running the drive will continue to run at the last commanded frequency.

## ◆ Communications Timing

To prevent overrun of the slave side, the master cannot send a message to the same drive for a selected length of time. To prevent overrun of the master side, the slave cannot send a response message to the master for a selected length of time.

This section gives information about message timing.

### ■ Command Message from Master to Slave

To prevent data loss and overrun, after the master receives a message from the slave, the master cannot send the same type of command message to the same slave for a selected length of time. The minimum wait time is different for each type of message. Refer to [Table 6.15](#) to find the minimum wait times.

**Table 6.15 Minimum Wait Time to Send a Message**

Command Type	Example	Minimum Wait Time
1	<ul style="list-style-type: none"> <li>Operation commands (Run command, stop command)</li> <li>I/O settings</li> <li>Reading the motor and parameter setting values</li> </ul>	5 ms <sup>*/</sup>
2	Writing a parameter	H5-11 = 0: 50 ms H5-11 = 1: 200 ms <sup>*/</sup>
3	Writing of modified data with the Enter command	200 ms to 2 s, depending on the number of parameters that were changed <sup>*/</sup>
4	Enter with storage to drive EEPROM after initialization	5 s

\*1 When the drive receives a message in the minimum wait time, it does command type 1 and sends a response message. If the drive receives command type 2 or command type 3 messages in the minimum wait time, it will trigger a communications error or the drive will ignore the command.

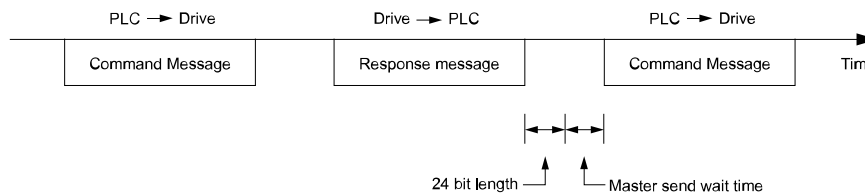
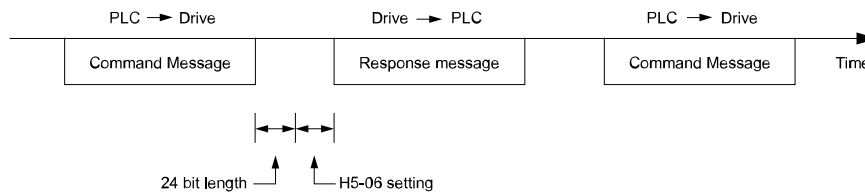

**Figure 6.13 Minimum Wait Time to Send a Message**

You must set the timer in the master to measure the length of time for the slave to respond to the master. If you set the timer, but the slave does not send a response message in a specified length of time, the master will send the message again.

### ■ Response Message from Slave

The slave receives the command message from the master then processes the data it received. The slave then waits for the time set in *H5-06 [Drive Transmit Wait Time]* then sends a response message to the master. If overrun occurs on the master, increase the wait time set in *H5-06*.



**Figure 6.14 Response Wait Time**

## ◆ Metasys N2 Point Database

This section describes the Metasys N2 point database. This database features 100 logical points: 38 Analog Inputs (AI), 32 Analog Outputs (AO), 19 Binary Inputs (BI) and 11 Binary Outputs (BO). These points configure, control, and monitor the operation of the drive.

### ■ Metasys N2 Analog Input (AI) Summary

**Table 6.16 Metasys N2 Analog Input Summary (Drive to Metasys N2)**

Object ID	Object Name	Units	Drive Parameters
AI 1	Speed Reference	0.01 Hz	U1-01
AI 2	Output Speed	0.01 Hz	U1-02



Object ID	Object Name	Units	Drive Parameters
AI 3	Output Current	0.1 A	U1-03
AI 4	kWatt Hour Meter	kWh	U4-10
AI 5	Output Power	0.1 kWh	U1-08
AI 6	Drive Temperature	1 °C	U4-08
AI 7	PI Feedback	0.01%	U5-01
AI 8	AC Output Voltage	0.1 Vac	U1-06
AI 9	DC Bus Voltage	1 Vdc	U1-07
AI 10	Fault Code	-	U2-01
AI 11	Elapsed Time - Hours	1 hour	U4-01
AI 12	Elapsed Time - 10K Hours	10K hours	U4-01
AI 13	MWatt Hour meter	MWh	U4-11
AI 14	Drive Rated Current	A	-
AI 15	Communication Error Code	-	U1-19
AI 16	PI Deviation	0.01%	U5-02
AI 17	PI Output Capacity	0.01%	U5-03
AI 18	PI Reference	0.01%	U5-04
AI 19	Last Fault Code	-	U2-02
AI 20	Freq Ref @ Fault	0.01 Hz	U2-03
AI 21	Output Freq @ Fault	0.01 Hz	U2-04
AI 22	Output Current @ Fault	0.1 A	U2-05
AI 23	Out Volt Ref @ Fault	0.1 Vac	U2-07
AI 24	DC Bus Volts @ Fault	1 Vdc	U2-08
AI 25	Output Power @ Fault	0.1 kW	U2-09
AI 26	Input Term Status @ Fault	-	U2-11
AI 27	Output Term Status @ Fault	-	U2-12
AI 28	Operation Status @ Fault	-	U2-13
AI 29	Elapsed Operation Time @ Fault	1 hour	U2-14
AI 30	Most Recent Fault	-	U3-01
AI 31	2nd Most Recent Fault	-	U3-02
AI 32	3rd Most Recent Fault	-	U3-03
AI 33	4th Most Recent Fault	-	U3-04
AI 34	Elapsed Time @ Current Fault	1 hour	U3-11
AI 35	Elapsed Time @ 2nd Fault	1 hour	U3-12
AI 36	Elapsed Time @ 3rd Fault	1 hour	U3-13
AI 37	Elapsed Time @ 4th Fault	1 hour	U3-14
AI 38	Read Parameter Data	-	-

## ■ Metasys N2 Analog Output (AO) Summary

Table 6.17 Metasys N2 Analog Output Summary (Drive to Metasys N2)

Object ID	Object Name	Units	Default Value	Drive Parameters
AO 1	Speed Command	0.01 Hz	-	-
AO 2	Acceleration Time	s	30.0	C1-01
AO 3	Deceleration Time	s	30.0	C1-02

## 6.5 Metasys N2 Communications

Object ID	Object Name	Units	Default Value	Drive Parameters
AO 4	PI Proportional Gain	-	2.00	b5-02
AO 5	PI Integral Time	s	5.0	b5-03
AO 6	Stall Prevention Level - Run	%	120	L3-06
AO 7	Stall Prevention Level - Accel	%	120	L3-02
AO 8	Reference Operation Mode Select	-	1	b1-01
AO 9	Run Operation Mode Select	-	1	b1-02
AO 10	PI Mode Select	-	0	b5-01
AO 11	Frequency Command Upper Limit	% of Max	100.0	d2-01
AO 12	Frequency Command Lower Limit	% of Max	0.0	d2-02
AO 13	Motor Rated Current	A	Motor model dependent	E2-01
AO 14	Jump Frequency 1	0.1 Hz	0.0	d3-01
AO 15	Jump Frequency 2	0.1 Hz	0.0	d3-02
AO 16	Jump Frequency 3	0.1 Hz	0.0	d3-03
AO 17	Jump Frequency Bandwidth	0.1 Hz	1.0	d3-04
AO 18	Number of Auto Restarts	-	0	L5-01
AO 19	Operator Display Mode	-	0	o1-03
AO 20	Power Loss Ride-Thru	s	Drive model dependent	L2-02
AO 21	Cable Loss Timeout	s	2.0	H5-09
AO 22	Cable Loss Speed	0.01 Hz	0.00	d1-04
AO 23	PI Integral Limit	0.1%	100.0	b5-04
AO 24	PI Upper Limit Value	0.1	100.0	b5-06
AO 25	PI Offset Adjustment	0.1	0.0	b5-07
AO 26	PI Primary Delay Time	0.01	0.00	b5-08
AO 27	Not Used	-	-	-
AO 28	Not Used	-	-	-
AO 29	Not Used	-	-	-
AO 30	Read Parameter Number	-	-	-
AO 31	Write Parameter Number	-	-	-
AO 32	Write Parameter Data	-	-	-

### ■ Metasys N2 Binary Input (BI) Summary

Table 6.18 Metasys N2 Binary Input Summary (Drive to Metasys N2)

Object ID	Object Name	Default	OFF (0) State	ON (1) State
BI 1	Run/Stop Monitor	0	Stopped	Running
BI 2	Forward/Reverse Monitor	0	Forward	Reverse
BI 3	Drive Ready Monitor	0	Not Ready	Ready
BI 4	Fault Monitor	0	Not Faulted	Faulted
BI 5	Zero Speed	0	Not Zero Speed	Zero Speed
BI 6	Speed Agree	0	Not Speed Agree	Speed Agree
BI 7	Minor Fault	0	No Minor Fault	Minor Fault
BI 8	Major Fault	0	No Major Fault	Major Fault
BI 9	Drive Communication Error Monitor	0	No Error	Error
BI 10	Multi-Function Output 1 (H2-01)	0	OFF	ON

Object ID	Object Name	Default	OFF (0) State	ON (1) State
BI 11	Multi-Function Output 2 (H2-02)	0	OFF	ON
BI 12	Multi-Function Output 3 (H2-03)	0	OFF	ON
BI 13	Safety Interlock Monitor	0	Safety Clear Terminal 3 Closed	Safety Set Terminal 3 Open
BI 14	HAND/AUTO Reference Monitor	0	AUTO or OFF	HAND
BI 15	Multi-Function Input S3 Monitor	0	OFF	ON
BI 16	Multi-Function Input S4 Monitor	0	OFF	ON
BI 17	Multi-Function Input S5 Monitor	0	OFF	ON
BI 18	Multi-Function Input S6 Monitor	0	OFF	ON
BI 19	Multi-Function Input S7 Monitor	0	OFF	ON

## ■ Metasys N2 Binary Output (BO) Summary

Table 6.19 Metasys N2 Binary Output Summary (Drive to Metasys N2)

Object ID	Object Name	Default	OFF (0) State	ON (1) State
BO 1	Run Forward Command	0	Stop	Forward
BO 2	Run Reverse Command	0	Stop	Reverse
BO 3	Serial Fault (EF0) Command	0	No Fault	Fault
BO 4	Fault Reset Command	0	No Reset	Reset
BO 5	Multi-Function Input S3 (H1-03)	0	OFF	ON
BO 6	Multi-Function Input S4 (H1-04)	0	OFF	ON
BO 7	Multi-Function Input S5 (H1-05)	0	OFF	ON
BO 8	Multi-Function Input S6 (H1-06)	0	OFF	ON
BO 9	Multi-Function Input S7 (H1-07)	0	OFF	ON
BO10	Panel Lock	0	HAND, AUTO, and OFF and Stop/ Reset Keys Enabled	HAND, AUTO, and OFF and Stop/ Reset Keys Disabled
BO 11	Communication Fault Enable	0	EF0 Not Activated if Cable Loss Occurs	EF0 Activated if Cable Loss Occurs

## ◆ Mailbox Functions

This section defines the Metasys N2 points that read and write drive parameters.

### ■ Reading a Drive Parameter

Two points are defined for reading drive parameters:

- AO 30 - Specifies the parameter to be read from the drive
- AI 38 - Reports the value of the parameter specified in AO 30.

When this point is read, it retrieves data from the parameter and sends it to the controller

Example: Writing a value of 387 (183 hex) to AO 30 specifies drive parameter *b1-04*. Reading AI 38 returns the current setting of parameter *b1-04* to the controller.

### ■ Writing to a Drive Parameter

Two points are defined for writing to drive parameters:

- AO 31 - Specifies the parameter to be written to
- AO 32 - Entry location of the value to be written to the parameter specified in AO 31. When this point is written to, it will write the value to the drive. An ENTER or ACCEPT command does not need to be sent for the data to be taken by the drive. The behavior of the write is the same as with the digital operator. If the drive is running, there are a limited number of drive parameters that can be written to.

Example: Writing a value of 387 (183 hex) to AO 31 specifies drive parameter *b1-04*. Writing a value of 1 to AO 32 sets *b1-04* = 1 and enables the drive for reverse run.

## ◆ Self-Diagnostics

The drive can use Self-Diagnostics to verify the hardware transceiver on the control circuit board. Self-Diagnostics connects the transmission terminal to the reception terminal on the control circuit and transmits the data to itself to make sure that the drive can communicate correctly.

Use this procedure to do Self-Diagnostics:

**DANGER! Electrical Shock Hazard.** Do not examine, connect, or disconnect wiring on an energized drive. Before servicing, disconnect all power to the equipment and wait for the time specified on the warning label at a minimum. The internal capacitor stays charged after the drive is de-energized. The charge indicator LED extinguishes when the DC bus voltage decreases below 50 Vdc. When all indicators are OFF, remove the covers before measuring for dangerous voltages to make sure that the drive is safe. If you do work on the drive when it is energized, it will cause serious injury or death from electrical shock.

1. Energize the drive.
2. Set H1-06 = 67 [Terminal S6 Function Selection = Communications Test Mode].
3. De-energize the drive.
4. Connect a jumper between control circuit terminals S6 and SN.

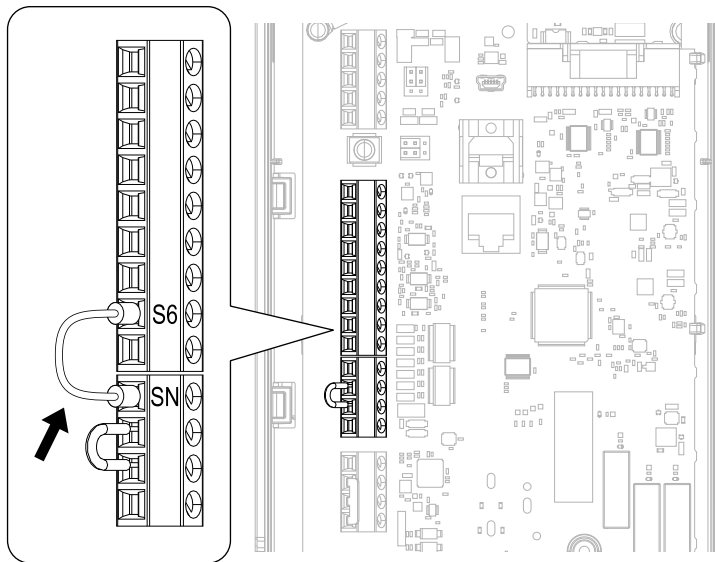

Figure 6.15 Self-Diagnostics Jumper Terminals

5. Energize the drive.
6. When normal, the keypad will show *PASS* [Modbus Communication Test].

**Note:**

If there is an error, the keypad will show *CE* [Modbus Communication Error]. Disconnect the drive from the network and test the drive again. If the error stays, there is a possible hardware problem. If there is no error, there is a possible network wiring problem.

7. De-energize the drive.
8. Disconnect the wire jumper between terminals S6 and SN. Set terminal S6 to its initial function.

Self-Diagnostics is complete and the drive returns to its usual function.

## 6.6 MEMOBUS/Modbus Communications

This section gives detailed information about the parameters, error codes and communication procedures for MEMOBUS/Modbus communications.

### ◆ Configure Master/Slave

You can use the MEMOBUS/Modbus protocol for serial communication with programmable controllers (PLC).

The MEMOBUS/Modbus communication uses one master (PLC) and a maximum of 31 slave drives. Serial communications usually starts with a signal from the master to the slave drives.

A slave drive that receives a command from the master does the specified function and then sends a response back to the master. You must set the address number for each slave drive before you start signal communications to make sure that the master uses the correct address numbers.

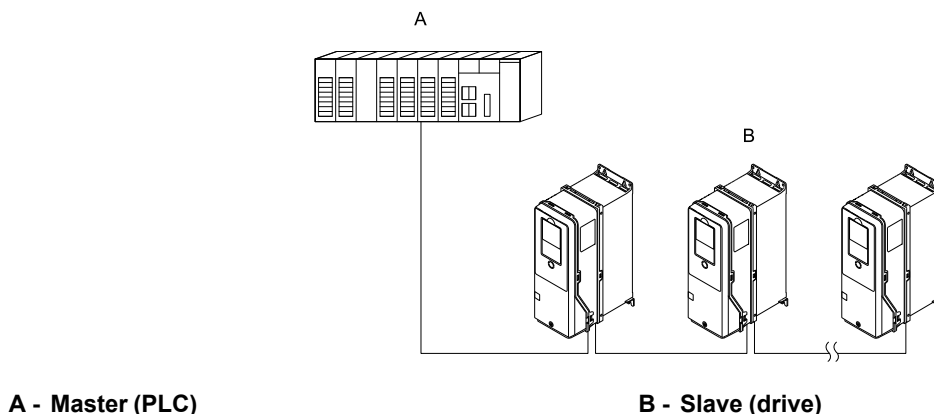

Figure 6.16 PLC and Drive Connection Example

### ◆ Communication Specifications

Table 6.20 lists the specifications for the MEMOBUS/Modbus communications.

Table 6.20 MEMOBUS/Modbus Specifications

Item	Specification
Interface	RS-485
Synchronization method	Asynchronous (start-stop synchronization)
Communication parameter	Communications speed: 1.2, 2.4, 4.8, 9.6, 19.2, 38.4, 57.6, 76.8, 115.2 kbps
	Data length: 8 bit (fixed)
	Parity: even, odd, none
	Stop bit 1 bit (fixed)
Communication protocol	MEMOBUS/Modbus standard (RTU mode only)
Number of possible units to connect	Maximum: 31 units

### ◆ Communication with the PLC

This section gives information about the settings for the termination resistor and how to connect to MEMOBUS/Modbus communications. MEMOBUS/Modbus communications uses an RS-485 interface (2-wire sequence).

#### ■ Connect Communications Cable

Use this procedure to start communication between the PLC and drive.

1. De-energize the drive then connect the communications cable to the PLC and the drive. The drive uses terminal TB6 for serial communications.

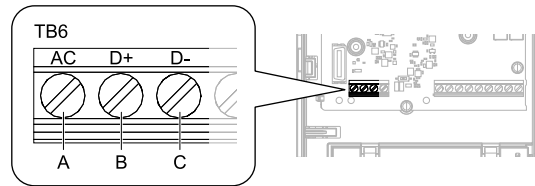

**A - Terminal AC: Signal ground**

**B - Terminal D+: Communication input/output (+)**

**C - Terminal D-: Communication input/output (-)**

**Figure 6.17 Communications Cable Connection Terminal (TB6)**

**Note:**

Isolate the communications wiring from the main circuit wiring and other high-power wiring. Use shielded wires for the communications wiring and connect cable sheaths to the ground terminal of the drive. Incorrect wiring procedures could cause drive malfunction because of electrical interference.

2. Install the termination resistor on the network termination slave drive. Set the DIP switch S2 to the ON position to enable the termination resistor on the drive.
3. Energize the drive.
4. Use the drive keypad to set the necessary communications parameters *H5-01 to H5-12*.
  - *H5-01 [Drive Node Address]*
  - *H5-02 [Communication Speed Selection]*
  - *H5-03 [Communication Parity Selection]*
  - *H5-04 [Stopping Method after Com Error]*
  - *H5-05 [Comm Fault Detection Select]*
  - *H5-06 [Drive Transmit Wait Time]*
  - *H5-08 [Communication Protocol Selection]*
  - *H5-09 [CE Detection Time]*
  - *H5-10 [Modbus Register 0025H Unit Sel]*
  - *H5-11 [Communications ENTER Func Select]*
  - *H5-12 [Run Command Method Selection]*
5. De-energize the drive and wait for the keypad display to turn off or set *H5-20 = 1 [Communication Parameters Reload = Reload Now]*.
6. Energize the drive.

The drive is prepared to start communication with the PLC.

### ■ Set the Termination Resistor

You must enable the termination resistor on the serial terminals of the drives on the two physical ends of the network to use serial communications. Use DIP switch S2 on the terminal block to enable and disable the built-in termination resistor. Refer to [Figure 6.18](#) for an example of how to set DIP switch S2. Use the tip of a tweezers or a jig with a tip width of 0.8 mm (0.03 in) to set the DIP switch. When you install the drive in the terminal of the communication line, set DIP switch S2 to ON. Set DIP switch S2 to OFF on all other drives.

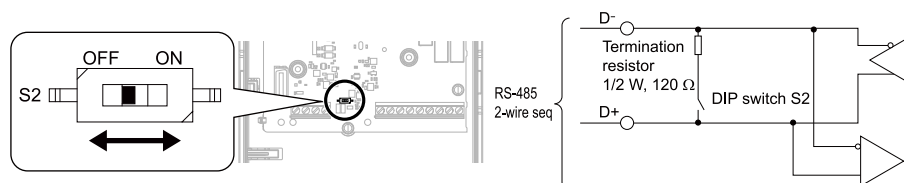

**Figure 6.18 Serial Communication Terminal and DIP Switch S2**

### ■ Wiring Diagram for More than One Drive

[Figure 6.19](#) shows how to wire more than one connected drive with using serial communications.

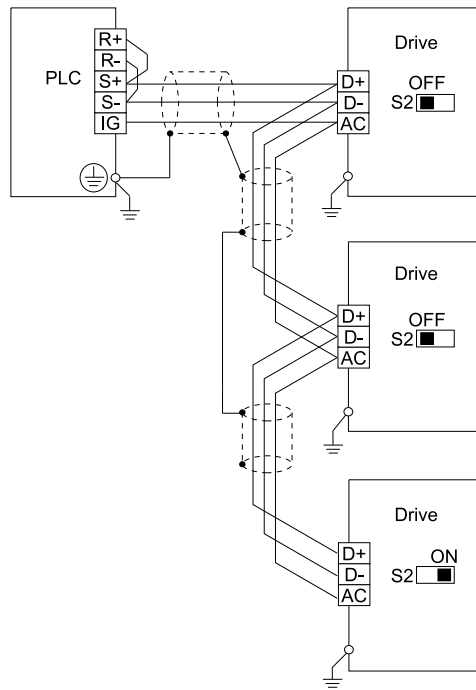

Figure 6.19 Wiring Diagram for More than One Drive

**Note:**

Set DIP switch S2 to the ON position on the last drive of the serial communication network to enable the termination resistor.

## ◆ Drive Operations by Serial Communications

Drive parameters will apply to the settings when the drive is running during serial communications. This section gives information about the available functions and their related parameters.

### ■ Executable Functions

A PLC can do these operations with serial communications. Parameter settings (except *H5-xx*) do not have an effect on the availability of these operations.

- Monitor the drive status and operate the drive
- Set and view parameters
- Fault Reset Procedure
- Multi-function input and output setting (The input command from serial communications and MFDI terminals (S1 to S7) are linked by a logical OR operation.)

### ■ Drive Control

To use external commands to set the frequency references and motor run/stop with serial communications, set these parameters as specified by the application:

- $b1-01 = 2$  [Frequency Reference Selection 1 = Serial Communications]
- $b1-02 = 2$  [Run Command Selection 1 = Serial Communications]
- $b1-02 = 7$  [AUTO Command + Term Run]
- $b1-02 = 8$  [AUTO Command + Serial Run]
- $b1-02 = 9$  [AUTO Command + Option Run]

For more information about operation mode selection, refer to *b1-01* and *b1-02*.

## ◆ Communications Timing

To prevent overrun of the slave side, the master cannot send a message to the same drive for a selected length of time.

To prevent overrun of the master side, the slave cannot send a response message to the master for a selected length of time.

This section gives information about message timing.

### ■ Command Message from Master to Slave

To prevent data loss and overrun, after the master receives a message from the slave, the master cannot send the same type of command message to the same slave for a selected length of time. The minimum wait time is different for each type of message. Refer to [Table 6.21](#) to find the minimum wait times.

**Table 6.21 Minimum Wait Time to Send a Message**

Command Type	Example	Minimum Wait Time
1	<ul style="list-style-type: none"> <li>Operation commands (Run command, stop command)</li> <li>I/O settings</li> <li>Reading the motor and parameter setting values</li> </ul>	5 ms <sup>*/1</sup>
2	Writing a parameter	H5-11 = 0: 50 ms H5-11 = 1: 200 ms <sup>*/1</sup>
3	Writing of modified data with the Enter command	200 ms to 2 s, depending on the number of parameters that were changed <sup>*/1</sup>
4	Enter with storage to drive EEPROM after initialization	5 s

\*1 When the drive receives a message in the minimum wait time, it does command type 1 and sends a response message. If the drive receives command type 2 or command type 3 messages in the minimum wait time, it will trigger a communications error or the drive will ignore the command.

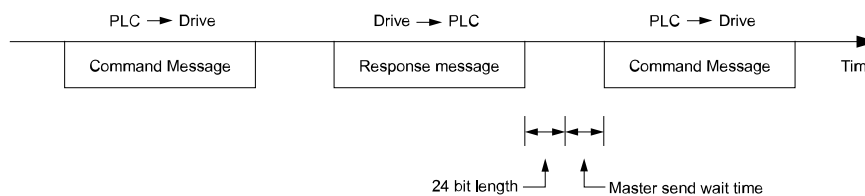
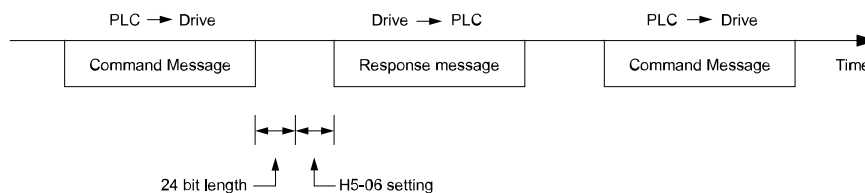

**Figure 6.20 Minimum Wait Time to Send a Message**

You must set the timer in the master to measure the length of time for the slave to respond to the master. If you set the timer, but the slave does not send a response message in a specified length of time, the master will send the message again.

### ■ Response Message from Slave

The slave receives the command message from the master then processes the data it received. The slave then waits for the time set in H5-06 [Drive Transmit Wait Time] then sends a response message to the master. If overrun occurs on the master, increase the wait time set in H5-06.



**Figure 6.21 Response Wait Time**

## ◆ Message Format

### ■ Communication Message Description

In MEMOBUS/Modbus communications, the master sends commands to the slave, then the slave responds. The master and slave send their messages in the configuration in [Figure 6.22](#). The length of the data changes when the description of the command (function) changes.



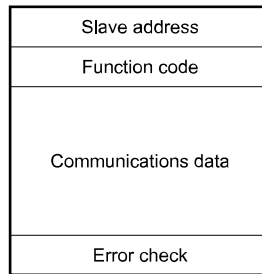

Figure 6.22 Message Format

### ■ Slave Address

Set the slave address of the drive to 00 to FF (Hex.). When the slave address is 00 (Hex), the master sends the command and all slaves receive the command.

The slave will not send a response message to the master.

### ■ Function Code

There are five function codes that set commands. Table 6.22 shows the different codes.

Table 6.22 Function Codes

Function Code (Hex.)	Subfunction Code (Hex.)	Function	Command Message		Response Message	
			Minimum Data Length (byte)	Maximum Data Length (byte)	Minimum Data Length (byte)	Maximum Data Length (byte)
03	-	Read Multiple Holding Registers	8	8	7	37
08	-	Loopback Test	8	8	8	8
10	-	Writing to Multiple Holding Registers	11	41	8	8
5A	-	Writing to Multiple Holding Registers / Reading the Register Indicated	11	41	17	17
67	010D	Reading the Contents of Non-Consecutive Holding Registers	10	248	10	248
	010E	Writing to Non-Consecutive Holding Registers	14	250	8	8

### ■ Communications Data

Communications data is a series of data that uses the combination of the communications register number and the data for these registers. The data length changes when the description of the command changes. For a loopback test, it switches to test code.

The communications register for the drive has a 2-byte length. Data that is written to the register for the drive is usually 2 bytes. Register data that is read from the drive is also 2 bytes.

### ■ Error Check

Error check uses the CRC-16 method to detect transmission errors. Use the procedure in this section to calculate CRC-16.

#### Command Data

When the drive receives data, it will make sure that there are no errors in the data. The drive uses the procedure below to calculate CRC-16, then the drive compares that data with the CRC-16 value in the message. If the CRC-16 values do not agree, the drive will not execute a command message.

When you calculate CRC-16 in MEMOBUS/Modbus communications, make sure that you set the start value as FFFF (Hex.). All 16 bits must be 1.

## 6.6 MEMOBUS/Modbus Communications

Use this procedure to calculate CRC-16:

1. Make sure that the start value is FFFF (Hex.).
2. Calculate the FFFF (Hex.) start value and the XOR of the slave address (exclusive OR).
3. Move the step 2 results one column to the right. Do this shift until the carry bit is 1.
4. When the carry bit is 1, calculate XOR via the result from the above step 3 and A001 (Hex.).
5. Do steps 3 and 4 until the 8th shift to the right.
6. Use the result of step 5 to calculate the XOR and the data of the following messages (function code, register address, data). Do steps 3 to 5 until the last data, then calculate.
7. The result of the last right shift or the value of the last XOR calculation is the result for CRC-16.

Table 6.23 lists examples of the CRC-16 calculation of slave address 02 (Hex.) and function code 03 (Hex.). The calculated results of CRC-16 for this section is D140 (Hex.).

**Note:**

The calculation example only gives information about some error checks with CRC-16. The drive will do the same error checks for the next data.

**Table 6.23 CRC-16 Calculation Example**

Description	Calculation	Overflow	Description	Calculation	Overflow
Initial value (FFFF (Hex.))	1111 1111 1111 1111	-	Function code 03 (Hex.)	0000 0011	-
Address 02 (Hex.)	0000 0010	-	XOR w result	1000 0001 0011 1101	-
XOR w initial value	1111 1111 1111 1101	-	Shift 1	0100 0000 1001 1110	1
Shift 1	0111 1111 1111 1110	1	XOR w A001 (Hex.)	1010 0000 0000 0001	-
XOR w A001 (Hex.)	1010 0000 0000 0001	-	XOR result	1110 0000 1001 1111	-
XOR result	1101 1111 1111 1111	-	Shift 2	0111 0000 0100 1111	1
Shift 2	0110 1111 1111 1111	1	XOR w A001 (Hex.)	1010 0000 0000 0001	-
XOR w A001 (Hex.)	1010 0000 0000 0001	-	XOR result	1101 0000 0100 1110	-
XOR result	1100 1111 1111 1110	-	Shift 3	0110 1000 0010 0111	0
Shift 3	0110 0111 1111 1111	0	Shift 4	0011 0100 0001 0011	1
Shift 4	0011 0011 1111 1111	1	XOR w A001 (Hex.)	1010 0000 0000 0001	-
XOR w A001 (Hex.)	1010 0000 0000 0001	-	XOR result	1001 0100 0001 0010	-
XOR result	1001 0011 1111 1110	-	Shift 5	0100 1010 0000 1001	0
Shift 5	0100 1001 1111 1111	0	Shift 6	0010 0101 0000 0100	1
Shift 6	0010 0100 1111 1111	1	XOR w A001 (Hex.)	1010 0000 0000 0001	-
XOR w A001 (Hex.)	1010 0000 0000 0001	-	XOR result	1000 0101 0000 0101	-
XOR result	1000 0100 1111 1110	-	Shift 7	0100 0010 1000 0010	1
Shift 7	0100 0010 0111 1111	0	XOR w A001 (Hex.)	1010 0000 0000 0001	-
Shift 8	0010 0001 0011 1111	1	XOR result	1110 0010 1000 0011	-
XOR w A001 (Hex.)	1010 0000 0000 0001	-	Shift 8	0111 0001 0100 0001	1
XOR result	1000 0001 0011 1110	-	XOR w A001 (Hex.)	1010 0000 0000 0001	-
Perform operations with next data (function code)			XOR result	1101 0001 0100 0000	-
			CRC-16	1101 0001 0100 0000	-
				D 1 4 0 (Lower) (Upper)	-
Continue from here with next data.					

### Response Data

The drive does the CRC-16 calculation for the response message and makes sure that the data does not have errors. Make sure that the calculated value is the same value as the CRC-16 in the response message.

## ◆ Examples of Messages for Commands/Responses

The items in this section are examples of messages for commands/responses.

### ■ Read Multiple Holding Registers

Uses function code 03 (Hex.) to read the contents of a maximum of 16 holding registers.

Table 6.24 shows example messages when the drive reads status signal from the drive of slave 2, the error contents, fault contents, and frequency references.

Table 6.24 Message Example When Reading the Contents of Holding Register

Byte	Command Message		Setting Data (Hex.)	Response Message (Normal)		Setting Data (Hex.)	Response Message (Fault)		Setting Data (Hex.)
0	Slave address		02	Slave address		02	Slave address		02
1	Function code		03	Function code		03	Function code		83
2	Starting No.	Upper	00	Data Qty		08	Error code		03
3		Lower	20	First storage register	Upper	00	CRC-16	Upper	F1
4	Data Qty	Upper	00		Next storage register	Lower		65	Lower
5		Lower	04	Next storage register		Upper	00	-	
6	CRC-16	Upper	45		Next storage register	Lower	00	-	
7		Lower	F0	Next storage register		Upper	00	-	
8	-				Next storage register	Lower	00	-	
9	-			Next storage register		Upper	01	-	
10	-				CRC-16	Lower	F4	-	
11	-			CRC-16		Upper	AF	-	
12	-				CRC-16	Lower	82	-	

### ■ Loopback Test

The loopback test uses function code 08 (Hex.) and returns the command message as a response message. This test checks communication between the master and slave. The test code and data can use desired values.

Table 6.25 shows examples of messages given out when the loopback test is done with the drive of slave 1.

Table 6.25 Message Examples from the Loopback Test

Byte	Command Message		Setting Data (Hex.)	Response Message (Normal)		Setting Data (Hex.)
0	Slave address		01	Slave address		01
1	Function code		08	Function code		08
2	Test code	Upper	00	Test code	Upper	00
3		Lower	00		Lower	00
4	Data	Upper	A5	Data	Upper	A5
5		Lower	37		Lower	37
6	CRC-16	Upper	DA	CRC-16	Upper	DA
7		Lower	8D		Lower	8D

### ■ Writing to Multiple Holding Registers

You can write the data that you set to the number of holding registers set in function code 10 (hex). You must configure the number of the holding registers and each 8 higher bits and 8 lower bits in order in the command message for the write data. You can write to a maximum of 16 holding registers.

Table 6.26 shows example messages when you use the PLC to set Forward run in the drive of slave 1 with a 60.00 Hz frequency reference.

When you rewrite the parameter value with the write command through the *H5-11 [Comm ENTER Command Mode]* setting, you must use the Enter command to save and enable the contents of the changes. Refer to *H5-11: Comm ENTER Command Mode on page 792* and *Enter Command on page 289* for more information.

**Table 6.26 Message Example When Writing to Multiple Holding Registers**

Byte	Command Message		Setting Data (Hex.)	Response Message (When Normal)		Setting Data (Hex.)	Response Message (When There is a Fault)		Setting Data (Hex.)
0	Slave address		01	Slave address		01	Slave address		01
1	Function code		10	Function code		10	Function code		90
2	Starting No.	Upper	00	Starting No.	Upper	00	Error code		02
3		Lower	01		Lower	01	CRC-16	Upper	CD
4	Data Quantity	Upper	00	Data Quantity	Upper	00		Lower	C1
5		Lower	02		Lower	02	-		
6	Byte No.		04	CRC-16	Upper	10	-		
7	First data	Upper	00		Lower	08	-		
8	Data Quantity		01	-		-		-	
9	Next data	Upper	17	-		-		-	
10		Lower	70	-		-		-	
11	CRC-16	Upper	6D	-		-		-	
12		Lower	B7	-		-		-	

**Note:**

The number of bytes set in the command message set the data quantity  $\times 2$  during the command message. The response message uses the same formula.

### ■ Reading from More than One Holding Register/Reading the Indicated Register

The drive uses function code 5A (Hex.) to write to more than one register, then it reads the contents of four holding registers at the same time.

The function for writing to more than one register is the same as the function for function code 10 (Hex.). You can write to a maximum of 16 holding registers.

The four holding registers to be read from are specified in *H5-25 to H5-28 [Function 5A Register x Selection]*.

Table 6.27 shows example messages when you write to more than one holding register or when you read more than one command register. Table 6.27 uses this register data for the examples:

- The drive for slave 1 is set for Forward run with a frequency reference of 60.00 Hz.
- The setting in *H5-25 to H5-28* and the data in the specified holding registers are as follows.
  - *H5-25* = 0044H: *U1-05 [Motor Speed]* = 60.00 Hz (6000 = 1770H)
  - *H5-26* = 0045H: *U1-06 [Output Voltage Ref]* = 200.0 V (2000 = 07D0H)
  - *H5-27* = 0042H: *U1-03 [Output Current]* = 50% of drive rated current (100% = 8192, 50% = 4096 = 1000H)
  - *H5-28* = 0049H: *U1-10 [Input Terminal Status]* = 00H

When you rewrite the parameter value with the write command through the *H5-11 [Comm ENTER Command Mode]* setting, you must use the Enter command to save and enable the contents of the changes. Refer to *H5-11: Comm ENTER Command Mode on page 792* and *Enter Command on page 289* for more information.

**Table 6.27 Message Example When Reading from More than One Holding Register/Reading the Indicated Register**

Byte	Command Message		Response Message (when normal)		Response Message (when there is a fault)	
		Setting Data (Hex.)		Setting Data (Hex.)		Setting Data (Hex.)
0	Slave address	01	Slave address	01	Slave address	01
1	Function Code	5A	Function Code	5A	Function Code	DA

Byte	Command Message			Response Message (when normal)			Response Message (when there is a fault)		
			Setting Data (Hex.)			Setting Data (Hex.)			Setting Data (Hex.)
2	Starting No.	Upper	00	Register status			Register status		
3		Lower	01	Data in holding register 1 selected with H5-25	Upper	17	Data in holding register 1 selected with H5-25	Upper	17
4	Data Qty	Upper	00		Data in holding register 2 selected with H5-26	Lower		70	Data in holding register 2 selected with H5-26
5		Lower	02	Data in holding register 3 selected with H5-27		Upper	07	Data in holding register 3 selected with H5-27	
6	Byte No.		04		Data in holding register 4 selected with H5-28	Lower	D0		Data in holding register 4 selected with H5-28
7	First data	Upper	00	Data in holding register 1 selected with H5-25		Upper	10	Data in holding register 1 selected with H5-25	
8		Lower	01		Data in holding register 2 selected with H5-26	Lower	00		Data in holding register 2 selected with H5-26
9	Next data	Upper	17	Data in holding register 3 selected with H5-27		Upper	00	Data in holding register 3 selected with H5-27	
10		Lower	70		Data in holding register 4 selected with H5-28	Lower	00		Data in holding register 4 selected with H5-28
11	CRC-16	Upper	4F	Starting No.		Upper	00	Error Codes	
12		Lower	43		Lower	01	CRC-16	Upper	E9
13	-		Data Qty	Upper	00	CRC-16		Lower	6C
14	-			Lower	02		-		
15	-		CRC-16	Upper	AC	-			
16	-			Lower	D0	-			

**Note:**

The number of bytes set in the command message set the data quantity  $\times 2$  during the command message.

Register status	
bit 0	Data in register 1 selected with H5-25 1: Successfully read the register 0: Register read error
bit 1	Data in register 2 selected with H5-26 1: Successfully read the register 0: Register read error
bit 2	Data in register 3 selected with H5-27 1: Successfully read the register 0: Register read error
bit 3	Data in register 4 selected with H5-28 1: Successfully read the register 0: Register read error
bit 4	Not used
bit 5	Not used
bit 6	Not used
bit 7	Not used

### ■ Reading the Contents of Non-Consecutive Holding Registers

The drive uses function code 67 (Hex.) and subfunction code 010D (Hex.) to read data with a maximum of 120 holding registers.

You must give the holding register number from which to read separately.

Table 6.28 shows example messages when you read the frequency reference and torque limit from the drive for slave 1. Table 6.28 uses these specified holding registers data for the examples.

- 0024H:U1-01 [Frequency Reference] = 60.00 Hz (6000 = 1770H)
- 0028H:U1-09 [Torque Reference] = 100.0% (1000 = 03E8H)

**Table 6.28 Message Example When Reading the Contents of Non-Consecutive Holding Registers**

Byte	Command Message			Response Message (when normal)			Response Message (when there is a fault)		
			Setting Data (Hex.)			Setting Data (Hex.)			Setting Data (Hex.)
0	Slave address		01	Slave address		01	Slave address		01
1	Function Code		67	Function Code		67	Function Code		E7
2	Subfunction Code	Upper	01	Subfunction Code	Upper	01	Error Codes		02
3		Lower	0D		Lower	0D	CRC-16	Upper	EA
4	Data Qty	Upper	00	Byte No.	Upper	00		Lower	31
5		Lower	02		Lower	04	-		
6	Holding register 1 No.	Upper	00	Holding register 1 data	Upper	17	-		
7		Lower	24		Lower	70	-		
8	Holding register 2 No.	Upper	00	Holding register 2 data	Upper	03	-		
9		Lower	28		Lower	E8	-		
10	CRC-16	Upper	8B	CRC-16	Upper	47	-		
11		Lower	29		Lower	ED	-		

**Note:**

The number of bytes set within the response message sets twice the number of data contained in the command message.

### ■ Writing to Non-Consecutive Holding Registers

The drive uses function code 67 (Hex.) and subfunction code 010E (Hex.) to read data with a maximum of 60 holding registers.

You must give the holding register number from which to write separately.

Table 6.29 shows example messages when you write the frequency reference and torque limit from the drive for slave 1. Table 6.29 uses these specified holding registers data for the examples.

- 0002H: Frequency Reference = 60.00 Hz (6000 = 1770H)
- 0004H: Torque Limit = 150.0% (1500 = 05DCH)

When you rewrite the parameter value with the write command through the *H5-11 [Comm ENTER Command Mode]* setting, you must use the Enter command to save and enable the contents of the changes. Refer to *H5-11: Comm ENTER Command Mode on page 792* and *Enter Command on page 289* for more information.

**Table 6.29 Message Example When Writing to Non-Consecutive Holding Registers**

Byte	Command Message			Response Message (when normal)			Response Message (when there is a fault)		
			Setting Data (Hex.)			Setting Data (Hex.)			Setting Data (Hex.)
0	Slave address		01	Slave address		01	Slave address		01
1	Function Code		67	Function Code		67	Function Code		E7
2	Subfunction Code	Upper	01	Subfunction Code	Upper	01	Error Codes		02
3		Lower	0E		Lower	0E	CRC-16	Upper	EA
4	Data Qty	Upper	00	Data Qty	Upper	00		Lower	31
5		Lower	02		Lower	02	-		
6	Byte No.	Upper	00	CRC-16	Upper	D5	-		
7		Lower	04		Lower	FC	-		
8	Holding register 1 No.	Upper	00	-			-		
9		Lower	02	-			-		

Byte	Command Message			Response Message (when normal)		Response Message (when there is a fault)	
			Setting Data (Hex.)		Setting Data (Hex.)		Setting Data (Hex.)
10	Holding register 1 data	Upper	17	-	-	-	-
11		Lower	70	-	-	-	-
12	Holding register 2 No.	Upper	00	-	-	-	-
13		Lower	04	-	-	-	-
14	Holding register 2 data	Upper	05	-	-	-	-
15		Lower	DC	-	-	-	-
16	CRC-16	Upper	55	-	-	-	-
17		Lower	59	-	-	-	-

**Note:**

The number of bytes set in the command message set the data quantity  $\times 2$  during the command message.

## ◆ Enter Command

When you use MEMOBUS/Modbus communications to write parameters from the PLC to the drive, *H5-11 [Comm ENTER Command Mode]* lets you use the Enter command to enable these parameters. This section gives information about the Enter command.

### ■ Types of Enter Commands

The drive supports the two Enter commands shown in [Table 6.30](#).

Write 0 to register number 0900 or 0910 (Hex.) to enable the Enter command. You can only write to these registers. If you read to these registers, it will cause an error.

**Table 6.30 Types of Enter Commands**

Register No. (Hex.)	Description
0900	When you write parameter data to the EEPROM, you will enable the data on the RAM at the same time. This process saves the parameter changes even if you de-energize the drive.
0910	This updates the data on the RAM, but does not write data to the EEPROM. If you de-energize the drive, you will lose the parameter changes.

**Note:**

- You can write the EEPROM to the drive a maximum of 100,000 times. Do not frequently execute the Enter command (0900 (Hex.)) that is written to EEPROM.
- The Enter command register is write-only. If this register is read, it will cause a Register Number Error (02 (Hex.)).
- When the command data or broadcast message is transmitted to the drive, the Enter command is not necessary.

### ■ Functions of the Enter Command when Replacing a Previous Generation Drive

When you replace a previous generation Yaskawa drive with this product, you must set the Enter command function for this product the same as the previous product. The Enter command function is different for Yaskawa G7, F7-series, and V7-series drives.

Use *H5-11* to set the Enter command function:

- When replacing G7 and F7 series drives, set *H5-11 = 0 [ENTER Command Required]*.
- When replacing V7 series drives, set *H5-11 = 1 [ENTER Command Not Required]*.
- When replacing 1000-series drives, set *H5-11* to the same value as the drive you replaced.

**Table 6.31 Enter Command Function Differences**

H5-11 Settings	H5-11 = 0	H5-11 = 1
The drive you replaced	G7, F7	V7
Time when the parameter settings are enabled	When the drive receives the Enter command from the master	When you change the parameter settings

H5-11 Settings	H5-11 = 0	H5-11 = 1
Upper and lower limit check	Checks the upper and lower limits and considers the related parameter settings.	Checks the upper and lower limit of the changed parameter only.
Default setting of related parameters	Will not change related parameter settings. You must change the parameters manually.	Automatically changes the default settings for the related parameters.
Fault detection when you set more than one parameter	Accepts and responds as usual to correct setting data if the data contains parameter setting errors. The drive discards the disabled setting data, but will not return an error message.	If there is a setting error in a parameter, the drive responds with a fault. The drive discards the data that was sent.

## ◆ Self-Diagnostics

The drive can use Self-Diagnostics to verify the hardware transceiver on the control circuit board. Self-Diagnostics connects the transmission terminal to the reception terminal on the control circuit and transmits the data to itself to make sure that the drive can communicate correctly.

Use this procedure to do Self-Diagnostics:

**DANGER! Electrical Shock Hazard.** Do not examine, connect, or disconnect wiring on an energized drive. Before servicing, disconnect all power to the equipment and wait for the time specified on the warning label at a minimum. The internal capacitor stays charged after the drive is de-energized. The charge indicator LED extinguishes when the DC bus voltage decreases below 50 Vdc. When all indicators are OFF, remove the covers before measuring for dangerous voltages to make sure that the drive is safe. If you do work on the drive when it is energized, it will cause serious injury or death from electrical shock.

1. Energize the drive.
2. Set H1-06 = 67 [Terminal S6 Function Selection = Communications Test Mode].
3. De-energize the drive.
4. Connect a jumper between control circuit terminals S6 and SN.

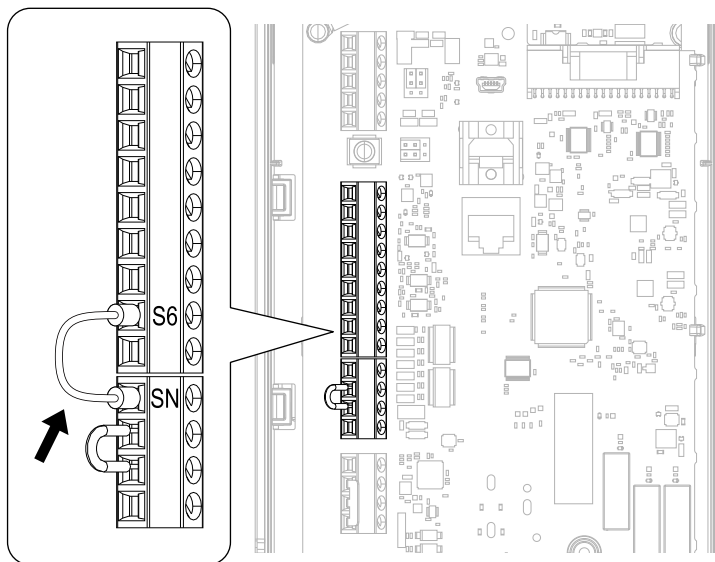

Figure 6.23 Self-Diagnostics Jumper Terminals

5. Energize the drive.
6. When normal, the keypad will show *PASS* [Modbus Communication Test].

**Note:**

If there is an error, the keypad will show *CE* [Modbus Communication Error]. Disconnect the drive from the network and test the drive again. If the error stays, there is a possible hardware problem. If there is no error, there is a possible network wiring problem.

7. De-energize the drive.
8. Disconnect the wire jumper between terminals S6 and SN. Set terminal S6 to its initial function.

Self-Diagnostics is complete and the drive returns to its usual function.



## ◆ Communications Data Table

*Command Data on page 291*, *Monitor Data on page 295*, and *Broadcast Messages on page 307* show the communications data. The data types are command data, monitor data, and broadcast message.

Refer to the Parameter List for parameter communications registers.

### ■ Command Data

You can read and write command data.

**Note:**

Set the reserved bit to 0. Do not write the data in the reserved register or the monitor register.

**Table 6.32 MEMOBUS/Modbus Communications Command Data**

Register No. (Hex.)	Description	
0000	Reserved	
0001	Run command, multi-function input command	
	bit 0	When $H5-12 = 0$ , Forward run/stop 1: Forward run, 0: Stop When $H5-12 = 1$ , run/stop 1: Run, 0: Stop
	bit 1	When $H5-12 = 0$ , Reverse run/stop 1: Reverse run, 0: Stop When $H5-12 = 1$ , Forward/Reverse run 1: Reverse, 0: Forward run
	bit 2	External fault 1: EF0 [Option Card External Fault]
	bit 3	Fault Reset Procedure 1: Reset command
	bit 4	Multi-function input 1 When $H1-01 = 40$ [Forward Run Command (2-Wire Seq)], the multi-function input command is "ComRef". <b>Note:</b> When you switch the bit ON as ComRef, the frequency reference source changes to MEMOBUS/Modbus communications. When you connect a communication option to the drive, the frequency reference source gives priority to the communications option.
	bit 5	Multi-function input 2 When the multi-function input command is $H1-02 = 41$ [Reverse Run Command (2-Wire Seq)], bit 5 is "ComCtrl". <b>Note:</b> When you switch the bit ON as ComCtrl, the Run Command source changes to MEMOBUS/Modbus communications. When you connect a communication option to the drive, the Run Command source gives priority to the communications option.
	bit 6	Multi-function input 3
	bit 7	Multi-function input 4
	bit 8	Multi-function input 5
	bit 9	Multi-function input 6
	bit A	Multi-function input 7
	bit B - F	Reserved
0002	Frequency reference	$o1-03$ [Frequency Display Unit Selection] (unsigned) sets the units.
0003	Output voltage gain	Units: 0.1 % Setting range: 20 (2.0%) to 2000 (200.0%), the default value at energize: 1000 (100.0%)
0004	Torque reference/torque limit (0.1% signed)	
0005	Torque compensation (0.1% signed)	
0006	PID setpoint (0.01% signed)	
0007	Setting for the multi-function analog monitor output terminal 1 (10 V/4000 H)	
0008	Setting for the multi-function analog monitor output terminal 2 (10 V/4000 H)	

## 6.6 MEMOBUS/Modbus Communications

Register No. (Hex.)	Description	
0009	MFDO setting	
	bit 0	MFDO (terminal M1-M2) 1: ON, 0: OFF
	bit 1	MFDO (terminal M3-M4) 1: ON, 0: OFF
	bit 2	MFDO (terminal M5-M6) 1: ON, 0: OFF
	bit 3 - 5	Reserved
	bit 6	1: bit 7 function is enabled
	bit 7	Fault relay output (terminal MA/MB-MC) 1: ON, 0: OFF
	bit 8 - F	Reserved
000A - 000C	Reserved	
000D	PI2 Control Setpoint	Units: 0.01% Setting range: -100.00% to +100.00% To enable this function, set MEMOBUS register 000E, bit 4 = 1.
000E	Reserved	
000F	Command selection setting	
	bit 0	Reserved
	bit 1	PID control target input 1: Enables target values from MEMOBUS/Modbus
	bit 2	Torque reference/torque limit input 1: Enables setting values from MEMOBUS/Modbus
	bit 3	Torque compensation input 1: Enables setting values from MEMOBUS/Modbus
	bit 4	PI2 control target input 1: Enables setting values from MEMOBUS/Modbus
	bit 5	PID feedback from the MEMOBUS/Modbus 1: Enables PID feedback (15FF (Hex.)) from MEMOBUS/Modbus
	bit 6 - B	Reserved
	bit C	Terminal S5 input for broadcast message 1: Enabled, 0: Disabled
	bit D	Terminal S6 input for broadcast message 1: Enabled, 0: Disabled
	bit E	Terminal S7 input for broadcast message 1: Enabled, 0: Disabled
bit F	Reserved	
0010 - 001F	Reserved	
15C0	bit 0	Extended multi-function input command 1
	bit 1	Extended multi-function input command 2
	bit 2	Extended multi-function input command 3
	bit 3 - F	Reserved

Register No. (Hex.)	Description	
15DF	bit 0	Speed Search from Fmax 1: Enables Speed Search from Fmax • This is the same function as $H1-xx = 61$ [MFDI Function Selection = Speed Search from Fmax]. It operates according to the command and OR operation from the MFDI terminals.
	bit 1	Baseblock command 1: Enables baseblock command • This is the same function as $H1-xx = 8$ [Baseblock Command (N.O.)]. It operates according to the command and OR operation from the MFDI terminals.
	bit 2	Baseblock command - Without message 1: Enables baseblock command • This is the same function as $H1-xx = 8$ [Baseblock Command (N.O.)]. • The keypad does not show the <i>bb</i> [Baseblock] alarm message. The ALM LED does not flash.
	bit 3	Coast-to-stop command 1: Enables coast-to-stop command • The drive shuts off the output and the motor coasts to stop at the leading edge of bit 3. • To restart the drive, set bit 3 to 0 and enter the Run command again.
	bit 4	Ramp to stop command 1: Enables ramp to stop command • The drive ramps to stop in the selected deceleration time at the leading edge of bit 4. • To restart the drive, set bit 4 to 0 and enter the Run command again.
	bit 5	Fast stop command 1: Enables fast stop command • This is the same function as $H1-xx = 15$ [Fast Stop (N.O.)]. It operates according to the command and OR operation from the MFDI terminals.
	bit 6	Soft start input reset 1: Enables soft start input reset • When bit 6 is 1, the input to the soft starter will be 0. The drive decelerates the motor in the selected deceleration time. When bit 6 is 0, the motor accelerates to the previous frequency reference. • $U1-01$ [Frequency Reference] shows the set frequency reference.
	bit 7	Soft start output reset 1: Enables soft start output reset • When bit 7 is 1, the output from the soft starter will be 0. • When bit 6 is 0, the motor accelerates to the previous frequency reference.
	bit 8	Accel/decel ramp hold command 1: Enables accel/decel ramp hold command • This is the same function as $H1-xx = A$ [Accel/Decel Ramp Hold]. It operates according to the command and OR operation from the MFDI terminals.
	bit 9	JOG command 1: Enables JOG command • This is the same function as $H1-xx = 6$ [Jog Reference Selection]. It operates according to the command and OR operation from the MFDI terminals.
	bit A	Forward Jog 1: Enables FJOG command • This is the same function as $H1-xx = 12$ [Forward Jog]. It operates according to the command and OR operation from the MFDI terminals.
	bit B	Reverse Jog 1: Enables RJOG command • This is the same function as $H1-xx = 13$ [Reverse Jog]. It operates according to the command and OR operation from the MFDI terminals.
	bit C	PID Disable command 1: Enables PID Disable command • This the same function as $H1-xx = 19$ [PID Disable]. It operates according to the command and OR operation from the MFDI terminals.
bit D - F	Reserved	
15FF	PID feedback (0.01% signed)	
1A7F - 1AA0	HV600 Memobus Data for HV600 Smart Network	
3004	Time Setting Setting range: 0000 to 2359 (decimal), the default value at energize: 0000 Sets the hour and the minute in HHMM format. • HH: 00 to 23 (decimal) • MM: 00 to 59 (decimal)	

## 6.6 MEMOBUS/Modbus Communications

Register No. (Hex.)	Description	
3005	<p>Year and Day Setting Setting range: 1600 to 9906 (decimal), the default value at energize: 1600 Sets the year and the day of the week in YYDW format.</p> <ul style="list-style-type: none"> <li>• YY: the last two digits of the year from 16 to 99 (decimal)</li> <li>• DW: the day of the week <ul style="list-style-type: none"> <li>– Sunday: 00</li> <li>– Monday: 01</li> <li>– Tuesday: 02</li> <li>– Wednesday: 03</li> <li>– Thursday: 04</li> <li>– Friday: 05</li> <li>– Saturday: 06</li> </ul> </li> </ul>	
3006	<p>Date Setting Setting range: 101 to 1231 (decimal), the default setting at energize: 101 Sets the month and the date in MMDD format.</p> <ul style="list-style-type: none"> <li>• MM: 01 to 12 (decimal)</li> <li>• DD: 01 to 31 (decimal)</li> </ul>	
3007	<p>Date and Time Information Setting Setting range: 0 to 8 (decimal), the default value at energize: 8 Sets the values specified in 3004H to 3006H as the date and time.</p> <ul style="list-style-type: none"> <li>• Command Data: 1</li> <li>• Response Data: 0 (normal), 8 (fault)</li> </ul>	
302F	<p>RTC Information Setting Uses the values specified in 3004H to 3006H to update the drive date or time instead of the RTC operator. To enable this function, set MEMOBUS register 3030H, bit 0 = 1. When you set 3030H, bit 1 = 1 and if you do not input 0 to this register in 2 min, the drive does not update the date or time and TIE fault occurs.</p> <ul style="list-style-type: none"> <li>• Command Data: 0</li> </ul>	
3030	RTC Function Enable	
	bit 0	RTC Enter Enable 1: Enabled, 0: Disabled
	bit 1	RTC TIE Fault Enable 1: Enabled, 0: Disabled
	bit 2 - F	Reserved
3A93	HV600 Function Bits	
	bit 0	RTC Disable
	bit 1	Dynamic Noise Control Disable
	bit 2	Reserved
	bit 3	EM Override Freq Reference: Use 3A94H
	bit 4	EM Override PID Feedback: Use 3A95H
	bit 5	EM Override PID Setpoint: Use 3A96H
bit 6 - F	Reserved	
3A94	<p>Emergency Override Frequency Reference Frequency reference used during Emergency Override operation when you set <math>S6-02 = 0</math> or <math>1</math> [<i>Emergency Override Ref Selection = Use Frequency Reference or System PID Mode</i>] and bit 3 of MEMOBUS register 3A93H. The <math>01-03</math> [<i>Frequency Display Unit Selection</i>] setting changes the unit and scale of the input value. The upper limit value of this register is the maximum frequency of the drive set in <math>E1-04</math> [<i>Maximum Output Frequency</i>] (<math>E9-02</math> [<i>Maximum Speed</i>] when <math>A1-02 = 8</math> [<i>Control Method Selection = EZOLV</i>]).</p>	

Register No. (Hex.)	Description
3A95	<p>Emergency Override PID Feedback</p> <p>PID feedback used during Emergency Override operation when you set <math>S6-02 = 2</math> or <math>3</math> [System PID Mode or Independent PID Mode] and bit 4 of MEMOBUS register 3A93H.</p> <p>When <math>S6-02 = 2</math>, these parameters set the unit of the input value:</p> <ul style="list-style-type: none"> <li>• <math>b5-38</math> [PID User Unit Display Scaling]</li> <li>• <math>b5-39</math> [PID User Unit Display Digits]</li> <li>• <math>b5-46</math> [PID Unit Display Selection]</li> </ul> <p>When <math>S6-02 = 3</math>, these parameters set the unit of the input value:</p> <ul style="list-style-type: none"> <li>• <math>S6-03</math> [EMOVR Independent PID Scale]</li> <li>• <math>S6-04</math> [EMOVR Independent PID Unit]</li> <li>• <math>S6-05</math> [EMOVR Independent PID Unit Digit]</li> </ul>
3A96	<p>Emergency Override PID Setpoint</p> <p>PID Setpoint used during Emergency Override operation when you set <math>S6-02 = 2</math> or <math>3</math> and bit 5 of MEMOBUS register 3A93H.</p> <p>When <math>S6-02 = 2</math>, these parameters set the unit of the input value:</p> <ul style="list-style-type: none"> <li>• <math>b5-38</math></li> <li>• <math>b5-39</math></li> <li>• <math>b5-46</math></li> </ul> <p>When <math>S6-02 = 3</math>, these parameters set the unit of the input value:</p> <ul style="list-style-type: none"> <li>• <math>S6-03</math></li> <li>• <math>S6-04</math></li> <li>• <math>S6-05</math></li> </ul>

### ■ Monitor Data

You can only read monitor data.

Table 6.33 Monitor Data for MEMOBUS/Modbus Communication

Register No. (Hex.)	Description	
0020	Drive Status 1	
	bit 0	During Run 1: During run, 0: During stop
	bit 1	During reverse 1: During reverse, 0: Forward run
	bit 2	Drive ready 1: Ready, 0: Not ready
	bit 3	Faults 1: Fault
	bit 4	Data Setting Error 1: oPExx error
	bit 5	MFDO (terminal M1-M2) 1: ON, 0: OFF
	bit 6	MFDO (terminal M3-M4) 1: ON, 0: OFF
	bit 7	MFDO (terminal M5-M6) 1: ON, 0: OFF
	bit 8 - B	Reserved
	bit C	SToF [Safe Torque OFF Hardware] 1: One of Safety input 1 (terminal H1-HC) and Safety input 2 (terminal H2-HC) is OFF (open) and the other is ON (closed).
	bit D	STo [Safe Torque OFF] 1: Both Safety input 1 (terminal H 1 - HC) and Safety input 2 (terminal H2 - HC) are OFF (open)
	bit E	ComRef status 1: Enabled
	bit F	ComCtrl status 1: Enabled
0021	Fault Description 1	
	bit 0	oC [Overcurrent], GF [Ground Fault]
	bit 1	ov [Overvoltage]
	bit 2	oL2 [Drive Overloaded]
	bit 3	oH1 [Heatsink Overheat], oH2 [External Overheat (H1-XX=B)]
	bit 4 - 6	Reserved
	bit 7	EF0 [Option Card External Fault], EF1 to EF7 [External Fault]
	bit 8	CPFxx [Hardware Fault] <b>Note:</b> Includes oFx.
	bit 9	oL1 [Motor Overload], oL3, oL4 [Overtorque Detection 1/2], UL3, UL4 [Undertorque Detection 1/2]
	bit A	oS [Overspeed], dEv [Speed Deviation]
	bit B	During Uv [Undervoltage] detection
	bit C	Uv1 [DC Bus Undervoltage], Uv2 [Control Power Undervoltage], Uv3 [Soft Charge Answerback Fault]
	bit D	LF [Output Phase Loss], PF [Input Phase Loss]
	bit E	CE [Modbus Communication Error], bUS [Option Communication Error]
bit F	oPr [Keypad Connection Fault]	

Register No. (Hex.)	Description	
0022	Fault Contents	
	bit 0	1: During data writing, during motor switching
	bit 1 - 2	Reserved
	bit 3	1: Upper/Lower Limit Fault
	bit 4	1: Data Integrity Fault
	bit 5	1: During EEPROM writing
	bit 6 - F	Reserved
0023	U1-01 [Frequency Reference] <b>Note:</b> o1-03 [Frequency Display Unit Selection] sets the units.	
0024	U1-02 [Output Frequency] <b>Note:</b> o1-03 [Frequency Display Unit Selection] sets the units.	
0025	U1-06 [Output Voltage Ref] (units: 0.1 V) <b>Note:</b> Use H5-10 [Modbus Register 0025H Unit Sel] to change the setting unit.	
0026	U1-03 [Output Current] (units: 0.1 A)	
0027	U1-08 [Output Power]	
0028	U1-09 [Torque Reference]	
0029	Fault Description 2	
	bit 0	Reserved
	bit 1	GF [Ground Fault]
	bit 2	PF [Input Phase Loss]
	bit 3	LF [Output Phase Loss]
	bit 4 - 5	Reserved
	bit 6	oH4 [Motor Overheat Fault (PTC Input)]
bit 7 - F	Reserved	
002A	Minor Fault Description 1	
	bit 0 - 1	Reserved
	bit 2	EF [FWD/REV Run Command Input Error]
	bit 3	bb [Baseblock]
	bit 4	oL3 [Overtorque 1]
	bit 5	oH [Heatsink Overheat]
	bit 6	ov [Overvoltage]
	bit 7	Uv [Undervoltage]
	bit 8	Reserved
	bit 9	CE [Run at H5-34 (CE Go-To-Freq)]
	bit A	bUS [Option Communication Error]
	bit B	UL3/UL4 [Undertorque Detection 1/2]
	bit C	oH3 [Motor Overheat (PTC Input)]
	bit D - E	Reserved
bit F	CALL [Serial Comm Transmission Error]	

## 6.6 MEMOBUS/Modbus Communications

Register No. (Hex.)	Description	
002B	U1-10 [Input Terminal Status]	
	bit 0	1: Control circuit terminal S1 ON
	bit 1	1: Control circuit terminal S2 ON
	bit 2	1: Control circuit terminal S3 ON
	bit 3	1: Control circuit terminal S4 ON
	bit 4	1: Control circuit terminal S5 ON
	bit 5	1: Control circuit terminal S6 ON
	bit 6	1: Control circuit terminal S7 ON
bit 7 - F	Reserved	
002C	Drive Status 2	
	bit 0	During Run 1: During Run
	bit 1	During zero speed 1: During zero speed
	bit 2	Speed agreement 1: During agreement
	bit 3	User-defined speed agreement 1: During agreement
	bit 4	Frequency Detection 1 1: Output frequency $\leq$ L4-01
	bit 5	Frequency Detection 2 1: Output frequency $\geq$ L4-01
	bit 6	Drive ready 1: Run ready
	bit 7	During low voltage detection 1: During detection
	bit 8	During baseblock 1: Drive output during baseblock
	bit 9	Frequency reference mode 1: No communication option, 0: Communication option
	bit A	Run command mode 1: No communication option, 0: Communication option
	bit B	During overtorque/undertorque 1, 2 detection
	bit C	Frequency reference loss 1: Loss
	bit D	Executing Auto-Restart 1: Restart Enabled
	bit E	Faults 1: Fault generated
bit F	MEMOBUS/Modbus communications timeout 1: At Timeout Includes CE Go To Frequency alarm	



Register No. (Hex.)	Description	
002D	U1-11 [Output Terminal Status]	
	bit 0	MFDO (terminal M1-M2) 1: ON, 0: OFF
	bit 1	MFDO (terminal M3-M4) 1: ON, 0: OFF
	bit 2	MFDO (terminal M5-M6) 1: ON, 0: OFF
	bit 3 - 6	Reserved
	bit 7	Fault relay output (terminal MA/MB-MC) 1: ON, 0: OFF
	bit 8 - F	Reserved
002E - 0030	Reserved	
0031	U1-07 [DC Bus Voltage] (unit: 1 V)	
0032	U1-09 [Torque Reference] (unit: 1%)	
0033	Reserved	
0034	Product code 1 [ASCII], product type (HV600 = 0G)	
0035	Product code 2 [ASCII], product type (HV600 = 60)	
0036 - 0037	Reserved	
0038	PID Feedback: Unsigned, input is equivalent to 100%/maximum output frequency (Units: 0.1%)	
0039	PID Input: Signed, $\pm 100\%$ / $\pm$ maximum output frequency (Units: 0.1%)	
003A	PID Output: Signed, $\pm 100\%$ / $\pm$ maximum output frequency (Units: 0.1%)	
003B - 003C	Reserved	
003D	Communications error description <b>Note:</b> The drive saves the description of the communications error until you reset the fault.	
	bit 0	CRC Error
	bit 1	Data Length Error
	bit 2	Reserved
	bit 3	Parity Error
	bit 4	Overrun Error
	bit 5	Framing Error
	bit 6	Timeout
bit 7 - F	Reserved	
003E	Output Frequency	Units: $\text{min}^{-1}$ or r/min <b>Note:</b> Set E2-04, E4-04, E5-04, E9-08 [Motor Pole Count].
003F		0.01% units
0040 - 004A	Used with U1-xx [Operation Status Monitors]. Refer to the U Monitor for parameter details.	

## 6.6 MEMOBUS/Modbus Communications

Register No. (Hex.)	Description	
004B	U1-12 [Drive Status]	
	bit 0	1: During Run
	bit 1	1: During zero speed
	bit 2	1: During reverse
	bit 3	1: During reset signal input
	bit 4	1: During speed agreement
	bit 5	1: Drive operation ready
	bit 6	1: Minor Fault
	bit 7	1: Fault
	bit 8	1: oPExx [Operation Error] generation
	bit 9	1: Recovery from momentary power loss, 0: Power recovery
	bit A	1: Motor 2 Selection
	bit B	Reserved
	bit C	1: AUTO Mode
	bit D	1: HAND Mode
	bit E	1: ComRef status/ NetRef status
bit F	1: ComCtrl status/ NetCtrl status	
004C - 007E	Use with U1-xx, U4-xx, U5-xx, U6-xx [Monitors]. Refer to "U2: Fault Trace" and "U3: Fault History" for more information.	
007F	Minor fault code (Refer to "Minor fault description" for more information about the minor fault codes.)	
0080 - 0097	Use with U2-xx, U3-xx [Monitors]. Refer to "U Monitor" for more information, and refer to "Fault Trace/Fault History Descriptions" for more information about register values.	
0098 - 0099	U4-01 [Cumulative Ope Time] Example: When U4-01 [Cumulative Ope Time] is 12345, 0098 (Hex.) = 1234 and 0099 (Hex.) = 5.	
009A - 009B	U4-03 [Cooling Fan Ope Time] Example: When U4-03 [Cooling Fan Ope Time] is 12345, 009A (Hex.) = 1234 and 009B (Hex.) = 5.	
009C - 00AA	Reserved	
00AB	Drive rated current <b>Note:</b> The unit of display is different for different models. • 0.01 A: 2011 to 2046, 4005 to 4014 • 0.1 A: 2059 to 2273, 4021 to 4302	
00AC	U1-05 [Motor Speed]	Units: min <sup>-1</sup> or r/min <b>Note:</b> Set E9-08 [Motor Pole Count].
00AD		Units: 0.01%
00AE, 00AF	Reserved	
00B0	Option codes connected to CNS	The drive stores option codes in the register. SI-W3 = 1003 (Hex.) SI-EM3 = 1005 (Hex.) SI-EN3 = 1006 (Hex.) SI-EP3 = 1006 (Hex.) JOHB-SMP3 (Modbus TCP/IP) = 1005 (Hex.) JOHB-SMP3 (EtherNet/IP) = 1006 (Hex.) JOHB-SMP3 (PROFINET) = 1006 (Hex.) JOHB-SMP3 (BACnet/IP) = 100C (Hex.)
00B1 - 00B4	Reserved	
00B5	U1-16 [SFS Output Frequency]	Units: min <sup>-1</sup> or r/min <b>Note:</b> Set E2-04, E4-04, E5-04, E9-08 [Motor Pole Count].
00B6		Units: 0.01%

Register No. (Hex.)	Description	
00B7	Frequency reference monitor	Units: min <sup>-1</sup> or r/min <b>Note:</b> Set E2-04, E4-04, E5-04, E9-08 [Motor Pole Count].
00B8		Units: 0.01%
00B9 - 00BE	Reserved	
00BF	Operation error number xx of oPExx is displayed.	
00C0	Fault Description 3	
	bit 0	Reserved
	bit 1	Uv1 [DC Bus Undervoltage]
	bit 2	Uv2 [Control Power Undervoltage]
	bit 3	Uv3 [Soft Charge Answerback Fault]
	bit 4	SC [Short Circuit/IGBT Failure]
	bit 5	GF [Ground Fault]
	bit 6	oC [Overcurrent]
	bit 7	ov [Overvoltage]
	bit 8	oH [Heatsink Overheat]
	bit 9	oH1 [Heatsink Overheat]
	bit A	oL1 [Motor Overload]
	bit B	oL2 [Drive Overloaded]
	bit C	oL3 [Overtorque Detection 1]
	bit D	oL4 [Overtorque Detection 2]
bit E - F	Reserved	
00C1	Fault Description 4	
	bit 0	EF3 [External Fault (Terminal S3)]
	bit 1	EF4 [External Fault (Terminal S4)]
	bit 2	EF5 [External Fault (Terminal S5)]
	bit 3	EF6 [External Fault (Terminal S6)]
	bit 4	EF7 [External Fault (Terminal S7)]
	bit 5 - 6	Reserved
	bit 7	oS [Overspeed]
	bit 8	dEv [Speed Deviation]
	bit 9	Reserved
	bit A	PF [Input Phase Loss]
	bit B	LF [Output Phase Loss]
	bit C	oH3 [Motor Overheat (PTC Input)]
	bit D	oPr [Keypad Connection Fault]
	bit E	Err [EEPROM Write Error]
bit F	oH4 [Motor Overheat Fault (PTC Input)]	

## 6.6 MEMOBUS/Modbus Communications

Register No. (Hex.)	Description	
00C2	Fault Description 5	
	bit 0	CE [Modbus Communication Error]
	bit 1	bUS [Option Communication Error]
	bit 2 - 5	Reserved
	bit 6	EF0 [Option Card External Fault]
	bit 7	Reserved
	bit 8	UL3 [Undertorque Detection 1]
	bit 9	UL4 [Undertorque Detection 2]
	bit A	oL7 [High Slip Braking Overload]
	bit B - E	Reserved
	bit F	Hardware Fault (includes <i>oFx</i> fault)
00C3	Fault Description 6	
	bit 0 - 4	Reserved
	bit 5	LF2 [Output Current Imbalance]
	bit 6	STPo [Motor Step-Out Detected]
	bit 7 - 9	Reserved
	bit A	SEr [Speed Search Retries Exceeded]
	bit B - F	Reserved
00C4	Fault Description 7	
	bit 0	Reserved
	bit 1	EF1 [External Fault (Terminal S1)]
	bit 2	EF2 [External Fault (Terminal S2)]
	bit 3 - 4	Reserved
	bit 5	CoF [Current Offset Fault]
	bit 6 - 7	Reserved
	bit 8	dWFL [DriveWorksEZ Fault]
	bit 9	dWF1 [EEPROM Memory DWEZ Data Error]
	bit A - F	Reserved
00C5	Fault Description 8	
	bit 0	Reserved
	bit 1	nSE [Node Setup Error]
	bit 2 - 9	Reserved
	bit A	dv7 [Polarity Judge Timeout]
	bit B - F	Reserved
00C6 - 00C7	Reserved	

Register No. (Hex.)	Description	
00C8	Minor Fault Description 2	
	bit 0	Uv [Undervoltage]
	bit 1	ov [Overvoltage]
	bit 2	oH [Heatsink Overheat]
	bit 3	Overheat Alarm (oH2)
	bit 4	oL3 [Overtorque 1]
	bit 5	oL4 [Overtorque 2]
	bit 6	EF [FWD/REV Run Command Input Error]
	bit 7	bb [Baseblock]
	bit 8	EF3 [External Fault (Terminal S3)]
	bit 9	EF4 [External Fault (Terminal S4)]
	bit A	EF5 [External Fault (Terminal S5)]
	bit B	EF6 [External Fault (Terminal S6)]
	bit C	EF7 [External Fault (Terminal S7)]
	bit D - E	Reserved
bit F	oS [Overspeed]	
00C9	Minor Fault Description 3	
	bit 0	dEv [Speed Deviation]
	bit 1	Reserved
	bit 2	oPr [Keypad Connection Fault]
	bit 3	CE [Run at H5-34 (CE Go-To-Freq)]
	bit 4	bUS [Option Communication Error]
	bit 5	CALL [Serial Comm Transmission Error]
	bit 6	oL1 [Motor Overload]
	bit 7	oL2 [Drive Overloaded]
	bit 8	Reserved
	bit 9	EF0 [Option Card External Fault]
	bit A	rUn [Motor Switch during Run]
	bit B	Reserved
	bit C	CALL [Serial Comm Transmission Error]
	bit D	UL3 [Undertorque Detection 1]
bit E	UL4 [Undertorque Detection 2]	
bit F	SE [Modbus Test Mode Error]	
00CA	Minor Fault Description 4	
	bit 0	L24v [Loss of External Power 24 Supply]
	bit 1	oH3 [Motor Overheat (PTC Input)]
	bit 2 - 7	Reserved
	bit 8	CyPo [Cycle Power to Accept Changes]
	bit 9	dnE [Drive Disabled]
bit A - F	Reserved	

## 6.6 MEMOBUS/Modbus Communications

Register No. (Hex.)	Description	
00CB	Minor Fault Description 5	
	bit 0 - 2	Reserved
	bit 3	HCA [High Current Alarm]
	bit 4	LT-1 [Cooling Fan Maintenance Time]
	bit 5	LT-2 [Capacitor Maintenance Time]
	bit 6 - 7	Reserved
	bit 8	EF1 [External Fault (Terminal S1)]
	bit 9	EF2 [External Fault (Terminal S2)]
	bit A	SToF [Safe Torque OFF Hardware]
	bit B - F	Reserved
	00CC	Minor Fault Description 6
bit 0		Reserved
bit 1		TrPC [IGBT Maintenance Time (90%)]
bit 2		LT-3 [SoftChargeBypassRelay MainteTime]
bit 3		LT-4 [IGBT Maintenance Time (50%)]
bit 4 - 7		Reserved
bit 8		dWAL [DriveWorksEZ Fault]
bit 9 - E		Reserved
bit F	AFBL [Analog Fbk Lost, Switched to Net]	
00CD - 00CF	Reserved	
00D0	CPF Contents 1	
	bit 0 - 1	Reserved
	bit 2	CPF02 [Control Circuit Error]
	bit 3	CPF03 [Control Circuit Error]
	bit 4 - 5	Reserved
	bit 6	CPF06 [Control Circuit Error]
	bit 7	CPF07 [Control Circuit Error]
	bit 8	CPF08 [Control Circuit Error]
	bit 9 - A	Reserved
	bit B	CPF11 [Control Circuit Error]
	bit C	CPF12 [Control Circuit Error]
	bit D	CPF13 [Control Circuit Error]
	bit E	CPF14 [Control Circuit Error]
	bit F	Reserved

Register No. (Hex.)	Description	
00D1	CPF Contents 2	
	bit 0	CPF16 [Control Circuit Error]
	bit 1	CPF17 [Control Circuit Error]
	bit 2	CPF18 [Control Circuit Error]
	bit 3	CPF19 [Control Circuit Error]
	bit 4	CPF20 [Control Circuit Error]
	bit 5	CPF21 [Control Circuit Error]
	bit 6	CPF22 [Control Circuit Error]
	bit 7	CPF23 [Control Circuit Error]
	bit 8	CPF24 [Control Circuit Error]
	bit 9	Reserved
	bit A	CPF26 [Control Circuit Error]
	bit B	CPF27 [Control Circuit Error]
	bit C	CPF28 [Control Circuit Error]
	bit D	CPF29 [Control Circuit Error]
bit E	CPF30 [Control Circuit Error]	
bit F	CPF31 [Control Circuit Error]	
00D2	CPF Contents 3	
	bit 0	CPF32 [Control Circuit Error]
	bit 1	CPF33 [Control Circuit Error]
	bit 2	CPF34 [Control Circuit Error]
	bit 3	CPF35 [Control Circuit Error]
	bit 4	CPF36 [Control Circuit Error]
	bit 5	CPF37 [Control Circuit Error]
	bit 6	CPF38 [Control Circuit Error]
	bit 7	CPF39 [Control Circuit Error]
bit 8 - F	Reserved	
00D3 - 00D7	Reserved	
00D8	oFA0x Description (CN5)	
	bit 0	oFA00 [Option Not Compatible with Port]
	bit 1	oFA01 [Option Fault/Connection Error]
	bit 2 - 4	Reserved
	bit 5	oFA05 [Option A/D Error]
	bit 6	oFA06 [Option Communication Error]
	bit 7 - F	Reserved

## 6.6 MEMOBUS/Modbus Communications

Register No. (Hex.)	Description	
00D9	oFA1x Description (CN5)	
	bit 0	oFA10 [Option RAM Error]
	bit 1	oFA11 [Option Ope Mode Error]
	bit 2	oFA12 [Drive Receive CRC Error]
	bit 3	oFA13 [Drive Receive Frame Error]
	bit 4	oFA14 [Drive Receive Abort Error]
	bit 5	oFA15 [Option Receive CRC Error]
	bit 6	oFA16 [Option Receive Frame Error]
	bit 7	oFA17 [Option Receive Abort Error]
	bit 8 - F	Reserved
00DA	Reserved	
00DB	oFA3x Description (CN5)	
	bit 0	oFA30 [COM ID Error]
	bit 1	oFA31 [Type Code Error]
	bit 2	oFA32 [SUM Check Error]
	bit 3	oFA33 [Option Receive Time Over]
	bit 4	oFA34 [Memobus Time Over]
	bit 5	oFA35 [Drive Timeout Waiting for Response]
	bit 6	oFA36 [CI Check Error]
	bit 7	oFA37 [Drive Timeout Waiting for Response]
	bit 8	oFA38 [Control Reference Error]
	bit 9	oFA39 [Drive Timeout Waiting for Response]
	bit A	oFA40 [CtrlResSel 1Err]
	bit B	oFA41 [Drive Timeout Waiting for Response]
	bit C	oFA42 [CtrlResSel 2Err]
	bit D	oFA43 [Drive Timeout Waiting for Response]
	bit E - F	Reserved
00DC - 00E4	Reserved	
00E5	Minor Fault Description 9	
	bit 0	EP24v [External Power 24V Supply]
	bit 1 - 3	Reserved
	bit 4	bAT [Keypad Battery Low Voltage]
	bit 5 - 7	Reserved
	bit 8	TiM [Keypad Time Not Set]
	bit 9	bCE [Bluetooth Communication Error]
	bit A - E	Reserved
	bit F	Bu-Fb [Main Fdbk Lost Using Backup Fdbk]
00E6 - 00E9	Reserved	



Register No. (Hex.)	Description	
00EA	Fault Description 11	
	bit 0	TiM [Keypad Time Not Set]
	bit 1	bAT [Keypad Battery Low Voltage]
	bit 2 - 3	Reserved
	bit 4	ov2 [DC Bus Overvoltage 2]
	bit 5 - D	Reserved
	bit E	SCF [Safety Circuit Fault]
	bit F	Reserved
00EB - 00ED	Reserved	
00EE	Fault Description 12	
	bit 0 - 4	Reserved
	bit 5	bCE [Bluetooth Communication Fault]
	bit 6 - E	Reserved
bit F	AUXFB [PI Aux Feedback Level Loss]	
00EF - 00FA	Reserved	
00FB	Output Current <b>Note:</b> The unit of display is different for different models. • 0.01 A: 2011 to 2046, 4005 to 4014 • 0.1 A: 2059 to 2273, 4021 to 4302	

## ■ Broadcast Messages

Broadcast messages are available as read-only.

The undefined bit signal in the broadcast operation signal uses the local data signal.

**Table 6.34 Broadcast Messages for MEMOBUS/Modbus Communication**

Register No. (Hex.)	Description	
0001	Operation signal	
	bit 0	Run command 1: Run, 0: Stop
	bit 1	Reverse run command 1: Reverse, 0: Forward run
	bit 2 - 3	Reserved
	bit 4	External fault 1: EF0 [Option Card External Fault]
	bit 5	Fault Reset 1: Reset command
	bit 6 - B	Reserved
	bit C	MFDI terminal S5 input
	bit D	MFDI terminal S6 input
	bit E	MFDI terminal S7 input
	bit F	Reserved
0002	Frequency reference	30000/100%

## ■ Fault Trace/Fault History Contents

Table 6.35 lists the fault codes that the commands from monitors [U2-xx, U3-xx] read.

**Table 6.35 Fault Trace/Fault History Contents**

Fault Code (Hex.)	Name	Fault Code (Hex.)	Name
0002	Uv1 [DC Bus Undervoltage]	0046	CoF [Current Offset Fault]
0003	Uv2 [Control Power Undervoltage]	0047	PE1 [PLC Fault 1]
0004	Uv3 [Soft Charge Answerback Fault]	0048	PE2 [PLC Fault 2]
0005	SC [Short Circuit/IGBT Failure]	0049	dWFL [DriveWorksEZ Fault]
0006	GF [Ground Fault]	004A	dWF1 [EEPROM Memory DWEZ Data Error]
0007	oC [Overcurrent]	004B	dWF2 [DriveWorksEZ Fault 2]
0008	ov [Overvoltage]	004C	dWF3 [DriveWorksEZ Fault 3]
0009	oH [Heatsink Overheat]	0052	nSE [Node Setup Error]
000A	oH1 [Heatsink Overheat]	005A	UL6 [Underload or Belt Break Detected]
000B	oL1 [Motor Overload]	005B	dv7 [Polarity Judge Timeout]
000C	oL2 [Drive Overloaded]	0083, 0084 0087 - 0089 008C - 008F 0091 - 0099 009B - 00A8	CPF02 - CPF39 [Control Circuit Error]
000D	oL3 [Overtorque Detection 1]	0101	oFA00 [Option Not Compatible with Port]
000E	oL4 [Overtorque Detection 2]	0102, 0106, 0107 0111 - 0118 0131 - 013E	oFA01 - oFA43 [Option Fault/Connection Error]
0011	EF3 [External Fault (Terminal S3)]	0401	TiM [Keypad Time Not Set]
0012	EF4 [External Fault (Terminal S4)]	0402	bAT [Keypad Battery Low Voltage]
0013	EF5 [External Fault (Terminal S5)]	0405	ov2 [DC Bus Overvoltage 2]
0014	EF6 [External Fault (Terminal S6)]	040F	SCF [Safety Circuit Fault]
0015	EF7 [External Fault (Terminal S7)]	0411	HLCE [High Level Communication Errors]
0018	oS [Overspeed]	0413	FAn1 [Drive Cooling Fan Failure]
0019	dEv [Speed Deviation]	0416	bCE [Bluetooth Communication Fault]
001B	PF [Input Phase Loss]	0420	AUXFB [PI Aux Feedback Level Loss]
001C	LF [Output Phase Loss]	0421	DIFF [Differential Feedback Exceeded]
001D	oH3 [Motor Overheat (PTC Input)]	0422	FDBKL [WIRE Break]
001E	oPr [Keypad Connection Fault]	0423	HFB [High Feedback Sensed]
001F	Err [EEPROM Write Error]	0424	HIAUX [High PI Aux Feedback Level]
0020	oH4 [Motor Overheat Fault (PTC Input)]	0425	LFB [Low Feedback Sensed]
0021	CE [Modbus Communication Error]	0426	LOAUX [Low PI Aux Feedback Level]
0022	bUS [Option Communication Error]	0427	LOP [Loss of Prime]
0027	EF0 [Option Card External Fault]	0428	MSL [Net Master Lost]
0029	UL3 [Undertorque Detection 1]	0429	NMS [Setpoint Not Met]
002A	UL4 [Undertorque Detection 2]	042A	OD [Output Disconnect]
002B	oL7 [High Slip Braking Overload]	042B	VLTS [Thermostat Fault]
0030	Includes oFx Fault [Hardware Fault]		
0036	LF2 [Output Current Imbalance]		
0037	STPo [Motor Step-Out Detected]		
003B	SEr [Speed Search Retries Exceeded]		
0042	EF1 [External Fault (Terminal S1)]		
0043	EF2 [External Fault (Terminal S2)]		

■ **Minor Fault/Alarm Contents**

Table 6.36 lists the minor fault/alarm codes that communications register (007F (Hex.)) reads.

Table 6.36 Minor Fault/Alarm Contents (007 (Hex.))

Minor Fault/Alarm Code (Hex.)	Name	Minor Fault/Alarm Code (Hex.)	Name
0001	Uv [Undervoltage]	0044	LT-4 [IGBT Maintenance Time (50%)]
0002	ov [Overvoltage]	0049	dWAL [DriveWorksEZ Alarm]
0003	oH [Heatsink Overheat]	004A	dWA2 [DriveWorksEZ Alarm 2]
0004	oH2 [External Overheat (H1-XX=B)]	004B	dWA3 [DriveWorksEZ Alarm 3]
0005	oL3 [Overtorque 1]	004E	UL6 [Underload or Belt Break Detected]
0006	oL4 [Overtorque 2]	0062	SAFE [Customer Safeties]
0007	EF [FWD/REV Run Command Input Error]	0067	EOF [Emergency Override FWD]
0008	bb [Baseblock]	0068	EOR [Emergency Override REV]
0009	EF3 [External Fault (Terminal S3)]	0069	INTLK [BAS Interlock]
000A	EF4 [External Fault (Terminal S4)]	0081	EP24v [External Power 24V Supply]
000B	EF5 [External Fault (Terminal S5)]	0085	bAT [Keypad Battery Low Voltage]
000C	EF6 [External Fault (Terminal S6)]	0089	TiM [Keypad Time Not Set]
000D	EF7 [External Fault (Terminal S7)]	008A	bCE [Bluetooth Communication Error]
0010	oS [Overspeed]	0090	Bu-Fb [Main Fdbk Lost Using Backup Fdbk]
0011	dEv [Speed Deviation]	0091	BuFbl [Backup Fdbk Lost Chk/Repl Xducer]
0014	CE [Modbus Communication Error]	0092	CE [Run at H5-34 (CE Go-To-Freq)]
0015	bUS [Option Communication Error]	0093	DIFF [Differential Feedback Exceeded]
0016	CALL [Serial Comm Transmission Error]	0094	FDBKL [Feedback Loss Wire Break]
0017	oL1 [Motor Overload]	0095	FLGT [Feedback Loss, Go To Freq b5-83]
0018	oL2 [Drive Overloaded]	0096	HIAUX [High PI Aux Feedback Level]
001A	EF0 [Option Card External Fault]	0097	HIFB [High Feedback Sensed]
001B	rUn [Motor Switch during Run]	0099	LOAUX [Low PI Aux Feedback Level]
001D	CALL [Serial Comm Transmission Error]	009A	LOFB [Low Feedback Sensed]
001E	UL3 [Undertorque Detection 1]	009B	LOP [Loss of Prime]
001F	UL4 [Undertorque Detection 2]	009C	NMS [Setpoint Not Met]
0020	SE [Modbus Test Mode Error]	009D	OD [Output Disconnect]
0021	L24v [Loss of External Power 24 Supply]	009E	FR<MS [Freq Ref < Minimum Speed (Y1-06)]
0022	oH3 [Motor Overheat (PTC Input)]	009F	FR<TH [Freq. Reference < Thrust (Y4-12)]
002A	dnE [Drive Disabled]	00A1	NETSC [NETSCAN Waiting for Master]
0034	HCA [High Current Alarm]	00A2	AFBL [Analog Fbk Lost, Switched to Net]
0035	LT-1 [Cooling Fan Maintenance Time]	00A3	AuDis [Low PI Aux Fdbk Drive Disabled]
0036	LT-2 [Capacitor Maintenance Time]	00A4	AUXFB [PI Aux Feedback Level Loss]
0039	EF1 [External Fault (Terminal S1)]	00A5	AuFbl [PI Aux Fdbk Lost Switched to Net]
003A	EF2 [External Fault (Terminal S2)]	00A6	BuDif [Main Fdbk Lost, Using Diff Fdbk]
003B	SToF [Safe Torque OFF Hardware]	00A7	LCP [Low City Pressure]
0042	TrPC [IGBT Maintenance Time (90%)]	00A8	LSP [Low Suction Pressure]
0043	LT-3 [SoftChargeBypassRelay MainteTime]	00A9	LWT [Low Water In Tank]

## ◆ Error Codes

### ■ MEMOBUS/Modbus Communications Error Code List

Table 6.37 lists the MEMOBUS/Modbus communications error codes.

When an error occurs, remove the cause of the error and restart communications.

**Table 6.37 MEMOBUS/Modbus Communications Error Codes**

Error Code (Hex.)	Name	Cause
01	Function Code Error	The PLC set a function code that was not 03, 08, or 10 (Hex.)
02	Register Number Error	<ul style="list-style-type: none"> <li>The register number that is trying to access is not registered.</li> <li>A starting number that was not 0001 or 0002 (Hex.) was set when broadcasting.</li> </ul>
03	Bit Count Error	<ul style="list-style-type: none"> <li>Read and write data quantities are more than the 1 to 16 range. (Command message data quantity is disabled.)</li> <li>The data that was read from non-consecutive holding registers contained more than 120 bytes.</li> <li>The data to be written to non-consecutive holding registers contained more than 60 bytes.</li> <li>In the write mode, the number of bytes in the message is not the number of data × 2.</li> </ul>
21	Data Setting Error	<ul style="list-style-type: none"> <li>Writing control data or parameters made the settings go out of the permitted setting range.</li> <li>A parameter setting error occurred when writing a parameter.</li> </ul>
22	Write Mode Error	<ul style="list-style-type: none"> <li>Tried to write a disabled parameter during run.</li> <li>When there was a <i>CPF06 [Control Circuit Error]</i>, the master tried to write a parameter other than one of these: <ul style="list-style-type: none"> <li><i>A1-00 [Language Selection]</i></li> <li><i>A1-01 [Access Level Selection]</i></li> <li><i>A1-02 [Control Method Selection]</i></li> <li><i>A1-03 [Initialize Parameters]</i></li> <li><i>A1-04 [Password]</i></li> <li><i>A1-05 [Password Setting]</i></li> <li><i>E1-03 [V/f Pattern Selection]</i></li> <li><i>o2-04 [Drive Model (KVA) Selection]</i></li> </ul> </li> <li>Writes the read-only data.</li> </ul>
23	DC Bus Undervoltage Write Error	During <i>Uv [DC Bus Undervoltage]</i> , a <i>Uv</i> write disabled parameter was written.
24	Error Writing Data During Parameter Processing	Tried to write a parameter from the master during parameter processing on the drive side.
25	Writing into EEPROM Disabled	Writing into EEPROM write is disabled, but EEPROM write was executed from MEMOBUS/Modbus communications. When this error occurs, the keypad shows a message and the drive continues operation.

### ■ No Response from Slave

The slave ignores the command message from the master and will not send a response message in these conditions:

- When a communications error (overflow, framing, parity, CRC-16) is detected in the command message.
- When the slave address in the command message and the slave address for the drive side do not agree (Use *H5-01 [Drive Node Address]* to set the slave address of the drive)
- When the time interval between the data of which the message is composed is longer than 24 bits
- When the data length for the command message is not accurate

#### Note:

- If the keypad shows *CALL [Serial Comm Transmission Error]*, refer to “Troubleshooting” to remove the cause of the error, and try to do communications again. If the keypad does not show *CALL*, check *U1-19 [MEMOBUS/Modbus Error Code]* for the error and error type.
- If you execute the write function code when the slave address in the command message is 00 (Hex.), all of the slaves will execute the write command, but they will not send response messages to the master.

# Troubleshooting

---

7.1	Section Safety .....	312
7.2	Types of Faults, Minor Faults, Alarms, and Errors .....	314
7.3	List of Fault, Minor Fault, Alarm, and Error Codes .....	315
7.4	Fault .....	322
7.5	Minor Faults/Alarms .....	345
7.6	Parameter Setting Errors.....	358
7.7	Auto-Tuning Errors .....	363
7.8	Backup Function Operating Mode Display and Errors.....	366
7.9	Diagnosing and Resetting Faults .....	368
7.10	Troubleshooting Without Fault Display.....	370

## 7.1 Section Safety

### DANGER

#### Electrical Shock Hazard

**Do not examine, connect, or disconnect wiring on an energized drive. Before servicing, disconnect all power to the equipment and wait for the time specified on the warning label at a minimum. The internal capacitor stays charged after the drive is de-energized. The charge indicator LED extinguishes when the DC bus voltage decreases below 50 Vdc. When all indicators are OFF, remove the covers before measuring for dangerous voltages to make sure that the drive is safe.**

If you do work on the drive when it is energized, it will cause serious injury or death from electrical shock.

### WARNING

#### Electrical Shock Hazard

**Do not operate the drive when covers are missing. Replace covers and shields before you operate the drive. Use the drive only as specified by the instructions.**

Some figures in this section include drives without covers or safety shields to more clearly show the inside of the drive. If covers or safety shields are missing from the drive, it can cause serious injury or death.

**Always ground the motor-side grounding terminal.**

If you do not ground the equipment correctly, it can cause serious injury or death if you touch the motor case.

**After the drive blows a fuse or trips a GFCI, do not immediately energize the drive or operate peripheral devices. Wait for the time specified on the warning label at a minimum and make sure that all indicators are OFF. Then check the wiring and peripheral device ratings to find the cause of the problem. If you do not know the cause of the problem, contact Yaskawa before you energize the drive or peripheral devices.**

If you do not fix the problem before you operate the drive or peripheral devices, it can cause serious injury or death.

**Only let approved personnel install, wire, maintain, examine, replace parts, and repair the drive.**

If personnel are not approved, it can cause serious injury or death.

**Do not wear loose clothing or jewelry when you do work on the drive. Tighten loose clothing and remove all metal objects, for example watches or rings.**

Loose clothing can catch on the drive and jewelry can conduct electricity and cause serious injury or death.

**Do not remove covers or touch circuit boards while the drive is energized.**

If you touch the internal components of an energized drive, it can cause serious injury or death.

**Do not modify the drive body or drive circuitry.**

Modifications to drive body and circuitry can cause serious injury or death, will cause damage to the drive, and will void the warranty. Yaskawa is not responsible for modifications of the product made by the user.

#### Fire Hazard

**Tighten all terminal screws to the correct tightening torque.**

Connections that are too loose or too tight can cause incorrect operation and damage to the drive. Incorrect connections can also cause death or serious injury from fire.

**Tighten screws at an angle in the specified range shown in this manual.**

If you tighten the screws at an angle not in the specified range, you can have loose connections that can cause damage to the terminal block or start a fire and cause serious injury or death.

#### Damage to Equipment

**Do not apply incorrect voltage to the main circuit of the drive. Operate the drive in the specified range of the input voltage on the drive nameplate.**

Voltages that are higher than the permitted nameplate tolerance can cause damage to the drive.

**⚠ WARNING****Fire Hazard**

**Do not put flammable or combustible materials on top of the drive and do not install the drive near flammable or combustible materials. Attach the drive to metal or other noncombustible material.**

Flammable and combustible materials can start a fire and cause serious injury or death.

**Crush Hazard**

**Wear eye protection when you do work on the drive.**

If you do not use correct safety equipment, it can cause serious injury or death.

**Use a crane or hoist to move large drives when necessary.**

If you try to move a large drive without a crane or hoist, it can cause serious injury or death.

**NOTICE****Damage to Equipment**

**When you touch the drive and circuit boards, make sure that you observe correct electrostatic discharge (ESD) procedures.**

If you do not follow procedures, it can cause ESD damage to the drive circuitry.

**Do not break the electrical connection between the drive and the motor when the drive is outputting voltage.**

Incorrect equipment sequencing can cause damage to the drive.

**Make sure that all connections are correct after you install the drive and connect peripheral devices.**

Incorrect connections can cause damage to the drive.

**Note:**

Do not use unshielded wire for control wiring. Use shielded, twisted-pair wires and ground the shield to the ground terminal of the drive. Unshielded wire can cause electrical interference and unsatisfactory system performance.

## 7.2 Types of Faults, Minor Faults, Alarms, and Errors

If the drive or motor do not operate correctly, check the drive keypad for a code or message.



If problems occur that are not identified in this manual, contact the nearest Yaskawa representative with this information:

- Drive model
- Drive software version
- Date of purchase
- Description of the problem (such as failure conditions)

Table 7.1 contains descriptions of the different types of faults, minor faults, alarms, and errors that can occur during drive operation.

Contact Yaskawa if there is damage to the drive. Contact information is on the back cover of the manual.

**Table 7.1 Types of Faults, Minor Faults, Alarms, and Errors**

Type	Drive Response
Faults	<p>When the drive detects a fault, it will cause these conditions:</p> <ul style="list-style-type: none"> <li>• The keypad shows the fault code and  and ALM/ERR of the LED Status Ring illuminate continuously.</li> <li>• The keypad shows the fault code and  and ALM/ERR on the LED Status Ring illuminate continuously when <math>o2-24 = 0</math> or <math>1</math> [<i>LED Light Function Selection = Enable Status Ring &amp; Keypad LED or LED Status Ring Disable</i>].</li> <li>• The drive shuts off output, and the motor coasts to a stop. Some faults let the user select a motor stopping method.</li> <li>• Fault relay output MA-MC will turn ON, and MB-MC will turn OFF.</li> </ul> <p>The drive will not operate until you clear the fault with a Fault Reset and the drive goes back to usual status.</p>
Minor Faults/Alarms	<p>When the drive detects a minor fault or an alarm, it will cause these conditions:</p> <ul style="list-style-type: none"> <li>• The keypad shows the alarm code and  and ALM/ERR on the LED Status Ring flash when <math>o2-24 = 0</math> or <math>1</math>.</li> <li>• The drive will continue to operate the motor. Some alarms let the user select a motor stopping method.</li> <li>• If the drive detects a minor fault, the terminal set to <math>H2-01</math> to <math>H2-03 = 10</math> [<i>MFDO Function Select = Alarm</i>] will switch ON. If you do not set parameters <math>H2-01</math> to <math>H2-03</math>, the drive will not trigger MFDO terminals when it detects a minor fault.</li> <li>• The drive will not output a minor fault signal when it detects an alarm.</li> </ul> <p>It is not necessary to do Fault Reset.</p>
Operation Errors	<p>An error occurs when parameter settings do not agree or a parameter combination is incorrect. The drive will not operate until you set the parameters correctly.</p> <p>When the drive detects an operation error, these conditions will result:</p> <ul style="list-style-type: none"> <li>• The keypad shows the error code.</li> <li>• Multi-function outputs do not output an alarm signal.</li> </ul> <p>Find the parameters that caused the error and correct the settings.</p>
Auto-Tuning Errors	<p>An error occurs during Auto-Tuning.</p> <p>When the drive detects a tuning error, it will cause these conditions:</p> <ul style="list-style-type: none"> <li>• The keypad shows the error code.</li> <li>• Multi-function outputs do not output an alarm signal.</li> <li>• The motor coasts to stop.</li> </ul> <p>Remove the cause of the error and do Auto-Tuning again.</p>
Copy Function Errors	<p>An error occurs when you use the keypad for a backup, restore, or verify operation.</p> <p>When the drive detects a copy function error, it will cause these conditions:</p> <ul style="list-style-type: none"> <li>• The keypad shows the error code.</li> <li>• Multi-function outputs do not output an alarm signal.</li> </ul> <p>Push a key on the keypad to clear the error. Remove the cause of the error and try the backup, restore, or verify operation again.</p>

**Note:**

If there is no information on the display when you energize the keypad, there can be a connection error. Remove the keypad and connect it again to make sure that you correctly connected the cable between the drive and the keypad.



## 7.3 List of Fault, Minor Fault, Alarm, and Error Codes

Table 7.2 shows the possible fault, minor fault, alarm, and error codes.

The display codes are in alphabetical order. Search the table for the code shown on the keypad, and identify its causes and possible solutions.

**Note:**

The number in parentheses adjacent to the code in the table identifies the fault code or minor fault code (hex. number) that was read during MEMOBUS/Modbus communications.

Example: AFBL (00A2)

**Table 7.2 List of Fault, Minor Fault, Alarm, and Error Codes**

Display (Hex.)	Name	ALM LED	Type	Ref.
AFBL (00A2)	Analog Fbk Lost, Switched to Net	Flashing	Alarm	345
AuDis (00A3)	Low PI Aux Fdbk Drive Disabled	Flashing	Alarm	345
AuFbl (00A5)	PI Aux Fdbk Lost Switched to Net	Flashing	Alarm	345
AUXFB (00A4)	PI Aux Feedback Level Loss	Flashing	Alarm	345
AUXFB (0420)	PI Aux Feedback Level Loss	Illuminated	Fault	322
bAT (0085)	Keypad Battery Low Voltage	Flashing	Alarm	345
bAT (0402)	Keypad Battery Low Voltage	Illuminated	Fault	322
bb (0008)	Baseblock	Flashing	Alarm	345
bCE (008A)	Bluetooth Communication Error	Flashing	Alarm	345
bCE (0416)	Bluetooth Communication Fault	Illuminated	Fault	322
BuDif (00A6)	Main Fdbk Lost, Using Diff Fdbk	Flashing	Alarm	346
Bu-Fb (0090)	Main Fdbk Lost Using Backup Fdbk	Flashing	Alarm	346
BuFbl (0091)	Backup Fdbk Lost Chk/Repl Xducer	Flashing	Alarm	346
bUS (0015)	Option Communication Error	Flashing	Alarm	346
bUS (0022)	Option Communication Error	Illuminated	Fault	322
bUSy	Busy	-	Not an alarm.	346
CALL (001D)	Serial Comm Transmission Error	Flashing	Alarm	346
CE (0092)	Run at H5-34 (CE Go-To-Freq)	Flashing	Alarm	347
CE (0014)	Modbus Communication Error	Flashing	Alarm	347
CE (0021)	Modbus Communication Error	Illuminated	Fault	322
CoF (0046)	Current Offset Fault	Illuminated	Fault	323
CPEr	Control Mode Mismatch	-	Backup Function Runtime Error	366
CPF00 (0081)	Control Circuit Error	Illuminated	Fault	323
CPF01 (0082)	Control Circuit Error	Illuminated	Fault	323
CPF02 (0083)	A/D Conversion Error	Illuminated	Fault	323
CPF03 (0084)	Control Board Connection Error	Illuminated	Fault	323
CPF06 (0087)	EEPROM Memory Data Error	Illuminated	Fault	324
CPF07 (0088)	Terminal Board Connection Error	Illuminated	Fault	324
CPF08 (0089)	Terminal Board Connection Error	Illuminated	Fault	324
CPF11 (008C)	RAM Fault	Illuminated	Fault	324
CPF12 (008D)	FLASH Memory Fault	Illuminated	Fault	324
CPF13 (008E)	Watchdog Circuit Exception	Illuminated	Fault	324
CPF14 (008F)	Control Circuit Fault	Illuminated	Fault	324
CPF16 (0091)	Clock Fault	Illuminated	Fault	325

## 7.3 List of Fault, Minor Fault, Alarm, and Error Codes

Display (Hex.)	Name	ALM LED	Type	Ref.
CPF17 (0092)	Timing Fault	Illuminated	Fault	325
CPF18 (0093)	Control Circuit Fault	Illuminated	Fault	325
CPF19 (0094)	Control Circuit Fault	Illuminated	Fault	325
CPF20 (0095)	Control Circuit Error	Illuminated	Fault	325
CPF21 (0096)	Control Circuit Error	Illuminated	Fault	325
CPF22 (0097)	Hybrid IC Error	Illuminated	Fault	325
CPF23 (0098)	Control Board Connection Error	Illuminated	Fault	325
CPF24 (0099)	Drive Unit Signal Fault	Illuminated	Fault	326
CPF26 (009B)	BB Circuit Error	Illuminated	Fault	326
CPF27 (009C)	PWM Set Reg Error	Illuminated	Fault	326
CPF28 (009D)	PWM Pattern Error	Illuminated	Fault	326
CPF29 (009E)	On-Delay Error	Illuminated	Fault	326
CPF30 (009F)	BB On Error	Illuminated	Fault	326
CPF31 (00A0)	ASIC Code Error	Illuminated	Fault	326
CPF32 (00A1)	ASIC Startup Error	Illuminated	Fault	326
CPF33 (00A2)	Watch-dog Error	Illuminated	Fault	327
CPF34 (00A3)	Power/Clock Error	Illuminated	Fault	327
CPF35 (00A4)	Ext A/D Conv Error	Illuminated	Fault	327
CPF36 (00A5)	ASIC COM Error	Illuminated	Fault	327
CPF37 (00A6)	ASIC COM Error	Illuminated	Fault	327
CPF38 (00A7)	EEPROM Data Error	Illuminated	Fault	327
CPF39 (00A8)	CPU-ASIC Communication Error	Illuminated	Fault	327
CPyE	Error Writing Data	-	Backup Function Runtime Error	366
CrST	Cannot Reset	Flashing	Not an alarm.	348
CSEr	Control Mode Mismatch	-	Backup Function Runtime Error	366
CyPo (0029)	Cycle Power to Accept Changes	Flashing	Alarm	348
dEv (0011)	Speed Deviation	Flashing	Alarm	348
dEv (0019)	Speed Deviation	Illuminated	Fault	327
dFPS	Drive Model Mismatch	-	Backup Function Runtime Error	366
DIFF (0093)	Differential Feedback Exceeded	Flashing	Alarm	348
DIFF (0421)	Differential Feedback Exceeded	Illuminated	Fault	328
dnE (002A)	Drive Disabled	Flashing	Alarm	348
dv7 (005B)	Polarity Judge Timeout	Illuminated	Fault	328
dWA2 (004A)	DriveWorksEZ Alarm 2	Flashing	Alarm	348
dWA3 (004B)	DriveWorksEZ Alarm 3	Flashing	Alarm	348
dWAL (0049)	DriveWorksEZ Alarm	Flashing	Alarm	348
dWF1 (004A)	EEPROM Memory DWEZ Data Error	Illuminated	Fault	328
dWF2 (004B)	DriveWorksEZ Fault 2	Illuminated	Fault	328
dWF3 (004C)	DriveWorksEZ Fault 3	Illuminated	Fault	328
dWFL (0049)	DriveWorksEZ Fault	Illuminated	Fault	328
EF (0007)	FWD/REV Run Command Input Error	Flashing	Alarm	349
EF0 (001A)	Option Card External Fault	Flashing	Alarm	349
EF0 (0027)	Option Card External Fault	Illuminated	Fault	328

## 7.3 List of Fault, Minor Fault, Alarm, and Error Codes

Display (Hex.)	Name	ALM LED	Type	Ref.
EF1 (0039)	External Fault (Terminal S1)	Flashing	Alarm	349
EF1 (0042)	External Fault (Terminal S1)	Illuminated	Faults	328
EF2 (003A)	External Fault (Terminal S2)	Flashing	Alarm	349
EF2 (0043)	External Fault (Terminal S2)	Illuminated	Faults	329
EF3 (0009)	External Fault (Terminal S3)	Flashing	Alarm	349
EF3 (0011)	External Fault (Terminal S3)	Illuminated	Faults	329
EF4 (000A)	External Fault (Terminal S4)	Flashing	Alarm	349
EF4 (0012)	External Fault (Terminal S4)	Illuminated	Faults	329
EF5 (000B)	External Fault (Terminal S5)	Flashing	Alarm	349
EF5 (0013)	External Fault (Terminal S5)	Illuminated	Faults	329
EF6 (000C)	External Fault (Terminal S6)	Flashing	Alarm	349
EF6 (0014)	External Fault (Terminal S6)	Illuminated	Faults	329
EF7 (000D)	External Fault (Terminal S7)	Flashing	Alarm	350
EF7 (0015)	External Fault (Terminal S7)	Illuminated	Faults	329
End1	Excessive Rated Voltage Setting	Flashing	An Auto-Tuning Error	363
End2	Iron Core Saturation Coefficient	Flashing	An Auto-Tuning Error	363
End3	Rated Current Setting Alarm	Flashing	An Auto-Tuning Error	363
End4	Adjusted Slip Calculation Error	Flashing	An Auto-Tuning Error	363
End5	Resistance Tuning Error	Flashing	An Auto-Tuning Error	363
End6	Leakage Inductance Alarm	Flashing	An Auto-Tuning Error	363
End7	No-Load Current Alarm	Flashing	An Auto-Tuning Error	363
End8	HFI Alarm	Flashing	An Auto-Tuning Error	363
End9	Initial Pole Detection Alarm	Flashing	An Auto-Tuning Error	364
EOF (0067)	Emergency Override FWD	Flashing	Alarm	350
EOR (0068)	Emergency Override REV	Flashing	Alarm	350
EP24v (0081)	External Power 24V Supply	Flashing	Alarm	350
Er-01	Motor Data Error	Flashing	An Auto-Tuning Error	364
Er-02	Drive in an Alarm State	Flashing	An Auto-Tuning Error	364
Er-03	OFF Button was Pressed	Flashing	An Auto-Tuning Error	364
Er-04	Line-to-Line Resistance Error	Flashing	An Auto-Tuning Error	364
Er-05	No-Load Current Error	Flashing	An Auto-Tuning Error	364
Er-08	Rated Slip Error	Flashing	An Auto-Tuning Error	365
Er-09	Acceleration Error	Flashing	An Auto-Tuning Error	365
Er-12	Current Detection Error	Flashing	An Auto-Tuning Error	365
Er-13	Leakage Inductance Error	Flashing	An Auto-Tuning Error	365
Er-18	Back EMF Error	Flashing	An Auto-Tuning Error	365
Er-19	PM Inductance Error	Flashing	An Auto-Tuning Error	365
Er-20	Stator Resistance Error	Flashing	An Auto-Tuning Error	365
Er-25	HighFreq Inject Param Tuning Err	Flashing	An Auto-Tuning Error	365
Err (001F)	EEPROM Write Error	Illuminated	Fault	330
FAn1 (0413)	Drive Cooling Fan Fault	Illuminated	Fault	330
FDBKL (0094)	Feedback Loss Wire Break	Flashing	Alarm	350
FDBKL (0422)	WIRE Break	Illuminated	Fault	330

## 7.3 List of Fault, Minor Fault, Alarm, and Error Codes

Display (Hex.)	Name	ALM LED	Type	Ref.
FLGT (0095)	Feedback Loss, Go To Freq b5-83	Flashing	Alarm	350
FR<MS (009E)	Freq Ref < Minimum Speed (Y1-06)	Flashing	Alarm	351
FR<TH (009F)	Freq. Reference < Thrust (Y4-12)	Flashing	Alarm	351
GF (0006)	Ground Fault	Illuminated	Fault	330
HCA (0034)	High Current Alarm	Flashing	Alarm	351
HFB (0423)	High Feedback Sensed	Illuminated	Fault	330
HIAUX (0096)	High PI Aux Feedback Level	Flashing	Alarm	351
HIAUX (0424)	High PI Aux Feedback Level	Illuminated	Fault	331
HIFB (0097)	High Feedback Sensed	Flashing	Alarm	351
HLCE (0411)	High Level Communication Errors	Illuminated	Fault	331
iFEr	Communication Err	-	Backup Function Runtime Error	366
INTLK (0069)	BAS Interlock	Flashing	Alarm	352
L24v (0021)	Loss of External Power 24 Supply	Flashing	Alarm	352
LCP (00A7)	Low City Pressure	Flashing	Alarm	352
LF (001C)	Output Phase Loss	Illuminated	Fault	331
LF2 (0036)	Output Current Imbalance	Illuminated	Fault	331
LFB (0425)	Low Feedback Sensed	Illuminated	Fault	331
LOAUX (0099)	Low PI Aux Feedback Level	Flashing	Alarm	352
LOAUX (0426)	Low PI Aux Feedback Level	Illuminated	Fault	332
LoG	Com Error / Abnormal SD Card	Flashing	Alarm	352
LOFB (009A)	Low Feedback Sensed	Flashing	Alarm	352
LOP (009B)	Loss of Prime	Flashing	Alarm	352
LOP (0427)	Loss of Prime	Illuminated	Fault	332
LSP (00A8)	Low Suction Pressure	Flashing	Alarm	353
LT-1 (0035)	Cooling Fan Maintenance Time	Flashing	Alarm	353
LT-2 (0036)	Capacitor Maintenance Time	Flashing	Alarm	353
LT-3 (0043)	SoftChargeBypassRelay MainteTime	Flashing	Alarm	353
LT-4 (0044)	IGBT Maintenance Time (50%)	Flashing	Alarm	353
LWT (00A9)	Low Water In Tank	Flashing	Alarm	353
MSL (0428)	Net Master Lost	Illuminated	Fault	332
ndAT	Model,VolClass,Capacity Mismatch	-	Backup Function Runtime Error	366
NETSC (00A1)	NETSCAN Waiting for Master	Flashing	Alarm	353
NMS (009C)	Setpoint Not Met	Flashing	Alarm	353
NMS (0429)	Setpoint Not Met	Illuminated	Fault	332
nSE (0052)	Node Setup Error	Illuminated	Fault	332
oC (0007)	Overcurrent	Illuminated	Fault	332
OD (009D)	Output Disconnect	Flashing	Alarm	354
OD (042A)	Output Disconnect	Illuminated	Fault	333
oFA00 (0101)	Option Not Compatible with Port	Illuminated	Fault	333
oFA01 (0102)	Option Fault/Connection Error	Illuminated	Fault	334
oFA05 (0106)	Option A/D Error	Illuminated	Fault	334
oFA06 (0107)	Option Communication Error	Illuminated	Fault	334
oFA10 (0111)	Option RAM Error	Illuminated	Fault	334

## 7.3 List of Fault, Minor Fault, Alarm, and Error Codes

Display (Hex.)	Name	ALM LED	Type	Ref.
oFA11 (0112)	Option Ope Mode Error	Illuminated	Fault	334
oFA12 (0113)	Drive Receive CRC Error	Illuminated	Fault	334
oFA13 (0114)	Drive Receive Frame Error	Illuminated	Fault	334
oFA14 (0115)	Drive Receive Abort Error	Illuminated	Fault	334
oFA15 (0116)	Option Receive CRC Error	Illuminated	Fault	335
oFA16 (0117)	Option Receive Frame Error	Illuminated	Fault	335
oFA17 (0118)	Option Receive Abort Error	Illuminated	Fault	335
oFA30 (0131)	COM ID Error	Illuminated	Fault	335
oFA31 (0132)	Type Code Error	Illuminated	Fault	335
oFA32 (0133)	SUM Check Error	Illuminated	Fault	335
oFA33 (0134)	Option Receive Time Over	Illuminated	Fault	335
oFA34 (0135)	Memobus Time Over	Illuminated	Fault	335
oFA35 (0136)	Drive Receive Time Over 1	Illuminated	Fault	336
oFA36 (0137)	CI Check Error	Illuminated	Fault	336
oFA37 (0138)	Drive Receive Time Over 2	Illuminated	Fault	336
oFA38 (0139)	Control Reference Error	Illuminated	Fault	336
oFA39 (013A)	Drive Receive Time Over 3	Illuminated	Fault	336
oFA40 (013B)	CtrlResSel 1Err	Illuminated	Fault	336
oFA41 (013C)	Drive Receive Time Over 4	Illuminated	Fault	336
oFA42 (013D)	CtrlResSel 2Err	Illuminated	Fault	336
oFA43 (013E)	Drive Receive Time Over 5	Illuminated	Fault	337
oH (0003)	Heatsink Overheat	Flashing	Alarm	354
oH (0009)	Heatsink Overheat	Illuminated	Fault	337
oH1 (000A)	Heatsink Overheat	Illuminated	Fault	337
oH2 (0004)	External Overheat (H1-XX=B)	Flashing	Alarm	354
oH3 (001D)	Motor Overheat (PTC Input)	Illuminated	Fault	337
oH3 (0022)	Motor Overheat (PTC Input)	Flashing	Alarm	354
oH4 (0020)	Motor Overheat Fault (PTC Input)	Illuminated	Fault	338
oL1 (000B)	Motor Overload	Illuminated	Fault	338
oL2 (000C)	Drive Overload	Illuminated	Fault	339
oL3 (0005)	Overtorque 1	Flashing	Alarm	355
oL3 (000D)	Overtorque Detection 1	Illuminated	Fault	339
oL4 (0006)	Overtorque 2	Flashing	Alarm	355
oL4 (000E)	Overtorque Detection 2	Illuminated	Fault	339
oL7 (002B)	High Slip Braking Overload	Illuminated	Fault	340
oPE01	Drive Capacity Setting Fault	Flashing	Parameter Setting Error	358
oPE02	Parameter Range Setting Error	Flashing	Parameter Setting Error	358
oPE03	Multi-Function Input Setting Err	Flashing	Parameter Setting Error	358
oPE05	Run Cmd/Freq Ref Source Sel Err	Flashing	Parameter Setting Error	360
oPE07	Analog Input Selection Error	Flashing	Parameter Setting Error	360
oPE08	Parameter Selection Error	Flashing	Parameter Setting Error	360
oPE09	PID Control Selection Fault	Flashing	Parameter Setting Error	361
oPE10	V/f Data Setting Error	Flashing	Parameter Setting Error	361

## 7.3 List of Fault, Minor Fault, Alarm, and Error Codes

Display (Hex.)	Name	ALM LED	Type	Ref.
oPE11	Carrier Frequency Setting Error	Flashing	Parameter Setting Error	361
oPE16	Energy Saving Constants Error	Flashing	Parameter Setting Error	361
oPE33	Digital Output Selection Error	Flashing	Parameter Setting Error	361
oPE34	HAND/OFF/AUTO Input Setting	Flashing	Parameter Setting Error	362
oPE35	Network PI Aux Operation Mode	Flashing	Parameter Setting Error	362
oPr (001E)	Keypad Connection Fault	Illuminated	Fault	340
oS (0010)	Overspeed	Flashing	Alarm	355
oS (0018)	Overspeed	Illuminated	Fault	340
ov (0002)	DC Bus Overvoltage	Flashing	Alarm	355
ov (0008)	Overvoltage	Illuminated	Fault	340
ov2 (0405)	DC Bus Overvoltage 2	Illuminated	Fault	341
ovEr	Too Many Parameters Changed	-	Not an alarm.	355
PASS	Modbus Communication Test	Flashing	Not an alarm.	355
PE1 (0047)	PLC Fault 1	Illuminated	Fault	341
PE2 (0048)	PLC Fault 2	Illuminated	Fault	341
PF (0047)	Input Phase Loss	Flashing	Alarm	355
PF (001B)	Input Phase Loss	Illuminated	Fault	341
PWEr	DWEZ Password Mismatch	-	Backup Function Runtime Error	366
rdEr	Error Reading Data	-	Backup Function Runtime Error	367
rUn (001B)	Motor Switch during Run	Flashing	Alarm	356
SAFE (0062)	Customer Safeties	Flashing	Alarm	356
SC (0005)	Short Circuit/IGBT Failure	Illuminated	Fault	341
SCF (040F)	Safety Circuit Fault	Illuminated	Fault	342
SE (0020)	Modbus Test Mode Error	Flashing	Alarm	356
SEr (003B)	Speed Search Retries Exceeded	Illuminated	Fault	342
STo (003C)	Safe Torque OFF	-	Alarm	356
SToF (003B)	Safe Torque OFF	Flashing	Alarm	356
STPo (0037)	Motor Step-Out Detected	Illuminated	Fault	342
TiM (0089)	Keypad Time Not Set	Flashing	Alarm	356
TiM (0401)	Keypad Time Not Set	Illuminated	Fault	342
TrPC (0042)	IGBT Maintenance Time (90%)	Flashing	Alarm	356
UL3 (001E)	Undertorque Detection 1	Flashing	Alarm	357
UL3 (0029)	Undertorque Detection 1	Illuminated	Fault	342
UL4 (001F)	Undertorque Detection 2	Flashing	Alarm	357
UL4 (002A)	Undertorque Detection 2	Illuminated	Fault	343
UL6 (004E)	Underload or Belt Break Detected	Flashing	Alarm	357
UL6 (005A)	Underload or Belt Break Detected	Illuminated	Fault	343
Uv (0001)	DC Bus Undervoltage	Flashing	Alarm	357
Uv1 (0002)	DC Bus Undervoltage	Illuminated	Fault	343
Uv2 (0003)	Control Power Undervoltage	Illuminated	Fault	343
Uv3 (0004)	Soft Charge Answerback Fault	Illuminated	Fault	343
vAEr	Voltage Class, Capacity Mismatch	-	Backup Function Runtime Error	367

## 7.3 List of Fault, Minor Fault, Alarm, and Error Codes

Display (Hex.)	Name	ALM LED	Type	Ref.
vFyE	Parameters do not Match	-	Backup Function Runtime Error	<a href="#">367</a>
VLTS (042B)	Thermostat Fault	Illuminated	Fault	<a href="#">344</a>

## 7.4 Fault

This section gives information about some of the causes and possible solutions of faults. You must use the Fault Reset operation to remove the fault before you can operate the drive. Use the information in this table to remove the cause of the fault.

Code	Name	Causes	Possible Solutions
AUXFB	PI Aux Feedback Level Loss	The analog input from the terminal set for <i>PI Auxiliary Control Feedback Level</i> [H3-xx = 27] is more than 21 mA or less than 3 mA for longer than 1 s.	Repair transducer or wiring.
<b>Note:</b> Do a Fault Reset to clear the fault.			
Code	Name	Causes	Possible Solutions
bAT	Keypad Battery Low Voltage	The keypad battery voltage is low.	Replace the keypad battery.
<b>Note:</b> Use o4-24 [bAT Detection Selection] to enable/disable bAT detection.			
Code	Name	Causes	Possible Solutions
bCE	Bluetooth Communication Fault	The smartphone or tablet with DriveWizard Mobile installed is too far from the keypad.	Use the smartphone or tablet 10 m (32.8 ft) or nearer to the keypad. <b>Note:</b> bCE can occur when the smartphone or tablet is 10 m (32.8 ft) or nearer to the keypad depending on the specifications of the smartphone or tablet.
		Radio waves from a different device are causing interference with communications between the smartphone or tablet and keypad.	Make sure that no device around the keypad uses the same radio bandwidth (2400 MHz to 2480 MHz), and prevent radio interference.
<b>Note:</b> <ul style="list-style-type: none"> <li>The drive detects this error when you use the Bluetooth HOA keypad and operate the drive with a smartphone or tablet.</li> <li>Do a Fault Reset to clear the fault.</li> <li>Set the stopping method for this fault in o2-27 [bCE Detection Selection].</li> </ul>			
Code	Name	Causes	Possible Solutions
bUS	Option Communication Error	The drive did not receive a signal from the controller.	Correct wiring errors.
		The communications cable wiring is incorrect.	
		There is a short-circuit in the communications cable or the communications cable is not connected.	<ul style="list-style-type: none"> <li>Repair short circuits and connect cables.</li> <li>Replace the defective communications cable.</li> </ul>
		Electrical interference caused a communication data error.	<ul style="list-style-type: none"> <li>Examine the control circuit lines, main circuit lines, and ground wiring, and decrease the effects of electrical interference.</li> <li>Make sure that a magnetic contactor is not the source of the electrical interference, then use a Surge Protective Device if necessary.</li> <li>Use only the recommended cables or other shielded line. Ground the shield on the controller side or the drive input power side.</li> <li>Separate the communication wiring from drive power lines, and install a noise filter to the input side of the power supply for communication.</li> <li>Decrease the effects of electrical interference from the controller.</li> </ul>
		The option is incorrectly installed to the drive.	Correctly install the option to the drive.
		The option is damaged.	If the fault continues and the wiring is correct, replace the option.
<b>Note:</b> <ul style="list-style-type: none"> <li>The drive detects this error if the Run command or frequency reference is assigned to the option card.</li> <li>Do a Fault Reset to clear the fault.</li> <li>If the drive detects this error, the drive will operate the motor as specified by the stopping method set in F6-01 [Communication Error Selection].</li> </ul>			
Code	Name	Causes	Possible Solutions
CE	Modbus Communication Error	The communications cable wiring is incorrect.	Correct wiring errors.
		There is a short circuit in the communications cable or the communications cable is not connected.	<ul style="list-style-type: none"> <li>Repair short circuits and connect cables.</li> <li>Replace the defective communications cable.</li> </ul>



Code	Name	Causes	Possible Solutions
		Electrical interference caused a communication data error.	<ul style="list-style-type: none"> <li>Examine the control circuit lines, main circuit lines, and ground wiring, and decrease the effects of electrical interference.</li> <li>Make sure that a magnetic contactor is not the source of the electrical interference, then use a Surge Protective Device if necessary.</li> <li>Use only the recommended cables or other shielded line. Ground the shield on the controller side or the drive input power side.</li> <li>Separate the communication wiring from drive power lines, and install a noise filter to the input side of the power supply for communication.</li> <li>Decrease the effects of electrical interference from the controller.</li> </ul>
<b>Note:</b> <ul style="list-style-type: none"> <li>The drive detects this error if it does not correctly receive control data for the <i>CE</i> detection time set to <i>H5-09 [CE Detection Time]</i>.</li> <li>Do a Fault Reset to clear the fault.</li> <li>If the drive detects this error, the drive will operate the motor as specified by the stopping method set in <i>H5-04 [Communication Error Stop Method]</i>.</li> </ul>			
Code	Name	Causes	Possible Solutions
CoF	Current Offset Fault	The drive starts operation while the induced voltage stays in the motor (during coasting to a stop or after fast deceleration).	<ul style="list-style-type: none"> <li>Make a sequence that does not restart operation when induced voltage stays in the motor.</li> <li>Set <i>b3-01 = 1 [Speed Search at Start Selection = Enabled]</i>.</li> <li>Use <i>Speed Search from Fmax or Fref [H1-xx = 61, 62]</i> to do a speed search through one of the external terminals.</li> </ul> <b>Note:</b> When controlling the PM motor, External Speed Search commands 1 and 2 operate the same.
		A drive hardware problem occurred.	<ul style="list-style-type: none"> <li>Do a Fault Reset to clear the fault or de-energize the drive.</li> <li>If the fault stays, replace the drive.</li> </ul>
Code	Name	Causes	Possible Solutions
CPF00	Control Circuit Error	A drive hardware problem occurred.	<ul style="list-style-type: none"> <li>Re-energize the drive.</li> <li>If the fault stays, replace the control board or the drive. For information about replacing the control board, contact Yaskawa or your nearest sales representative.</li> </ul>
<b>Note:</b> <ul style="list-style-type: none"> <li>Do a Fault Reset to clear the fault.</li> <li>Fault trace is not available for these faults.</li> </ul>			
Code	Name	Causes	Possible Solutions
CPF01	Control Circuit Error	A drive hardware problem occurred.	<ul style="list-style-type: none"> <li>Re-energize the drive.</li> <li>If the fault stays, replace the control board or the drive. For information about replacing the control board, contact Yaskawa or your nearest sales representative.</li> </ul>
<b>Note:</b> <ul style="list-style-type: none"> <li>Do a Fault Reset to clear the fault.</li> <li>Fault trace is not available for these faults.</li> </ul>			
Code	Name	Causes	Possible Solutions
CPF02	Control Circuit Error	A drive hardware problem occurred.	<ul style="list-style-type: none"> <li>Re-energize the drive.</li> <li>If the fault stays, replace the control board or the cooling fans. If you replace the control board and the cooling fans and the fault stays, replace the drive. For information about replacing the control board and the cooling fans, contact Yaskawa or your nearest sales representative.</li> </ul>
<b>Note:</b> <ul style="list-style-type: none"> <li>Do a Fault Reset to clear the fault.</li> <li>Fault trace is not available for these faults.</li> </ul>			
Code	Name	Causes	Possible Solutions
CPF03	Control Circuit Error	A drive hardware problem occurred.	<ul style="list-style-type: none"> <li>Re-energize the drive.</li> <li>If the fault stays, replace the control board or the drive. For information about replacing the control board, contact Yaskawa or your nearest sales representative.</li> </ul>
<b>Note:</b> <ul style="list-style-type: none"> <li>Do a Fault Reset to clear the fault.</li> <li>Fault trace is not available for these faults.</li> </ul>			

## 7.4 Fault

Code	Name	Causes	Possible Solutions
CPF06	Control Circuit Error (EEPROM memory Data Error)	The drive power supply was de-energized while a communication option entered a parameter Write command.	Set A1-03 = 2220, 3330 [Initialize Parameters = 2-Wire Initialization, 3-Wire Initialization] and initialize the drive.
		An EEPROM peripheral circuit error occurred.	<ul style="list-style-type: none"> <li>Re-energize the drive.</li> <li>If the fault stays, replace the control board or the drive. For information about how to replace the control board, contact Yaskawa or your nearest sales representative.</li> </ul>
<b>Note:</b> <ul style="list-style-type: none"> <li>The drive detects this error if there is an error in the data written to the drive EEPROM.</li> <li>Do a Fault Reset to clear the fault.</li> <li>Fault trace is not available for these faults.</li> </ul>			
Code	Name	Causes	Possible Solutions
CPF07	Control Circuit Error	A drive hardware problem occurred.	<ul style="list-style-type: none"> <li>Re-energize the drive.</li> <li>If the fault stays, replace the control board or the drive. For information about replacing the control board, contact Yaskawa or your nearest sales representative.</li> </ul>
<b>Note:</b> <ul style="list-style-type: none"> <li>Do a Fault Reset to clear the fault.</li> <li>Fault trace is not available for these faults.</li> </ul>			
Code	Name	Causes	Possible Solutions
CPF08	Control Circuit Error	A drive hardware problem occurred.	<ul style="list-style-type: none"> <li>Re-energize the drive.</li> <li>If the fault stays, replace the control board or the drive. For information about replacing the control board, contact Yaskawa or your nearest sales representative.</li> </ul>
<b>Note:</b> <ul style="list-style-type: none"> <li>Do a Fault Reset to clear the fault.</li> <li>Fault trace is not available for these faults.</li> </ul>			
Code	Name	Causes	Possible Solutions
CPF11	Control Circuit Error	A drive hardware problem occurred.	<ul style="list-style-type: none"> <li>Re-energize the drive.</li> <li>If the fault stays, replace the control board or the drive. For information about replacing the control board, contact Yaskawa or your nearest sales representative.</li> </ul>
<b>Note:</b> <ul style="list-style-type: none"> <li>Do a Fault Reset to clear the fault.</li> <li>Fault trace is not available for these faults.</li> </ul>			
Code	Name	Causes	Possible Solutions
CPF12	Control Circuit Error	A drive hardware problem occurred.	<ul style="list-style-type: none"> <li>Re-energize the drive.</li> <li>If the fault stays, replace the control board or the drive. For information about replacing the control board, contact Yaskawa or your nearest sales representative.</li> </ul>
<b>Note:</b> <ul style="list-style-type: none"> <li>Do a Fault Reset to clear the fault.</li> <li>Fault trace is not available for these faults.</li> </ul>			
Code	Name	Causes	Possible Solutions
CPF13	Control Circuit Error	A drive hardware problem occurred.	<ul style="list-style-type: none"> <li>Re-energize the drive.</li> <li>If the fault stays, replace the control board or the drive. For information about replacing the control board, contact Yaskawa or your nearest sales representative.</li> </ul>
<b>Note:</b> <ul style="list-style-type: none"> <li>Do a Fault Reset to clear the fault.</li> <li>Fault trace is not available for these faults.</li> </ul>			
Code	Name	Causes	Possible Solutions
CPF14	Control Circuit Error	A drive hardware problem occurred.	<ul style="list-style-type: none"> <li>Re-energize the drive.</li> <li>If the fault stays, replace the control board or the drive. For information about replacing the control board, contact Yaskawa or your nearest sales representative.</li> </ul>
<b>Note:</b> <ul style="list-style-type: none"> <li>Do a Fault Reset to clear the fault.</li> <li>Fault trace is not available for these faults.</li> </ul>			

Code	Name	Causes	Possible Solutions
CPF16	Control Circuit Error	A drive hardware problem occurred.	<ul style="list-style-type: none"> <li>Re-energize the drive.</li> <li>If the fault stays, replace the control board or the drive. For information about replacing the control board, contact Yaskawa or your nearest sales representative.</li> </ul>
<b>Note:</b> <ul style="list-style-type: none"> <li>Do a Fault Reset to clear the fault.</li> <li>Fault trace is not available for these faults.</li> </ul>			
Code	Name	Causes	Possible Solutions
CPF17	Control Circuit Error	A drive hardware problem occurred.	<ul style="list-style-type: none"> <li>Re-energize the drive.</li> <li>If the fault stays, replace the control board or the drive. For information about replacing the control board, contact Yaskawa or your nearest sales representative.</li> </ul>
<b>Note:</b> <ul style="list-style-type: none"> <li>Do a Fault Reset to clear the fault.</li> <li>Fault trace is not available for these faults.</li> </ul>			
Code	Name	Causes	Possible Solutions
CPF18	Control Circuit Error	A drive hardware problem occurred.	<ul style="list-style-type: none"> <li>Re-energize the drive.</li> <li>If the fault stays, replace the control board or the drive. For information about replacing the control board, contact Yaskawa or your nearest sales representative.</li> </ul>
<b>Note:</b> <ul style="list-style-type: none"> <li>Do a Fault Reset to clear the fault.</li> <li>Fault trace is not available for these faults.</li> </ul>			
Code	Name	Causes	Possible Solutions
CPF19	Control Circuit Error	A drive hardware problem occurred.	<ul style="list-style-type: none"> <li>Re-energize the drive.</li> <li>If the fault stays, replace the control board or the drive. For information about replacing the control board, contact Yaskawa or your nearest sales representative.</li> </ul>
<b>Note:</b> <ul style="list-style-type: none"> <li>Do a Fault Reset to clear the fault.</li> <li>Fault trace is not available for these faults.</li> </ul>			
Code	Name	Causes	Possible Solutions
CPF20	Control Circuit Error	A drive hardware problem occurred.	<ul style="list-style-type: none"> <li>Re-energize the drive.</li> <li>If the fault stays, replace the control board or the drive. For information about replacing the control board, contact Yaskawa or your nearest sales representative.</li> </ul>
<b>Note:</b> <ul style="list-style-type: none"> <li>Do a Fault Reset to clear the fault.</li> <li>Fault trace is not available for these faults.</li> </ul>			
Code	Name	Causes	Possible Solutions
CPF21	Control Circuit Error	A drive hardware problem occurred.	<ul style="list-style-type: none"> <li>Re-energize the drive.</li> <li>If the fault stays, replace the control board or the drive. For information about replacing the control board, contact Yaskawa or your nearest sales representative.</li> </ul>
<b>Note:</b> <ul style="list-style-type: none"> <li>Do a Fault Reset to clear the fault.</li> <li>Fault trace is not available for these faults.</li> </ul>			
Code	Name	Causes	Possible Solutions
CPF22	Control Circuit Error	A drive hardware problem occurred.	<ul style="list-style-type: none"> <li>Re-energize the drive.</li> <li>If the fault stays, replace the control board or the drive. For information about replacing the control board, contact Yaskawa or your nearest sales representative.</li> </ul>
<b>Note:</b> <ul style="list-style-type: none"> <li>Do a Fault Reset to clear the fault.</li> <li>Fault trace is not available for these faults.</li> </ul>			
Code	Name	Causes	Possible Solutions
CPF23	Control Circuit Error	A drive hardware problem occurred.	<ul style="list-style-type: none"> <li>Re-energize the drive.</li> <li>If the fault stays, replace the control board or the drive. For information about replacing the control board, contact Yaskawa or your nearest sales representative.</li> </ul>
<b>Note:</b> <ul style="list-style-type: none"> <li>Do a Fault Reset to clear the fault.</li> <li>Fault trace is not available for these faults.</li> </ul>			

## 7.4 Fault

Code	Name	Causes	Possible Solutions
CPF24	Control Circuit Error (Drive Unit Signal Fault)	A drive hardware problem occurred.	<ul style="list-style-type: none"> <li>Re-energize the drive.</li> <li>If the fault stays, replace the control board or the drive. For information about replacing the control board, contact Yaskawa or your nearest sales representative.</li> </ul>
<b>Note:</b> <ul style="list-style-type: none"> <li>Do a Fault Reset to clear the fault.</li> <li>Fault trace is not available for these faults.</li> </ul>			
Code	Name	Causes	Possible Solutions
CPF26	Control Circuit Error	A drive hardware problem occurred.	<ul style="list-style-type: none"> <li>Re-energize the drive.</li> <li>If the fault stays, replace the control board or the drive. For information about replacing the control board, contact Yaskawa or your nearest sales representative.</li> </ul>
<b>Note:</b> <ul style="list-style-type: none"> <li>Do a Fault Reset to clear the fault.</li> <li>Fault trace is not available for these faults.</li> </ul>			
Code	Name	Causes	Possible Solutions
CPF27	Control Circuit Error	A drive hardware problem occurred.	<ul style="list-style-type: none"> <li>Re-energize the drive.</li> <li>If the fault stays, replace the control board or the drive. For information about replacing the control board, contact Yaskawa or your nearest sales representative.</li> </ul>
<b>Note:</b> <ul style="list-style-type: none"> <li>Do a Fault Reset to clear the fault.</li> <li>Fault trace is not available for these faults.</li> </ul>			
Code	Name	Causes	Possible Solutions
CPF28	Control Circuit Error	A drive hardware problem occurred.	<ul style="list-style-type: none"> <li>Re-energize the drive.</li> <li>If the fault stays, replace the control board or the drive. For information about replacing the control board, contact Yaskawa or your nearest sales representative.</li> </ul>
<b>Note:</b> <ul style="list-style-type: none"> <li>Do a Fault Reset to clear the fault.</li> <li>Fault trace is not available for these faults.</li> </ul>			
Code	Name	Causes	Possible Solutions
CPF29	Control Circuit Error	A drive hardware problem occurred.	<ul style="list-style-type: none"> <li>Re-energize the drive.</li> <li>If the fault stays, replace the control board or the drive. For information about replacing the control board, contact Yaskawa or your nearest sales representative.</li> </ul>
<b>Note:</b> <ul style="list-style-type: none"> <li>Do a Fault Reset to clear the fault.</li> <li>Fault trace is not available for these faults.</li> </ul>			
Code	Name	Causes	Possible Solutions
CPF30	Control Circuit Error	A drive hardware problem occurred.	<ul style="list-style-type: none"> <li>Re-energize the drive.</li> <li>If the fault stays, replace the control board or the drive. For information about replacing the control board, contact Yaskawa or your nearest sales representative.</li> </ul>
<b>Note:</b> <ul style="list-style-type: none"> <li>Do a Fault Reset to clear the fault.</li> <li>Fault trace is not available for these faults.</li> </ul>			
Code	Name	Causes	Possible Solutions
CPF31	Control Circuit Error	A drive hardware problem occurred.	<ul style="list-style-type: none"> <li>Re-energize the drive.</li> <li>If the fault stays, replace the control board or the drive. For information about replacing the control board, contact Yaskawa or your nearest sales representative.</li> </ul>
<b>Note:</b> <ul style="list-style-type: none"> <li>Do a Fault Reset to clear the fault.</li> <li>Fault trace is not available for these faults.</li> </ul>			
Code	Name	Causes	Possible Solutions
CPF32	Control Circuit Error	A drive hardware problem occurred.	<ul style="list-style-type: none"> <li>Re-energize the drive.</li> <li>If the fault stays, replace the control board or the drive. For information about replacing the control board, contact Yaskawa or your nearest sales representative.</li> </ul>
<b>Note:</b> <ul style="list-style-type: none"> <li>Do a Fault Reset to clear the fault.</li> <li>Fault trace is not available for these faults.</li> </ul>			

Code	Name	Causes	Possible Solutions
CPF33	Control Circuit Error	A drive hardware problem occurred.	<ul style="list-style-type: none"> <li>Re-energize the drive.</li> <li>If the fault stays, replace the control board or the drive. For information about replacing the control board, contact Yaskawa or your nearest sales representative.</li> </ul>
<b>Note:</b> <ul style="list-style-type: none"> <li>Do a Fault Reset to clear the fault.</li> <li>Fault trace is not available for these faults.</li> </ul>			
Code	Name	Causes	Possible Solutions
CPF34	Control Circuit Error	A drive hardware problem occurred.	<ul style="list-style-type: none"> <li>Re-energize the drive.</li> <li>If the fault stays, replace the control board or the drive. For information about replacing the control board, contact Yaskawa or your nearest sales representative.</li> </ul>
<b>Note:</b> <ul style="list-style-type: none"> <li>Do a Fault Reset to clear the fault.</li> <li>Fault trace is not available for these faults.</li> </ul>			
Code	Name	Causes	Possible Solutions
CPF35	Control Circuit Error	A drive hardware problem occurred.	<ul style="list-style-type: none"> <li>Re-energize the drive.</li> <li>If the fault stays, replace the control board or the drive. For information about replacing the control board, contact Yaskawa or your nearest sales representative.</li> </ul>
<b>Note:</b> <ul style="list-style-type: none"> <li>Do a Fault Reset to clear the fault.</li> <li>Fault trace is not available for these faults.</li> </ul>			
Code	Name	Causes	Possible Solutions
CPF36	Control Circuit Error	A drive hardware problem occurred.	<ul style="list-style-type: none"> <li>Re-energize the drive.</li> <li>If the fault stays, replace the control board or the drive. For information about replacing the control board, contact Yaskawa or your nearest sales representative.</li> </ul>
<b>Note:</b> <ul style="list-style-type: none"> <li>Do a Fault Reset to clear the fault.</li> <li>Fault trace is not available for these faults.</li> </ul>			
Code	Name	Causes	Possible Solutions
CPF37	Control Circuit Error	A drive hardware problem occurred.	<ul style="list-style-type: none"> <li>Re-energize the drive.</li> <li>If the fault stays, replace the control board or the drive. For information about replacing the control board, contact Yaskawa or your nearest sales representative.</li> </ul>
<b>Note:</b> <ul style="list-style-type: none"> <li>Do a Fault Reset to clear the fault.</li> <li>Fault trace is not available for these faults.</li> </ul>			
Code	Name	Causes	Possible Solutions
CPF38	Control Circuit Error	A drive hardware problem occurred.	<ul style="list-style-type: none"> <li>Re-energize the drive.</li> <li>If the fault stays, replace the control board or the drive. For information about replacing the control board, contact Yaskawa or your nearest sales representative.</li> </ul>
<b>Note:</b> <ul style="list-style-type: none"> <li>Do a Fault Reset to clear the fault.</li> <li>Fault trace is not available for these faults.</li> </ul>			
Code	Name	Causes	Possible Solutions
CPF39	Control Circuit Error	A drive hardware problem occurred.	<ul style="list-style-type: none"> <li>Re-energize the drive.</li> <li>If the fault stays, replace the control board or the drive. For information about replacing the control board, contact Yaskawa or your nearest sales representative.</li> </ul>
<b>Note:</b> <ul style="list-style-type: none"> <li>Do a Fault Reset to clear the fault.</li> <li>Fault trace is not available for these faults.</li> </ul>			
Code	Name	Causes	Possible Solutions
dEv	Speed Deviation	The load is too heavy.	Decrease the load.
		Acceleration and deceleration times are set too short.	Increase the values set in C1-01 to C1-04 [Acceleration/Deceleration Time].
		The dEv detection level settings are incorrect.	Adjust F1-10 [Speed Deviation Detection Level] and F1-11 [Speed Deviation Detect DelayTime].
		The load is locked up.	Examine the machine.

## 7.4 Fault

Code	Name	Causes	Possible Solutions
		The holding brake is stopping the motor.	Release the holding brake.
<b>Note:</b> <ul style="list-style-type: none"> <li>The drive detects this error if the difference between the detected speed and the speed reference is more than the setting of F1-10 for longer than F1-11.</li> <li>Do a Fault Reset to clear the fault.</li> <li>If the drive detects this error, the drive will operate the motor as specified by the stopping method set in F1-04 [Speed Deviation Detection Select].</li> </ul>			
Code	Name	Causes	Possible Solutions
DIFF	Differential Feedback Exceeded	The difference between the PID Feedback and Differential Level Source [H3-xx = 2D] is more than the level set in Y4-18 [Differential Level] for the time set in Y4-19 [Differential Lvl Detection Time].	<ul style="list-style-type: none"> <li>Replace the feedback transducer or transducers.</li> <li>Make sure that the settings of Y4-18 [Differential Level] to Y4-20 [Differential Level Detection Sel] are correct.</li> </ul>
<b>Note:</b> Do a Fault Reset to clear the fault.			
Code	Name	Causes	Possible Solutions
dv7	Polarity Judge Timeout	There is a disconnection in the motor coil winding. The screws on the drive output terminals are loose.	Measure the motor line-to-line resistance and replace the motor if a coil is disconnected. Tighten the terminal screws to the correct tightening torque.
<b>Note:</b> <ul style="list-style-type: none"> <li>The drive detects this error if it cannot detect polarity in a pre-set length of time.</li> <li>Do a Fault Reset to clear the fault.</li> </ul>			
Code	Name	Causes	Possible Solutions
dWF1	EEPROM Memory DWEZ Data Error	There is an error in the EEPROM peripheral circuit. There is a problem with the EEPROM data.	<ul style="list-style-type: none"> <li>Re-energize the drive.</li> <li>If the fault stays, replace the control board or the drive. For information about replacing the control board, contact Yaskawa or your nearest sales representative.</li> </ul> Set A1-03 = 2220, 3330 [Initialize Parameters = 2-Wire Initialization, 3-Wire Initialization] to initialize the drive, then upload the DriveWorksEZ project to the drive again.
<b>Note:</b> <ul style="list-style-type: none"> <li>The drive detects this error if there is an error in the DriveWorksEZ program that was saved to EEPROM.</li> <li>Do a Fault Reset to clear the fault.</li> </ul>			
Code	Name	Causes	Possible Solutions
dWF2	DriveWorksEZ Fault 2	There was a fault in the DriveWorksEZ program.	Examine the DriveWorksEZ program and remove the cause of the fault. This is not a drive fault.
<b>Note:</b> Do a Fault Reset to clear the fault.			
Code	Name	Causes	Possible Solutions
dWF3	DriveWorksEZ Fault 3	There was a fault in the DriveWorksEZ program.	Examine the DriveWorksEZ program and remove the cause of the fault. This is not a drive fault.
<b>Note:</b> Do a Fault Reset to clear the fault.			
Code	Name	Causes	Possible Solutions
dWFL	DriveWorksEZ Fault	There was a fault in the DriveWorksEZ program.	Examine the DriveWorksEZ program and remove the cause of the fault. This is not a drive fault.
<b>Note:</b> Do a Fault Reset to clear the fault.			
Code	Name	Causes	Possible Solutions
EF0	Option Card External Fault	The communication option received an external fault from the controller. A programming error occurred on the controller side.	<ol style="list-style-type: none"> <li>Find the device that caused the external fault and remove the cause.</li> <li>Clear the external fault input from the controller.</li> </ol> Examine the operation of the controller program.
<b>Note:</b> <ul style="list-style-type: none"> <li>The drive detects this fault if the alarm function on the external device side is operating.</li> <li>Do a Fault Reset to clear the fault.</li> <li>If the drive detects this fault, it will operate the motor as specified by the stop method set in F6-03 [Comm External Fault (EF0) Select].</li> </ul>			
Code	Name	Causes	Possible Solutions
EF1	External Fault (Terminal S1)	MFDI terminal S1 caused an external fault through an external device. The wiring is incorrect.	<ol style="list-style-type: none"> <li>Find the device that caused the external fault and remove the cause.</li> <li>Clear the external fault input in the MFDI.</li> </ol> Correctly connect the signal line to MFDI terminal S1.

Code	Name	Causes	Possible Solutions
		<i>External Fault [H1-01 = 20 to 2B]</i> is set to MFDI terminal S1, but the terminal is not in use.	Correctly set the MFDI.
<b>Note:</b> Do a Fault Reset to clear the fault.			
Code	Name	Causes	Possible Solutions
EF2	External Fault (Terminal S2)	MFDI terminal S2 caused an external fault through an external device.	1. Find the device that caused the external fault and remove the cause. 2. Clear the external fault input in the MFDI.
		The wiring is incorrect.	Correctly connect the signal line to MFDI terminal S2.
		<i>External Fault [H1-02 = 20 to 2B]</i> is set to MFDI terminal S2, but the terminal is not in use.	Correctly set the MFDI.
<b>Note:</b> Do a Fault Reset to clear the fault.			
Code	Name	Causes	Possible Solutions
EF3	External Fault (Terminal S3)	MFDI terminal S3 caused an external fault through an external device.	1. Find the device that caused the external fault and remove the cause. 2. Clear the external fault input in the MFDI.
		The wiring is incorrect.	Correctly connect the signal line to MFDI terminal S3.
		<i>External Fault [H1-03 = 20 to 2B]</i> is set to MFDI terminal S3, but the terminal is not in use.	Correctly set the MFDI.
<b>Note:</b> Do a Fault Reset to clear the fault.			
Code	Name	Causes	Possible Solutions
EF4	External Fault (Terminal S4)	MFDI terminal S4 caused an external fault through an external device.	1. Find the device that caused the external fault and remove the cause. 2. Clear the external fault input in the MFDI.
		The wiring is incorrect.	Correctly connect the signal line to MFDI terminal S4.
		<i>External Fault [H1-04 = 20 to 2B]</i> is set to MFDI terminal S4, but the terminal is not in use.	Correctly set the MFDI.
<b>Note:</b> Do a Fault Reset to clear the fault.			
Code	Name	Causes	Possible Solutions
EF5	External Fault (Terminal S5)	MFDI terminal S5 caused an external fault through an external device.	1. Find the device that caused the external fault and remove the cause. 2. Clear the external fault input in the MFDI.
		The wiring is incorrect.	Correctly connect the signal line to MFDI terminal S5.
		<i>External Fault [H1-05 = 20 to 2B]</i> is set to MFDI terminal S5, but the terminal is not in use.	Correctly set the MFDI.
<b>Note:</b> Do a Fault Reset to clear the fault.			
Code	Name	Causes	Possible Solutions
EF6	External Fault (Terminal S6)	MFDI terminal S6 caused an external fault through an external device.	1. Find the device that caused the external fault and remove the cause. 2. Clear the external fault input in the MFDI.
		The wiring is incorrect.	Correctly connect the signal line to MFDI terminal S6.
		<i>External Fault [H1-06 = 20 to 2B]</i> is set to MFDI terminal S6, but the terminal is not in use.	Correctly set the MFDI.
<b>Note:</b> Do a Fault Reset to clear the fault.			
Code	Name	Causes	Possible Solutions
EF7	External Fault (Terminal S7)	MFDI terminal S7 caused an external fault through an external device.	1. Find the device that caused the external fault and remove the cause. 2. Clear the external fault input in the MFDI.
		The wiring is incorrect.	Correctly connect the signal line to MFDI terminal S7.
		<i>External Fault [H1-07 = 20 to 2B]</i> is set to MFDI terminal S7, but the terminal is not in use.	Correctly set the MFDI.
<b>Note:</b> Do a Fault Reset to clear the fault.			

## 7.4 Fault

Code	Name	Causes	Possible Solutions
Err	EEPROM Write Error	There was a problem with the EEPROM hardware.	<ul style="list-style-type: none"> <li>Re-energize the drive.</li> <li>If the fault stays, replace the control board or the drive. Contact Yaskawa or your nearest sales representative to replace the board.</li> </ul>
		Electrical interference corrupted the data while it was writing to the EEPROM of the drive.	<ul style="list-style-type: none"> <li>Push ENTER Key.</li> <li>Set the parameters again.</li> </ul>
<b>Note:</b> Do a Fault Reset to clear the fault.			
Code	Name	Causes	Possible Solutions
FAn1	Drive Cooling Fan Fault	The cooling fan stopped operating correctly.	<ul style="list-style-type: none"> <li>Examine cooling fan operation.</li> <li>Re-energize the drive.</li> <li>Examine U4-03 [Cooling Fan Ope Time] and U4-04 [Cool Fan Maintenance]. If the performance life of the cooling fan is expired or if there is damage to the fan, replace the fan.</li> </ul>
		The circulation fan is damaged.	<ul style="list-style-type: none"> <li>Examine circulation fan operation.</li> <li>Re-energize the drive.</li> <li>Examine U4-03 [Cooling Fan Ope Time] and U4-04 [Cool Fan Maintenance]. If there is damage to the circulation fan or if the performance life of the fan is expired, replace the fan.</li> </ul>
<b>Note:</b> Do a Fault Reset to clear the fault.			
Code	Name	Causes	Possible Solutions
FDBKL	WIRE Break	The analog input from the terminal set for <i>PID Feedback</i> [H3-xx = B] is more than 21mA or less than 3mA for longer than 1 s in these conditions: <ul style="list-style-type: none"> <li>b5-82 = 2 [Feedback Loss 4 ~ 20mA Detect Sel = Fault]</li> <li>b5-01 ≠ 0 [PID Mode Setting ≠ Disabled]</li> <li>H3-01 or H3-09 = 2 [Terminal A1/A2 Signal Level Selection = 4 to 20 mA]</li> </ul>	Make sure that you install the PID feedback source and it operates correctly.
<b>Note:</b> <ul style="list-style-type: none"> <li>Do a Fault Reset to clear the fault.</li> <li>If the drive detects this fault, it will operate the motor as specified by the settings of b5-82.</li> <li>Parameter L5-42 [Feedback Loss Fault Retry Select] sets the Auto Restart function of this fault.</li> </ul>			
Code	Name	Causes	Possible Solutions
GF	Ground Fault	Overheating caused damage to the motor or the motor insulation is not satisfactory.	Measure the motor insulation resistance, and replace the motor if there is electrical conduction or unserviceable insulation.
		The motor main circuit cable is contacting ground to make a short circuit.	<ul style="list-style-type: none"> <li>Examine the motor main circuit cable for damage, and repair short circuits.</li> <li>Measure the resistance between the motor main circuit cable and the ground terminal. If there is electrical conduction, replace the cable.</li> </ul>
		An increase in the stray capacitance of the cable and the ground terminal caused an increase in the leakage current.	<ul style="list-style-type: none"> <li>If the wiring length of the cable is more than 100 m, decrease the carrier frequency.</li> <li>Decrease the stray capacitance.</li> </ul>
		There was a problem with the drive hardware.	Replace the control board or the drive. For information about replacing the control board, contact Yaskawa or your nearest sales representative.
<b>Note:</b> <ul style="list-style-type: none"> <li>The drive detects this fault if a current short to ground was more than 50% of rated current on the output side of the drive.</li> <li>Do a Fault Reset to clear the fault.</li> <li>L5-08 [Fault Reset Enable Select Grp2] disables the Auto Restart function.</li> </ul>			
Code	Name	Causes	Possible Solutions
HFB	High Feedback Sensed	The feedback level is more than the level set in Y1-11 [High Feedback Level] for the time set in Y1-12 [High Feedback Lvl Fault Dly Time].	<ul style="list-style-type: none"> <li>Decrease the feedback level less than Y1-11.</li> <li>Set Y1-11 and Y1-12 correctly.</li> </ul>
<b>Note:</b> <ul style="list-style-type: none"> <li>Do a Fault Reset to clear the fault.</li> <li>If the drive detects this fault, it will respond as specified by the setting of Y1-13 [High Feedback Selection].</li> <li>Parameter L5-41 [Hi Feedback Flt Retry Selection] sets the Auto Restart function of this fault.</li> </ul>			



Code	Name	Causes	Possible Solutions
HIAUX	High PI Aux Feedback Level	<p>PI Auxiliary Feedback is more than the level set in <i>YF-12 [PI Aux Control High Level Detect]</i> for the time set in <i>YF-13 [PI Aux High Level Detection Time]</i> in these conditions:</p> <ul style="list-style-type: none"> <li>The drive operates in AUTO Mode.</li> <li>The output frequency &gt; 0.</li> </ul>	<ul style="list-style-type: none"> <li>Decrease the PI Auxiliary Feedback level less than <i>YF-12</i>.</li> <li>Set <i>YF-12</i> and <i>YF-13</i> correctly.</li> </ul>
<p><b>Note:</b></p> <ul style="list-style-type: none"> <li>Do a Fault Reset to clear the fault.</li> <li>Parameter <i>YF-14 [PI Aux Hi Level Detection Select]</i> sets the Auto Restart function of this fault.</li> </ul>			
Code	Name	Causes	Possible Solutions
HLCE	High Level Communication Errors	<p>Communication data error occurred between the option and the master drive when you use Gateway function.</p> <p>The master drive detects <i>oF:xxx</i> and the slave drive detects <i>HLCE</i>.</p>	Examine the wiring between the option and the master drive and remove the cause of the fault.
<p><b>Note:</b></p> <p>This fault occurs when the drive is a slave drive in Gateway Mode [<i>F6-16</i> ≠ 0] and communication is lost from the master.</p>			
Code	Name	Causes	Possible Solutions
LF	Output Phase Loss	The motor main circuit cable is disconnected.	Connect motor main circuit cable wiring. Correct wiring errors in the main circuit drive input power.
		There is a disconnection in the motor coil winding.	If a coil is disconnected, measure the motor Line-to-Line Resistance and replace the motor.
		The screws on the drive output terminals are loose.	Tighten the terminal screws to the correct tightening torque.
		The rated output current of the motor is less than 5% of the drive rated current.	Examine the drive capacity or the motor output to be applied.
		You are trying to use a single-phase motor.	The drive cannot operate a single-phase motor.
		The output transistor in the drive is damaged.	<ul style="list-style-type: none"> <li>Re-energize the drive.</li> <li>If the fault stays, replace the control board or the drive. For information about replacing the control board, contact Yaskawa or your nearest sales representative.</li> </ul>
<p><b>Note:</b></p> <ul style="list-style-type: none"> <li>The drive detects this fault if phase loss occurs on the output side of the drive.</li> <li>Do a Fault Reset to clear the fault.</li> <li>Set <i>L8-07 [Output Phase Loss Protection Sel]</i> to enable and disable <i>LF</i> detection.</li> </ul>			
Code	Name	Causes	Possible Solutions
LF2	Output Current Imbalance	Phase loss occurred in the wiring on the output side of the drive.	Examine for wiring errors or disconnected wires on the output side of the drive, and repair problems.
		The output terminal screws of the drive are loose.	Tighten the terminal screws to the correct tightening torque.
		There is not balance between the three phases of the PM motor impedance.	<ul style="list-style-type: none"> <li>Measure the Line-to-Line Resistance for each motor phase and make sure that resistance is equal in the three phases, and that all wires are connected correctly.</li> <li>Replace the motor.</li> </ul>
		The drive output circuit is broken.	<ul style="list-style-type: none"> <li>Re-energize the drive.</li> <li>If the fault stays, replace the control board or the drive. For information about replacing the control board, contact Yaskawa or your nearest sales representative.</li> </ul>
<p><b>Note:</b></p> <ul style="list-style-type: none"> <li>The drive detects this fault if there is not balance between the three phases of the output current from the PM motor.</li> <li>Do a Fault Reset to clear the fault.</li> </ul>			
Code	Name	Causes	Possible Solutions
LFB	Low Feedback Sensed	The feedback level is less than the level set in <i>Y1-08 [Low Feedback Level]</i> for the time set in <i>Y1-09 [Low Feedback Lvl Fault Dly Time]</i> .	<ul style="list-style-type: none"> <li>Increase the feedback level to more than <i>Y1-08</i>.</li> <li>Set <i>Y1-08</i> and <i>Y1-09</i> correctly.</li> </ul>
<p><b>Note:</b></p> <ul style="list-style-type: none"> <li>Do a Fault Reset to clear the fault.</li> <li>If the drive detects this fault, it will respond as specified by the setting of <i>Y1-10 [Low Feedback Selection]</i>.</li> <li>Parameter <i>L5-40 [Low Feedback Flt Retry Selection]</i> sets the Auto Restart function of this fault.</li> </ul>			

## 7.4 Fault

Code	Name	Causes	Possible Solutions
LOAUX	Low PI Aux Feedback Level	When the drive operates in AUTO Mode or HAND Mode, PI Auxiliary Feedback is less than the level set in YF-09 [PI Aux Control Low Lvl Detection] for the time set in YF-10 [PI Aux Control Low Lvl Det Time] and the drive is running.	<ul style="list-style-type: none"> <li>Increase the PI Auxiliary Feedback level to be more than YF-09.</li> <li>Set YF-09 and YF-10 correctly.</li> </ul>
<b>Note:</b> <ul style="list-style-type: none"> <li>Do a Fault Reset to clear the fault.</li> <li>Parameter YF-11 [PI Aux Control Low Level Det Sel] sets the Auto Restart function of this fault.</li> </ul>			
Code	Name	Causes	Possible Solutions
LOP	Loss of Prime	The drive used the Y1-18 [Prime Loss Detection Method] setting and measured a pump load that is less than the level set in Y1-19 [Prime Loss Level] for the time set in Y1-20 [Prime Loss Time], and the output frequency is Y1-21 [Prime Loss Activation Freq] or more.	<ul style="list-style-type: none"> <li>Examine for a dry well, air in the system, or no water in the system. Use preferred priming method suggested by the pump manufacturer to restart the pump.</li> <li>When there is resistance in the pump, let the system pump water again.</li> <li>Set Y1-18 to Y1-21 correctly.</li> </ul>
<b>Note:</b> <ul style="list-style-type: none"> <li>Do a Fault Reset to clear the fault.</li> <li>If the drive detects this fault, it will respond as specified by the setting of Y1-22 [Prime Loss Selection].</li> <li>Parameters L5-51 [Loss of Prime Fault Retry Select] and Y1-23 [Prime Loss Max Restart Time] set the Auto Restart function of this fault.</li> </ul>			
Code	Name	Causes	Possible Solutions
MSL	Net Master Lost	When Y9-27 = 3 [Network Recovery = Fault MSL] and the drive does not receive message from the master within the time set in Y9-26 [Master Time-out].	<ul style="list-style-type: none"> <li>Increase Y9-26 to account for network latency.</li> <li>Make sure that there is a drive on the network with parameters set to Y1-01 = 3 [Multiplex Mode = Memobus Network] and Y9-27 = 0 [Automatic].</li> <li>Examine network connections and the settings of H5-01 [Drive Node Address] and Y9-25 [Highest Node Address] for all drives on the network.</li> </ul>
<b>Note:</b> <ul style="list-style-type: none"> <li>Do a Fault Reset to clear the fault.</li> </ul>			
Code	Name	Causes	Possible Solutions
NMS	Setpoint Not Met	The feedback deviates from the setpoint at a level more than Y1-15 [Maximum Setpoint Difference] for the time set in Y1-16 [Not Maintaining Setpoint Time].	<ul style="list-style-type: none"> <li>Examine for a blocked impeller, over cycling, or broken pipe.</li> <li>Set Y1-15 and Y1-16 correctly.</li> </ul>
<b>Note:</b> <ul style="list-style-type: none"> <li>Do a Fault Reset to clear the fault.</li> <li>If the drive detects this fault, it will respond as specified by the setting of Y1-17 [Not Maintaining Setpoint Sel].</li> <li>Parameter L5-50 [Setpoint Not Met Fault Retry Sel] sets the Auto Restart function of this fault.</li> </ul>			
Code	Name	Causes	Possible Solutions
nSE	Node Setup Error	The drive received a Run command while the Node Setup function was active.	Stop the drive when the Node Setup function is in use.
<b>Note:</b> <ul style="list-style-type: none"> <li>Do a Fault Reset to clear the fault.</li> </ul>			
Code	Name	Causes	Possible Solutions
oC	Overcurrent	The load is too large.	<ul style="list-style-type: none"> <li>Measure the current flowing into the motor.</li> <li>Replace the drive with a larger capacity model if the current value is more than the drive rated current.</li> <li>Decrease the load or replace with a larger drive to prevent sudden changes in the current level.</li> </ul>
		Overheating caused damage to the motor or the motor insulation is not satisfactory.	Measure the motor insulation resistance, and replace the motor if there is electrical conduction or unserviceable insulation.
		The motor main circuit cable is contacting ground to make a short circuit.	<ul style="list-style-type: none"> <li>Examine the motor main circuit cable for damage, and repair short circuits.</li> <li>Measure the resistance between the motor main circuit cable and the ground terminal. If there is electrical conduction, replace the cable.</li> </ul>
		A short circuit or ground fault on the drive output side caused damage to the output transistor of the drive.	<ul style="list-style-type: none"> <li>Make sure that there is not a short circuit in terminals - and terminals U/T1, V/T2, and W/T3.</li> <li>If there is a short circuit, contact Yaskawa or your nearest sales representative.</li> </ul>
		The acceleration time is too short.	<ul style="list-style-type: none"> <li>Calculate the torque necessary during acceleration related to the load inertia and the specified acceleration time.</li> <li>Increase the values set in C1-01 or C1-03 [Acceleration Times] to get the necessary torque.</li> <li>Increase the values set in C2-01 to C2-04 [S-Curve Characteristics] to get the necessary torque.</li> <li>Replace the drive with a larger capacity model.</li> </ul>

Code	Name	Causes	Possible Solutions
		The drive is trying to operate a specialized motor or a motor that is larger than the maximum applicable motor output of the drive.	<ul style="list-style-type: none"> <li>Examine the motor nameplate, the motor, and the drive to make sure that the drive rated current is larger than the motor rated current.</li> <li>Replace the drive with a larger capacity model.</li> </ul>
		A magnetic contactor was switched at the output.	Set the operation sequence to not turn ON or OFF the magnetic contactor while the drive is outputting voltage.
		The V/f pattern settings are incorrect.	<ul style="list-style-type: none"> <li>Examine the ratios between the V/f pattern frequency and voltage. Decrease the voltage if it is too high compared to the frequency.</li> <li>Adjust E1-04 to E1-10 [V/f Pattern Parameters]. For motor 2, adjust E3-04 to E3-10.</li> </ul>
		The torque compensation gain is too large.	Decrease the value set in C4-01 [Torque Compensation Gain] to make sure that the motor does not stall.
		Electrical interference caused a problem.	Examine the control circuit lines, main circuit lines, and ground wiring, and decrease the effects of electrical interference.
		The gain during overexcitation operation is too large.	<ul style="list-style-type: none"> <li>Find the time when the fault occurs.</li> <li>If the fault occurs at the same time as overexcitation operation, decrease the value set in n3-13 [OverexcitationBraking (OEB) Gain] and consider the motor flux saturation.</li> </ul>
		The drive received a Run command while the motor was coasting.	<ul style="list-style-type: none"> <li>Examine the sequence and input the Run command after the motor fully stops.</li> <li>Set b3-01 = 1 [Speed Search at Start Selection = Enabled] or set H1-xx = 61, 62 [Speed Search from Fmax or Fref] to input speed search commands from the MFDI terminals.</li> </ul>
		The motor code setting is incorrect for PM Control Methods.	<ul style="list-style-type: none"> <li>Enter the correct motor code to E5-01 [PM Motor Code Selection] as specified by the PM motor.</li> <li>For specialized motors, refer to the motor test report and set E5-xx [PM Motor Settings] correctly.</li> </ul>
		The current flowing in the motor is more than the value set in L8-27 [Overcurrent Detection Gain] for PM Control Methods.	Correct the value set in L8-27.
		The control method is set incorrectly for the motor.	Set A1-02 [Control Method Selection] correctly.
		The motor main circuit cable is too long.	Replace the drive with a larger capacity model.
		Speed search does not complete at start when A1-02 = 8 [EZ Vector Control] and you use an induction motor.	When E9-01 = 0 [Motor Type Selection = Induction (IM)], set b3-24 = 2 [Speed Search Method Selection = Current Detection Speed Search].
		The relay or contactor on the soft-charge bypass relay is damaged.	<ul style="list-style-type: none"> <li>Re-energize the drive.</li> <li>If the fault stays, replace the control board or the drive.</li> </ul>
		An overcurrent condition occurred during overexcitation deceleration.	<ul style="list-style-type: none"> <li>Decrease the value set in n3-13 [OverexcitationBraking (OEB) Gain].</li> <li>Decrease the value set in n3-21 [HSB Current Suppression Level].</li> </ul>
		You are using a premium efficiency motor.	Set these parameters: <ul style="list-style-type: none"> <li>b3-03 [Speed Search Deceleration Time] = default value × 2</li> <li>L2-03 [Minimum Baseblock Time] = default value × 2</li> <li>L2-04 [Powerloss V/f Recovery Ramp Time] = default value × 2</li> </ul>
<b>Note:</b> <ul style="list-style-type: none"> <li>This fault occurs if the drive sensors detect a drive output current more than the specified overcurrent detection level.</li> <li>Do a Fault Reset to clear the fault.</li> </ul>			
Code	Name	Causes	Possible Solutions
OD	Output Disconnect	The output circuit between the drive and the motor is open, and the drive output current is less than 5% of E2-01 [Motor Rated Current (FLA)].	Close the disconnected output circuit between the drive and the motor.
<b>Note:</b> <ul style="list-style-type: none"> <li>Do a Fault Reset to clear the fault.</li> <li>If the drive detects this fault, it will respond as specified by the setting of Y4-42 [Output Disconnect Detection Sel].</li> </ul>			
Code	Name	Causes	Possible Solutions
oFA00	Option Not Compatible with Port	The option card connected to connector CN5 is not compatible.	Connect the option card to the correct connector.
<b>Note:</b> <ul style="list-style-type: none"> <li>Do a Fault Reset to clear the fault.</li> <li>Fault trace is not available for this fault.</li> </ul>			

## 7.4 Fault

Code	Name	Causes	Possible Solutions
oFA01	Option Fault/Connection Error	The option card connected to connector CN5 is not compatible.	<ol style="list-style-type: none"> <li>1. De-energize the drive.</li> <li>2. Refer to the option card manual and correctly connect the option card to the connector on the drive.</li> </ol>
<b>Note:</b> Do a Fault Reset to clear the fault.			
Code	Name	Causes	Possible Solutions
oFA05	Option A/D Error	A fault occurred in the option card.	<ol style="list-style-type: none"> <li>1. De-energize the drive.</li> <li>2. Make sure that the option card is correctly connected to the connector.</li> <li>3. If the problem continues, replace the option card.</li> </ol>
<b>Note:</b> Do a Fault Reset to clear the fault.			
Code	Name	Causes	Possible Solutions
oFA06	Option Communication Error	A fault occurred in the option card.	<ol style="list-style-type: none"> <li>1. De-energize the drive.</li> <li>2. Make sure that the option card is correctly connected to the connector.</li> <li>3. If the problem continues, replace the option card.</li> </ol>
<b>Note:</b> Do a Fault Reset to clear the fault.			
Code	Name	Causes	Possible Solutions
oFA10	Option RAM Error	A fault occurred in the option card.	<ol style="list-style-type: none"> <li>1. De-energize the drive.</li> <li>2. Make sure that the option card is correctly connected to the connector.</li> <li>3. If the problem continues, replace the option card.</li> </ol>
<b>Note:</b> Do a Fault Reset to clear the fault.			
Code	Name	Causes	Possible Solutions
oFA11	Option Ope Mode Error	A fault occurred in the option card.	<ol style="list-style-type: none"> <li>1. De-energize the drive.</li> <li>2. Make sure that the option card is correctly connected to the connector.</li> <li>3. If the problem continues, replace the option card.</li> </ol>
<b>Note:</b> Do a Fault Reset to clear the fault.			
Code	Name	Causes	Possible Solutions
oFA12	Drive Receive CRC Error	A fault occurred in the option card.	<ol style="list-style-type: none"> <li>1. De-energize the drive.</li> <li>2. Make sure that the option card is correctly connected to the connector.</li> <li>3. If the problem continues, replace the option card.</li> </ol>
<b>Note:</b> Do a Fault Reset to clear the fault.			
Code	Name	Causes	Possible Solutions
oFA13	Drive Receive Frame Error	A fault occurred in the option card.	<ol style="list-style-type: none"> <li>1. De-energize the drive.</li> <li>2. Make sure that the option card is correctly connected to the connector.</li> <li>3. If the problem continues, replace the option card.</li> </ol>
<b>Note:</b> Do a Fault Reset to clear the fault.			
Code	Name	Causes	Possible Solutions
oFA14	Drive Receive Abort Error	A fault occurred in the option card.	<ol style="list-style-type: none"> <li>1. De-energize the drive.</li> <li>2. Make sure that the option card is correctly connected to the connector.</li> <li>3. If the problem continues, replace the option card.</li> </ol>
<b>Note:</b> Do a Fault Reset to clear the fault.			

Code	Name	Causes	Possible Solutions
oFA15	Option Receive CRC Error	A fault occurred in the option card.	<ol style="list-style-type: none"> <li>1. De-energize the drive.</li> <li>2. Make sure that the option card is correctly connected to the connector.</li> <li>3. If the problem continues, replace the option card.</li> </ol>
<b>Note:</b> Do a Fault Reset to clear the fault.			
Code	Name	Causes	Possible Solutions
oFA16	Option Receive Frame Error	A fault occurred in the option card.	<ol style="list-style-type: none"> <li>1. De-energize the drive.</li> <li>2. Make sure that the option card is correctly connected to the connector.</li> <li>3. If the problem continues, replace the option card.</li> </ol>
<b>Note:</b> Do a Fault Reset to clear the fault.			
Code	Name	Causes	Possible Solutions
oFA17	Option Receive Abort Error	A fault occurred in the option card.	<ol style="list-style-type: none"> <li>1. De-energize the drive.</li> <li>2. Make sure that the option card is correctly connected to the connector.</li> <li>3. If the problem continues, replace the option card.</li> </ol>
<b>Note:</b> Do a Fault Reset to clear the fault.			
Code	Name	Causes	Possible Solutions
oFA30	COM ID Error	A fault occurred in the option card.	<ol style="list-style-type: none"> <li>1. De-energize the drive.</li> <li>2. Make sure that the option card is correctly connected to the connector.</li> <li>3. If the problem continues, replace the option card.</li> </ol>
<b>Note:</b> Do a Fault Reset to clear the fault.			
Code	Name	Causes	Possible Solutions
oFA31	Type Code Error	A fault occurred in the option card.	<ol style="list-style-type: none"> <li>1. De-energize the drive.</li> <li>2. Make sure that the option card is correctly connected to the connector.</li> <li>3. If the problem continues, replace the option card.</li> </ol>
<b>Note:</b> Do a Fault Reset to clear the fault.			
Code	Name	Causes	Possible Solutions
oFA32	SUM Check Error	A fault occurred in the option card.	<ol style="list-style-type: none"> <li>1. De-energize the drive.</li> <li>2. Make sure that the option card is correctly connected to the connector.</li> <li>3. If the problem continues, replace the option card.</li> </ol>
<b>Note:</b> Do a Fault Reset to clear the fault.			
Code	Name	Causes	Possible Solutions
oFA33	Option Receive Time Over	A fault occurred in the option card.	<ol style="list-style-type: none"> <li>1. De-energize the drive.</li> <li>2. Make sure that the option card is correctly connected to the connector.</li> <li>3. If the problem continues, replace the option card.</li> </ol>
<b>Note:</b> Do a Fault Reset to clear the fault.			
Code	Name	Causes	Possible Solutions
oFA34	Memobus Time Over	A fault occurred in the option card.	<ol style="list-style-type: none"> <li>1. De-energize the drive.</li> <li>2. Make sure that the option card is correctly connected to the connector.</li> <li>3. If the problem continues, replace the option card.</li> </ol>
<b>Note:</b> Do a Fault Reset to clear the fault.			

## 7.4 Fault

Code	Name	Causes	Possible Solutions
oFA35	Drive Receive Time Over 1	A fault occurred in the option card.	<ol style="list-style-type: none"> <li>1. De-energize the drive.</li> <li>2. Make sure that the option card is correctly connected to the connector.</li> <li>3. If the problem continues, replace the option card.</li> </ol>
<b>Note:</b> Do a Fault Reset to clear the fault.			
Code	Name	Causes	Possible Solutions
oFA36	CI Check Error	A fault occurred in the option card.	<ol style="list-style-type: none"> <li>1. De-energize the drive.</li> <li>2. Make sure that the option card is correctly connected to the connector.</li> <li>3. If the problem continues, replace the option card.</li> </ol>
<b>Note:</b> Do a Fault Reset to clear the fault.			
Code	Name	Causes	Possible Solutions
oFA37	Drive Receive Time Over 2	A fault occurred in the option card.	<ol style="list-style-type: none"> <li>1. De-energize the drive.</li> <li>2. Make sure that the option card is correctly connected to the connector.</li> <li>3. If the problem continues, replace the option card.</li> </ol>
<b>Note:</b> Do a Fault Reset to clear the fault.			
Code	Name	Causes	Possible Solutions
oFA38	Control Reference Error	A fault occurred in the option card.	<ol style="list-style-type: none"> <li>1. De-energize the drive.</li> <li>2. Make sure that the option card is correctly connected to the connector.</li> <li>3. If the problem continues, replace the option card.</li> </ol>
<b>Note:</b> Do a Fault Reset to clear the fault.			
Code	Name	Causes	Possible Solutions
oFA39	Drive Receive Time Over 3	A fault occurred in the option card.	<ol style="list-style-type: none"> <li>1. De-energize the drive.</li> <li>2. Make sure that the option card is correctly connected to the connector.</li> <li>3. If the problem continues, replace the option card.</li> </ol>
<b>Note:</b> Do a Fault Reset to clear the fault.			
Code	Name	Causes	Possible Solutions
oFA40	CtrlResSel 1Err	A fault occurred in the option card.	<ol style="list-style-type: none"> <li>1. De-energize the drive.</li> <li>2. Make sure that the option card is correctly connected to the connector.</li> <li>3. If the problem continues, replace the option card.</li> </ol>
<b>Note:</b> Do a Fault Reset to clear the fault.			
Code	Name	Causes	Possible Solutions
oFA41	Drive Receive Time Over 4	A fault occurred in the option card.	<ol style="list-style-type: none"> <li>1. De-energize the drive.</li> <li>2. Make sure that the option card is correctly connected to the connector.</li> <li>3. If the problem continues, replace the option card.</li> </ol>
<b>Note:</b> Do a Fault Reset to clear the fault.			
Code	Name	Causes	Possible Solutions
oFA42	CtrlResSel 2Err	A fault occurred in the option card.	<ol style="list-style-type: none"> <li>1. De-energize the drive.</li> <li>2. Make sure that the option card is correctly connected to the connector.</li> <li>3. If the problem continues, replace the option card.</li> </ol>
<b>Note:</b> Do a Fault Reset to clear the fault.			

Code	Name	Causes	Possible Solutions
oFA43	Drive Receive Time Over 5	A fault occurred in the option card.	<ol style="list-style-type: none"> <li>De-energize the drive.</li> <li>Make sure that the option card is correctly connected to the connector.</li> <li>If the problem continues, replace the option card.</li> </ol>
<b>Note:</b> Do a Fault Reset to clear the fault.			
Code	Name	Causes	Possible Solutions
oH	Heatsink Overheat	The ambient temperature is high and the heatsink temperature of the drive is more than the value set in <i>L8-02 [Overheat Alarm Level]</i> .	<ul style="list-style-type: none"> <li>Measure the ambient temperature.</li> <li>Increase the airflow in the control panel.</li> <li>Install a cooling device (cooling fan or air conditioner) to lower the ambient temperature.</li> <li>Remove objects near the drive that are producing too much heat.</li> </ul>
		The load is too heavy.	<ul style="list-style-type: none"> <li>Measure the output current.</li> <li>Decrease the load.</li> <li>Decrease the value set in <i>C6-02 [Carrier Frequency Selection]</i>.</li> </ul>
		The internal cooling fan of the drive stopped.	<ol style="list-style-type: none"> <li>Use the procedures in this manual to replace the cooling fan.</li> <li>Set <i>o4-03 = 0 [Fan Operation Time Setting = 0 h]</i>.</li> </ol>
<b>Note:</b> <ul style="list-style-type: none"> <li>The drive detects this fault if the heatsink temperature of the drive is more than the value set in <i>L8-02</i>.</li> <li>Do a Fault Reset to clear the fault.</li> <li>If the drive detects this fault, it will operate the motor as specified by the Stopping Method set in <i>L8-03 [Overheat Pre-Alarm Selection]</i>.</li> </ul>			
Code	Name	Causes	Possible Solutions
oH1	Heatsink Overheat	The ambient temperature is high and the heatsink temperature of the drive is more than the <i>oH1</i> detection level.	<ul style="list-style-type: none"> <li>Measure the ambient temperature.</li> <li>Increase the airflow in the control panel.</li> <li>Install a cooling device (cooling fan or air conditioner) to lower the ambient temperature.</li> <li>Remove objects near the drive that are producing too much heat.</li> </ul>
		The load is too heavy.	<ul style="list-style-type: none"> <li>Measure the output current.</li> <li>Decrease the load.</li> <li>Decrease the value set in <i>C6-02 [Carrier Frequency Selection]</i>.</li> </ul>
<b>Note:</b> <ul style="list-style-type: none"> <li>The drive detects this fault if the heatsink temperature of the drive is more than the <i>oH1</i> detection level. <i>o2-04 [Drive Model (KVA) Selection]</i> determines the <i>oH1</i> detection level.</li> <li>Do a Fault Reset to clear the fault.</li> <li><i>L5-08 [Fault Reset Enable Select Grp2]</i> disables the Auto Restart function.</li> </ul>			
Code	Name	Causes	Possible Solutions
oH3	Motor Overheat (PTC Input)	The thermistor wiring that detects motor temperature is defective.	Correct wiring errors.
		A fault occurred on the machine. Example: The machine is locked.	Examine the machine and remove the cause of the fault
		The motor has overheated.	<ul style="list-style-type: none"> <li>Check the load level, acceleration/deceleration time, and motor start/stop frequency (cycle time).</li> <li>Decrease the load.</li> <li>Increase the values set in <i>C1-01 to C1-04 [Acceleration/Deceleration Times]</i>.</li> <li>Set <i>E2-01 [Motor Rated Current (FLA)]</i> correctly to the value specified by the motor nameplate.</li> <li>Make sure that the motor cooling system is operating correctly, and repair or replace it if it is damaged.</li> <li>Adjust <i>E1-04 to E1-10 [V/f Pattern Parameters]</i>. For motor 2, adjust <i>E3-04 to E3-10</i>. Decrease the values set in <i>E1-08 [Mid Point A Voltage]</i> and <i>E1-10 [Minimum Output Voltage]</i>.</li> </ul> <p><b>Note:</b> If the values set in <i>E1-08</i> and <i>E1-10</i> are too low, the overload tolerance will decrease at low speeds.</p>
<b>Note:</b> <ul style="list-style-type: none"> <li>When <i>H3-02</i> or <i>H3-10 = E [MFAI Function Selection = Motor Temperature (PTC Input)]</i>, the drive detects this fault if the motor overheat signal entered to analog input terminals A1 or A2 is more than the alarm detection level.</li> <li>Do a Fault Reset to clear the fault.</li> <li>If the drive detects this fault, it will operate the motor as specified by the Stopping Method set in <i>L1-03 [Motor Thermistor oH Alarm Select]</i>.</li> </ul>			

## 7.4 Fault

Code	Name	Causes	Possible Solutions
oH4	Motor Overheat Fault (PTC Input)	The motor has overheated.	<ul style="list-style-type: none"> <li>Check the load level, acceleration/deceleration time, and motor start/stop frequency (cycle time).</li> <li>Decrease the load.</li> <li>Increase the values set in C1-01 to C1-04 [Acceleration/Deceleration Times].</li> <li>Set E2-01 [Motor Rated Current (FLA)] correctly to the value specified by the motor nameplate.</li> <li>Make sure that the motor cooling system is operating correctly, and repair or replace it if it is damaged.</li> <li>Adjust E1-04 to E1-10 [V/f Pattern Parameters]. For motor 2, adjust E3-04 to E3-10. Decrease the values set in E1-08 [Mid Point A Voltage] and E1-10 [Minimum Output Voltage].</li> </ul> <p><b>Note:</b> If E1-08 and E1-10 are set too low, the overload tolerance will decrease at low speeds.</p>
<p><b>Note:</b></p> <ul style="list-style-type: none"> <li>The drive detects this fault if the motor overheat signal that was entered to an analog input terminals A1 or A2 is more than the alarm detection level. (If H3-02 or H3-10 = E [MFAI Function Select = Motor Temperature (PTC Input)] was set.)</li> <li>Do a Fault Reset to clear the fault.</li> </ul>			
Code	Name	Causes	Possible Solutions
oL1	Motor Overload	The load is too heavy.	Decrease the load. <p><b>Note:</b> Reset oL1 when U4-16 [Motor oL1 Level] &lt; 100.</p>
		The acceleration/deceleration times or cycle times are too short.	<ul style="list-style-type: none"> <li>Examine the acceleration/deceleration times and the motor start/stop frequencies (cycle times).</li> <li>Increase the values set in C1-01 to C1-04 [Acceleration/Deceleration Times].</li> </ul>
		Overload occurred while running at low speed.	<ul style="list-style-type: none"> <li>Decrease the load when running at low speed.</li> <li>Increase the motor speed.</li> <li>If the motor is run frequently at low speeds, replace the motor with a larger motor or use a drive-dedicated motor.</li> </ul> <p><b>Note:</b> For general-purpose motors, overload can occur while running at low speed when operating at below the rated current.</p>
		L1-01 [Motor Overload (oL1) Protection] is set incorrectly.	Set L1-01 in as specified by the motor qualities for a drive-dedicated motor.
		The V/f pattern does not fit the motor qualities.	<ul style="list-style-type: none"> <li>Examine the ratios between the V/f pattern frequency and voltage. Decrease the voltage if it is too high compared to the frequency.</li> <li>Adjust E1-04 to E1-10 [V/f Pattern Parameters]. For motor 2, adjust E3-04 to E3-10. Decrease the values set in E1-08 [Mid Point A Voltage] and E1-10 [Minimum Output Voltage].</li> </ul> <p><b>Note:</b> If the values set in E1-08 and E1-10 are too low, the overload tolerance will decrease at low speeds.</p>
		E1-06 [Base Frequency] is set incorrectly.	Set E1-06 to the rated frequency shown on the motor nameplate.
		One drive is operating more than one motor.	Set L1-01 = 0 [Motor Overload (oL1) Protection = Disabled], connect thermal overload relay to each motor to prevent damage to the motor.
		The electronic thermal protector qualities and the motor overload properties do not align.	<ul style="list-style-type: none"> <li>Examine the motor qualities and set L1-01 [Motor Overload (oL1) Protection] correctly.</li> <li>Connect a thermal overload relay to the motor.</li> </ul>
		The electronic thermal protector is operating at an incorrect level.	Set E2-01 [Motor Rated Current (FLA)] correctly to the value specified by the motor nameplate.
		There is increased motor loss from overexcitation operation.	<ul style="list-style-type: none"> <li>Lower the value set in n3-13 [OverexcitationBraking (OEB) Gain].</li> <li>Set L3-04 ≠ 4 [Stall Prevention during Decel ≠ Overexcitation/High Flux].</li> <li>Set n3-23 = 0 [Overexcitation Braking Operation = Disabled].</li> </ul>
The speed search-related parameters are set incorrectly.	<ul style="list-style-type: none"> <li>Examine the settings for all speed search related parameters.</li> <li>Adjust b3-03 [Speed Search Deceleration Time].</li> <li>Set b3-24 = 1 [Speed Search Method Selection = Speed Estimation] after Auto-Tuning.</li> </ul>		
Phase loss in the input power supply is causing the output current to change.	Make sure that there is no phase loss, and repair problems.		



Code	Name	Causes	Possible Solutions
		Overload occurred during overexcitation deceleration.	<ul style="list-style-type: none"> <li>Decrease the value set in <i>n3-13 [OverexcitationBraking (OEB) Gain]</i>.</li> <li>Decrease the value set in <i>n3-21 [HSB Current Suppression Level]</i>.</li> </ul>
<p><b>Note:</b></p> <ul style="list-style-type: none"> <li>The drive detects this fault if the electronic thermal protector of the drive started the motor overload protection.</li> <li>Do a Fault Reset to clear the fault.</li> <li><i>L5-07 [Fault Reset Enable Select Grp1]</i> disables the Auto Restart function.</li> </ul>			
Code	Name	Causes	Possible Solutions
oL2	Drive Overload	The load is too large.	Decrease the load.
		The acceleration/deceleration times or cycle times are too short.	<ul style="list-style-type: none"> <li>Examine the acceleration/deceleration times and the motor start/stop frequencies (cycle times).</li> <li>Increase the values set in <i>C1-01 to C1-04 [Acceleration/Deceleration Times]</i>.</li> </ul>
		The V/f pattern does not fit the motor qualities.	<ul style="list-style-type: none"> <li>Examine the ratios between the V/f pattern frequency and voltage. Decrease the voltage if it is too high compared to the frequency.</li> <li>Adjust <i>E1-04 to E1-10 [V/f Pattern Parameters]</i>. Decrease the values set in <i>E1-08 [Mid Point A Voltage]</i> and <i>E1-10 [Minimum Output Voltage]</i>. For motor 2, adjust <i>E3-04 to E3-10</i>.</li> </ul> <p><b>Note:</b> If the values set in <i>E1-08</i> and <i>E1-10</i> are too low, the overload tolerance will decrease at low speeds.</p>
		The drive capacity is too small.	Replace the drive with a larger capacity model.
		Overload occurred while running at low speed.	<ul style="list-style-type: none"> <li>Decrease the load when running at low speed.</li> <li>Replace the drive with a larger capacity model.</li> <li>Decrease the value set in <i>C6-02 [Carrier Frequency Selection]</i>.</li> </ul>
		The torque compensation gain is too large.	Decrease the value set in <i>C4-01 [Torque Compensation Gain]</i> to make sure that the motor does not stall.
		The speed search-related parameters are set incorrectly.	<ul style="list-style-type: none"> <li>Examine the settings for all speed search-related parameters.</li> <li>Adjust <i>b3-03 [Speed Search Deceleration Time]</i>.</li> <li>Set <i>b3-24 = 1 [Speed Search Method Selection = Speed Estimation]</i> after Auto-Tuning.</li> </ul>
		Phase loss in the input power supply is causing the output current to change.	<ul style="list-style-type: none"> <li>Correct errors with the wiring for main circuit drive input power.</li> <li>Make sure that there is no phase loss, and repair problems.</li> </ul>
		Overload occurred during overexcitation deceleration.	<ul style="list-style-type: none"> <li>Decrease the value set in <i>n3-13 [OverexcitationBraking (OEB) Gain]</i>.</li> <li>Decrease the value set in <i>n3-21 [HSB Current Suppression Level]</i>.</li> </ul>
<p><b>Note:</b></p> <ul style="list-style-type: none"> <li>The drive detects this fault if the electronic thermal protector of the drive started the drive overload protection.</li> <li>Do a Fault Reset to clear the fault.</li> <li><i>L5-07 [Fault Reset Enable Select Grp1]</i> disables the Auto Restart function.</li> </ul>			
Code	Name	Causes	Possible Solutions
oL3	Overtorque Detection 1	A fault occurred on the machine. Example: The machine is locked.	Examine the machine and remove the cause of the fault.
		The parameters are incorrect for the load.	Adjust <i>L6-02 [Torque Detection Level 1]</i> and <i>L6-03 [Torque Detection Time 1]</i> settings.
<p><b>Note:</b></p> <ul style="list-style-type: none"> <li>The drive detects this fault if the drive output current is more than the level set in <i>L6-02</i> for longer than <i>L6-03</i>.</li> <li>Do a Fault Reset to clear the fault.</li> <li>If the drive detects this fault, it will operate the motor as specified by the Stopping Method set in <i>L6-01 [Torque Detection Selection 1]</i>.</li> <li><i>L5-07 [Fault Reset Enable Select Grp1]</i> disables the Auto Restart function.</li> </ul>			
Code	Name	Causes	Possible Solutions
oL4	Overtorque Detection 2	A fault occurred on the machine. Example: The machine is locked.	Examine the machine and remove the cause of the fault.
		The parameters are incorrect for the load.	Adjust <i>L6-05 [Torque Detection Level 2]</i> and <i>L6-06 [Torque Detection Time 2]</i> settings.
<p><b>Note:</b></p> <ul style="list-style-type: none"> <li>The drive detects this fault if the drive output current is more than the level set in <i>L6-05</i> for longer than <i>L6-06</i>.</li> <li>Do a Fault Reset to clear the fault.</li> <li>If the drive detects this fault, it will operate the motor as specified by the Stopping Method set in <i>L6-04 [Torque Detection Selection 2]</i>.</li> <li><i>L5-07 [Fault Reset Enable Select Grp1]</i> disables the Auto Restart function.</li> </ul>			

## 7.4 Fault

Code	Name	Causes	Possible Solutions
oL7	High Slip Braking Overload	The load inertia is too large.	Decrease deceleration times in <i>C1-02</i> and <i>C1-04</i> [Deceleration Times] for applications that do not use High Slip Braking.
		An external force on the load side rotated the motor.	
		Something is preventing deceleration on the load side.	
		The value set in <i>n3-04</i> [HSB Overload Time] is too small.	<ul style="list-style-type: none"> <li>Increase the value set in <i>n3-04</i>.</li> <li>Connect a thermal overload relay to the motor, and set <i>n3-04</i> = 1200 s (maximum value).</li> </ul>
<b>Note:</b> <ul style="list-style-type: none"> <li>The drive detects this fault if the output frequency is constant for longer than <i>n3-04</i>.</li> <li>Do a Fault Reset to clear the fault.</li> </ul>			
Code	Name	Causes	Possible Solutions
oPr	Keypad Connection Fault	The keypad is not securely connected to the connector on the drive.	Examine the connection between the keypad and the drive.
		The connection cable between the drive and the keypad is disconnected.	<ul style="list-style-type: none"> <li>Remove the keypad and connect it again.</li> <li>If the cable is damaged, replace it.</li> </ul>
<b>Note:</b> <ul style="list-style-type: none"> <li>The drive detects this fault if these conditions are correct: <ul style="list-style-type: none"> <li><i>-o2-06</i> = 1 [Keypad Disconnect Detection = Enabled].</li> <li><i>-b1-02</i> = 0 [Run Command Selection 1 = Keypad], or the drive is operating in HAND Mode with the keypad.</li> </ul> </li> <li>Do a Fault Reset to clear the fault.</li> </ul>			
Code	Name	Causes	Possible Solutions
oS	Overspeed	There is overshoot.	Decrease <i>C5-01</i> [ASR Proportional Gain 1] and increase <i>C5-02</i> [ASR Integral Time 1].
<b>Note:</b> <ul style="list-style-type: none"> <li>Do a Fault Reset to clear the fault.</li> </ul>			
Code	Name	Causes	Possible Solutions
ov	Overvoltage	Deceleration time is too short and regenerative energy is flowing from the motor into the drive.	<ul style="list-style-type: none"> <li>Set <i>L3-04</i> = 1 [Stall Prevention during Decel = General Purpose].</li> <li>Increase the values set in <i>C1-02</i> or <i>C1-04</i> [Deceleration Times].</li> <li>Perform Deceleration Rate Auto-Tuning.</li> </ul>
		The acceleration time is too short.	<ul style="list-style-type: none"> <li>Make sure that sudden drive acceleration does not cause the fault.</li> <li>Increase the values set in <i>C1-01</i> or <i>C1-03</i> [Acceleration Times].</li> <li>Increase the value set in <i>C2-02</i> [S-Curve Time @ End of Accel].</li> <li>Set <i>L3-11</i> = 1 [Overvoltage Suppression Select = Enabled].</li> </ul>
		The drive output cable or motor is shorted to ground (the current short to ground is charging the main circuit capacitor of the drive through the power supply).	<ol style="list-style-type: none"> <li>Examine the motor main circuit cable, terminals, and motor terminal box, and then remove ground faults.</li> <li>Re-energize the drive.</li> </ol>
		If the drive detects <i>ov</i> in these conditions, the speed search-related parameters are incorrect: <ul style="list-style-type: none"> <li>During speed search</li> <li>During momentary power loss recovery</li> <li>When the drive starts again automatically</li> <li>When you set <i>A1-02</i> = 0 [Control Method Selection = V/f Control] and do rotational Auto-Tuning</li> <li>You are using a premium efficiency motor</li> </ul>	<ul style="list-style-type: none"> <li>Examine the settings for all speed search related parameters.</li> <li>Set <i>b3-19</i> ≠ 0 [Speed Search Restart Attempts ≠ 0 times].</li> <li>Adjust <i>b3-03</i> [Speed Search Deceleration Time] setting.</li> <li>Do Stationary Auto-Tuning for Line-to-Line Resistance and then set <i>b3-24</i> = 1 [Speed Search Method Selection = Speed Estimation].</li> <li>Increase the value set in <i>L2-04</i> [Powerloss V/f Recovery Ramp Time].</li> <li>Set these parameters: <ul style="list-style-type: none"> <li><i>b3-03</i> [Speed Search Deceleration Time] = default value × 2</li> <li><i>L2-03</i> [Minimum Baseblock Time] = default value × 2</li> <li><i>L2-04</i> [Powerloss V/f Recovery Ramp Time] = default value × 2</li> </ul> </li> </ul>
		The power supply voltage is too high.	Decrease the power supply voltage to align with the drive rated voltage.
		Electrical interference caused a drive malfunction.	<ul style="list-style-type: none"> <li>Examine the control circuit lines, main circuit lines, and ground wiring, and decrease the effects of electrical interference.</li> <li>Make sure that a magnetic contactor is not the source of the electrical interference, then use a Surge Protective Device if necessary.</li> </ul>
		The load inertia is set incorrectly.	<ul style="list-style-type: none"> <li>Examine the load inertia settings with KEB, overvoltage suppression, or stall prevention during deceleration.</li> <li>Adjust <i>L3-25</i> [Load Inertia Ratio] to align with the qualities of the machine.</li> </ul>

Code	Name	Causes	Possible Solutions
		There is motor hunting.	<ul style="list-style-type: none"> <li>Adjust <i>n1-02</i> [<i>Hunting Prevention Gain Setting</i>] settings.</li> <li>Adjust <i>n8-45</i> [<i>Speed Feedback Detection Gain</i>] and <i>n8-47</i> [<i>Pull-in Current Comp Filter Time</i>] settings.</li> </ul>
		Speed search does not complete at start when you use an induction motor in EZOLV control.	When <i>E9-01</i> = 0 [ <i>Motor Type Selection = Induction (IM)</i> ], set <i>b3-24</i> = 2 [ <i>Speed Search Method Selection = Current Detection 2</i> ].
<b>Note:</b> <ul style="list-style-type: none"> <li>The drive detects this error if the DC bus voltage is more than the <i>ov</i> detection level while the drive is running.</li> <li>The <i>ov</i> detection level is approximately 410 V with 208 V class drives. The detection level is approximately 820 V with 480 V class drives.</li> <li>Do a Fault Reset to clear the fault.</li> <li>Parameter <i>L5-08</i> [<i>Fault Reset Enable Select Grp2</i>] disables the Auto Restart function.</li> </ul>			
Code	Name	Causes	Possible Solutions
ov2	DC Bus Overvoltage 2	The wiring is too long and DC bus voltage is too large.	<ul style="list-style-type: none"> <li>Shorten the shielded motor cable.</li> <li>Decrease the carrier frequency.</li> <li>If the power supply has a neutral ground, switch on the internal EMC filter.</li> </ul>
<b>Note:</b> <ul style="list-style-type: none"> <li>The drive detects this fault when the DC bus voltage increases to more than the Stall Prevention Level during Deceleration for the time set in <i>S6-23</i> [<i>OV2 Detect Time</i>].</li> <li>Do a Fault Reset to clear the fault.</li> <li>This fault is resettable, but will not auto-restart.</li> </ul>			
Code	Name	Causes	Possible Solutions
PE1	PLC Fault 1	The communication option detected a fault.	Refer to the manual for the communication option card.
<b>Note:</b> Do a Fault Reset to clear the fault.			
Code	Name	Causes	Possible Solutions
PE2	PLC Fault 2	The communication option detected a fault.	Refer to the manual for the communication option card.
<b>Note:</b> Do a Fault Reset to clear the fault.			
Code	Name	Causes	Possible Solutions
PF	Input Phase Loss	There is a phase loss in the drive input power.	Correct errors with the wiring for main circuit drive input power.
		There is loose wiring in the drive input power terminals.	Tighten the terminal screws to the correct tightening torque.
		The drive input power voltage is changing too much.	<ul style="list-style-type: none"> <li>Examine the input power for problems.</li> <li>Make the drive input power stable.</li> <li>If the input power supply is good, examine the magnetic contactor on the main circuit side for problems.</li> </ul>
		There is unsatisfactory balance between voltage phases.	<ul style="list-style-type: none"> <li>Examine the input power for problems.</li> <li>Make the drive input power stable.</li> <li>Set <i>L8-05</i> = 0 [<i>Input Phase Loss Protection Sel = Disabled</i>].</li> </ul>
		The main circuit capacitors have become unserviceable.	<ul style="list-style-type: none"> <li>Examine the capacitor maintenance time in monitor <i>U4-05</i> [<i>Capacitor Maintenance</i>]. If <i>U4-05</i> is more than 90%, replace the control board or the drive. For information about replacing the control board, contact Yaskawa or your nearest sales representative.</li> <li>If drive input power is correct and the fault stays, replace the control board or the drive. For information about replacing the control board, contact Yaskawa or your nearest sales representative.</li> </ul>
<b>Note:</b> <ul style="list-style-type: none"> <li>The drive detects this error if the DC bus voltage changes irregularly without regeneration.</li> <li>Do a Fault Reset to clear the fault.</li> <li>Use <i>L8-05</i> to enable and disable <i>PF</i> detection.</li> </ul>			
Code	Name	Causes	Possible Solutions
SC	Short Circuit/IGBT Failure	Overheating caused damage to the motor or the motor insulation is not satisfactory.	Measure the motor insulation resistance, and replace the motor if there is electrical conduction or unserviceable insulation.
		The motor main circuit cable is contacting ground to make a short circuit.	<ul style="list-style-type: none"> <li>Examine the motor main circuit cable for damage, and repair short circuits.</li> <li>Measure the resistance between the motor main circuit cable and the ground terminal. If there is electrical conduction, replace the cable.</li> </ul>
		A short circuit or ground fault on the drive output side caused damage to the output transistor of the drive.	<ul style="list-style-type: none"> <li>Make sure that there is not a short circuit in terminals +1 and terminals U/T1, V/T2, and W/T3. Make sure that there is not a short circuit in terminals - and terminals U/T1, V/T2, and W/T3.</li> <li>If there is a short circuit, contact Yaskawa or your nearest sales representative.</li> </ul>

## 7.4 Fault

Code	Name	Causes	Possible Solutions
		When $A1-02 = 5$ [Control Method Selection = OLV/PM], the output current is more than the value set in $L8-27$ [Overcurrent Detection Gain].	Set $L8-27$ correctly.
<b>Note:</b> <ul style="list-style-type: none"> <li>The drive detects this error if there is a short circuit or ground fault on the drive output side, or an IGBT failure.</li> <li>Do a Fault Reset to clear the fault.</li> </ul>			
Code	Name	Causes	Possible Solutions
SCF	Safety Circuit Fault	The safety circuit is broken.	Replace the control board or the drive. For information about replacing the control board, contact Yaskawa or your nearest sales representative.
<b>Note:</b> <ul style="list-style-type: none"> <li>Do a Fault Reset to clear the fault.</li> </ul>			
Code	Name	Causes	Possible Solutions
SEr	Speed Search Retries Exceeded	The speed search-related parameters are set incorrectly.	<ul style="list-style-type: none"> <li>Decrease <math>b3-10</math> [Speed Estimation Detection Gain].</li> <li>Increase <math>b3-17</math> [Speed Est Retry Current Level].</li> <li>Increase <math>b3-18</math> [Speed Est Retry Detection Time].</li> <li>Do Auto-Tuning again.</li> </ul>
		The motor is coasting in the opposite direction of the Run command.	Set $b3-14 = 1$ [Bi-directional Speed Search = Enabled].
<b>Note:</b> <ul style="list-style-type: none"> <li>The drive detects this error if the number of speed search restarts is more than <math>b3-19</math> [Speed Search Restart Attempts].</li> <li>Do a Fault Reset to clear the fault.</li> </ul>			
Code	Name	Causes	Possible Solutions
STPo	Motor Step-Out Detected	The motor code is set incorrectly for PM Control Methods.	<ul style="list-style-type: none"> <li>Set <math>E5-01</math> [PM Motor Code Selection] correctly as specified by the motor.</li> <li>For specialized motors, refer to the motor test report and set <math>E5-xx</math> correctly.</li> </ul>
		The load is too large.	<ul style="list-style-type: none"> <li>Increase the value set in <math>n8-55</math> [Motor to Load Inertia Ratio].</li> <li>Increase the value set in <math>n8-51</math> [Pull-in Current @ Acceleration]. If the drive detects STPo during deceleration when increasing the value set in <math>n8-51</math>, set the value of <math>n8-79</math> [Pull-in Current @ Deceleration] lower than <math>n8-51</math>.</li> <li>Decrease the load.</li> <li>Replace the drive and motor with larger capacity models.</li> </ul>
		The load inertia is too large.	Increase the value set in $n8-55$ .
		The acceleration/deceleration times are too short.	<ul style="list-style-type: none"> <li>Increase the values set in <math>C1-01</math> to <math>C1-04</math> [Acceleration/Deceleration Times].</li> <li>Increase the value set in <math>C2-01</math> [S-Curve Time @ Start of Accel].</li> </ul>
		Speed response is too slow.	Increase the value set in $n8-55$ .
<b>Note:</b> <ul style="list-style-type: none"> <li>Do a Fault Reset to clear the fault.</li> </ul>			
Code	Name	Causes	Possible Solutions
TiM	Keypad Time Not Set	There is a battery in the keypad, but the date and time are not set.	Use the keypad to set the date and time.
<b>Note:</b> <ul style="list-style-type: none"> <li>Do a Fault Reset to clear the fault.</li> <li>Parameter <math>o4-24</math> [bAT Detection Selection] enables and disables <math>TiM</math> detection.</li> </ul>			
Code	Name	Causes	Possible Solutions
UL3	Undertorque Detection 1	A fault occurred on the machine. Example: There is a broken pulley belt.	Examine the machine and remove the cause of the fault.
		The parameters are incorrect for the load.	Adjust $L6-02$ [Torque Detection Level 1] and $L6-03$ [Torque Detection Time 1] settings.
<b>Note:</b> <ul style="list-style-type: none"> <li>The drive detects this error if the drive output current is less than the level set in <math>L6-02</math> for longer than <math>L6-03</math>.</li> <li>Do a Fault Reset to clear the fault.</li> <li>If the drive detects this error, it will operate the motor as specified by the Stopping Method set in <math>L6-01</math> [Torque Detection Selection 1].</li> </ul>			

Code	Name	Causes	Possible Solutions
UL4	Undertorque Detection 2	A fault occurred on the machine. Example: There is a broken pulley belt.	Examine the machine and remove the cause of the fault.
		The parameters are incorrect for the load.	Adjust L6-05 [Torque Detection Level 2] and L6-06 [Torque Detection Time 2] settings.
<b>Note:</b> <ul style="list-style-type: none"> <li>The drive detects this error if the drive output current is less than the level set in L6-05 for longer than L6-06.</li> <li>Do a Fault Reset to clear the fault.</li> <li>If the drive detects this error, it will operate the motor as specified by the Stopping Method set in L6-04 [Torque Detection Selection 2].</li> </ul>			
Code	Name	Causes	Possible Solutions
UL6	Underload or Belt Break Detected	The output current decreased less than the motor underload curve set in L6-14 [Motor Underload Level @ Min Freq] for longer than the time set in L6-03 [Torque Detection Time 1].	Adjust the L6-14 setting to set the output current to stay the level more than the motor underload curve during usual operations.
<b>Note:</b> Do a Fault Reset to clear the fault.			
Code	Name	Causes	Possible Solutions
Uv1	DC Bus Undervoltage	There is a phase loss in the drive input power.	Correct errors with the wiring for main circuit drive input power.
		There is loose wiring in the drive input power terminals.	Tighten the terminal screws to the correct tightening torque.
		The drive input power voltage is changing too much.	<ul style="list-style-type: none"> <li>Examine the input power for problems.</li> <li>Make the drive input power stable.</li> <li>If the input power supply is good, examine the magnetic contactor on the main circuit side for problems.</li> </ul>
		There was a loss of power.	Use a better power supply.
		The main circuit capacitors have become unserviceable.	Examine the capacitor maintenance time in monitor U4-05 [Capacitor Maintenance]. If U4-05 is more than 90%, replace the control board or the drive. For information about replacing the control board, contact Yaskawa or your nearest sales representative.
		The relay or contactor on the soft-charge bypass relay is damaged.	U4-06 [PreChargeRelayMainte] shows the performance life of the soft-charge bypass relay. If U4-06 is more than 90%, replace the board or the drive. For information about replacing the board, contact Yaskawa or your nearest sales representative.
<b>Note:</b> <ul style="list-style-type: none"> <li>The drive detects this error if the DC bus voltage decreases below the level set in L2-05 [Undervoltage Detection Lvl (Uv1)] while the drive is running.</li> <li>The Uv1 detection level is approximately 190 V for a 208 V class drives. The detection level is approximately 380 V for 480 V class drives. The detection level is approximately 350 V when E1-01 [Input AC Supply Voltage] &lt; 400.</li> <li>Do a Fault Reset to clear the fault.</li> <li>Fault trace is not available for this fault.</li> <li>L5-08 [Fault Reset Enable Select Grp2] disables the Auto Restart function.</li> </ul>			
Code	Name	Causes	Possible Solutions
Uv2	Control Power Undervoltage	The value set in L2-02 [Power Loss Ride Through Time] increased and the momentary power loss recovery unit is not connected to the drive.	Connect the momentary power loss recovery unit to the drive.
		There was a problem with the drive hardware.	<ul style="list-style-type: none"> <li>Re-energize the drive.</li> <li>If the fault stays, replace the control board or the drive. For information about replacing the control board, contact Yaskawa or your nearest sales representative.</li> </ul>
<b>Note:</b> <ul style="list-style-type: none"> <li>The drive detects this error if the control power supply voltage decreases.</li> <li>Do a Fault Reset to clear the fault.</li> <li>Fault trace is not available for this fault.</li> </ul>			
Code	Name	Causes	Possible Solutions
Uv3	Soft Charge Answerback Fault	The relay or contactor on the soft-charge bypass relay is damaged.	<ul style="list-style-type: none"> <li>Re-energize the drive.</li> <li>If the fault stays, replace the control board or the drive.</li> <li>Check monitor U4-06 [PreChargeRelayMainte], which shows the performance life of the soft-charge bypass relay. If U4-06 is more than 90%, replace the board or the drive. For information about replacing the board, contact Yaskawa or your nearest sales representative.</li> </ul>
		Air inside the drive is too hot.	Check the ambient temperature of the drive.
<b>Note:</b> <ul style="list-style-type: none"> <li>Do a Fault Reset to clear the fault.</li> <li>Fault trace is not available for this fault.</li> </ul>			

## 7.4 Fault

---

Code	Name	Causes	Possible Solutions
VLTS	Thermostat Fault	The digital input from the terminal set for <i>Thermostat Fault</i> [ <i>H1-xx = 88</i> ] is active.	Examine the wiring or wait for the motor to cool.
<b>Note:</b> <ul style="list-style-type: none"><li>• Do a Fault Reset to clear the fault.</li><li>• Parameter <i>L5-53</i> [<i>Thermostat Fault Retry Selection</i>] sets the Auto Restart function of this fault.</li></ul>			

## 7.5 Minor Faults/Alarms

This section gives information about the causes and possible solutions when a minor fault or alarm occurs. Use the information in this table to remove the cause of the minor fault or alarm.

Code	Name	Causes	Possible Solutions
AFBL	Analog Fbk Lost, Switched to Net	The analog input source is defective or broken.	<ul style="list-style-type: none"> <li>Make sure that you install the PID Feedback source and it operates correctly.</li> <li>If the drive does not have an analog PID Feedback source, set <math>Y9-02 = 3</math> [<i>System Feedback Source = Network Only</i>] to set the drive to read the network PID Feedback from another drive.</li> </ul>
		The parameter setting is $H3-xx \neq B$ [ <i>MFAI Function Selection <math>\neq</math> PID Feedback</i> ].	<ul style="list-style-type: none"> <li>Set <math>H3-xx = B</math> to use the analog input source for PID Feedback.</li> <li>If the drive does not have an analog PID Feedback source, set <math>Y9-02 = 3</math>.</li> </ul>
<b>Note:</b> If the drive detects this error, the terminal set to $H2-01$ to $H2-03 = 10$ [ <i>MFDO Function Selection = Alarm</i> ] will activate.			
Code	Name	Causes	Possible Solutions
AuDis	Low PI Aux Fdbk Drive Disabled	<ul style="list-style-type: none"> <li>Parameter setting of <math>Y9-51 = 1</math> [<i>PI Aux Control Turn-Off Method = Enabled</i>] does not let the drive operate in Memobus Multiplex.</li> <li>PI Auxiliary Feedback is less than the <math>YF-06</math> [<i>PI Aux Control Wake-up Level</i>] setting, and the drive is stopped or running as a Lag drive.</li> </ul>	<ul style="list-style-type: none"> <li>Make sure that the <math>YF-06</math> setting is correct.</li> <li>Wait for the PI Auxiliary Feedback to recover.</li> </ul>
<b>Note:</b> If the drive detects this error, the terminal set to $H2-01$ to $H2-03 = 10$ [ <i>MFDO Function Selection = Alarm</i> ] will activate.			
Code	Name	Causes	Possible Solutions
AUXFB	PI Aux Feedback Level Loss	The analog input from the terminal set to $H3-xx = 27$ [ <i>MFAI Function Selection = PI Auxiliary Control Feedback Level</i> ] is more than 21 mA or less than 3 mA for longer than 1 s.	Repair transducer or wiring.
<b>Note:</b> If the drive detects this error, the terminal set to $H2-01$ to $H2-03 = 10$ [ <i>MFDO Function Selection = Alarm</i> ] will activate.			
Code	Name	Causes	Possible Solutions
AuFbl	PI Aux Fdbk Lost Switched to Net	The analog input source is defective or broken.	<ul style="list-style-type: none"> <li>Make sure that you install the Auxiliary PI Feedback source and it operates correctly.</li> <li>Make sure that the <math>YF-19</math> [<i>PI Aux Ctrl Feedback WireBreak</i>] setting is correct.</li> <li>If there is no analog feedback, set <math>Y9-50 = 3</math> [<i>PI Auxiliary Control Source = Network Only</i>] to set the drive to read the network Auxiliary PI Feedback from another drive.</li> </ul>
<b>Note:</b> <ul style="list-style-type: none"> <li>The drive detects this error if it detected a wire-break with the <i>PI Auxiliary Control Feedback</i> [<math>H3-xx = 27</math>] analog signal and it uses PI Auxiliary Feedback.</li> <li>If the drive detects this error, the terminal set to <math>H2-01</math> to <math>H2-03 = 10</math> [<i>MFDO Function Selection = Alarm</i>] will activate.</li> </ul>			
Code	Name	Causes	Possible Solutions
bAT	Keypad Battery Low Voltage	The keypad battery voltage is low.	Replace the keypad battery.
<b>Note:</b> <ul style="list-style-type: none"> <li>If the drive detects this error, the terminal set to <math>H2-01</math> to <math>H2-03 = 10</math> [<i>MFDO Function Selection = Alarm</i>] will activate.</li> <li>Set <math>o4-24</math> [<i>bAT Detection Selection</i>] to enable/disable <i>bAT</i> detection.</li> </ul>			
Code	Name	Causes	Possible Solutions
bb	Baseblock	An external baseblock command was entered through one of the MFDI terminals $Sx$ , and the drive output stopped as shown by an external baseblock command.	Examine the external sequence and timing of the baseblock command input.
<b>Note:</b> The drive will not output a minor fault signal for this alarm.			
Code	Name	Causes	Possible Solutions
bCE	Bluetooth Communication Error	The smartphone or tablet with DriveWizard Mobile is too far from the keypad.	Move to 10 m (32.8 ft) or less from the keypad.  <b>Note:</b> <i>bCE</i> can occur when the smartphone or tablet is 10 m (32.8 ft) or nearer to the keypad for different smartphone and tablet specifications.
		Radio waves from a different device are causing interference with communications between the smartphone or tablet and keypad.	Make sure that no device around the keypad uses the same radio bandwidth (2400 MHz to 2480 MHz), and prevent radio interference.
<b>Note:</b> <ul style="list-style-type: none"> <li>The drive detects this error when you use a smartphone or tablet and a Bluetooth HOA keypad to operate the drive.</li> <li>If the drive detects this error, the terminal set to <math>H2-01</math> to <math>H2-03 = 10</math> [<i>MFDO Function Selection = Alarm</i>] will activate.</li> <li>Use <math>o2-27</math> [<i>bCE Detection selection</i>] to enable and disable <i>bCE</i> detection.</li> </ul>			

## 7.5 Minor Faults/Alarms

Code	Name	Causes	Possible Solutions
BuDif	Main Fdbk Lost, Using Diff Fdbk	Parameter $Y4-41 = 1$ [ <i>Diff Lvl Src Fdbk Backup Select = Enabled</i> ] and the drive detected a wire-break on the analog input terminal set for <i>PID Feedback</i> [ $H3-xx = B$ ].	Examine the connection of the Main PID Feedback Transducer.
		Main PID Feedback Transducer is broken.	Replace Main PID Feedback Transducer.
<b>Note:</b> <ul style="list-style-type: none"> <li>The drive detects this error if it does not receive the <i>PID Feedback</i> signal and it uses <i>Differential Feedback</i> [<math>H3-xx = 2D</math>] as backup.</li> <li>If the drive detects this error, the terminal set to <math>H2-01</math> to <math>H2-03 = 10</math> [<i>MFDO Function Selection = Alarm</i>] will activate.</li> </ul>			
Code	Name	Causes	Possible Solutions
Bu-Fb	Main Fdbk Lost Using Backup Fdbk	The drive detected wire-break on the analog input terminal set to $H3-xx = B$ [ <i>MFAI Function Selection = PID Feedback</i> ].	Examine the connection of the Main PID Feedback Transducer.
		Main PID Feedback Transducer is broken.	Replace Main PID Feedback Transducer.
<b>Note:</b> <ul style="list-style-type: none"> <li>If the drive detects this error, the terminal set to <math>H2-01</math> to <math>H2-03 = 10</math> [<i>MFDO Function Selection = Alarm</i>] will activate.</li> </ul>			
Code	Name	Causes	Possible Solutions
BuFbl	Backup Fdbk Lost Chk/Repl Xducer	The drive detected wire-break on the analog input terminal set for <i>PID Feedback Backup</i> [ $H3-xx = 24$ ].	Examine the connection of the Differential PID Feedback transducer.
		Backup PID Feedback Transducer is broken.	Replace Backup PID Feedback Transducer.
		Parameter $Y4-41 = 1$ [ <i>Diff Lvl Src Fdbk Backup Select = Enabled</i> ] and the drive detected a wire-break on the analog input terminal set for <i>Differential Level Source</i> [ $H3-xx = 2D$ ].	Examine the connection of the Differential PID Feedback transducer.
		Parameter $Y4-41 = 1$ and the Differential PID Feedback Transducer is broken.	<ul style="list-style-type: none"> <li>Replace the Differential PID Feedback Transducer.</li> <li>Set <math>Y4-41 = 0</math> [<i>Disabled</i>].</li> </ul>
<b>Note:</b> <ul style="list-style-type: none"> <li>The drive detects this error if it does not receive the <i>PID Feedback Backup</i> signal.</li> <li>If the drive detects this error, the terminal set to <math>H2-01</math> to <math>H2-03 = 10</math> [<i>MFDO Function Selection = Alarm</i>] will activate.</li> </ul>			
Code	Name	Causes	Possible Solutions
bUS	Option Communication Error	The communications cable wiring is incorrect.	Correct wiring errors.
		There is a short-circuit in the communications cable or the communications cable is not connected.	<ul style="list-style-type: none"> <li>Repair short circuits and connect cables.</li> <li>Replace the defective communications cable.</li> </ul>
		Electrical interference caused a communication data error.	<ul style="list-style-type: none"> <li>Examine the control circuit lines, main circuit lines, and ground wiring, and decrease the effects of electrical interference.</li> <li>Make sure that a magnetic contactor is not the source of the electrical interference, then use a Surge Protective Device if necessary.</li> <li>Use only the recommended cables or other shielded line. Ground the shield on the controller side or the drive input power side.</li> <li>Separate the communication wiring from drive power lines, and install a noise filter to the input side of the power supply for communication.</li> <li>Decrease the effects of electrical interference from the controller.</li> </ul>
		The option card is incorrectly installed to the drive.	Correctly install the option card to the drive.
		The option card is damaged.	If the alarm continues and the wiring is correct, replace the option card.
<b>Note:</b> <ul style="list-style-type: none"> <li>The drive detects this error if the Run command or frequency reference is assigned to the option card.</li> <li>If the drive detects this error, the terminal set to <math>H2-01</math> to <math>H2-03 = 10</math> [<i>MFDO Function Selection = Alarm</i>] will activate.</li> <li>If the drive detects this error, it will operate the motor as specified by the stopping method set in <math>F6-01</math> [<i>Communication Error Selection</i>].</li> </ul>			
Code	Name	Causes	Possible Solutions
bUSy	Busy	You set the drive to use MEMOBUS/Modbus communications to change parameters, but you used the keypad to change parameters.	Use MEMOBUS/Modbus communications to enter the enter command, then use the keypad to change the parameter.
		You tried to change a parameter while the drive was changing setting.	Wait until the process is complete.
Code	Name	Causes	Possible Solutions
CALL	Serial Comm Transmission Error	The communications cable wiring is incorrect.	Correct wiring errors.
		There is a short circuit in the communications cable or the communications cable is not connected.	<ul style="list-style-type: none"> <li>Repair the short-circuited or disconnected portion of the cable.</li> <li>Replace the defective communications cable.</li> </ul>
		A programming error occurred on the controller side.	Examine communications at start-up and correct programming errors.



Code	Name	Causes	Possible Solutions
		There is damage to the communications circuitry.	<ul style="list-style-type: none"> <li>Do a self-diagnostics check.</li> <li>If the problem continues, replace the control board or the drive. Contact Yaskawa or your nearest sales representative to replace the control board.</li> </ul>
		The termination resistor setting for MEMOBUS/Modbus communications is incorrect.	On the last drive in a MEMOBUS/Modbus network, set DIP switch S2 to the ON position to enable the termination resistor.
<b>Note:</b> <ul style="list-style-type: none"> <li>The drive detects this error if it does not correctly receive control data from the controller when energizing the drive.</li> <li>If the drive detects this error, the terminal assigned to H2-01 to H2-03 = 10 [MFDO Function Selection = Alarm] will activate.</li> <li>If the drive detects this error, it will not run in AUTO or JOG. You can operate the drive in HAND mode during a CALL alarm.</li> <li>Parameter H5-33 [Power-up CALL Alarm] enables or disables the detection of this alarm at power-up.</li> </ul>			
Code	Name	Causes	Possible Solutions
CE	Modbus Communication Error	The communications cable wiring is incorrect.	Correct wiring errors.
		There is a short circuit in the communications cable or the communications cable is not connected.	<ul style="list-style-type: none"> <li>Repair short circuits and connect cables.</li> <li>Replace the defective communications cable.</li> </ul>
		Electrical interference caused a communication data error.	<ul style="list-style-type: none"> <li>Examine the control circuit lines, main circuit lines, and ground wiring, and decrease the effects of electrical interference.</li> <li>Make sure that a magnetic contactor is not the source of the electrical interference, then use a Surge Protective Device if necessary.</li> <li>Use only the recommended cables or other shielded line. Ground the shield on the controller side or the drive input power side.</li> <li>Separate the communication wiring from drive power lines, and install a noise filter to the input side of the power supply for communication.</li> <li>Decrease the effects of electrical interference from the controller.</li> </ul>
		The communication protocol is not compatible.	<ul style="list-style-type: none"> <li>Examine the values set in H5-xx.</li> <li>Examine the settings on the controller side and correct the difference in communication conditions.</li> </ul>
		The value set in H5-09 [CE Detection Time] is too small for the communications cycle.	<ul style="list-style-type: none"> <li>Change the controller software settings.</li> <li>Increase the value set in H5-09.</li> </ul>
		The controller software or hardware is causing a communication problem.	Examine the controller and remove the cause of the problem.
<b>Note:</b> <ul style="list-style-type: none"> <li>This alarm is a different alarm from CE [Run at H5-34 (CE Go-To-Freq)]. The keypad will show this alarm when: <ul style="list-style-type: none"> <li>-H5-04 ≠ 4 [Communication Error Stop Method ≠ Run at H5-34 (CE Go-To-Freq)]</li> <li>-H5-04 = 4 but the drive cannot operate at the selected frequency</li> </ul> </li> <li>The drive detects this error if it does not correctly receive control data for the CE detection time set to H5-09.</li> <li>If the drive detects this error, the terminal set to H2-01 to H2-03 = 10 [MFDO Function Selection = Alarm] will activate.</li> <li>If the drive detects this error, it will operate the motor as specified by the stopping method set in H5-04.</li> </ul>			
Code	Name	Causes	Possible Solutions
CE	Run at H5-34 (CE Go-To-Freq)	The communications cable wiring is incorrect.	Correct wiring errors.
		There is a short circuit in the communications cable or the communications cable is not connected.	<ul style="list-style-type: none"> <li>Repair short circuits and connect cables.</li> <li>Replace the defective communications cable.</li> </ul>
		Electrical interference caused a communication data error.	<ul style="list-style-type: none"> <li>Examine the control circuit lines, main circuit lines, and ground wiring, and decrease the effects of electrical interference.</li> <li>Make sure that a magnetic contactor is not the source of the electrical interference, then use a Surge Protective Device if necessary.</li> <li>Use only recommended shielded line. Ground the shield on the controller side or on the drive input power side.</li> <li>Separate the communication wiring from drive power lines, and install a noise filter to the input side of the power supply for communication.</li> <li>Decrease the effects of electrical interference from the controller.</li> </ul>
		The communication protocol is not compatible.	<ul style="list-style-type: none"> <li>Examine the values set in H5-xx.</li> <li>Examine the settings on the controller side and correct the difference in communication conditions.</li> </ul>
		The value set in H5-09 [CE Detection Time] is too small for the communications cycle.	<ul style="list-style-type: none"> <li>Make sure that the settings are compatible.</li> <li>Change the software settings in the PLC.</li> <li>Increase the value set in H5-09.</li> </ul>

## 7.5 Minor Faults/Alarms

Code	Name	Causes	Possible Solutions
		The controller software or hardware is causing a communication problem.	Examine the controller and remove the cause of the problem.
<b>Note:</b> <ul style="list-style-type: none"> <li>This alarm is a different alarm from the standard <i>CE [Modbus Communication Error]</i>. The keypad will show this alarm only when <i>H5-04 = 4 [Communication Error Stop Method = Run at H5-34 (CE Go-To-Freq)]</i>. If the drive cannot operate at the selected frequency, the keypad will show the standard <i>CE</i> alarm.</li> <li>The drive detects this error if it does not correctly receive control data for the <i>CE</i> detection time set to <i>H5-09</i>.</li> <li>If the drive detects this error, the terminal set to <i>H2-01 to H2-03 = 10 [MFDO Function Selection = Alarm]</i> will activate.</li> </ul>			
Code	Name	Causes	Possible Solutions
CrST	Cannot Reset	The drive received a fault reset command when a Run command was active.	Turn off the Run command then de-energize and re-energize the drive.
Code	Name	Causes	Possible Solutions
CyPo	Cycle Power to Accept Changes	Although <i>F6-15 = 1 [Comm. Option Parameters Reload = Reload Now]</i> , the drive does not update the communication option parameters.	Re-energize the drive to update the communication option parameters.
Code	Name	Causes	Possible Solutions
dEv	Speed Deviation	The load is too heavy	Decrease the load.
		Acceleration and deceleration times are set too short.	Increase the values set in <i>C1-01 to C1-04 [Acceleration/Deceleration Time]</i> .
		The <i>dEv</i> detection level settings are incorrect.	Adjust <i>F1-10 [Speed Deviation Detection Level]</i> and <i>F1-11 [Speed Deviation Detect DelayTime]</i> .
		The load is locked up.	Examine the machine.
		The holding brake is stopping the motor.	Release the holding brake.
<b>Note:</b> <ul style="list-style-type: none"> <li>The drive detects this error if the difference between the detected speed and the speed reference is more than the setting of <i>F1-10</i> for longer than <i>F1-11</i>.</li> <li>If the drive detects this error, the terminal assigned to <i>H2-01 to H2-03 = 10 [MFDO Function Selection = Alarm]</i> will be ON.</li> <li>If the drive detects this error, the drive will operate the motor as specified by the stopping method set in <i>F1-04 [Speed Deviation Detection Select]</i>.</li> </ul>			
Code	Name	Causes	Possible Solutions
DIFF	Differential Feedback Exceeded	The difference between the PID Feedback and <i>Differential Level Source [H3-xx = 2D]</i> is more than the level set in <i>Y4-18 [Pre-Charge Loss of Prime Level 2]</i> for the time set in <i>Y4-19 [Differential Lvl Detection Time]</i> .	<ul style="list-style-type: none"> <li>Replace the feedback transducer or transducers.</li> <li>Set <i>Y4-18</i> and <i>Y4-19</i> correctly.</li> </ul>
<b>Note:</b> <ul style="list-style-type: none"> <li>If the drive detects this error, it will respond as specified by the setting of <i>Y4-20 [Differential Level Detection Sel]</i>.</li> <li>If the drive detects this error, the terminal set to <i>H2-01 to H2-03 = 10 [MFDO Function Selection = Alarm]</i> will activate.</li> </ul>			
Code	Name	Causes	Possible Solutions
dnE	Drive Disabled	A terminal set for <i>H1-xx = 6A [MFDI Function Selection = Drive Enable]</i> deactivated.	Examine the operation sequence.
<b>Note:</b> <ul style="list-style-type: none"> <li>If the drive detects this error, the terminal set to <i>H2-01 to H2-03 = 10 [MFDO Function Selection = Alarm]</i> will activate.</li> </ul>			
Code	Name	Causes	Possible Solutions
dWA2	DriveWorksEZ Alarm 2	The DriveWorksEZ program output a minor fault.	Examine the DriveWorksEZ program and remove the cause of the fault. This is not a drive fault.
<b>Note:</b> <ul style="list-style-type: none"> <li>If the drive detects this error, the terminal set to <i>H2-01 to H2-03 = 10 [MFDO Function Selection = Alarm]</i> will activate.</li> </ul>			
Code	Name	Causes	Possible Solutions
dWA3	DriveWorksEZ Alarm 3	The DriveWorksEZ program output a minor fault.	Examine the DriveWorksEZ program and remove the cause of the fault. This is not a drive fault.
<b>Note:</b> <ul style="list-style-type: none"> <li>If the drive detects this error, the terminal set to <i>H2-01 to H2-03 = 10 [MFDO Function Selection = Alarm]</i> will activate.</li> </ul>			
Code	Name	Causes	Possible Solutions
dWAL	DriveWorksEZ Alarm	There was an error in the DriveWorksEZ program.	Examine the DriveWorksEZ program and remove the cause of the error. This is not a drive fault.
<b>Note:</b> <ul style="list-style-type: none"> <li>If the drive detects this error, the terminal set to <i>H2-01 to H2-03 = 10 [MFDO Function Selection = Alarm]</i> will activate.</li> </ul>			
Code	Name	Causes	Possible Solutions
EF	FWD/REV Run Command Input Error	The drive received a forward command and a reverse command at the same time for longer than 0.5 s.	Examine the forward and reverse command sequence and correct the problem.
<b>Note:</b> <ul style="list-style-type: none"> <li>If the drive detects <i>EF</i>, the motor will ramp to stop.</li> <li>If the drive detects this error, the terminal set to <i>H2-01 to H2-03 = 10 [MFDO Function Selection = Alarm]</i> will activate.</li> </ul>			

Code	Name	Causes	Possible Solutions
EF0	Option Card External Fault	The communication option card received an external fault from the controller.	1. Find the device that caused the external fault and remove the cause. 2. Clear the external fault input from the controller.
		Programming error occurred on the controller side.	Examine the operation of the controller program.
<b>Note:</b> <ul style="list-style-type: none"> <li>The drive detects this error if the alarm function on the external device side is operating.</li> <li>If the drive detects this error, the terminal set to H2-01 to H2-03 = 10 [MFDO Function Selection = Alarm] will activate.</li> <li>Use F6-03 [Comm External Fault (EF0) Select] to set the stopping method for this fault.</li> </ul>			
Code	Name	Causes	Possible Solutions
EF1	External Fault (Terminal S1)	MFDI terminal S1 caused an external fault through an external device.	1. Find the device that caused the external fault and remove the cause. 2. Clear the external fault input in the MFDI.
		The wiring is incorrect.	Correctly connect the signal line to MFDI terminal S1.
		External Fault [H1-01 = 2C to 2F] is set to MFDI terminal S1, but the terminal is not in use.	Correctly set the MFDI.
<b>Note:</b> <p>If the drive detects this error, the terminal set to H2-01 to H2-03 = 10 [MFDO Function Selection = Alarm] will activate.</p>			
Code	Name	Causes	Possible Solutions
EF2	External Fault (Terminal S2)	MFDI terminal S2 caused an external fault through an external device.	1. Find the device that caused the external fault and remove the cause. 2. Clear the external fault input in the MFDI.
		The wiring is incorrect.	Correctly connect the signal line to MFDI terminal S2.
		External Fault [H1-02 = 2C to 2F] is set to MFDI terminal S2, but the terminal is not in use.	Correctly set the MFDI.
<b>Note:</b> <p>If the drive detects this error, the terminal set to H2-01 to H2-03 = 10 [MFDO Function Selection = Alarm] will activate.</p>			
Code	Name	Causes	Possible Solutions
EF3	External Fault (Terminal S3)	MFDI terminal S3 caused an external fault through an external device.	1. Find the device that caused the external fault and remove the cause. 2. Clear the external fault input in the MFDI.
		The wiring is incorrect.	Correctly connect the signal line to MFDI terminal S3.
		External Fault [H1-03 = 2C to 2F] is set to MFDI terminal S3, but the terminal is not in use.	Correctly set the MFDI.
<b>Note:</b> <p>If the drive detects this error, the terminal set to H2-01 to H2-03 = 10 [MFDO Function Selection = Alarm] will activate.</p>			
Code	Name	Causes	Possible Solutions
EF4	External Fault (Terminal S4)	MFDI terminal S4 caused an external fault through an external device.	1. Find the device that caused the external fault and remove the cause. 2. Clear the external fault input in the MFDI.
		The wiring is incorrect.	Correctly connect the signal line to MFDI terminal S4.
		External Fault [H1-04 = 2C to 2F] is set to MFDI terminal S4, but the terminal is not in use.	Correctly set the MFDI.
<b>Note:</b> <p>If the drive detects this error, the terminal set to H2-01 to H2-03 = 10 [MFDO Function Selection = Alarm] will activate.</p>			
Code	Name	Causes	Possible Solutions
EF5	External Fault (Terminal S5)	MFDI terminal S5 caused an external fault through an external device.	1. Find the device that caused the external fault and remove the cause. 2. Clear the external fault input in the MFDI.
		The wiring is incorrect.	Correctly connect the signal line to MFDI terminal S5.
		External Fault [H1-05 = 2C to 2F] is set to MFDI terminal S5, but the terminal is not in use.	Correctly set the MFDI.
<b>Note:</b> <p>If the drive detects this error, the terminal set to H2-01 to H2-03 = 10 [MFDO Function Selection = Alarm] will activate.</p>			
Code	Name	Causes	Possible Solutions
EF6	External Fault (Terminal S6)	MFDI terminal S6 caused an external fault through an external device.	1. Find the device that caused the external fault and remove the cause. 2. Clear the external fault input in the MFDI.
		The wiring is incorrect.	Correctly connect the signal line to MFDI terminal S6.

## 7.5 Minor Faults/Alarms

Code	Name	Causes	Possible Solutions
		<i>External Fault [H1-06 = 2C to 2F]</i> is set to MFDI terminal S6, but the terminal is not in use.	Correctly set the MFDI.
<b>Note:</b> If the drive detects this error, the terminal set to <i>H2-01 to H2-03 = 10 [MFDO Function Selection = Alarm]</i> will activate.			
Code	Name	Causes	Possible Solutions
EF7	External Fault (Terminal S7)	MFDI terminal S7 caused an external fault through an external device.	1. Find the device that caused the external fault and remove the cause. 2. Clear the external fault input in the MFDI.
		The wiring is incorrect.	Correctly connect the signal line to MFDI terminal S7.
		<i>External Fault [H1-07 = 2C to 2F]</i> is set to MFDI terminal S7, but the terminal is not in use.	Correctly set the MFDI.
<b>Note:</b> If the drive detects this error, the terminal set to <i>H2-01 to H2-03 = 10 [MFDO Function Selection = Alarm]</i> will activate.			
Code	Name	Causes	Possible Solutions
EOF	Emergency Override FWD	The digital input terminal set to <i>H1-xx = AF [MFDI Function Selection = Emergency Override FWD]</i> activated.	When the emergency condition is gone, deactivate the digital input set to <i>Emergency Override FWD</i> .
<b>Note:</b> If the drive detects this error, the terminal set to <i>H2-01 to H2-03 = 10 [MFDO Function Selection = Alarm]</i> will activate.			
Code	Name	Causes	Possible Solutions
EOR	Emergency Override REV	The digital input terminal set to <i>H1-xx = B0 [MFDI Function Selection = Emergency Override REV]</i> activated.	When the emergency condition is gone, deactivate the digital input set to <i>Emergency Override REV</i> .
<b>Note:</b> If the drive detects this error, the terminal set to <i>H2-01 to H2-03 = 10 [MFDO Function Selection = Alarm]</i> will activate.			
Code	Name	Causes	Possible Solutions
EP24v	External Power 24V Supply	The voltage of the main circuit power supply decreased, and the 24 V power supply is supplying power to the drive.	<ul style="list-style-type: none"> <li>Examine the main circuit power supply.</li> <li>Turn ON the main circuit power supply to run the drive.</li> </ul>
<b>Note:</b> <ul style="list-style-type: none"> <li>Set <i>o2-26 [Ext. Power 24V Supply Display]</i> to enable or disable <i>EP24v</i> detection.</li> <li>The drive will not output an alarm signal for this alarm.</li> </ul>			
Code	Name	Causes	Possible Solutions
FDBKL	Feedback Loss Wire Break	<p>The analog input from the terminal set to <i>H3-xx = B [MFAI Function Selection = PID Feedback]</i> is more than 21 mA or less than 3 mA for longer than 1 s in these conditions:</p> <ul style="list-style-type: none"> <li><i>b5-82 = 1 [Feedback Loss 4 ~ 20mA Detect Sel = Alarm Only]</i></li> <li><i>b5-01 ≠ 0 [PID Mode Setting ≠ Disabled]</i></li> <li><i>H3-01 or H3-09 = 2 [Terminal A1/A2 Signal Level Selection = 4 to 20 mA]</i></li> </ul>	Make sure that you install the PID feedback source and it operates correctly.
<b>Note:</b> <ul style="list-style-type: none"> <li>If the drive detects this error, the terminal set to <i>H2-01 to H2-03 = 10 [MFDO Function Selection = Alarm]</i> will activate.</li> <li>If the drive detects this error, it will operate the motor as specified by the settings of <i>b5-82</i>.</li> <li>Parameter <i>L5-42 [Feedback Loss Fault Retry Select]</i> sets the Auto Restart function of this error.</li> </ul>			
Code	Name	Causes	Possible Solutions
FLGT	Feedback Loss, Go To Freq b5-83	<p>The analog input from the terminal set to <i>H3-xx = B [MFAI Function Selection = PID Feedback]</i> is more than 21 mA or less than 3 mA for longer than 1 s in these conditions:</p> <ul style="list-style-type: none"> <li><i>b5-82 = 3 [Feedback Loss 4 ~ 20mA Detect Sel = Run At b5-83]</i></li> <li><i>b5-01 ≠ 0 [PID Mode Setting ≠ Disabled]</i></li> <li><i>H3-01 or H3-09 = 2 [Terminal A1/A2 Signal Level Selection = 4 to 20 mA]</i></li> </ul>	Make sure that you install the PID feedback source and it operates correctly.
<b>Note:</b> <ul style="list-style-type: none"> <li>If the drive detects this error, the terminal set to <i>H2-01 to H2-03 = 10 [MFDO Function Selection = Alarm]</i> will activate.</li> <li>If the drive detects this error, it will operate the motor at the speed set in <i>b5-83 [Feedback Loss Goto Frequency]</i> as specified by the setting of <i>b5-82</i>.</li> </ul>			

Code	Name	Causes	Possible Solutions
FR<MS	Freq Ref < Minimum Speed (Y1-06)	The drive frequency reference setting is less than the value set in Y1-06 [Minimum Speed] in these conditions: <ul style="list-style-type: none"> <li>The drive is not in PI Mode</li> <li>The drive is running</li> <li>Minimum Speed is enabled (Y1-06 &gt; 0.00)</li> <li>Y1-06 &gt; Y4-12 [Thrust Frequency]</li> </ul>	Increase the frequency reference to a value more than Y1-06.
<b>Note:</b> <ul style="list-style-type: none"> <li>If the drive detects this error, the terminal set to H2-01 to H2-03 = 10 [MFDO Function Selection = Alarm] will activate.</li> <li>If the drive detects this error, it internally sets the frequency reference to the value set in Y1-06.</li> </ul>			
Code	Name	Causes	Possible Solutions
FR<TH	Freq. Reference < Thrust (Y4-12)	The drive frequency reference setting is less than the value set in Y4-12 [Thrust Frequency] in these conditions: <ul style="list-style-type: none"> <li>The drive is not in PI Mode</li> <li>The drive is running</li> <li>Thrust is enabled (Y4-11 [Thrust Acceleration Time] &gt; 0.00 and Y4-12 &gt; Y1-06 [Minimum Speed])</li> </ul>	Increase the frequency reference to a value more than Y4-12.
<b>Note:</b> <ul style="list-style-type: none"> <li>If the drive detects this error, the terminal set to H2-01 to H2-03 = 10 [MFDO Function Selection = Alarm] will activate.</li> <li>If the drive detects this error, it internally sets the frequency reference to the value set in Y4-12.</li> </ul>			
Code	Name	Causes	Possible Solutions
HCA	High Current Alarm	The load is too heavy.	<ul style="list-style-type: none"> <li>Decrease the load for applications with repetitive starts and stops.</li> <li>Replace the drive with a larger capacity model.</li> </ul>
		The acceleration time is too short.	<ul style="list-style-type: none"> <li>Calculate the torque necessary during acceleration related to the load inertia and the specified acceleration time.</li> <li>Increase the values set in C1-01 or C1-03 [Acceleration Times] until you get the necessary torque.</li> <li>Increase the values set in C2-01 to C2-04 [S-Curve Characteristics] until you get the necessary torque.</li> <li>Replace the drive with a larger capacity model.</li> </ul>
		The drive is trying to operate a specialized motor or a motor that is larger than the maximum applicable motor output of the drive.	<ul style="list-style-type: none"> <li>Examine the motor nameplate, the motor, and the drive to make sure that the drive rated current is larger than the motor rated current.</li> <li>Replace the drive with a larger capacity model.</li> </ul>
		The current level temporarily increased because of speed search after a momentary power loss or while trying to Auto Restart.	If speed search or Auto Restart cause an increase in current, the drive can temporarily show this alarm. The time that the drive shows the alarm is short. No more steps are necessary to clear the alarm.
<b>Note:</b> <ul style="list-style-type: none"> <li>The drive detects this error if the drive output current is more than the overcurrent alarm level (150% of the rated current).</li> <li>If the drive detects this error, the terminal set to H2-01 to H2-03 = 10 [MFDO Function Selection = Alarm] will activate.</li> </ul>			
Code	Name	Causes	Possible Solutions
HIAUX	High PI Aux Feedback Level	PI Auxiliary Feedback is more than the level set in YF-12 [PI Aux Control High Level Detect] for the time set in YF-13 [PI Aux High Level Detection Time] in these conditions: <ul style="list-style-type: none"> <li>The drive operates in AUTO Mode.</li> <li>The output frequency &gt; 0.</li> </ul>	<ul style="list-style-type: none"> <li>Decrease the PI Auxiliary Feedback level to less than YF-12.</li> <li>Set YF-12 and YF-13 correctly.</li> </ul>
<b>Note:</b> <ul style="list-style-type: none"> <li>If the drive detects this error, the terminal set to H2-01 to H2-03 = 10 [MFDO Function Selection = Alarm] will activate.</li> </ul>			
Code	Name	Causes	Possible Solutions
HIFB	High Feedback Sensed	The feedback level is more than the level set in Y1-11 [High Feedback Level].	<ul style="list-style-type: none"> <li>Decrease the feedback level to less than Y1-11 - Y1-14 [Hysteresis Level].</li> <li>Set Y1-11 and Y1-12 correctly.</li> </ul>
<b>Note:</b> <ul style="list-style-type: none"> <li>If the drive detects this error, the terminal set to H2-01 to H2-03 = 10 [MFDO Function Selection = Alarm] will activate.</li> <li>If the drive detects this error, it will respond as specified by the setting of Y1-13 [High Feedback Selection].</li> </ul>			

## 7.5 Minor Faults/Alarms

Code	Name	Causes	Possible Solutions
INTLK	BAS Interlock	The digital input terminal set to $H1-xx = B2$ [MFDI Function Selection = BAS Interlock] deactivates.	Make sure the cause of interlock.
<b>Note:</b> <ul style="list-style-type: none"> <li>If the drive detects this error, the terminal set to <math>H2-01</math> to <math>H2-03 = 10</math> [MFDO Function Selection = Alarm] will activate.</li> </ul>			
<ul style="list-style-type: none"> <li>If the drive detects this error,  will not flash.</li> </ul>			
Code	Name	Causes	Possible Solutions
L24v	Loss of External Power 24 Supply	The voltage of the backup 24 V power supply has decreased. The main circuit power supply is operating correctly.	<ul style="list-style-type: none"> <li>Examine the external 24 V power supply for disconnected wires and wiring errors and repair the problems.</li> <li>Examine the external 24 V power supply for problems.</li> </ul>
<b>Note:</b> <ul style="list-style-type: none"> <li>Set <math>o2-23</math> [External 24V Powerloss Detection] to enable or disable L24v detection.</li> <li>The drive will not output an alarm signal for this alarm.</li> </ul>			
Code	Name	Causes	Possible Solutions
LCP	Low City Pressure	Insufficient pressure is present on the inlet to the pump in these conditions: <ul style="list-style-type: none"> <li><math>Y4-24 = 0</math> [Low City Alarm Text = Low City Pressure]</li> <li>The terminal set for <math>H1-xx = B8</math> or <math>1B8</math> [MFDI Function Selection = Low City Pressure or !Low City Pressure] activates</li> </ul>	<ul style="list-style-type: none"> <li>Examine the pressure switch contact for correct operation.</li> <li>Examine control wiring to drive terminal strip from pressure switch contact.</li> <li>Make sure that suction pressure is present with an isolated measuring device.</li> <li>Set <math>Y4-22</math> [Low City On-Delay Time] and <math>Y4-23</math> [Low City Off-Delay Time] correctly.</li> <li>Deactivate the digital input terminals set to <math>H1-xx = B8</math> or <math>1B8</math>.</li> </ul>
<b>Note:</b> <ul style="list-style-type: none"> <li>If the drive detects this error, the terminal set to <math>H2-01</math> to <math>H2-03 = 10</math> [MFDO Function Selection = Alarm] will activate.</li> <li>If the drive detects this error during run, it coasts to stop and does not operate until the digital input has deactivated for the time set in <math>Y4-22</math>.</li> </ul>			
Code	Name	Causes	Possible Solutions
LOAUX	Low PI Aux Feedback Level	When the drive operates in AUTO Mode or HAND Mode, PI Auxiliary Feedback is less than the level set in $YF-09$ [PI Aux Control Low Lvl Detection] for the time set in $YF-10$ [PI Aux Control Low Lvl Det Time] and the drive is running.	<ul style="list-style-type: none"> <li>Increase the PI Auxiliary Feedback level more than <math>YF-09</math>.</li> <li>Set <math>YF-09</math> and <math>YF-10</math> correctly.</li> </ul>
<b>Note:</b> <ul style="list-style-type: none"> <li>If the drive detects this error, the terminal set to <math>H2-01</math> to <math>H2-03 = 10</math> [MFDO Function Selection = Alarm] will activate.</li> </ul>			
Code	Name	Causes	Possible Solutions
LOFB	Low Feedback Sensed	The feedback level is less than the level set in $Y1-08$ [Low Feedback Level] for the time set in $Y1-09$ [Low Feedback Lvl Fault Dly Time].	<ul style="list-style-type: none"> <li>Increase the feedback level to more than <math>Y1-08 + Y1-14</math> [High Feedback Hysteresis Level].</li> <li>Set <math>Y1-08</math> and <math>Y1-09</math> correctly.</li> </ul>
<b>Note:</b> <ul style="list-style-type: none"> <li>If the drive detects this error, the terminal set to <math>H2-01</math> to <math>H2-03 = 10</math> [MFDO Function Selection = Alarm] will activate.</li> <li>If the drive detects this fault, it will respond as specified by the setting of <math>Y1-10</math> [Low Feedback Selection].</li> </ul>			
Code	Name	Causes	Possible Solutions
LoG	Com Error / Abnormal SD Card	There is not a micro SD card in the keypad.	Put a micro SD card in the keypad.
		<ul style="list-style-type: none"> <li>The drive is connected to USB.</li> <li>The number of log communication files is more than 1000.</li> <li>The micro SD card does not have available memory space.</li> <li>The line number data in a log communication file was changed.</li> <li>A communication error between the keypad and drive occurred during a log communication.</li> </ul>	Set $o5-01 = 0$ [Log Start/Stop Selection = OFF].
<b>Note:</b> <ul style="list-style-type: none"> <li>If the drive detects this error, the terminal set to <math>H2-01</math> to <math>H2-03 = 6A</math> [MFDO Function Selection = Data Logger Error] will activate.</li> </ul>			
Code	Name	Causes	Possible Solutions
LOP	Loss of Prime	The drive used the method set in $Y1-18$ [Prime Loss Detection Method] to detect that the pump load is less than the level set in $Y1-19$ [Prime Loss Level] for the time set in $Y1-20$ [Prime Loss Time], and the output frequency is $Y1-21$ [Prime Loss Activation Freq] or more.	<ul style="list-style-type: none"> <li>Examine a dry well, air in the system, or no water in the system. Use preferred priming method suggested by the pump manufacturer to restart the pump.</li> <li>When there is resistance in the pump, allow the system to pump water again.</li> <li>Set <math>Y1-18</math> to <math>Y1-21</math> correctly.</li> </ul>
<b>Note:</b> <ul style="list-style-type: none"> <li>If the drive detects this error, the terminal set to <math>H2-01</math> to <math>H2-03 = 10</math> [MFDO Function Selection = Alarm] will activate.</li> <li>If the drive detects this fault, it will respond as specified by the setting of <math>Y1-22</math> [Prime Loss Selection].</li> </ul>			

Code	Name	Causes	Possible Solutions
LSP	Low Suction Pressure	An external input has indicated that an insufficient suction pressure condition exists in these conditions: <ul style="list-style-type: none"> <li>Y4-24 = 1 [Low City Alarm Text = Low Suction Pressure]</li> <li>The terminal set for H1-xx = B8 or 1B8 [MFDI Function Selection = Low City Pressure or !Low City Pressure] activates</li> </ul>	<ul style="list-style-type: none"> <li>Examine the pressure switch contact for correct operation.</li> <li>Examine control wiring to drive terminal strip from pressure switch contact.</li> <li>Make sure that suction pressure is present with an isolated measuring device.</li> <li>Increase the system pressure.</li> <li>Set Y4-22 [Low City On-Delay Time] and Y4-23 [Low City Off-Delay Time] correctly.</li> <li>Deactivate the digital input terminals set to H1-xx = B8 or 1B8.</li> </ul>
<b>Note:</b> <ul style="list-style-type: none"> <li>If the drive detects this error, the terminal set to H2-01 to H2-03 = 10 [MFDO Function Selection = Alarm] will activate.</li> <li>If the drive detects this error during run, it coasts to stop and does not operate until the digital input has deactivated for the time set in Y4-22.</li> </ul>			
Code	Name	Causes	Possible Solutions
LT-1	Cooling Fan Maintenance Time	The cooling fan is at 90% of its performance life estimate.	<ol style="list-style-type: none"> <li>Replace the cooling fan.</li> <li>Set o4-03 = 0 [Fan Operation Time Setting = 0 h] to reset the cooling fan operation time.</li> </ol>
<b>Note:</b> When the performance life estimate is expired, the terminal set to H2-01 to H2-03 = 2F [MFDO Function Selection = Maintenance Notification] will activate.			
Code	Name	Causes	Possible Solutions
LT-2	Capacitor Maintenance Time	The capacitors for the main circuit and control circuit are at 90% of their performance life estimate.	Replace the control board or the drive. For information about replacing the control board, contact Yaskawa or your nearest sales representative.
<b>Note:</b> When the performance life estimate is expired, the terminal set to H2-01 to H2-03 = 2F [MFDO Function Selection = Maintenance Notification] will activate.			
Code	Name	Causes	Possible Solutions
LT-3	SoftChargeBypassRelay MainteTime	The soft charge bypass relay is at 90% of its performance life estimate.	Replace the control board or the drive. For information about replacing the control board, contact Yaskawa or your nearest sales representative.
<b>Note:</b> When the performance life estimate is expired, the terminal set to H2-01 to H2-03 = 2F [MFDO Function Selection = Maintenance Notification] will activate.			
Code	Name	Causes	Possible Solutions
LT-4	IGBT Maintenance Time (50%)	The IGBT is at 50% of its performance life estimate.	Check the load, carrier frequency, and output frequency.
<b>Note:</b> When the performance life estimate is expired, the terminal set to H2-01 to H2-03 = 2F [MFDO Function Selection = Maintenance Notification] will activate.			
Code	Name	Causes	Possible Solutions
LWT	Low Water In Tank	An external input has indicated that the water level in the tank is too low in these conditions: <ul style="list-style-type: none"> <li>Y4-24 = 2 [Low City Alarm Text = Low Water in Tank]</li> <li>The terminal set for H1-xx = B8 or 1B8 [MFDI Function Selection = Low City Pressure or !Low City Pressure] activates</li> </ul>	<ul style="list-style-type: none"> <li>Examine the pressure switch contact for correct operation.</li> <li>Examine control wiring to drive terminal strip from pressure switch contact.</li> <li>Make sure that suction pressure is present with an isolated measuring device.</li> <li>Increase the water level.</li> <li>Set Y4-22 [Low City On-Delay Time] and Y4-23 [Low City Off-Delay Time] correctly.</li> <li>Deactivate the digital input terminals set to H1-xx = B8 or 1B8.</li> </ul>
<b>Note:</b> <ul style="list-style-type: none"> <li>If the drive detects this error, the terminal set to H2-01 to H2-03 = 10 [MFDO Function Selection = Alarm] will activate.</li> <li>If the drive detects this error during run, it coasts to stop and does not operate until the digital input has deactivated for the time set in Y4-22.</li> </ul>			
Code	Name	Causes	Possible Solutions
NETSC	NETSCAN Waiting for Master	The drive does not receive message from the master in the time set in Y9-28 [NETSCAN Alarm Time].	<ul style="list-style-type: none"> <li>Increase Y9-28 to account for network latency.</li> <li>Make sure that there is a drive on the network with parameters set to Y1-01 = 3 [Multiplex Mode = Memobus Network] and Y9-27 = 0 [Network Recovery = Automatic].</li> <li>Examine the network connections and the settings of H5-01 [Drive Node Address] and Y9-25 [Highest Node Address] for all drives on the network.</li> </ul>
<b>Note:</b> If the drive detects this error, the terminal set to H2-01 to H2-03 = 10 [MFDO Function Selection = Alarm] will activate.			
Code	Name	Causes	Possible Solutions
NMS	Setpoint Not Met	The feedback deviates from the setpoint at a level more than Y1-15 [Maximum Setpoint Difference] for the time set in Y1-16 [Not Maintaining Setpoint Time].	<ul style="list-style-type: none"> <li>Examine for a blocked impeller, over cycling, or broken pipe.</li> <li>Set Y1-15 and Y1-16 correctly.</li> </ul>
<b>Note:</b> <ul style="list-style-type: none"> <li>If the drive detects this error, the terminal set to H2-01 to H2-03 = 10 [MFDO Function Selection = Alarm] will activate.</li> <li>If the drive detects this error, it will respond as specified by the setting of Y1-17 [Not Maintaining Setpoint Sel].</li> </ul>			

## 7.5 Minor Faults/Alarms

Code	Name	Causes	Possible Solutions
OD	Output Disconnect	The output circuit between the drive and the motor is open, and the drive output current is less than 5% of <i>E2-01 [Motor Rated Current (FLA)]</i> .	<ul style="list-style-type: none"> <li>Close the disconnected output circuit between the drive and the motor.</li> <li>If you do not use a motor disconnect, set <i>Y4-42 = 0 [Disabled]</i>.</li> </ul>
<b>Note:</b> <ul style="list-style-type: none"> <li>If the drive detects this error, the terminal set to <i>H2-01 to H2-03 = 10 [MFDO Function Selection = Alarm]</i> will activate.</li> <li>If the drive detects this error, it will respond as specified by the setting of <i>Y4-42 [Output Disconnect Detection Sel]</i>.</li> </ul>			
Code	Name	Causes	Possible Solutions
oH	Heatsink Overheat	The ambient temperature is high and the heatsink temperature is more than the <i>L8-02 [Overheat Alarm Level]</i> .	<ul style="list-style-type: none"> <li>Measure the ambient temperature.</li> <li>Increase the airflow around the drive.</li> <li>Install a cooling device (cooling fan or air conditioner) to decrease the ambient temperature.</li> <li>Remove objects near the drive that are producing too much heat.</li> </ul>
		There is not sufficient airflow around the drive.	<ul style="list-style-type: none"> <li>Give the drive the correct installation space as shown in the manual.</li> <li>Make sure that there is sufficient circulation around the control panel.</li> <li>Examine the drive for dust or other unwanted materials that could clog the cooling fan.</li> <li>Remove unwanted materials that prevent air circulation.</li> </ul>
		The internal cooling fan or fans stopped.	<ol style="list-style-type: none"> <li>Replace the cooling fan.</li> <li>Set <i>o4-03 = 0 [Fan Operation Time Setting = 0 h]</i> to reset the cooling fan operation time.</li> </ol>
<b>Note:</b> <ul style="list-style-type: none"> <li>The drive detects this error if the heatsink temperature of the drive is more than <i>L8-02</i>.</li> <li>If the drive detects this error, the terminal set to <i>H2-01 to H2-03 = 10 [MFDO Function Selection = Alarm]</i> will activate.</li> <li>Use <i>L8-03 [Overheat Pre-Alarm Selection]</i> to the stopping method for this fault.</li> </ul>			
Code	Name	Causes	Possible Solutions
oH2	External Overheat (H1-XX=B)	An external device sent an <i>oH2</i> alarm.	<ol style="list-style-type: none"> <li>Find the external device that output the overheat alarm.</li> <li>Remove the cause of the problem.</li> <li>Clear the <i>Overheat Alarm (oH2) [H1-xx = B]</i> in MFDI terminals S1 to S7.</li> </ol>
<b>Note:</b> <p>If the drive detects this error, the terminal set to <i>H2-01 to H2-03 = 10 [MFDO Function Selection = Alarm]</i> will activate.</p>			
Code	Name	Causes	Possible Solutions
oH3	Motor Overheat (PTC Input)	The thermistor wiring that detects motor temperature is defective.	Correct wiring errors.
		A fault occurred on the machine. Example: The machine is locked.	Examine the machine and remove the cause of the fault
		The motor has overheated.	<ul style="list-style-type: none"> <li>Check the load level, acceleration/deceleration time, and motor start/stop frequency (cycle time).</li> <li>Decrease the load.</li> <li>Increase the values set in <i>C1-01 to C1-04 [Acceleration/Deceleration Times]</i>.</li> <li>Set <i>E2-01 [Motor Rated Current (FLA)]</i> correctly to the value specified by the motor nameplate.</li> <li>Make sure that the motor cooling system is operating correctly, and repair or replace it if it is damaged.</li> <li>Adjust <i>E1-04 to E1-10 [V/f Pattern Parameters]</i>. For motor 2, adjust <i>E3-04 to E3-10</i>. Decrease the values set in <i>E1-08 [Mid Point A Voltage]</i> and <i>E1-10 [Minimum Output Voltage]</i>.</li> </ul> <p><b>Note:</b> If the values set in <i>E1-08</i> and <i>E1-10</i> are too low, the overload tolerance will decrease at low speeds.</p>
<b>Note:</b> <ul style="list-style-type: none"> <li>When <i>H3-02 or H3-10 = E [MFAI Function Selection = Motor Temperature (PTC Input)]</i>, the drive detects this fault if the motor overheat signal entered to analog input terminals A1 and A2 is more than the alarm detection level.</li> <li>If the drive detects this error, the terminal set to <i>H2-01 to H2-03 = 10 [MFDO Function Selection = Alarm]</i> will activate.</li> <li>If the drive detects this error, it will operate the motor as specified by the stopping method set in <i>L1-03 [Motor Thermistor oH Alarm Select]</i>.</li> </ul>			



Code	Name	Causes	Possible Solutions
oL3	Overtorque 1	A fault occurred on the machine. Example: The machine is locked.	Examine the machine and remove the cause of the fault.
		The parameters are incorrect for the load.	Adjust L6-02 [Torque Detection Level 1] and L6-03 [Torque Detection Time 1] settings.
<b>Note:</b> <ul style="list-style-type: none"> <li>The drive detects this fault if the drive output current is more than the level set in L6-02 for longer than L6-03.</li> <li>If the drive detects this error, the terminal set to H2-01 to H2-03 = 10 [MFDO Function Selection = Alarm] will activate.</li> <li>Use L6-01 [Torque Detection Selection 1] to set the conditions that trigger the minor fault.</li> </ul>			
Code	Name	Causes	Possible Solutions
oL4	Overtorque 2	A fault occurred on the machine. Example: The machine is locked.	Examine the machine and remove the cause of the fault.
		The parameters are incorrect for the load.	Adjust L6-05 [Torque Detection Level 2] and L6-06 [Torque Detection Time 2] settings.
<b>Note:</b> <ul style="list-style-type: none"> <li>The drive detects this error if the drive output current is more than the level set in L6-05 for longer than L6-06.</li> <li>If the drive detects this error, the terminal set to H2-01 to H2-03 = 10 [MFDO Function Selection = Alarm] will activate.</li> <li>Use L6-04 [Torque Detection Selection 2] to set the conditions that trigger the minor fault.</li> </ul>			
Code	Name	Causes	Possible Solutions
oS	Overspeed	There is overshoot.	Decrease C5-01 [ASR Proportional Gain 1] and increase C5-02 [ASR Integral Time 1].
<b>Note:</b> If the drive detects this error, the terminal set to H2-01 to H2-03 = 10 [MFDO Function Selection = Alarm] will activate.			
Code	Name	Causes	Possible Solutions
ov	DC Bus Overvoltage	The drive output cable or motor is shorted to ground (the current short to ground is charging the main circuit capacitor of the drive through the power supply).	<ol style="list-style-type: none"> <li>Examine the motor main circuit cable, terminals, and motor terminal box, and then remove ground faults.</li> <li>Re-energize the drive.</li> </ol>
		The power supply voltage is too high.	Decrease the power supply voltage to align with the drive rated voltage.
		Electrical interference caused a drive malfunction.	<ul style="list-style-type: none"> <li>Examine the control circuit lines, main circuit lines, and ground wiring, and minimize the effects of noise.</li> <li>Find the source of the noise. If a magnetic contactor is the source, use Surge Protective Device if necessary.</li> <li>Set L5-01 ≠ 0 [Number of Auto-Restart Attempts ≠ 0 times].</li> </ul>
<b>Note:</b> <ul style="list-style-type: none"> <li>The drive detects this error if the DC bus voltage is more than the ov detection level when the Run command has not been input (while the drive is stopped).</li> <li>The ov detection level is approximately 410 V with 208 V class drives. The detection level is approximately 820 V with 480 V class drives.</li> <li>If the drive detects this error, the terminal set to H2-01 to H2-03 = 10 [MFDO Function Selection = Alarm] will activate.</li> </ul>			
Code	Name	Causes	Possible Solutions
ovEr	Too Many Parameters Changed	You tried to change more than 150 parameters.	Make sure that parameters that do not have an effect on drive operation are at their default settings. <b>Note:</b> <ul style="list-style-type: none"> <li>You can change 150 parameters maximum.</li> <li>If you change parameters that have dependencies, the drive can detect ovEr when the number of changed parameters is fewer than 150.</li> </ul>
Code	Name	Causes	Possible Solutions
PASS	Modbus Communication Test	The MEMOBUS/Modbus communications test is complete.	The PASS display will turn off after communications test mode is cleared.
Code	Name	Causes	Possible Solutions
PF	Input Phase Loss	There is a phase loss in the drive input power.	Correct errors with the wiring for main circuit drive input power.
		Loose wiring in the input power terminals.	Tighten the terminal screws to the correct tightening torque.
		The drive input power voltage is changing too much.	<ul style="list-style-type: none"> <li>Examine the input power for problems.</li> <li>Make the drive input power stable.</li> </ul>
		Unsatisfactory balance between voltage phases.	<ul style="list-style-type: none"> <li>Examine the input power for problems.</li> <li>Make the drive input power stable.</li> <li>If the input power supply is good, examine the magnetic contactor on the main circuit side for problems.</li> </ul>

## 7.5 Minor Faults/Alarms

Code	Name	Causes	Possible Solutions
		The main circuit capacitors are unserviceable.	<ul style="list-style-type: none"> <li>Examine the capacitor maintenance time in monitor <i>U4-05 [Capacitor Maintenance]</i>.</li> <li>If <i>U4-05</i> is more than 90%, replace the capacitor. Contact Yaskawa or your nearest sales representative for more information.</li> </ul>
			<ul style="list-style-type: none"> <li>Examine the input power for problems.</li> <li>Re-energize the drive.</li> <li>If the alarm stays, replace the circuit board or the drive. Contact Yaskawa or your nearest sales representative for more information.</li> </ul>
<b>Note:</b> <ul style="list-style-type: none"> <li>The drive detects this error if the DC bus voltage changes irregularly without regeneration.</li> <li>If the drive detects this error, the terminal set to <i>H2-01 to H2-03 = 10 [MFDO Function Selection = Alarm]</i> will activate.</li> <li>Use <i>L8-05 [Input Phase Loss Protection Sel]</i> to enable and disable PF detection.</li> </ul>			
Code	Name	Causes	Possible Solutions
rUn	Motor Switch during Run	The drive received a <i>Motor 2 Selection [H1-xx = 16]</i> during run.	Make sure that the drive receives the Motor 2 Selection while the drive is stopped.
<b>Note:</b> If the drive detects this error, the terminal set to <i>H2-01 to H2-03 = 10 [MFDO Function Selection = Alarm]</i> will activate.			
Code	Name	Causes	Possible Solutions
SAFE	Customer Safeties	External contact from customer wiring is open.	Examine the cause of the open safety.
<b>Note:</b> <ul style="list-style-type: none"> <li>If the terminal set for <i>H1-xx = B1 [MFDI Function Selection = Customer Safeties]</i> deactivates, the drive detects this alarm.</li> <li>If the drive detects this error, the terminal set to <i>H2-01 to H2-03 = 10 [MFDO Function Selection = Alarm]</i> will activate.</li> <li>This alarm has display priority over <i>INTLK [BAS Interlock]</i>.</li> </ul>			
Code	Name	Causes	Possible Solutions
SE	Modbus Test Mode Error	MEMOBUS/Modbus communications self-diagnostics [ <i>H1-xx = 67</i> ] was done while the drive was running.	Stop the drive and do MEMOBUS/Modbus communications self-diagnostics.
<b>Note:</b> If the drive detects this error, the terminal set to <i>H2-01 to H2-03 = 10 [MFDO Function Selection = Alarm]</i> will activate.			
Code	Name	Causes	Possible Solutions
STo	Safe Torque OFF	Safe Disable inputs H1-HC and H2-HC are open.	<ul style="list-style-type: none"> <li>Make sure that the Safe Disable signal is input from an external source to terminal H1-HC and H2-HC.</li> <li>When the Safe Disable function is not in use, use a jumper to connect terminals H1-HC and H2-HC.</li> </ul>
		There is internal damage to the two Safe Disable channels.	Replace the board or the drive. Contact Yaskawa or your nearest sales representative to replace the board.
<b>Note:</b> <ul style="list-style-type: none"> <li>The drive will not output an alarm signal for this alarm.</li> <li>If the drive detects this error, the terminal set to <i>H2-01 to H2-03 = 21 [MFDO Function Selection = Safe Torque OFF]</i> will activate.</li> </ul>			
Code	Name	Causes	Possible Solutions
SToF	Safe Torque OFF Hardware	One of the two terminals H1-HC or H2-HC received the Safe Disable input signal.	<ul style="list-style-type: none"> <li>Make sure that the Safe Disable signal is input from an external source to terminals H1-HC or H2-HC.</li> <li>When the Safe Disable function is not in use, use a jumper to connect terminals H1-HC and H2-HC.</li> </ul>
		The Safe Disable input signal is wired incorrectly.	
		There is internal damage to one Safe Disable channel.	Replace the board or the drive. Contact Yaskawa or your nearest sales representative to replace the board.
<b>Note:</b> If the drive detects this error, the terminal set to <i>H2-01 to H2-03 = 10 [MFDO Function Selection = Alarm]</i> will activate.			
Code	Name	Causes	Possible Solutions
TiM	Keypad Time Not Set	There is a battery in the keypad, but you have not set the date and time.	Use the keypad to set the date and time.
<b>Note:</b> <ul style="list-style-type: none"> <li>Parameter <i>o4-24 [bAT Detection selection]</i> enables and disables <i>TiM</i> detection.</li> <li>If the drive detects this error, the terminal set to <i>H2-01 to H2-03 = 10 [MFDO Function Selection = Alarm]</i> will activate.</li> </ul>			
Code	Name	Causes	Possible Solutions
TrPC	IGBT Maintenance Time (90%)	The IGBT is at 90% of its performance life estimate.	Replace the IGBT or the drive. For more information, contact Yaskawa or your nearest sales representative.
<b>Note:</b> If the drive detects this error, the terminal set to <i>H2-01 to H2-03 = 10 [MFDO Function Selection = Alarm]</i> will activate.			

Code	Name	Causes	Possible Solutions
UL3	Undertorque Detection 1	A fault occurred on the machine. Example: There is a broken pulley belt.	Examine the machine and remove the cause of the fault.
		The parameters are incorrect for the load.	Adjust L6-02 [Torque Detection Level 1] and L6-03 [Torque Detection Time 1] settings.
<b>Note:</b> <ul style="list-style-type: none"> <li>The drive detects this error if the drive output current is less than the level set in L6-02 for longer than L6-03.</li> <li>If the drive detects this error, the terminal set to H2-01 to H2-03 = 10 [MFDO Function Selection = Alarm] will activate.</li> <li>If the drive detects this error, it will operate the motor as specified by the Stopping Method set in L6-01 [Torque Detection Selection 1].</li> </ul>			
Code	Name	Causes	Possible Solutions
UL4	Undertorque Detection 2	A fault occurred on the machine. Example: There is a broken pulley belt.	Examine the machine and remove the cause of the fault.
		The parameters are incorrect for the load.	Adjust L6-05 [Torque Detection Level 2] and L6-06 [Torque Detection Time 2] settings.
<b>Note:</b> <ul style="list-style-type: none"> <li>The drive detects this error if the drive output current is less than the level set in L6-05 for longer than L6-06.</li> <li>If detected, the terminal set to H2-01 to H2-03 = 10 [MFDO Function Selection = Alarm] will activate.</li> <li>If the drive detects this error, it will operate the motor as specified by the Stopping Method set in L6-04 [Torque Detection Selection 2].</li> </ul>			
Code	Name	Causes	Possible Solutions
UL6	Underload or Belt Break Detected	The output current decreased less than the motor underload curve set in L6-14 [Motor Underload Level @ Min Freq] for longer than the time set in L6-03 [Torque Detection Time 1].	Examine parameters L6-13 [Motor Underload Curve Select] and L6-14.
		The belt has broken disconnecting the motor from the load.	
<b>Note:</b> <ul style="list-style-type: none"> <li>If the drive detects this error, the terminal set to H2-01 to H2-03 = 10 [MFDO Function Selection = Alarm] will activate.</li> </ul>			
Code	Name	Causes	Possible Solutions
Uv	Undervoltage	The drive input power voltage is changing too much.	<ul style="list-style-type: none"> <li>Examine the input power for problems.</li> <li>Make the drive input power stable.</li> <li>If the input power supply is good, examine the magnetic contactor on the main circuit side for problems.</li> </ul>
		There is a phase loss in the drive input power.	Correct errors with the wiring for main circuit drive input power.
		There is loose wiring in the drive input power terminals.	Tighten the terminal screws to the correct tightening torque.
		There was a loss of power.	Use a better power supply.
		The main circuit capacitors have become unserviceable.	Examine the capacitor maintenance time in monitor U4-05 [Capacitor Maintenance]. If U4-05 is more than 90%, replace the control board or the drive. For information about replacing the control board, contact Yaskawa or your nearest sales representative.
		The drive input power transformer is too small and voltage drops when the power is switched on.	<ul style="list-style-type: none"> <li>Check for an alarm when a molded-case circuit breaker, Leakage Breaker (ELCB or GFCI) (with overcurrent protective function), or magnetic contactor is ON.</li> <li>Check the capacity of the drive power supply transformer.</li> </ul>
		Air inside the drive is too hot.	Check the ambient temperature of the drive.
		The Charge LED is broken.	Replace the control board or the entire drive. For information about replacing the control board, contact Yaskawa or your nearest sales representative.
<b>Note:</b> <ul style="list-style-type: none"> <li>The drive detects this error if one of these conditions is correct when the Run command has not been input (while the drive is stopped). <ul style="list-style-type: none"> <li>The DC bus voltage &lt; L2-05 [Undervoltage Detection Lvl (Uv1)].</li> <li>The Contactor that prevents inrush current in the drive was opened.</li> <li>There is low voltage in the control drive input power.</li> </ul> </li> <li>If the drive detects this error, the terminal set to H2-01 to H2-03 = 10 [MFDO Function Selection = Alarm] will activate.</li> </ul>			

## 7.6 Parameter Setting Errors

Parameter setting errors occur when multiple parameter settings do not agree, or when parameter setting values are not correct. Refer to the table in this section, examine the parameter setting that caused the error, and remove the cause of the error. You must first correct the parameter setting errors before you can operate the drive. The drive will not send notification signals for the faults and alarms when these parameter setting errors occur.

Code	Name	Causes	Possible Solutions
oPE01	Drive Capacity Setting Error	The value set in <i>o2-04 [Drive Model (KVA) Selection]</i> does not agree with the drive model.	Set <i>o2-04</i> to the correct value.
Code	Name	Causes	Possible Solutions
oPE02	Parameter Range Setting Error	Parameters settings are not in the applicable setting range.	<ol style="list-style-type: none"> <li>Push  to show <i>U1-18 [oPE Fault Parameter]</i>, and find parameters that are not in the applicable setting range.</li> <li>Correct the parameter settings.</li> </ol> <p><b>Note:</b> If more than one error occurs at the same time, other <i>oPExx</i> errors have priority over <i>oPE02</i>.</p>
		You set $E2-01 \leq E2-03$ [ <i>Motor Rated Current (FLA) ≤ Motor No-Load Current</i> ].	Make sure that $E2-01 > E2-03$ . <b>Note:</b> If it is necessary to set $E2-01 < E2-03$ , first lower the value set in <i>E2-03</i> , and then set <i>E2-01</i> .
		The settings for these parameters do not agree: <ul style="list-style-type: none"> <li><i>L8-12 [Ambient Temperature Setting] = 60 °C</i> and <i>L8-35 = 1 or 3 [Installation Method Selection = Side-by-Side Mounting or IP55/UL Type 12]</i> for models 2011 to 2114 and 4005 to 4124</li> <li><i>L8-35 = 1 or 3</i> for models 2143 to 2273 and 4156 to 4302</li> </ul>	Set $L8-35 = 0$ or $2$ [ <i>IP20/UL Open Type or IP20/UL Type 1</i> ].
		The settings for these parameters do not agree: <ul style="list-style-type: none"> <li><i>Y1-01 = 3 [Multiplex Mode = Memobus Network]</i></li> <li><i>F6-16 ≠ 0 [Gateway Mode ≠ Disabled]</i></li> </ul>	When $Y1-01 = 3$ , set $F6-16 = 0$ or disable DriveWorksEZ while $q7-01 ≠ 0$ .
		The settings for these parameters do not agree: <ul style="list-style-type: none"> <li><i>Y1-01 = 3</i></li> <li>The parameter settings to enable Remote I/O function: <ul style="list-style-type: none"> <li><math>A1-07 = 1</math> [<i>DriveWorksEZ Function Selection = DWEZ Enabled</i>]</li> <li><math>q7-01</math> [<i>Slave Address</i>] <math>≠ 0</math></li> <li><math>H1-xx ≠ 9F</math> [<i>MFDI Function Selection ≠ DWEZ Disable</i>]</li> </ul> </li> </ul>	
		You set $S3-09 < S3-10$ [ <i>PI2 Control Output Upper Limit &lt; PI2 Control Output Lower Limit</i> ].	Make sure that $S3-09 > S3-10$ at all times.
		You set $S3-13 > S3-15$ [ <i>PI2 Control Low Feedback Lvl &gt; PI2 Control High Feedback Lvl</i> ].	Make sure that $S3-13 < S3-15$ at all times.
		The settings for these parameters do not agree: <ul style="list-style-type: none"> <li><math>o1-17 = 4</math> [<i>F3 Key Function Selection = RELAY (ON/OFF H2-XX = A9)</i>]</li> <li><math>H2-xx ≠ A9</math> [<i>MFDI Function Selection ≠ RELAY Operator Control</i>]</li> </ul>	<ul style="list-style-type: none"> <li>Set <math>H2-xx = A9</math> to an MFDO.</li> <li>Change the parameter setting to <math>o1-17 ≠ 4</math>.</li> </ul>
Code	Name	Causes	Possible Solutions
oPE03	Multi-Function Input Setting Err	The settings for these parameters do not agree: <ul style="list-style-type: none"> <li><i>H1-01 to H1-07 [Terminals S1 to S7 Function Selection]</i></li> <li><i>H7-01 to H7-04 [Virtual Multi-Function Inputs 1 to 4]</i></li> </ul>	Correct the parameter settings.
		The settings for MFDIs overlap. <b>Note:</b> This does not include $H1-xx = 20$ to $2F$ [ <i>MFDI Function Selection = External Fault</i> ] and [ <i>Reserved</i> ].	Set the parameters correctly to prevent MFDI function overlap.

Code	Name	Causes	Possible Solutions
		<p>These pairs of MFDI functions are not set to Digital Inputs (<i>H1-xx</i> and <i>H7-01</i> to <i>H7-04</i>) at the same time:</p> <ul style="list-style-type: none"> <li>Setting values 10 [<i>Up Command</i>] and 11 [<i>Down Command</i>]</li> <li>Setting values 42 [<i>Run Command (2-Wire Sequence 2)</i>] and 43 [<i>FWD/REV (2-Wire Sequence 2)</i>]</li> </ul>	Set the MFDI pairs.
		<p>A minimum of two of these MFDI combinations are set to Digital Inputs (<i>H1-xx</i> and <i>H7-01</i> to <i>H7-04</i>) at the same time:</p> <ul style="list-style-type: none"> <li>Setting values 10 [<i>Up Command</i>] and 11 [<i>Down Command</i>]</li> <li>Setting value 1E [<i>Reference Sample Hold</i>]</li> <li>Setting values 44 to 46 [<i>Add Offset Frequency 1 to 3 (d7-01 to d7-03)</i>]</li> </ul>	Remove the function settings that are not in use.
		<p>The parameter settings are enabled at the same time.</p> <ul style="list-style-type: none"> <li><i>b5-01</i> [<i>PID Mode Setting</i>]</li> <li><i>H1-xx</i> = 10 [<i>Up Command</i>]</li> <li><i>H1-xx</i> = 11 [<i>Down Command</i>]</li> </ul>	<ul style="list-style-type: none"> <li>Set <i>b5-01</i> = 0 [<i>Disabled</i>].</li> <li>Remove the function Up/Down command settings.</li> </ul>
		<p>These commands are set in Digital Inputs (<i>H1-xx</i> and <i>H7-01</i> to <i>H7-04</i>) at the same time:</p> <ul style="list-style-type: none"> <li>Setting values 61 [<i>Speed Search from Fmax</i>] and 62 [<i>Speed Search from Fref</i>]</li> <li>Setting values 65, 66, 7A, 7B [<i>KEB Ride-Thru 1 or 2 Activate</i>] and 68 [<i>High Slip Braking (HSB) Activate</i>]</li> <li>Setting values 65, 66 [<i>KEB Ride-Thru 1 Activate</i>] and 7A, 7B [<i>KEB Ride-Thru 2 Activate</i>]</li> <li>Setting values 40, 41 [<i>Forward RUN (2-Wire), Reverse RUN (2-Wire)</i>] and 42, 43 [<i>Run Command (2-Wire Sequence 2), FWD/REV (2-Wire Sequence 2)</i>]</li> </ul>	Remove the function settings that are not in use.
		<p>These groups of MFDI functions are not set to Digital Inputs (<i>H1-xx</i> and <i>H7-01</i> to <i>H7-04</i>) at the same time:</p> <ul style="list-style-type: none"> <li>Setting values 3E [<i>PID Setpoint Selection 1</i>] and 3F [<i>PID Setpoint Selection 2</i>]</li> <li>Setting values 83 [<i>Dedicated Multi-Setpoint YA-02</i>], 84 [<i>Dedicated Multi-Setpoint YA-03</i>], and 85 [<i>Dedicated Multi-Setpoint YA-04</i>]</li> </ul>	Set the MFDI groups correctly.
		<p>Two of these three MFDI functions are set to Digital Inputs (<i>H1-xx</i> and <i>H7-01</i> to <i>H7-04</i>) at the same time:</p> <ul style="list-style-type: none"> <li>Setting value 50 [<i>Motor Pre-heat 2</i>]</li> <li>Setting value 60 [<i>DC Injection Braking Command</i>]</li> <li>Setting value 6A [<i>Drive Enable</i>]</li> </ul>	Remove the function setting that are not in use and use only one function.
		<p>Settings for N.C. and N.O. input [<i>H1-xx</i>] for these functions were selected at the same time:</p> <ul style="list-style-type: none"> <li>Setting value 15 [<i>Fast Stop (N.O.)</i>]</li> <li>Setting value 17 [<i>Fast Stop (N.C.)</i>]</li> </ul>	Remove one of the function settings.
		<p>These MFDI functions are set at the same time:</p> <ul style="list-style-type: none"> <li><i>H1-xx</i> ≠ 6A [<i>Drive Enable</i>] and <i>H1-xx</i> ≠ 70 [<i>Drive Enable 2</i>]</li> <li><i>H2-xx</i> = 38 [<i>Drive Enabled</i>]</li> </ul>	<ul style="list-style-type: none"> <li>Set <i>H1-xx</i> = 6A or 70.</li> <li>Change the MFDO setting.</li> </ul>
		<p>These MFDI functions are set at the same time:</p> <ul style="list-style-type: none"> <li><i>H1-xx</i> = 6A [<i>Drive Enable</i>]</li> <li><i>H1-xx</i> = 70 [<i>Drive Enable 2</i>]</li> </ul>	Remove one of the function settings.
		<p>These MFDI functions are set at the same time:</p> <ul style="list-style-type: none"> <li><i>H1-xx</i> = 69 [<i>Jog Run 2</i>]</li> <li><i>H1-xx</i> = 12 [<i>Forward Jog</i>] or <i>H1-xx</i> = 13 [<i>Reverse Jog</i>]</li> </ul>	<p>Make sure the operation direction of Jog Run 2 and remove one of the function settings <i>H1-xx</i> = 12 or <i>H1-xx</i> = 13.</p> <p><b>Note:</b> The direction command from 3-wire sequence sets the operation direction of Jog Run 2.</p>
		<p>These parameters are set at the same time:</p> <ul style="list-style-type: none"> <li><i>H1-xx</i> = 62 [<i>Speed Search from Fref</i>]</li> <li><i>H5-22</i> = 1 [<i>Speed Search from MODBUS = Enabled</i>]</li> </ul>	Remove one of the function settings.

## 7.6 Parameter Setting Errors

Code	Name	Causes	Possible Solutions
		The MFDI setting is $H1-xx = 69$ [Jog Run 2] but the drive is not in 3-wire sequence or 2-wire sequence 2 control.	<ul style="list-style-type: none"> <li>Remove the setting of <math>H1-xx = 69</math>.</li> <li>Set <math>H1-xx = 0</math> [3-Wire Sequence].</li> </ul>
		Parameter $S3-01 \neq 0$ [PI2 Control Enable Selection $\neq$ Disabled] and MFDI set for $H1-xx = AD$ [Select PI2 Control PI Parameters] is ON.	<ul style="list-style-type: none"> <li>Set <math>S3-01 = 0</math> to use <math>H1-xx = AD</math> for the adjustments of <math>S3-06</math> [PI2 Control Proportional Gain] and <math>S3-07</math> [PI2 Control Integral Time] instead of the primary PI controller Proportional and Integral adjustments.</li> <li>When PI2 Control is necessary, remove the MFDI function setting.</li> </ul>
Code	Name	Causes	Possible Solutions
oPE05	Run Cmd/Freq Ref Source Sel Err	The setting to assign the Run command or frequency reference to an option card is incorrect.	Correct the parameter settings.
		$b1-01 = 3$ [Frequency Reference Selection 1 = Option PCB] is set, but there is no option card connected to the drive.	Connect an option card to the drive.
		$b1-02 = 3$ [Run Command Selection 1 = Option PCB] is set, but there is no option card connected to the drive.	
		When $S5-04 = 0$ [HAND-OFF-AUTO Behavior = Legacy], you set $b1-02 \neq 7, 8, \text{ or } 9$ [Run Command Selection 1 $\neq$ AUTO Command + Term Run, AUTO Command + Serial Run, or AUTO Command + Option Run].	Set $b1-02 = 7, 8, \text{ or } 9$ .
		When $S5-10 = 2$ [AUTO Key Memory at Power Down = AUTO Mode], you set $b1-02 = 0$ [Keypad].	Change the $b1-02$ or $S5-10$ setting.
Code	Name	Causes	Possible Solutions
oPE07	Analog Input Selection Error	The settings for $H3-02$ and $H3-10$ [MFAI Function Selection] and $H7-30$ [Virtual Analog Input Selection] overlap.	Set $H3-02$ , $H3-10$ , and $H7-30$ correctly to prevent overlap. <b>Note:</b> It is possible to set these functions to multiple analog input terminals at the same time: <ul style="list-style-type: none"> <li>Setting value 0 [Frequency Reference]</li> <li>Setting values F and 1F [Not Used]</li> </ul>
Code	Name	Causes	Possible Solutions
oPE08	Parameter Selection Error	You set a function that is not compatible with the control method set in $A1-02$ [Control Method Selection].	1. Push  to show $U1-18$ [oPE Fault Parameter], and find parameters that are not in the applicable setting range. 2. Correct the parameter settings. <b>Note:</b> If more than one error occurs at the same time, other oPExx errors have priority over oPE02.
		When $A1-02 = 0$ [Control Method Selection = V/f], you set these parameters: <ul style="list-style-type: none"> <li><math>S1-01 = 1</math> [Dynamic Noise Control = Enabled]</li> <li><math>Y4-42 \neq 0</math> [Output Disconnect Detection Sel <math>\neq</math> Disabled]</li> </ul>	Set $S1-01 = 0$ or $Y4-42 = 0$ .
		When $A1-02 = 5$ [OLV/PM], you set $E5-02$ to $E5-07$ [PM Motor Parameters] = 0.	<ul style="list-style-type: none"> <li>Set <math>E5-01</math> [PM Motor Code Selection] correctly as specified by the motor.</li> <li>For specialized motors, refer to the motor test report and set <math>E5-xx</math> correctly.</li> </ul>
		When $A1-02 = 5$ , you used these parameter settings: <ul style="list-style-type: none"> <li><math>E5-09 = 0.0</math> [PM Back-EMF Vpeak (mV/(rad/s)) = 0.0 mV/(rad/s)]</li> <li><math>E5-24 = 0.0</math> [PM Back-EMF L-L Vrms (mV/rpm) = 0.0 mV/min<sup>-1</sup>]</li> </ul>	Set $E5-09$ or $E5-24$ to the correct value.
		When $A1-02 = 5$ , you set $E5-09 \neq 0$ and $E5-24 \neq 0$ .	Set $E5-09 = 0$ or $E5-24 = 0$ .
		When $A1-02 = 8$ [EZOLV], you used these parameter settings: <ul style="list-style-type: none"> <li><math>E9-01 = 1, 2</math> [Motor Type Selection = Permanent Magnet (PM), Synchronous Reluctance (SynRM)]</li> <li><math>b3-24 = 2</math> [Speed Search Method Selection = Current Detection 2]</li> </ul>	When $E9-01 = 1$ or $2$ , set $b3-24 = 1$ [Speed Estimation].
		You set $L6-02$ [Torque Detection Level 1] < $L6-14$ [Motor Underload Level @ Min Freq].	Set parameters to be $L6-02 \geq L6-14$ .

Code	Name	Causes	Possible Solutions
oPE09	PID Control Selection Fault	These parameters are set at the same time: <ul style="list-style-type: none"> <li>• <math>b5-01 = 1</math></li> <li>• <math>b5-11 = 1</math> [PID Output Reverse Selection = Negative Output Accepted]</li> </ul> And one of these parameters is set: <ul style="list-style-type: none"> <li>• <math>d2-02 \neq 0.0</math> [Frequency Reference Lower Limit <math>\neq 0.0\%</math>]</li> <li>• <math>Y1-06 \neq 0.0</math> [Minimum Speed <math>\neq 0.0\%</math>]</li> <li>• <math>Y4-12 \neq 0.0</math> [Thrust Frequency <math>\neq 0.0\%</math>]</li> <li>• <math>Y1-01 \neq 0</math> [Multiplex Mode <math>\neq</math> Drive Only]</li> <li>• <math>YF-01 \neq 0</math> [PI Aux Control Selection <math>\neq</math> Disabled]</li> </ul>	Correct the parameter settings.
		Parameter $b5-01 = 3$ and one of these parameters is set at the same time: <ul style="list-style-type: none"> <li>• <math>d2-02 \neq 0.0</math></li> <li>• <math>Y1-06 \neq 0.0</math></li> <li>• <math>Y4-12 \neq 0.0</math></li> <li>• <math>Y1-01 \neq 0</math></li> <li>• <math>YF-01 \neq 0</math></li> </ul>	Correct the parameter settings.
<b>Note:</b> The drive detects this error if the PID control function selection is incorrect. (When $b5-01 = 1$ or $3$ [PID Mode Setting = Standard or Fref + PID Trim])			
Code	Name	Causes	Possible Solutions
oPE10	V/f Data Setting Error	The parameters that set the V/f pattern do not satisfy these conditions: <ul style="list-style-type: none"> <li>• For motor 1: <math>E1-09 \leq E1-07 &lt; E1-06 \leq E1-11 \leq E1-04</math> [Minimum Output Frequency <math>\leq</math> Mid Point A Frequency <math>&lt;</math> Base Frequency <math>\leq</math> Mid Point B Frequency <math>\leq</math> Maximum Output Frequency]</li> <li>• For motor 2: <math>E3-09 \leq E3-07 &lt; E3-06 \leq E3-11 \leq E3-04</math> [Minimum Output Frequency <math>\leq</math> Mid Point A Frequency <math>&lt;</math> Base Frequency <math>\leq</math> Mid Point B Frequency <math>\leq</math> Maximum Output Frequency]</li> </ul>	Set the parameters correctly to satisfy the conditions.
Code	Name	Causes	Possible Solutions
oPE11	Carrier Frequency Setting Error	These parameters are set at the same time: <ul style="list-style-type: none"> <li>• <math>C6-05 &gt; 6</math> [Carrier Freq Proportional Gain <math>&gt; 6</math>]</li> <li>• <math>C6-04 &gt; C6-03</math> [Carrier Frequency Lower Limit <math>&gt;</math> Carrier Frequency Upper Limit]</li> </ul> <b>Note:</b> When $C6-05 < 7$ , $C6-04$ becomes disabled. $C6-03$ stays active.	Set $C6-02$ to $C6-05$ correctly.
		$C6-02$ to $C6-05$ settings are not in the applicable setting range.	
Code	Name	Causes	Possible Solutions
oPE16	Energy Saving Constants Error	The Energy Saving parameters are not set in the applicable setting range.	Make sure that $E5-xx$ is set correctly as specified by the motor nameplate data.
		These parameters are set at the same time: <ul style="list-style-type: none"> <li>• <math>b8-01 = 1</math> [Energy Saving Control Selection = Enabled]</li> <li>• <math>S1-01 = 1</math> [Dynamic Noise Control = Enabled]</li> </ul>	Disable Energy Saving Control or Dynamic Noise Control.
Code	Name	Causes	Possible Solutions
oPE33	Digital Output Selection Error	These two parameters are set at the same time: <ul style="list-style-type: none"> <li>• <math>H2-60 \neq F</math> [Term M1-M2 Secondary Function <math>\neq</math> Not Used]</li> <li>• <math>H2-01 = 1xx</math> [Term M1-M2 Function Selection = Inverse output of <math>xx</math>]</li> </ul>	Clear the $H2-01$ to $H2-03 = 1xx$ [Inverse output of $xx$ ] settings. <b>Note:</b> It is not possible to set $H2-01$ to $H2-03 = 1xx$ [Inverse output of $xx$ ] when using output functions for logic operations ( $H2-60$ , $H2-63$ , $H2-66 \neq F$ ).
		These two parameters are set at the same time: <ul style="list-style-type: none"> <li>• <math>H2-63 \neq F</math> [Term M3-M4 Secondary Function <math>\neq</math> Not Used]</li> <li>• <math>H2-02 = 1xx</math> [Term M3-M4 Function Selection = Inverse output of <math>xx</math>]</li> </ul>	
		These two parameters are set at the same time: <ul style="list-style-type: none"> <li>• <math>H2-66 \neq F</math> [Term M5-M6 Secondary Function <math>\neq</math> Not Used]</li> <li>• <math>H2-03 = 1xx</math> [Term M5-M6 Function Selection = Inverse output of <math>xx</math>]</li> </ul>	

## 7.6 Parameter Setting Errors

Code	Name	Causes	Possible Solutions
oPE34	HAND/OFF/AUTO Input Setting	When $S5-04 = 0$ [HAND-OFF-AUTO Behavior = Legacy], $H1-xx = 6D$ and $6E$ [MFDI Function Selection = AUTO Command and HAND Command] are set at the same time.	Set only one of the two functions $H1-xx = 6D$ or $6E$ .
		When $S5-04 = 1$ [HAND-OFF-AUTO Behavior = Normal] and $b1-02 \neq 1$ [Run Command Selection 1 $\neq$ Digital Input], only one of $H1-xx = 6D$ or $6E$ is set.	Set $H1-xx = 6D$ and $6E$ for operation from terminals, or remove both input settings.
		These parameters are set at the same time: <ul style="list-style-type: none"> <li>• <math>S5-04 = 1</math></li> <li>• <math>b1-02 = 1</math></li> <li>• <math>H1-xx = 6D</math></li> </ul>	Remove the MFDI setting of $H1-xx = 6D$ . <b>Note:</b> When $S5-04 = 1$ and $b1-02 = 1$ , the AUTO Mode Run command comes from the Run command MFDI based on one of these operation sequence settings: <ul style="list-style-type: none"> <li>• <math>H1-xx = 0</math> [3-Wire Sequence]</li> <li>• <math>H1-xx = 40</math> [Forward RUN (2-Wire)]</li> <li>• <math>H1-xx = 41</math> [Reverse RUN (2-Wire)]</li> <li>• <math>H1-xx = 42</math> [Run Command (2-Wire Sequence 2)]</li> </ul>
Code	Name	Causes	Possible Solutions
oPE35	Network PI Aux Operation Mode	These parameter settings are not compatible: <ul style="list-style-type: none"> <li>• <math>Y9-50 \neq 0</math> [PI Auxiliary Control Source <math>\neq</math> Analog Only]</li> <li>• <math>Y9-51 = 1</math> [PI Aux Control Turn-Off Method = Enabled]</li> </ul>	Examine the settings for $Y9-50$ and $Y9-51$ .



## 7.7 Auto-Tuning Errors

This table gives information about errors detected during Auto-Tuning. If the drive detects an Auto-Tuning error, the keypad will show the error and the motor will coast to stop. The drive will not send notification signals for faults and alarms when Auto-Tuning errors occur.

Two types of Auto-Tuning errors are: *Endx* and *Erx*. *Endx* identifies that Auto-Tuning has successfully completed with calculation errors. Find and repair the cause of the error and do Auto-Tuning again, or set the motor parameters manually. You can use the drive in the application if you cannot find the cause of the *Endx* error.

*Erx* identifies that Auto-Tuning was not successful. Find and repair the cause of the error and do Auto-Tuning again.

Code	Name	Causes	Possible Solutions
End1	Excessive Rated Voltage Setting	The torque reference was more than 20% during Auto-Tuning or the no-load current that was measured after Auto-Tuning is more than 80%.	<ul style="list-style-type: none"> <li>Make sure that the input motor nameplate data is correct.</li> <li>Do Auto-Tuning again and correctly set the motor nameplate data.</li> <li>If you can uncouple the motor and load, remove the motor from the machine and do Rotational Auto-Tuning again.</li> <li>If you cannot uncouple the motor and load, use the results from Auto-Tuning.</li> </ul>
Code	Name	Causes	Possible Solutions
End2	Iron Core Saturation Coefficient	The motor nameplate data entered during Auto-Tuning is incorrect.	<ul style="list-style-type: none"> <li>Make sure that the input motor nameplate data is correct.</li> <li>Do Auto-Tuning again and correctly set the motor nameplate data.</li> </ul>
Code	Name	Causes	Possible Solutions
End3	Rated Current Setting Alarm	The rated current value is incorrect.	Do Auto-Tuning again and set the correct rated current shown on the motor nameplate.
Code	Name	Causes	Possible Solutions
End4	Adjusted Slip Calculation Error	The Auto-Tuning results were not in the applicable parameter setting range.	<ul style="list-style-type: none"> <li>Make sure the input motor nameplate data is correct.</li> <li>Do Rotational Auto-Tuning again and correctly set the motor nameplate data.</li> <li>If you cannot uncouple the motor and load, do Stationary Auto-Tuning 2.</li> </ul>
		The motor rated slip that was measured after Stationary Auto-Tuning was 0.2 Hz or lower.	
		The secondary resistor measurement results were not in the applicable range.	
Code	Name	Causes	Possible Solutions
End5	Resistance Tuning Error	The Auto-Tuning results of the Line-to-Line Resistance were not in the applicable range.	<ul style="list-style-type: none"> <li>Make sure that the input motor nameplate data is correct.</li> <li>Examine and repair damaged motor wiring.</li> </ul>
Code	Name	Causes	Possible Solutions
End6	Leakage Inductance Alarm	The Auto-Tuning results were not in the applicable parameter setting range.	Make sure that the input motor nameplate data is correct, and do Auto-Tuning again.
		<i>A1-02 [Control Method Selection]</i> setting is not applicable.	<ul style="list-style-type: none"> <li>Examine the value set in <i>A1-02</i>.</li> <li>Make sure that the input motor nameplate data is correct, and do Auto-Tuning again.</li> </ul>
Code	Name	Causes	Possible Solutions
End7	No-Load Current Alarm	The Auto-Tuning results of the motor no-load current value were not in the applicable range.	Examine and repair damaged motor wiring.
		Auto-Tuning results were less than 5% of the motor rated current.	Make sure that the input motor nameplate data is correct, and do Auto-Tuning again.
Code	Name	Causes	Possible Solutions
End8	HFI Alarm	<ul style="list-style-type: none"> <li>Inductance saliency ratio (<i>E5-07/E5-06</i>) is too small.</li> <li>The drive cannot find the <i>n8-36 [HFI Frequency Level for L Tuning]</i> value.</li> </ul>	<ul style="list-style-type: none"> <li>Set the correct value on the motor nameplate to <i>E5-xx [PM Motor Settings]</i> or do rotational/stationary Auto-Tuning.</li> <li>When it is necessary to set <i>n8-35 = 1 [Initial Pole Detection Method = High Frequency Injection]</i>, make sure that there is no unusual noise in the low speed range (10% or less) and that the motor does not rotate in reverse at start.</li> </ul> <p><b>Note:</b> If the drive detects <i>End8</i>, it will automatically set <i>n8-35 = 0 [Pull-in]</i>. Do not change the settings unless necessary.</p>

## 7.7 Auto-Tuning Errors

Code	Name	Causes	Possible Solutions
End9	Initial Pole Detection Alarm	The drive cannot calculate the correct value for <i>n8-84</i> [Polarity Detection Current] during High Frequency Injection Tuning.	When <i>n8-35</i> = 1 [Initial Pole Detection Method = High Frequency Injection], make sure that the motor does not rotate in reverse at start. <b>Note:</b> If the drive detects <i>End9</i> , it will automatically set <i>n8-35</i> = 0 [Pull-in]. Do not change the settings unless necessary.
Code	Name	Causes	Possible Solutions
Er-01	Motor Data Error	The motor nameplate data entered during Auto-Tuning is incorrect.	<ul style="list-style-type: none"> <li>Make sure that the motor nameplate data is correct.</li> <li>Do Auto-Tuning again and correctly set the motor nameplate data.</li> </ul>
		The combination of the motor rated power and motor rated current do not match.	<ul style="list-style-type: none"> <li>Examine the combination of drive capacity and motor output.</li> <li>Do Auto-Tuning again, and correctly set the motor rated power and motor rated current.</li> </ul>
		The combination of the motor rated current that was entered during Auto-Tuning and <i>E2-03</i> [Motor No-Load Current] do not match.	<ul style="list-style-type: none"> <li>Examine the motor rated current and the no-load current.</li> <li>Set <i>E2-03</i> correctly.</li> <li>Do Auto-Tuning again, and correctly set the motor rated current.</li> </ul>
		The combination of the setting values of Motor Base Frequency and Motor Base Speed do not match.	Do Auto-Tuning again, and correctly set the Motor Base Frequency and Motor Base Speed.
Code	Name	Causes	Possible Solutions
Er-02	Drive in an Alarm State	The motor nameplate data entered during Auto-Tuning is incorrect.	<ul style="list-style-type: none"> <li>Make sure that the motor nameplate data entered in Auto-Tuning is correct.</li> <li>Do Auto-Tuning again and correctly set the motor nameplate data.</li> </ul>
		You did Auto-Tuning while the drive had a minor fault or alarm.	Clear the minor fault or alarm and do Auto-Tuning again.
		There is a defective motor cable or cable connection.	Examine and repair motor wiring.
		The load is too large.	<ul style="list-style-type: none"> <li>Decrease the load.</li> <li>Examine the machine area to see if, for example, the motor shaft is locked.</li> </ul>
		The drive detected a minor fault during Auto-Tuning.	<ol style="list-style-type: none"> <li>Stop Auto-Tuning.</li> <li>Examine the minor fault code and remove the cause of the problem.</li> <li>Do Auto-Tuning again.</li> </ol>
Code	Name	Causes	Possible Solutions
Er-03	OFF Button was Pressed	You pushed  during Auto-Tuning.	Auto-Tuning did not complete correctly. Do Auto-Tuning again.
Code	Name	Causes	Possible Solutions
Er-04	Line-to-Line Resistance Error	The Auto-Tuning results were not in the applicable parameter setting range.	<ul style="list-style-type: none"> <li>Examine and repair motor wiring.</li> <li>Disconnect the machine from the motor and do Rotational Auto-Tuning again.</li> </ul>
		Auto-Tuning did not complete in a pre-set length of time.	
		There is a defective motor cable or cable connection.	<ul style="list-style-type: none"> <li>Make sure that the input motor nameplate data is correct.</li> <li>Do Auto-Tuning again and correctly set the motor nameplate data.</li> </ul>
		The motor nameplate data entered during Auto-Tuning is incorrect.	
Code	Name	Causes	Possible Solutions
Er-05	No-Load Current Error	The Auto-Tuning results were not in the applicable parameter setting range.	<ul style="list-style-type: none"> <li>Examine and repair motor wiring.</li> <li>Disconnect the machine from the motor and do Rotational Auto-Tuning again.</li> </ul>
		Auto-Tuning did not complete in a pre-set length of time.	
		The motor nameplate data entered during Auto-Tuning is incorrect.	<ul style="list-style-type: none"> <li>Make sure that the input motor nameplate data is correct.</li> <li>Do Auto-Tuning again and correctly set the motor nameplate data.</li> </ul>
		Rotational Auto-Tuning was done with a load that was more than 30% of the rating connected to the motor.	<ul style="list-style-type: none"> <li>Disconnect the machine from the motor and do Rotational Auto-Tuning again.</li> <li>If you cannot uncouple the motor and load, make sure that the load is less than 30% of the motor rating. If a mechanical brake is installed in the motor, release the brake during Rotational Auto-Tuning.</li> </ul>

Code	Name	Causes	Possible Solutions
Er-08	Rated Slip Error	The motor nameplate data entered during Auto-Tuning is incorrect.	<ul style="list-style-type: none"> <li>Make sure that the input motor nameplate data is correct.</li> <li>Do Auto-Tuning again and correctly set the motor nameplate data.</li> </ul>
		Auto-Tuning did not complete in a pre-set length of time.	<ul style="list-style-type: none"> <li>Examine and repair the motor wiring.</li> <li>If the motor and machine are connected during Rotational Auto-Tuning, decouple the motor from the machinery.</li> </ul>
		The Auto-Tuning results were not in the applicable parameter setting range.	
		Rotational Auto-Tuning was done with a load that was more than 30% of the rating connected to the motor.	<ul style="list-style-type: none"> <li>Disconnect the machine from the motor and do Rotational Auto-Tuning again.</li> <li>If you cannot uncouple the motor and load, make sure that the load is less than 30% of the motor rating. If a mechanical brake is installed in the motor, release the brake during Rotational Auto-Tuning.</li> </ul>
Code	Name	Causes	Possible Solutions
Er-09	Acceleration Error	The motor did not accelerate for the specified acceleration time.	<ol style="list-style-type: none"> <li>Increase the value set in <i>C1-01 [Acceleration Time 1]</i>.</li> <li>Disconnect the machine from the motor and do Rotational Auto-Tuning again.</li> </ol>
		Rotational Auto-Tuning was done with a load that was more than 30% of the rating connected to the motor.	<ul style="list-style-type: none"> <li>Disconnect the machine from the motor and do Rotational Auto-Tuning again.</li> <li>If you cannot uncouple the motor and load, make sure that the load is less than 30% of the motor rating. If a mechanical brake is installed in the motor, release the brake during Rotational Auto-Tuning.</li> </ul>
Code	Name	Causes	Possible Solutions
Er-12	Current Detection Error	There is a phase loss in the drive input power. (U/T1, V/T2, W/T3)	Examine and repair motor wiring.
		The current exceeded the current rating of the drive.	<ul style="list-style-type: none"> <li>Check the motor wiring for any short circuits between the wires.</li> <li>Check and turn ON any magnetic contactors used between motors.</li> <li>Replace the control board or the drive. For information about replacing the control board, contact Yaskawa or your nearest sales representative.</li> </ul>
		The output current is too low.	
		You tried Auto-Tuning without a motor connected to the drive.	Connect the motor and do Auto-Tuning.
		There was a current detection signal error.	Replace the control board or the drive. For information about replacing the control board, contact Yaskawa or your nearest sales representative.
Code	Name	Causes	Possible Solutions
Er-13	Leakage Inductance Error	The motor rated current value is incorrect.	Correctly set the rated current indicated on the motor nameplate and do Auto-Tuning again.
		The drive could not complete tuning for leakage inductance in fewer than 300 s.	Examine and repair motor wiring.
Code	Name	Causes	Possible Solutions
Er-18	Back EMF Error	The result of the induced voltage tuning was not in the applicable range.	<ol style="list-style-type: none"> <li>Make sure that the input motor nameplate data is correct.</li> <li>Do Auto-Tuning again and correctly set the motor nameplate data.</li> </ol>
Code	Name	Causes	Possible Solutions
Er-19	PM Inductance Error	The Auto-Tuning results of the PM motor inductance were not in the applicable range.	<ol style="list-style-type: none"> <li>Make sure that the input motor nameplate data is correct.</li> <li>Do Auto-Tuning again and correctly set the motor nameplate data.</li> </ol>
Code	Name	Causes	Possible Solutions
Er-20	Stator Resistance Error	The Auto-Tuning results of the PM Motor Stator Resistance were not in the applicable range.	<ol style="list-style-type: none"> <li>Make sure that the input motor nameplate data is correct.</li> <li>Do Auto-Tuning again and correctly set the motor nameplate data.</li> </ol>
Code	Name	Causes	Possible Solutions
Er-25	HighFreq Inject Param Tuning Err	The motor data is incorrect.	<p>Do Stationary Auto-Tuning again.</p> <p><b>Note:</b></p> <p>If the drive detects <i>Er-25</i> after you do Stationary Auto-Tuning, it is possible that the motor cannot use high frequency injection. For more information, contact Yaskawa or your nearest sales representative.</p>

## 7.8 Backup Function Operating Mode Display and Errors

### ◆ Operating Mode Display

When you use the backup function from the keypad, the keypad will show messages related to the current operation. These messages will not identify errors in the drive operation.

Keypad Display	Name	Display	State
Drive and Keypad mismatch. Should the parameters be restored?	Detection of inconsistency between the drive and keypad	Normally displayed	The drive detected the connection of a keypad from a different drive. Select [Yes] to copy parameters backed up in the keypad to the connected drive.
Restore Restore from keypad	Restoring parameters	Flashing	The parameters stored in the keypad have been restored to the drive.
End	Backup/restore/verify operation ended normally	Normally displayed	The parameter backup, restore, or verify operation ended normally.
Backup Backup from Drive	Backing up parameters	Flashing	The parameters stored in the drive are being backed up to the keypad.
Verify Keypad & Drive	Verifying parameters	Flashing	The parameter settings stored in the keypad and the parameter settings in the drive align or are being compared.

### ◆ Backup Function Runtime Errors

When an error occurs, the keypad shows a code to identify the error.

The table in this section shows the error codes. Refer to this table to remove the cause of the errors.

**Note:**

Push any key on the keypad to clear an error.

Code	Name	Causes	Possible Solutions
CPEr	Control Mode Mismatch	The keypad setting and drive setting for <i>A1-02</i> [ <i>Control Method Selection</i> ] do not agree.	<ol style="list-style-type: none"> <li>Set <i>A1-02</i> on the drive to the same value that is on the keypad.</li> <li>Restore the parameters.</li> </ol>
Code	Name	Causes	Possible Solutions
CPyE	Error Writing Data	Parameter restore did not end correctly.	Restore the parameters.
Code	Name	Causes	Possible Solutions
CSEr	Control Mode Mismatch	The keypad is broken.	Replace the keypad.
Code	Name	Causes	Possible Solutions
dFPS	Drive Model Mismatch	You tried to restore parameters to a different drive model than the one that you backed up.	<ol style="list-style-type: none"> <li>Examine the drive model that you used to back up the parameters.</li> <li>Restore the parameters.</li> </ol>
Code	Name	Causes	Possible Solutions
iFEr	Keypad Communication Error	There was a communications error between the keypad and the drive.	Examine the connector or cable connection.
Code	Name	Causes	Possible Solutions
ndAT	Error Received Data	The parameter settings for model and specifications (power supply voltage and capacity) are different between the keypad and the drive.	<ol style="list-style-type: none"> <li>Make sure that drive model and the value set in <i>o2-04</i> [<i>Drive Model (KVA) Selection</i>] agree.</li> <li>Restore the parameters.</li> </ol>
		The parameters are not stored in the keypad.	<ol style="list-style-type: none"> <li>Connect a keypad that has the correct parameters.</li> <li>Restore the parameters.</li> </ol>
Code	Name	Causes	Possible Solutions
PWEr	DWEZ Password Mismatch	The password set in the backup operation with <i>qx-xx</i> [ <i>DriveWorksEZ Parameters</i> ] and <i>rx-xx</i> [ <i>DriveWorksEZ Connections</i> ] is incorrect.	Set the DWEZ PC software password supplied by Yaskawa for the DWEZ program user ID downloaded to the drive.
<b>Note:</b>			
<i>U8-11</i> and <i>U8-12</i> [ <i>DWEZ Versions 1 and 2</i> ] show the user ID of the DWEZ program.			

## 7.8 Backup Function Operating Mode Display and Errors

Code	Name	Causes	Possible Solutions
rdEr	Error Reading Data	You tried to back up the data when <i>o3-02 = 0 [Copy Allowed Selection = Disabled]</i> .	Set <i>o3-02 = 1 [Enabled]</i> and back up again.
Code	Name	Causes	Possible Solutions
vAEr	Voltage Class, Capacity Mismatch	The power supply specifications or drive capacity parameter settings are different between the keypad and the drive.	<ol style="list-style-type: none"> <li>1. Make sure that drive model and the value set in <i>o2-04 [Drive Model (KVA) Selection]</i> agree.</li> <li>2. Restore the parameters.</li> </ol>
Code	Name	Causes	Possible Solutions
vFyE	Parameters do not Match	The parameters that are backed up in the keypad and the parameters in the drive are not the same.	<ol style="list-style-type: none"> <li>1. Restore or backup the parameter again.</li> <li>2. Verify the parameters.</li> </ol>

## 7.9 Diagnosing and Resetting Faults

When a fault occurs and the drive stops, do the procedures in this section to remove the cause of the fault, then re-energize the drive.

### ◆ Fault and Power Loss Occur at the Same Time

**WARNING! Crush Hazard.** Wear eye protection when you do work on the drive. If you do not use correct safety equipment, it can cause serious injury or death.

**WARNING! Electrical Shock Hazard.** After the drive blows a fuse or trips a GFCI, do not immediately energize the drive or operate peripheral devices. Wait for the time specified on the warning label at a minimum and make sure that all indicators are OFF. Then check the wiring and peripheral device ratings to find the cause of the problem. If you do not know the cause of the problem, contact Yaskawa before you energize the drive or peripheral devices. If you do not fix the problem before you operate the drive or peripheral devices, it can cause serious injury or death.

1. Supply power to the control circuit from the external 24 V input.
2. Use monitor parameters  $U2-xx$  [*Fault Trace*] to show the fault code and data about the operating status of the drive immediately before the fault occurred.
3. Use the information in the Troubleshooting tables to remove the fault.

**Note:**

1. To find the faults that were triggered, check the fault history in  $U2-02$  [*Previous Fault*]. To find information about drive status (such as frequency, current, and voltage) when the faults were triggered, check  $U2-03$  to  $U2-20$ .
2. If the fault display stays after you re-energize the drive, remove the cause of the fault and reset.

### ◆ Fault Occurs Without Power Loss

1. Examine the fault code shown on the keypad.
2. Use the information in the Troubleshooting tables to remove the fault.
3. Do a fault reset.

### ◆ Fault Reset

If a fault occurs, you must remove the cause of the fault and re-energize the drive. [Table 7.3](#) lists the different methods to reset the drive after a fault.

**Table 7.3 Fault Reset Methods**

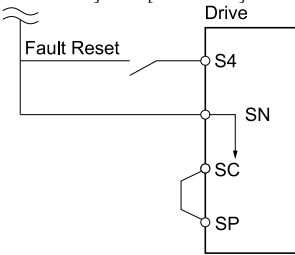
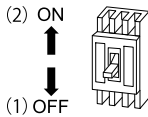
Methods	Description
Method 1	While the keypad is showing the fault or alarm code, push <b>F1</b> (Reset) or  on the keypad.
Method 2	<p>Switch ON the MFDI terminal set to <math>H1-xx = 14</math> [<i>MFDI Function Select = Fault Reset</i>].</p> <p><b>Note:</b> The default setting for <math>H1-04</math> [<i>Terminal S4 Function Selection</i>] is 14 [<i>Fault Reset</i>].</p> 
Method 3	<ol style="list-style-type: none"> <li>1. De-energize the drive main circuit power supply.</li> <li>2. Energize the drive again after the keypad display goes out.</li> </ol> 

**Note:**

If the drive receives a Run command from a communication option or control circuit terminal, the drive will not reset the fault. Remove the Run command then try to clear the fault. If you do a fault reset when the drive has a Run command, the keypad will show minor fault *CrST* [*Remove RUN Command to Reset*].

## 7.10 Troubleshooting Without Fault Display

### Note:

Make sure that you use a keypad with FLASH number 1004 or later. Keypads with FLASH numbers 1003 and earlier will not show characters correctly.

If the drive or motor operate incorrectly, but the keypad does not show a fault or error code, refer to the items in this section.

If there is no display on the keypad and no lights illuminate on the keypad, replace the keypad, control board, or external cooling fan. If the keypad display error stays, replace the drive. For information about replacing the keypad, control board, and external cooling fan, contact Yaskawa or your nearest sales representative.

- Motor hunting and oscillation
- Unsatisfactory motor torque
- Unsatisfactory speed precision
- Unsatisfactory motor torque and speed response
- Motor noise

### ◆ Typical Problems

Symptom	Reference
The Parameter Settings Will Not Change	370
The Motor Does Not Rotate After Entering Run Command	371
The Motor Rotates in the Opposite Direction from the Run Command	372
The Motor Rotates in Only One Direction	372
The Motor Is Too Hot	372
oPE02 Error Occurs When Decreasing the Motor Rated Current Setting	373
The Correct Auto-Tuning Mode Is Not Available	373
The Motor Stalls during Acceleration or Accel/Decel Time Is Too Long	373
The Drive Frequency Reference Is Different than the Controller Frequency Reference Command	374
The Motor Speed Is Not Stable When Using a PM Motor	374
There Is Too Much Motor Oscillation and the Rotation Is Irregular	374
There Is Audible Noise from the Drive or Motor Cables When the Drive Is Energized	374
The Ground Fault Circuit Interrupter (GFCI) Trips During Run	375
Motor Rotation Causes Unexpected Audible Noise from Connected Machinery	375
Motor Rotation Causes Oscillation or Hunting	375
PID Output Fault	375
The Starting Torque Is Not Sufficient	375
The Motor Rotates after the Drive Output Is Shut Off	376
The Output Frequency Is Lower Than the Frequency Reference	376
The Motor Is Making an Audible Noise	376
The Motor Will Not Restart after a Loss of Power	376





### ◆ The Parameter Settings Will Not Change

Causes	Possible Solutions
The drive is operating the motor (the drive is in Drive Mode).	Stop the drive and change to Programming Mode.
Parameter $A1-01 = 0$ [Access Level Selection = Operation Only].	Set $A1-01 = 2$ [Access Level Selection = Advanced Level] or $A1-01 = 3$ [Expert Level].
Parameter $H1-xx = 1B$ [MFDI Function Select = Programming Lockout].	Activate the terminals to which $H1-xx = 1B$ is set, and then change the parameters.



Causes	Possible Solutions
You entered an incorrect password in <i>A1-04 [Password]</i> .	<ul style="list-style-type: none"> <li>Enter the correct password to <i>A1-04</i> again.</li> <li>If you forgot the password, set the password again with <i>A1-04</i> and <i>A1-05 [Password Setting]</i>.</li> </ul> <p><b>Note:</b> If you set the password, you cannot change these parameters until the password aligns:</p> <ul style="list-style-type: none"> <li><i>A1-01 [Access Level Selection]</i></li> <li><i>A1-02 [Control Method Selection]</i></li> <li><i>A1-03 [Initialize Parameters]</i></li> <li><i>A1-06 [Application Preset]</i></li> <li><i>A1-07 [DriveWorksEZ Function Selection]</i></li> <li><i>A2-01 to A2-32 [User Parameter 1 to User Parameter 32]</i></li> </ul>
The drive detected <i>Uv [Undervoltage]</i> .	<ul style="list-style-type: none"> <li>View <i>U1-07 [DC Bus Voltage]</i> to see the power supply voltage.</li> <li>Examine the main circuit wiring.</li> </ul>

## ◆ The Motor Does Not Rotate After Entering Run Command

Causes	Possible Solutions
The drive is not in Drive Mode.	<ol style="list-style-type: none"> <li>Make sure that the keypad shows [Rdy].</li> <li>If the keypad does not show [Rdy], go back to the Home screen.</li> </ol>
Auto-Tuning completed.	Go back to the Home screen on the keypad. <b>Note:</b> When Auto-Tuning completes, the drive changes to Programming Mode. The drive will not accept a Run command unless the drive is in Drive Mode.
The drive stopped, you pushed  , and changed the Run command source to the keypad.	Do one of these two: <ul style="list-style-type: none"> <li>Push .</li> <li>Re-energize the drive.</li> </ul>
The drive received a fast stop command.	Turn off the fast stop input signal.
The settings for the source that supplies the Run command are incorrect.	Set <i>b1-02 [Run Command Selection 1]</i> correctly.
The frequency reference source is set incorrectly.	Set <i>b1-01 [Frequency Reference Selection 1]</i> correctly.
There is defective wiring in the control circuit terminals.	<ul style="list-style-type: none"> <li>Correctly wire the drive control circuit terminals.</li> <li>View <i>U1-10 [Input Terminal Status]</i> for input terminal status.</li> </ul>
The settings for voltage input and current input of the master frequency reference are incorrect.	Examine these analog input terminal signal level settings: <ul style="list-style-type: none"> <li>Terminal A1: Jumper switch S1 and <i>H3-01 [Terminal A1 Signal Level Select]</i></li> <li>Terminal A2: Jumper switch S1 and <i>H3-09 [Terminal A2 Signal Level Select]</i></li> </ul>
The selection for the sinking/sourcing mode and the internal/external power supply is incorrect.	<ul style="list-style-type: none"> <li>For sinking mode, close the circuit between terminals SC-SP with a wire jumper.</li> <li>For sourcing mode, close the circuit between terminals SC-SN with a wire jumper.</li> <li>For external power supply, remove the wire jumper.</li> </ul>
The frequency reference is too low.	<ul style="list-style-type: none"> <li>View <i>U1-01 [Freq Reference]</i>.</li> <li>Increase the frequency reference to a value higher than <i>E1-09 [Minimum Output Frequency]</i>.</li> </ul>
The MFAI setting is incorrect.	<ul style="list-style-type: none"> <li>Make sure that the functions set to the MFAI are correct. The frequency reference is 0 when <i>H3-02, H3-10 = 1 [MFAI Function Select = Frequency Gain]</i> and voltage (current) is not input.</li> <li>View <i>U1-13 and U1-14 [Terminal A1, A2 Input Voltage]</i> to see if the analog input values set to terminals A1 and A2 are applicable.</li> </ul>
 was pushed.	Turn the Run command OFF then ON from an external input. <b>Note:</b> When you push  during operation, the drive will coast to stop. Set <i>o2-02 = 0 [STOP Key Function Selection = Disabled]</i> to disable the  function.
The 2-wire sequence and 3-wire sequence are set incorrectly.	<ul style="list-style-type: none"> <li>Set one of the parameters <i>H1-03 to H1-07 [Terminals S3 to S7 Function Select]</i> to 0 [<i>3-Wire Sequence</i>] to enable the 3-wire sequence.</li> <li>If a 2-wire sequence is necessary, make sure that <i>H1-03 to H1-07 ≠ 0</i>.</li> </ul>

### ◆ The Motor Rotates in the Opposite Direction from the Run Command

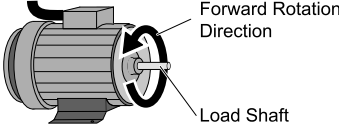
Causes	Possible Solutions
The phase wiring between the drive and motor is incorrect.	<ul style="list-style-type: none"> <li>Examine the wiring between the drive and motor.</li> <li>Connect drive output terminals U/T1, V/T2, and W/T3 in the correct sequence to agree with motor terminals U, V, and W.</li> <li>Switch two motor cables U, V, and W to reverse motor direction.</li> </ul>
The forward direction for the motor is set incorrectly.	<ul style="list-style-type: none"> <li>Connect drive output terminals U/T1, V/T2, and W/T3 in the correct sequence to agree with motor terminals U, V, and W.</li> <li>Switch two motor cables U, V, and W to reverse motor direction.</li> </ul> <div style="text-align: center;">  <p><b>Figure 7.1 Forward Rotating Motor</b></p> <p><b>Note:</b></p> <ul style="list-style-type: none"> <li>For Yaskawa motors, the forward direction is counterclockwise when looking from the motor shaft side.</li> <li>Refer to the motor specifications, and make sure that the forward rotation direction is correct for the application. The forward rotation direction of motors can be different for different motor manufacturers and types.</li> </ul> </div>
The signal connections for forward run and reverse run on the drive control circuit terminals and control panel side are incorrect.	Correctly wire the control circuit.
The motor is running at almost 0 Hz and the Speed Search estimated the speed to be in the opposite direction.	Set <i>b3-14 = 0 [Bi-directional Speed Search = Disabled]</i> , then the drive will only do speed search in the specified direction.

### ◆ The Motor Rotates in Only One Direction

Causes	Possible Solutions
The drive will not let the motor rotate in reverse.	Set <i>b1-04 = 0 [Reverse Operation Selection = Reverse Enabled]</i> .
The drive did not receive a Reverse run signal and 3-Wire sequence is selected.	Activate the terminals to which <i>H1-xx = 0 [3-Wire Sequence]</i> is set, and then enable reverse operation.

### ◆ The Motor Is Too Hot

Causes	Possible Solutions
The load is too heavy.	<ul style="list-style-type: none"> <li>Decrease the load.</li> <li>Increase the acceleration and deceleration times.</li> <li>Examine the values set in <i>L1-01 [Motor Overload (oL1) Protection]</i>, <i>L1-02 [Motor Overload Protection Time]</i>, and <i>E2-01 [Motor Rated Current (FLA)]</i>.</li> <li>Use a larger motor.</li> </ul> <p><b>Note:</b> The motor also has a short-term overload rating. Examine this rating carefully before setting drive parameters.</p>
The motor is running continuously at a very low speed.	<ul style="list-style-type: none"> <li>Change the run speed.</li> <li>Use a drive-dedicated motor.</li> </ul>
The drive is operating in a vector control mode, but Auto-Tuning has not been done.	<ul style="list-style-type: none"> <li>Do Auto-Tuning.</li> <li>Calculate motor parameter and set motor parameters.</li> <li>Set <i>A1-02 = 0 [Control Method Selection = V/f Control]</i>.</li> </ul>
The voltage insulation between motor phases is not sufficient.	<ul style="list-style-type: none"> <li>Use a motor with a voltage tolerance that is higher than the maximum voltage surge.</li> <li>Use a drive-dedicated motor that is rated for use with AC drives for applications that use a motor on drives rated higher than 480 V class.</li> <li>Install an AC reactor on the output side of the drive and set <i>C6-02 = 1 [Carrier Frequency Selection = 2.0 kHz]</i>.</li> </ul> <p><b>Note:</b> When the motor is connected to the drive output terminals U/T1, V/T2, and W/T3, surges occur between the drive switching and the motor coils. These surges can be three times the drive input power supply voltage (600 V for a 208 V class drive, 1200 V for a 480 V class drive).</p>
The air around the motor is too hot.	<ul style="list-style-type: none"> <li>Measure the ambient temperature.</li> <li>Decrease the temperature in the area until it is in the specified temperature range.</li> </ul>
The motor fan stopped or is clogged.	<ul style="list-style-type: none"> <li>Clean the motor fan.</li> <li>Make the drive environment better.</li> </ul>

### ◆ oPE02 Error Occurs When Decreasing the Motor Rated Current Setting

Causes	Possible Solutions
Motor rated current and the motor no-load current setting in the drive are incorrect.	<ul style="list-style-type: none"> <li>You are trying to set the motor rated current in <i>E2-01 [Motor Rated Current (FLA)]</i> to a value lower than the no-load current set in <i>E2-03 [Motor No-Load Current]</i>.</li> <li>Make sure that value set in <i>E2-01</i> is higher than <i>E2-03</i>.</li> <li>If it is necessary to set <i>E2-01</i> lower than <i>E2-03</i>, first decrease the value set to <i>E2-03</i>, then change the <i>E2-01</i> setting as necessary.</li> </ul>

### ◆ The Correct Auto-Tuning Mode Is Not Available

Causes	Possible Solutions
The desired Auto-Tuning mode is not available for the selected control mode.	Change the motor control method with parameter <i>A1-02 [Control Method Selection]</i> .

### ◆ The Motor Stalls during Acceleration or Accel/Decel Time Is Too Long

Causes	Possible Solutions
The drive and motor system reached the torque limit or current suppression will not let the drive accelerate.	<ul style="list-style-type: none"> <li>Decrease the load.</li> <li>Use a larger motor.</li> </ul> <p><b>Note:</b> Although the drive has a Stall Prevention function and a Torque Compensation Limit function, accelerating too fast or trying to drive a load that is too large can exceed the limits of the motor.</p>
Torque limit is set incorrectly.	Set the torque limit correctly.
The acceleration time setting is too short.	Examine the values set in <i>C1-01</i> or <i>C1-03 [Acceleration Times]</i> and set them to applicable values.
The load is too heavy.	<ul style="list-style-type: none"> <li>Increase the acceleration time.</li> <li>Examine the mechanical brake and make sure that it is fully releasing.</li> <li>Decrease the load to make sure that the output current stays less than the motor rated current.</li> <li>Use a larger motor.</li> </ul> <p><b>Note:</b></p> <ul style="list-style-type: none"> <li>In extruder and mixer applications, the load can increase as the temperature decreases.</li> <li>Although the drive has a Stall Prevention function and a Torque Compensation Limit function, accelerating too fast or trying to drive a load that is too large can exceed the limits of the motor.</li> </ul>
The frequency reference is low.	<ul style="list-style-type: none"> <li>Examine <i>E1-04 [Maximum Output Frequency]</i> and increase the setting if it is set too low.</li> <li>Examine <i>U1-01 [Frequency Reference]</i> for the correct frequency reference.</li> <li>Examine the multi-function input terminals to see if a frequency reference signal switch has been set.</li> <li>Examine the low gain level set in <i>H3-03, H3-11 [Terminal A1, A2 Gain Setting]</i> when you use MFAL.</li> </ul>
The frequency reference is set incorrectly.	<p>When <i>H3-02, H3-10 = 1 [MFAL Function Selection = Frequency Gain]</i> are set, see if voltage (current) has been set.</p> <ul style="list-style-type: none"> <li>Check the values set in <i>H3-02</i> and <i>H3-10</i>.</li> <li>Use <i>U1-13</i> and <i>U1-14 [Terminal A1, A2 Input Voltage]</i> to make sure that the analog input values set to terminals A1 and A2 are applicable.</li> </ul>
The motor characteristics and drive parameter settings are not compatible.	<ul style="list-style-type: none"> <li>Set the correct V/f pattern to agree with the characteristics of the motor.</li> <li>Examine the V/f pattern set in <i>E1-03 [V/f Pattern Selection]</i>.</li> <li>Perform Rotational Auto-Tuning.</li> </ul>
The drive is operating in vector control mode, but Auto-Tuning is not completed.	<ul style="list-style-type: none"> <li>Do Auto-Tuning.</li> <li>Calculate motor data and reset motor parameters.</li> <li>Set <i>A1-02 = 0 [Control Method Selection = V/f Control]</i>.</li> </ul>
The Stall Prevention level during acceleration setting is too low.	<p>Increase the value set in <i>L3-02 [Stall Prevent Level during Accel]</i>.</p> <p><b>Note:</b> If the <i>L3-02</i> value is too low, the acceleration time can be unsatisfactorily long.</p>
The Stall Prevention level during run setting is too low.	<p>Increase the value set in <i>L3-06 [Stall Prevent Level during Run]</i>.</p> <p><b>Note:</b> If the <i>L3-06</i> value is too low, speed will decrease while the drive outputs torque.</p>
Drive reached the limitations of the V/f motor control method.	<ul style="list-style-type: none"> <li>When the motor cable is longer than 50 m (164 ft), do Auto-Tuning for line-to-line resistance.</li> <li>Set the V/f pattern to "High Starting Torque".</li> <li>Use a Vector Control method.</li> </ul> <p><b>Note:</b> V/f control method does not provide high torque at low speeds.</p>

### ◆ The Drive Frequency Reference Is Different than the Controller Frequency Reference Command

Causes	Possible Solutions
The analog input gain and bias for the frequency reference input are set incorrectly.	Examine the gain and bias settings for the analog inputs that set the frequency reference. <ul style="list-style-type: none"> <li>Terminal A1: H3-03 [Terminal A1 Gain Setting], H3-04 [Terminal A1 Bias Setting]</li> <li>Terminal A2: H3-11 [Terminal A2 Gain Setting], H3-12 [Terminal A2 Bias Setting]</li> </ul>
The drive is receiving frequency bias signals from analog input terminals A1 and A2 and the sum of all signals makes the frequency reference.	<ul style="list-style-type: none"> <li>Examine parameters H3-02, H3-10 [MFAI Function Selection]. If two or more of these parameters are set to 0 [Frequency Reference], change the settings.</li> <li>Use U1-13 and U1-14 [Terminal A1, A2 Input Voltage] to make sure that the analog input values set to terminals A1 and A2 are applicable.</li> </ul>
PID control is enabled.	If PID control is not necessary, set b5-01 = 0 [PID Mode Setting = Disabled]. <p><b>Note:</b> When PID control is enabled, the drive adjusts the output frequency as specified by the target value. The drive will only accelerate to the maximum output frequency set in E1-04 [Maximum Output Frequency] while PID control is active.</p>

### ◆ The Motor Speed Is Not Stable When Using a PM Motor

Causes	Possible Solutions
Parameter E5-01 [PM Motor Code Selection] is set incorrectly.	Refer to "Motor Performance Fine-Tuning" in the technical manual.
The drive is operating the motor at more than the specified speed control range.	Examine the speed control range and adjust the speed.
The motor is hunting.	Adjust these parameters to have the largest effect: <ul style="list-style-type: none"> <li>n8-55 [Motor to Load Inertia Ratio]</li> <li>n8-45 [Speed Feedback Detection Gain]</li> <li>C4-02 [Torque Compensation Delay Time]</li> </ul>
Hunting occurs at start.	Increase the value set in C2-01 [S-Curve Time @ Start of Accel].
Too much current is flowing through the drive.	Set E5-01 correctly as specified by the motor. For special-purpose motors, enter the correct value to E5-xx as specified by the motor test report.

### ◆ There Is Too Much Motor Oscillation and the Rotation Is Irregular

Causes	Possible Solutions
Unsatisfactory balance of motor phases.	<ul style="list-style-type: none"> <li>Make sure that the drive input power voltage supplies stable power.</li> <li>Set L8-05 = 0 [Input Phase Loss Protect Select = Disabled].</li> </ul>
The motor is hunting.	Set n1-01 = 1 [Hunting Prevention Selection = Enabled].

### ◆ There Is Audible Noise from the Drive or Motor Cables when You Energize the Drive

Causes	Possible Solutions
The relay switching in the drive is making too much noise.	<ul style="list-style-type: none"> <li>Use C6-02 [Carrier Frequency Selection] to decrease the carrier frequency.</li> <li>Connect a noise filter to the input side of the drive power supply.</li> <li>Connect a noise filter to the output side of the drive.</li> <li>Isolate the control circuit wiring from the main circuit wiring.</li> <li>Use a metal cable gland to wire the drive.</li> <li>Shield the periphery of the drive with metal.</li> <li>Make sure that the drive and motor are grounded correctly.</li> <li>Make sure that ground faults have not occurred in the wiring or motor.</li> </ul>

### ◆ The Ground Fault Circuit Interrupter (GFCI) Trips During Run

Causes	Possible Solutions
There is too much leakage current from the drive.	<ul style="list-style-type: none"> <li>• Increase the GFCI sensitivity or use GFCI with a higher threshold.</li> <li>• Use C6-02 [Carrier Frequency Selection] to decrease the carrier frequency.</li> <li>• Decrease the length of the cable used between the drive and the motor.</li> <li>• Install a noise filter or AC reactor on the output side of the drive. Set C6-02 = 1 [2.0 kHz] when connecting an AC reactor.</li> <li>• Disable the internal EMC filter.</li> </ul>

### ◆ Motor Rotation Causes Unexpected Audible Noise from Connected Machinery

Causes	Possible Solutions
The carrier frequency and the resonant frequency of the connected machinery are the same.	<ul style="list-style-type: none"> <li>• Adjust C6-02 to C6-05 [Carrier Frequency].</li> <li>• Set C6-02 = 1 to 6 [Carrier Frequency Selection = Frequency other than Swing PWM].</li> </ul> <p><b>Note:</b> If C6-02 = 7 to A [Carrier Frequency Selection = Swing PWM], the drive will not know if the noise comes from the drive or the machine.</p>
The drive output frequency and the resonant frequency of the connected machinery are the same.	<ul style="list-style-type: none"> <li>• Adjust d3-01 to d3-04 [Jump Frequency].</li> <li>• Put the motor on a rubber pad to decrease vibration.</li> </ul>

### ◆ Motor Rotation Causes Oscillation or Hunting

Causes	Possible Solutions
The frequency reference is assigned to an external source, and there is electrical interference in the signal.	<p>Make sure that electrical interference does not have an effect on the signal lines.</p> <ul style="list-style-type: none"> <li>• Isolate control circuit wiring from main circuit wiring.</li> <li>• Use twisted-pair cables or shielded wiring for the control circuit.</li> <li>• Increase the value of H3-13 [Analog Input Filter Time Constant].</li> </ul>
The cable between the drive and motor is too long.	<ul style="list-style-type: none"> <li>• Do Auto-Tuning.</li> <li>• Make the wiring as short as possible.</li> </ul>
The PID parameters are not sufficiently adjusted.	Adjust b5-xx [PID control].

### ◆ PID Output Fault

Causes	Possible Solutions
There is no PID feedback input.	<ul style="list-style-type: none"> <li>• Examine the MFAI terminal settings.</li> <li>• See if H3-02, H3-10 = B [MFAI Function Selection = PID Feedback] is set.</li> <li>• Make sure that the MFAI terminal settings agree with the signal inputs.</li> <li>• Examine the connection of the feedback signal.</li> <li>• Make sure that b5-xx [PID Control] is set correctly.</li> </ul> <p><b>Note:</b> If there is no PID feedback input to the terminal, the detected value is 0, which causes a PID fault and also causes the drive to operate at maximum frequency.</p>
The detection level and the target value do not agree.	<p>Use H3-03, H3-11 [Terminal A1, A2 Gain Setting] to adjust PID target and feedback signal scaling.</p> <p><b>Note:</b> PID control keeps the difference between the target value and detection value at 0. Set the input level for the values relative to each other.</p>
Reverse drive output frequency and speed detection. When output frequency increases, the sensor detects a speed decrease.	Set b5-09 = 1 [PID Output Level Selection = Reverse Output (Reverse Acting)].

### ◆ The Starting Torque Is Not Sufficient

Causes	Possible Solutions
Auto-Tuning has not been done in vector control method.	Do Auto-Tuning.
The control method was changed after doing Auto-Tuning.	Do Auto-Tuning again.
Stationary Auto-Tuning for Line-to-Line Resistance was done.	Do Rotational Auto-Tuning.

◆ The Motor Rotates after the Drive Output Is Shut Off

Causes	Possible Solutions
DC Injection Braking is too low and the drive cannot decelerate correctly.	<ul style="list-style-type: none"> <li>• Increase the value set in <i>b2-02 [DC Injection Braking Current]</i>.</li> <li>• Increase the value set in <i>b2-04 [DC Inject Braking Time at Stop]</i>.</li> </ul>
The stopping method makes the drive coast to stop.	Set <i>b1-03 = 0</i> or <i>2 [Stopping Method Selection = Ramp to Stop, DC Injection Braking to Stop]</i> .

◆ The Output Frequency Is Lower Than the Frequency Reference

Causes	Possible Solutions
The frequency reference is in the Jump frequency range.	Adjust <i>d3-01</i> to <i>d3-03 [Jump Frequency 1 to 3]</i> and <i>d3-04 [Jump Frequency Width]</i> . <b>Note:</b> Enabling the Jump frequency prevents the drive from outputting the frequencies specified in the Jump range.
The upper limit for the frequency reference has been exceeded.	Set <i>E1-04 [Maximum Output Frequency]</i> , <i>d2-01 [Frequency Reference Upper Limit]</i> , and <i>Y1-40 [Maximum Speed]</i> to the best values for the application. <b>Note:</b> This calculation supplies the upper value for the output frequency: The smaller of $E1-04 \times d2-01 / 100$ or <i>Y1-40</i> .
A large load triggered Stall Prevention function during acceleration.	<ul style="list-style-type: none"> <li>• Decrease the load.</li> <li>• Adjust <i>L3-02 [Stall Prevent Level during Accel]</i>.</li> </ul>
<i>L3-01 = 3 [Stall Prevention during Accel = Current Limit Method]</i> has been set.	<ol style="list-style-type: none"> <li>1. Make sure that the V/f pattern and motor parameter settings are appropriate, and set them correctly.</li> <li>2. If this does not solve the problem, and it is not necessary to limit the current level of stall during acceleration, adjust <i>L3-02</i>.</li> <li>3. If this does not solve the problem, set <i>L3-01 = 1 [Enabled]</i>.</li> </ol>
The motor is rotating at this speed: $b2-01 [DC Injection/Zero SpeedThreshold] \leq \text{Motor Speed} < E1-09 [Minimum Output Frequency]$	Set <i>E1-09 &lt; b2-01</i> .

◆ The Motor Is Making an Audible Noise

Causes	Possible Solutions
100% of the rated output current of the drive was exceeded while operating at low speeds.	<ul style="list-style-type: none"> <li>• If the sound is coming from the motor, set <i>L8-38 = 0 [Carrier Frequency Reduction = Disabled]</i>.</li> <li>• If <i>oL2 [Drive Overloaded]</i> occurs frequently after setting <i>L8-38 = 0</i>, replace the drive with a high-capacity drive.</li> </ul>

◆ The Motor Will Not Restart after a Loss of Power

Causes	Possible Solutions
The drive did not receive a Run command after applying power.	<ul style="list-style-type: none"> <li>• Examine the sequence and wiring that enters the Run command.</li> <li>• Set up a relay to make sure that the Run command stays enabled during a loss of power.</li> </ul>
For applications that use 3-wire sequence, the momentary power loss continued for a long time, and the relay that keeps the Run command has been switched off.	Examine the wiring and circuitry for the relay that keeps the Run command enabled during the momentary power loss ride-thru time.

# Periodic Inspection and Maintenance

---

This chapter gives information about how to examine and maintain drives in use, how to replace cooling fans and other parts, and how to store drives.

<b>8.1</b>	<b>Section Safety .....</b>	<b>378</b>
<b>8.2</b>	<b>Inspection.....</b>	<b>380</b>
<b>8.3</b>	<b>Maintenance .....</b>	<b>383</b>
<b>8.4</b>	<b>Replace Cooling Fans and Circulation Fans.....</b>	<b>385</b>
<b>8.5</b>	<b>Replace the Keypad Battery .....</b>	<b>411</b>
<b>8.6</b>	<b>Storage Guidelines .....</b>	<b>413</b>

## 8.1 Section Safety

### DANGER

#### Electrical Shock Hazard

**Do not examine, connect, or disconnect wiring on an energized drive. Before servicing, disconnect all power to the equipment and wait for the time specified on the warning label at a minimum. The internal capacitor stays charged after the drive is de-energized. The charge indicator LED extinguishes when the DC bus voltage decreases below 50 Vdc. When all indicators are OFF, remove the covers before measuring for dangerous voltages to make sure that the drive is safe.**

If you do work on the drive when it is energized, it will cause serious injury or death from electrical shock.

**Disconnect all power to the drive and wait for the time specified on the warning label before you remove covers. Check the drive for dangerous voltages before servicing or repair work.**

If you do work on the drive when it is energized and there is no cover over the electronic circuits, it will cause serious injury or death from electrical shock. The drive has internal capacitors that stay charged after you de-energize the drive.

### WARNING

#### Electrical Shock Hazard

**The motor will run after you de-energize the drive. PM motors can generate induced voltage to the terminal of the motor after you de-energize the drive.**

If you touch a motor that is moving or energized, it can cause serious injury or death.

**Do not operate the drive when covers are missing. Replace covers and shields before you operate the drive. Use the drive only as specified by the instructions.**

Some figures in this section include drives without covers or safety shields to more clearly show the inside of the drive. If covers or safety shields are missing from the drive, it can cause serious injury or death.

**Always ground the motor-side grounding terminal.**

If you do not ground the equipment correctly, it can cause serious injury or death if you touch the motor case.

**Only let approved personnel install, wire, maintain, examine, replace parts, and repair the drive.**

If personnel are not approved, it can cause serious injury or death.

**Do not wear loose clothing or jewelry when you do work on the drive. Tighten loose clothing and remove all metal objects, for example watches or rings.**

Loose clothing can catch on the drive and jewelry can conduct electricity and cause serious injury or death.

#### Fire Hazard

**Tighten all terminal screws to the correct tightening torque.**

Connections that are too loose or too tight can cause incorrect operation and damage to the drive. Incorrect connections can also cause death or serious injury from fire.

#### Damage to Equipment

**Do not apply incorrect voltage to the main circuit of the drive. Operate the drive in the specified range of the input voltage on the drive nameplate.**

Voltages that are higher than the permitted nameplate tolerance can cause damage to the drive.

#### Fire Hazard

**Do not put flammable or combustible materials on top of the drive and do not install the drive near flammable or combustible materials. Attach the drive to metal or other noncombustible material.**

Flammable and combustible materials can start a fire and cause serious injury or death.



**⚠ WARNING****Electrical Shock Hazard**

**Do not modify the drive body or drive circuitry.**

Modifications to drive body and circuitry can cause serious injury or death, will cause damage to the drive, and will void the warranty. Yaskawa is not responsible for modifications of the product made by the user.

**Sudden Movement Hazard**

**Make sure that you align the phase order for the drive and motor when you connect the motor to drive output terminals U/T1, V/T2, and W/T3.**

If the phase order is incorrect, it can cause the motor to run in reverse. If the motor accidentally runs in reverse, it can cause serious injury or death.

**⚠ CAUTION****Burn Hazard**

**Do not touch a hot drive heatsink. De-energize the drive, wait for a minimum of 15 minutes, then make sure that the heatsink is cool before you replace the cooling fans.**

If you touch a hot drive heatsink, it can burn you.

**NOTICE****Damage to Equipment**

**When you touch the drive and circuit boards, make sure that you observe correct electrostatic discharge (ESD) procedures.**

If you do not follow procedures, it can cause ESD damage to the drive circuitry.

**Use the instructions in this manual to replace the cooling fans. When you do maintenance on the fans, replace all the fans to increase product life.**

If you install the fans incorrectly, it can cause damage to the drive.

**Make sure that all connections are correct after you install the drive and connect peripheral devices.**

Incorrect connections can cause damage to the drive.

**Do not energize and de-energize the drive more frequently than one time each 30 minutes.**

If you frequently energize and de-energize the drive, it can cause drive failure.

**Do not operate a drive or connected equipment that has damaged or missing parts.**

You can cause damage to the drive and connected equipment.

**Note:**

Do not use unshielded cable for control wiring. Use shielded, twisted-pair wires and ground the shield to the ground terminal of the drive. Incorrect wiring can cause electrical interference and unsatisfactory system performance.

## 8.2 Inspection

Power electronics have limited life and can show changes in performance and deterioration of performance after years of use in usual conditions. To help prevent these problems, it is important to do preventive maintenance and regular inspection, and replace parts on the drive.

Drives contain different types of power electronics, for example power transistors, semiconductors, capacitors, resistors, fans, and relays. The electronics in the drive are necessary for correct motor control.

Follow the inspection lists in this chapter as a part of a regular maintenance program.

**Note:**

Examine the drive one time each year at a minimum.

The operating conditions, environmental conditions, and use conditions will have an effect on the examination frequency for connected equipment.

Examine the drive more frequently if you use the drive in bad conditions or in these conditions:

- High ambient temperatures
- Frequent starting and stopping
- Changes in the AC power supply or load
- Too much vibration or shock loading
- Dust, metal dust, salt, sulfuric acid, or chlorine atmospheres
- Unsatisfactory storage conditions.

### ◆ Recommended Daily Inspection

Table 8.1 gives information about the recommended daily inspection for Yaskawa drives. Examine the items in Table 8.1 each day to make sure that the components do not become unserviceable or fail. Make a copy of this checklist and put a check mark in the “Checked” column after each inspection.

**Table 8.1 Daily Inspection Checklist**

Inspection Area	Inspection Points	Corrective Action	Checked
Motor	Examine for unusual oscillation or noise coming from the motor.	<ul style="list-style-type: none"> <li>• Check the load coupling.</li> <li>• Measure motor vibration.</li> <li>• Tighten all loose components.</li> </ul>	
Cooling System	Examine for unusual heat from the drive or motor and visible discoloration.	<ul style="list-style-type: none"> <li>• Check for a load that is too heavy.</li> <li>• Tighten loose screws.</li> <li>• Check for a dirty heatsink or motor.</li> <li>• Measure the ambient temperature.</li> </ul>	
	Examine the cooling fans, circulation fans, and circuit board cooling fans.	<ul style="list-style-type: none"> <li>• Check for a clogged or dirty fan.</li> <li>• Use the performance life monitor to check for correct fan operation.</li> </ul>	
Surrounding Environment	Make sure that the installation environment is applicable.	Remove the source of contamination or correct unsatisfactory environment.	
Load	Make sure that the drive output current is not more than the motor or drive rating for an extended period of time.	<ul style="list-style-type: none"> <li>• Check for a load that is too heavy.</li> <li>• Check the correct motor parameter settings.</li> </ul>	
Power Supply Voltage	Examine main power supply and control voltages.	<ul style="list-style-type: none"> <li>• Correct the voltage or power supply to agree with nameplate specifications.</li> <li>• Verify all main circuit phases.</li> </ul>	

### ◆ Recommended Periodic Inspection

Table 8.2 to Table 8.6 give information about the recommended periodic inspections for Yaskawa drives. Examine the drive one time each year at a minimum. The operating conditions, environmental conditions, and use conditions will have an effect on the examination frequency for connected equipment. You must use your experience with the application to select the correct inspection frequency for each drive installation. Periodic inspections will help to prevent performance deterioration and product failure. Make a copy of this checklist and put a check mark in the “Checked” column after each inspection.

**DANGER! Electrical Shock Hazard.** Do not examine, connect, or disconnect wiring on an energized drive. Before servicing, disconnect all power to the equipment and wait for the time specified on the warning label at a minimum. The internal capacitor stays charged after the drive is de-energized. The charge indicator LED extinguishes when the DC bus voltage decreases below 50 Vdc. When all indicators are OFF, remove the covers before measuring for dangerous voltages to make sure that the drive is safe. If you do work on the drive when it is energized, it will cause serious injury or death from electrical shock.

Table 8.2 Main Circuit Periodic Inspection Checklist

Inspection Area	Inspection Points	Corrective Action	Checked
General	<ul style="list-style-type: none"> <li>Examine equipment for discoloration from too much heat or deterioration.</li> <li>Examine for damaged parts.</li> </ul>	<ul style="list-style-type: none"> <li>Replace damaged components as necessary.</li> <li>The drive does not have many serviceable parts and it could be necessary to replace the drive.</li> </ul>	
	Examine for dirt, unwanted particles, or dust on components.	<ul style="list-style-type: none"> <li>Examine enclosure door seal.</li> <li>Use a vacuum cleaner to remove unwanted particles and dust without touching the components.</li> <li>If you cannot remove unwanted particles and dust with a vacuum cleaner, replace the components.</li> </ul>	
Conductors and Wiring	<ul style="list-style-type: none"> <li>Examine wiring and connections for discoloration or damage. Examine wiring and connections for discoloration from too much heat.</li> <li>Examine wire insulation and shielding for discoloration and wear.</li> </ul>	Repair or replace damaged wiring.	
Terminal Block	Examine terminals for stripped, damaged, or loose connections.	<ul style="list-style-type: none"> <li>Tighten loose screws.</li> <li>Replace damaged screws or terminals.</li> </ul>	
Electromagnetic Contactors and Relays	<ul style="list-style-type: none"> <li>Examine contactors and relays for too much noise during operation.</li> <li>Examine coils for signs of too much heat, such as melted or broken insulation.</li> </ul>	<ul style="list-style-type: none"> <li>Check coil voltage for overvoltage or undervoltage conditions.</li> <li>Replace broken relays, contactors, or circuit boards that you can remove.</li> </ul>	
Electrolytic capacitor	<ul style="list-style-type: none"> <li>Examine for leaks, discoloration, or cracks.</li> <li>Examine if the cap has come off, if there is swelling, or if there are leaks from broken sides.</li> </ul>	The drive does not have many serviceable parts and it could be necessary to replace the drive.	
Diodes, IGBT (Power Transistor)	Examine for dust or other unwanted material collected on the surface.	Use a vacuum cleaner to remove unwanted particles and dust without touching the components.	

Table 8.3 Motor Periodic Inspection Checklist

Inspection Area	Inspection Points	Corrective Action	Checked
Operation Check	Check for increased vibration or unusual noise.	Stop the motor and contact approved maintenance personnel as necessary.	

Table 8.4 Control Circuit Periodic Inspection Checklist

Inspection Area	Inspection Points	Corrective Action	Checked
General	<ul style="list-style-type: none"> <li>Examine terminals for stripped, damaged, or loose connections.</li> <li>Make sure that all terminals have been correctly tightened.</li> </ul>	<ul style="list-style-type: none"> <li>Tighten loose screws.</li> <li>Replace damaged screws or terminals.</li> <li>If terminals are integral to a circuit board, it could be necessary to replace the control board or the drive.</li> </ul>	
Circuit Boards	<ul style="list-style-type: none"> <li>Check for odor, discoloration, or rust.</li> <li>Make sure that all connections are correctly fastened.</li> <li>Make sure that the surface of the circuit board does not have dust or oil mist.</li> </ul>	<ul style="list-style-type: none"> <li>Tighten loose connections.</li> <li>Use a vacuum cleaner to remove unwanted particles and dust without touching the components.</li> <li>If you cannot remove unwanted particles and dust with a vacuum cleaner, replace the components.</li> <li>Do not use solvents to clean the board.</li> <li>The drive does not have many serviceable parts and it could be necessary to replace the drive.</li> </ul>	

Table 8.5 Cooling System Periodic Inspection Checklist

Inspection Area	Inspection Points	Corrective Action	Checked
Cooling fan	<ul style="list-style-type: none"> <li>Check for unusual oscillation or unusual noise.</li> <li>Check for damaged or missing fan blades.</li> </ul>	Clean or replace the fans as necessary.	
Heatsink	<ul style="list-style-type: none"> <li>Examine for dust or other unwanted material collected on the surface.</li> <li>Examine for dirt.</li> </ul>	Use a vacuum cleaner to remove unwanted particles and dust without touching the components.	
Air Duct	Examine air intake, exhaust openings and make sure that there are no unwanted materials on the surface.	Clear blockages and clean air duct as necessary.	

**Table 8.6 Keypad Periodic Inspection Checklist**

Inspection Area	Inspection Points	Corrective Action	Checked
General	<ul style="list-style-type: none"> <li>• Make sure that the keypad shows the data correctly.</li> <li>• Examine for dust or other unwanted material that collected on components in the area.</li> <li>• Examine if the clock battery is expired.</li> </ul>	<ul style="list-style-type: none"> <li>• If you have problems with the display or the keys, contact Yaskawa or your nearest sales representative.</li> <li>• Clean the keypad.</li> <li>• Replace the battery.</li> </ul>	

## 8.3 Maintenance

The drive Maintenance Monitors keep track of component wear and tell the user when the end of the estimated performance life is approaching. The Maintenance Monitors prevent the need to shut down the full system for unexpected problems. Users can set alarm notifications for the maintenance periods for these drive components:

- Cooling fan
- Electrolytic capacitor
- Soft charge bypass relay
- IGBT

Contact Yaskawa or your nearest sales representative for more information about part replacement.

### ◆ Replaceable Parts

You can replace these parts of the drive:

- Control circuit terminal board
- Cooling fan, circulation fan
- Keypad

**Note:**

Make sure that you use a keypad with FLASH number 1004 or later. Keypads with FLASH numbers 1003 and earlier will not show characters correctly.

If there is a failure in the main circuit, replace the drive.

If the drive is in the warranty period, contact Yaskawa or your nearest sales representative before you replace parts. Yaskawa reserves the right to replace or repair the drive as specified by the Yaskawa warranty policy.

**DANGER! Electrical Shock Hazard.** Do not examine, connect, or disconnect wiring on an energized drive. Before servicing, disconnect all power to the equipment and wait for the time specified on the warning label at a minimum. The internal capacitor stays charged after the drive is de-energized. The charge indicator LED extinguishes when the DC bus voltage decreases below 50 Vdc. When all indicators are OFF, remove the covers before measuring for dangerous voltages to make sure that the drive is safe. If you do work on the drive when it is energized, it will cause serious injury or death from electrical shock.

### ◆ Part Replacement Guidelines

Table 8.7 shows the standard replacement period for replacement parts. When you replace these parts, make sure that you use Yaskawa replacement parts for the applicable model and design revision number of your drive.

**Table 8.7 Standard Replacement Period**

Parts	Standard Replacement Period
Cooling fan	10 years
Electrolytic capacitor <sup>*1</sup>	10 years

\*1 If there is damage to parts that you cannot repair or replace, replace the drive.

**Note:**

The performance life estimate uses these operating conditions. Yaskawa provides these conditions so you can replace parts to maintain performance. Unsatisfactory conditions or heavy use will make it necessary for you to replace some parts more frequently than other parts.

Operating conditions for performance life estimate:

- Yearly average
  - IP20/Open Type enclosure: 40 °C (104 °F)
  - IP20/UL Type 1 and External Heatsink Installation of IP55/UL Type 12: 30 °C (86 °F)
- Load factor
  - 80% maximum
- Operation time
  - 24 hours a day

### ◆ Monitors that Show the Lifespan of Drive Components

The drive keypad shows percentage values for the replacement parts to help you know when you must replace those components. Use the monitors in Table 8.8 to see how close you are to the end of the useful life of a component.

## 8.3 Maintenance

When the monitor value is 100%, the component is at the end of its useful life and there is an increased risk of drive malfunction. Yaskawa recommends that you check the maintenance period regularly to make sure that you get the maximum performance life.

**Table 8.8 Performance Life Monitors**

Monitor No.	Parts	Description
U4-03	Cooling fan	Shows the total operation time of fans as 0 to 99999 hours. After this value is 99999, the drive automatically resets it to 0.
U4-04		Shows the total fan operation time as a percentage of the specified maintenance period.
U4-05	Electrolytic capacitor	Shows the total capacitor usage time as a percentage of the specified maintenance period.
U4-06	Soft charge bypass relay	Shows the number of times the drive is energized as a percentage of the performance life of the inrush circuit.
U4-07	IGBT	Shows the percentage of the maintenance period reached by the IGBTs.

### ◆ Alarm Outputs for Maintenance Monitors

You can use *H2-xx* [*Multi-Function Digital Out*] to send a message that tells you when a specified component is near the end of its performance life estimate. Set *H2-xx* to the applicable value for your component as shown in [Table 8.9](#).

When the specified component is near the end of its performance life estimate, the MFDO terminals set for *H2-xx* = *2F* [*Maintenance Notification*] will turn ON, and the keypad will show an alarm that identifies the component to replace.

**Table 8.9 Maintenance Period Alarms**

Display	Alarm Name	Cause	Possible Solutions	Digital Outputs (Setting Value in H2-xx)
LT-1	Cooling Fan Maintenance Time	The cooling fan is at 90% of its expected performance life.	Replace the cooling fan, then set <i>o4-03</i> = 0 [ <i>Fan Operation Time Setting</i> = 0 h] to reset the cooling fan operation time.	2F
LT-2	Capacitor Maintenance Time	The capacitors for the main circuit and control circuit are at 90% of expected performance life.	Replace the board or the drive. Contact Yaskawa or your nearest sales representative to replace the board.	
LT-3	SoftChargeBypassRelay Maintenance Time	The soft charge bypass relay is at 90% of its performance life estimate.	Replace the board or the drive. Contact Yaskawa or your nearest sales representative to replace the board.	
LT-4	IGBT Maintenance Time (50%)	The IGBT is at 50% of its expected performance life.	Check the load, carrier frequency, and output frequency.	
TrPC	IGBT Maintenance Time (90%)	The IGBT is at 90% of its expected performance life.	Replace the IGBT or the drive.	10

### ◆ Related Parameters

Replace the component, then set *o4-03*, *o4-05*, *o4-07*, and *o4-09* [*Maintenance Setting*] = 0 to reset the Maintenance Monitor. If you do not reset these parameters after you replace the parts, the Maintenance Monitor function will continue to count down the performance life from the value from the previous part. If you do not reset the Maintenance Monitor, the drive will not have the correct value of the performance life for the new part.

**Note:**

The maintenance period is different for different operating environments.

**Table 8.10 Maintenance Setting Parameters**

No.	Name	Function
o4-03	Fan Operation Time Setting	Sets the value from which to start the cumulative drive cooling fan operation time in 10-hour units. <b>Note:</b> When <i>o4-03</i> = 30 has been set, the drive will count the operation time for the cooling fan from 300 hours and <i>U4-03</i> [ <i>Cooling Fan Open Time</i> ] will show 300 h.
o4-05	Capacitor Maintenance Setting	Sets the value from which to start the count for the main circuit capacitor maintenance period as a percentage.
o4-07	Softcharge Relay Maintenance Set	Sets as a percentage the value from which to start the count for the soft charge bypass relay maintenance time.
o4-09	IGBT Maintenance Setting	Sets the value from which to start the count for the IGBT maintenance period as a percentage.

## 8.4 Replace Cooling Fans and Circulation Fans

**CAUTION!** *Injury to Personnel. Some fan units are not easily accessible from a standing position. Make sure that you can safely and comfortably remove and replace the fan. If you try to remove a fan that you cannot easily access, the fan unit can fall and cause minor to moderate injury.*

**NOTICE:** *Use the instructions in this manual to replace the cooling fans. When you do maintenance on the fans, replace all the fans to increase product life. If you install the fans incorrectly, it can cause damage to the drive.*

### ◆ Cooling Fans and Circulation Fans by Drive Model

**Table 8.11 Cooling Fans and Circulation Fans for IP20/UL Open Type and IP20/UL Type 1 Drives**

Model	Cooling Fan	Circulation Fan	Replacement Procedure	Reference
4005, 4008	-	-	-	-
2011 - 2031 4011 - 4034	1	-	Procedure A	385
2046, 2059 4040 - 4052	1	-	Procedure B	390
4065	1	1		
2075 - 2114 4077 - 4124	2	-	Procedure C	396
2143 - 2273 4156 - 4240	2	-	Procedure D	401
4302	2	1	Procedure E	404

**Table 8.12 Cooling Fans and Circulation Fans for IP55/UL Type 12 Drives**

Model	Cooling Fan	Circulation Fan	Replacement Procedure	Reference
4005	-	-	-	-
2011, 2017 4008 - 4014	1	-	Procedure A	385
2024, 2031 4021 - 4034	1	1		
2046, 2059 4040 - 4065	1	1	Procedure B	390
2075 - 2114 4077 - 4124	2	1	Procedure C	396

**Table 8.13 Cooling Fans and Circulation Fans for IP55/UL Type 12 Drives with Main Switch**

Model	Cooling Fan	Circulation Fan	Replacement Procedure	Reference
4005	-	-	-	-
2011, 2017 4008 - 4014	1	-	Procedure A	385
2024, 2031 4021 - 4034	1	1		
2046, 2059 4040 - 4065	1	1	Procedure B	390
2075 - 2114 4077 - 4096	2	1	Procedure C	396

### ◆ Fan Replacement (Procedure A)

**DANGER!** *Electrical Shock Hazard. Do not examine, connect, or disconnect wiring on an energized drive. Before servicing, disconnect all power to the equipment and wait for the time specified on the warning label at a minimum. The internal capacitor stays charged after the drive is de-energized. The charge indicator LED extinguishes when the DC bus voltage decreases below 50 Vdc. When all indicators are OFF, remove the covers before measuring for dangerous voltages to make sure that the drive is safe. If you do work on the drive when it is energized, it will cause serious injury or death from electrical shock.*

**CAUTION!** *Burn Hazard. Do not touch a hot drive heatsink. De-energize the drive, wait for a minimum of 15 minutes, then make sure that the heatsink is cool before you replace the cooling fans. If you touch a hot drive heatsink, it can burn you.*

## 8.4 Replace Cooling Fans and Circulation Fans

**NOTICE:** Use the instructions in this manual to replace the cooling fans. When you do maintenance on the fans, replace all the fans to increase product life. If you install the fans incorrectly, it can cause damage to the drive.

### ■ Fan Removal

1. Push the tab on the back side of the fan finger guard and pull up to remove the fan finger guard from the drive.

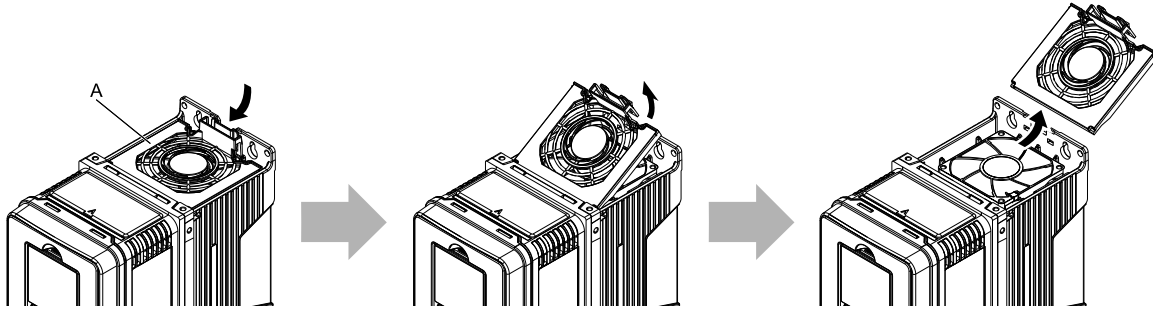

A - Fan finger guard

Figure 8.1 Remove the Fan Finger Guard

2. Pull the cooling fan straight up from the drive. Remove the protective tube on the relay connector and disconnect the connector to remove the fan from the drive.

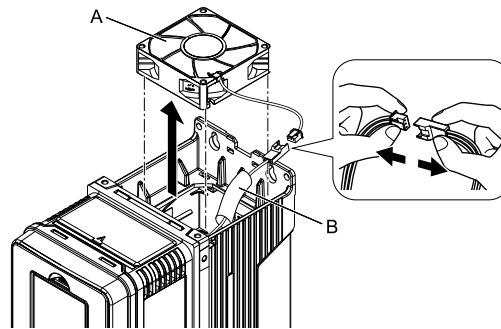

A - Cooling fan

B - Protective tube

Figure 8.2 Remove the Cooling Fan

### ■ Fan Installation

Reverse the removal procedure for fan installation.

1. Connect the relay connector between the drive and cooling fan, and attach the protective tube.

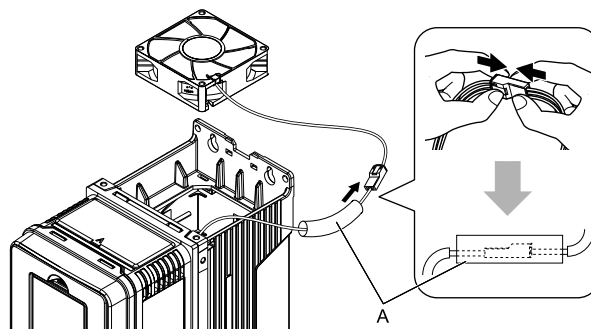

A - Protective tube

Figure 8.3 Connect the Relay Connector

2. Align the notches on the fan with the pin on the drive and install the cooling fan in the drive.

#### Note:

The positions of notch on the fan and alignment pin on the drive are different for different drive models. Use these figures to make sure that you use correct positions for your drive.



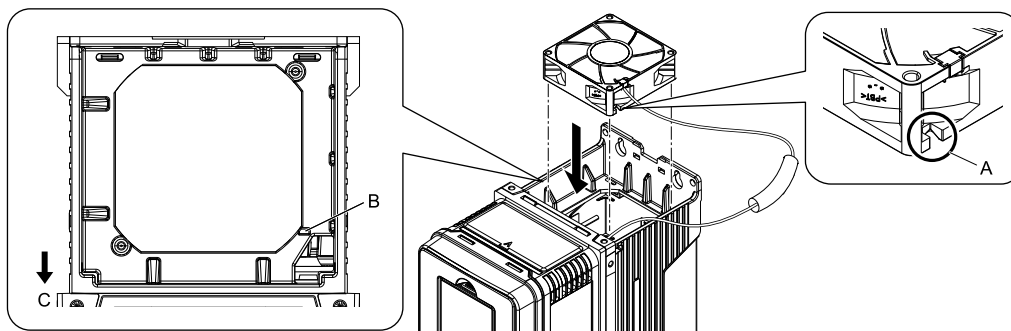

A - Notch on fan

B - Alignment pin on drive

C - Front of drive

Figure 8.4 Install the Cooling Fan (Drive Models: 2011, 2017, 4008xV/T, 4011, 4014)

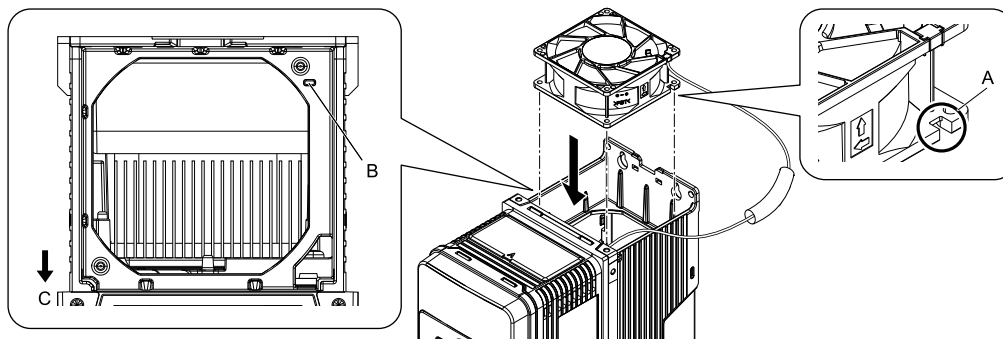

A - Notch on fan

B - Alignment pin on drive

C - Front of drive

Figure 8.5 Install the Cooling Fan (Drive Models: 2024, 2031, 4021 to 4034)

3. Put the cable and connector in the recess of the drive.

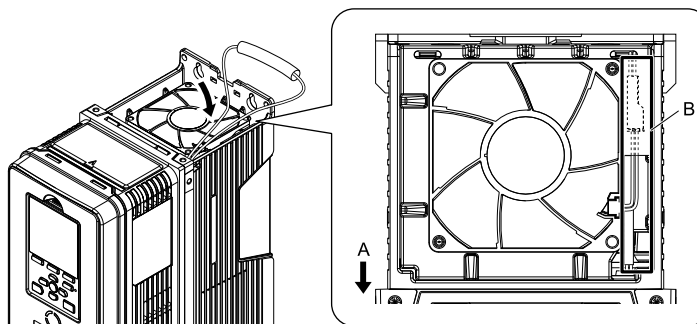

A - Front of drive

B - Recess for cable and connector <sup>\*1</sup>

Figure 8.6 Put the Cable and Connector in the Drive Recess

\*1 Make sure that the cable and connector are in the correct space.

4. Hold the fan finger guard at an angle and put the connector tabs on the fan finger guard into the holes on the drive.

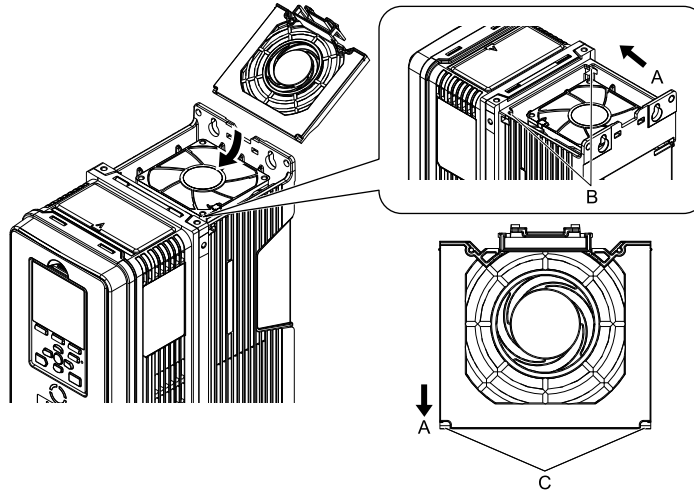

A - Front of drive  
B - Drive holes

C - Connector tabs

**Figure 8.7 Install the Fan Finger Guard**

5. Push the tab on the back side of the fan finger guard and click it into place on the drive.

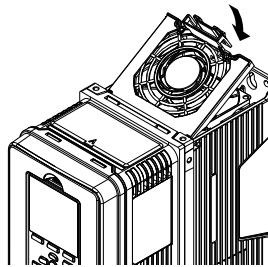

**Figure 8.8 Install the Fan Finger Guard**

6. Energize the drive and set  $o4-03 = 0$  [Fan Operation Time Setting = 0 h] to reset the fan operation time.

### ■ Circulation Fan Removal

**Note:**

Use this procedure only when you use one of these drive models:

- 2024xV, 2031xV
- 4021xV to 4034xV
- 2024xT, 2031xT
- 4021xT to 4034xT

Remove the drive cover before you start this procedure.

**CAUTION!** *Crush Hazard. Loosen the cover screws. Do not fully remove them. If you fully remove the cover screws, the terminal cover can fall and cause moderate injury.*

1. Disconnect the connector and remove the fan cable from the hook.

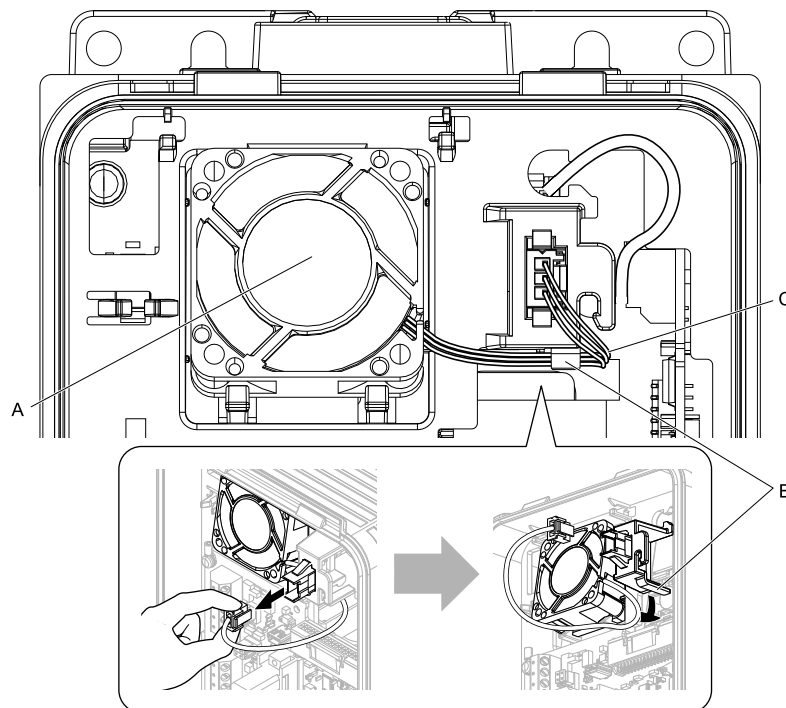

A - Circulation fan  
B - Hook

C - Fan cable

Figure 8.9 Disconnect the Connector and Remove the Fan Cable

2. Pull the bottom of the fan forward to remove it from the drive.

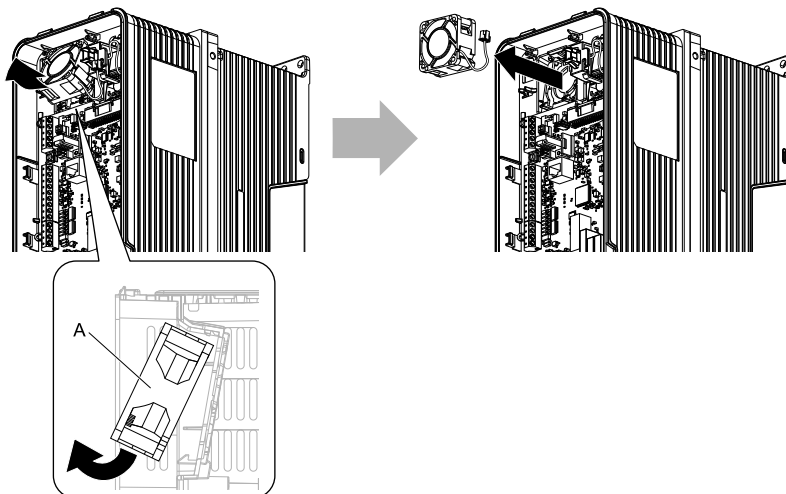

A - Circulation fan

Figure 8.10 Remove the Circulation Fan

## ■ Circulation Fan Installation

### Note:

Use this procedure only when you use one of these drive models:

- 2024xV, 2031xV
- 4021xV to 4034xV
- 2024xT, 2031xT
- 4021xT to 4034xT

## 8.4 Replace Cooling Fans and Circulation Fans

Reverse the removal procedure for circulation fan installation.

1. Put the side of the fan nearest to the top of the drive in first, and push it until the tabs click into position.

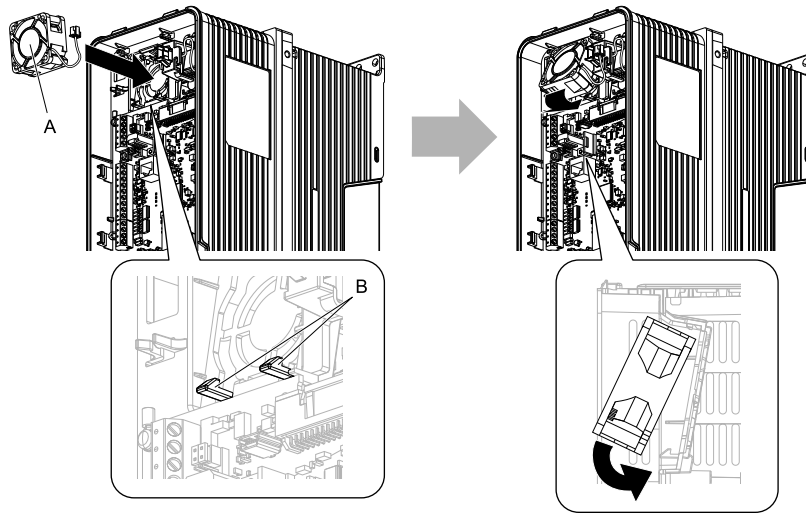

A - Circulation fan

B - Tabs

Figure 8.11 Install the Circulation Fan

2. Put the cable back into its initial position and connect the connector.

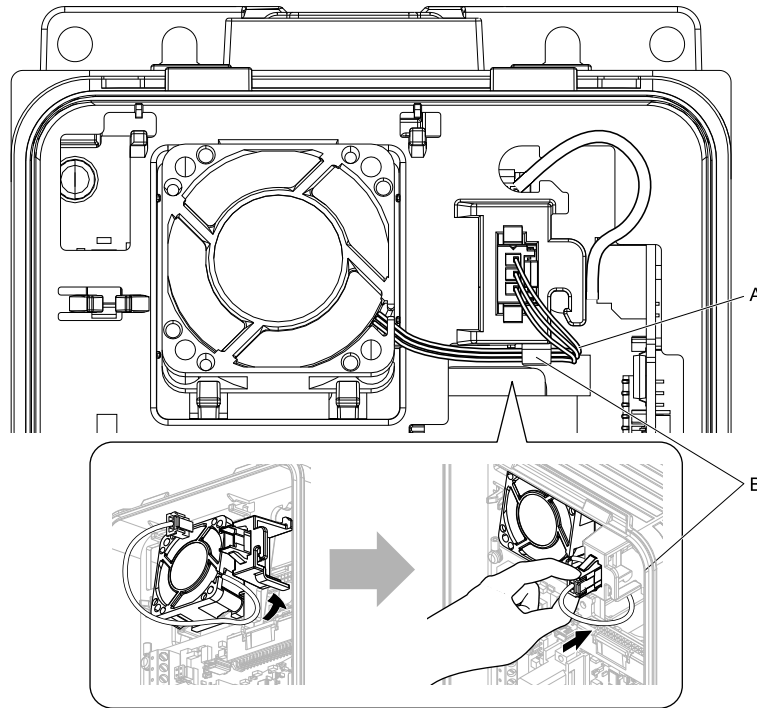

A - Fan cable

B - Hook

Figure 8.12 Put the Cable Back into the Drive and Connect the Connector

### ◆ Fan Replacement (Procedure B)

**DANGER! Electrical Shock Hazard.** Do not examine, connect, or disconnect wiring on an energized drive. Before servicing, disconnect all power to the equipment and wait for the time specified on the warning label at a minimum. The internal capacitor stays charged after the drive is de-energized. The charge indicator LED extinguishes when the DC bus voltage decreases below 50 Vdc. When all indicators are OFF, remove the covers before measuring for dangerous voltages to make sure that the drive is safe. If you do work on the drive when it is energized, it will cause serious injury or death from electrical shock.

**CAUTION! Burn Hazard.** Do not touch a hot drive heatsink. De-energize the drive, wait for a minimum of 15 minutes, then make sure that the heatsink is cool before you replace the cooling fans. If you touch a hot drive heatsink, it can burn you.

**NOTICE:** Use the instructions in this manual to replace the cooling fans. When you do maintenance on the fans, replace all the fans to increase product life. If you install the fans incorrectly, it can cause damage to the drive.

## ■ Fan Removal

1. Push the tab on the back side of the fan finger guard and pull up to remove the fan finger guard from the drive.

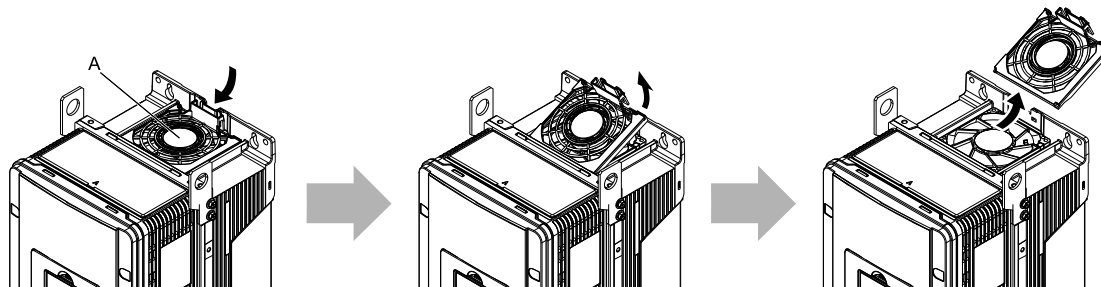

A - Fan finger guard

Figure 8.13 Remove the Fan Finger Guard

2. Pull the cooling fan straight up from the drive. Remove the protective tube on the relay connector and disconnect the connector to remove the fan from the drive.

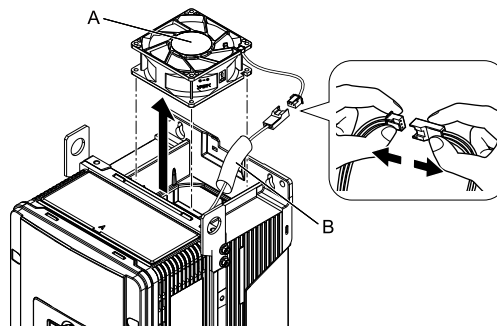

A - Cooling fan

B - Protective tube

Figure 8.14 Remove the Cooling Fan

## ■ Fan Installation

Reverse the removal procedure for fan installation.

1. Connect the relay connector between the drive and cooling fan, and attach the protective tube.

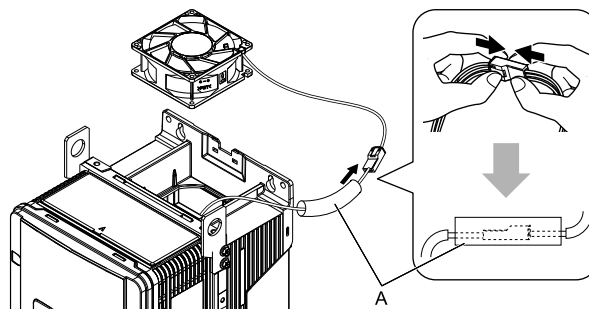

A - Protective tube

Figure 8.15 Connect the Relay Connector

- Align the notch on the fan with the pin on the drive and install the cooling fan in the drive.

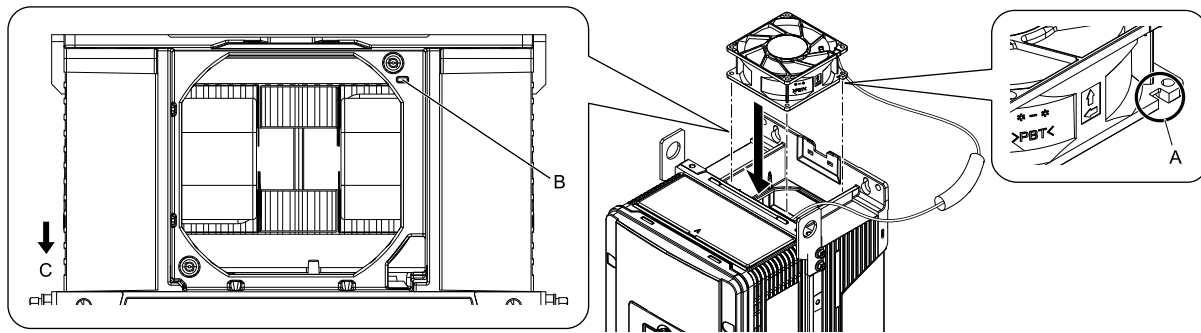

A - Notch on fan  
B - Alignment pin on drive

C - Front of drive

Figure 8.16 Install the Cooling Fan

- Put the cable and connector in the recess of the drive.

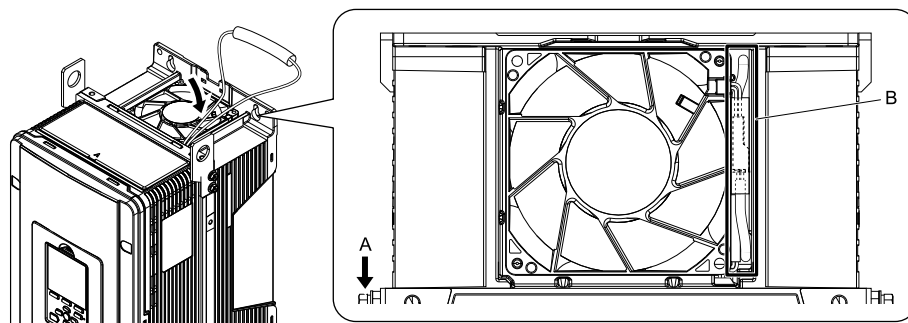

A - Front of drive

B - Recess for cable and connector \*1

Figure 8.17 Put the Cable in the Drive Recess

\*1 Make sure that the cable and connector are in the correct space.

- Hold the fan finger guard at an angle and put the connector tabs on the fan finger guard into the holes on the drive.

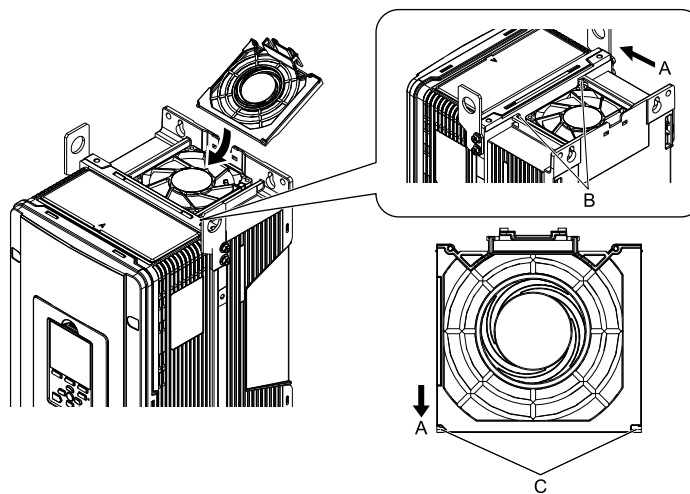

A - Front of drive  
B - Drive holes

C - Connector tabs

Figure 8.18 Install the Fan Finger Guard

5. Push the tab on the back side of the fan finger guard and click it into place on the drive.

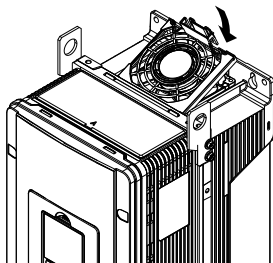

**Figure 8.19 Install the Fan Finger Guard**

6. Energize the drive and set  $o4-03 = 0$  [Fan Operation Time Setting = 0 h] to reset the fan operation time.

## ■ Circulation Fan Removal

### Note:

Use this procedure only when you use one of these drive models:

- 4065xF
- 2046xV, 2059xV
- 4040xV to 4065xV
- 2046xT, 2059xT
- 4040xT to 4065xT

Remove the drive cover before you start this procedure.

**CAUTION!** *Crush Hazard. Loosen the cover screws. Do not fully remove them. If you fully remove the cover screws, the terminal cover can fall and cause moderate injury.*

1. Remove the fan cable from the hooks.

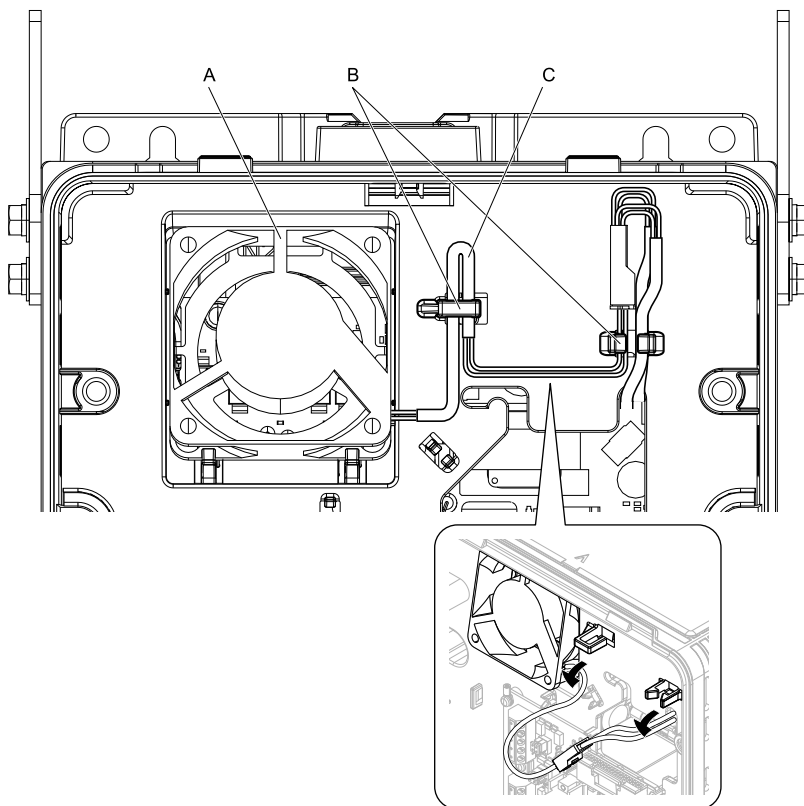

A - Circulation fan  
B - Hooks

C - Fan cable

**Figure 8.20 Remove the Fan Cable**

2. Disconnect the relay connector.

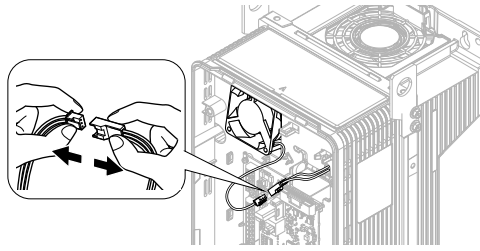

**Figure 8.21 Disconnect the Relay Connector**

3. Pull the bottom of the fan forward to remove it from the drive.

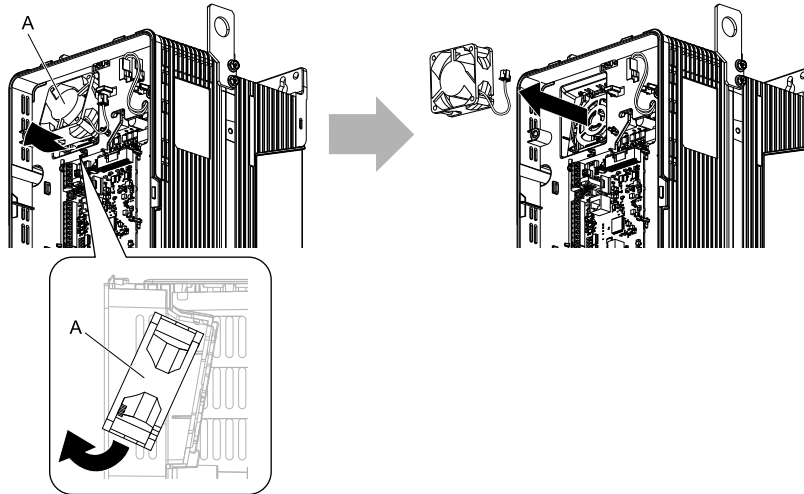

**A - Circulation fan**

**Figure 8.22 Remove the Circulation Fan**

### ■ Circulation Fan Installation

**Note:**

Use this procedure only when you use one of these drive models:

- 4065xF
- 2046xV, 2059xV
- 4040xV to 4065xV
- 2046xT, 2059xT
- 4040xT to 4065xT

Reverse the removal procedure for circulation fan installation.



1. Align the notch on the fan with the pin on the drive and install the fan in the drive.

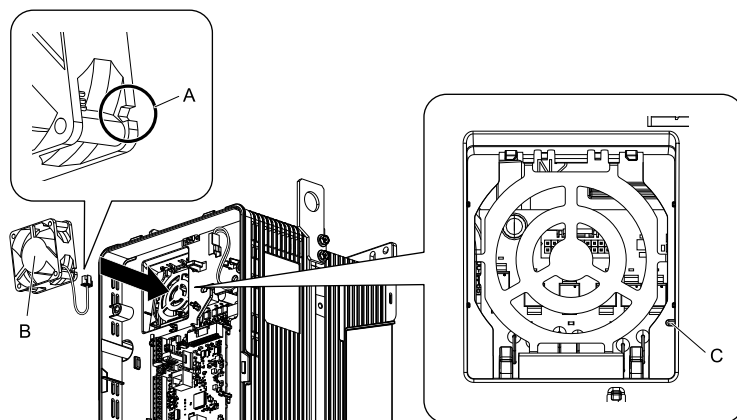

A - Notch on fan  
B - Circulation fan

C - Alignment pin on drive

**Figure 8.23 Install the Circulation Fan**

2. Put the side of the fan nearest to the top of the drive in first, and push it until the tabs click into position.

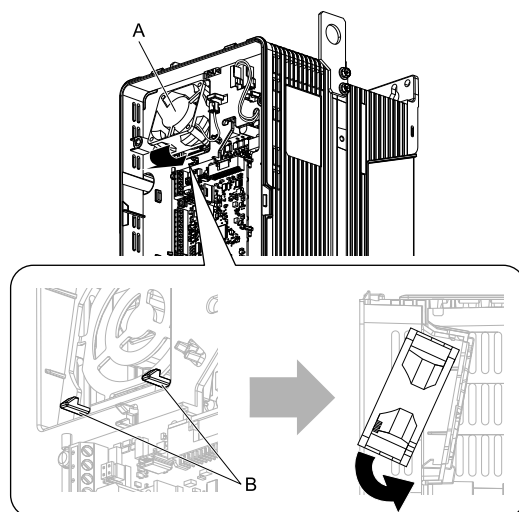

A - Circulation fan

B - Tabs

**Figure 8.24 Install the Circulation Fan**

3. Connect the relay connector.

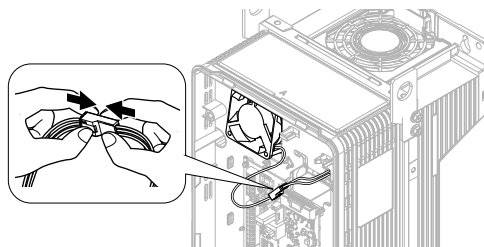

**Figure 8.25 Connect the Relay Connector**

- Put the cable and connector back into their initial positions.

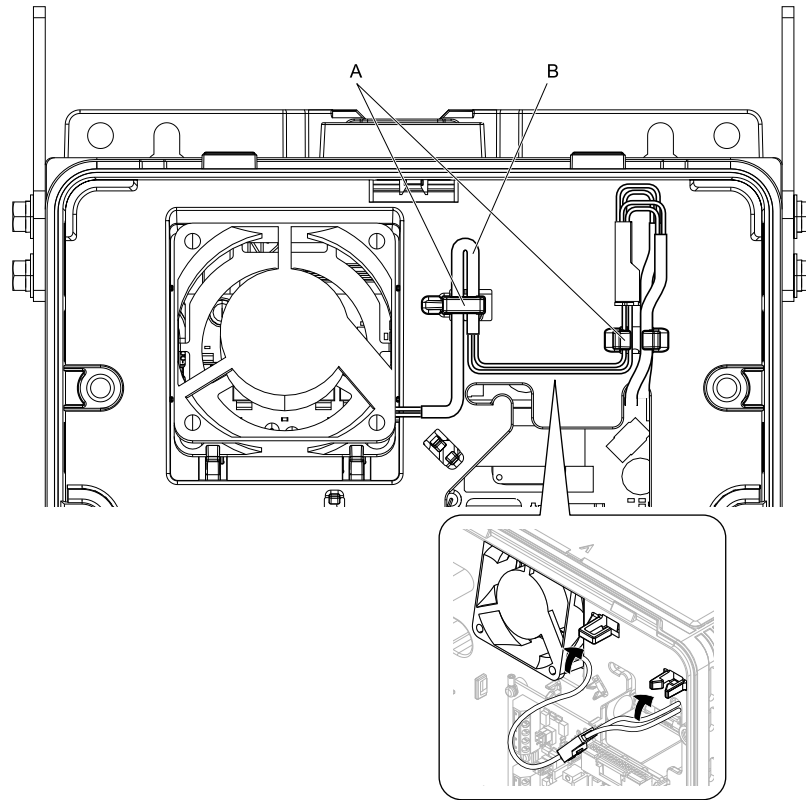

A - Hooks

B - Fan cable

Figure 8.26 Put the Cable Back into the Drive

### ◆ Fan Replacement (Procedure C)

**DANGER! Electrical Shock Hazard.** Do not examine, connect, or disconnect wiring on an energized drive. Before servicing, disconnect all power to the equipment and wait for the time specified on the warning label at a minimum. The internal capacitor stays charged after the drive is de-energized. The charge indicator LED extinguishes when the DC bus voltage decreases below 50 Vdc. When all indicators are OFF, remove the covers before measuring for dangerous voltages to make sure that the drive is safe. If you do work on the drive when it is energized, it will cause serious injury or death from electrical shock.

**CAUTION! Burn Hazard.** Do not touch a hot drive heatsink. De-energize the drive, wait for a minimum of 15 minutes, then make sure that the heatsink is cool before you replace the cooling fans. If you touch a hot drive heatsink, it can burn you.

**NOTICE:** Use the instructions in this manual to replace the cooling fans. When you do maintenance on the fans, replace all the fans to increase product life. If you install the fans incorrectly, it can cause damage to the drive.

## ■ Fan Removal

1. Push the tabs on the left and right sides of the fan finger guard and pull up to remove the fan finger guard from the drive.

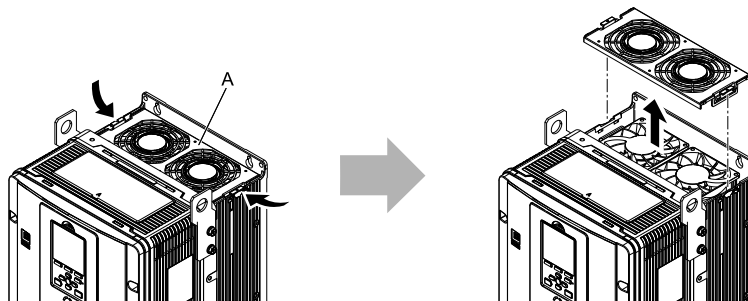

A - Fan finger guard

Figure 8.27 Remove the Fan Finger Guard

2. Pull the cooling fans straight up from the drive. Remove the protective tubes on the relay connectors and disconnect the connectors to remove the fans from the drive.

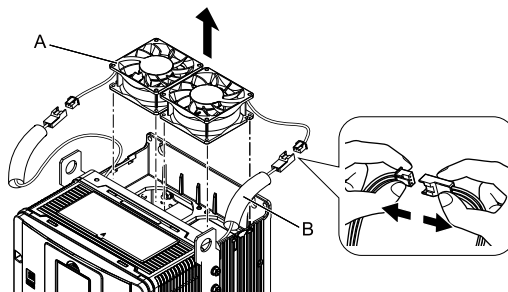

A - Cooling fans

B - Protective tubes

Figure 8.28 Remove the Cooling Fans

## ■ Fan Installation

Reverse the removal procedure for fan installation.

1. Connect the relay connectors between the drive and cooling fans, and attach the protective tubes.

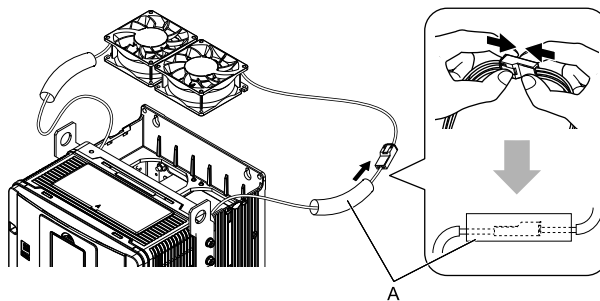

A - Protective tubes

Figure 8.29 Connect the Relay Connectors

- Align the notches on the fans with the pins on the drive and install the cooling fans in the drive.

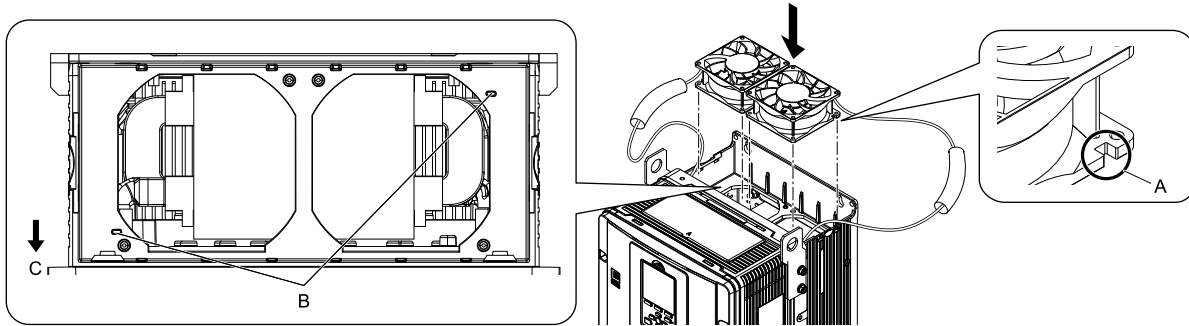

A - Notch on fan  
B - Alignment pins on drive

C - Front of drive

Figure 8.30 Install the Cooling Fans

- Put the cables and connectors in the recess of the drive.

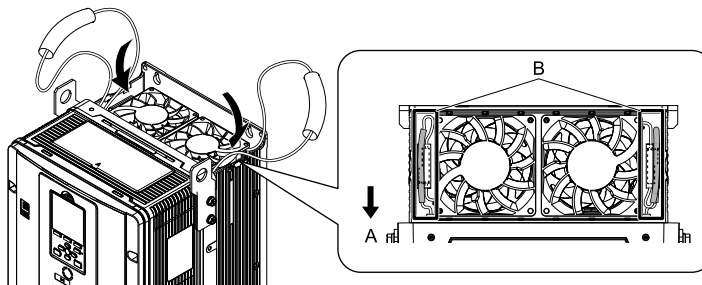

A - Front of drive

B - Recess for cables and connectors \*1

Figure 8.31 Put the Cables and Connectors in the Drive Recess

\*1 Make sure that the cables and connectors are in the correct space.

- Install the fan finger guard straight until the tabs click into place.

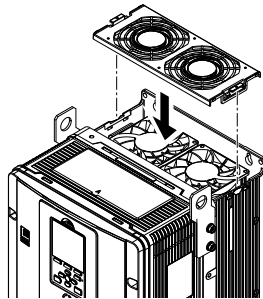

Figure 8.32 Install the Fan Finger Guard

- Energize the drive and set o4-03 = 0 [Fan Operation Time Setting = 0 h] to reset the fan operation time.

### ■ Circulation Fan Removal

#### Note:

Use this procedure only when you use one of these drive models:

- 2075xV to 2114xV
- 4077xV to 4124xV
- 2075xT to 2114xT
- 4077xT, 4096xT

Remove the drive cover before you start this procedure.

**CAUTION!** Crush Hazard. Loosen the cover screws. Do not fully remove them. If you fully remove the cover screws, the terminal cover can fall and cause moderate injury.

1. Pull the relay connector toward the top of the drive to remove from the hook then remove the cable from the hooks.

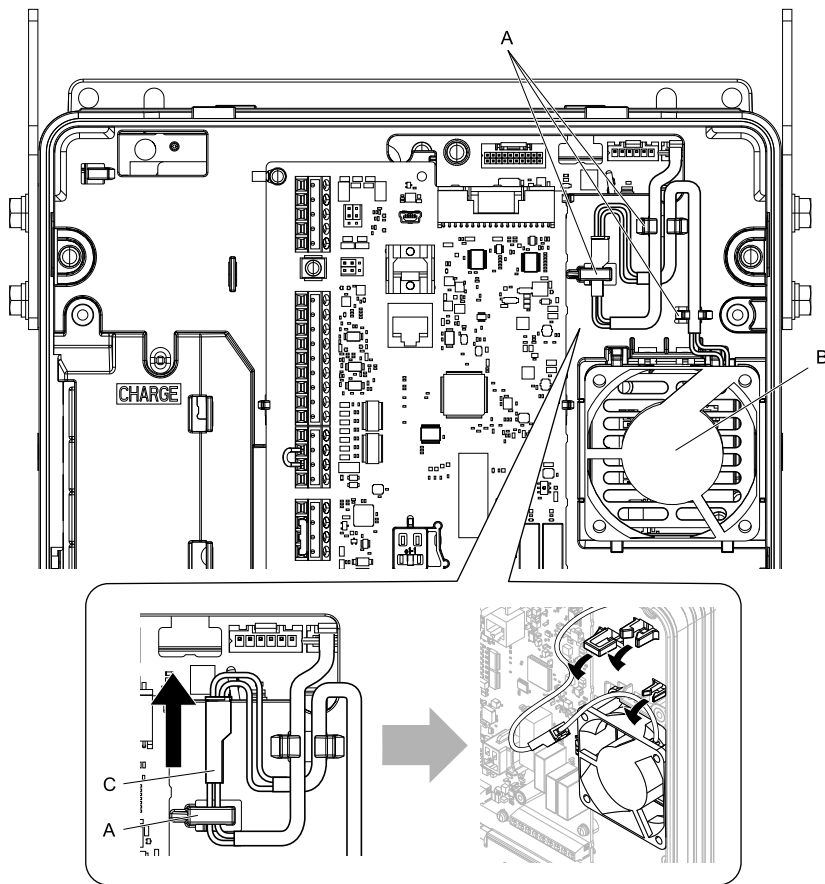

A - Hooks  
B - Circulation fan

C - Relay connector

Figure 8.33 Remove the Cable

2. Disconnect the relay connector.

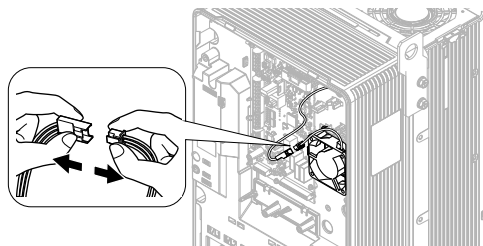
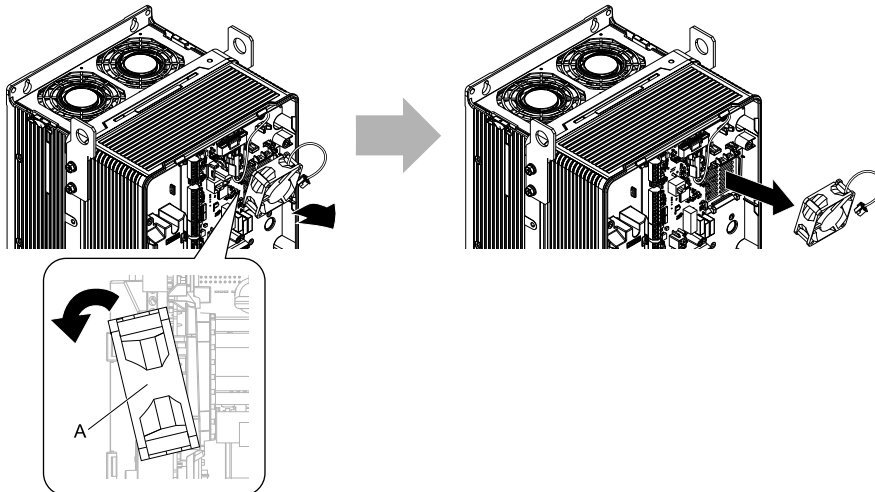

Figure 8.34 Disconnect the Relay Connector

3. Pull the top of the fan forward to remove it from the drive.



A - Circulation fan

Figure 8.35 Remove the Circulation Fan

### ■ Circulation Fan Installation

**Note:**

Use this procedure only when you use one of these drive models:

- 2075xV to 2114xV
- 4077xV to 4124xV
- 2075xT to 2114xT
- 4077xT, 4096xT

Reverse the removal procedure for circulation fan installation.

1. Put the bottom of the fan on the tabs in position A then push the fan until the tabs in position B click into position to put the fan back into the drive.

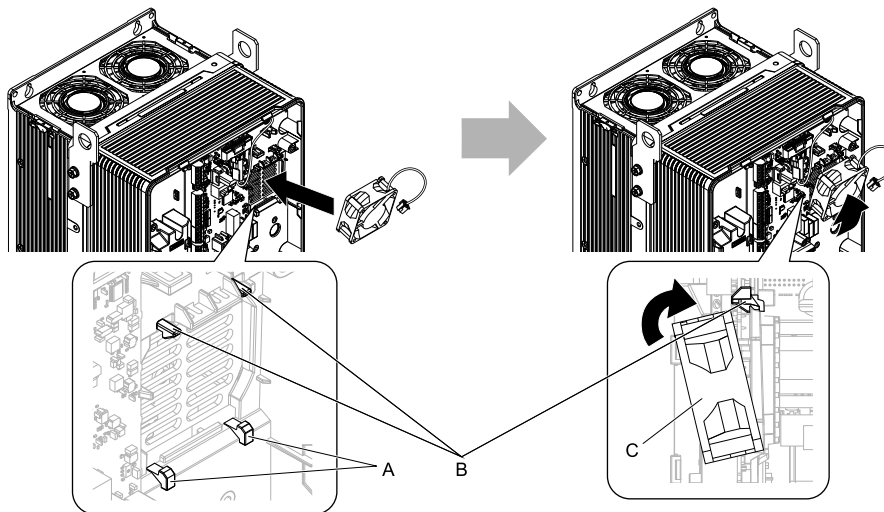

A - Tabs at the bottom of the fan

B - Tabs at the top of the fan

C - Circulation fan

Figure 8.36 Install the Circulation Fan

2. Connect the relay connector.

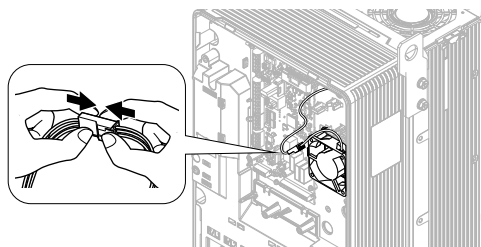
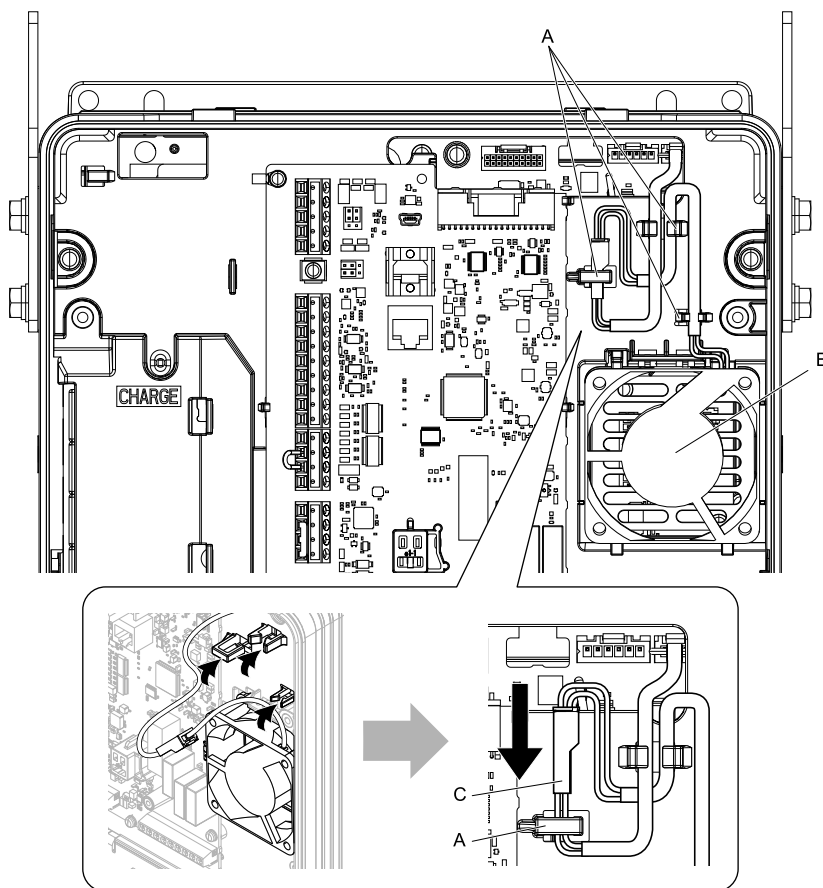

Figure 8.37 Connect the Relay Connector

3. Put the cable and relay connector back into their initial position.



A - Hooks  
B - Circulation fan

C - Relay connector

Figure 8.38 Put the Cable and Relay Connector Back into the Drive

### ◆ Fan Replacement (Procedure D)

**DANGER!** *Electrical Shock Hazard. Do not examine, connect, or disconnect wiring on an energized drive. Before servicing, disconnect all power to the equipment and wait for the time specified on the warning label at a minimum. The internal capacitor stays charged after the drive is de-energized. The charge indicator LED extinguishes when the DC bus voltage decreases below 50 Vdc. When all indicators are OFF, remove the covers before measuring for dangerous voltages to make sure that the drive is safe. If you do work on the drive when it is energized, it will cause serious injury or death from electrical shock.*

**CAUTION!** *Burn Hazard. Do not touch a hot drive heatsink. De-energize the drive, wait for a minimum of 15 minutes, then make sure that the heatsink is cool before you replace the cooling fans. If you touch a hot drive heatsink, it can burn you.*

**NOTICE:** *Use the instructions in this manual to replace the cooling fans. When you do maintenance on the fans, replace all the fans to increase product life. If you install the fans incorrectly, it can cause damage to the drive.*

### ■ Fan Removal

1. Push the tabs on the left and right sides of the fan finger guard and pull up to remove the fan finger guard from the drive.

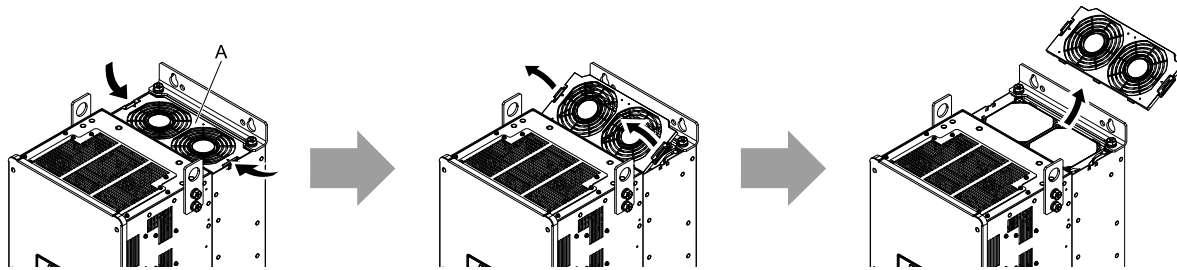

A - Fan finger guard

Figure 8.39 Remove the Fan Finger Guard

2. Pull the cooling fans straight up from the drive. Remove the protective tubes on the relay connectors and disconnect the connectors to remove the fans from the drive.

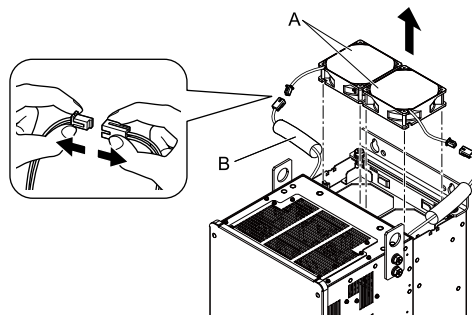

A - Cooling fans

B - Protective tubes

Figure 8.40 Remove the Cooling Fans

### ■ Fan Installation

Reverse the removal procedure for fan installation.

1. Connect the relay connectors, and attach the protective tubes.

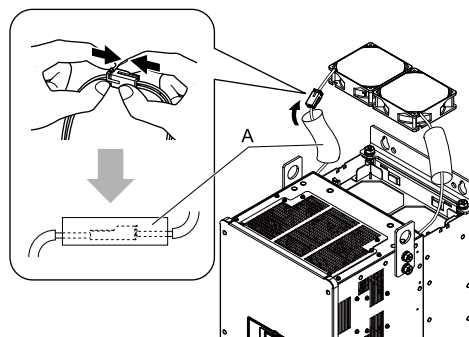

A - Protective tubes

Figure 8.41 Connect the Relay Connectors



- Align the notches on the fans with the pins on the drive and install the cooling fans in the drive.

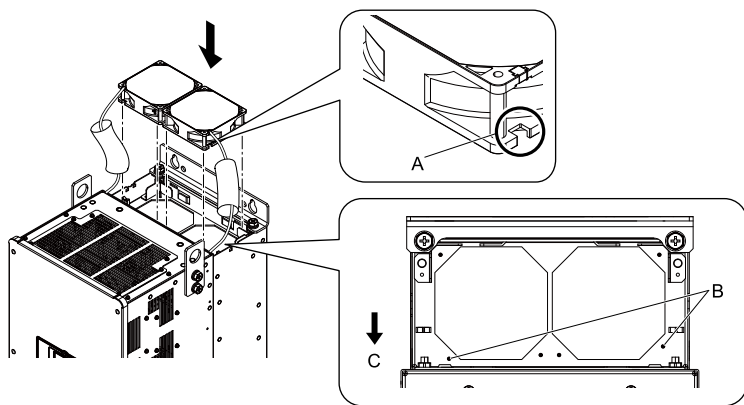

A - Notch on fan  
B - Alignment pins on drive

C - Front of drive

Figure 8.42 Install the Cooling Fans

- Put the cables and connectors in the recess of the drive.

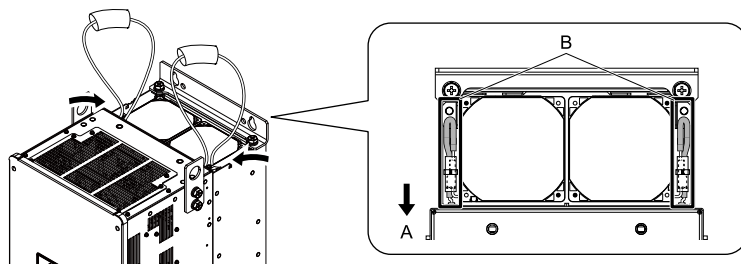

A - Front of drive

B - Recess for cables and connectors \*1

Figure 8.43 Put the Cables and Connectors in the Drive Recess

\*1 Make sure that the cables and connectors are in the correct space.

- Hold the fan finger guard at an angle and put the connector tabs on the fan finger guard into the holes on the drive.

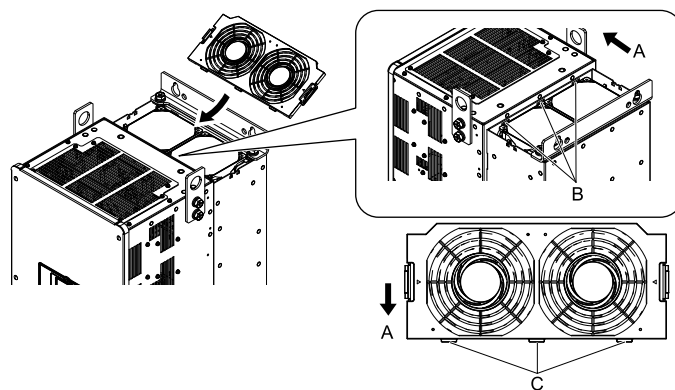

A - Front of drive  
B - Drive holes

C - Connector tabs

Figure 8.44 Install the Fan Finger Guard

5. Push the tabs on the left and right sides of the fan finger guard and click it into place on the drive.

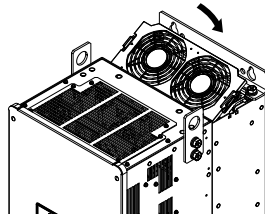

Figure 8.45 Install the Fan Finger Guard

6. Energize the drive and set o4-03 = 0 [Fan Operation Time Setting = 0 h] to reset the fan operation time.

### ◆ Fan Replacement (Procedure E)

**DANGER! Electrical Shock Hazard.** Do not examine, connect, or disconnect wiring on an energized drive. Before servicing, disconnect all power to the equipment and wait for the time specified on the warning label at a minimum. The internal capacitor stays charged after the drive is de-energized. The charge indicator LED extinguishes when the DC bus voltage decreases below 50 Vdc. When all indicators are OFF, remove the covers before measuring for dangerous voltages to make sure that the drive is safe. If you do work on the drive when it is energized, it will cause serious injury or death from electrical shock.

**CAUTION! Burn Hazard.** Do not touch a hot drive heatsink. De-energize the drive, wait for a minimum of 15 minutes, then make sure that the heatsink is cool before you replace the cooling fans. If you touch a hot drive heatsink, it can burn you.

**NOTICE:** Use the instructions in this manual to replace the cooling fans. When you do maintenance on the fans, replace all the fans to increase product life. If you install the fans incorrectly, it can cause damage to the drive.

### ■ Fan Removal

1. Push the tab on the back side of each fan finger guard and pull up to remove the fan finger guards from the drive.

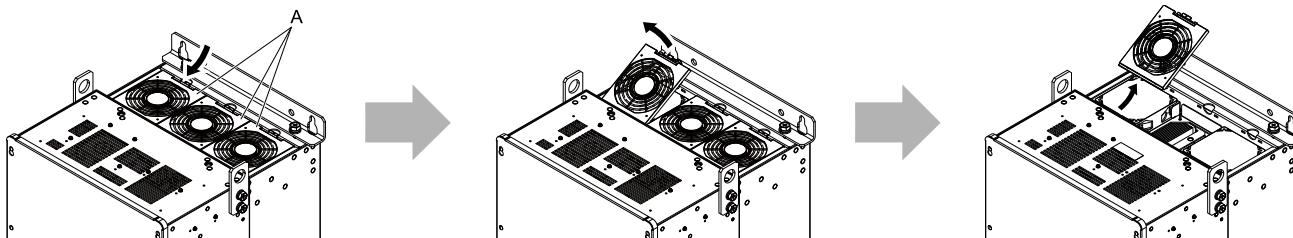

A - Fan finger guards

Figure 8.46 Remove the Fan Finger Guards

2. Pull the cooling fans straight up from the drive. Remove the protective tubes on the relay connectors and disconnect the connectors to remove the fans from the drive.

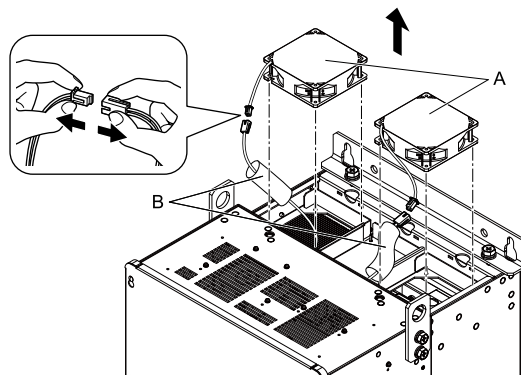

A - Cooling fans

B - Protective tubes

Figure 8.47 Remove the Cooling Fans

## ■ Fan Installation

Reverse the removal procedure for fan installation.

1. Connect the relay connectors, and attach the protective tubes.

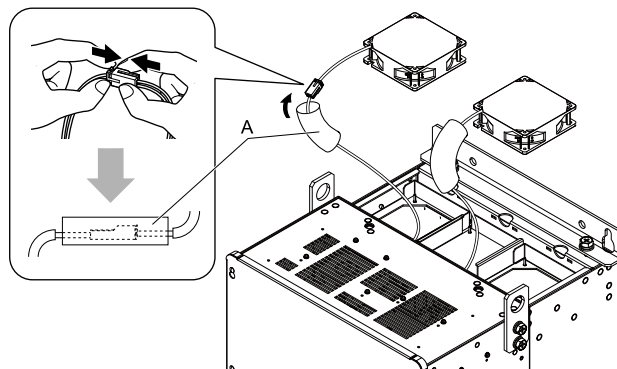

A - Protective tubes

Figure 8.48 Connect the Relay Connectors

2. Align the notches on the fans with the pins on the drive and install the cooling fans in the drive.

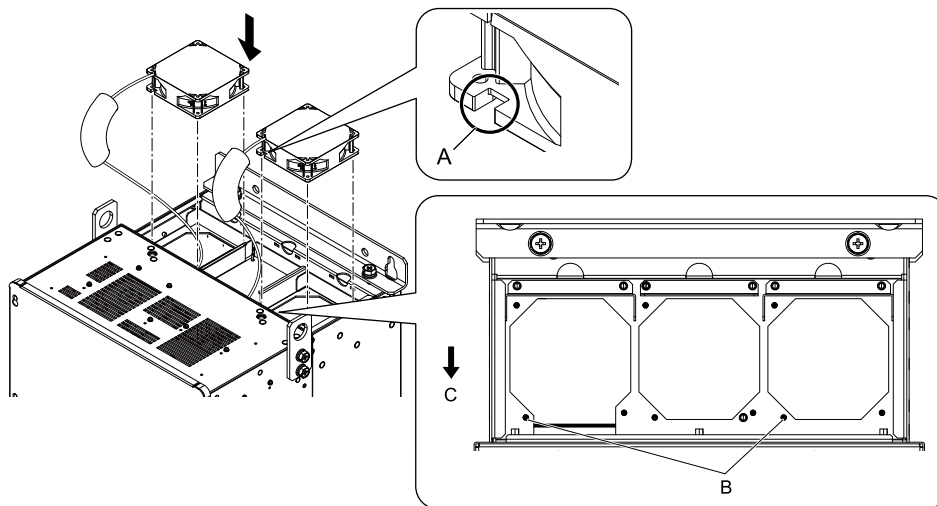

A - Notch on fan

B - Alignment pins on drive

C - Front of drive

Figure 8.49 Install the Cooling Fans

## 8.4 Replace Cooling Fans and Circulation Fans

- Put the cables and connectors in the recess of the drive.

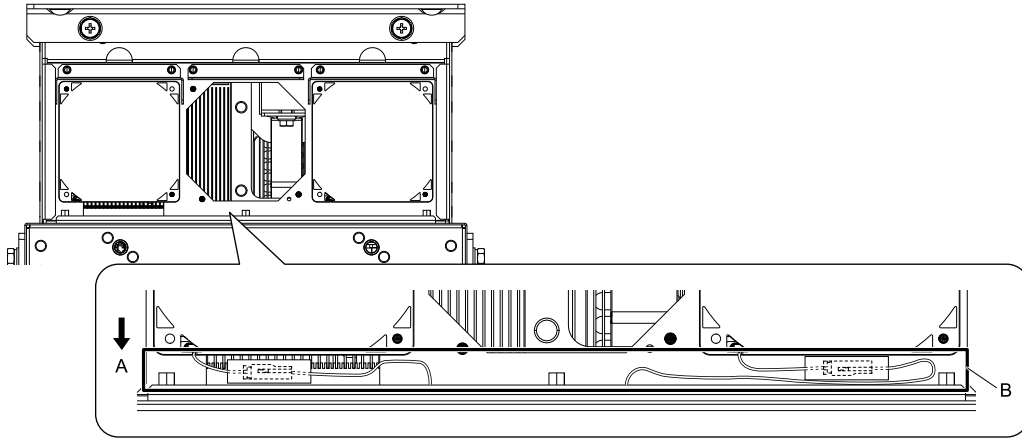

A - Front of drive

B - Recess for the cables and connectors \*1

**Figure 8.50 Put the Cables and Connectors in the Drive Recess**

\*1 Make sure that the cables and connectors are in the correct space.

- Hold the fan finger guards at an angle and put the connector tabs on the fan finger guards into the receiving areas on the drive.

**Note:**

When you install the cooling fans, make sure that you do not pinch cables between the fan finger guards and the drive.

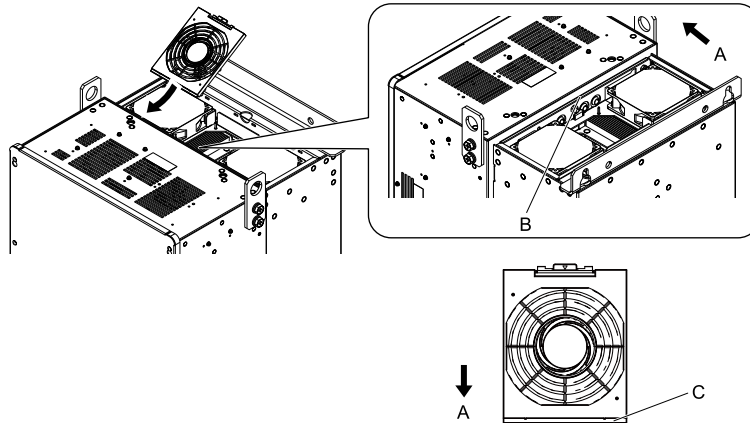

A - Front of drive

B - Receiving area

C - Tab

**Figure 8.51 Install the Fan Finger Guards**

5. Push the tabs on the back side of the fan finger guards and click them into place on the drive.

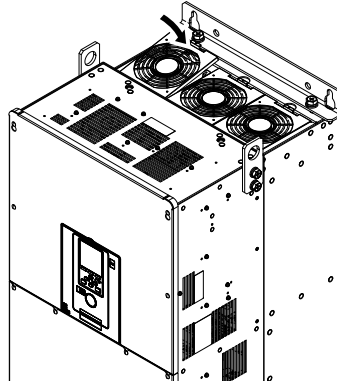

Figure 8.52 Install the Fan Finger Guards

6. Energize the drive and set  $\alpha 4-03 = 0$  [Fan Operation Time Setting = 0 h] to reset the fan operation time.

### ■ Circulation Fan Removal

Remove the drive cover before you start this procedure.

**CAUTION!** Crush Hazard. Loosen the cover screws. Do not fully remove them. If you fully remove the cover screws, the terminal cover can fall and cause moderate injury.

1. Remove the cable from the clamps.

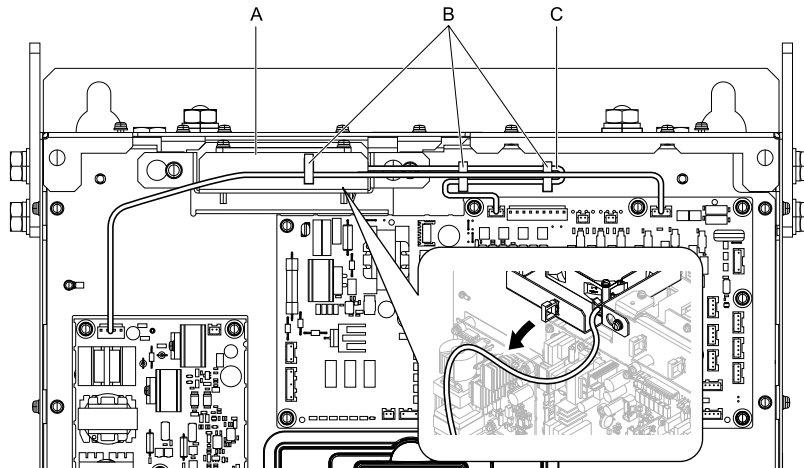

A - Fan unit  
B - Clamps

C - Fan cable

Figure 8.53 Remove the Fan Cable

2. Loosen the screws that safety the fan unit and slide the fan unit to the right.

**Note:**

To remove the fan unit, it is only necessary to loosen the screws.

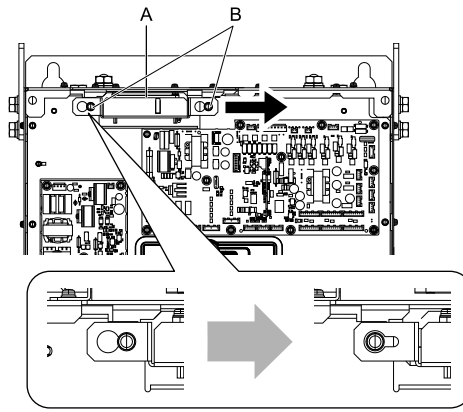

A - Fan unit

B - Screws

Figure 8.54 Slide the Fan Unit

3. Disconnect the relay connector and remove the fan unit.

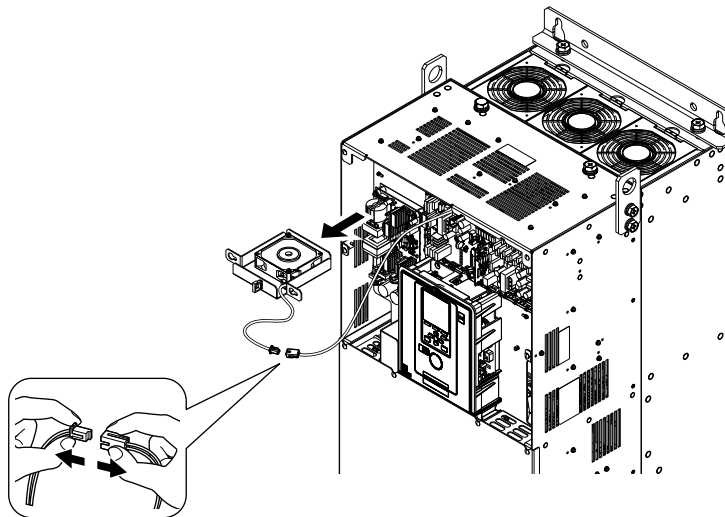
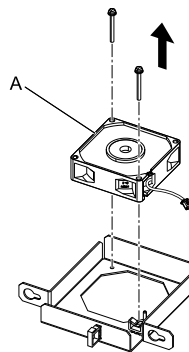

Figure 8.55 Remove the Fan Unit

4. Remove the screws that safety the circulation fan and remove the fan.



A - Circulation fan

Figure 8.56 Remove the Circulation Fan

### ■ Circulation Fan Installation

Reverse the removal procedure for fan installation.

1. Connect the relay connector between the drive and circulation fan.

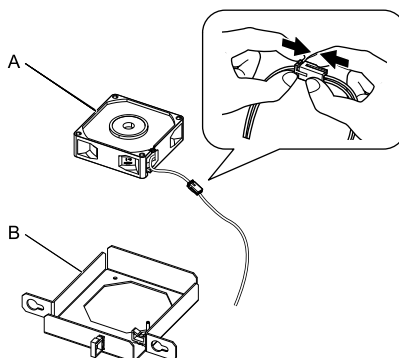

A - Circulation fan

B - Fan unit base

Figure 8.57 Connect the Relay Connector

2. Align the pin on the fan unit base with the notch on the fan and put the fan in the fan unit base, then use the screws to safety it.  
Tighten the screws to a tightening torque of 0.98 N·m to 1.33 N·m (8.67 lbf·in to 11.77 lbf·in).

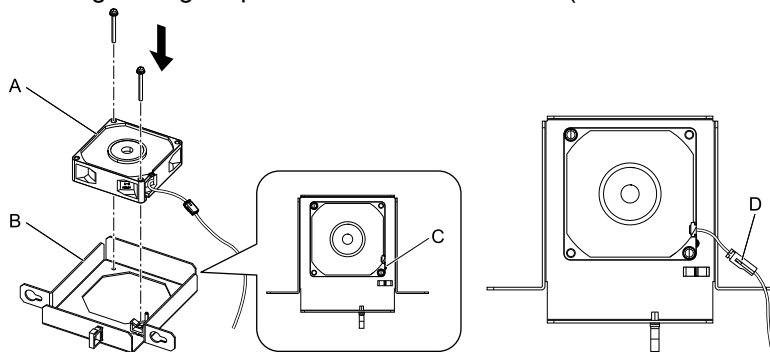

A - Circulation fan

B - Fan unit base

C - Alignment pin on fan unit base

D - Circulation fan connector

Figure 8.58 Install the Circulation Fan

3. Safety the fan cable through the clamp.

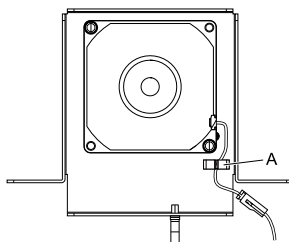

A - Clamp

Figure 8.59 Safety the Fan Cable

4. Put the fan unit into the specified location and slide it to the left, then use screws to safety it to the drive.  
Tighten the screws to a tightening torque of 1.96 N·m to 2.53 N·m (17.35 lbf·in to 22.39 lbf·in).

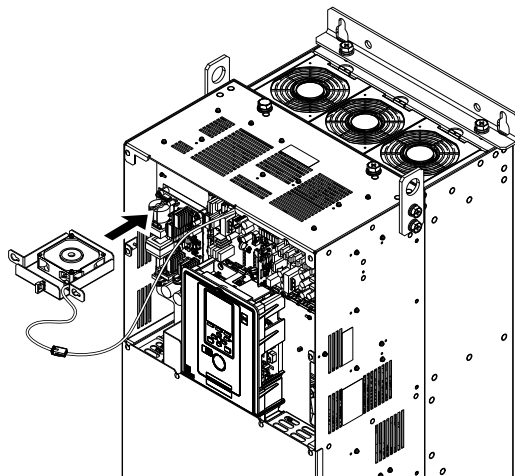

**Figure 8.60 Install the Fan Unit**

5. Safety the cable through the clamps.

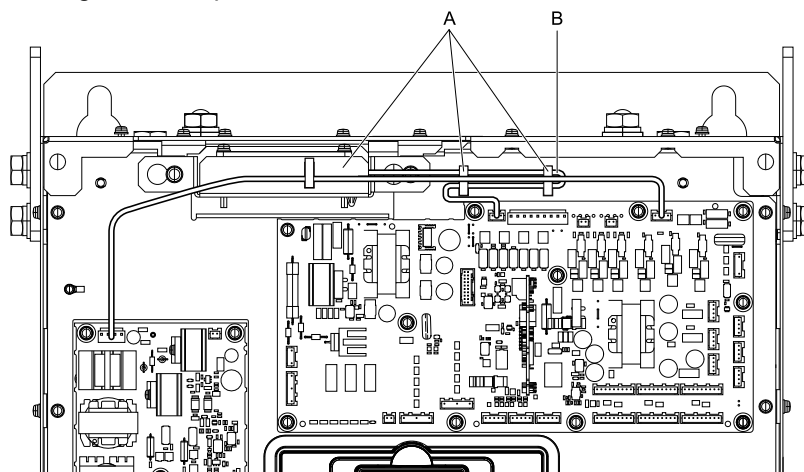

**A - Clamps**

**B - Fan cable**

**Figure 8.61 Safety the Fan Cable through the Clamps**

6. Install the drive cover.
7. Energize the drive and set  $o4-03 = 0$  [*Fan Operation Time Setting = 0 h*] to reset the fan operation time.



## 8.5 Replace the Keypad Battery

When the keypad battery is expired, the date and time go back to the default settings. Use this procedure to replace the battery.

**WARNING! Fire Hazard.** Handle keypad batteries properly. Do not charge the battery or disassemble the keypad. If the battery explodes, it can cause a fire.

To replace the battery, use a Hitachi Maxell “CR2016 Lithium Manganese Dioxide Lithium Battery” or an equivalent battery with these properties:

- Nominal voltage: 3 V
- Operating temperature range: -20 °C to + 85°C (-4 °F to +185 °F)

**WARNING! Fire Hazard.** Do not disassemble batteries. Do not expose batteries to heat or fire. If the battery explodes, it can cause a fire.

**NOTICE: Damage to Equipment.** The keypad battery stays in use after you de-energize the drive. When you will keep the drive de-energized for long periods of time, remove the battery from the keypad. When the expected life of the battery is complete, replace the battery immediately. A dead battery in the keypad can leak and cause damage to the keypad and drive.

The performance life estimate of a new battery is:

- Ambient temperature 20 °C (68 °F): 5 years
- Ambient temperature -10 °C to +50 °C (14 °F to 122 °F): 3.5 years

1. De-energize the drive and remove the keypad.
2. Use a slotted screwdriver or other tool to turn the battery cover counterclockwise and remove the cover.

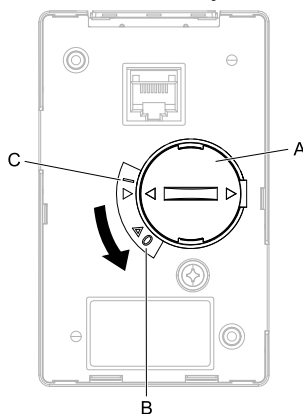

**A - Battery cover**  
**B - Opened**

**C - Closed**

**Figure 8.62 Remove the Battery Cover**

3. Remove the used battery from the keypad.
4. Insert the new battery.

**Note:**

- The battery cover side is the positive pole. Make sure that the polarity is correct when you put the battery in the keypad.
- Discard the used battery as specified by local regulations.

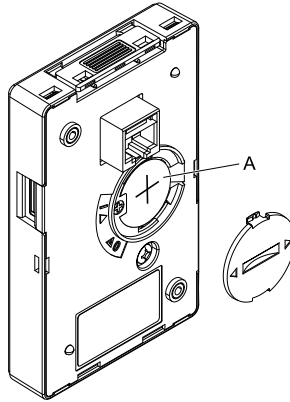

### A - Battery

**Figure 8.63 Insert the New Battery**

5. Put the battery cover on the keypad and use a slotted screwdriver to turn the battery cover clockwise to close it.
6. Install the keypad on the drive.

## 8.6 Storage Guidelines

The chemicals in the electrolytic capacitors and other electronic parts of the drive change over time. When you store the drive for long periods of time, use the information in this section to help keep the performance life estimates.

### ◆ Storage Location

- **Temperature and Humidity**  
When you store the drive for approximately one month, for example during shipping, you can put the drive in a location where the temperature is  $-20\text{ }^{\circ}\text{C}$  to  $+70\text{ }^{\circ}\text{C}$  ( $-4\text{ }^{\circ}\text{F}$  to  $+158\text{ }^{\circ}\text{F}$ ). Correctly package and store the drive during shipping to prevent vibration and impact damage.  
Do not put the drive in direct sunlight or where there will be condensation or ice. Put the drive in a location where the relative humidity is 95% or less.
- **Dust and Oil Mist**  
Do not keep the drive locations with dust or oil mist. For example, cement factories and cotton mills.
- **Corrosive Gas**  
Do not keep the drive in locations with corrosive gas. For example, chemical plants, refineries, and sewage plants.
- **Salt Damage**  
Do not keep the drive in salty locations. For example, locations near the ocean, and salt damage-designated locations.

Do not keep the drive in unsatisfactory locations. Keep all drives in storage rooms that are safe from unsatisfactory elements.

### ◆ Regular Application of Power

To prevent deterioration of the capacitors, Yaskawa recommends that you apply power to the drive a minimum of one time each year for a minimum of 30 minutes.

If you store the drive for longer than two years and do not apply power, Yaskawa recommends that you use a variable power source and gradually increase the power from 0 V to the rated drive voltage over a period of 2 to 3 minutes. Apply power for a minimum of 1 hour with no load to reform the main circuit electrolytic capacitor. When you operate the drive after you apply power, wire the drive correctly and check for drive faults, overcurrents, motor vibration, motor speed differences, and other defects during operation.

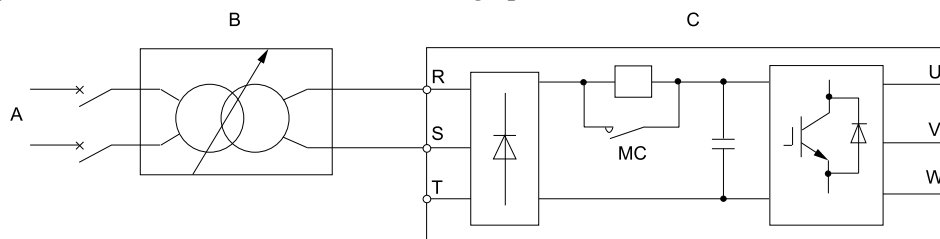

A - AC power supply

B - Variable power source

C - Drive

Figure 8.64 Power Distribution Method



## Disposal

---

<b>9.1</b>	<b>Section Safety .....</b>	<b>416</b>
<b>9.2</b>	<b>Disposal Instructions .....</b>	<b>417</b>
<b>9.3</b>	<b>WEEE Directive .....</b>	<b>418</b>

## 9.1 Section Safety

### WARNING

#### Electrical Shock Hazard

**De-energize the drive and wait 5 minutes minimum until the Charge LED turns off. Remove the front cover and terminal cover to do work on wiring, circuit boards, and other parts. Use terminals for their correct function only.**

Incorrect wiring, incorrect ground connections, and incorrect repair of protective covers can cause death or serious injury.

**Only let approved personnel install, wire, maintain, examine, replace parts, and repair the drive.**

If personnel are not approved, it can cause serious injury or death.

**Do not wear loose clothing or jewelry when you do work on the drive. Tighten loose clothing and remove all metal objects, for example watches or rings.**

Loose clothing can catch on the drive and jewelry can conduct electricity and cause serious injury or death.

#### Fire Hazard

**Handle keypad batteries properly. Do not charge the battery or disassemble the keypad.**

If the battery explodes, it can cause a fire.

**Do not disassemble batteries. Do not expose batteries to heat or fire.**

If the battery explodes, it can cause a fire.

#### Crush Hazard

**Wear eye protection when you do work on the drive.**

If you do not use correct safety equipment, it can cause serious injury or death.

**Only approved personnel can operate a crane or hoist to move the drive.**

If unapproved personnel operate a crane or hoist, it can cause serious injury or death from falling equipment.

**Use a crane or hoist to move large drives when necessary.**

If you try to move a large drive without a crane or hoist, it can cause serious injury or death.

### CAUTION

#### Crush Hazard

**Tighten terminal cover screws and hold the case safely when you move the drive.**

If the drive or covers fall, it can cause moderate injury.

### NOTICE

#### Damage to Equipment

**The keypad battery stays in use after you de-energize the drive. When you will keep the drive de-energized for long periods of time, remove the battery from the keypad. When the expected life of the battery is complete, replace the battery immediately.**

A dead battery in the keypad can leak and cause damage to the keypad and drive.

## 9.2 Disposal Instructions

Correctly discard the drive, packing material, battery, and microSD card as specified by regional, local, and municipal laws and regulations for this product.

**Note:**

- Remove the battery and microSD card from the keypad before you discard the drive.
- You cannot recycle the battery. Discard used batteries as specified by the battery manufacturer.
- Customers are responsible for microSD card data protection.  
PC functions that format and delete the data may not be sufficient to fully erase the microSD card data. Yaskawa recommends that customers physically destroy the microSD card in a shredder or use data wipe software to fully erase the card.

## 9.3 WEEE Directive



The wheeled bin symbol on this product, its manual, or its packaging identifies that you must recycle it at the end of its product life.

You must discard the product at an applicable collection point for electrical and electronic equipment (EEE). Do not discard the product with usual waste.



## Specifications

---

<b>10.1</b>	<b>Section Safety .....</b>	<b>420</b>
<b>10.2</b>	<b>Model Specifications (208 V Class) .....</b>	<b>421</b>
<b>10.3</b>	<b>Model Specifications (480 V Class) .....</b>	<b>422</b>
<b>10.4</b>	<b>Common Drive Specifications .....</b>	<b>424</b>
<b>10.5</b>	<b>Drive Watt Loss .....</b>	<b>427</b>
<b>10.6</b>	<b>Drive Derating .....</b>	<b>429</b>
<b>10.7</b>	<b>Drive Exterior and Mounting Dimensions .....</b>	<b>433</b>
<b>10.8</b>	<b>Knock-Out Hole Dimensions .....</b>	<b>452</b>
<b>10.9</b>	<b>Peripheral Devices and Options .....</b>	<b>461</b>

## 10.1 Section Safety

 **DANGER**

**Do not ignore the safety messages in this manual.**

If you ignore the safety messages in this manual, it will cause serious injury or death. The manufacturer is not responsible for injuries or damage to equipment.

## 10.2 Model Specifications (208 V Class)

**Table 10.1 Rating (208 V Class)**

Model		2011	2017	2024	2031	2046	2059	2075	2088	2114	
Maximum Applicable Motor Output (kW) <sup>*1</sup>		2.2	3.7	5.5	7.5	11	15	18.5	22	30	
Maximum Applicable Motor Output (HP) <sup>*2</sup>		3	5	7.5	10	15	20	25	30	40	
Input	Rated Input Current (A)	AC	8.8	14	20	27	40	54	66	78	106
		DC	10.0	17.0	25	34	49	66	80	95	129
Output	Rated Output Current (A)	10.6	16.7	24.2	30.8	46.2	59.4	74.8	88	114	
Power Supply	Input Power (kVA)	3.7	5.8	8	11	17	22	27	33	44	

- \*1 The maximum applicable motor output is based on 4-pole, general-purpose 220 V motor ratings. The rated output current of the drive output amps must be equal to or more than the motor rated current.
- \*2 The maximum applicable motor output complies with 208 V motor ratings as specified in NEC Table 430.250. The rated output current of the drive output amps must be equal to or more than the motor rated current.

**Table 10.2 Rating (208 V Class)**

Model		2143	2169	2211	2273	
Maximum Applicable Motor Output (kW) <sup>*1</sup>		37	45	55	75	
Maximum Applicable Motor Output (HP) <sup>*2</sup>		50	60	75	100	
Input	Rated Input Current (A)	AC	130	157	192	258
		DC	159	191	233	315
Output	Rated Output Current (A)	143	169	211	273	
Power Supply	Input Power (kVA)	54	65	79	107	

- \*1 The maximum applicable motor output is based on 4-pole, general-purpose 220 V motor ratings. The rated output current of the drive output amps must be equal to or more than the motor rated current.
- \*2 The maximum applicable motor output complies with 208 V motor ratings as specified in NEC Table 430.250. The rated output current of the drive output amps must be equal to or more than the motor rated current.

## 10.3 Model Specifications (480 V Class)

**Table 10.3 Rating (480 V Class)**

Model		4005	4008	4011	4014	4021	4027	
Maximum Applicable Motor Output (kW) at 400 V Output *1		1.5	3	4	5.5	7.5	11	
Maximum Applicable Motor Output (HP) at 460 V Output *2		3	5	7.5	10	15	20	
Input	Rated Input Current (A) at 400 V Input	AC	4.1	7.1	8.9	11.9	17.5	23.4
		DC	5.0	8.7	11.0	15.0	21	29
	Rated Input Current (A) at 460 V Input	AC	3.8	6.2	9	12.1	17.4	23.5
		DC	4.7	7.6	11.0	14.8	21.3	28.8
Output	Rated Output Current (A)		4.8	7.6	11	14	21	27
Power Supply	Input Power (kVA) at 400 V Input		2.8	4.9	6.2	8.2	12	16
	Input Power (kVA) at 460 V Input		3.2	5.2	7	10	14	20

\*1 The motor capacity (kW) refers to a IEC 60947-4-1, Annex G 400 V motor. The rated output current of the drive output amps should be equal to or greater than the motor rated current.

\*2 The maximum applicable motor output complies with 460 V motor ratings as specified in NEC Table 430.250. The rated output current of the drive output amps must be equal to or more than the motor rated current.

**Table 10.4 Rating (480 V Class)**

Model		4034	4040	4052	4065	4077	4096	
Maximum Applicable Motor Output (kW) at 400 V Output *1		15	18.5	22	30	37	45	
Maximum Applicable Motor Output (HP) at 460 V Output *2		25	30	40	50	60	75	
Input	Rated Input Current (A) at 400 V Input	AC	31	38	44	59.6	74.9	89.2
		DC	38	47	54	73	92	109
	Rated Input Current (A) at 460 V Input	AC	28.7	34	45.9	56.3	68.1	82.8
		DC	35.2	41.6	56.2	69.0	83.4	101
Output	Rated Output Current (A)		34	40	52	65	77	96
Power Supply	Input Power (kVA) at 400 V Input		21	26	30	41	52	62
	Input Power (kVA) at 460 V Input		24	28	38	47	57	69

\*1 The motor capacity (kW) refers to a IEC 60947-4-1, Annex G 400 V motor. The rated output current of the drive output amps should be equal to or greater than the motor rated current.

\*2 The maximum applicable motor output complies with 460 V motor ratings as specified in NEC Table 430.250. The rated output current of the drive output amps must be equal to or more than the motor rated current.

**Table 10.5 Rating (480 V Class)**

Model		4124	4156	4180	4240	4302	
Maximum Applicable Motor Output (kW) at 400 V Output *1		55	75	90	110	160	
Maximum Applicable Motor Output (HP) at 460 V Output *2		100	125	150	200	250	
Input	Rated Input Current (A) at 400 V Input	AC	103	140	168	205	296
		DC	126	171	206	251	363
	Rated Input Current (A) at 460 V Input	AC	112	134	163	221	289
		DC	137	164	200	271	354
Output	Rated Output Current (A)		124	156	180	240	302
Power Supply	Input Power (kVA) at 400 V Input		71	97	116	142	205
	Input Power (kVA) at 460 V Input		93	111	136	184	240

\*1 The motor capacity (kW) refers to a IEC 60947-4-1, Annex G 400 V motor. The rated output current of the drive output amps should be equal to or greater than the motor rated current.

- \*2 The maximum applicable motor output complies with 460 V motor ratings as specified in NEC Table 430.250. The rated output current of the drive output amps must be equal to or more than the motor rated current.

## 10.4 Common Drive Specifications

**Note:**

To get the longest product life, install the drive in an environment that meets the necessary specifications.

**Table 10.6 Control Characteristics**

Item	Specification
Control Methods	<ul style="list-style-type: none"> <li>V/f Control (V/f)</li> <li>PM Open Loop Vector Control (OLV/PM)</li> <li>EZ Open Loop Vector Control (EZOLV)</li> </ul>
Frequency Control Range	<ul style="list-style-type: none"> <li>EZOLV: 0.01 Hz to 120 Hz</li> <li>V/f and OLV/PM: 0.01 Hz to 400 Hz</li> </ul>
Frequency Accuracy (Temperature Fluctuation)	Digital inputs: Within $\pm 0.01\%$ of the maximum output frequency ( $-10\text{ }^{\circ}\text{C}$ to $+40\text{ }^{\circ}\text{C}$ ( $14\text{ }^{\circ}\text{F}$ to $104\text{ }^{\circ}\text{F}$ )) Analog inputs: Within $\pm 0.1\%$ of the maximum output frequency ( $25\text{ }^{\circ}\text{C} \pm 10\text{ }^{\circ}\text{C}$ ( $77\text{ }^{\circ}\text{F} \pm 18\text{ }^{\circ}\text{F}$ ))
Frequency Setting Resolution	Digital inputs: 0.01 Hz Analog inputs: 1/2048 of the maximum output frequency (11-bit)
Output Frequency Resolution	0.001 Hz
Frequency Setting Signal	Main speed frequency reference: 0 Vdc to 10 Vdc (20 k $\Omega$ ), 4 mA to 20 mA (250 $\Omega$ ), 0 mA to 20 mA (250 $\Omega$ )
Starting Torque	<ul style="list-style-type: none"> <li>V/f: 140%/3 Hz</li> <li>OLV/PM: 100%/10% speed</li> <li>EZOLV: 100%/10% speed</li> </ul>
Speed Control Range	<ul style="list-style-type: none"> <li>For Induction Motors: <ul style="list-style-type: none"> <li>V/f: 1:40</li> <li>EZOLV: 1:10</li> </ul> </li> <li>For Permanent Magnet Motors and Synchronous Reluctance Motors: <ul style="list-style-type: none"> <li>OLV/PM: 1:20</li> <li>EZOLV: 1:10</li> </ul> </li> </ul>
Torque Limits	Parameter settings allow different limits in four quadrants in EZOLV control method.
Accel/Decel Time	0.1 s to 6000.0 s The drive can set two pairs of different acceleration and deceleration times.
V/f Characteristics	Select from 15 pre-defined V/f patterns, or a user-set V/f pattern.
Main Control Functions	Restart After Momentary Power Loss, Speed Search, Overtorque/Undertorque Detection, Torque Limit, 9 Step Speed (max.), Accel/Decel Switch, S-curve Acceleration/Deceleration, 3-wire Sequence, Auto-Tuning (Rotational and Stationary), Cooling Fan ON/OFF Switch, Slip Compensation, Torque Compensation, Jump Frequency, Upper/Lower Limits for Frequency Reference, DC Injection Braking at Start and Stop, Overexcitation Braking, High Slip Braking, PID Control (with Sleep Function), Energy Saving Control, APOGEE FLN Communication (RS-485 4.8 kbps), BACnet Communication (RS-485 max. 76.8 kbps), MEMOBUS/Modbus Communication (RS-485 max. 115.2 kbps), Metasys N2 Communication (RS-485 9.6 kbps), Auto Restart, Application Presets, DriveWorksEZ (customized functions), KEB, Overexcitation Deceleration, Overvoltage Suppression

**Table 10.7 Protection Functions**

Item	Specification
Motor Protection	Electronic thermal overload protection
Momentary Overcurrent Protection	Drive stops when the output current is more than 175% of the drive rated output current.
Overload Protection	Drive stops when the output current is more than these overload tolerances: <ul style="list-style-type: none"> <li>110% of the rated output current for 60 seconds</li> <li>140% of the rated output current for 2.5 seconds when the drive output frequency is 3 Hz</li> </ul> The permitted frequency of overload is one time each 10 minutes. <b>Note:</b> If output frequency < 6 Hz, the drive can trigger the overload protection function when the output current is in the overload tolerance range.
Overvoltage Protection	208 V class: Stops when the DC bus voltage is more than approximately 410 V 480 V class: Stops when the DC bus voltage is more than approximately 820 V
Undervoltage Protection	208 V class: Stops when the DC bus voltage decreases to less than approximately 190 V 480 V class: <ul style="list-style-type: none"> <li>Stops when the DC bus voltage decreases to less than approximately 350 V when you use an input voltage less than 400 V</li> <li>Stops when the DC bus voltage decreases to less than approximately 380 V when you use an input voltage less than 460 V</li> <li>Stops when the DC bus voltage decreases to less than approximately 440 V when you use an input voltage of 460 V or more</li> </ul>

Item	Specification
Momentary Power Loss Ride-thru	Immediately stops when power loss is 15 ms or longer. Continues operation if power loss is shorter than 2 s (depending on parameter settings). <b>Note:</b> Stop time may be shortened depending on the load and motor speed.
Heatsink Overheat Protection	The drive stops when the thermistor detects an IGBT temperature more than approximately 100 °C (212 °F). The trip temperature level is different for different drive models.
Stall Prevention	Stall prevention is available during acceleration, deceleration, and during run.
Ground Fault Protection	Electronic circuit protection <b>Note:</b> This protection detects ground faults during run. The drive will not provide protection when: <ul style="list-style-type: none"> <li>• There is a low-resistance ground fault for the motor cable or terminal block</li> <li>• Energizing the drive when there is a ground fault.</li> </ul>
DC Bus Charge LED	Charge LED illuminates when DC bus voltage is more than 50 V.

Table 10.8 Environment

Item	Specification
Area of Use	Indoors
Power Supply	Overvoltage Category III
Ambient Temperature Setting	IP20/UL Type 1 and IP55/UL Type 12: -10 °C to +40 °C (14 °F to 104 °F) IP20/UL Open Type/Heatsink External Mounting: -10 °C to +50 °C (14 °F to 122 °F) <ul style="list-style-type: none"> <li>• When you install the drive in an enclosure, use a cooling fan or air conditioner to keep the internal air temperature in the permitted range.</li> <li>• Do not let the drive freeze.</li> <li>• You can use IP20/UL Open Type and IP20/UL Type 1 drives at a maximum of 60 °C (140 °F) when you derate the output current.</li> <li>• You can use IP55/UL Type 12 drives at a maximum of 50 °C (122 °F) when you derate the output current.</li> </ul>
Humidity	95% RH or less Do not let condensation form on the drive.
Storage Temperature	-20 °C to +70 °C (-4 °F to +158 °F) (short-term temperature during transportation)
Surrounding Area	Pollution degree 2 or less Install the drive in an area without: <ul style="list-style-type: none"> <li>• Oil mist, corrosive or flammable gas, or dust</li> <li>• Metal powder, oil, water, or other unwanted materials</li> <li>• Radioactive materials or flammable materials, including wood</li> <li>• Harmful gas or fluids</li> <li>• Salt</li> <li>• Direct sunlight</li> </ul>
Altitude	1000 m (3281 ft) maximum <b>Note:</b> Derate the output current by 1% for each 100 m (328 ft) to install the drive in altitudes between 1000 m to 4000 m (3281 ft to 13123 ft). It is not necessary to derate the rated voltage in these conditions: <ul style="list-style-type: none"> <li>• When you install the drive at 2000 m (6562 ft) or lower</li> <li>• When you install the drive between 2000 m to 4000 m (6562 ft to 13123 ft) and ground the neutral point on the power supply.</li> </ul>
Vibration	<ul style="list-style-type: none"> <li>• For models 2xxxxB/F/V and 4xxxxB/F/V without Main Switch: <ul style="list-style-type: none"> <li>– 10 Hz to 20 Hz: 1 G (9.8 m/s<sup>2</sup>, 32.15 ft/s<sup>2</sup>)</li> <li>– 20 Hz to 55 Hz: <ul style="list-style-type: none"> <li>2011 to 2031, 4005 to 4034: 0.6 G (5.9 m/s<sup>2</sup>, 19.36 ft/s<sup>2</sup>)</li> <li>2046 to 2273, 4040 to 4302: 0.2 G (1.96 m/s<sup>2</sup>, 6.43 ft/s<sup>2</sup>)</li> </ul> </li> </ul> </li> <li>• For models 2xxxxT and 4xxxxT with Main Switch: <ul style="list-style-type: none"> <li>– 10 Hz to 20 Hz: 1 G (9.8 m/s<sup>2</sup>, 32.15 ft/s<sup>2</sup>)</li> <li>– 20 Hz to 55 Hz: 0.2 G (1.96 m/s<sup>2</sup>, 6.43 ft/s<sup>2</sup>)</li> </ul> </li> </ul>
Installation Orientation	Install the drive vertically for sufficient airflow to cool the drive.

Table 10.9 Certifications and Standard Compliance

Item	Specification
UL/cUL	UL 508C
CE Low Voltage Directive 2014/35/EU	<ul style="list-style-type: none"> <li>• EN 61800-5-1:2007/A1:2017</li> <li>• IEC 61800-5-1:2007+AMD1:2016</li> </ul>

## 10.4 Common Drive Specifications

Item	Specification
CE EMC Directive 2014/30/EU	EN 61800-3:2004/A1:2012 First environment restricted distribution
CE Machinery Directive 2006/42/EC	<ul style="list-style-type: none"> <li>• EN 61800-5-2:2017 (SIL3)</li> <li>• IEC 61800-5-2:2016 (SIL3)</li> <li>• EN 62061:2005/A2:2015 (SIL CL3)</li> <li>• IEC 62061:2005+AMD1:2012+AMD2:2015 CSV (SIL CL3)</li> <li>• EN ISO 13849-1:2015 (PL e (Cat.III))</li> </ul>
TUV SUD	<ul style="list-style-type: none"> <li>• Functional Safety               <ul style="list-style-type: none"> <li>– IEC 61800-5-2:2016 (SIL3)</li> <li>– EN 61800-5-2:2017 (SIL3)</li> <li>– EN 61508:2010 (SIL3)</li> <li>– IEC 61508:2010 (SIL3)</li> <li>– EN 62061:2005/A2:2015 (SIL CL3)</li> <li>– IEC 62061:2005+AMD1:2012+AMD2:2015 CSV (SIL CL3)</li> </ul> </li> <li>• Machinery Safety               <ul style="list-style-type: none"> <li>– EN ISO 13849-1:2015 (Cat.III, PL e)</li> <li>– ISO 13849-1:2015 (Cat.III, PL e)</li> </ul> </li> <li>• EMC               <ul style="list-style-type: none"> <li>– EN 61000-6-7:2015</li> <li>– EN 61326-3-1:2017</li> <li>– EN 61800-3:2004+A1:2012</li> <li>– EN 61800-5-2:2017</li> </ul> </li> <li>• LVD               <ul style="list-style-type: none"> <li>– EN 61800-5-1:2007/A1:2017</li> <li>– IEC 61800-5-1:2007+AMD1:2016</li> </ul> </li> </ul>
RoHS Directive 2011/65/EU	-
WEEE Directive 2012/19/EU	-

**Table 10.10 Enclosure Ratings**

Item	Specification
Protection Design	IP20/UL Open Type IP20/UL Type 1 IP55/UL Type 12 IP55/UL Type 12 with Main Switch  <b>Note:</b> Install a UL Type 1 kit on an IP20/UL Open Type drive to convert the drive to an IP20/UL Type 1.



## 10.5 Drive Watt Loss

### ◆ 208 V Class

Table 10.11 Drive Watt Loss (NEMA Rating) for Models: 2xxxxB/F/V without Main Switch

Model	Rated Output Current A	Carrier Frequency kHz	Interior Unit Loss W	Cooling Fin Loss W	Total Loss W
2011	10.6	5.0	45	86	131
2017	16.7	5.0	56	140	196
2024	24.2	5.0	75	184	259
2031	30.8	5.0	89	244	333
2046	46.2	5.0	116	314	430
2059	59.4	5.0	148	418	566
2075	74.8	5.0	175	538	713
2088	88	5.0	201	615	816
2114	114	5.0	246	780	1026
2143	143	5.0	244	937	1180
2169	169	5.0	279	1132	1411
2211	211	5.0	331	1321	1651
2273	273	5.0	423	1821	2244

Table 10.12 Drive Watt Loss (NEMA Rating) for Models: 2xxxxT with Main Switch

Model	Rated Output Current A	Carrier Frequency kHz	Interior Unit Loss W	Cooling Fin Loss W	Total Loss W
2011	10.6	5.0	45	86	131
2017	16.7	5.0	57	140	196
2024	24.2	5.0	76	184	260
2031	30.8	5.0	91	244	335
2046	46.2	5.0	118	314	432
2059	59.4	5.0	151	418	569
2075	74.8	5.0	177	538	715
2088	88	5.0	203	615	818
2114	114	5.0	251	780	1031

### ◆ 480 V Class

Table 10.13 Drive Watt Loss (NEMA Rating) for Models: 4xxxxB/F/V without Main Switch

Model	Rated Output Current A	Carrier Frequency kHz	Interior Unit Loss W	Cooling Fin Loss W	Total Loss W
4005	4.8	5.0	31	44	75
4008xF */	7.6	5.0	38	70	108
4008xV */	7.6	5.0	46	99	145
4011	11	5.0	56	142	198
4014	14	5.0	66	196	262
4021	21	5.0	89	212	301
4027	27	5.0	112	285	397
4034	34	5.0	128	327	455

## 10.5 Drive Watt Loss

Model	Rated Output Current A	Carrier Frequency kHz	Interior Unit Loss W	Cooling Fin Loss W	Total Loss W
4040	40	5.0	145	373	518
4052	52	5.0	178	470	648
4065	65	5.0	224	600	824
4077	77	5.0	271	819	1090
4096	96	5.0	323	973	1295
4124	124	5.0	423	1294	1717
4156	156	5.0	332	1448	1780
4180	180	5.0	395	1707	2102
4240	240	4.0	406	1810	2216
4302	302	4.0	866	2847	3712

\*1 The watt loss values are different for different drive protection designs.

**Table 10.14 Drive Watt Loss (NEMA Rating) for Models: 4xxxT with Main Switch**

Model	Rated Output Current A	Carrier Frequency kHz	Interior Unit Loss W	Cooling Fin Loss W	Total Loss W
4005	4.8	5.0	31	44	75
4008	7.6	5.0	46	99	145
4011	11	5.0	56	142	198
4014	14	5.0	67	196	263
4021	21	5.0	90	212	301
4027	27	5.0	113	285	398
4034	34	5.0	130	327	457
4040	40	5.0	146	373	519
4052	52	5.0	181	470	651
4065	65	5.0	228	600	827
4077	77	5.0	273	819	1093
4096	96	5.0	326	973	1298

## 10.6 Drive Derating

You must derate the drive capacity to operate the drive above the rated temperature, altitude, and default carrier frequency.

### ◆ Carrier Frequency Settings and Rated Current Values

Table 10.15 and Table 10.16 show how the drive rated output current changes when the *C6-02 [Carrier Frequency Selection]* value changes. The output current value changes linearly as the carrier frequency changes. You can use the values from the tables to calculate a frequency that is not shown.

#### Note:

The drive will apply derating for the rated output current value based on the carrier frequency only to the reference output current value of the *oL2 [Drive Overload]*. The derated value for the 100% rated output current in parameters and monitors will not be the same as the rated output current value shown in *Model Specifications (208 V Class) on page 421* and *Model Specifications (480 V Class) on page 422*.

### ■ 208 V Class

Table 10.15 Carrier Frequency and Rated Current Derating

Model	Rated Current (A)				
	2 kHz	5 kHz	8 kHz	10 kHz	12.5 kHz
2011	10.6	10.6	8.9	7.7	6.3
2017	16.7	16.7	14.0	12.2	10.0
2024	24.2	24.2	20.3	17.7	14.5
2031	30.8	30.8	25.8	22.6	18.5
2046	46.2	46.2	38.8	33.9	27.7
2059	59.4	59.4	49.9	43.5	35.6
2075	74.8	74.8	62.8	54.9	44.9
2088	88.0	88.0	73.9	64.5	52.8
2114	114	114	95.8	83.6	68.4
2143	143	143	114.5	95.5	71.7
2169	169	169	135.3	112.8	84.7
2211	211	211	168.8	140.7	-
2273	273	273	218.4	182	-

### ■ 480 V Class

Table 10.16 Carrier Frequency and Rated Current Derating

Model	Rated Current (A)				
	2 kHz	5 kHz	8 kHz	10 kHz	12.5 kHz
4005	4.8	4.8	4.0	3.5	2.8
4008	7.6	7.6	6.3	5.5	4.5
4011	11.0	11.0	9.2	8.0	6.6
4014	14.0	14.0	11.7	10.2	8.4
4021	21.0	21.0	17.6	15.4	12.6
4027	27.0	27.0	22.6	19.8	16.2
4034	34.0	34.0	28.5	24.9	20.4
4040	40.0	40.0	33.6	29.3	24.0
4052	52.0	52.0	43.7	38.1	31.2
4065	65.0	65.0	54.6	47.7	39.0

## 10.6 Drive Derating

Model	Rated Current (A)				
	2 kHz	5 kHz	8 kHz	10 kHz	12.5 kHz
4077	77.0	77.0	64.7	56.5	46.2
4096	96.0	96.0	80.6	70.4	57.6
4124	124	124	99.3	82.8	62.2
4156	156	156	124.9	104.2	78.2
4180	180	180	144	120	-
4240	240	224	176	144	-
4302	302	281.9	221.5	181.2	-

### ◆ Derating Depending on Ambient Temperature

When you install drives in a place where ambient temperatures are higher than the rated conditions or install drives side-by-side in the enclosure panel, set *L8-12 [Ambient Temperature]* and *L8-35 [Installation Method Selection]*. Derate the output current as specified in [Figure 10.1](#) to [Figure 10.4](#).

No. (Hex.)	Name	Description	Default (Range)
L8-12 (04B8)	Ambient Temperature Setting	<input type="checkbox"/> V/f <input type="checkbox"/> OLV/IPM <input type="checkbox"/> EZOLV Sets the ambient temperature of the drive installation area.	40 °C (Determined by L8-35)

No. (Hex.)	Name	Description	Default (Range)
L8-35 (04EC)	Installation Method Selection	<input type="checkbox"/> V/f <input type="checkbox"/> OLV/IPM <input type="checkbox"/> EZOLV Sets the type of drive installation.	Determined by the drive (0 - 3)

#### Note:

The drive will detect an *oPE02 [Parameter Range Setting Error]* in these conditions:

- If you set *L8-12 = 60 °C* and *L8-35 = 1 or 3* for models 2011 to 2114 and 4005 to 4124
- If you set *L8-35 = 1 or 3* for models 2143 to 2273 and 4156 to 4302

### 0 : IP20/UL Open Type

Use this setting to install an IP20/UL Open Type drive. The applicable output current to operate the drive changes when the ambient temperature changes:

- -10 °C to +50 °C (14 °F to 122 °F): You can operate the drive with 100% output current without derating.
- 50 °C to 60 °C (122 °F to 140 °F): Derate the output current from 100% to 80%.

Make sure that there is 60 mm (2.4 in) minimum of space between drives or between the drive and side of the enclosure panel.

### 1 : Side-by-Side Mounting

Use this setting to install more than one drive Side-by-Side. The applicable output current to operate the drive changes when the ambient temperature changes:

- -10 °C to +40 °C (14 °F to 104 °F): You can operate the drive with 100% output current without derating.
- 40 °C to 50 °C (104 °F to 122 °F): Derate the output current from 100% to 80%.

Make sure that there is 2 mm (0.08 in) minimum of space between drives.

### 2 : IP20/UL Type 1

Use this setting to install an IP20/UL Type 1 drive. The applicable output current to operate the drive changes when the drive model and ambient temperature change:

- For the drive models 4005 and 4008
  - -10 °C to +40 °C (14 °F to 104 °F): You can operate the drive with 100% output current without derating.
  - 40 °C to 60 °C (104 °F to 140 °F): Derate the output current from 100% to 80%.
- For the drive models 4011 to 4027

- -10 °C to +50 °C (14 °F to 122 °F): You can operate the drive with 100% output current without derating.
- 50 °C to 60 °C (122 °F to 140 °F): Derate the output current from 100% to 80%.
- For the drive models 4034 to 4065
  - -10 °C to +45 °C (14 °F to 113 °F): You can operate the drive with 100% output current without derating.
  - 45 °C to 50 °C (113 °F to 122 °F): Derate the output current from 100% to 90%.
  - 50 °C to 60 °C (122 °F to 140 °F): Derate the output current from 90% to 70%.
- For the drive models 2011 to 2273 and 4077 to 4302
  - -10 °C to +40 °C (14 °F to 104 °F): You can operate the drive with 100% output current without derating.
  - 40 °C to 60 °C (104 °F to 140 °F): Derate the output current from 100% to 60%.

### 3 : IP55/UL Type 12

Use this setting to install an IP55/UL Type 12 drive. The applicable output current to operate the drive changes when the ambient temperature changes:

- -10 °C to +40 °C (14 °F to 104 °F): You can operate the drive with 100% output current without derating.
- 40 °C to 50 °C (104 °F to 122 °F): Derate the output current from 100% to 80%.

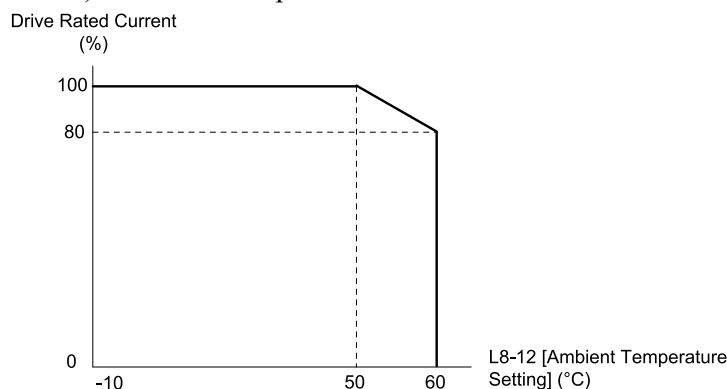

**Figure 10.1 Derating for IP20/UL Open Type (L8-35 = 0)**

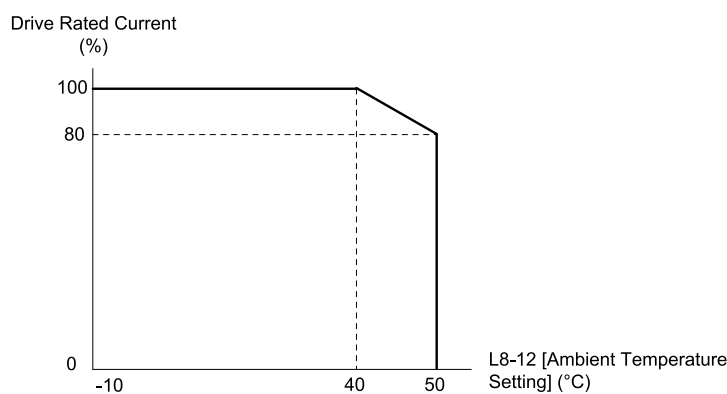

**Figure 10.2 Derating for Side-by-Side Mounting (L8-35 = 1)**

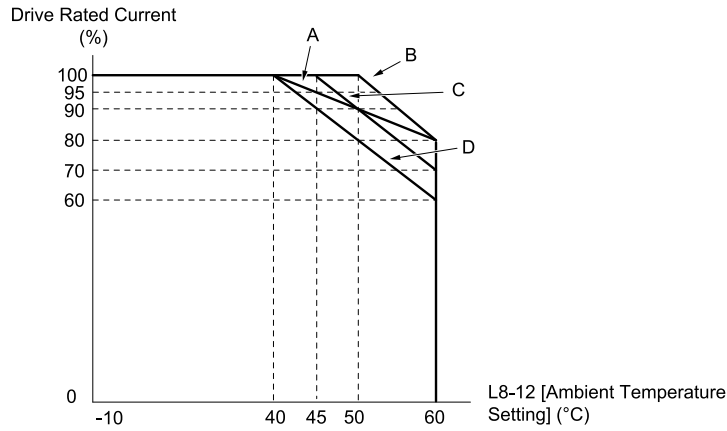

**A - Drive Models: 4005, 4008**  
**B - Drive Models: 4011 to 4027**

**C - Drive Models: 4034 to 4065**  
**D - Drive Models: 2011 to 2273 and 4077 to 4302**

**Figure 10.3 Derating for IP20/UL Type 1 (L8-35 = 2)**

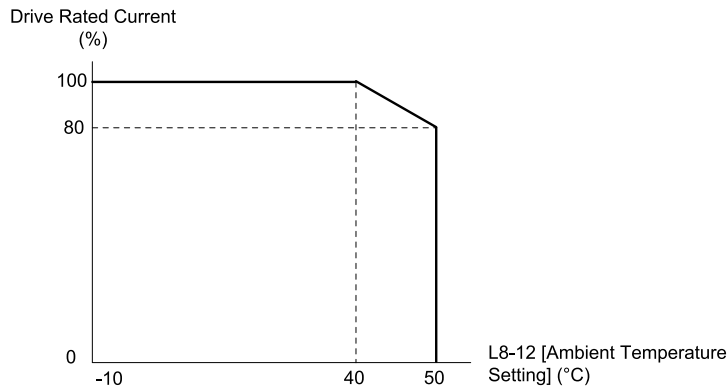

**Figure 10.4 Derating for IP55/UL Type 12 (L8-35 = 3)**

### ◆ Altitude Derating

Install the drive in a location that has an altitude of 1000 m (3281 ft) or lower.

Derate the output current by 1% for each 100 m (328 ft) to install the drive in altitudes between 1000 to 4000 m (3281 to 13123 ft).

It is not necessary to derate the rated voltage in these conditions:

- Installing the drive at 2000 m (6562 ft) or lower
- Installing the drive between 2000 to 4000 m (6562 to 13123 ft) and grounding the neutral point on the power supply.

If you do not ground the drive with a neutral network, contact Yaskawa or your nearest sales representative.

## 10.7 Drive Exterior and Mounting Dimensions

### ◆ Drive Models and Exterior/Mounting Dimensions

Table 10.17 Models: 2xxxxB/F and 4xxxxB/F without Main Switch

Model	Reference Page	
	IP20/UL Open Type Models: 2xxxxB and 4xxxxB	IP20/UL Type 1 Models: 2xxxxF and 4xxxxF
4005, 4008	-	436
2011, 2017 4011, 4014	-	437
2024, 2031 4021 - 4034	-	437
2046, 2059 4040 - 4065	-	438
2075 - 2114 4077 - 4124	-	439
2143, 2169 4156	-	440
2211, 2273 4180, 4240	434	-
4302	435	-

Table 10.18 Models: 2xxxxV and 4xxxxV without Main Switch

Model	Reference Page
	IP55/UL Type 12 Models: 2xxxxV and 4xxxxV
4005	441
2011, 2017 4008 - 4014	442
2024, 2031 4021 - 4034	443
2046, 2059 4040 - 4065	444
2075 - 2114 4077 - 4124	445
2143, 2169 4156	-
2211, 2273 4180, 4240	-
4302	-

Table 10.19 Models: 2xxxxT and 4xxxxT with Main Switch

Model	Reference Page
	IP55/UL Type 12 with Main Switch Models: 2xxxxT and 4xxxxT
4005	446
2011, 2017 4008 - 4014	447
2024, 2031 4021 - 4034	448

## 10.7 Drive Exterior and Mounting Dimensions

Model	Reference Page
	IP55/UL Type 12 with Main Switch Models: 2xxxxT and 4xxxxT
2046, 2059 4040 - 4065	449
2075 - 2114 4077 - 4096	450

### ◆ IP20/UL Open Type

#### ■ Drive Models: 2211, 2273, 4180, 4240

**Note:**

When you use non-metric hardware to install the drive, use Type B narrow washers or equivalent and make sure that the size of the screw head and washer are applicable for your drive before installation.

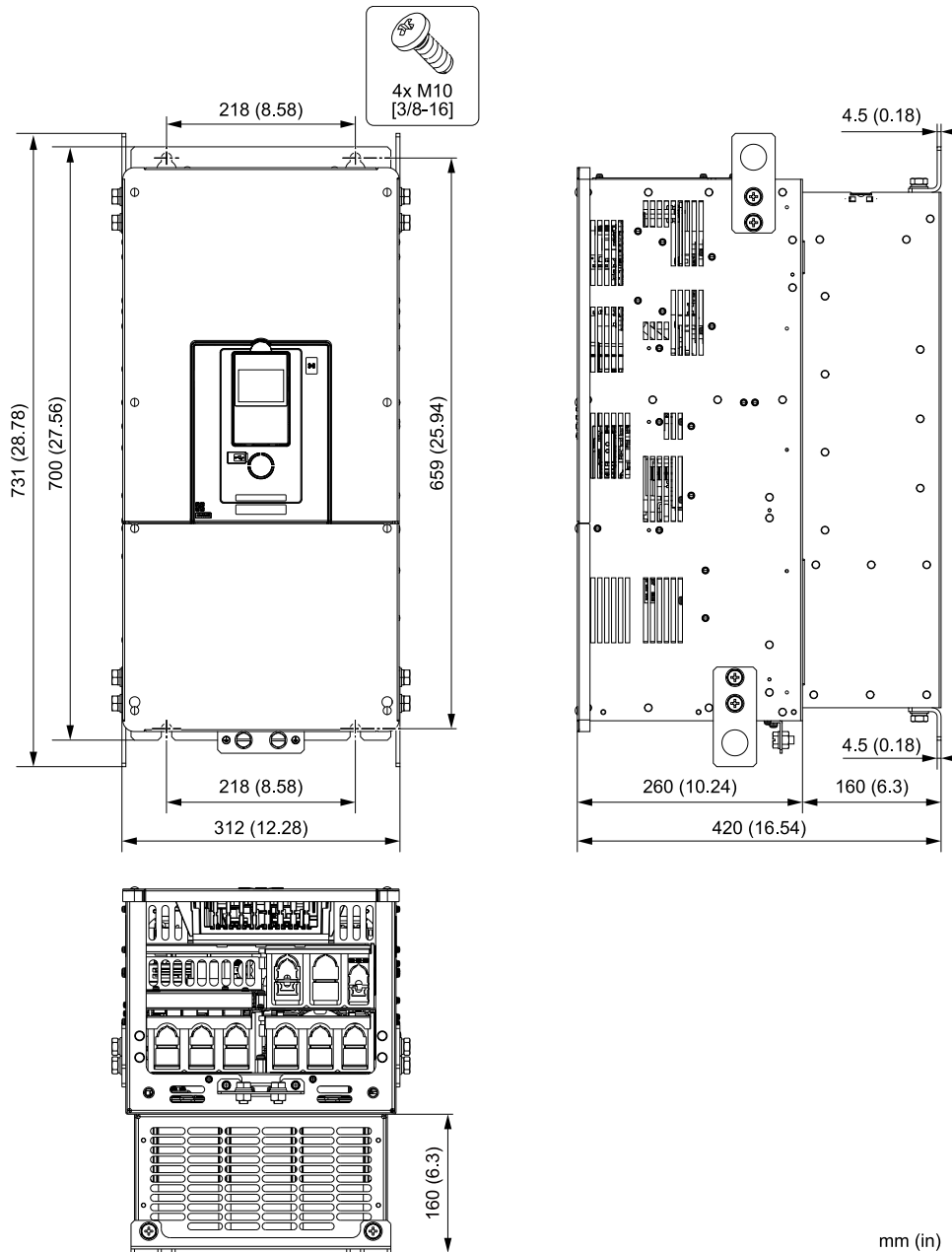

Figure 10.5 Exterior and Mounting Dimensions Diagram 1



Estimated Weight kg (lb)			
2211	2273	4180	4240
78 (172.0)	82 (180.8)	79 (174.2)	82 (180.8)

■ Drive Models: 4302

**Note:**

When you use non-metric hardware to install the drive, use Type B narrow washers or equivalent and make sure that the size of the screw head and washer are applicable for your drive before installation.

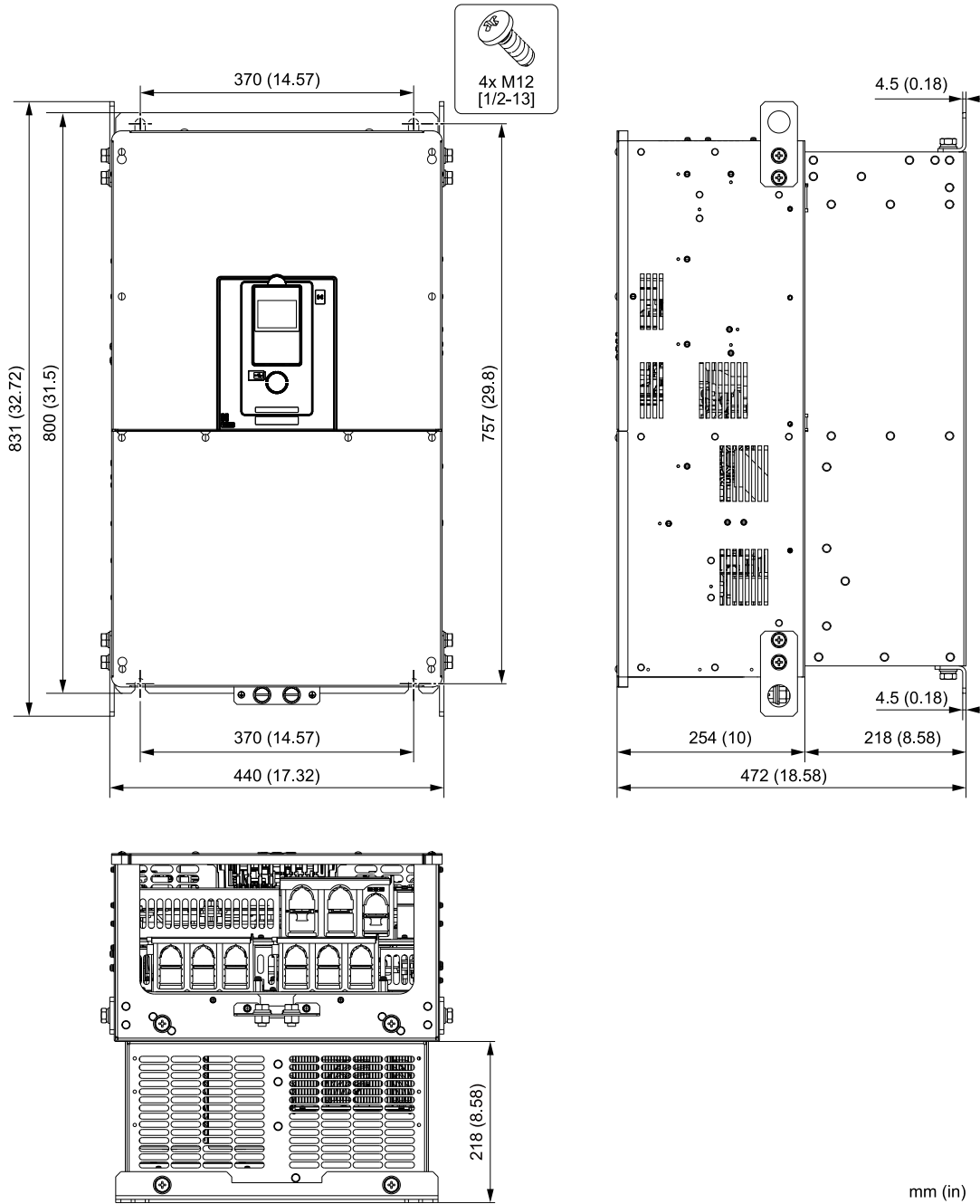

Figure 10.6 Exterior and Mounting Dimensions Diagram 2

## 10.7 Drive Exterior and Mounting Dimensions

Estimated Weight kg (lb)	
4302	
125 (275.6)	

### ◆ IP20/UL Type1

#### ■ Drive Models: 4005, 4008

**Note:**

When you use non-metric hardware to install the drive, use Type B narrow washers or equivalent and make sure that the size of the screw head and washer are applicable for your drive before installation.

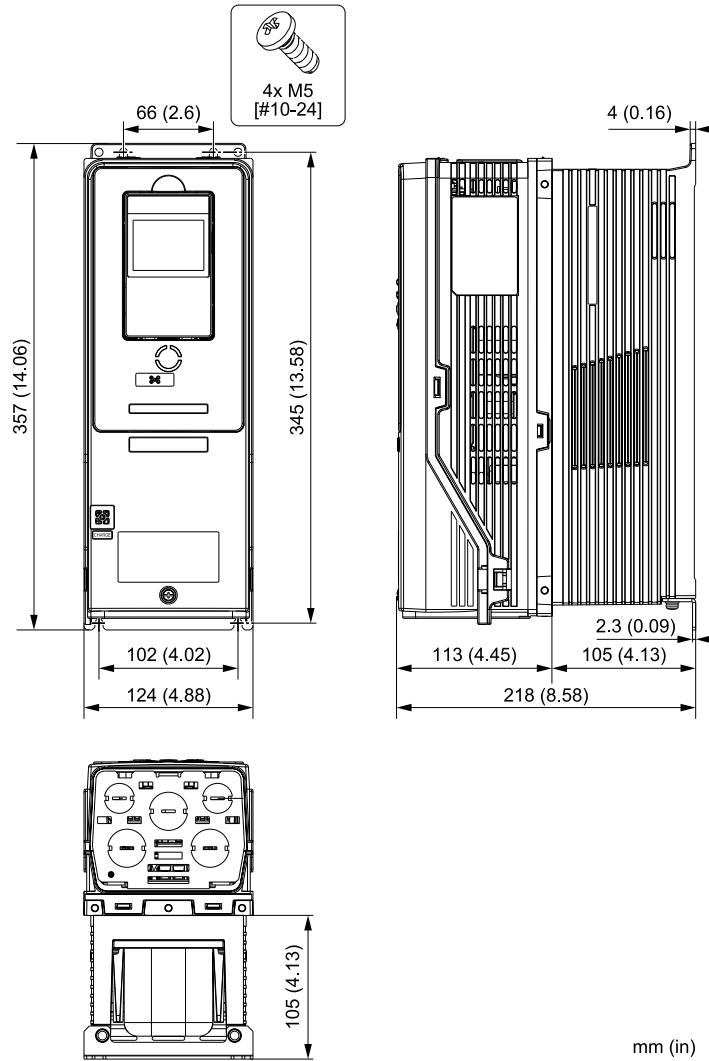

**Figure 10.7 Exterior and Mounting Dimensions Diagram 1**

Estimated Weight kg (lb)	
4005	4008
7.0 (15.4)	7.5 (16.5)

■ Drive Models: 2011, 2017, 4011, 4014

**Note:**

When you use non-metric hardware to install the drive, use Type B narrow washers or equivalent and make sure that the size of the screw head and washer are applicable for your drive before installation.

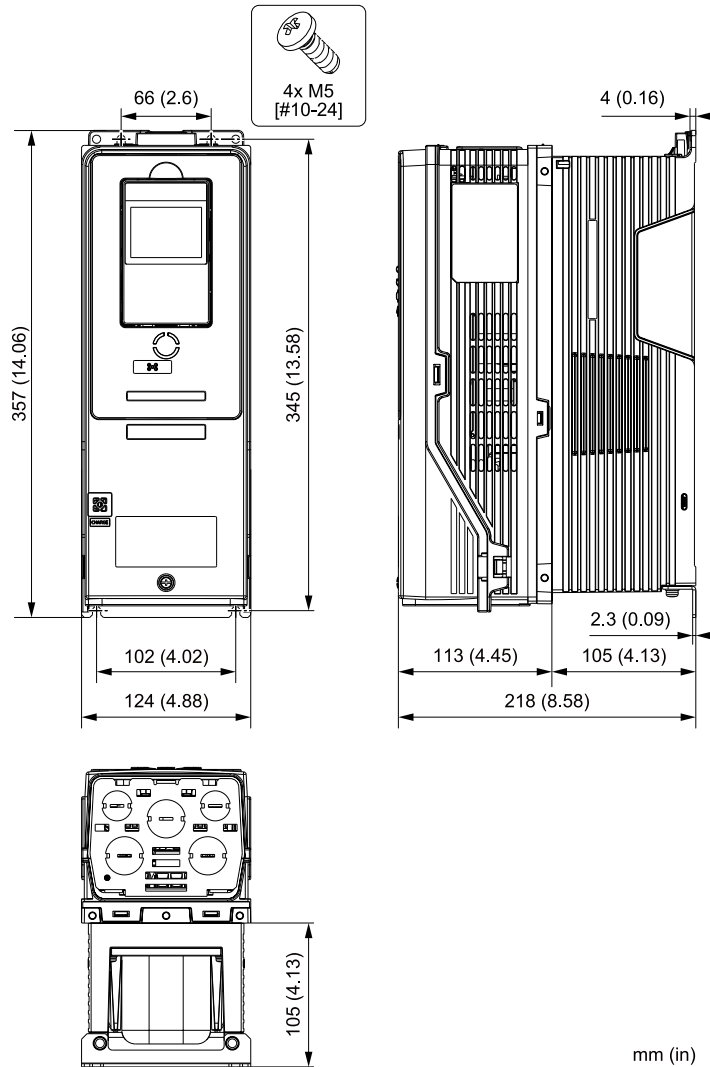

Figure 10.8 Exterior and Mounting Dimensions Diagram 2

Estimated Weight kg (lb)			
2011	2017	4011	4014
6.5 (14.3)	6.5 (14.3)	7.0 (15.4)	7.0 (15.4)

■ Drive Models: 2024, 2031, 4021 to 4034

**Note:**

When you use non-metric hardware to install the drive, use Type B narrow washers or equivalent and make sure that the size of the screw head and washer are applicable for your drive before installation.

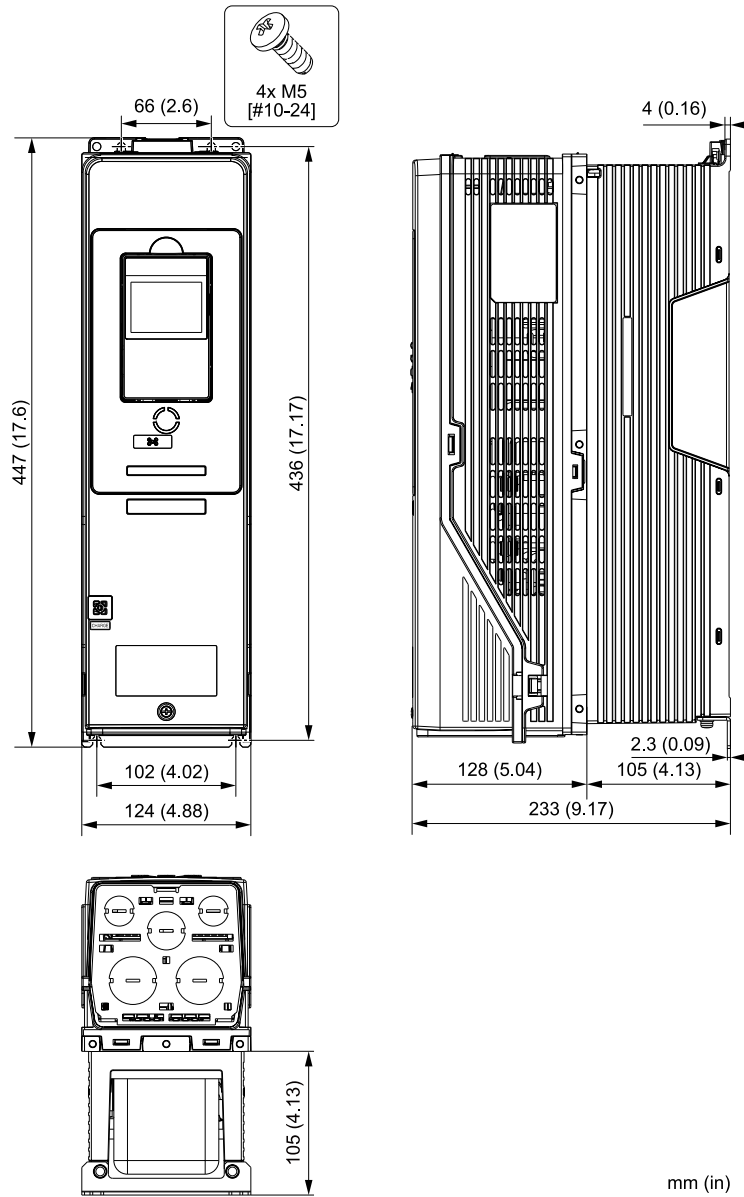

Figure 10.9 Exterior and Mounting Dimensions Diagram 3

Estimated Weight kg (lb)				
2024	2031	4021	4027	4034
8.5 (18.7)	9.0 (19.8)	9.0 (19.8)	10 (22.0)	11 (24.3)

■ Drive Models: 2046, 2059, 4040 to 4065

Note:

When you use non-metric hardware to install the drive, use Type B narrow washers or equivalent and make sure that the size of the screw head and washer are applicable for your drive before installation.

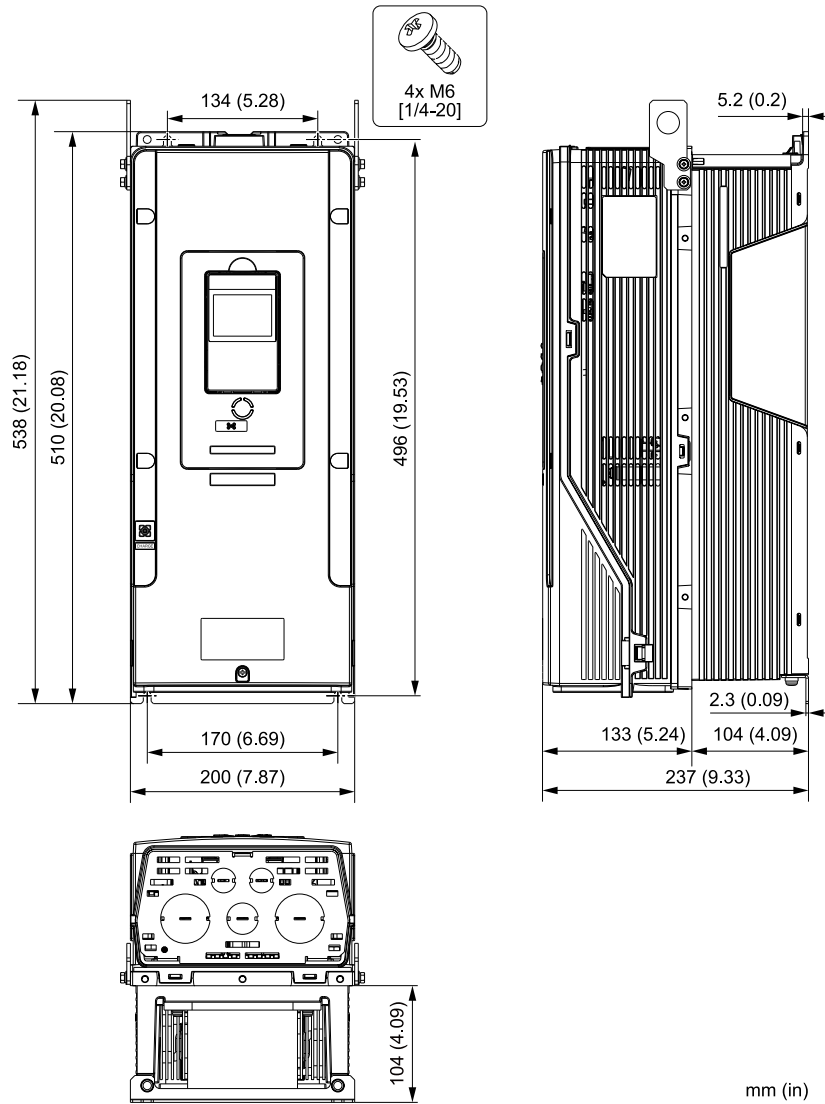

Figure 10.10 Exterior and Mounting Dimensions Diagram 4

Estimated Weight kg (lb)				
2046	2059	4040	4052	4065
15 (33.1)	16 (35.3)	16 (35.3)	18 (39.7)	20 (44.1)

■ Drive Models: 2075 to 2114, 4077 to 4124

**Note:**

When you use non-metric hardware to install the drive, use Type B narrow washers or equivalent and make sure that the size of the screw head and washer are applicable for your drive before installation.

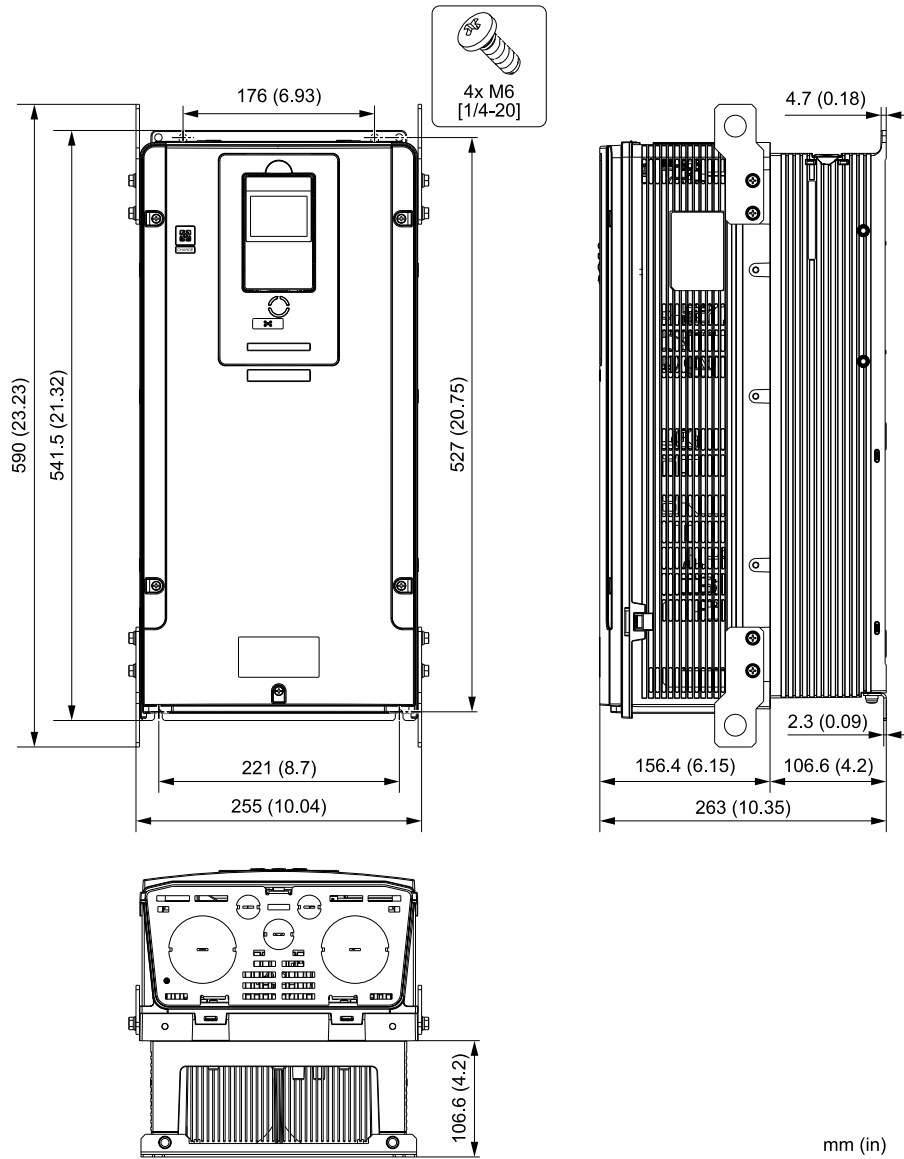

Figure 10.11 Exterior and Mounting Dimensions Diagram 5

Estimated Weight kg (lb)					
2075	2088	2114	4077	4096	4124
25 (55.1)	25 (55.1)	28 (61.7)	28 (61.7)	30 (66.1)	33 (72.8)

■ Drive Models: 2143, 2169, 4156

Note:

When you use non-metric hardware to install the drive, use Type B narrow washers or equivalent and make sure that the size of the screw head and washer are applicable for your drive before installation.

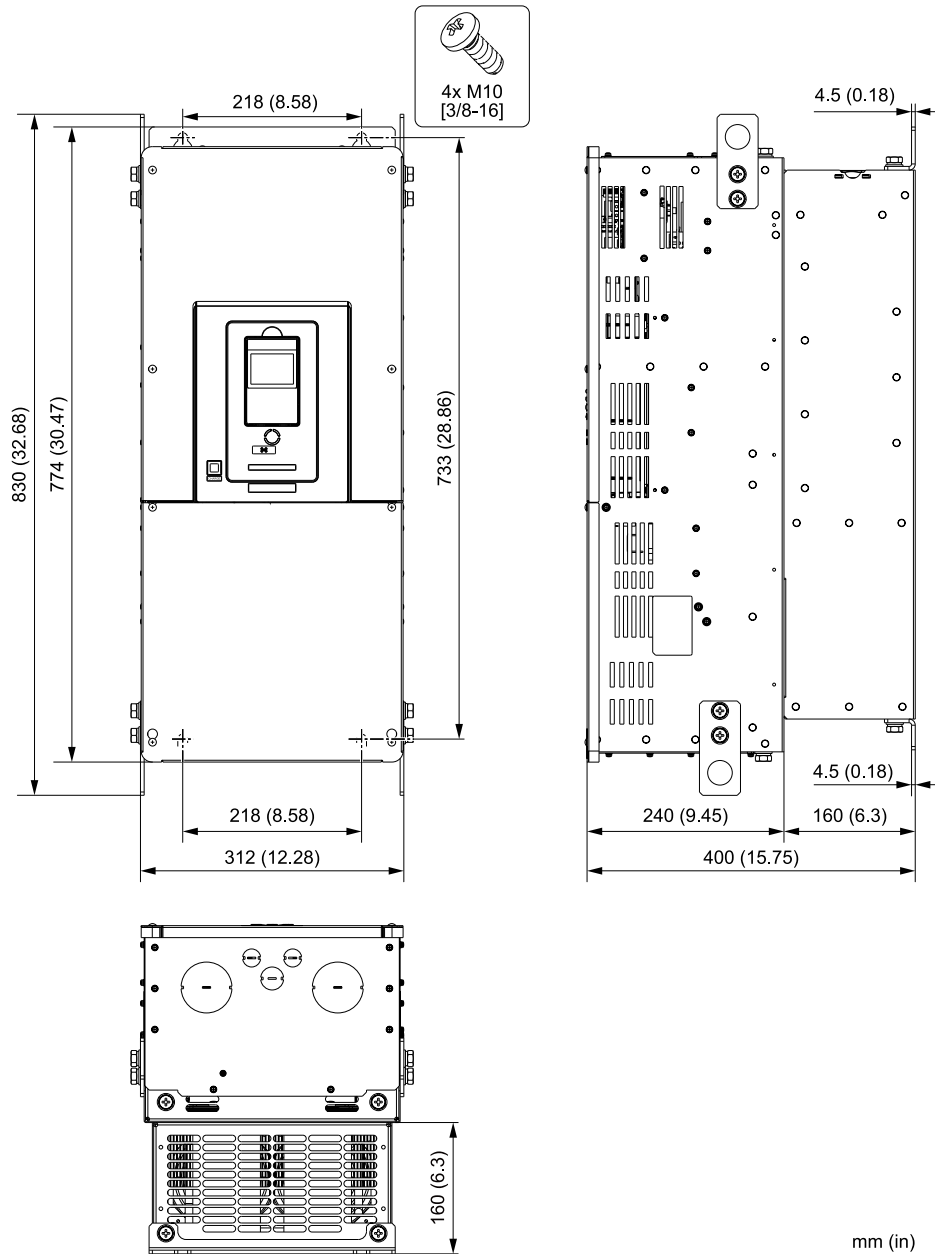

Figure 10.12 Exterior and Mounting Dimensions Diagram 6

Estimated Weight kg (lb)		
2143	2169	4156
74 (163.1)	76 (167.6)	78 (172.0)

◆ IP55/UL Type 12

■ Drive Model: 4005

Note:

When you use non-metric hardware to install the drive, use Type B narrow washers or equivalent and make sure that the size of the screw head and washer are applicable for your drive before installation.

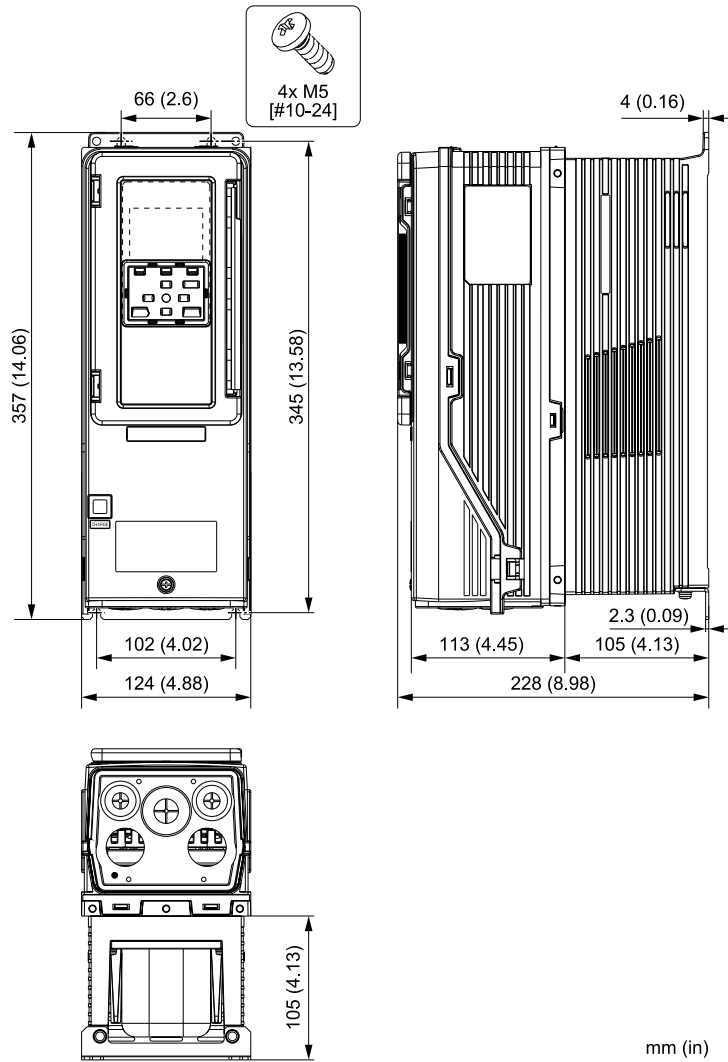

Figure 10.13 Exterior and Mounting Dimensions Diagram 1

Estimated Weight	
kg (lb)	
<b>4005</b>	
7.0 (15.4)	

■ Drive Models: 2011, 2017, 4008 to 4014

**Note:**

When you use non-metric hardware to install the drive, use Type B narrow washers or equivalent and make sure that the size of the screw head and washer are applicable for your drive before installation.



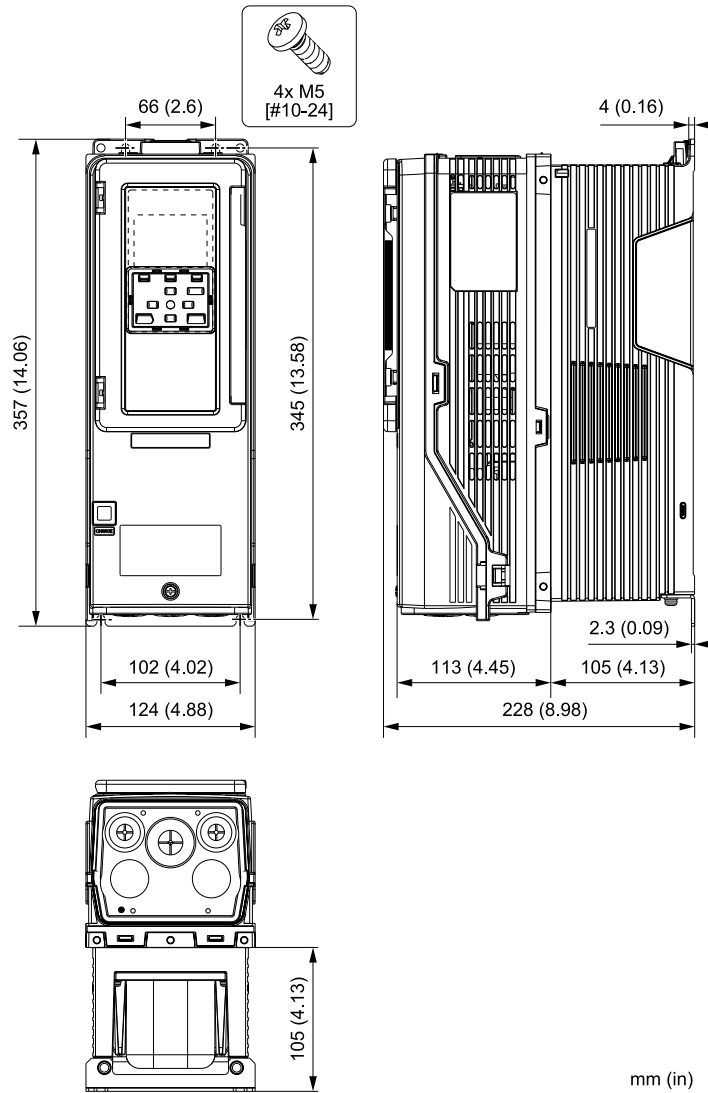

Figure 10.14 Exterior and Mounting Dimensions Diagram 2

Estimated Weight kg (lb)				
2011	2017	4008	4011	4014
6.5 (14.3)	6.5 (14.3)	7.0 (15.4)	7.0 (15.4)	7.0 (15.4)

■ Drive Models: 2024, 2031, 4021 to 4034

Note:

When you use non-metric hardware to install the drive, use Type B narrow washers or equivalent and make sure that the size of the screw head and washer are applicable for your drive before installation.

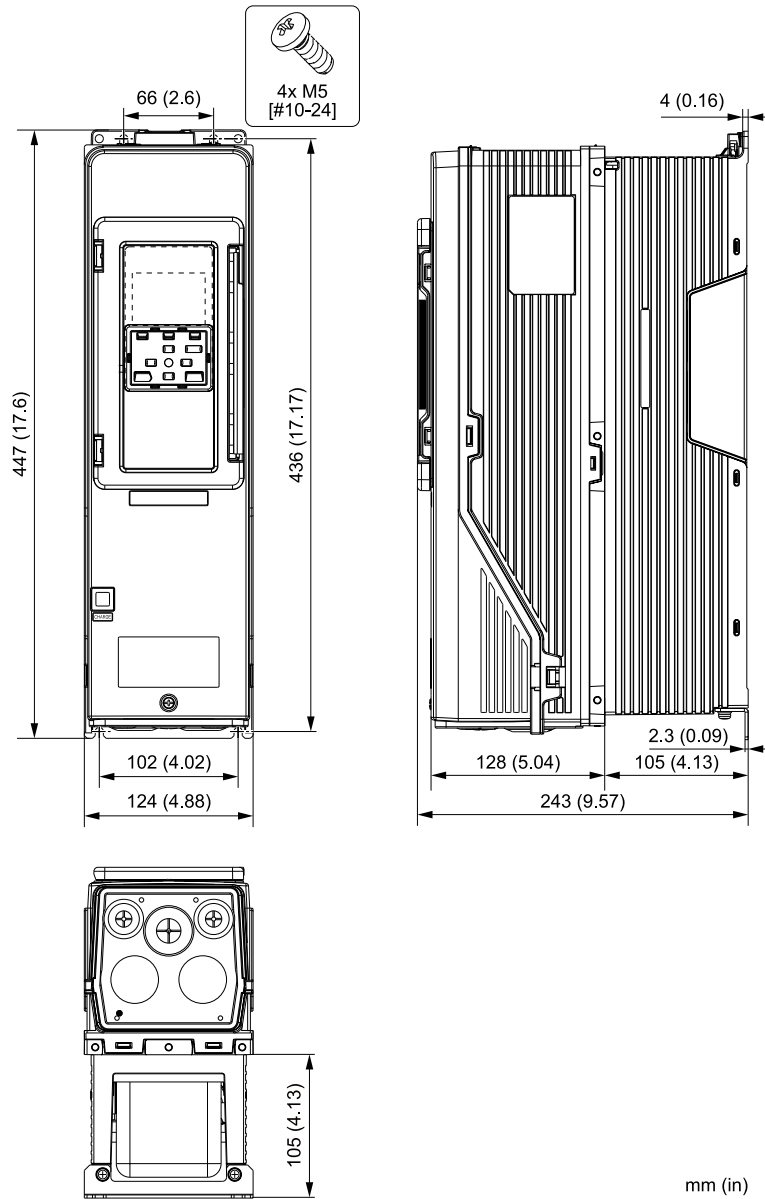

Figure 10.15 Exterior and Mounting Dimensions Diagram 3

Estimated Weight kg (lb)				
2024	2031	4021	4027	4034
8.5 (18.7)	9.0 (19.8)	9.0 (19.8)	10 (22.0)	11 (24.3)

■ Drive Models: 2046, 2059, 4040 to 4065

**Note:**

When you use non-metric hardware to install the drive, use Type B narrow washers or equivalent and make sure that the size of the screw head and washer are applicable for your drive before installation.

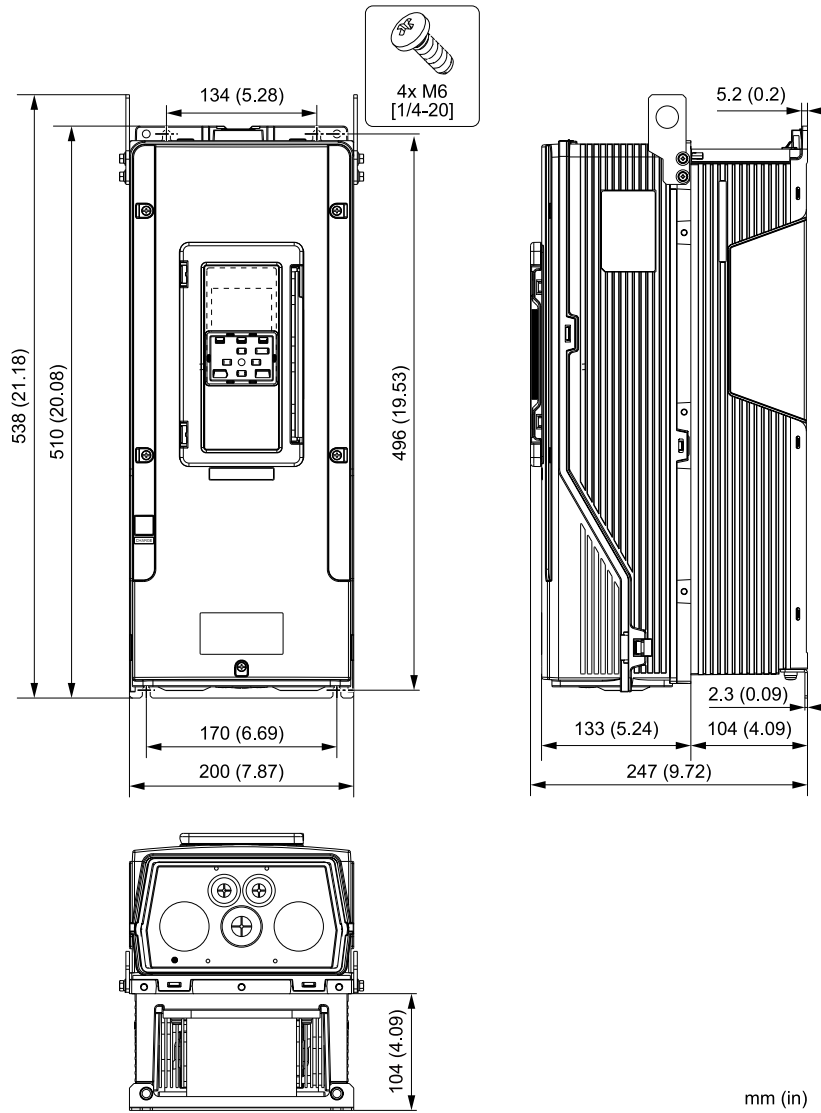

Figure 10.16 Exterior and Mounting Dimensions Diagram 4

Estimated Weight kg (lb)				
2046	2059	4040	4052	4065
15 (33.1)	16 (35.3)	16 (35.3)	18 (39.7)	20 (44.1)

■ Drive Models: 2075 to 2114, 4077 to 4124

**Note:**

When you use non-metric hardware to install the drive, use Type B narrow washers or equivalent and make sure that the size of the screw head and washer are applicable for your drive before installation.

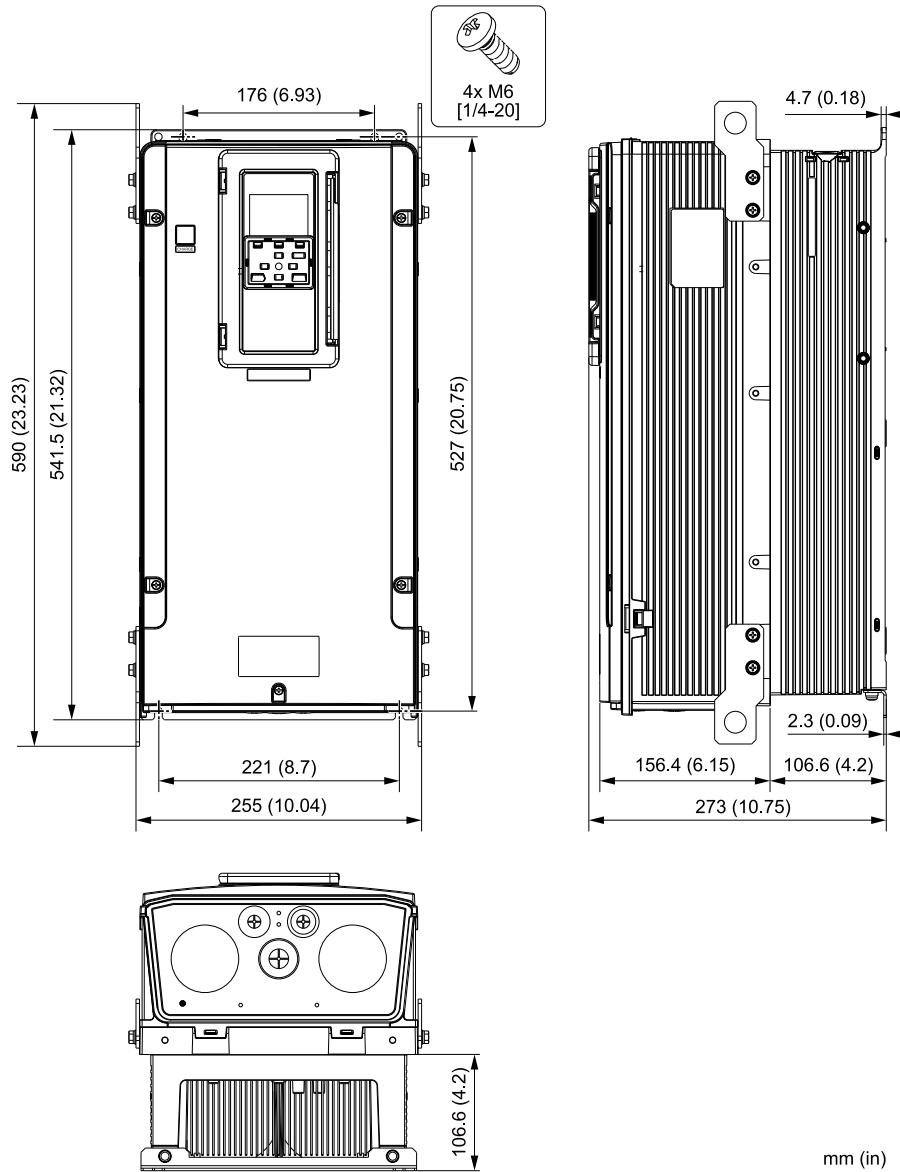

Figure 10.17 Exterior and Mounting Dimensions Diagram 5

Estimated Weight kg (lb)					
2075	2088	2114	4077	4096	4124
25 (55.1)	25 (55.1)	28 (61.7)	28 (61.7)	30 (66.1)	33 (72.8)

◆ IP55/UL Type 12 with Main Switch

■ Drive Model: 4005

Note:

When you use non-metric hardware to install the drive, use Type B narrow washers or equivalent and make sure that the size of the screw head and washer are applicable for your drive before installation.

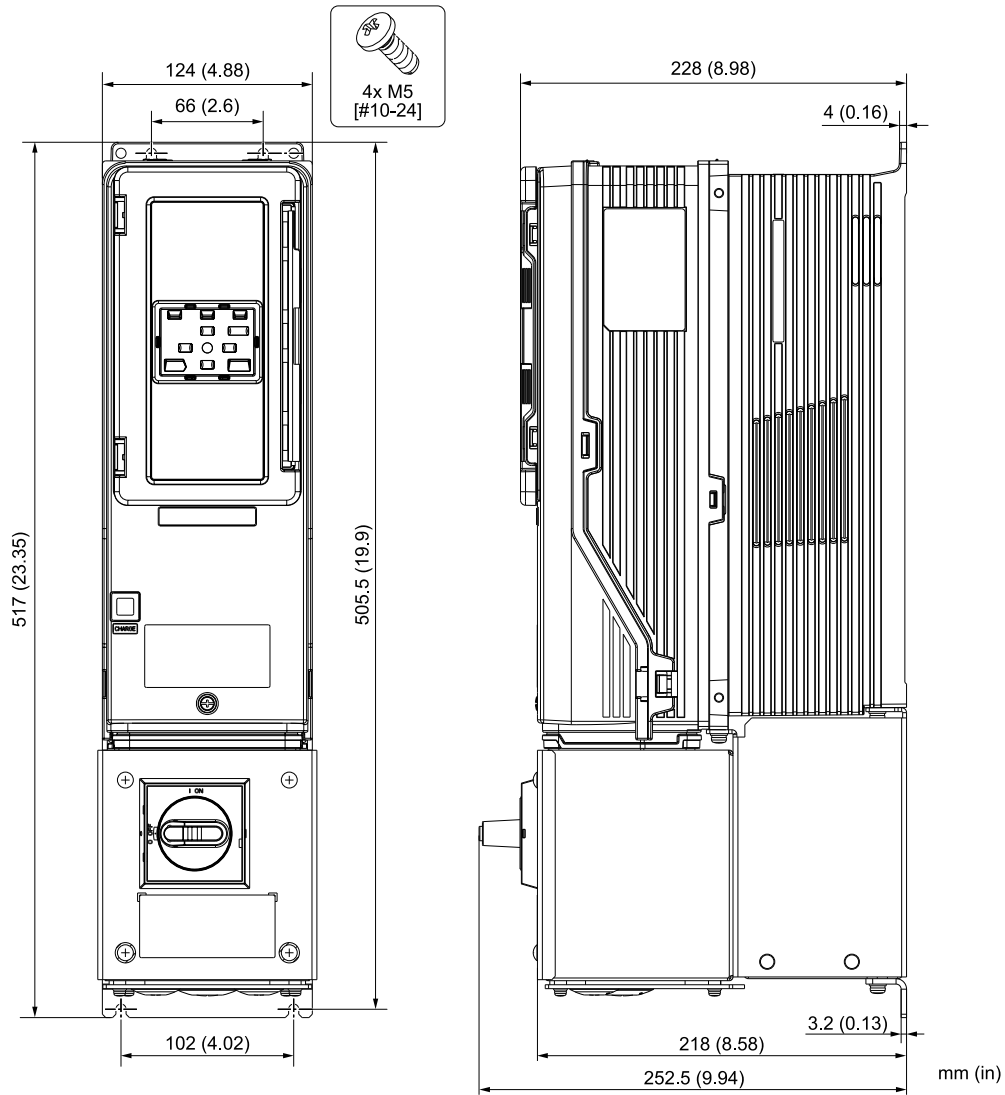

Figure 10.18 Exterior and Mounting Dimensions Diagram 1

Estimated Weight kg (lb)
4005
10 (22.0)

■ Drive Models: 2011, 2017, 4008 to 4014

Note:

When you use non-metric hardware to install the drive, use Type B narrow washers or equivalent and make sure that the size of the screw head and washer are applicable for your drive before installation.

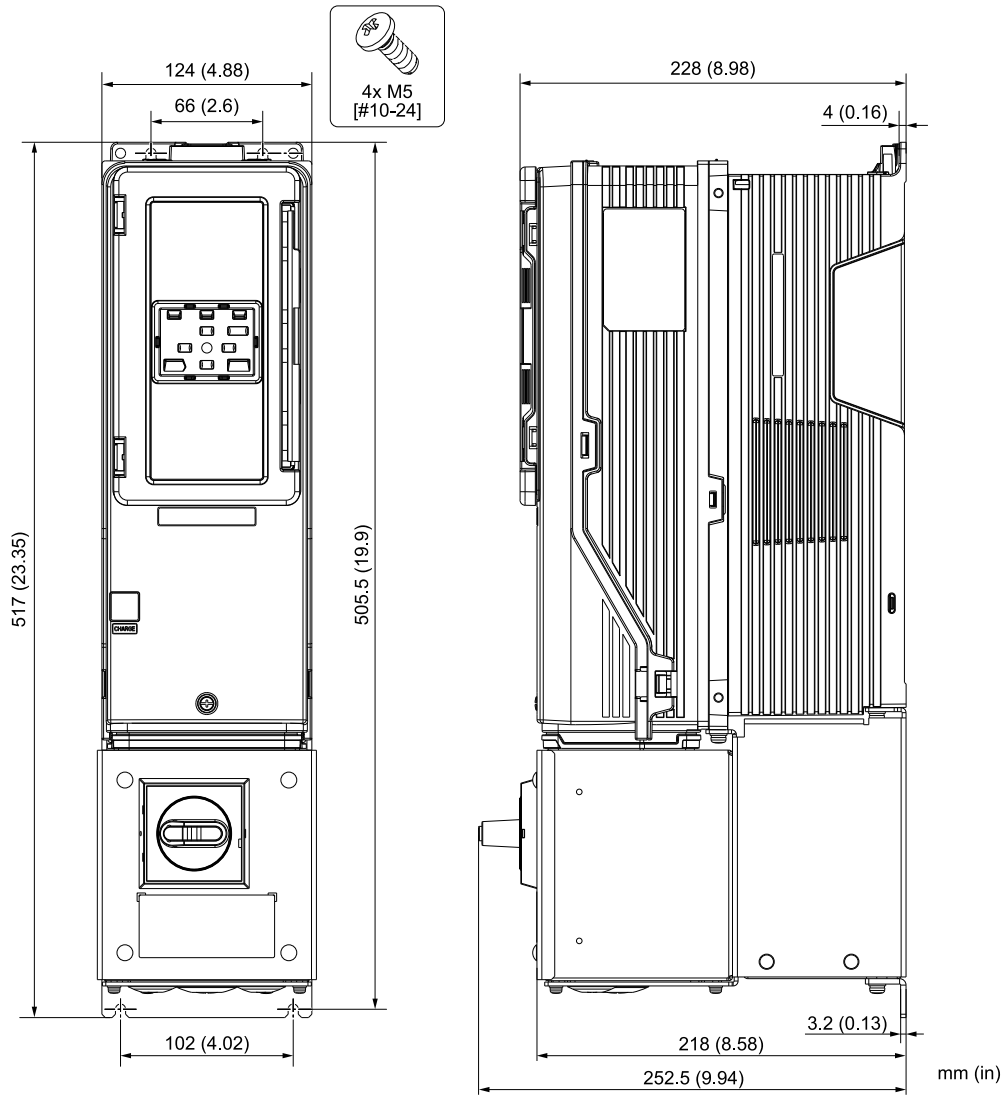

Figure 10.19 Exterior and Mounting Dimensions Diagram 2

Estimated Weight kg (lb)				
2011	2017	4008	4011	4014
9.5 (20.9)	9.5 (20.9)	10 (22.0)	10 (22.0)	10 (22.0)

■ Drive Models: 2024, 2031, 4021 to 4034

Note:

When you use non-metric hardware to install the drive, use Type B narrow washers or equivalent and make sure that the size of the screw head and washer are applicable for your drive before installation.

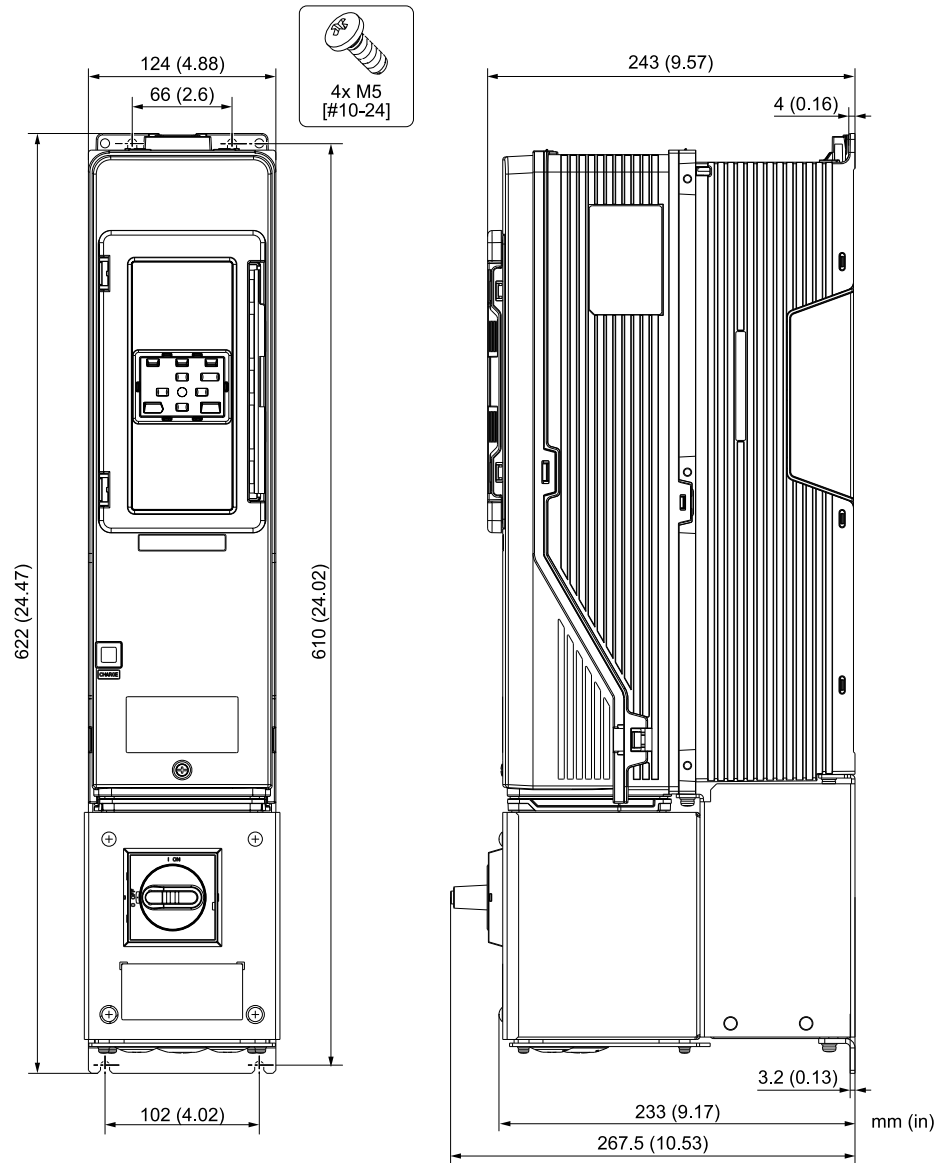

Figure 10.20 Exterior and Mounting Dimensions Diagram 3

Estimated Weight kg (lb)				
2024	2031	4021	4027	4034
12 (26.5)	13 (28.7)	13 (28.7)	14 (30.9)	14.5 (32)

■ Drive Models: 2046, 2059, 4040 to 4065

**Note:**

When you use non-metric hardware to install the drive, use Type B narrow washers or equivalent and make sure that the size of the screw head and washer are applicable for your drive before installation.

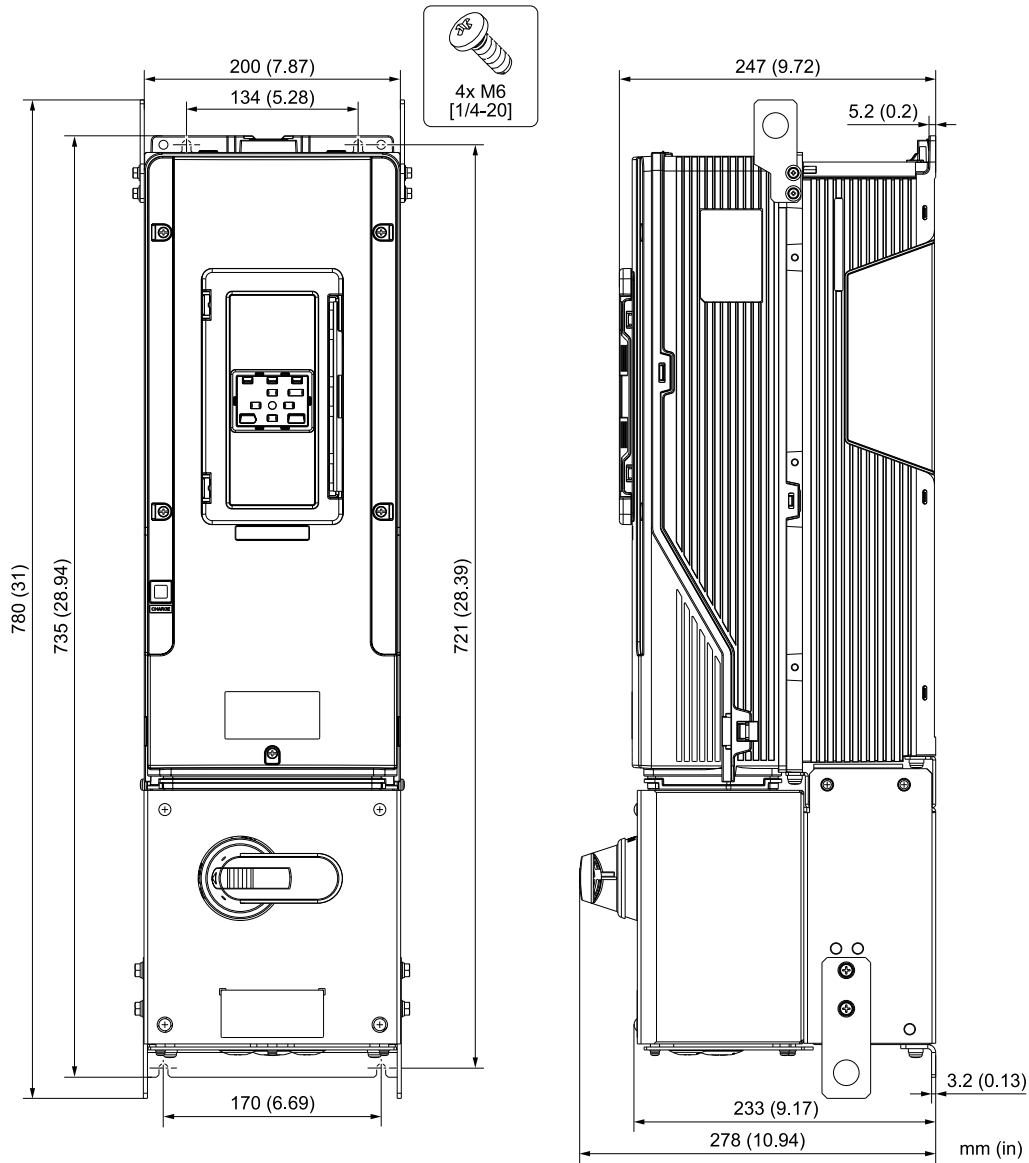

Figure 10.21 Exterior and Mounting Dimensions Diagram 4

Estimated Weight kg (lb)				
2046	2059	4040	4052	4065
22 (48.5)	23 (50.7)	23 (50.7)	25 (55.1)	27 (59.5)

■ Drive Models: 2075 to 2114, 4077 to 4096

Note:

When you use non-metric hardware to install the drive, use Type B narrow washers or equivalent and make sure that the size of the screw head and washer are applicable for your drive before installation.



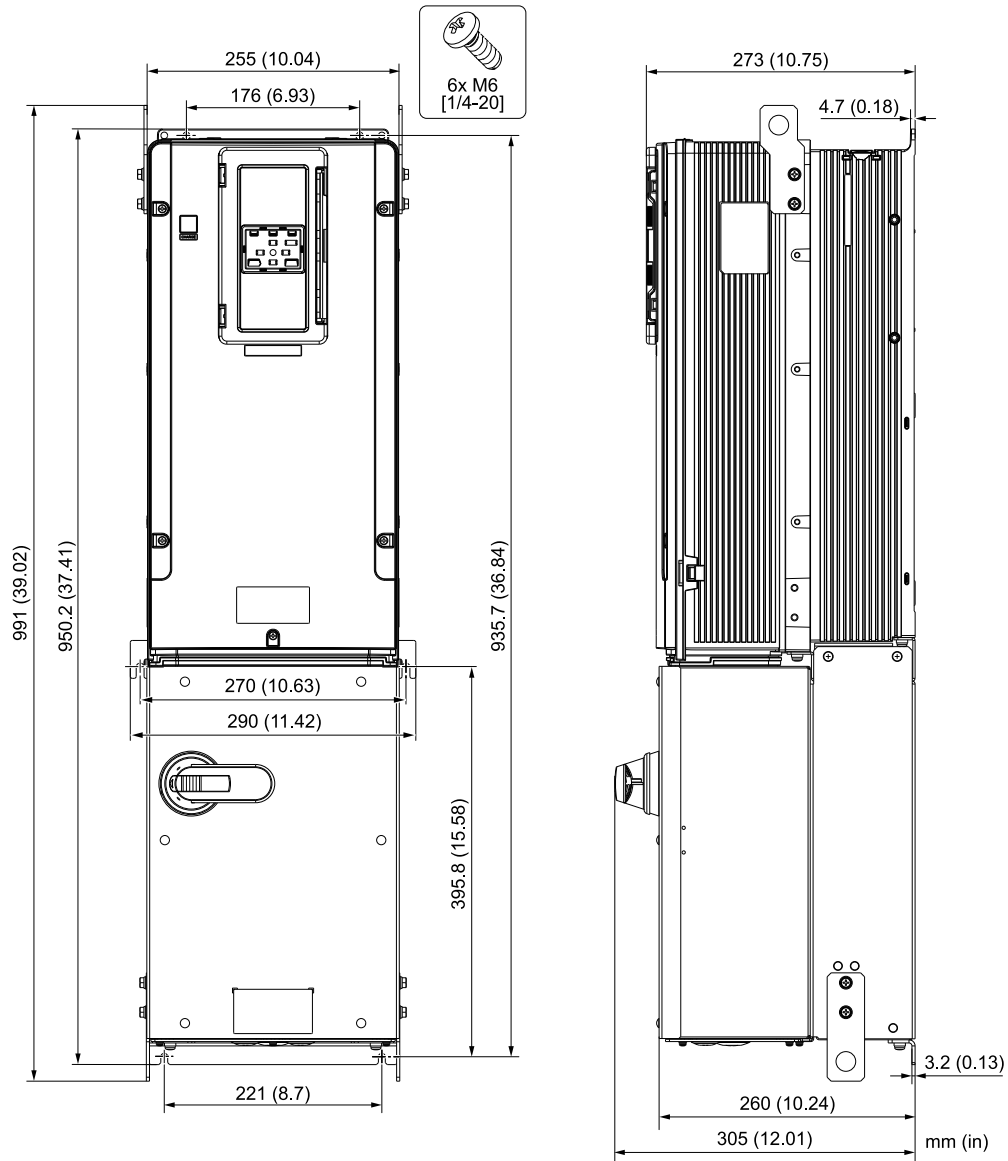

Figure 10.22 Exterior and Mounting Dimensions Diagram 5

Estimated Weight kg (lb)				
2075	2088	2114	4077	4096
41 (90.4)	41 (90.4)	44 (97.0)	44 (97.0)	46 (101.4)

## 10.8 Knock-Out Hole Dimensions

### ◆ Drive Models and Knock-Out Hole Dimensions

Table 10.20 Models: 2xxxxF and 4xxxxF without Main Switch

Model	Reference Pages
	IP20/UL Type 1 Models: 2xxxxF and 4xxxxF
4005, 4008	453
2011, 2017 4011, 4014	453
2024, 2031 4021 - 4034	454
2046, 2059 4040 - 4065	454
2075 - 2114 4077 - 4124	455
2143, 2169 4156	455
2211, 2273 4180, 4240	-
4302	-

Table 10.21 Models: 2xxxxV and 4xxxxV without Main Switch

Model	Reference Pages
	IP55/UL Type 12 Models: 2xxxxV and 4xxxxV
4005	456
2011, 2017 4008 - 4014	456
2024, 2031 4021 - 4034	457
2046, 2059 4040 - 4065	457
2075 - 2114 4077 - 4124	458
2143, 2169 4156	-
2211, 2273 4180, 4240	-
4302	-

Table 10.22 Models: 2xxxxT and 4xxxxT with Main Switch

Model	Reference Pages
	IP55/UL Type 12 with Main Switch Models: 2xxxxT and 4xxxxT
4005	458
2011, 2017 4008 - 4014	459
2024, 2031 4021 - 4034	459

Model	Reference Pages
	IP55/UL Type 12 with Main Switch Models: 2xxxxT and 4xxxxT
2046, 2059 4040 - 4065	460
2075 - 2114 4077 - 4096	460

◆ IP20/UL Type1

■ Drive Models: 4005, 4008

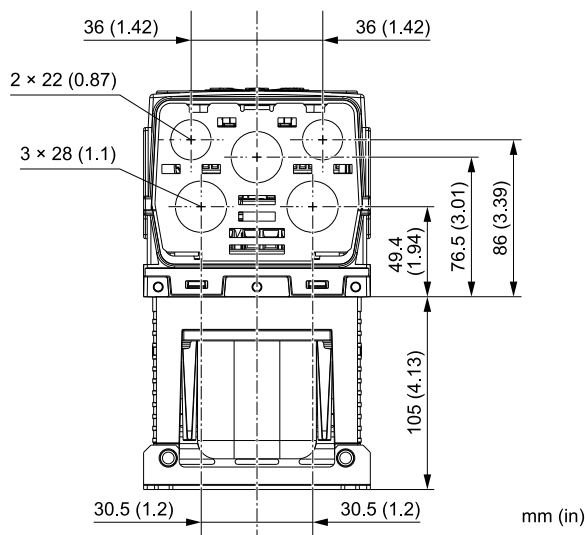

Figure 10.23 Knock-Out Dimensions Diagram 1

■ Drive Models: 2011, 2017, 4011, 4014

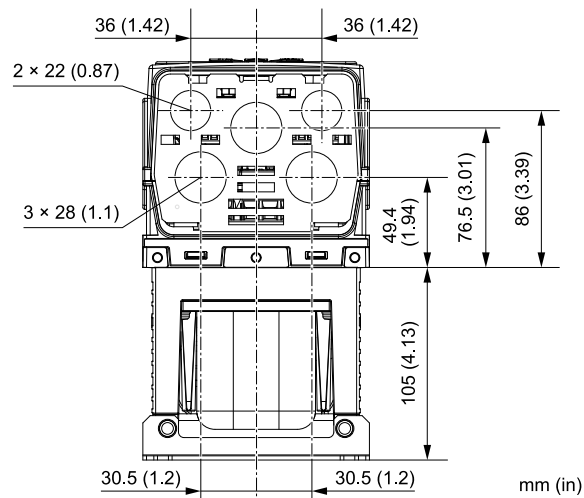

Figure 10.24 Knock-Out Dimensions Diagram 2

■ Drive Models: 2024, 2031, 4021 to 4034

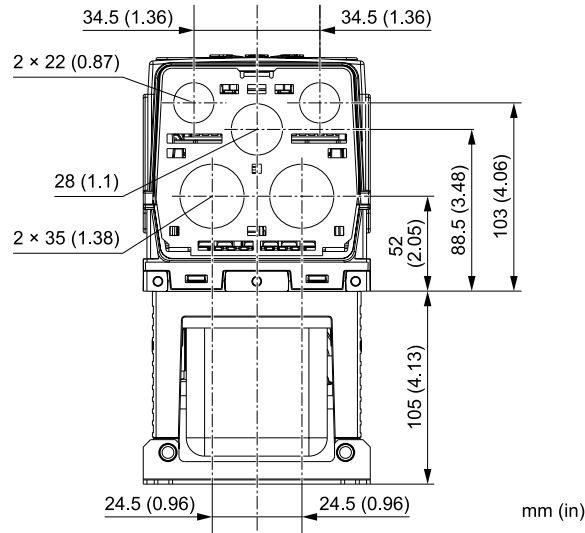

Figure 10.25 Knock-Out Dimensions Diagram 3

■ Drive Models: 2046, 2059, 4040 to 4065

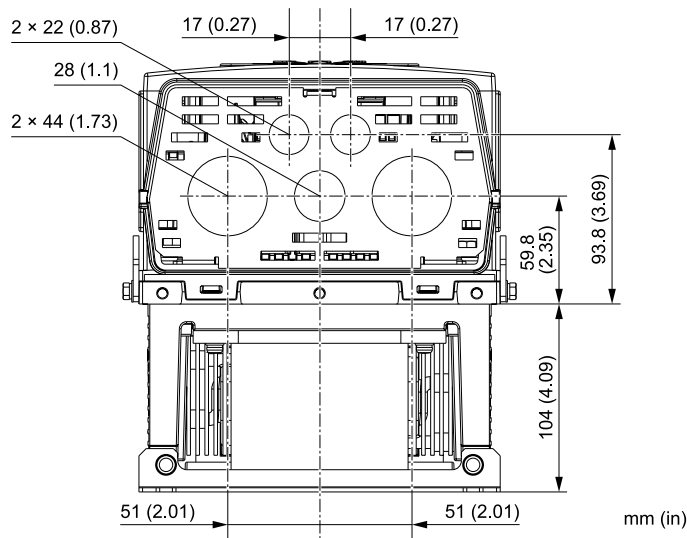

Figure 10.26 Knock-Out Dimensions Diagram 4

■ Drive Models: 2075 to 2114, 4077 to 4124

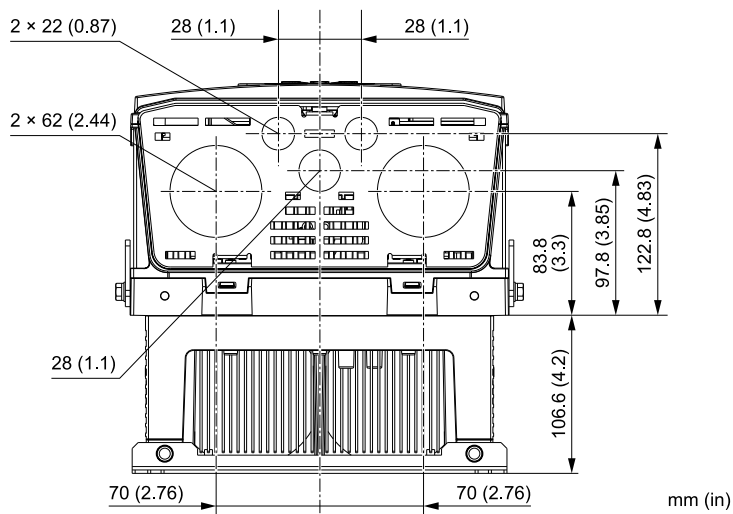

Figure 10.27 Knock-Out Dimensions Diagram 5

■ Drive Models: 2143, 2169, 4156

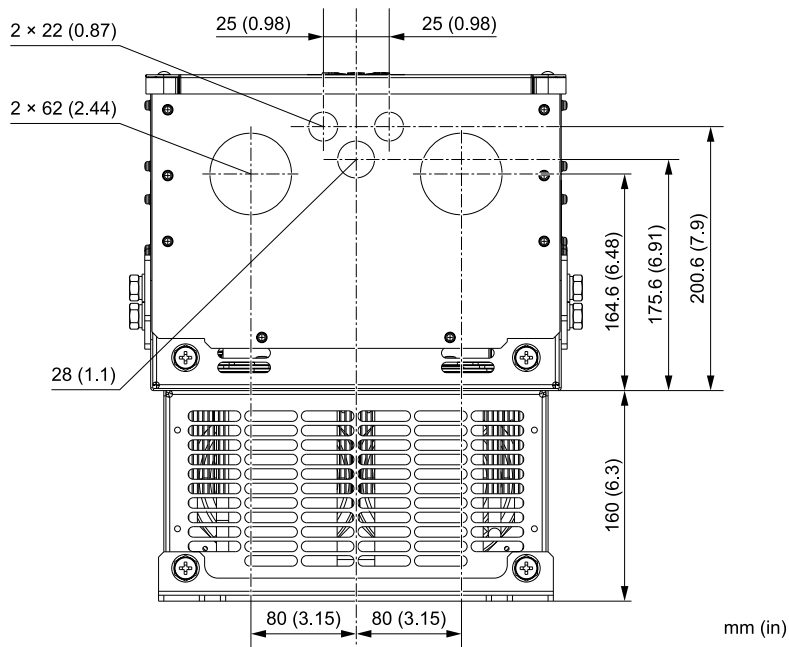

Figure 10.28 Knock-Out Dimensions Diagram 6

◆ IP55/UL Type 12

■ Drive Model: 4005

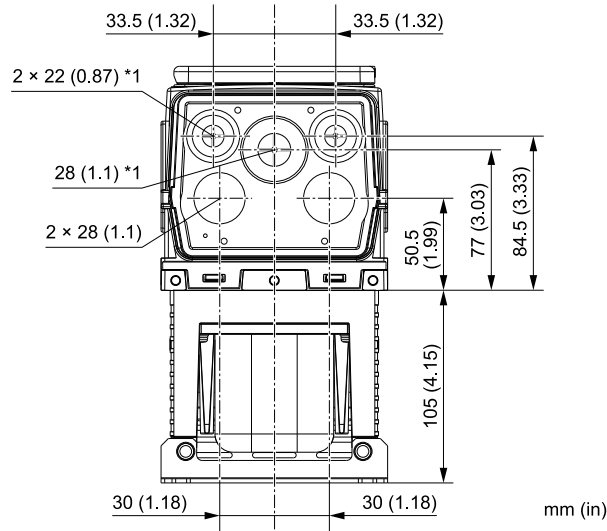

Figure 10.29 Knock-Out Dimensions Diagram 1

\*1 You must install the included rubber waterproofing grommets for knock-out holes that you do not use for control circuit wiring.

■ Drive Models: 2011, 2017, 4008 to 4014

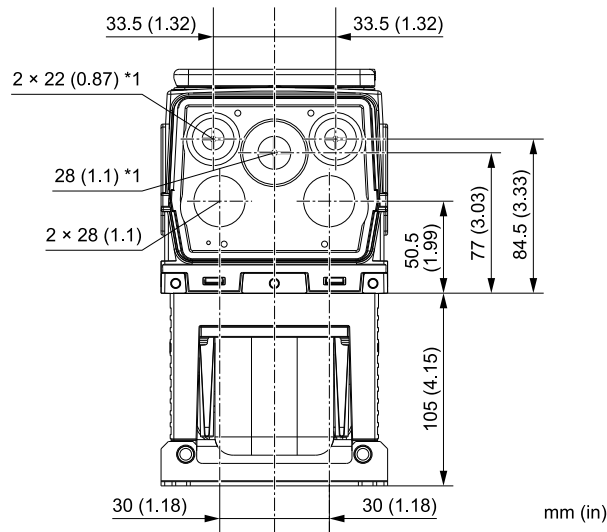
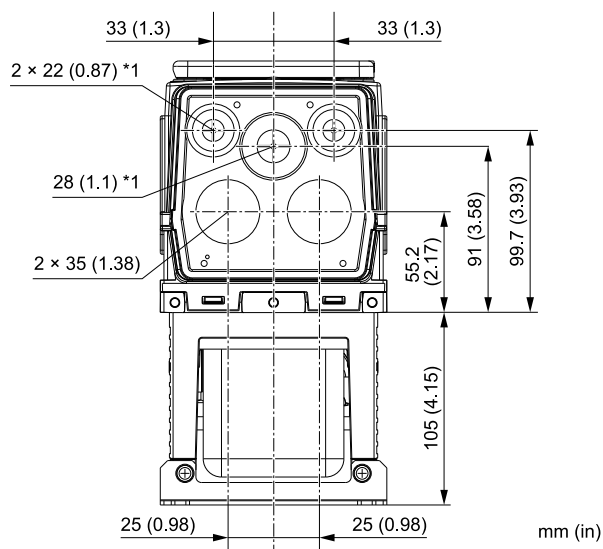

Figure 10.30 Knock-Out Dimensions Diagram 2

\*1 You must install the included rubber waterproofing grommets for knock-out holes that you do not use for control circuit wiring.

### ■ Drive Models: 2024, 2031, 4021 to 4034



**Figure 10.31 Knock-Out Dimensions Diagram 3**

\*1 You must install the included rubber waterproofing grommets for knock-out holes that you do not use for control circuit wiring.

### ■ Drive Models: 2046, 2059, 4040 to 4065

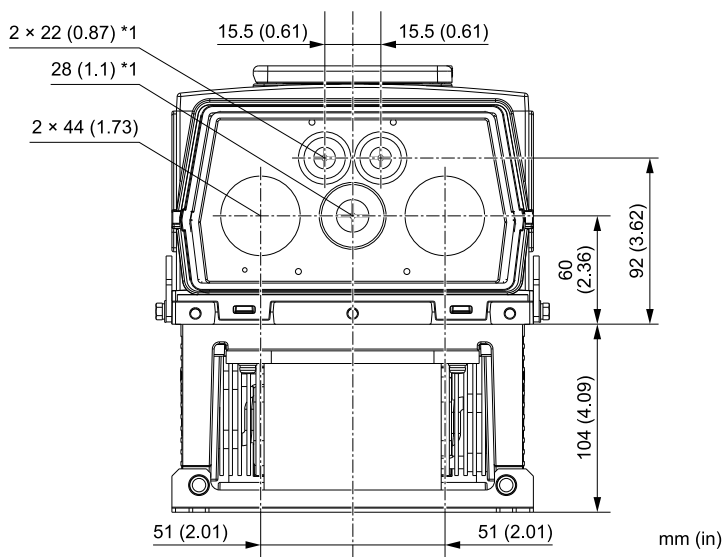

**Figure 10.32 Knock-Out Dimensions Diagram 4**

\*1 You must install the included rubber waterproofing grommets for knock-out holes that you do not use for control circuit wiring.

■ Drive Models: 2075 to 2114, 4077 to 4124

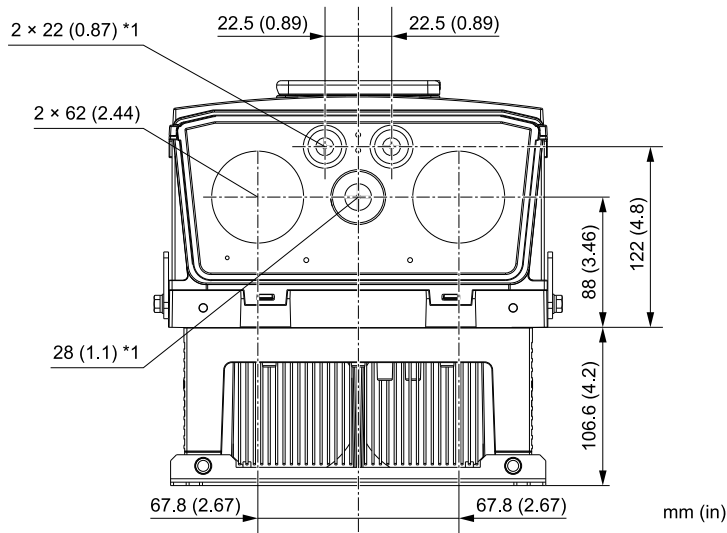

Figure 10.33 Knock-Out Dimensions Diagram 5

\*1 You must install the included rubber waterproofing grommets for knock-out holes that you do not use for control circuit wiring.

◆ IP55/UL Type 12 with Main Switch

■ Drive Model: 4005

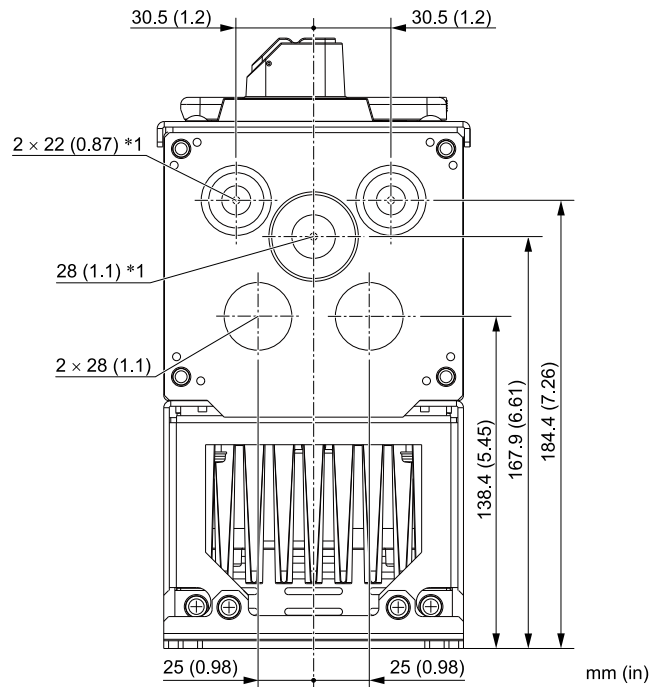
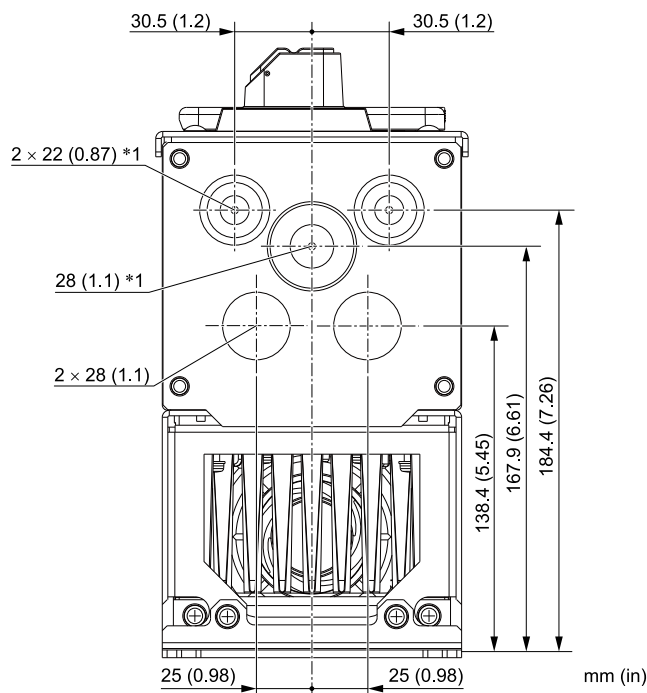

Figure 10.34 Knock-Out Dimensions Diagram 1

\*1 You must install the included rubber waterproofing grommets for knock-out holes that you do not use for control circuit wiring.



### ■ Drive Models: 2011, 2017, 4008 to 4014



**Figure 10.35 Knock-Out Dimensions Diagram 2**

\*1 You must install the included rubber waterproofing grommets for knock-out holes that you do not use for control circuit wiring.

### ■ Drive Models: 2024, 2031, 4021 to 4034

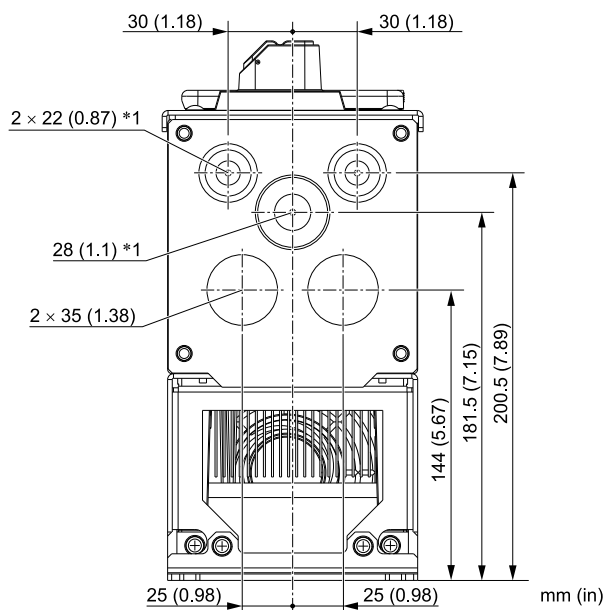

**Figure 10.36 Knock-Out Dimensions Diagram 3**

\*1 You must install the included rubber waterproofing grommets for knock-out holes that you do not use for control circuit wiring.

■ Drive Models: 2046, 2059, 4040 to 4065

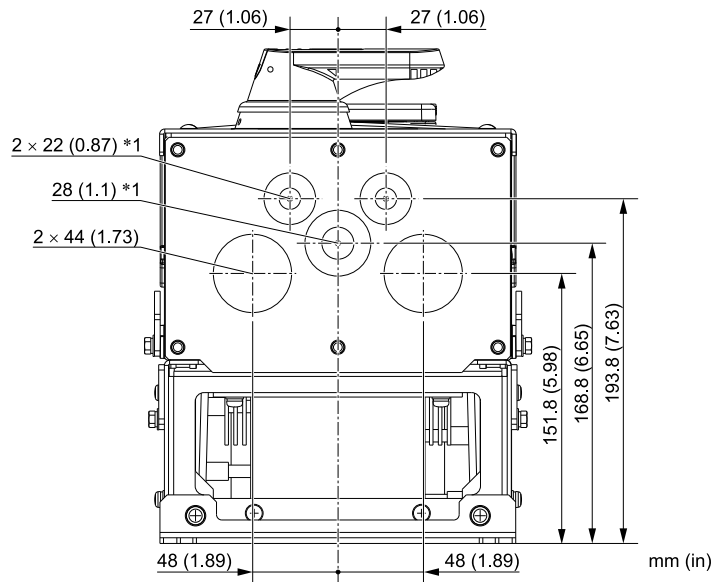

Figure 10.37 Knock-Out Dimensions Diagram 4

\*1 You must install the included rubber waterproofing grommets for knock-out holes that you do not use for control circuit wiring.

■ Drive Models: 2075 to 2114, 4077 to 4096

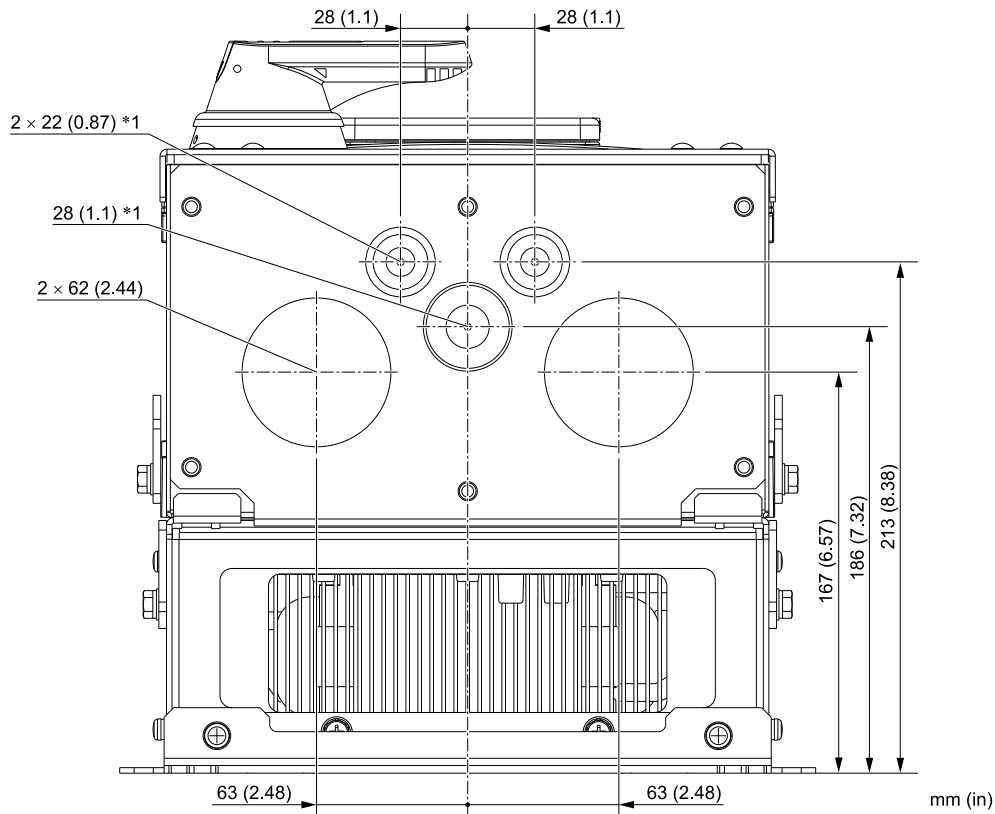

Figure 10.38 Knock-Out Dimensions Diagram 5

\*1 You must install the included rubber waterproofing grommets for knock-out holes that you do not use for control circuit wiring.

## 10.9 Peripheral Devices and Options

There are many available peripheral devices and options for the drive.

Refer to the HV600 Selection Guide (SL.HV600.01) for information about available options, including:

- Main circuit options
- Frequency settings and monitor options
- Keypad options
- Attachment options
- Engineering tools

Contact Yaskawa or your nearest sales representative to make an order.

Refer to the instruction manual for each option for information about option installation and wiring.



## Parameter List

---

11.1	Section Safety .....	464
11.2	How to Read the Parameter List .....	465
11.3	Parameter Groups .....	466
11.4	A: Initialization Parameters .....	468
11.5	b: Application .....	472
11.6	C: Tuning .....	482
11.7	d: Reference Settings .....	485
11.8	E: Motor Parameters .....	488
11.9	F: Options .....	492
11.10	H: Terminal Functions .....	497
11.11	L: Protection Functions .....	524
11.12	n: Special Adjustment .....	533
11.13	o: Keypad-Related Settings .....	538
11.14	q: DriveWorksEZ Parameters .....	545
11.15	r: DWEZ Connection 1-20 .....	546
11.16	S: Special Applications .....	547
11.17	T: Motor Tuning .....	557
11.18	U: Monitors .....	560
11.19	Y: Application Features .....	579
11.20	Parameters that Change from the Default Settings with A1-02 [Control Method Selection] .....	594
11.21	Parameters Changed by E1-03 [V/f Pattern Selection] .....	597
11.22	Defaults by o2-04 [Drive Model (kVA) Selection] .....	600

## 11.1 Section Safety



 **DANGER**

**Do not ignore the safety messages in this manual.**

If you ignore the safety messages in this manual, it will cause serious injury or death. The manufacturer is not responsible for injuries or damage to equipment.

## 11.2 How to Read the Parameter List

### ◆ Icons and Terms that Identify Parameters and Control Methods

Icon	Description
	The parameter is available when operating the drive with V/f Control.
	The parameter is available when operating the drive with Open Loop Vector Control for PM.
	The parameter is available when operating the drive with EZ Open Loop Vector Control.
Hex.	Hexadecimal numbers that represent MEMOBUS addresses to change parameters over network communication.
RUN	You can change the parameter setting during Run.
Expert	The parameter is available in Expert Mode only. <i>*1</i>

\*1 Set  $A1-01 = 3$  [*Access Level Selection = Expert Level*] to show and set Expert Mode parameters on the keypad.

**Note:**

Gray icons identify parameters that are not available in the specified control method.

## 11.3 Parameter Groups

Represents the type of product parameters.

Parameters	Name
A1	Initialization
A2	User Parameters
b1	Operation Mode Selection
b2	DC Injection Braking and Short Circuit Braking
b3	Speed Search
b4	Timer Function
b5	PID Control
b8	Energy Saving
C1	Accel & Decel Time
C2	S-Curve Characteristics
C3	Slip Compensation
C4	Torque Compensation
C5	Auto Speed Regulator (ASR)
C6	Carrier Frequency
d1	Frequency Reference
d2	Reference Limits
d3	Jump Frequency
d4	Frequency Ref Up/Down & Hold
d6	Field Weakening
d7	Offset Frequency
E1	V/f Pattern for Motor 1
E2	Motor Parameters
E3	V/f Pattern for Motor 2
E4	Motor 2 Parameters
E5	PM Motor Settings
E9	Motor Setting
F6	Communication Options
F7	Ethernet Options
H1	Digital Inputs
H2	Digital Outputs
H3	Analog Inputs
H4	Analog Outputs
H5	Serial Communication
H7	Virtual Inputs / Outputs
L1	Motor Protection
L2	Power Loss Ride Through
L3	Stall Prevention
L4	Speed Detection
L5	Fault Restart

Parameters	Name
L6	Torque Detection
L7	Torque Limit
L8	Drive Protection
L9	Drive Protection 2
n1	Hunting Prevention
n3	High Slip/Overexcite Braking
n7	EZ Drive
n8	PM Motor Control Tuning
o1	Keypad Display
o2	Keypad Operation
o3	Copy Keypad Function
o4	Maintenance Monitors
o5	Log Function
q	DriveWorksEZ Parameters
r	DriveWorksEZ Connections
S1	Dynamic Noise Control
S2	Sequence Run Timers
S3	PI2 Control
S5	HAND/OFF/AUTO Operation
S6	Protection
T0	Tuning Mode Selection
T1	InductionMotor Auto-Tuning
T2	PM Motor Auto-Tuning
T4	EZ Tuning
U1	Operation Status Monitors
U2	Fault Trace
U3	Fault History
U4	Maintenance Monitors
U5	PID Monitors
U6	Operation Status Monitors
U8	DriveWorksEZ Monitors
UA	Network Multiplexing
UC	BACnet Diagnostic Monitors
Y1	Application Basics
Y2	PID Sleep and Protection
Y4	Application Advanced
Y9	Network Multiplex Options
YA	Preset Setpoint



Parameters	Name
YC	Foldback Features

Parameters	Name
YF	PI Auxiliary Control

## 11.4 A: Initialization Parameters

### ◆ A1: Initialization

No. (Hex.)	Name	Description	Default (Range)	Ref.
A1-00 (0100) RUN	Language Selection	<p><b>V/f</b> <b>OLV/PM</b> <b>EZOLV</b></p> <p>Sets the language for the keypad.</p> <p><b>Note:</b> When you use <i>A1-03 [Initialize Parameters]</i> to initialize the drive, the drive will not reset this parameter.</p> <p>0 : English 1 : Japanese 2 : German 3 : French 4 : Italian 5 : Spanish 6 : Portuguese</p>	0 (0 - 6)	609
A1-01 (0101) RUN	Access Level Selection	<p><b>V/f</b> <b>OLV/PM</b> <b>EZOLV</b></p> <p>Sets user access to parameters. The access level controls which parameters the keypad will display and which parameters the user can set.</p> <p>0 : Operation Only 1 : User Parameters 2 : Advanced Level 3 : Expert Level 4 : Lock Parameters</p>	2 (0 - 4)	609
A1-02 (0102)	Control Method Selection	<p><b>V/f</b> <b>OLV/PM</b> <b>EZOLV</b></p> <p>Sets the control method for the drive application and the motor.</p> <p>0 : V/f Control 5 : PM Open Loop Vector 8 : EZ Vector Control</p>	0 (0 - 8)	610
A1-03 (0103)	Initialize Parameters	<p><b>V/f</b> <b>OLV/PM</b> <b>EZOLV</b></p> <p>Sets parameters to default values.</p> <p>0 : No Initialization 1110 : User Initialization 2220 : 2-Wire Initialization 3330 : 3-Wire Initialization 3410 : HVAC Initialization</p>	0 (0 - 3410)	611
A1-04 (0104)	Password	<p><b>V/f</b> <b>OLV/PM</b> <b>EZOLV</b></p> <p>Entry point for the password set in <i>A1-05 [Password Setting]</i>. The user can view the settings of parameters that are locked without entering the password. Enter the correct password in this parameter to change parameter settings.</p>	0000 (0000 - 9999)	612
A1-05 (0105)	Password Setting	<p><b>V/f</b> <b>OLV/PM</b> <b>EZOLV</b></p> <p>Sets a password to lock parameters and prevent changes to parameter settings. Enter the correct password in <i>A1-04 [Password]</i> to unlock parameters and accept changes.</p>	0000 (0000 - 9999)	613
A1-06 (0127)	Application Preset	<p><b>V/f</b> <b>OLV/PM</b> <b>EZOLV</b></p> <p>Sets the drive to operate in selected application conditions.</p> <p>0 : No Preset Selected 1 : General Purpose Fan 2 : Fan w/ PID Control 3 : Return Fan w/ PID Control 4 : Cooling Tower Fan 5 : Cooling Tower Fan w/ PID 6 : Secondary Pump 7 : Pump w/ PID Control 8 : Pump Network Multiplex</p>	0 (0 - 8)	613
A1-07 (0128)	DriveWorksEZ Function Selection	<p><b>V/f</b> <b>OLV/PM</b> <b>EZOLV</b></p> <p>Sets the drive to operate with DriveWorksEZ.</p> <p>0 : DWEZ Disabled 1 : DWEZ Enabled 2 : Enabled/Disabled wDigital Input</p>	0 (0 - 2)	623

No. (Hex.)	Name	Description	Default (Range)	Ref.
A1-11 (111D) Expert	Firmware Update Lock	<b>V/f</b> <b>OLV/PM</b> <b>EZOLV</b> Protects the drive firmware. When you enable the protection, you cannot update the drive firmware. 0 : Disabled 1 : Enabled	0 (0, 1)	623
A1-12 (1564)	Bluetooth ID	<b>V/f</b> <b>OLV/PM</b> <b>EZOLV</b> Sets the password necessary to use Bluetooth to control the drive with a smartphone or tablet.	- (0000 - 9999)	624

## ◆ A2: User Parameters

No. (Hex.)	Name	Description	Default (Range)	Ref.
A2-01 (0106)	User Parameter 1	<b>V/f</b> <b>OLV/PM</b> <b>EZOLV</b> Sets the parameter number to be shown for number 1 of the [User Custom Parameters] under the main menu. You can select a maximum of 32 parameters for the drive and set them to parameters A2-01 to A2-32.	A1-02 (Determined by A1-01, A1-02, A1-07)	624
A2-02 (0107)	User Parameter 2	<b>V/f</b> <b>OLV/PM</b> <b>EZOLV</b> Sets the parameter number to be shown for number 2 of the [User Custom Parameters] under the main menu. You can select a maximum of 32 parameters for the drive and set them to parameters A2-01 to A2-32.	b1-01 (Determined by A1-01, A1-02, A1-07)	624
A2-03 (0108)	User Parameter 3	<b>V/f</b> <b>OLV/PM</b> <b>EZOLV</b> Sets the parameter number to be shown for number 3 of the [User Custom Parameters] under the main menu. You can select a maximum of 32 parameters for the drive and set them to parameters A2-01 to A2-32.	b1-02 (Determined by A1-01, A1-02, A1-07)	624
A2-04 (0109)	User Parameter 4	<b>V/f</b> <b>OLV/PM</b> <b>EZOLV</b> Sets the parameter number to be shown for number 4 of the [User Custom Parameters] under the main menu. You can select a maximum of 32 parameters for the drive and set them to parameters A2-01 to A2-32.	b1-03 (Determined by A1-01, A1-02, A1-07)	624
A2-05 (010A)	User Parameter 5	<b>V/f</b> <b>OLV/PM</b> <b>EZOLV</b> Sets the parameter number to be shown for number 5 of the [User Custom Parameters] under the main menu. You can select a maximum of 32 parameters for the drive and set them to parameters A2-01 to A2-32.	C1-01 (Determined by A1-01, A1-02, A1-07)	624
A2-06 (010B)	User Parameter 6	<b>V/f</b> <b>OLV/PM</b> <b>EZOLV</b> Sets the parameter number to be shown for number 6 of the [User Custom Parameters] under the main menu. You can select a maximum of 32 parameters for the drive and set them to parameters A2-01 to A2-32.	C1-02 (Determined by A1-01, A1-02, A1-07)	624
A2-07 (010C)	User Parameter 7	<b>V/f</b> <b>OLV/PM</b> <b>EZOLV</b> Sets the parameter number to be shown for number 7 of the [User Custom Parameters] under the main menu. You can select a maximum of 32 parameters for the drive and set them to parameters A2-01 to A2-32.	C6-02 (Determined by A1-01, A1-02, A1-07)	624
A2-08 (010D)	User Parameter 8	<b>V/f</b> <b>OLV/PM</b> <b>EZOLV</b> Sets the parameter number to be shown for number 8 of the [User Custom Parameters] under the main menu. You can select a maximum of 32 parameters for the drive and set them to parameters A2-01 to A2-32.	d1-01 (Determined by A1-01, A1-02, A1-07)	624
A2-09 (010E)	User Parameter 9	<b>V/f</b> <b>OLV/PM</b> <b>EZOLV</b> Sets the parameter number to be shown for number 9 of the [User Custom Parameters] under the main menu. You can select a maximum of 32 parameters for the drive and set them to parameters A2-01 to A2-32.	d1-02 (Determined by A1-01, A1-02, A1-07)	624
A2-10 (010F)	User Parameter 10	<b>V/f</b> <b>OLV/PM</b> <b>EZOLV</b> Sets the parameter number to be shown for number 10 of the [User Custom Parameters] under the main menu. You can select a maximum of 32 parameters for the drive and set them to parameters A2-01 to A2-32.	d1-03 (Determined by A1-01, A1-02, A1-07)	624
A2-11 (0110)	User Parameter 11	<b>V/f</b> <b>OLV/PM</b> <b>EZOLV</b> Sets the parameter number to be shown for number 11 of the [User Custom Parameters] under the main menu. You can select a maximum of 32 parameters for the drive and set them to parameters A2-01 to A2-32.	d1-04 (Determined by A1-01, A1-02, A1-07)	624
A2-12 (0111)	User Parameter 12	<b>V/f</b> <b>OLV/PM</b> <b>EZOLV</b> Sets the parameter number to be shown for number 12 of the [User Custom Parameters] under the main menu. You can select a maximum of 32 parameters for the drive and set them to parameters A2-01 to A2-32.	d1-17 (Determined by A1-01, A1-02, A1-07)	624
A2-13 (0112)	User Parameter 13	<b>V/f</b> <b>OLV/PM</b> <b>EZOLV</b> Sets the parameter number to be shown for number 13 of the [User Custom Parameters] under the main menu. You can select a maximum of 32 parameters for the drive and set them to parameters A2-01 to A2-32.	E1-01 (Determined by A1-01, A1-02, A1-07)	624

## 11.4 A: Initialization Parameters

No. (Hex.)	Name	Description	Default (Range)	Ref.
A2-14 (0113)	User Parameter 14	<b>V/f</b> <b>OLV/PM</b> <b>EZOLV</b> Sets the parameter number to be shown for number 14 of the [User Custom Parameters] under the main menu. You can select a maximum of 32 parameters for the drive and set them to parameters A2-01 to A2-32.	E1-03 (Determined by A1-01, A1-02, A1-07)	624
A2-15 (0114)	User Parameter 15	<b>V/f</b> <b>OLV/PM</b> <b>EZOLV</b> Sets the parameter number to be shown for number 15 of the [User Custom Parameters] under the main menu. You can select a maximum of 32 parameters for the drive and set them to parameters A2-01 to A2-32.	E1-04 (Determined by A1-01, A1-02, A1-07)	624
A2-16 (0115)	User Parameter 16	<b>V/f</b> <b>OLV/PM</b> <b>EZOLV</b> Sets the parameter number to be shown for number 16 of the [User Custom Parameters] under the main menu. You can select a maximum of 32 parameters for the drive and set them to parameters A2-01 to A2-32.	E1-05 (Determined by A1-01, A1-02, A1-07)	624
A2-17 (0116)	User Parameter 17	<b>V/f</b> <b>OLV/PM</b> <b>EZOLV</b> Sets the parameter number to be shown for number 17 of the [User Custom Parameters] under the main menu. You can select a maximum of 32 parameters for the drive and set them to parameters A2-01 to A2-32. You can set A2-17 to A2-32 when A2-33 = 0 [User Parameter Auto Selection = Disabled: Manual Entry Required].	E1-06 (Determined by A1-01, A1-02, A1-07)	624
A2-18 (0117)	User Parameter 18	<b>V/f</b> <b>OLV/PM</b> <b>EZOLV</b> Sets the parameter number to be shown for number 18 of the [User Custom Parameters] under the main menu. You can select a maximum of 32 parameters for the drive and set them to parameters A2-01 to A2-32. You can set A2-17 to A2-32 when A2-33 = 0 [User Parameter Auto Selection = Disabled: Manual Entry Required].	E1-09 (Determined by A1-01, A1-02, A1-07)	624
A2-19 (0118)	User Parameter 19	<b>V/f</b> <b>OLV/PM</b> <b>EZOLV</b> Sets the parameter number to be shown for number 19 of the [User Custom Parameters] under the main menu. You can select a maximum of 32 parameters for the drive and set them to parameters A2-01 to A2-32. You can set A2-17 to A2-32 when A2-33 = 0 [User Parameter Auto Selection = Disabled: Manual Entry Required].	E1-13 (Determined by A1-01, A1-02, A1-07)	624
A2-20 (0119)	User Parameter 20	<b>V/f</b> <b>OLV/PM</b> <b>EZOLV</b> Sets the parameter number to be shown for number 20 of the [User Custom Parameters] under the main menu. You can select a maximum of 32 parameters for the drive and set them to parameters A2-01 to A2-32. You can set A2-17 to A2-32 when A2-33 = 0 [User Parameter Auto Selection = Disabled: Manual Entry Required].	E2-01 (Determined by A1-01, A1-02, A1-07)	624
A2-21 (011A)	User Parameter 21	<b>V/f</b> <b>OLV/PM</b> <b>EZOLV</b> Sets the parameter number to be shown for number 21 of the [User Custom Parameters] under the main menu. You can select a maximum of 32 parameters for the drive and set them to parameters A2-01 to A2-32. You can set A2-17 to A2-32 when A2-33 = 0 [User Parameter Auto Selection = Disabled: Manual Entry Required].	E2-04 (Determined by A1-01, A1-02, A1-07)	624
A2-22 (011B)	User Parameter 22	<b>V/f</b> <b>OLV/PM</b> <b>EZOLV</b> Sets the parameter number to be shown for number 22 of the [User Custom Parameters] under the main menu. You can select a maximum of 32 parameters for the drive and set them to parameters A2-01 to A2-32. You can set A2-17 to A2-32 when A2-33 = 0 [User Parameter Auto Selection = Disabled: Manual Entry Required].	E2-11 (Determined by A1-01, A1-02, A1-07)	624
A2-23 (011C)	User Parameter 23	<b>V/f</b> <b>OLV/PM</b> <b>EZOLV</b> Sets the parameter number to be shown for number 23 of the [User Custom Parameters] under the main menu. You can select a maximum of 32 parameters for the drive and set them to parameters A2-01 to A2-32. You can set A2-17 to A2-32 when A2-33 = 0 [User Parameter Auto Selection = Disabled: Manual Entry Required].	H4-02 (Determined by A1-01, A1-02, A1-07)	624
A2-24 (011D)	User Parameter 24	<b>V/f</b> <b>OLV/PM</b> <b>EZOLV</b> Sets the parameter number to be shown for number 24 of the [User Custom Parameters] under the main menu. You can select a maximum of 32 parameters for the drive and set them to parameters A2-01 to A2-32. You can set A2-17 to A2-32 when A2-33 = 0 [User Parameter Auto Selection = Disabled: Manual Entry Required].	L1-01 (Determined by A1-01, A1-02, A1-07)	624
A2-25 (011E)	User Parameter 25	<b>V/f</b> <b>OLV/PM</b> <b>EZOLV</b> Sets the parameter number to be shown for number 25 of the [User Custom Parameters] under the main menu. You can select a maximum of 32 parameters for the drive and set them to parameters A2-01 to A2-32. You can set A2-17 to A2-32 when A2-33 = 0 [User Parameter Auto Selection = Disabled: Manual Entry Required].	L3-04 (Determined by A1-01, A1-02, A1-07)	624
A2-26 (011F)	User Parameter 26	<b>V/f</b> <b>OLV/PM</b> <b>EZOLV</b> Sets the parameter number to be shown for number 26 of the [User Custom Parameters] under the main menu. You can select a maximum of 32 parameters for the drive and set them to parameters A2-01 to A2-32. You can set A2-17 to A2-32 when A2-33 = 0 [User Parameter Auto Selection = Disabled: Manual Entry Required].	- (Determined by A1-01, A1-02, A1-07)	624
A2-27 (0120)	User Parameter 27	<b>V/f</b> <b>OLV/PM</b> <b>EZOLV</b> Sets the parameter number to be shown for number 27 of the [User Custom Parameters] under the main menu. You can select a maximum of 32 parameters for the drive and set them to parameters A2-01 to A2-32. You can set A2-17 to A2-32 when A2-33 = 0 [User Parameter Auto Selection = Disabled: Manual Entry Required].	- (Determined by A1-01, A1-02, A1-07)	624
A2-28 (0121)	User Parameter 28	<b>V/f</b> <b>OLV/PM</b> <b>EZOLV</b> Sets the parameter number to be shown for number 28 of the [User Custom Parameters] under the main menu. You can select a maximum of 32 parameters for the drive and set them to parameters A2-01 to A2-32. You can set A2-17 to A2-32 when A2-33 = 0 [User Parameter Auto Selection = Disabled: Manual Entry Required].	- (Determined by A1-01, A1-02, A1-07)	624

No. (Hex.)	Name	Description	Default (Range)	Ref.
A2-29 (0122)	User Parameter 29	<b>V/f</b> <b>OLV/PM</b> <b>EZOLV</b> Sets the parameter number to be shown for number 29 of the [User Custom Parameters] under the main menu. You can select a maximum of 32 parameters for the drive and set them to parameters A2-01 to A2-32. You can set A2-17 to A2-32 when A2-33 = 0 [User Parameter Auto Selection = Disabled: Manual Entry Required].	- (Determined by A1-01, A1-02, A1-07)	624
A2-30 (0123)	User Parameter 30	<b>V/f</b> <b>OLV/PM</b> <b>EZOLV</b> Sets the parameter number to be shown for number 30 of the [User Custom Parameters] under the main menu. You can select a maximum of 32 parameters for the drive and set them to parameters A2-01 to A2-32. You can set A2-17 to A2-32 when A2-33 = 0 [User Parameter Auto Selection = Disabled: Manual Entry Required].	- (Determined by A1-01, A1-02, A1-07)	624
A2-31 (0124)	User Parameter 31	<b>V/f</b> <b>OLV/PM</b> <b>EZOLV</b> Sets the parameter number to be shown for number 31 of the [User Custom Parameters] under the main menu. You can select a maximum of 32 parameters for the drive and set them to parameters A2-01 to A2-32. You can set A2-17 to A2-32 when A2-33 = 0 [User Parameter Auto Selection = Disabled: Manual Entry Required].	- (Determined by A1-01, A1-02, A1-07)	624
A2-32 (0125)	User Parameter 32	<b>V/f</b> <b>OLV/PM</b> <b>EZOLV</b> Sets the parameter number to be shown for number 32 of the [User Custom Parameters] under the main menu. You can select a maximum of 32 parameters for the drive and set them to parameters A2-01 to A2-32. You can set A2-17 to A2-32 when A2-33 = 0 [User Parameter Auto Selection = Disabled: Manual Entry Required].	- (Determined by A1-01, A1-02, A1-07)	624
A2-33 (0126)	User Parameter Auto Selection	<b>V/f</b> <b>OLV/PM</b> <b>EZOLV</b> Sets the automatic save feature for changes to parameters A2-17 to A2-32 [User Parameters 17 to 32]. 0 : Disabled: Manual Entry Required 1 : Enabled: Auto Save Recent Parm	Determined by A1-06 (0, 1)	624

## 11.5 b: Application

### ◆ b1: Operation Mode Selection

No. (Hex.)	Name	Description	Default (Range)	Ref.
b1-01 (0180)	Frequency Reference Selection 1	<p><b>V/f</b> <b>OLV/PM</b> <b>EZOLV</b></p> <p>Sets the input method for the frequency reference.</p> <p>0 : Keypad 1 : Analog Input 2 : Serial Communications 3 : Option PCB</p>	1 (0 - 3)	625
b1-02 (0181)	Run Command Selection 1	<p><b>V/f</b> <b>OLV/PM</b> <b>EZOLV</b></p> <p>Sets the input method for the Run command.</p> <p>0 : Keypad 1 : Digital Input 2 : Serial Communications 3 : Option PCB 7 : AUTO Command + Term Run 8 : AUTO Command + Serial Run 9 : AUTO Command + Option Run</p> <p><b>Note:</b> If you use these parameter settings at the same time, the drive will detect an <i>oPE05</i> [Run Cmd/Freq Ref Source Sel Err]:</p> <ul style="list-style-type: none"> <li>• <i>S5-04</i> = 0 [HAND-OFF-AUTO Behavior = Legacy] and <i>b1-02</i> = 0 to 3</li> <li>• <i>S5-10</i> = 2 [AUTO Key Memory at Power Down = AUTO Mode] and <i>b1-02</i> = 0</li> </ul>	7 (0 - 9)	627
b1-03 (0182)	Stopping Method Selection	<p><b>V/f</b> <b>OLV/PM</b> <b>EZOLV</b></p> <p>Sets the method to stop the motor after removing a Run command or entering a Stop command.</p> <p><b>Note:</b> When <i>A1-02</i> = 5 or 8 [Control Method Selection = OLV/PM or EZOLV], the setting range is 0, 1, 3.</p> <p>0 : Ramp to Stop 1 : Coast to Stop 2 : DC Injection Braking to Stop 3 : Coast to Stop with Timer</p>	1 (0 - 3)	627
b1-04 (0183)	Reverse Operation Selection	<p><b>V/f</b> <b>OLV/PM</b> <b>EZOLV</b></p> <p>Sets the reverse operation function. Disable reverse operation in fan or pump applications where reverse rotation is dangerous.</p> <p>0 : Reverse Enabled 1 : Reverse Disabled</p>	1 (0, 1)	630
b1-08 (0187)	Run Command Select in PRG Mode	<p><b>V/f</b> <b>OLV/PM</b> <b>EZOLV</b></p> <p>Sets the conditions for the drive to accept a Run command entered from an external source when using the keypad to set parameters.</p> <p>0 : Disregard RUN while Programming 1 : Accept RUN while Programming 2 : Allow Programming Only at Stop</p>	0 (0 - 2)	631
b1-11 (01DF)	Run Delay @ Stop	<p><b>V/f</b> <b>OLV/PM</b> <b>EZOLV</b></p> <p>Sets the amount of time that the drive will not accept the Run command again after the Run command is removed.</p> <p><b>Note:</b></p> <ul style="list-style-type: none"> <li>• This parameter will operate for both AUTO Mode and HAND Mode.</li> <li>• This parameter will operate when the drive goes to sleep then wakes up.</li> <li>• The time set in this parameter does not apply for faults or Auto-Restarts.</li> <li>• When there is an active Run command while the time set in <i>b1-11</i> is active, the keypad will show a [Start Delay] message as specified by the <i>o1-82</i> [Message Screen Display] display format.</li> </ul>	0.0 s (0.0 - 6000.0 s)	631
b1-12 (01E0)	Run Delay Memory Selection	<p><b>V/f</b> <b>OLV/PM</b> <b>EZOLV</b></p> <p>Sets how the drive saves Run Delay Timer to the EEPROM during power loss.</p> <p>0 : Disabled 1 : Only at Stop 2 : Running &amp; Stop</p>	2 (0 - 2)	632

No. (Hex.)	Name	Description	Default (Range)	Ref.
b1-14 (01C3)	Phase Order Selection	<p><b>V/f</b> <b>OLV/PM</b> <b>EZOLV</b></p> <p>Sets the phase order for output terminals U/T1, V/T2, and W/T3. This parameter can align the Forward Run command from the drive and the forward direction of the motor without changing wiring.</p> <p><b>Note:</b> When you use <i>A1-03 [Initialize Parameters]</i> to initialize the drive, the drive will not reset this parameter.</p> <p>0 : Standard 1 : Switch Phase Order</p>	0 (0, 1)	634
b1-17 (01C6)	Run Command at Power Up	<p><b>V/f</b> <b>OLV/PM</b> <b>EZOLV</b></p> <p>Sets drive response when the CPU changes from de-energized to energized and there is an active Run command. Set this parameter in applications where energizing or de-energizing the drive enables the Run command. When the CPU stays energized during loss of power, <i>L2-01 [Power Loss Ride Through Select]</i> sets operation.</p> <p>0 : Disregard Existing RUN Command 1 : Accept Existing RUN Command</p>	1 (0, 1)	634
b1-40 (3BCF)	Deceleration Abort Time	<p><b>V/f</b> <b>OLV/PM</b> <b>EZOLV</b></p> <p>Sets the maximum time until the drive shuts off the output to decelerate to stop.</p> <p><b>Note:</b> Set this parameter to 0.0 s to disable this function.</p>	0.0 s (0.0 - 6000.0 s)	635

## ◆ b2: DC Injection Braking and Short Circuit Braking

No. (Hex.)	Name	Description	Default (Range)	Ref.
b2-01 (0189)	DC Injection/Zero Speed Threshold	<p><b>V/f</b> <b>OLV/PM</b> <b>EZOLV</b></p> <p>Sets the frequency to start DC Injection Braking or Short Circuit Braking near the end of a stop ramp.</p> <p><b>Note:</b> This parameter is available when <i>b1-03 = 0 [Stopping Method Selection = Ramp to Stop]</i>.</p>	Determined by A1-02 (0.0 - 10.0 Hz)	635
b2-02 (018A)	DC Injection Braking Current	<p><b>V/f</b> <b>OLV/PM</b> <b>EZOLV</b></p> <p>Sets the DC Injection Braking current as a percentage of the drive rated current.</p>	50% (0 - 100%)	636
b2-03 (018B)	DC Inject Braking Time at Start	<p><b>V/f</b> <b>OLV/PM</b> <b>EZOLV</b></p> <p>Sets the DC Injection Braking Time at start.</p>	0.00 s (0.00 - 10.00 s)	636
b2-04 (018C)	DC Inject Braking Time at Stop	<p><b>V/f</b> <b>OLV/PM</b> <b>EZOLV</b></p> <p>Sets the DC Injection Braking Time at stop.</p>	0.00 s (0.00 - 10.00 s)	637
b2-09 (01E1)	Pre-heat Current 2	<p><b>V/f</b> <b>OLV/PM</b> <b>EZOLV</b></p> <p>Sets the percentage of motor rated output current used with <i>MFDI H1-xx = 50 [MFDI Function Selection = Motor Pre-heat 2]</i> for the motor pre-heat function.</p>	5% (0 - 100%)	637
b2-12 (01BA)	Short Circuit Brake Time @ Start	<p><b>V/f</b> <b>OLV/PM</b> <b>EZOLV</b></p> <p>Sets the Short Circuit Braking time at start.</p>	0.00 s (0.00 - 25.50 s)	637
b2-13 (01BB)	Short Circuit Brake Time @ Stop	<p><b>V/f</b> <b>OLV/PM</b> <b>EZOLV</b></p> <p>Sets the Short Circuit Braking time at stop.</p>	Determined by A1-02 (0.00 - 25.50 s)	637
b2-18 (0177)	Short Circuit Braking Current	<p><b>V/f</b> <b>OLV/PM</b> <b>EZOLV</b></p> <p>Sets the Short Circuit Braking Current as a percentage of the motor rated current.</p> <p><b>Note:</b> Parameter <i>A1-02 [Control Method Selection]</i> selects which parameter is the motor rated current.  <ul style="list-style-type: none"> <li><i>A1-02 = 5 [OLV/PM]: E5-03 [PM Motor Rated Current (FLA)]</i></li> <li><i>A1-02 = 8 [EZOLV]: E9-06 [Motor Rated Current (FLA)]</i></li> </ul> </p>	100.0% (0.0 - 200.0%)	637

### ◆ b3: Speed Search

No. (Hex.)	Name	Description	Default (Range)	Ref.
b3-01 (0191)	Speed Search at Start Selection	<p><b>V/f</b> <b>OLV/PM</b> <b>EZOLV</b></p> <p>Sets the drive to do a Speed Search each time the drive receives a Run command. 0 : Disabled 1 : Enabled</p>	0 (0, 1)	641
b3-02 (0192)	SpeedSearch Deactivation Current	<p><b>V/f</b> <b>OLV/PM</b> <b>EZOLV</b></p> <p>Sets the current level that stops Speed Search as a percentage of the drive rated output current. Usually it is not necessary to change this setting.</p>	120% (0 - 200%)	642
b3-03 (0193)	Speed Search Deceleration Time	<p><b>V/f</b> <b>OLV/PM</b> <b>EZOLV</b></p> <p>Sets the deceleration time during Speed Search operation. Set the length of time to decelerate from the maximum output frequency to the minimum output frequency.</p> <p><b>Note:</b> When <math>A1-02 = 8</math> [Control Method Selection = EZOLV], this parameter takes effect only in Expert Mode.</p>	2.0 s (0.1 - 10.0 s)	642
b3-04 (0194)	V/f Gain during Speed Search	<p><b>V/f</b> <b>OLV/PM</b> <b>EZOLV</b></p> <p>Sets the ratio used to reduce the V/f during searches to reduce the output current during speed searches.</p>	Determined by o2-04 (10 - 100)	642
b3-05 (0195)	Speed Search Delay Time	<p><b>V/f</b> <b>OLV/PM</b> <b>EZOLV</b></p> <p>Sets the Speed Search delay time to activate a magnetic contactor installed between the drive and motor.</p>	0.2 s (0.0 - 100.0 s)	642
b3-06 (0196) Expert	Speed Estimation Current Level 1	<p><b>V/f</b> <b>OLV/PM</b> <b>EZOLV</b></p> <p>Sets the level of current that flows to the motor during Speed Estimation Speed Search as a coefficient of the motor rated current. Usually it is not necessary to change this setting.</p>	Determined by o2-04 (0.0 - 2.0)	642
b3-07 (0197) Expert	Speed Estimation Current Level 2	<p><b>V/f</b> <b>OLV/PM</b> <b>EZOLV</b></p> <p>Sets the level of current that flows to the motor during Speed Estimation Speed Search as a coefficient of <math>E2-03</math> [Motor No-Load Current] or <math>E4-03</math> [Motor 2 Rated No-Load Current]. Usually it is not necessary to change this setting.</p>	1.0 (0.0 - 3.0)	643
b3-08 (0198)	Speed Estimation ACR P Gain	<p><b>V/f</b> <b>OLV/PM</b> <b>EZOLV</b></p> <p>Sets the proportional gain for the automatic current regulator during Speed Estimation Speed Search. Also adjusts speed search responsiveness. Usually it is not necessary to change this setting.</p>	Determined by A1-02 and o2-04 (0.00 - 6.00)	643
b3-09 (0199)	Speed Estimation ACR I Time	<p><b>V/f</b> <b>OLV/PM</b> <b>EZOLV</b></p> <p>Sets the integral time for the automatic current regulator during Speed Estimation Speed Search. Also adjusts speed search responsiveness. Usually it is not necessary to change this setting.</p>	Determined by A1-02 when $A1-02 \neq 5$ 20.0 when $A1-02 = 5$ (0.0 - 1000.0 ms)	643
b3-10 (019A) Expert	Speed Estimation Detection Gain	<p><b>V/f</b> <b>OLV/PM</b> <b>EZOLV</b></p> <p>Sets the gain to correct estimated frequencies from Speed Estimation Speed Search.</p> <p><b>Note:</b> When <math>A1-02 = 8</math> [Control Method Selection = EZOLV], the default setting is 1.00 and the setting range is 1.00 - 1.10.</p>	1.05 (1.00 - 1.20)	643
b3-11 (019B) Expert	Spd Est Method Switch-over Level	<p><b>V/f</b> <b>OLV/PM</b> <b>EZOLV</b></p> <p>Uses the quantity of voltage in the motor to automatically switch the search method within the type of speed measurement.</p> <p><b>Note:</b></p> <ul style="list-style-type: none"> <li>• 208 V class at 100% = 200 V</li> <li>• 480 V class at 100% = 400 V</li> </ul>	5.0% (0.5 - 100.0%)	643
b3-12 (019C) Expert	Speed Search Current Deadband	<p><b>V/f</b> <b>OLV/PM</b> <b>EZOLV</b></p> <p>Sets the minimum current detection level during Speed Search. If the drive does not do Speed Estimation, increase this setting in 0.1-unit increments.</p>	determined by o2-04 (2.0 - 10.0)	644



No. (Hex.)	Name	Description	Default (Range)	Ref.
b3-14 (019E)	Bi-directional Speed Search	<p><b>V/f</b> <b>OLV/PM</b> <b>EZOLV</b></p> <p>Sets the direction of Speed Search to the direction of the frequency reference or in the motor rotation direction as detected by the drive.</p> <p>0 : Disabled 1 : Enabled</p> <p><b>Note:</b></p> <ul style="list-style-type: none"> <li>The initial value of <i>b3-14</i> is different for different <i>A1-02</i> [Control Method Selection] settings when you set these parameters: <ul style="list-style-type: none"> <li>–<i>A1-02</i> = 0, 8 [Control Method Selection = V/f, EZOLV]</li> <li>–<i>E9-01</i> = 0 [Motor Type Selection = Induction (IM)]</li> <li>–<i>b3-24</i> = 1 [Speed Search Method Selection = Speed Estimation Speed Search]</li> </ul> </li> <li>The initial value of <i>b3-14</i> is 0 when you set these parameters: <ul style="list-style-type: none"> <li>–<i>A1-02</i> = 0, 8</li> <li>–<i>E9-01</i> = 0</li> <li>–<i>b3-24</i> = 2 [Current Detection 2]</li> </ul> </li> <li>The initial value of <i>b3-14</i> is different for different <i>A1-02</i> [Control Method Selection] settings when you set these parameters: <ul style="list-style-type: none"> <li>–<i>A1-02</i> = 8 [EZOLV]</li> <li>–<i>E9-01</i> = 1, 2 [Permanent Magnet (PM), Synchronous Reluctance (SynRM)]</li> </ul> </li> <li>When you change <i>A1-02</i>, <i>b3-24</i>, and <i>E9-01</i>, also set <i>b3-14</i>.</li> </ul>	Determined by A1-02, b3-24, and E9-01 (0, 1)	644
b3-17 (01F0) Expert	Speed Est Retry Current Level	<p><b>V/f</b> <b>OLV/PM</b> <b>EZOLV</b></p> <p>Sets the current level for the search retry function in Speed Estimation Speed Search as a percentage where drive rated current is a setting value of 100%.</p>	110% (0 - 200%)	644
b3-18 (01F1) Expert	Speed Est Retry Detection Time	<p><b>V/f</b> <b>OLV/PM</b> <b>EZOLV</b></p> <p>Sets the length of time that the drive will wait to retry Speed Estimation Speed Search when too much current flow stopped the Speed Search.</p>	0.10 s (0.00 - 1.00 s)	644
b3-19 (01F2)	Speed Search Restart Attempts	<p><b>V/f</b> <b>OLV/PM</b> <b>EZOLV</b></p> <p>Sets the number of times to restart Speed Search if Speed Search does not complete.</p>	3 times (0 - 10 times)	645
b3-24 (01C0)	Speed Search Method Selection	<p><b>V/f</b> <b>OLV/PM</b> <b>EZOLV</b></p> <p>Sets the Speed Search method when you start the motor or when you return power after a momentary power loss.</p> <p><b>Note:</b></p> <ul style="list-style-type: none"> <li>The default setting is different for different control methods. <ul style="list-style-type: none"> <li>–<i>A1-02</i> = 0 [Control Method Selection = V/f]: 2</li> <li>–<i>A1-02</i> = 8 [EZOLV] and <i>E9-01</i> = 0 [Motor Type Selection = Induction (IM)]: 2</li> <li>–<i>A1-02</i> = 8 and <i>E9-01</i> ≠ 0: 1</li> </ul> </li> <li>When <i>A1-02</i> = 8 and <i>E9-01</i> = 1, 2, set <i>b3-24</i> = 1. If <i>b3-24</i> = 2, the drive will detect <i>oPE08</i> [Parameter Selection Error].</li> </ul> <p>1 : Speed Estimation 2 : Current Detection 2</p>	Determined by A1-02 (1, 2)	645
b3-25 (01C8) Expert	Speed Search Wait Time	<p><b>V/f</b> <b>OLV/PM</b> <b>EZOLV</b></p> <p>Sets the length of time the drive will wait to start the Speed Search Retry function.</p>	0.5 s (0.0 - 30.0 s)	645
b3-26 (01C7) Expert	Direction Determination Level	<p><b>V/f</b> <b>OLV/PM</b> <b>EZOLV</b></p> <p>Sets the level to find the motor rotation direction. Increase the value if the drive cannot find the direction.</p>	1000 (40 to 60000)	645
b3-27 (01C9) Expert	Speed Search RUN/BB Priority	<p><b>V/f</b> <b>OLV/PM</b> <b>EZOLV</b></p> <p>Sets the conditions necessary to start Speed Search.</p> <p>0 : SS Only if RUN Applied Before BB 1 : SS Regardless of RUN/BB Sequence</p>	0 (0, 1)	646
b3-29 (077C) Expert	Speed Search Back-EMF Threshold	<p><b>V/f</b> <b>OLV/PM</b> <b>EZOLV</b></p> <p>Sets the induced voltage for motors that use Speed Search. The drive will start Speed Search when the motor induced voltage level is the same as the setting value. Usually it is not necessary to change this setting.</p>	10% (0 - 10%)	646
b3-31 (0BC0) Expert	Spd Search Current Reference Lvl	<p><b>V/f</b> <b>OLV/PM</b> <b>EZOLV</b></p> <p>Sets the current level that decreases the output current during Current Detection Speed Search.</p>	1.50 (1.50 - 3.50)	646
b3-32 (0BC1) Expert	Spd Search Current Complete Lvl	<p><b>V/f</b> <b>OLV/PM</b> <b>EZOLV</b></p> <p>Sets the current level that completes Speed Search.</p>	1.20 (0.00 - 1.49)	646
b3-39 (1B8F) Expert	Regen Judgment Lv of Spd Search	<p><b>V/f</b> <b>OLV/PM</b> <b>EZOLV</b></p> <p>Sets the level to determine the regenerative state during speed search. Usually it is not necessary to change this setting.</p> <p><b>Note:</b></p> <p>This parameter is only available in the drive software versions PRG: 01013 and later.</p>	15% (0 - 50%)	646

## 11.5 b: Application

No. (Hex.)	Name	Description	Default (Range)	Ref.
b3-54 (3123)	Search Time	<input type="checkbox"/> V/f <input type="checkbox"/> OLV/PM <input type="checkbox"/> EZOLV Sets the length of time that the drive will run Speed Search.	400 ms (10 - 2000 ms)	647
b3-55 (3124) Expert	Current Increment Time	<input type="checkbox"/> V/f <input type="checkbox"/> OLV/PM <input type="checkbox"/> EZOLV Sets the length of time that the drive will increase the current from zero current to the setting value of b3-06 [Speed Estimation Current Level 1].	10 ms (10 - 2000 ms)	647
b3-56 (3126)	InverseRotationSearch WaitTime	<input type="checkbox"/> V/f <input type="checkbox"/> OLV/PM <input type="checkbox"/> EZOLV Sets the wait time until the drive starts inverse rotation search after it completes forward search when you do inverse rotation search during Current Detection Speed Search.	Determined by o2-04 (0.1 - 5.0 s)	647

### ◆ b4: Timer Function

No. (Hex.)	Name	Description	Default (Range)	Ref.
b4-01 (01A3)	Timer Function ON-Delay Time	<input type="checkbox"/> V/f <input type="checkbox"/> OLV/PM <input type="checkbox"/> EZOLV Sets the ON-delay time for the timer input.	0.0 s (0.0 - 3000.0 s)	648
b4-02 (01A4)	Timer Function OFF-Delay Time	<input type="checkbox"/> V/f <input type="checkbox"/> OLV/PM <input type="checkbox"/> EZOLV Sets the OFF-delay time for the timer input.	0.0 s (0.0 - 3000.0 s)	648
b4-03 (0B30) Expert	Terminal M1-M2 ON-Delay Time	<input type="checkbox"/> V/f <input type="checkbox"/> OLV/PM <input type="checkbox"/> EZOLV Sets the delay time to activate the contact after the function set in H2-01 activates.	0 ms (0 - 65000 ms)	648
b4-04 (0B31) Expert	Terminal M1-M2 OFF-Delay Time	<input type="checkbox"/> V/f <input type="checkbox"/> OLV/PM <input type="checkbox"/> EZOLV Sets the delay time to deactivate the contact after the function set in H2-01 deactivates.	0 ms (0 - 65000 ms)	648
b4-05 (0B32) Expert	Terminal M3-M4 ON-Delay Time	<input type="checkbox"/> V/f <input type="checkbox"/> OLV/PM <input type="checkbox"/> EZOLV Sets the delay time to activate the contact after the function set in H2-02 activates.	0 ms (0 - 65000 ms)	648
b4-06 (0B33) Expert	Terminal M3-M4 OFF-Delay Time	<input type="checkbox"/> V/f <input type="checkbox"/> OLV/PM <input type="checkbox"/> EZOLV Sets the delay time to deactivate the contact after the function set in H2-02 deactivates.	0 ms (0 - 65000 ms)	649
b4-07 (0B34) Expert	Terminal M5-M6 ON-Delay Time	<input type="checkbox"/> V/f <input type="checkbox"/> OLV/PM <input type="checkbox"/> EZOLV Sets the delay time to activate the contact after the function set in H2-03 activates.	0 ms (0 - 65000 ms)	649
b4-08 (0B35) Expert	Terminal M5-M6 OFF-Delay Time	<input type="checkbox"/> V/f <input type="checkbox"/> OLV/PM <input type="checkbox"/> EZOLV Sets the delay time to deactivate the contact after the function set in H2-03 deactivates.	0 ms (0 - 65000 ms)	649

### ◆ b5: PID Control

No. (Hex.)	Name	Description	Default (Range)	Ref.
b5-01 (01A5)	PID Mode Setting	<input type="checkbox"/> V/f <input type="checkbox"/> OLV/PM <input type="checkbox"/> EZOLV Sets the type of PID control. 0 : Disabled 1 : Standard 3 : Fref + PID Trim	0 (0 - 3)	657
b5-02 (01A6) RUN	Proportional Gain (P)	<input type="checkbox"/> V/f <input type="checkbox"/> OLV/PM <input type="checkbox"/> EZOLV Sets the proportional gain (P) that is applied to PID input.	2.00 (0.00 - 25.00)	657
b5-03 (01A7) RUN	Integral Time (I)	<input type="checkbox"/> V/f <input type="checkbox"/> OLV/PM <input type="checkbox"/> EZOLV Sets the integral time (I) that is applied to PID input.	0.5 s (0.0 - 360.0 s)	657

No. (Hex.)	Name	Description	Default (Range)	Ref.
b5-04 (01A8) RUN	Integral Limit	<p><b>V/f</b> <b>OLV/PM</b> <b>EZOLV</b></p> <p>Sets the upper limit for integral control (I) as a percentage of the Maximum Output Frequency.</p> <p><b>Note:</b> Parameter <i>A1-02</i> [Control Method Selection] selects which parameter is the maximum output frequency.  <ul style="list-style-type: none"> <li>• <i>A1-02</i> ≠ 8 [EZOLV]: <i>E1-04</i> [Maximum Output Frequency]</li> <li>• <i>A1-02</i> = 8: <i>E9-02</i> [Maximum Speed]</li> </ul> </p>	100.0% (0.0 - 100.0%)	658
b5-05 (01A9) RUN	Derivative Time (D)	<p><b>V/f</b> <b>OLV/PM</b> <b>EZOLV</b></p> <p>Sets the derivative time (D) for PID control. This parameter adjusts system responsiveness.</p>	0.00 s (0.00 - 10.00 s)	658
b5-06 (01AA) RUN	PID Output Limit	<p><b>V/f</b> <b>OLV/PM</b> <b>EZOLV</b></p> <p>Sets the maximum possible output from the PID controller as a percentage of the Maximum Output Frequency.</p> <p><b>Note:</b> Parameter <i>A1-02</i> [Control Method Selection] selects which parameter is the maximum output frequency.  <ul style="list-style-type: none"> <li>• <i>A1-02</i> ≠ 8 [EZOLV]: <i>E1-04</i> [Maximum Output Frequency]</li> <li>• <i>A1-02</i> = 8: <i>E9-02</i> [Maximum Speed]</li> </ul> </p>	100.0% (0.0 - 100.0%)	658
b5-07 (01AB) RUN	PID Offset Adjustment	<p><b>V/f</b> <b>OLV/PM</b> <b>EZOLV</b></p> <p>Sets the offset for the PID control output as a percentage of the Maximum Output Frequency.</p> <p><b>Note:</b> Parameter <i>A1-02</i> [Control Method Selection] selects which parameter is the maximum output frequency.  <ul style="list-style-type: none"> <li>• <i>A1-02</i> ≠ 8 [EZOLV]: <i>E1-04</i> [Maximum Output Frequency]</li> <li>• <i>A1-02</i> = 8: <i>E9-02</i> [Maximum Speed]</li> </ul> </p>	0.0% (-100.0 - +100.0%)	658
b5-08 (01AC) RUN Expert	PID Primary Delay Time Constant	<p><b>V/f</b> <b>OLV/PM</b> <b>EZOLV</b></p> <p>Sets the primary delay time constant for the PID control output. Usually it is not necessary to change this setting.</p>	0.00 s (0.00 - 10.00 s)	658
b5-09 (01AD)	PID Output Level Selection	<p><b>V/f</b> <b>OLV/PM</b> <b>EZOLV</b></p> <p>Sets the polarity of the PID output.  0 : Normal Output (Direct Acting)  1 : Reverse Output (Reverse Acting)</p>	0 (0, 1)	658
b5-10 (01AE) RUN	PID Output Gain Setting	<p><b>V/f</b> <b>OLV/PM</b> <b>EZOLV</b></p> <p>Sets the amount of gain to apply to the PID output.</p>	1.00 (0.00 - 25.00)	659
b5-11 (01AF)	PID Output Reverse Selection	<p><b>V/f</b> <b>OLV/PM</b> <b>EZOLV</b></p> <p>Sets the function that enables and disables reverse motor rotation for negative PID control output.  0 : Lower Limit is Zero  1 : Negative Output Accepted</p>	0 (0, 1)	659
b5-17 (01B5) RUN	PID Accel/Decel Time	<p><b>V/f</b> <b>OLV/PM</b> <b>EZOLV</b></p> <p>Raises or lowers the PID setpoint using the acceleration and deceleration times set to the drive. This is a soft-starter for the PID setpoint.</p>	0.0 s (0.0 - 6000.0 s)	659
b5-28 (01EA)	PID Feedback Square Root Sel	<p><b>V/f</b> <b>OLV/PM</b> <b>EZOLV</b></p> <p>Enables and disables the square root of the PID Feedback compared to the PID Setpoint to set an appropriate drive output for the correct system regulation.  0 : Disabled  1 : Enabled</p>	0 (0, 1)	659
b5-29 (01EB)	PID Feedback Square Root Gain	<p><b>V/f</b> <b>OLV/PM</b> <b>EZOLV</b></p> <p>Sets the multiplier applied to the square root of the feedback.</p>	0.00 (0.00 - 2.00)	659
b5-30 (01EC)	PID Feedback Offset	<p><b>V/f</b> <b>OLV/PM</b> <b>EZOLV</b></p> <p>Sets PID feedback Offset as a percentage of maximum frequency.</p>	0.00% (0.00 - 100.00%)	660
b5-34 (019F) RUN	PID Output Lower Limit Level	<p><b>V/f</b> <b>OLV/PM</b> <b>EZOLV</b></p> <p>Sets the output lower limit for the PID control as a percentage of the Maximum Output Frequency.</p> <p><b>Note:</b> Parameter <i>A1-02</i> [Control Method Selection] selects which parameter is the maximum output frequency.  <ul style="list-style-type: none"> <li>• <i>A1-02</i> ≠ 8 [EZOLV]: <i>E1-04</i> [Maximum Output Frequency]</li> <li>• <i>A1-02</i> = 8: <i>E9-02</i> [Maximum Speed]</li> </ul> </p>	0.0% (-100.0 - +100.0%)	660

## 11.5 b: Application

No. (Hex.)	Name	Description	Default (Range)	Ref.
b5-35 (01A0) RUN	PID Input Limit Level	<p><b>V/f</b> <b>OLV/PM</b> <b>EZOLV</b></p> <p>Sets the output upper limit for the PID control as a percentage of the Maximum Output Frequency.</p> <p><b>Note:</b> Parameter <i>A1-02</i> [Control Method Selection] selects which parameter is the maximum output frequency.  <ul style="list-style-type: none"> <li>• <i>A1-02</i> ≠ 8 [EZOLV]: <i>E1-04</i> [Maximum Output Frequency]</li> <li>• <i>A1-02</i> = 8: <i>E9-02</i> [Maximum Speed]</li> </ul> </p>	1000.0% (0.0 - 1000.0%)	660
b5-38 (01FE)	PID User Unit Display Scaling	<p><b>V/f</b> <b>OLV/PM</b> <b>EZOLV</b></p> <p>Sets the value that the drive sets or shows as the PID setpoint when at the maximum output frequency.</p>	100.00 (0.01 - 600.00)	660
b5-39 (01FF)	PID User Unit Display Digits	<p><b>V/f</b> <b>OLV/PM</b> <b>EZOLV</b></p> <p>Sets the number of digits to set and show the PID setpoint.</p> <p>0 : No Decimal Places (XXXXX)            1 : One Decimal Places (XXXX.X)            2 : Two Decimal Places (XXX.XX)            3 : Three Decimal Places (XX.XXX)</p>	2 (0 - 3)	660
b5-41 (0160)	PID Output 2 Unit	<p><b>V/f</b> <b>OLV/PM</b> <b>EZOLV</b></p> <p>Sets the display units in <i>U5-14</i> [PID Out2 Upr4 Digits] and <i>U5-15</i> [PID Out2 Lwr4 Digits].</p> <p>0 : "WC: inches of water column            1 : PSI: pounds per square inch            2 : GPM: gallons/min            3 : °F: Fahrenheit            4 : ft³/min: cubic feet/min            5 : m³/h: cubic meters/hour            6 : L/h: liters/hour            7 : L/s: liters/sec            8 : bar: bar            9 : Pa: Pascal            10 : °C: Celsius            11 : m: meters            12 : ft: feet            13 : L/min: liters/min            14 : m³/min: cubic meters/min            15 : "Hg: Inch Mercury            16 : kPa: kilopascal            48 : %: Percent            49 : Custom(b5-68~70)            50 : None</p>	0 (0 - 50)	660
b5-42 (0161) RUN	PID Output 2 Calc Mode	<p><b>V/f</b> <b>OLV/PM</b> <b>EZOLV</b></p> <p>Sets how to calculate the original PID output.</p> <p>0 : Linear            1 : Square Root            2 : Quadratic            3 : Cubic</p> <p><b>Note:</b> Used for <i>U5-14</i> [PID Out2 Upr4 Digits] and <i>U5-15</i> [PID Out2 Lwr4 Digits] only.</p>	0 (0 - 3)	661
b5-43 (0162) RUN	PID Out2 Monitor MAX Upper4 Dig	<p><b>V/f</b> <b>OLV/PM</b> <b>EZOLV</b></p> <p>Sets the upper 4 digits of the maximum monitor value. Used with <i>b5-44</i> [PID Out2 Monitor MAX Lower4 Dig] to set maximum monitor value of <i>U5-14</i> [PID Out2 Upr4 Digits] and <i>U5-15</i> [PID Out2 Lwr4 Digits] at maximum frequency.</p> <p><b>Note:</b> Used for <i>U5-14</i> [PID Out2 Upr4 Digits] and <i>U5-15</i> [PID Out2 Lwr4 Digits] only.</p>	0 (0 - 9999)	661
b5-44 (0163) RUN	PID Out2 Monitor MAX Lower4 Dig	<p><b>V/f</b> <b>OLV/PM</b> <b>EZOLV</b></p> <p>Sets the lower 4 digits of the maximum monitor value. Used with <i>b5-43</i> [PID Out2 Monitor MAX Upper4 Dig] to set maximum monitor value of <i>U5-14</i> [PID Out2 Upr4 Digits] and <i>U5-15</i> [PID Out2 Lwr4 Digits] at maximum frequency.</p> <p><b>Note:</b> Used for <i>U5-14</i> [PID Out2 Upr4 Digits] and <i>U5-15</i> [PID Out2 Lwr4 Digits] only.</p>	0.00 (0.00 - 99.99)	662
b5-45 (0164) RUN	PID Out2 Monitor MIN for Linear	<p><b>V/f</b> <b>OLV/PM</b> <b>EZOLV</b></p> <p>Sets the minimum display value to show when at zero speed. Only effective when <i>b5-42</i> = 0 [PID Output 2 Calc Mode = Linear].</p> <p><b>Note:</b> Used for <i>U5-14</i> [PID Out2 Upr4 Digits] and <i>U5-15</i> [PID Out2 Lwr4 Digits] only.</p>	0.0 (0.0 - 999.9)	662

No. (Hex.)	Name	Description	Default (Range)	Ref.
b5-46 (0165)	PID Unit Display Selection	<p><b>V/f</b> <b>OLV/PM</b> <b>EZOLV</b></p> <p>Sets the units-text for the PID Display.</p> <p>0 : "WC: inches of water column  1 : PSI: pounds per square inch  2 : GPM: gallons/min  3 : °F: Fahrenheit  4 : ft³/min: cubic feet/min  5 : m³/h: cubic meters/hour  6 : L/h: liters/hour  7 : L/s: liters/sec  8 : bar: bar  9 : Pa: Pascal  10 : °C: Celsius  11 : m: meters  12 : ft: feet  13 : L/min: liters/min  14 : m³/min: cubic meters/min  15 : "Hg: Inch Mercury  16 : kPa: kilopascal  48 : %: Percent  49 : Custom(b5-68~70)  50 : None</p>	48 (0 - 50)	662
b5-53 (0B8F) RUN	PID Integrator Ramp Limit	<p><b>V/f</b> <b>OLV/PM</b> <b>EZOLV</b></p> <p>Sets the responsiveness of PID control when the PID feedback changes quickly.</p>	0.0 Hz (0.0 - 10.0 Hz)	663
b5-61 (119A)	PID Trim Mode Lower Limit Sel	<p><b>V/f</b> <b>OLV/PM</b> <b>EZOLV</b></p> <p>Sets the function that adjusts the PID output in relation to the frequency reference.</p> <p>0 : Disabled  1 : Enabled</p>	0 (0, 1)	663
b5-62 (119B)	PID Trim Mode Lower Limit Value	<p><b>V/f</b> <b>OLV/PM</b> <b>EZOLV</b></p> <p>Sets the PID Trim Mode Lower Limit Value as a percentage of the maximum output frequency.</p> <p><b>Note:</b>  Parameter A1-02 [Control Method Selection] selects which parameter is the maximum output frequency.  • A1-02 ≠ 8 [EZOLV]: E1-04 [Maximum Output Frequency]  • A1-02 = 8: E9-02 [Maximum Speed]</p>	0.00% (0.00 - 100.00%)	663
b5-68 (3C1F)	System Unit Custom Character 1	<p><b>V/f</b> <b>OLV/PM</b> <b>EZOLV</b></p> <p>Sets the first character of the custom unit display when b5-46 = 49 [PID Unit Display Selection = Custom (B5-68~70)] or when b5-41 = 49 [PID Output 2 Unit = Custom (B5-68~70)].</p>	41 (20 - 7A)	663
b5-69 (3C20)	System Unit Custom Character 2	<p><b>V/f</b> <b>OLV/PM</b> <b>EZOLV</b></p> <p>Sets the second character of the custom unit display when b5-46 = 49 [PID Unit Display Selection = Custom (B5-68~70)] or when b5-41 = 49 [PID Output 2 Unit = Custom (B5-68~70)].</p>	41 (20 - 7A)	664
b5-70 (3C21)	System Unit Custom Character 3	<p><b>V/f</b> <b>OLV/PM</b> <b>EZOLV</b></p> <p>Sets the third character of the custom unit display when b5-46 = 49 [PID Unit Display Selection = Custom (B5-68~70)] or when b5-41 = 49 [PID Output 2 Unit = Custom (B5-68~70)].</p>	41 (20 - 7A)	664
b5-71 (3C22)	Min PID Transducer Scaling	<p><b>V/f</b> <b>OLV/PM</b> <b>EZOLV</b></p> <p>Sets the minimum PID level corresponding to the lowest analog input signal level.</p> <p><b>Note:</b>  • To enable this parameter, you must set b5-71 &lt; b5-38 [PID User Unit Display Scaling]. If you set b5-71 &gt; b5-38, the drive will disable all PID analog inputs.  • Parameters b5-46 [PID Unit Display Selection], b5-38, and b5-39 [PID User Unit Display Digits] set the unit, scaling, and resolution.</p>	0.00 (-99.99 - +99.99)	664
b5-82 (31B0)	Feedback Loss 4 ~ 20mA Detect Sel	<p><b>V/f</b> <b>OLV/PM</b> <b>EZOLV</b></p> <p>Sets the drive to do a 4 to 20 mA wire-break detection on the analog input set for PID feedback.</p> <p>0 : Disabled  1 : Alarm Only  2 : Fault  3 : Run At b5-83</p>	2 (0 - 3)	665

## 11.5 b: Application

No. (Hex.)	Name	Description	Default (Range)	Ref.
b5-83 (31B1) RUN	Feedback Loss GoTo Frequency	<p><b>V/f</b> <b>OLV/PM</b> <b>EZOLV</b></p> <p>Sets the speed at which the drive will run if the drive detects a 4 to 20 mA wire-break on the PID Feedback and <math>b5-82 = 3</math> [Feedback Loss 4 ~ 20mA Detect Sel = Run At b5-83].</p> <p><b>Note:</b> When <math>A1-02 = 8</math> [Control Method Selection = EZ Vector Control], the range is 0.0 to 120.0 Hz.</p>	0.0 Hz (0.0 - 400.0 Hz)	667
b5-84 (31B2) RUN	Feedback Loss Loss Of Prime Lvl	<p><b>V/f</b> <b>OLV/PM</b> <b>EZOLV</b></p> <p>Sets the level at which the drive will detect Loss of Prime in the pump.</p> <p><b>Note:</b></p> <ul style="list-style-type: none"> <li>Loss of Prime condition occurs when the measured quantity set by <math>Y1-18</math> [Prime Loss Detection Method] decreases to this level for the time set in <math>Y1-20</math> [Loss of Prime Time] and the output frequency is at the <math>Y4-02</math> [Pre-Charge Frequency] level.</li> <li>The drive will respond to the Loss of Prime condition as specified by <math>Y1-22</math> [Loss of Prime Selection].</li> <li>Display unit and scaling are dependent on System Units.</li> </ul>	0.0 A (0.0 - 1000.0 A)	667
b5-85 (31B3) RUN	Feedback Loss GoTo Freq Timeout	<p><b>V/f</b> <b>OLV/PM</b> <b>EZOLV</b></p> <p>When <math>b5-82 = 3</math> [Feedback Loss 4 ~ 20mA Detect Sel = Run At b5-83] and the Feedback signal is lost, the drive will run at the <math>b5-83</math> [Feedback Loss Goto Frequency] speed for this length of time, after which the drive will fault on <math>FDBKL</math> [WIRE Break].</p> <p><b>Note:</b> Set this parameter to 0 s to disable the function.</p>	0 s (0 - 6000 s)	668
b5-86 (31B4) RUN	Feedback Loss Start Delay	<p><b>V/f</b> <b>OLV/PM</b> <b>EZOLV</b></p> <p>When you initiate an AUTO Run command, the drive will wait for this length of time before it will fault on <math>FDBKL</math> [WIRE Break] or use parameter <math>b5-83</math> [Feedback Loss Goto Frequency].</p>	0.0 s (0.0 - 120.0 s)	668

## ◆ b8: Energy Saving

No. (Hex.)	Name	Description	Default (Range)	Ref.
b8-01 (01CC)	Energy Saving Control Selection	<p><b>V/f</b> <b>OLV/PM</b> <b>EZOLV</b></p> <p>Sets the Energy-saving control function.</p> <p>0 : Disabled 1 : Enabled</p>	0 (0, 1)	668
b8-04 (01CF) Expert	Energy Saving Coefficient Value	<p><b>V/f</b> <b>OLV/PM</b> <b>EZOLV</b></p> <p>Sets the Energy-saving control coefficient to maintain maximum motor efficiency. The default setting is for Yaskawa motors.</p> <p><b>Note:</b></p> <ul style="list-style-type: none"> <li>When you do Rotational Auto-Tuning, the drive will automatically set the energy-saving coefficient.</li> <li>The minimum values and the maximum values are different for different drive models. -2011 to 2024, 4005 and 4008: 0.0 - 2000.0 -2031 to 2273, 4011 to 4302: 0.00 - 655.00</li> </ul>	Determined by E2-11 and o2-04 (0.00 - 655.00)	668
b8-05 (01D0) Expert	Power Detection Filter Time	<p><b>V/f</b> <b>OLV/PM</b> <b>EZOLV</b></p> <p>Sets the time constant to measure output power.</p>	20 ms (0 - 2000 ms)	669
b8-06 (01D1) Expert	Search Operation Voltage Limit	<p><b>V/f</b> <b>OLV/PM</b> <b>EZOLV</b></p> <p>Sets the voltage limit for Search Operation as a percentage of the motor rated voltage.</p>	0% (0 - 100%)	669
b8-19 (0B40) Expert	E-Save Search Frequency	<p><b>V/f</b> <b>OLV/PM</b> <b>EZOLV</b></p> <p>Sets the frequency of Energy-saving control search operations. Usually it is not necessary to change this setting.</p>	Determined by A1-02 (10 - 300 Hz)	669
b8-20 (0B41) Expert	E-Save Search Width	<p><b>V/f</b> <b>OLV/PM</b> <b>EZOLV</b></p> <p>Sets the amplitude of Energy-saving control search operations.</p>	1.0 degrees (0.1 - 5.0 degrees)	669

No. (Hex.)	Name	Description	Default (Range)	Ref.
b8-28 (0B8B) Expert	Over Excitation Action Selection	<div style="display: flex; justify-content: space-between; align-items: center;"> <span>V/f</span> <span>OLV/PM</span> <span style="background-color: black; color: white; padding: 2px;">EZOLV</span> </div> Sets the function for excitation operation. 0 : Disabled 1 : Enabled	0 (0, 1)	670
b8-29 (0B8C)	Energy Saving Priority Selection	<div style="display: flex; justify-content: space-between; align-items: center;"> <span>V/f</span> <span>OLV/PM</span> <span style="background-color: black; color: white; padding: 2px;">EZOLV</span> </div> Sets the priority of drive response between changes to the load or Energy-saving control. Enable this to prioritize energy-saving control. Disable this to prioritize tracking related to fast load changes, and prevent motor stall. 0 : Priority: Drive Response 1 : Priority: Energy Savings	0 (0, 1)	670

## 11.6 C: Tuning

### ◆ C1: Accel & Decel Time

No. (Hex.)	Name	Description	Default (Range)	Ref.
C1-01 (0200) RUN	Acceleration Time 1	<b>V/f</b> <b>OLV/PM</b> <b>EZOLV</b> Sets the length of time to accelerate from zero to maximum output frequency.	30.0 s (0.1 - 6000.0 s)	672
C1-02 (0201) RUN	Deceleration Time 1	<b>V/f</b> <b>OLV/PM</b> <b>EZOLV</b> Sets the length of time to decelerate from maximum output frequency to zero.	30.0 s (0.1 - 6000.0 s)	672
C1-03 (0202) RUN	Acceleration Time 2	<b>V/f</b> <b>OLV/PM</b> <b>EZOLV</b> Sets the length of time to accelerate from zero to maximum output frequency.	30.0 s (0.1 - 6000.0 s)	672
C1-04 (0203) RUN	Deceleration Time 2	<b>V/f</b> <b>OLV/PM</b> <b>EZOLV</b> Sets the length of time to decelerate from maximum output frequency to zero.	30.0 s (0.1 - 6000.0 s)	673
C1-05 (0204) RUN	Acceleration Time 3	<b>V/f</b> <b>OLV/PM</b> <b>EZOLV</b> Sets the length of time to accelerate from zero to maximum output frequency.	30.0 s (0.1 - 6000.0 s)	673
C1-06 (0205) RUN	Deceleration Time 3	<b>V/f</b> <b>OLV/PM</b> <b>EZOLV</b> Sets the length of time to decelerate from maximum output frequency to zero.	30.0 s (0.1 - 6000.0 s)	673
C1-07 (0206) RUN	Acceleration Time 4	<b>V/f</b> <b>OLV/PM</b> <b>EZOLV</b> Sets the length of time to accelerate from zero to maximum output frequency.	30.0 s (0.1 - 6000.0 s)	673
C1-08 (0207) RUN	Deceleration Time 4	<b>V/f</b> <b>OLV/PM</b> <b>EZOLV</b> Sets the length of time to decelerate from maximum output frequency to zero.	30.0 s (0.1 - 6000.0 s)	673
C1-09 (0208) RUN	Fast Stop Time	<b>V/f</b> <b>OLV/PM</b> <b>EZOLV</b> Sets the length of time that the drive will decelerate to zero for a Fast Stop. <b>Note:</b> If you decelerate the drive too quickly, the drive will detect an <i>ov</i> [Overvoltage] fault and shut off the output, and the motor will coast to stop. To prevent motor coasting and stop the motor quickly and safely, make sure to set a Fast Stop time in <i>C1-09</i> .	10.0 s (0.1 - 6000.0 s)	673

### ◆ C2: S-Curve Characteristics

No. (Hex.)	Name	Description	Default (Range)	Ref.
C2-01 (020B)	S-Curve Time @ Start of Accel	<b>V/f</b> <b>OLV/PM</b> <b>EZOLV</b> Sets the S-curve acceleration time at start.	Determined by A1-02 (0.00 - 10.00 s)	674
C2-02 (020C)	S-Curve Time @ End of Accel	<b>V/f</b> <b>OLV/PM</b> <b>EZOLV</b> Sets the S-curve acceleration time at completion.	0.20 s (0.00 - 10.00 s)	674
C2-03 (020D)	S-Curve Time @ Start of Decel	<b>V/f</b> <b>OLV/PM</b> <b>EZOLV</b> Sets the S-curve deceleration time at start.	0.20 s (0.00 - 10.00 s)	674
C2-04 (020E)	S-Curve Time @ End of Decel	<b>V/f</b> <b>OLV/PM</b> <b>EZOLV</b> Sets the S-curve deceleration time at completion.	0.00 s (0.00 - 10.00 s)	674



### ◆ C3: Slip Compensation

No. (Hex.)	Name	Description	Default (Range)	Ref.
C3-01 (020F) RUN	Slip Compensation Gain	<p><b>V/f</b> <b>OLV/PM</b> <b>EZOLV</b></p> <p>Sets the gain for the slip compensation function. Usually it is not necessary to change this setting.</p> <p><b>Note:</b> Correctly set these parameters before you change the slip compensation gain:</p> <ul style="list-style-type: none"> <li>• E2-01 [Motor Rated Current (FLA)]</li> <li>• E2-02 [Motor Rated Slip]</li> <li>• E2-03 [Motor No-Load Current]</li> </ul>	0.0 (0.0 - 2.5)	675
C3-02 (0210) RUN	Slip Compensation Delay Time	<p><b>V/f</b> <b>OLV/PM</b> <b>EZOLV</b></p> <p>Sets the slip compensation delay time when speed is unstable or when the slip compensation response is too slow. Usually it is not necessary to change this setting.</p>	Determined by A1-02 (0 - 10000 ms)	675
C3-21 (033E) RUN	Motor 2 Slip Compensation Gain	<p><b>V/f</b> <b>OLV/PM</b> <b>EZOLV</b></p> <p>Sets the gain for the motor 2 slip compensation function. Usually it is not necessary to change this setting.</p> <p><b>Note:</b> Correctly set these parameters before you change the slip compensation gain:</p> <ul style="list-style-type: none"> <li>• E4-01 [Motor 2 Rated Current]</li> <li>• E4-02 [Motor 2 Rated Slip]</li> <li>• E4-03 [Motor 2 Rated No-Load Current]</li> </ul>	0.0 (0.0 - 2.5)	675
C3-22 (0241) RUN	Motor 2 Slip Comp Delay Time	<p><b>V/f</b> <b>OLV/PM</b> <b>EZOLV</b></p> <p>Sets the slip compensation delay time for motor 2 when speed is unstable or when the slip compensation response is too slow. Usually it is not necessary to change this setting.</p>	2000 (0 - 10000 ms)	675
C3-29 (1B5D) RUN Expert	Slip Compensation Gain @ Low Spd	<p><b>V/f</b> <b>OLV/PM</b> <b>EZOLV</b></p> <p>Sets the slip compensation gain at low speed. Usually it is not necessary to change this setting.</p>	0.0 (0.0 - 2.5)	676

### ◆ C4: Torque Compensation

No. (Hex.)	Name	Description	Default (Range)	Ref.
C4-01 (0215) RUN	Torque Compensation Gain	<p><b>V/f</b> <b>OLV/PM</b> <b>EZOLV</b></p> <p>Sets the gain for the torque compensation function. Use this parameter value for motor 1 when you operate multiple motors.</p> <p><b>Note:</b> If A1-02 = 8 [Control Method Selection = EZOLV], you cannot change the setting while the drive is running.</p>	Determined by A1-02 (0.00 - 2.50)	676
C4-02 (0216) RUN	Torque Compensation Delay Time	<p><b>V/f</b> <b>OLV/PM</b> <b>EZOLV</b></p> <p>Sets the torque compensation delay time. Usually it is not necessary to change this setting.</p> <p><b>Note:</b> If A1-02 = 5, 8 [Control Method Selection = OLV/PM, EZOLV], you cannot change the setting while the drive is running.</p>	Determined by A1-02 (0 - 60000 ms)	676
C4-07 (0341) RUN	Motor 2 Torque Compensation Gain	<p><b>V/f</b> <b>OLV/PM</b> <b>EZOLV</b></p> <p>Sets the gain for motor 2 torque compensation function when you use the Motor Switch function.</p>	1.00 (0.00 - 2.50)	677
C4-23 (1583) Expert	Current Control Gain	<p><b>V/f</b> <b>OLV/PM</b> <b>EZOLV</b></p> <p>Current control gain. Usually it is not necessary to change this parameter.</p>	1.00 (0.50 - 2.50)	677

## ◆ C5: Auto Speed Regulator (ASR)

No. (Hex.)	Name	Description	Default (Range)	Ref.
C5-01 (021B) RUN	ASR Proportional Gain 1	<input type="checkbox"/> V/f <input type="checkbox"/> OLV/PM <input checked="" type="checkbox"/> EZOLV Sets the gain to adjust ASR response.	Determined by A1-02 (0.00 - 300.00)	679
C5-02 (021C) RUN	ASR Integral Time 1	<input type="checkbox"/> V/f <input type="checkbox"/> OLV/PM <input checked="" type="checkbox"/> EZOLV Sets the ASR integral time.	Determined by A1-02 (0.000 - 60.000 s)	680
C5-03 (021D) RUN	ASR Proportional Gain 2	<input type="checkbox"/> V/f <input type="checkbox"/> OLV/PM <input checked="" type="checkbox"/> EZOLV Sets the gain to adjust ASR response.	Determined by A1-02 (0.00 - 300.00)	680
C5-04 (021E) RUN	ASR Integral Time 2	<input type="checkbox"/> V/f <input type="checkbox"/> OLV/PM <input checked="" type="checkbox"/> EZOLV Sets the ASR integral time.	Determined by A1-02 (0.000 - 60.000 s)	680
C5-06 (0220)	ASR Delay Time	<input type="checkbox"/> V/f <input type="checkbox"/> OLV/PM <input checked="" type="checkbox"/> EZOLV Sets the filter time constant of the torque reference output from the speed loop. Usually it is not necessary to change this setting.	Determined by A1-02 (0.000 - 0.500 s)	680
C5-07 (0221)	ASR Gain Switchover Frequency	<input type="checkbox"/> V/f <input type="checkbox"/> OLV/PM <input checked="" type="checkbox"/> EZOLV Sets the frequency where the drive will switch between these parameters: C5-01 and C5-03 [ASR Proportional Gain 1/2] C5-02 and C5-04 [ASR Integral Time 1/2]	Determined by A1-02 (Determined by A1-02)	680
C5-08 (0222)	ASR Integral Limit	<input type="checkbox"/> V/f <input type="checkbox"/> OLV/PM <input checked="" type="checkbox"/> EZOLV Set the upper limit of the ASR integral amount as a percentage of the rated load.	400% (0 - 400%)	681

## ◆ C6: Carrier Frequency

No. (Hex.)	Name	Description	Default (Range)	Ref.
C6-02 (0224)	Carrier Frequency Selection	<input type="checkbox"/> V/f <input type="checkbox"/> OLV/PM <input checked="" type="checkbox"/> EZOLV Sets the carrier frequency for the transistors in the drive. 1 : 2.0 kHz 2 : 5.0 kHz 3 : 8.0 kHz 4 : 10.0 kHz 5 : 12.5 kHz 7 : Swing PWM1 (Audible Sound 1) 8 : Swing PWM2 (Audible Sound 2) 9 : Swing PWM3 (Audible Sound 3) A : Swing PWM4 (Audible Sound 4) B : Leakage Current Rejection PWM F : User Defined (C6-03 to C6-05) <b>Note:</b> • The carrier frequency for Swing PWM 1 to 4 is equivalent to 2.0 kHz. Swing PWM applies a special PWM pattern to decrease the audible noise. • When A1-02 = 5 or 8 [Control Method Selection = OLV/PM or EZOLV], you cannot set to 7 to A • Setting B uses a PWM pattern that decreases the leakage current that the drive detects over long wiring distances. This can help decrease alarm detection and decrease problems with the current monitor from leakage current over long wiring distances.	Determined by A1-02 and o2-04 (Determined by A1-02)	681
C6-03 (0225)	Carrier Frequency Upper Limit	<input type="checkbox"/> V/f <input type="checkbox"/> OLV/PM <input checked="" type="checkbox"/> EZOLV Sets the upper limit of the carrier frequency. Set C6-02 = F [Carrier Frequency Selection = User Defined (C6-03 to C6-05)] to set this parameter.	Determined by C6-02 (1.0 - 12.5 kHz)	682
C6-04 (0226)	Carrier Frequency Lower Limit	<input type="checkbox"/> V/f <input type="checkbox"/> OLV/PM <input checked="" type="checkbox"/> EZOLV Sets the lower limit of the carrier frequency. Set C6-02 = F [Carrier Frequency Selection = User Defined (C6-03 to C6-05)] to set this parameter.	Determined by C6-02 (1.0 - 12.5 kHz)	683
C6-05 (0227)	Carrier Freq Proportional Gain	<input type="checkbox"/> V/f <input type="checkbox"/> OLV/PM <input checked="" type="checkbox"/> EZOLV Sets the proportional gain for the carrier frequency. Set C6-02 = F [Carrier Frequency Selection = User Defined (C6-03 to C6-05)] to set this parameter.	Determined by C6-02 (0 - 99)	683

## 11.7 d: Reference Settings

### ◆ d1: Frequency Reference

No. (Hex.)	Name	Description	Default (Range)	Ref.
d1-01 (0280) RUN	Reference 1	<b>V/f</b> <b>OLV/PM</b> <b>EZOLV</b> Sets the frequency reference in the units from <i>o1-03</i> [Frequency Display Unit Selection].	0.00 Hz (0.00 - 400.00 Hz)	686
d1-02 (0281) RUN	Reference 2	<b>V/f</b> <b>OLV/PM</b> <b>EZOLV</b> Sets the frequency reference in the units from <i>o1-03</i> [Frequency Display Unit Selection].	0.00 Hz (0.00 - 400.00 Hz)	687
d1-03 (0282) RUN	Reference 3	<b>V/f</b> <b>OLV/PM</b> <b>EZOLV</b> Sets the frequency reference in the units from <i>o1-03</i> [Frequency Display Unit Selection].	0.00 Hz (0.00 - 400.00 Hz)	687
d1-04 (0283) RUN	Reference 4	<b>V/f</b> <b>OLV/PM</b> <b>EZOLV</b> Sets the frequency reference in the units from <i>o1-03</i> [Frequency Display Unit Selection].	0.00 Hz (0.00 - 400.00 Hz)	687
d1-05 (0284) RUN	Reference 5	<b>V/f</b> <b>OLV/PM</b> <b>EZOLV</b> Sets the frequency reference in the units from <i>o1-03</i> [Frequency Display Unit Selection].	0.00 Hz (0.00 - 400.00 Hz)	687
d1-06 (0285) RUN	Reference 6	<b>V/f</b> <b>OLV/PM</b> <b>EZOLV</b> Sets the frequency reference in the units from <i>o1-03</i> [Frequency Display Unit Selection].	0.00 Hz (0.00 - 400.00 Hz)	687
d1-07 (0286) RUN	Reference 7	<b>V/f</b> <b>OLV/PM</b> <b>EZOLV</b> Sets the frequency reference in the units from <i>o1-03</i> [Frequency Display Unit Selection].	0.00 Hz (0.00 - 400.00 Hz)	688
d1-08 (0287) RUN	Reference 8	<b>V/f</b> <b>OLV/PM</b> <b>EZOLV</b> Sets the frequency reference in the units from <i>o1-03</i> [Frequency Display Unit Selection].	0.00 Hz (0.00 - 400.00 Hz)	688
d1-17 (0292) RUN	Jog Reference	<b>V/f</b> <b>OLV/PM</b> <b>EZOLV</b> Sets the Jog frequency reference in the units from <i>o1-03</i> [Frequency Display Unit Selection]. Set <i>H1-xx = 6</i> [MFDDI Function Selection = Jog Reference Selection] to use the Jog frequency reference.	6.00 Hz (0.00 - 400.00 Hz)	688

### ◆ d2: Reference Limits

No. (Hex.)	Name	Description	Default (Range)	Ref.
d2-01 (0289)	Frequency Reference Upper Limit	<b>V/f</b> <b>OLV/PM</b> <b>EZOLV</b> Sets maximum limit for all frequency references. The maximum output frequency is 100%. <b>Note:</b> Parameter <i>A1-02</i> [Control Method Selection] selects which parameter is the maximum output frequency. • <i>A1-02</i> ≠ 8 [EZOLV]: <i>E1-04</i> [Maximum Output Frequency] • <i>A1-02</i> = 8: <i>E9-02</i> [Motor Max Revolutions]	100.0% (0.0 - 110.0%)	689
d2-02 (028A)	Frequency Reference Lower Limit	<b>V/f</b> <b>OLV/PM</b> <b>EZOLV</b> Sets minimum limit for all frequency references. The maximum output frequency is 100%. <b>Note:</b> Parameter <i>A1-02</i> [Control Method Selection] selects which parameter is the maximum output frequency. • <i>A1-02</i> ≠ 8 [EZOLV]: <i>E1-04</i> [Maximum Output Frequency] • <i>A1-02</i> = 8: <i>E9-02</i> [Motor Max Revolutions]	0.0% (0.0 - 110.0%)	689
d2-03 (0293)	Analog Frequency Ref Lower Limit	<b>V/f</b> <b>OLV/PM</b> <b>EZOLV</b> Sets the lower limit for the master frequency reference (the first frequency of the multi-step speed reference) as a percentage. The maximum output frequency is 100%. <b>Note:</b> Parameter <i>A1-02</i> [Control Method Selection] selects which parameter is the maximum output frequency. • <i>A1-02</i> ≠ 8: <i>E1-04</i> [Maximum Output Frequency] • <i>A1-02</i> = 8: <i>E9-02</i> [Maximum Speed]	0.0% (0.0 - 110.0%)	689

## ◆ d3: Jump Frequency

No. (Hex.)	Name	Description	Default (Range)	Ref.
d3-01 (0294)	Jump Frequency 1	<input type="checkbox"/> V/f <input type="checkbox"/> OLV/PM <input type="checkbox"/> EZOLV Sets the median value of the frequency band that the drive will avoid.	0.0 Hz (0.0 - 400.0 Hz)	690
d3-02 (0295)	Jump Frequency 2	<input type="checkbox"/> V/f <input type="checkbox"/> OLV/PM <input type="checkbox"/> EZOLV Sets the median value of the frequency band that the drive will avoid.	0.0 Hz (0.0 - 400.0 Hz)	690
d3-03 (0296)	Jump Frequency 3	<input type="checkbox"/> V/f <input type="checkbox"/> OLV/PM <input type="checkbox"/> EZOLV Sets the median value of the frequency band that the drive will avoid.	0.0 Hz (0.0 - 400.0 Hz)	690
d3-04 (0297)	Jump Frequency Width	<input type="checkbox"/> V/f <input type="checkbox"/> OLV/PM <input type="checkbox"/> EZOLV Sets the width of the frequency band that the drive will avoid.	1.0 Hz (Determined by A1-02)	690

## ◆ d4: Frequency Ref Up/Down &amp; Hold

No. (Hex.)	Name	Description	Default (Range)	Ref.
d4-01 (0298)	Freq Reference Hold Selection	<input type="checkbox"/> V/f <input type="checkbox"/> OLV/PM <input type="checkbox"/> EZOLV Sets the function that saves the frequency reference after a Stop command or when de-energizing the drive. Set H1-xx [MFDD Function Selection] to one of these values to enable this parameter: • A [Accel/Decel Ramp Hold] • 10/11 [Up/Down Command] 0 : Disabled 1 : Enabled	0 (0, 1)	691
d4-10 (02B6)	Up/Down Freq Lower Limit Select	<input type="checkbox"/> V/f <input type="checkbox"/> OLV/PM <input type="checkbox"/> EZOLV Sets the lower frequency limit for the Up/Down function. 0 : Greater of d2-02 or Analog 1 : d2-02	0 (0, 1)	692

## ◆ d6: Field Weakening

No. (Hex.)	Name	Description	Default (Range)	Ref.
d6-01 (02A0)	Field Weakening Level	<input type="checkbox"/> V/f <input type="checkbox"/> OLV/PM <input type="checkbox"/> EZOLV Sets the drive output voltage as a percentage of E1-05 [Maximum Output Voltage] when H1-xx = 63 [Field Weakening] is activated.	80% (0 - 100%)	692
d6-02 (02A1)	Field Weakening Frequency Limit	<input type="checkbox"/> V/f <input type="checkbox"/> OLV/PM <input type="checkbox"/> EZOLV Sets the minimum output frequency to start field weakening.	0.0 Hz (0.0 - 400.0 Hz)	692

## ◆ d7: Offset Frequency

No. (Hex.)	Name	Description	Default (Range)	Ref.
d7-01 (02B2) RUN	Offset Frequency 1	<p><b>V/f</b> <b>OLV/PM</b> <b>EZOLV</b></p> <p>Uses <math>H1-xx = 44</math> [MFDI Function Select = Add Offset Frequency 1 (d7-01)] as a percentage of the Maximum Output Frequency to add or subtract the set frequency to/from the frequency reference.</p> <p><b>Note:</b> Parameter <math>A1-02</math> [Control Method Selection] selects which parameter is the maximum output frequency.  <ul style="list-style-type: none"> <li>• <math>A1-02 \neq 8</math> [EZOLV]: <math>E1-04</math> [Maximum Output Frequency]</li> <li>• <math>A1-02 = 8</math>: <math>E9-02</math> [Maximum Speed]</li> </ul> </p>	0.0% (-100.0 - +100.0%)	693
d7-02 (02B3) RUN	Offset Frequency 2	<p><b>V/f</b> <b>OLV/PM</b> <b>EZOLV</b></p> <p>Uses <math>H1-xx = 45</math> [MFDI Function Select = Add Offset Frequency 2 (d7-02)] as a percentage of the Maximum Output Frequency to add or subtract the set frequency to/from the frequency reference.</p> <p><b>Note:</b> Parameter <math>A1-02</math> [Control Method Selection] selects which parameter is the maximum output frequency.  <ul style="list-style-type: none"> <li>• <math>A1-02 \neq 8</math> [EZOLV]: <math>E1-04</math> [Maximum Output Frequency]</li> <li>• <math>A1-02 = 8</math>: <math>E9-02</math> [Maximum Speed]</li> </ul> </p>	0.0% (-100.0 - +100.0%)	693
d7-03 (02B4) RUN	Offset Frequency 3	<p><b>V/f</b> <b>OLV/PM</b> <b>EZOLV</b></p> <p>Uses <math>H1-xx = 46</math> [MFDI Function Select = Add Offset Frequency 3 (d7-03)] as a percentage of the Maximum Output Frequency to add or subtract the set frequency to/from the frequency reference.</p> <p><b>Note:</b> Parameter <math>A1-02</math> [Control Method Selection] selects which parameter is the maximum output frequency.  <ul style="list-style-type: none"> <li>• <math>A1-02 \neq 8</math> [EZOLV]: <math>E1-04</math> [Maximum Output Frequency]</li> <li>• <math>A1-02 = 8</math>: <math>E9-02</math> [Maximum Speed]</li> </ul> </p>	0.0% (-100.0 - +100.0%)	693

## 11.8 E: Motor Parameters

### ◆ E1: V/f Pattern for Motor 1

No. (Hex.)	Name	Description	Default (Range)	Ref.
E1-01 (0300)	Input AC Supply Voltage	<p><b>V/f</b> <b>OLV/PM</b> <b>EZOLV</b></p> <p>Sets the drive input voltage.</p> <p><b>NOTICE: Damage to Equipment. Set E1-01 [Input AC Supply Voltage] to align with the drive input voltage (not motor voltage). If this parameter is incorrect, the protective functions of the drive will not operate correctly and it can cause damage to the drive.</b></p>	208 V Class: 240 V, 480 V Class: 480 V (208 V Class: 155 - 255 V, 480 V Class: 310 - 510 V)	695
E1-03 (0302)	V/f Pattern Selection	<p><b>V/f</b> <b>OLV/PM</b> <b>EZOLV</b></p> <p>Sets the V/f pattern for the drive and motor. You can use one of the preset patterns or you can make a custom pattern.</p> <p>0 : Const Trq, 50Hz base, 50Hz max 1 : Const Trq, 60Hz base, 60Hz max 2 : Const Trq, 50Hz base, 60Hz max 3 : Const Trq, 60Hz base, 72Hz max 4 : VT, 50Hz, 65% Vmid reduction 5 : VT, 50Hz, 50% Vmid reduction 6 : VT, 60 Hz, 65% Vmid reduction 7 : VT, 60Hz, 50% Vmid reduction 8 : High Trq, 50Hz, 25% Vmin boost 9 : High Trq, 50Hz, 65% Vmin boost A : High Trq, 60Hz, 25% Vmin boost B : High Trq, 60Hz, 65% Vmin boost C : High Freq, 60Hz base, 90Hz max D : High Freq, 60Hz base, 120Hz max E : High Freq, 60Hz base, 180Hz max F : Custom</p> <p><b>Note:</b></p> <ul style="list-style-type: none"> <li>Set the correct V/f pattern for the application and operation area. An incorrect V/f pattern can decrease motor torque and increase current from overexcitation.</li> <li>Parameter A1-03 [Initialize Parameters] will not initialize the value of E1-03.</li> </ul>	F (Determined by A1-02)	695
E1-04 (0303)	Maximum Output Frequency	<p><b>V/f</b> <b>OLV/PM</b> <b>EZOLV</b></p> <p>Sets the maximum output frequency for the V/f pattern.</p>	Determined by A1-02 and E5-01 (Determined by A1-02 and E5-01)	700
E1-05 (0304)	Maximum Output Voltage	<p><b>V/f</b> <b>OLV/PM</b> <b>EZOLV</b></p> <p>Sets the maximum output voltage for the V/f pattern.</p>	208 V Class: 230.0 V, 480 V Class: 460.0 V (208 V Class: 0.0 - 255.0 V, 480 V Class: 0.0 - 510.0 V)	700
E1-06 (0305)	Base Frequency	<p><b>V/f</b> <b>OLV/PM</b> <b>EZOLV</b></p> <p>Sets the base frequency for the V/f pattern.</p>	Determined by A1-02 and E5-01 (0.0 - E1-04)	700
E1-07 (0306)	Mid Point A Frequency	<p><b>V/f</b> <b>OLV/PM</b> <b>EZOLV</b></p> <p>Sets a middle output frequency for the V/f pattern.</p>	Determined by E1-03 (0.0 - E1-04)	701
E1-08 (0307)	Mid Point A Voltage	<p><b>V/f</b> <b>OLV/PM</b> <b>EZOLV</b></p> <p>Sets a middle output voltage for the V/f pattern.</p>	Determined by o2-04 (208 V Class: 0.0 - 255.0 V, 480 V Class: 0.0 - 510.0 V)	701
E1-09 (0308)	Minimum Output Frequency	<p><b>V/f</b> <b>OLV/PM</b> <b>EZOLV</b></p> <p>Sets the minimum output frequency for the V/f pattern.</p>	Determined by A1-02 and E5-01 (Determined by A1-02, E1-04, and E5-01)	701
E1-10 (0309)	Minimum Output Voltage	<p><b>V/f</b> <b>OLV/PM</b> <b>EZOLV</b></p> <p>Sets the minimum output voltage for the V/f pattern.</p>	Determined by E1-03 (208 V Class: 0.0 - 255.0 V, 480 V Class: 0.0 - 510.0 V)	701
E1-11 (030A) Expert	Mid Point B Frequency	<p><b>V/f</b> <b>OLV/PM</b> <b>EZOLV</b></p> <p>Sets a middle output frequency for the V/f pattern.</p>	0.0 Hz (0.0 - E1-04)	701

No. (Hex.)	Name	Description	Default (Range)	Ref.
E1-12 (030B) Expert	Mid Point B Voltage	<b>V/f</b> <b>OLV/PM</b> <b>EZOLV</b> Sets a middle point voltage for the V/f pattern.	0.0 V (208 V Class: 0.0 - 255.0 V, 480 V Class: 0.0 - 510.0 V)	701
E1-13 (030C) Expert	Base Voltage	<b>V/f</b> <b>OLV/PM</b> <b>EZOLV</b> Sets the base voltage for the V/f pattern.	0.0 V (208 V Class: 0.0 - 255.0 V, 480 V Class: 0.0 - 510.0 V)	701

## ◆ E2: Motor Parameters

No. (Hex.)	Name	Description	Default (Range)	Ref.
E2-01 (030E)	Motor Rated Current (FLA)	<b>V/f</b> <b>OLV/PM</b> <b>EZOLV</b> Sets the motor rated current in amps.	Determined by o2-04 (10% to 200% of the drive rated current)	702
E2-02 (030F)	Motor Rated Slip	<b>V/f</b> <b>OLV/PM</b> <b>EZOLV</b> Sets motor rated slip.	Determined by o2-04 (0.000 - 20.000 Hz)	702
E2-03 (0310)	Motor No-Load Current	<b>V/f</b> <b>OLV/PM</b> <b>EZOLV</b> Sets the no-load current for the motor in amps when operating at the rated frequency and the no-load voltage.	Determined by o2-04 (0 to E2-01)	702
E2-04 (0311)	Motor Pole Count	<b>V/f</b> <b>OLV/PM</b> <b>EZOLV</b> Sets the number of motor poles.	4 (2 - 120)	703
E2-05 (0312)	Motor Line-to-Line Resistance	<b>V/f</b> <b>OLV/PM</b> <b>EZOLV</b> Sets the line-to-line resistance for the motor stator windings.	Determined by o2-04 (0.000 - 65.000 Ω)	703
E2-06 (0313)	Motor Leakage Inductance	<b>V/f</b> <b>OLV/PM</b> <b>EZOLV</b> Sets the voltage drop from motor leakage inductance when the motor is operating at the rated frequency and rated current. This value is a percentage of Motor Rated Voltage.	Determined by o2-04 (0.0 - 60.0%)	703
E2-10 (0317)	Motor Iron Loss	<b>V/f</b> <b>OLV/PM</b> <b>EZOLV</b> Sets the motor iron loss.	Determined by o2-04 (0 - 65535 W)	703
E2-11 (0318)	Motor Rated Power	<b>V/f</b> <b>OLV/PM</b> <b>EZOLV</b> Sets the motor rated output in the units from o1-58 [Motor Power Unit Selection].	Determined by o2-04 (0.00 - 650.00 HP)	703

## ◆ E3: V/f Pattern for Motor 2

No. (Hex.)	Name	Description	Default (Range)	Ref.
E3-01 (0319)	Motor 2 Control Mode Selection	<b>V/f</b> <b>OLV/PM</b> <b>EZOLV</b> Sets the control method for motor 2. <b>Note:</b> • Parameter L1-01 [Motor Overload (oL1) Protection] sets the protection operation of oL1 [Motor Overload] the same as Motor 1. • When you use parameter A1-03 [Initialize Parameters] to initialize the drive, this parameter is not reset. 0 : V/f Control	0 (0)	704
E3-04 (031A)	Motor 2 Maximum Output Frequency	<b>V/f</b> <b>OLV/PM</b> <b>EZOLV</b> Set the maximum output frequency for the motor 2 V/f pattern.	Determined by E3-01 (40.0 - 400.0 Hz)	704
E3-05 (031B)	Motor 2 Maximum Output Voltage	<b>V/f</b> <b>OLV/PM</b> <b>EZOLV</b> Sets the maximum output voltage for the motor 2 V/f pattern.	Determined by E3-01 (208 V Class: 0.0 - 255.0 V, 480 V Class: 0.0 - 510.0 V)	704
E3-06 (031C)	Motor 2 Base Frequency	<b>V/f</b> <b>OLV/PM</b> <b>EZOLV</b> Sets the base frequency for the motor 2 V/f pattern.	Determined by E3-01 (0.0 - E3-04)	705
E3-07 (031D)	Motor 2 Mid Point A Frequency	<b>V/f</b> <b>OLV/PM</b> <b>EZOLV</b> Sets a middle output frequency for the motor 2 V/f pattern.	Determined by E3-01 (0.0 - E3-04)	705

## 11.8 E: Motor Parameters

No. (Hex.)	Name	Description	Default (Range)	Ref.
E3-08 (031E)	Motor 2 Mid Point A Voltage	<input type="checkbox"/> V/f <input type="checkbox"/> OLV/PM <input type="checkbox"/> EZOLV Sets a middle output voltage for the motor 2 V/f pattern.	Determined by E3-01 (208 V Class: 0.0 - 255.0 V, 480 V Class: 0.0 - 510.0 V)	705
E3-09 (031F)	Motor 2 Minimum Output Frequency	<input type="checkbox"/> V/f <input type="checkbox"/> OLV/PM <input type="checkbox"/> EZOLV Sets the minimum output frequency for the motor 2 V/f pattern.	Determined by E3-01 (0.0 - E3-04)	705
E3-10 (0320)	Motor 2 Minimum Output Voltage	<input type="checkbox"/> V/f <input type="checkbox"/> OLV/PM <input type="checkbox"/> EZOLV Sets the minimum output voltage for the motor 2 V/f pattern.	Determined by E3-01 (208 V Class: 0.0 - 255.0 V, 480 V Class)	705
E3-11 (0345) Expert	Motor 2 Mid Point B Frequency	<input type="checkbox"/> V/f <input type="checkbox"/> OLV/PM <input type="checkbox"/> EZOLV Sets a middle output frequency for the motor 2 V/f pattern. Set this parameter to adjust the V/f pattern for the constant output range. Usually it is not necessary to change this parameter.	0.0 Hz (0.0 - E3-04)	705
E3-12 (0346) Expert	Motor 2 Mid Point B Voltage	<input type="checkbox"/> V/f <input type="checkbox"/> OLV/PM <input type="checkbox"/> EZOLV Sets a middle output voltage for the motor 2 V/f pattern. Set this parameter to adjust the V/f pattern for the constant output range. Usually it is not necessary to change this parameter.	0.0 V (208 V Class: 0.0 - 255.0 V, 480 V Class: 0.0 - 510.0 V)	705
E3-13 (0347) Expert	Motor 2 Base Voltage	<input type="checkbox"/> V/f <input type="checkbox"/> OLV/PM <input type="checkbox"/> EZOLV Sets the base voltage for the motor 2 V/f pattern. Set this parameter to adjust the V/f pattern for the constant output range. Usually it is not necessary to change this parameter.	0.0 V (208 V Class: 0.0 - 255.0 V, 480 V Class: 0.0 - 510.0 V)	706

### ◆ E4: Motor 2 Parameters

No. (Hex.)	Name	Description	Default (Range)	Ref.
E4-01 (0321)	Motor 2 Rated Current	<input type="checkbox"/> V/f <input type="checkbox"/> OLV/PM <input type="checkbox"/> EZOLV Sets the motor rated current for motor 2 in amps.	Determined by o2-04 (10% to 200% of the drive rated current)	706
E4-02 (0322)	Motor 2 Rated Slip	<input type="checkbox"/> V/f <input type="checkbox"/> OLV/PM <input type="checkbox"/> EZOLV Sets the motor rated slip for motor 2.	Determined by o2-04 (0.000 - 20.000 Hz)	706
E4-03 (0323)	Motor 2 Rated No-Load Current	<input type="checkbox"/> V/f <input type="checkbox"/> OLV/PM <input type="checkbox"/> EZOLV Sets the no-load current for motor 2 in amps when operating at the rated frequency and the no-load voltage.	Determined by o2-04 (Less than 0 - E4-01)	706
E4-04 (0324)	Motor 2 Motor Poles	<input type="checkbox"/> V/f <input type="checkbox"/> OLV/PM <input type="checkbox"/> EZOLV Sets the number of poles for motor 2.	4 (2 - 120)	707
E4-05 (0325)	Motor 2 Line-to-Line Resistance	<input type="checkbox"/> V/f <input type="checkbox"/> OLV/PM <input type="checkbox"/> EZOLV Sets the line-to-line resistance for the motor 2 stator windings.	Determined by o2-04 (0.000 - 65.000 Ω)	707
E4-06 (0326)	Motor 2 Leakage Inductance	<input type="checkbox"/> V/f <input type="checkbox"/> OLV/PM <input type="checkbox"/> EZOLV Sets the voltage drop from motor 2 leakage inductance as a percentage of Motor Rated Voltage when motor 2 operates at the rated frequency and rated current.	Determined by o2-04 (0.0 - 60.0%)	707
E4-10 (0340)	Motor 2 Iron Loss	<input type="checkbox"/> V/f <input type="checkbox"/> OLV/PM <input type="checkbox"/> EZOLV Sets the motor iron loss for motor 2.	Determined by o2-04 (0 - 65535 W)	707
E4-11 (0327)	Motor 2 Rated Power	<input type="checkbox"/> V/f <input type="checkbox"/> OLV/PM <input type="checkbox"/> EZOLV Sets the motor rated power in the units from o1-58 [Motor Power Unit Selection].	Determined by o2-04 (0.00 - 650.00 HP)	707

### ◆ E5: PM Motor Settings

No. (Hex.)	Name	Description	Default (Range)	Ref.
E5-01 (0329)	PM Motor Code Selection	<input type="checkbox"/> V/f <input type="checkbox"/> OLV/PM <input type="checkbox"/> EZOLV Sets the motor code for Yaskawa PM motors. The drive uses the motor code to automatically set some parameters to their correct settings.	FFFF (0000 - FFFF)	708
E5-02 (032A)	PM Motor Rated Power	<input type="checkbox"/> V/f <input type="checkbox"/> OLV/PM <input type="checkbox"/> EZOLV Sets the PM motor rated output in the units set in o1-58 [Motor Power Unit Selection].	Determined by o2-04 (0.13 - 650.00 HP)	708
E5-03 (032B)	PM Motor Rated Current (FLA)	<input type="checkbox"/> V/f <input type="checkbox"/> OLV/PM <input type="checkbox"/> EZOLV Sets the PM motor rated current (FLA).	Determined by o2-04 (10% to 200% of the drive rated current)	708



No. (Hex.)	Name	Description	Default (Range)	Ref.
E5-04 (032C)	PM Motor Pole Count	<input type="checkbox"/> V/f <input checked="" type="checkbox"/> OLV/PM <input type="checkbox"/> EZOLV Sets the number of PM motor poles. <b>Note:</b> When A1-02 = 5 or 8 [OLV/PM or EZOLV], the maximum value is 48.	4 (2 - 120)	708
E5-05 (032D)	PM Motor Resistance (ohms/phase)	<input type="checkbox"/> V/f <input checked="" type="checkbox"/> OLV/PM <input type="checkbox"/> EZOLV Sets the resistance per phase of a PM motor. Set 50% of the line-to-line resistance.	0.100 Ω (0.000 - 65.000 Ω)	709
E5-06 (032E)	PM d-axis Inductance (mH/phase)	<input type="checkbox"/> V/f <input checked="" type="checkbox"/> OLV/PM <input type="checkbox"/> EZOLV Sets the PM motor d-axis inductance.	1.00 mH (0.00 - 300.00 mH)	709
E5-07 (032F)	PM q-axis Inductance (mH/phase)	<input type="checkbox"/> V/f <input checked="" type="checkbox"/> OLV/PM <input type="checkbox"/> EZOLV Sets the PM motor q-axis inductance.	1.00 mH (0.00 - 600.00 mH)	709
E5-09 (0331)	PM Back-EMF Vpeak (mV/(rad/s))	<input type="checkbox"/> V/f <input checked="" type="checkbox"/> OLV/PM <input type="checkbox"/> EZOLV Sets the peak value of PM motor induced voltage.	0.0 mV/(rad/sec) (0.0 - 2000.0 mV/(rad/s))	709
E5-24 (0353)	PM Back-EMF L-L Vrms (mV/rpm)	<input type="checkbox"/> V/f <input checked="" type="checkbox"/> OLV/PM <input type="checkbox"/> EZOLV Sets the RMS value for PM motor line voltage.	0.1 mV/min <sup>-1</sup> (0.0 - 6500.0 mV/min <sup>-1</sup> )	710

## ◆ E9: Motor Setting

No. (Hex.)	Name	Description	Default (Range)	Ref.
E9-01 (11E4)	Motor Type Selection	<input type="checkbox"/> V/f <input checked="" type="checkbox"/> OLV/PM <input type="checkbox"/> EZOLV Sets the type of motor. 0 : Induction (IM) 1 : Permanent Magnet (PM) 2 : Synchronous Reluctance (SynRM)	0 (0 - 2)	710
E9-02 (11E5)	Maximum Speed	<input type="checkbox"/> V/f <input checked="" type="checkbox"/> OLV/PM <input type="checkbox"/> EZOLV Sets the maximum speed of the motor.	Determined by E9-01 (40.0 - 120.0 Hz)	710
E9-03 (11E6)	Rated Speed	<input type="checkbox"/> V/f <input checked="" type="checkbox"/> OLV/PM <input type="checkbox"/> EZOLV Sets the rated rotation speed of the motor.	Determined by E9-01 (100 - 7200 min <sup>-1</sup> )	710
E9-04 (11E7)	Base Frequency	<input type="checkbox"/> V/f <input checked="" type="checkbox"/> OLV/PM <input type="checkbox"/> EZOLV Sets the rated frequency of the motor.	Determined by E9-01 (40.0 - 120.0 Hz)	710
E9-05 (11E8)	Base Voltage	<input type="checkbox"/> V/f <input checked="" type="checkbox"/> OLV/PM <input type="checkbox"/> EZOLV Sets the rated voltage of the motor.	208 V Class: 230.0 V, 480 V Class: 460.0 V (208 V Class: 0.0 - 255.0 V, 480 V Class: 0.0 - 510.0 V)	711
E9-06 (11E9)	Motor Rated Current (FLA)	<input type="checkbox"/> V/f <input checked="" type="checkbox"/> OLV/PM <input type="checkbox"/> EZOLV Sets the motor rated current in amps.	Determined by E9-01 and o2-04 (10% to 200% of the drive rated current)	711
E9-07 (11EA)	Motor Rated Power	<input type="checkbox"/> V/f <input checked="" type="checkbox"/> OLV/PM <input type="checkbox"/> EZOLV Sets the motor rated output in the units from o1-58 [Motor Power Unit Selection].	Determined by E9-02 and o2-04 (0.00 - 650.00 kW)	711
E9-08 (11EB)	Motor Pole Count	<input type="checkbox"/> V/f <input checked="" type="checkbox"/> OLV/PM <input type="checkbox"/> EZOLV Sets the number of motor poles.	4 (2 to 120)	711
E9-09 (11EC)	Motor Rated Slip	<input type="checkbox"/> V/f <input checked="" type="checkbox"/> OLV/PM <input type="checkbox"/> EZOLV Sets the motor rated slip.	0.000 Hz (0.000 - 20.000 Hz)	711
E9-10 (11ED)	Motor Line-to-Line Resistance	<input type="checkbox"/> V/f <input checked="" type="checkbox"/> OLV/PM <input type="checkbox"/> EZOLV Sets the line-to-line resistance for the motor stator windings.	Determined by o2-04 (0.000 - 65.000 Ω)	712

## 11.9 F: Options

### ◆ F6: Communication Options

No. (Hex.)	Name	Description	Default (Range)	Ref.
F6-01 (03A2)	Communication Error Selection	<p><b>V/f</b> <b>OLV/PM</b> <b>EZOLV</b></p> <p>Sets the method to stop the motor or let the motor continue operating when the drive detects <i>bUS</i> [Option Communication Error].</p> <p>0 : Ramp to Stop            1 : Coast to Stop            2 : Fast Stop (Use C1-09)            3 : Alarm Only            4 : Alarm (Run at d1-04)            5 : Alarm - Ramp Stop</p>	1 (0 - 5)	718
F6-02 (03A3)	Comm External Fault (EF0) Detect	<p><b>V/f</b> <b>OLV/PM</b> <b>EZOLV</b></p> <p>Sets the conditions at which <i>EF0</i> [Option Card External Fault] is detected.</p> <p>0 : Always Detected            1 : Detected during RUN Only</p>	0 (0, 1)	719
F6-03 (03A4)	Comm External Fault (EF0) Select	<p><b>V/f</b> <b>OLV/PM</b> <b>EZOLV</b></p> <p>Sets the method to stop the motor or let the motor continue operating when the drive detects an <i>EF0</i> [Option Card External Fault].</p> <p>0 : Ramp to Stop            1 : Coast to Stop            2 : Fast Stop (Use C1-09)            3 : Alarm Only</p>	1 (0 - 3)	719
F6-04 (03A5)	bUS Error Detection Time	<p><b>V/f</b> <b>OLV/PM</b> <b>EZOLV</b></p> <p>Sets the delay time for the drive to detect <i>bUS</i> [Option Communication Error].</p> <p><b>Note:</b>            When you install an option card in the drive, the parameter value changes to 0.0 s.</p>	2.0 s (0.0 - 5.0 s)	719
F6-06 (03A7)	Torque Reference/Limit by Comm	<p><b>V/f</b> <b>OLV/PM</b> <b>EZOLV</b></p> <p>Sets the function that enables and disables the torque reference and torque limit received from the communication option.</p> <p>0 : Disabled            1 : Enabled</p>	0 (0, 1)	719
F6-07 (03A8)	Multi-Step Ref @ NetRef/ComRef	<p><b>V/f</b> <b>OLV/PM</b> <b>EZOLV</b></p> <p>Sets the function that enables and disables the multi-step speed reference when the frequency reference source is NetRef or ComRef (communication option card or MEMOBUS/Modbus communications).</p> <p>0 : Disable Multi-Step References            1 : Enable Multi-Step References</p>	0 (0, 1)	720
F6-08 (036A)	Comm Parameter Reset @Initialize	<p><b>V/f</b> <b>OLV/PM</b> <b>EZOLV</b></p> <p>Sets the function to initialize <i>F6-xx</i> and <i>F7-xx</i> parameters when the drive is initialized with <i>A1-03</i> [Initialize Parameters].</p> <p>0 : No Reset - Parameters Retained            1 : Reset Back to Factory Default</p>	0 (0, 1)	720
F6-14 (03BB)	BUS Error Auto Reset	<p><b>V/f</b> <b>OLV/PM</b> <b>EZOLV</b></p> <p>Sets the automatic reset function for <i>bUS</i> [Option Communication Errors].</p> <p>0 : Disable            1 : Enabled</p>	0 (0, 1)	720
F6-15 (0B5B)	Comm. Option Parameters Reload	<p><b>V/f</b> <b>OLV/PM</b> <b>EZOLV</b></p> <p>Sets the update method when you change <i>F6-xx</i>, <i>F7-xx</i> [Communication Options].</p> <p>0 : Reload at Next Power Cycle            1 : Reload Now            2 : Cancel Reload Request</p>	0 (0 - 2)	720
F6-16 (0B8A)	Gateway Mode	<p><b>V/f</b> <b>OLV/PM</b> <b>EZOLV</b></p> <p>Sets the gateway mode operation and the number of connected slave drives.</p> <p>0 : Disabled            1 : Enabled: 1 Slave Drives            2 : Enabled: 2 Slave Drives            3 : Enabled: 3 Slave Drives            4 : Enabled: 4 Slave Drives</p>	0 (0 to 4)	721

No. (Hex.)	Name	Description	Default (Range)	Ref.
F6-48 (02FE)	BACnet Device Object Identifier0	<b>V/f</b> <b>OLV/PM</b> <b>EZOLV</b> Sets the last word of BACnet communication addresses.	0 (0 - FFFF)	721
F6-49 (02FF)	BACnet Device Object Identifier1	<b>V/f</b> <b>OLV/PM</b> <b>EZOLV</b> Sets the last word of BACnet communication addresses.	0 (0 - 3F)	721

## ◆ F7: Ethernet Options

No. (Hex.)	Name	Description	Default (Range)	Ref.
F7-01 (03E5)	IP Address 1	<b>V/f</b> <b>OLV/PM</b> <b>EZOLV</b> Sets the first octet of the IP Address for the device that is connecting to the network. Restart the drive after you change this parameter. <b>Note:</b> When $F7-13 = 0$ [Address Mode at Startup = Static]: • Use parameters $F7-01$ to $F7-04$ [IP Address 1 to 4] to set the IP Address. Be sure to set a different IP address for each drive on the network. • Also set parameters $F7-05$ to $F7-12$ [Subnet Mask 1 to 4, Gateway Address 1 to 4].	192 (0 - 255)	721
F7-02 (03E6)	IP Address 2	<b>V/f</b> <b>OLV/PM</b> <b>EZOLV</b> Sets the second octet of the IP Address for the device that is connecting to the network. Restart the drive after you change this parameter. <b>Note:</b> When $F7-13 = 0$ [Address Mode at Startup = Static]: • Use parameters $F7-01$ to $F7-04$ [IP Address 1 to 4] to set the IP Address. Be sure to set a different IP address for each drive on the network. • Also set parameters $F7-05$ to $F7-12$ [Subnet Mask 1 to 4, Gateway Address 1 to 4].	168 (0 - 255)	721
F7-03 (03E7)	IP Address 3	<b>V/f</b> <b>OLV/PM</b> <b>EZOLV</b> Sets the third octet of the IP Address for the device that is connecting to the network. Restart the drive after you change this parameter. <b>Note:</b> When $F7-13 = 0$ [Address Mode at Startup = Static]: • Use parameters $F7-01$ to $F7-04$ [IP Address 1 to 4] to set the IP Address. Be sure to set a different IP address for each drive on the network. • Also set parameters $F7-05$ to $F7-12$ [Subnet Mask 1 to 4, Gateway Address 1 to 4].	1 (0 - 255)	721
F7-04 (03E8)	IP Address 4	<b>V/f</b> <b>OLV/PM</b> <b>EZOLV</b> Sets the fourth octet of the IP Address for the device that is connecting to the network. Restart the drive after you change this parameter. <b>Note:</b> When $F7-13 = 0$ [Address Mode at Startup = Static]: • Use parameters $F7-01$ to $F7-04$ [IP Address 1 to 4] to set the IP Address. Be sure to set a different IP address for each drive on the network. • Also set parameters $F7-05$ to $F7-12$ [Subnet Mask 1 to 4, Gateway Address 1 to 4].	20 (0 - 255)	722
F7-05 (03E9)	Subnet Mask 1	<b>V/f</b> <b>OLV/PM</b> <b>EZOLV</b> Sets the first octet of the subnet mask of the connected network. <b>Note:</b> Set this parameter when $F7-13 = 0$ [Address Mode at Startup = Static].	255 (0 - 255)	722
F7-06 (03EA)	Subnet Mask 2	<b>V/f</b> <b>OLV/PM</b> <b>EZOLV</b> Sets the second octet of the subnet mask of the connected network. <b>Note:</b> Set this parameter when $F7-13 = 0$ [Address Mode at Startup = Static].	255 (0 - 255)	722
F7-07 (03EB)	Subnet Mask 3	<b>V/f</b> <b>OLV/PM</b> <b>EZOLV</b> Sets the third octet of the subnet mask of the connected network. <b>Note:</b> Set this parameter when $F7-13 = 0$ [Address Mode at Startup = Static].	255 (0 - 255)	722
F7-08 (03EC)	Subnet Mask 4	<b>V/f</b> <b>OLV/PM</b> <b>EZOLV</b> Sets the fourth octet of the subnet mask of the connected network. <b>Note:</b> Set this parameter when $F7-13 = 0$ [Address Mode at Startup = Static].	0 (0 - 255)	722
F7-09 (03ED)	Gateway Address 1	<b>V/f</b> <b>OLV/PM</b> <b>EZOLV</b> Sets the first octet of the gateway address of the connected network. <b>Note:</b> Set this parameter when $F7-13 = 0$ [Address Mode at Startup = Static].	192 (0 - 255)	722

## 11.9 F: Options

No. (Hex.)	Name	Description	Default (Range)	Ref.
F7-10 (03EE)	Gateway Address 2	<b>V/f</b> <b>OLV/PM</b> <b>EZOLV</b> Sets the second octet of the gateway address of the connected network. <b>Note:</b> Set this parameter when $F7-13 = 0$ [Address Mode at Startup = Static].	168 (0 - 255)	723
F7-11 (03EF)	Gateway Address 3	<b>V/f</b> <b>OLV/PM</b> <b>EZOLV</b> Sets the third octet of the gateway address of the connected network. <b>Note:</b> Set this parameter when $F7-13 = 0$ [Address Mode at Startup = Static].	1 (0 - 255)	723
F7-12 (03F0)	Gateway Address 4	<b>V/f</b> <b>OLV/PM</b> <b>EZOLV</b> Sets the fourth octet of the gateway address of the connected network. <b>Note:</b> Set this parameter when $F7-13 = 0$ [Address Mode at Startup = Static].	1 (0 - 255)	723
F7-13 (03F1)	Address Mode at Startup	<b>V/f</b> <b>OLV/PM</b> <b>EZOLV</b> Sets the method to set option card IP addresses. 0 : Static 1 : BOOTP 2 : DHCP <b>Note:</b> • The following setting values are available when using the PROFINET communication option card (SI-EP3). -0: Static -2: DHCP • When $F7-13 = 0$ , set parameters $F7-01$ to $F7-12$ [IP Address 1 to Gateway Address 4] to set the IP Address. Be sure to set a different IP address for each drive on the network.	2 (0 - 2)	723
F7-14 (03F2)	Duplex Mode Selection	<b>V/f</b> <b>OLV/PM</b> <b>EZOLV</b> Sets the duplex mode setting method. 0 : Half/Half 1 : Auto/Auto 2 : Full/Full 3 : Half/Auto 4 : Half/Full 5 : Auto/Half 6 : Auto/Full 7 : Full/Half 8 : Full/Auto	1 (0 - 8)	723
F7-15 (03F3)	Communication Speed Selection	<b>V/f</b> <b>OLV/PM</b> <b>EZOLV</b> Sets the communications speed. 10 : 10/10 Mbps 100 : 100/100 Mbps 101 : 10/100 Mbps 102 : 100/10 Mbps	10 (10, 100 - 102)	724
F7-16 (03F4)	Timeout Value	<b>V/f</b> <b>OLV/PM</b> <b>EZOLV</b> Sets the detection time for a communications timeout. <b>Note:</b> Set this parameter to 0.0 to disable the connection timeout function.	0.0 s (0.0 - 30.0 s)	724
F7-17 (03F5)	EtherNet/IP Speed Scaling Factor	<b>V/f</b> <b>OLV/PM</b> <b>EZOLV</b> Sets the scaling factor for the speed monitor in the EtherNet/IP Class ID 2AH Object.	0 (-15 - +15)	724
F7-18 (03F6)	EtherNet/IP Current Scale Factor	<b>V/f</b> <b>OLV/PM</b> <b>EZOLV</b> Sets the scaling factor for the output current monitor in the EtherNet/IP Class ID 2AH Object.	0 (-15 - +15)	724
F7-19 (03F7)	EtherNet/IP Torque Scale Factor	<b>V/f</b> <b>OLV/PM</b> <b>EZOLV</b> Sets the scaling factor for the torque monitor in the EtherNet/IP Class ID 2AH Object.	0 (-15 - +15)	724
F7-20 (03F8)	EtherNet/IP Power Scaling Factor	<b>V/f</b> <b>OLV/PM</b> <b>EZOLV</b> Sets the scaling factor for the power monitor in the EtherNet/IP Class ID 2AH Object.	0 (-15 - +15)	725
F7-21 (03F9)	EtherNet/IP Voltage Scale Factor	<b>V/f</b> <b>OLV/PM</b> <b>EZOLV</b> Sets the scaling factor for the voltage monitor in the EtherNet/IP Class ID 2AH Object.	0 (-15 - +15)	725
F7-22 (03FA)	EtherNet/IP Time Scaling	<b>V/f</b> <b>OLV/PM</b> <b>EZOLV</b> Sets the scaling factor for the time monitor in the EtherNet/IP Class ID 2AH Object.	0 (-15 - +15)	725

No. (Hex.)	Name	Description	Default (Range)	Ref.
F7-23 (03FB)	Dynamic Out Param 1 for CommCard	<b>V/f</b> <b>OLV/PM</b> <b>EZOLV</b> When you use an Ethernet/IP option, sets Output Assembly 116. The drive writes the values from Output Assembly 116 to the MEMOBUS/Modbus address register that is stored for each parameter. The drive will not write the values from Output Assembly 116 to the registers when the MEMOBUS/Modbus address is 0. When you use a PROFINET option, set this parameter to set to configurable output 1.	0	725
F7-24 (03FC)	Dynamic Out Param 2 for CommCard	<b>V/f</b> <b>OLV/PM</b> <b>EZOLV</b> When you use an Ethernet/IP option, sets Output Assembly 116. The drive writes the values from Output Assembly 116 to the MEMOBUS/Modbus address register that is stored for each parameter. The drive will not write the values from Output Assembly 116 to the registers when the MEMOBUS/Modbus address is 0. When you use a PROFINET option, set this parameter to set to configurable output 2.	0	725
F7-25 (03FD)	Dynamic Out Param 3 for CommCard	<b>V/f</b> <b>OLV/PM</b> <b>EZOLV</b> When you use an Ethernet/IP option, sets Output Assembly 116. The drive writes the values from Output Assembly 116 to the MEMOBUS/Modbus address register that is stored for each parameter. The drive will not write the values from Output Assembly 116 to the registers when the MEMOBUS/Modbus address is 0. When you use a PROFINET option, set this parameter to set to configurable output 3.	0	725
F7-26 (03FE)	Dynamic Out Param 4 for CommCard	<b>V/f</b> <b>OLV/PM</b> <b>EZOLV</b> Sets Output Assembly 116 when you use an Ethernet/IP option. The drive writes the values from Output Assembly 116 to the MEMOBUS/Modbus address register that is stored for each parameter. The drive will not write the values from Output Assembly 116 to the registers when the MEMOBUS/Modbus address is 0. When you use a ProfiNet option, set this parameter to set to configurable output 4.	0	725
F7-27 (03FF)	Dynamic Out Param 5 for CommCard	<b>V/f</b> <b>OLV/PM</b> <b>EZOLV</b> When you use an Ethernet/IP option, sets Output Assembly 116. The drive writes the values from Output Assembly 116 to the MEMOBUS/Modbus address register that is stored for each parameter. The drive will not write the values from Output Assembly 116 to the registers when the MEMOBUS/Modbus address is 0. When you use a PROFINET option, set this parameter to set to configurable output 5.	0	725
F7-28 (0370)	Dynamic Out Param 6 for CommCard	<b>V/f</b> <b>OLV/PM</b> <b>EZOLV</b> When you use an Ethernet/IP option, sets Output Assembly 116. The drive writes the values from Output Assembly 116 to the MEMOBUS/Modbus address register that is stored for each parameter. The drive will not write the values from Output Assembly 116 to the registers when the MEMOBUS/Modbus address is 0.	0	725
F7-29 (0371)	Dynamic Out Param 7 for CommCard	<b>V/f</b> <b>OLV/PM</b> <b>EZOLV</b> When you use an Ethernet/IP option, sets Output Assembly 116. The drive writes the values from Output Assembly 116 to the MEMOBUS/Modbus address register that is stored for each parameter. The drive will not write the values from Output Assembly 116 to the registers when the MEMOBUS/Modbus address is 0.	0	725
F7-30 (0372)	Dynamic Out Param 8 for CommCard	<b>V/f</b> <b>OLV/PM</b> <b>EZOLV</b> When you use an Ethernet/IP option, sets Output Assembly 116. The drive writes the values from Output Assembly 116 to the MEMOBUS/Modbus address register that is stored for each parameter. The drive will not write the values from Output Assembly 116 to the registers when the MEMOBUS/Modbus address is 0.	0	725
F7-31 (0373)	Dynamic Out Param 9 for CommCard	<b>V/f</b> <b>OLV/PM</b> <b>EZOLV</b> When you use an Ethernet/IP option, sets Output Assembly 116. The drive writes the values from Output Assembly 116 to the MEMOBUS/Modbus address register that is stored for each parameter. The drive will not write the values from Output Assembly 116 to the registers when the MEMOBUS/Modbus address is 0.	0	725
F7-32 (0374)	Dynamic Out Param 10 for CommCard	<b>V/f</b> <b>OLV/PM</b> <b>EZOLV</b> When you use an Ethernet/IP option, sets Output Assembly 116. The drive writes the values from Output Assembly 116 to the MEMOBUS/Modbus address register that is stored for each parameter. The drive will not write the values from Output Assembly 116 to the registers when the MEMOBUS/Modbus address is 0.	0	725
F7-33 (0375)	Dynamic In Param 1 for CommCard	<b>V/f</b> <b>OLV/PM</b> <b>EZOLV</b> Sets Input Assembly 166 when you use an Ethernet/IP option. The drive sends the values from the MEMOBUS/Modbus address registers stored for each parameter to Input Assembly 166. The drive returns the default register value for the option card when the MEMOBUS/Modbus address is 0 and the value sent to Input Assembly 166 is not defined. When you use a ProfiNet option, set this parameter to set to configurable input 1.	0	725
F7-34 (0376)	Dynamic In Param 2 for CommCard	<b>V/f</b> <b>OLV/PM</b> <b>EZOLV</b> Sets Input Assembly 166 when you use an Ethernet/IP option. The drive sends the values from the MEMOBUS/Modbus address registers stored for each parameter to Input Assembly 166. The drive returns the default register value for the option card when the MEMOBUS/Modbus address is 0 and the value sent to Input Assembly 166 is not defined. When you use a ProfiNet option, set this parameter to set to configurable input 2.	0	725
F7-35 (0377)	Dynamic In Param 3 for CommCard	<b>V/f</b> <b>OLV/PM</b> <b>EZOLV</b> Sets Input Assembly 166 when you use an Ethernet/IP option. The drive sends the values from the MEMOBUS/Modbus address registers stored for each parameter to Input Assembly 166. The drive returns the default register value for the option card when the MEMOBUS/Modbus address is 0 and the value sent to Input Assembly 166 is not defined. When you use a ProfiNet option, set this parameter to set to configurable input 3.	0	725

## 11.9 F: Options

No. (Hex.)	Name	Description	Default (Range)	Ref.
F7-36 (0378)	Dynamic In Param 4 for CommCard	<b>V/f</b> <b>OLV/PM</b> <b>EZOLV</b> Sets Input Assembly 166 when you use an Ethernet/IP option. The drive sends the values from the MEMOBUS/Modbus address registers stored for each parameter to Input Assembly 166. The drive returns the default register value for the option card when the MEMOBUS/Modbus address is 0 and the value sent to Input Assembly 166 is not defined. When you use a ProfiNet option, set this parameter to set to configurable input 4.	0	725
F7-37 (0379)	Dynamic In Param 5 for CommCard	<b>V/f</b> <b>OLV/PM</b> <b>EZOLV</b> Sets Input Assembly 166 when you use an Ethernet/IP option. The drive sends the values from the MEMOBUS/Modbus address registers stored for each parameter to Input Assembly 166. The drive returns the default register value for the option card when the MEMOBUS/Modbus address is 0 and the value sent to Input Assembly 166 is not defined. When you use a ProfiNet option, set this parameter to set to configurable input 5.	0	725
F7-38 (037A)	Dynamic In Param 6 for CommCard	<b>V/f</b> <b>OLV/PM</b> <b>EZOLV</b> Sets Input Assembly 166 when you use an Ethernet/IP option. The drive sends the values from the MEMOBUS/Modbus address registers stored for each parameter to Input Assembly 166. The drive returns the default register value for the option card when the MEMOBUS/Modbus address is 0 and the value sent to Input Assembly 166 is not defined.	0	725
F7-39 (037B)	Dynamic In Param 7 for CommCard	<b>V/f</b> <b>OLV/PM</b> <b>EZOLV</b> Sets Input Assembly 166 when you use an Ethernet/IP option. The drive sends the values from the MEMOBUS/Modbus address registers stored for each parameter to Input Assembly 166. The drive returns the default register value for the option card when the MEMOBUS/Modbus address is 0 and the value sent to Input Assembly 166 is not defined.	0	725
F7-40 (037C)	Dynamic In Param 8 for CommCard	<b>V/f</b> <b>OLV/PM</b> <b>EZOLV</b> Sets Input Assembly 166 when you use an Ethernet/IP option. The drive sends the values from the MEMOBUS/Modbus address registers stored for each parameter to Input Assembly 166. The drive returns the default register value for the option card when the MEMOBUS/Modbus address is 0 and the value sent to Input Assembly 166 is not defined.	0	725
F7-41 (037D)	Dynamic In Param 9 for CommCard	<b>V/f</b> <b>OLV/PM</b> <b>EZOLV</b> Sets Input Assembly 166 when you use an Ethernet/IP option. The drive sends the values from the MEMOBUS/Modbus address registers stored for each parameter to Input Assembly 166. The drive returns the default register value for the option card when the MEMOBUS/Modbus address is 0 and the value sent to Input Assembly 166 is not defined.	0	725
F7-42 (037E)	Dynamic In Param 10 for CommCard	<b>V/f</b> <b>OLV/PM</b> <b>EZOLV</b> Sets Input Assembly 166 when you use an Ethernet/IP option. The drive sends the values from the MEMOBUS/Modbus address registers stored for each parameter to Input Assembly 166. The drive returns the default register value for the option card when the MEMOBUS/Modbus address is 0 and the value sent to Input Assembly 166 is not defined.	0	725
F7-50 (1BC1)	BACnet/IP Port #	<b>V/f</b> <b>OLV/PM</b> <b>EZOLV</b> Sets the UDP port on which the drive will receive incoming BACnet messages.	47808 (1024 - 65535)	725
F7-51 (1BE9)	BBMD Foreign Register Addr 1	<b>V/f</b> <b>OLV/PM</b> <b>EZOLV</b> Sets the first octet of the IP Address of the BBMD device to which this unit will register as a foreign device.	0 (0 - 255)	725
F7-52 (1BEA)	BBMD Foreign Register Addr 2	<b>V/f</b> <b>OLV/PM</b> <b>EZOLV</b> Sets the second octet of the IP Address of the BBMD device to which this unit will register as a foreign device.	0 (0 - 255)	725
F7-53 (1BEB)	BBMD Foreign Register Addr 3	<b>V/f</b> <b>OLV/PM</b> <b>EZOLV</b> Sets the third octet of the IP Address of the BBMD device to which this unit will register as a foreign device.	0 (0 - 255)	726
F7-54 (1BEC)	BBMD Foreign Register Addr 4	<b>V/f</b> <b>OLV/PM</b> <b>EZOLV</b> Sets the fourth octet of the IP Address of the BBMD device to which this unit will register as a foreign device.	0 (0 - 255)	726
F7-55 (1BED)	BBMD Foreign Register Port #	<b>V/f</b> <b>OLV/PM</b> <b>EZOLV</b> Sets the UDP port of the BBMD device to which this unit will register.	47808 (1024 - 65535)	726
F7-56 (1BEE)	BBMD Foreign Register Time	<b>V/f</b> <b>OLV/PM</b> <b>EZOLV</b> Sets the time interval in which this unit will repeat BBMD foreign registration.	3600 s (0 - 65535 s)	726
F7-57 (1BEF)	BACnet/IP bUS Timeout Value	<b>V/f</b> <b>OLV/PM</b> <b>EZOLV</b> Sets the length of time that this unit will wait after it receives a Run command or frequency reference command before it detects a bUS fault.	3600 s (0 - 65535 s)	726

## 11.10 H: Terminal Functions

### ◆ H1: Digital Inputs

No. (Hex.)	Name	Description	Default (Range)	Ref.
H1-01 (0438)	Terminal S1 Function Selection	<b>V/f</b> <b>OLV/PM</b> <b>EZOLV</b> Sets the function for MFDI terminal S1. <b>Note:</b> The default setting is <i>F</i> when you initialize the drive for <i>3-Wire Initialization</i> [A1-03 = 3330].	40 (1 - 1FF)	728
H1-02 (0439)	Terminal S2 Function Selection	<b>V/f</b> <b>OLV/PM</b> <b>EZOLV</b> Sets the function for MFDI terminal S2. <b>Note:</b> The default setting is <i>F</i> when you initialize the drive for <i>3-Wire Initialization</i> [A1-03 = 3330].	F (1 - 1FF)	728
H1-03 (0400)	Terminal S3 Function Selection	<b>V/f</b> <b>OLV/PM</b> <b>EZOLV</b> Sets the function for MFDI terminal S3.	24 (0 - 1FF)	728
H1-04 (0401)	Terminal S4 Function Selection	<b>V/f</b> <b>OLV/PM</b> <b>EZOLV</b> Sets the function for MFDI terminal S4.	14 (0 - 1FF)	728
H1-05 (0402)	Terminal S5 Function Selection	<b>V/f</b> <b>OLV/PM</b> <b>EZOLV</b> Sets the function for MFDI terminal S5. <b>Note:</b> The default setting is <i>0</i> when the drive is initialized for <i>3-Wire Initialization</i> [A1-03 = 3330].	3 (0 - 1FF)	729
H1-06 (0403)	Terminal S6 Function Selection	<b>V/f</b> <b>OLV/PM</b> <b>EZOLV</b> Sets the function for MFDI terminal S6. <b>Note:</b> The default setting is <i>3</i> when the drive is initialized for <i>3-Wire Initialization</i> [A1-03 = 3330].	4 (0 - 1FF)	729
H1-07 (0404)	Terminal S7 Function Selection	<b>V/f</b> <b>OLV/PM</b> <b>EZOLV</b> Sets the function for MFDI terminal S7. <b>Note:</b> The default setting is <i>4</i> when the drive is initialized for <i>3-Wire Initialization</i> [A1-03 = 3330].	6 (0 - 1FF)	729
H1-40 (0B54)	Mbus Reg 15C0h bit0 Input Func	<b>V/f</b> <b>OLV/PM</b> <b>EZOLV</b> Sets the MFDI function assigned to <i>bit 0</i> of the MEMOBUS register <i>15C0</i> (Hex.).	F (1 - 1FF)	729
H1-41 (0B55)	Mbus Reg 15C0h bit1 Input Func	<b>V/f</b> <b>OLV/PM</b> <b>EZOLV</b> Sets the MFDI function assigned to <i>bit 1</i> of the MEMOBUS register <i>15C0</i> (Hex.).	F (1 - 1FF)	729
H1-42 (0B56)	Mbus Reg 15C0h bit2 Input Func	<b>V/f</b> <b>OLV/PM</b> <b>EZOLV</b> Sets the MFDI function assigned to <i>bit 2</i> of the MEMOBUS register <i>15C0</i> (Hex.).	F (1 - 1FF)	729
H1-61 (39E1) RUN	Terminal S1 On-Delay Time	<b>V/f</b> <b>OLV/PM</b> <b>EZOLV</b> Sets the length of time necessary for Terminal S1 to be closed before the drive does the programmed function.	0.00 s (0.00 - 300.00 s)	730
H1-62 (39E2) RUN	Terminal S2 On-Delay Time	<b>V/f</b> <b>OLV/PM</b> <b>EZOLV</b> Sets the length of time necessary for Terminal S2 to be closed before the drive does the programmed function.	0.00 s (0.00 - 300.00 s)	731
H1-63 (39E3) RUN	Terminal S3 On-Delay Time	<b>V/f</b> <b>OLV/PM</b> <b>EZOLV</b> Sets the length of time necessary for Terminal S3 to be closed before the drive does the programmed function.	0.00 s (0.00 - 300.00 s)	731
H1-64 (39E4) RUN	Terminal S4 On-Delay Time	<b>V/f</b> <b>OLV/PM</b> <b>EZOLV</b> Sets the length of time necessary for Terminal S4 to be closed before the drive does the programmed function.	0.00 s (0.00 - 300.00 s)	731
H1-65 (39E5) RUN	Terminal S5 On-Delay Time	<b>V/f</b> <b>OLV/PM</b> <b>EZOLV</b> Sets the length of time necessary for Terminal S5 to be closed before the drive does the programmed function.	0.00 s (0.00 - 300.00 s)	731
H1-66 (39E6) RUN	Terminal S6 On-Delay Time	<b>V/f</b> <b>OLV/PM</b> <b>EZOLV</b> Sets the length of time necessary for Terminal S6 to be closed before the drive does the programmed function.	0.00 s (0.00 - 300.00 s)	731



## 11.10 H: Terminal Functions

No. (Hex.)	Name	Description	Default (Range)	Ref.
H1-67 (39E7) RUN	Terminal S7 On-Delay Time	<b>V/f</b> <b>OLV/PM</b> <b>EZOLV</b> Sets the length of time necessary for Terminal S7 to be closed before the drive does the programmed function.	0.00 s (0.00 - 300.00 s)	731
H1-71 (39EB) RUN	Terminal S1 Off-Delay Time	<b>V/f</b> <b>OLV/PM</b> <b>EZOLV</b> Sets the length of time necessary for Terminal S1 to be open before the drive removes the programmed function.	0.00 s (0.00 - 300.00 s)	731
H1-72 (39EC) RUN	Terminal S2 Off-Delay Time	<b>V/f</b> <b>OLV/PM</b> <b>EZOLV</b> Sets the length of time necessary for Terminal S2 to be open before the drive removes the programmed function.	0.00 s (0.00 - 300.00 s)	732
H1-73 (39ED) RUN	Terminal S3 Off-Delay Time	<b>V/f</b> <b>OLV/PM</b> <b>EZOLV</b> Sets the length of time necessary for Terminal S3 to be open before the drive removes the programmed function.	0.00 s (0.00 - 300.00 s)	732
H1-74 (39EE) RUN	Terminal S4 Off-Delay Time	<b>V/f</b> <b>OLV/PM</b> <b>EZOLV</b> Sets the length of time necessary for Terminal S4 to be open before the drive removes the programmed function.	0.00 s (0.00 - 300.00 s)	732
H1-75 (39EF) RUN	Terminal S5 Off-Delay Time	<b>V/f</b> <b>OLV/PM</b> <b>EZOLV</b> Sets the length of time necessary for Terminal S5 to be open before the drive removes the programmed function.	0.00 s (0.00 - 300.00 s)	732
H1-76 (39F0) RUN	Terminal S6 Off-Delay Time	<b>V/f</b> <b>OLV/PM</b> <b>EZOLV</b> Sets the length of time necessary for Terminal S6 to be open before the drive removes the programmed function.	0.00 s (0.00 - 300.00 s)	732
H1-77 (39F1) RUN	Terminal S7 Off-Delay Time	<b>V/f</b> <b>OLV/PM</b> <b>EZOLV</b> Sets the length of time necessary for Terminal S7 to be open before the drive removes the programmed function.	0.00 s (0.00 - 300.00 s)	732

### ■ H1-xx: MFDI Setting Values

Setting Value	Function	Description	Ref.
0	3-Wire Sequence	<b>V/f</b> <b>OLV/PM</b> <b>EZOLV</b> Sets the direction of motor rotation for 3-wire sequence.	732
3	Multi-Step Speed Reference 1	<b>V/f</b> <b>OLV/PM</b> <b>EZOLV</b> Uses speed references <i>d1-01</i> to <i>d1-08</i> to set a multi-step speed reference.	733
4	Multi-Step Speed Reference 2	<b>V/f</b> <b>OLV/PM</b> <b>EZOLV</b> Uses speed references <i>d1-01</i> to <i>d1-08</i> to set a multi-step speed reference.	733
5	Multi-Step Speed Reference 3	<b>V/f</b> <b>OLV/PM</b> <b>EZOLV</b> Uses speed references <i>d1-01</i> to <i>d1-08</i> to set a multi-step speed reference.	734
6	Jog Reference Selection	<b>V/f</b> <b>OLV/PM</b> <b>EZOLV</b> Sets the drive to use the JOG Frequency Reference (JOG command) set in <i>d1-17</i> [ <i>Jog Reference</i> ]. The JOG Frequency Reference (JOG command) overrides the <i>d1-01</i> to <i>d1-08</i> [ <i>References 1 to 8</i> ] settings.	734
7	Accel/Decel Time Selection 1	<b>V/f</b> <b>OLV/PM</b> <b>EZOLV</b> Sets the drive to use <i>Acceleration/Deceleration Time 1</i> [ <i>C1-01, C1-02</i> ] or <i>Acceleration/Deceleration Time 2</i> [ <i>C1-03, C1-04</i> ].	734
8	Baseblock Command (N. O.)	<b>V/f</b> <b>OLV/PM</b> <b>EZOLV</b> Sets the command that stops drive output and coasts the motor to stop when the input is ON. ON : Baseblock (drive output stop) OFF : Normal operation	734
9	Baseblock Command (N. C.)	<b>V/f</b> <b>OLV/PM</b> <b>EZOLV</b> Sets the command that stops drive output and coasts the motor to stop when the input terminal is OFF. ON : Normal operation OFF : Baseblock (drive output stop)	734
A	Accel/Decel Ramp Hold	<b>V/f</b> <b>OLV/PM</b> <b>EZOLV</b> Momentarily pauses motor acceleration and deceleration when the terminal is turned ON, retains the output frequency that was stored in the drive at the time of the pause, and restarts motor operation.	735
B	Overheat Alarm (oH2)	<b>V/f</b> <b>OLV/PM</b> <b>EZOLV</b> Sets the drive to show an <i>oH2</i> [ <i>External Overheat (H1-XX=B)</i> ] alarm when the input terminal is ON. The alarm does not have an effect on drive operation.	735



Setting Value	Function	Description	Ref.
C	Analog Terminal Enable Selection	<b>V/f</b> <b>OLV/PM</b> <b>EZOLV</b> Sets the command that enables or disables the terminals selected in <i>H3-14 [Analog Input Terminal Enable Sel]</i> . ON : Terminal selected with <i>H3-14</i> is enabled OFF : Terminal selected with <i>H3-14</i> is disabled	735
E	ASR Integral Reset	<b>V/f</b> <b>OLV/PM</b> <b>EZOLV</b> Sets the command to reset the integral value and use PI control or P control for the speed control loop. ON : P control OFF : PI control	735
F	Not Used	<b>V/f</b> <b>OLV/PM</b> <b>EZOLV</b> Use this setting for unused terminals or to use terminals in through mode.	735
10	Up Command	<b>V/f</b> <b>OLV/PM</b> <b>EZOLV</b> Sets the command to use a push button switch to increase the drive frequency reference. You must also set <i>Setting 11 [Down Command]</i> . ON : Increases the frequency reference. OFF : Holds the current frequency reference.	735
11	Down Command	<b>V/f</b> <b>OLV/PM</b> <b>EZOLV</b> Sets the command to use a push button switch to decrease the drive frequency reference. You must also set <i>Setting 10 [Up Command]</i> . ON : Decreases the frequency reference. OFF : Holds the current frequency reference.	737
12	Forward Jog	<b>V/f</b> <b>OLV/PM</b> <b>EZOLV</b> Sets the command to operate the motor in the forward direction at the Jog Frequency set in <i>d1-17 [Jog Reference]</i> .	738
13	Reverse Jog	<b>V/f</b> <b>OLV/PM</b> <b>EZOLV</b> Sets the command to operate the motor in the reverse direction at the Jog Frequency set in <i>d1-17 [Jog Reference]</i> .	738
14	Fault Reset	<b>V/f</b> <b>OLV/PM</b> <b>EZOLV</b> Sets the command to reset the current fault when the Run command is inactive. <b>Note:</b> The drive ignores the fault reset command when the Run command is active. Remove the Run command before trying to reset a fault.	738
15	Fast Stop (N.O.)	<b>V/f</b> <b>OLV/PM</b> <b>EZOLV</b> Sets the command to ramp to stop in the deceleration time set in <i>C1-09 [Fast Stop Time]</i> when the input terminal is activated while the drive is operating.	738
16	Motor 2 Selection	<b>V/f</b> <b>OLV/PM</b> <b>EZOLV</b> Sets the command for the drive to operate motor 1 or motor 2. Stop the motors before switching. ON : Selects motor 2. OFF : Selects motor 1.	739
17	Fast Stop (N.C.)	<b>V/f</b> <b>OLV/PM</b> <b>EZOLV</b> Sets the command to ramp to stop in the deceleration time set in <i>C1-09 [Fast Stop Time]</i> when the input terminal is activated while the drive is operating.	739
18	Timer Function	<b>V/f</b> <b>OLV/PM</b> <b>EZOLV</b> Sets the command to start the timer function. Use this setting with <i>Timer Output [H2-xx = 12]</i> .	740
19	PID Disable	<b>V/f</b> <b>OLV/PM</b> <b>EZOLV</b> Sets the command to disable PID control when <i>b5-01 = 1 or 3 [PID Mode Setting = Standard or Fref + PID Trim]</i> . ON : PID control disabled OFF : PID control enabled	740
1B	Programming Lockout	<b>V/f</b> <b>OLV/PM</b> <b>EZOLV</b> Sets the command to prevent parameter changes when the terminal is OFF. ON : Programming Lockout OFF : Parameter Write Prohibit	740
1E	Reference Sample Hold	<b>V/f</b> <b>OLV/PM</b> <b>EZOLV</b> Sets the command to sample the frequency reference at terminals A1 or A2 and hold the frequency reference at that frequency.	740
20	External Fault (NO-Always-Ramp)	<b>V/f</b> <b>OLV/PM</b> <b>EZOLV</b> When the terminal activates, the drive ramps to stop in the selected deceleration time. Fault relay output terminal MA-MC will turn ON, and MB-MC will turn OFF. The drive always detects external faults whether the drive is stopped or running.	741
21	External Fault (NC-Always-Ramp)	<b>V/f</b> <b>OLV/PM</b> <b>EZOLV</b> When the terminal deactivates, the drive ramps to stop in the selected deceleration time. Fault relay output terminal MA-MC will turn ON, and MB-MC will turn OFF. The drive always detects external faults whether the drive is stopped or running.	741

## 11.10 H: Terminal Functions

Setting Value	Function	Description	Ref.
22	External Fault (NO-@Run-Ramp)	<b>V/f</b> <b>OLV/PM</b> <b>EZOLV</b> When the terminal activates during run, the drive ramps to stop in the selected deceleration time. Fault relay output terminal MA-MC will turn ON, and MB-MC will turn OFF. The drive does not detect external faults while the drive is stopped.	741
23	External Fault (NC-@Run-Ramp)	<b>V/f</b> <b>OLV/PM</b> <b>EZOLV</b> When the terminal deactivates during run, the drive ramps to stop in the selected deceleration time. Fault relay output terminal MA-MC will turn ON, and MB-MC will turn OFF. The drive does not detect external faults while the drive is stopped.	741
24	External Fault (NO-Always-Coast)	<b>V/f</b> <b>OLV/PM</b> <b>EZOLV</b> When the terminal activates, the drive shuts off the output and the motor coasts to stop. Fault relay output terminal MA-MC will turn ON, and MB-MC will turn OFF. The drive always detects external faults whether the drive is stopped or running.	741
25	External Fault (NC-Always-Coast)	<b>V/f</b> <b>OLV/PM</b> <b>EZOLV</b> When the terminal deactivates, the drive shuts off the output and the motor coasts to stop. Fault relay output terminal MA-MC will turn ON, and MB-MC will turn OFF. The drive always detects external faults whether the drive is stopped or running.	741
26	External Fault (NO-@Run-Coast)	<b>V/f</b> <b>OLV/PM</b> <b>EZOLV</b> When the terminal activates during run, the drive shuts off the output and the motor coasts to stop. Fault relay output terminal MA-MC will turn ON, and MB-MC will turn OFF. The drive does not detect external faults while the drive is stopped.	741
27	External Fault (NC-@Run-Coast)	<b>V/f</b> <b>OLV/PM</b> <b>EZOLV</b> When the terminal deactivates during run, the drive shuts off the output and the motor coasts to stop. Fault relay output terminal MA-MC will turn ON, and MB-MC will turn OFF. The drive does not detect external faults while the drive is stopped.	741
28	External Fault (NO-Always-FStop)	<b>V/f</b> <b>OLV/PM</b> <b>EZOLV</b> When the terminal activates, the drive stops the motor in the deceleration time set to <i>CI-09 [Fast Stop Time]</i> . Fault relay output terminal MA-MC turns ON, and MB-MC turns OFF. Stopped drives and running drives will detect external faults.	741
29	External Fault (NC-Always-FStop)	<b>V/f</b> <b>OLV/PM</b> <b>EZOLV</b> When the terminal deactivates, the drive stops the motor in the deceleration time set to <i>CI-09 [Fast Stop Time]</i> . Fault relay output terminal MA-MC turns ON, and MB-MC turns OFF. Stopped drives and running drives will detect external faults.	741
2A	External Fault (NO-@Run-FStop)	<b>V/f</b> <b>OLV/PM</b> <b>EZOLV</b> When the terminal activates during run, the drive stops the motor in the deceleration time set to <i>CI-09 [Fast Stop Time]</i> . Fault relay output terminal MA-MC turns ON, and MB-MC turns OFF. Stopped drives will not detect external faults.	741
2B	External Fault (NC-@Run-FStop)	<b>V/f</b> <b>OLV/PM</b> <b>EZOLV</b> When the terminal deactivates during run, the drive stops the motor in the deceleration time set to <i>CI-09 [Fast Stop Time]</i> . Fault relay output terminal MA-MC turns ON, and MB-MC turns OFF. Stopped drives will not detect external faults.	741
2C	External Fault (NO-Always-Alarm)	<b>V/f</b> <b>OLV/PM</b> <b>EZOLV</b> When the terminal activates, the keypad shows <i>EFx [External Fault (Terminal Sx)]</i> and the output terminal set for <i>Alarm [H2-01 to H2-03 = 10]</i> activates. The drive continues operation. The drive always detects external faults whether the drive is stopped or running.	741
2D	External Fault (NC-Always-Alarm)	<b>V/f</b> <b>OLV/PM</b> <b>EZOLV</b> When the terminal deactivates, the keypad shows <i>EFx [External Fault (Terminal Sx)]</i> and the output terminal set for <i>Alarm [H2-01 to H2-03 = 10]</i> activates. The drive continues operation. The drive always detects external faults whether the drive is stopped or running.	741
2E	External Fault (NO-@Run-Alarm)	<b>V/f</b> <b>OLV/PM</b> <b>EZOLV</b> When the terminal activates during run, the keypad shows <i>EFx [External Fault (Terminal Sx)]</i> and the output terminal set for <i>Alarm [H2-01 to H2-03 = 10]</i> activates. The drive continues operation. The drive does not detect external faults while the drive is stopped.	741
2F	External Fault (NC-@Run-Alarm)	<b>V/f</b> <b>OLV/PM</b> <b>EZOLV</b> When the terminal deactivates during run, the keypad shows <i>EFx [External Fault (Terminal Sx)]</i> and the output terminal set for <i>Alarm [H2-01 to H2-03 = 10]</i> activates. The drive continues operation. The drive does not detect external faults while the drive is stopped.	741
30	PID Integrator Reset	<b>V/f</b> <b>OLV/PM</b> <b>EZOLV</b> Sets the command to reset and hold the PID control integral to 0 when the terminal is ON.	742
31	PID Integrator Hold	<b>V/f</b> <b>OLV/PM</b> <b>EZOLV</b> Sets the command to hold the integral value of the PID control while the terminal is activated.	742
34	PID Soft Starter Disable	<b>V/f</b> <b>OLV/PM</b> <b>EZOLV</b> Sets the PID soft starter function. ON : Disable OFF : Enabled	742
35	PID Input (Error) Invert	<b>V/f</b> <b>OLV/PM</b> <b>EZOLV</b> Sets the command to turn the terminal ON and OFF to switch the PID input level (polarity).	742

Setting Value	Function	Description	Ref.
3E	PID Setpoint Selection 1	<p><b>V/f</b> <b>OLV/PM</b> <b>EZOLV</b></p> <p>Sets the function to switch the PID setpoint to <i>YA-02</i> [Setpoint 2] or <i>YA-04</i> [Setpoint 4]. Set this function and <i>H1-xx = 3F</i> [PID Setpoint Selection 2] at the same time.</p> <p><b>Note:</b></p> <p>If you use this function and one of <i>H1-xx = 83 to 85</i> [Dedicated Multi-Setpoint <i>YA-02</i> to <i>YA-04</i>] at the same time, the drive will detect an <i>oPE03</i> [Multi-Function Input Setting Err].</p> <p>ON : <i>YA-02</i> or <i>YA-04</i> is PID setpoint.</p> <p>OFF : The frequency reference, <i>YA-01</i> [Setpoint 1], or <i>YA-03</i> [Setpoint 3] is PID setpoint.</p>	743
3F	PID Setpoint Selection 2	<p><b>V/f</b> <b>OLV/PM</b> <b>EZOLV</b></p> <p>Sets the function to switch the PID setpoint to <i>YA-03</i> [Setpoint 3] or <i>YA-04</i> [Setpoint 4]. Set this function and <i>H1-xx = 3E</i> [PID Setpoint Selection 1] at the same time.</p> <p><b>Note:</b></p> <p>If you use this function and one of <i>H1-xx = 83 to 85</i> [Dedicated Multi-Setpoint <i>YA-02</i> to <i>YA-04</i>] at the same time, the drive will detect an <i>oPE03</i> [Multi-Function Input Setting Err].</p> <p>ON : <i>YA-03</i> or <i>YA-04</i> is PID setpoint.</p> <p>OFF : The frequency reference, <i>YA-01</i> [Setpoint 1], or <i>YA-02</i> [Setpoint 2] is PID setpoint.</p>	743
40	Forward RUN (2-Wire)	<p><b>V/f</b> <b>OLV/PM</b> <b>EZOLV</b></p> <p>Sets the Forward Run command for 2-wire sequence 1. Set this function and <i>H1-xx = 41</i> [Reverse RUN (2-Wire)] together.</p> <p>ON : Forward Run</p> <p>OFF : Stop</p> <p><b>Note:</b></p> <ul style="list-style-type: none"> <li>If you turn ON the Forward Run command terminal and the Reverse Run command terminal, it will cause an <i>EF</i> [FWD/REV Run Command Input Error] alarm and the motor will ramp to stop.</li> <li>Initialize the drive with a 2-wire sequence to set the Forward Run command to terminal S1.</li> <li>This function will not operate at the same time as <i>H1-xx = 42, 43</i> [Run Command (2-Wire Sequence 2), FWD/REV (2-Wire Sequence 2)].</li> </ul>	743
41	Reverse RUN (2-Wire)	<p><b>V/f</b> <b>OLV/PM</b> <b>EZOLV</b></p> <p>Sets the Reverse Run command for 2-wire sequence 1. Set this function and <i>H1-xx = 40</i> [Forward RUN (2-Wire)] together.</p> <p>ON : Reverse Run</p> <p>OFF : Stop</p> <p><b>Note:</b></p> <ul style="list-style-type: none"> <li>If you turn ON the Forward Run command terminal and the Reverse Run command terminal, it will cause an <i>EF</i> [FWD/REV Run Command Input Error] alarm and the motor will ramp to stop.</li> <li>Initialize the drive with a 2-wire sequence to set the Reverse Run command to terminal S2.</li> <li>This function will not operate at the same time as <i>H1-xx = 42, 43</i> [Run Command (2-Wire Sequence 2), FWD/REV (2-Wire Sequence 2)].</li> </ul>	743
42	Run Command (2-Wire Sequence 2)	<p><b>V/f</b> <b>OLV/PM</b> <b>EZOLV</b></p> <p>Sets the Run command for 2-wire sequence 2. Set this function and <i>H1-xx = 43</i> [FWD/REV (2-Wire Sequence 2)] together.</p> <p>ON : Run</p> <p>OFF : Stop</p> <p><b>Note:</b></p> <p>This function will not operate at the same time as <i>H1-xx = 40, 41</i> [Forward RUN (2-Wire), Reverse RUN (2-Wire)].</p>	744
43	FWD/REV (2-Wire Sequence 2)	<p><b>V/f</b> <b>OLV/PM</b> <b>EZOLV</b></p> <p>Sets the direction of motor rotation for 2-wire sequence 2. Set this function and <i>H1-xx = 42</i> [Run Command (2-Wire Sequence 2)] together.</p> <p>ON : Reverse Run</p> <p>OFF : Forward Run</p> <p><b>Note:</b></p> <ul style="list-style-type: none"> <li>You must input the Run command to rotate the motor.</li> <li>This function will not operate at the same time as <i>H1-xx = 40, 41</i> [Forward RUN (2-Wire), Reverse RUN (2-Wire)].</li> </ul>	744
44	Add Offset Frequency 1 (d7-01)	<p><b>V/f</b> <b>OLV/PM</b> <b>EZOLV</b></p> <p>Sets the function to add the offset frequency set in <i>d7-01</i> [Offset Frequency 1] to the frequency reference when the terminal activates.</p>	744
45	Add Offset Frequency 2 (d7-02)	<p><b>V/f</b> <b>OLV/PM</b> <b>EZOLV</b></p> <p>Sets the function to add the offset frequency set in <i>d7-02</i> [Offset Frequency 2] to the frequency reference when the terminal activates.</p>	744
46	Add Offset Frequency 3 (d7-03)	<p><b>V/f</b> <b>OLV/PM</b> <b>EZOLV</b></p> <p>Sets the function to add the offset frequency set in <i>d7-03</i> [Offset Frequency 3] to the frequency reference when the terminal activates.</p>	744
50	Motor Pre-heat 2	<p><b>V/f</b> <b>OLV/PM</b> <b>EZOLV</b></p> <p>Sets the command to apply the motor pre-heat current set in <i>b2-09</i> [Pre-heat Current 2].</p>	745
51	Sequence Timer Disable	<p><b>V/f</b> <b>OLV/PM</b> <b>EZOLV</b></p> <p>Sets the command to disable Sequence Timers.</p> <p>ON : Sequence Timer is Disabled</p>	745

## 11.10 H: Terminal Functions

Setting Value	Function	Description	Ref.
52	Sequence Timer Cancel	<b>V/f</b> <b>OLV/PM</b> <b>EZOLV</b> Sets the command to cancel the currently active Sequence Timer. ON : Cancel Active Sequence Timer	745
60	DC Injection Braking Command	<b>V/f</b> <b>OLV/PM</b> <b>EZOLV</b> Sets the command to use DC Injection Braking to stop the motor. <b>Note:</b> When $A1-02 = 8$ [Control Method Selection = EZOLV], this function is available with a PM motor.	745
61	Speed Search from Fmax	<b>V/f</b> <b>OLV/PM</b> <b>EZOLV</b> Sets the function to use an external reference to start speed search although $b3-01 = 0$ [Speed Search Selection at Start = Disabled] to not allow speed search at start. <b>Note:</b> The drive will detect $oPE03$ [Multi-Function Input Setting Err] when $H1-xx = 61$ [Speed Search from Fmax] and $H1-xx = 62$ [Speed Search from Fref] are set at the same time.	745
62	Speed Search from Fref	<b>V/f</b> <b>OLV/PM</b> <b>EZOLV</b> Sets the function to use an external reference to start speed search although $b3-01 = 0$ [Speed Search Selection at Start = Disabled] to not allow speed search at start. <b>Note:</b> The drive will detect $oPE03$ [Multi-Function Input Setting Err] when $H1-xx = 61$ [Speed Search from Fmax] and $H1-xx = 62$ [Speed Search from Fref] are set at the same time.	746
63	Field Weakening	<b>V/f</b> <b>OLV/PM</b> <b>EZOLV</b> Sets the function to send the Field Weakening Level and Field Weakening Frequency Limit commands set in $d6-01$ [Field Weakening Level] and $d6-02$ [Field Weakening Frequency Limit] when the input terminal is activated.	746
65	KEB Ride-Thru 1 Activate (N.C.)	<b>V/f</b> <b>OLV/PM</b> <b>EZOLV</b> Sets operation of the KEB1 function through the KEB Ride-Thru 1 (N.C.). ON : Normal operation OFF : Deceleration during momentary power loss	746
66	KEB Ride-Thru 1 Activate (N.O.)	<b>V/f</b> <b>OLV/PM</b> <b>EZOLV</b> Sets operation of the KEB1 function through the KEB Ride-Thru 1 (N.O.). ON : Deceleration during momentary power loss OFF : Normal operation	746
67	Communications Test Mode	<b>V/f</b> <b>OLV/PM</b> <b>EZOLV</b> Set the function for the drive to self-test RS-485 serial communications operation.	747
68	High Slip Braking (HSB) Activate	<b>V/f</b> <b>OLV/PM</b> <b>EZOLV</b> Sets the command to use high-slip braking to stop the motor.	747
69	Jog Run 2	<b>V/f</b> <b>OLV/PM</b> <b>EZOLV</b> Causes the drive to ramp to the $d1-17$ [Jog Reference] frequency. The forward/reverse command from the 3-wire or 2-wire 2 sequence sets the direction.	747
6A	Drive Enable	<b>V/f</b> <b>OLV/PM</b> <b>EZOLV</b> Sets the function to show $dnE$ [Drive Disabled] on the keypad and ignore Run commands when the terminal is OFF.	747
6D	AUTO Command	<b>V/f</b> <b>OLV/PM</b> <b>EZOLV</b> Sets the command to operate the drive in AUTO Mode. ON : AUTO Mode OFF : OFF Mode or HAND Mode	747
6E	HAND Command	<b>V/f</b> <b>OLV/PM</b> <b>EZOLV</b> Sets the command to operate the drive in HAND Mode. ON : HAND Mode OFF : OFF Mode or AUTO Mode	748
70	Drive Enable 2	<b>V/f</b> <b>OLV/PM</b> <b>EZOLV</b> Sets the function to show $dnE$ [Drive Enabled] on the keypad and ignore Run commands when the terminal is OFF. ON : Run command is accepted. OFF : Run command is disabled. When the drive is running, it stops according to $b1-03$ setting.	748
77	ASR Gain (C5-03) Select	<b>V/f</b> <b>OLV/PM</b> <b>EZOLV</b> Sets the function to switch the ASR proportional gain to $C5-01$ [ASR Proportional Gain 1] or $C5-03$ [ASR Proportional Gain 2]. ON : C5-03 OFF : C5-01	748
7A	KEB Ride-Thru 2 Activate (N.C.)	<b>V/f</b> <b>OLV/PM</b> <b>EZOLV</b> Sets operation of the KEB2 function through the KEB Ride-Thru 2 (N.C.). ON : Normal operation OFF : Deceleration during momentary power loss	748

Setting Value	Function	Description	Ref.
7B	KEB Ride-Thru 2 Activate (N.O.)	<p><b>V/f</b> <b>OLV/PM</b> <b>EZOLV</b></p> <p>Sets operation of the KEB2 function through the KEB Ride-Thru 2 (N.O.). ON : Deceleration during momentary power loss OFF : Normal operation</p>	749
7C	Short Circuit Braking (N.O.)	<p><b>V/f</b> <b>OLV/PM</b> <b>EZOLV</b></p> <p>Sets operation of Short Circuit Braking (N.O.). ON : Short Circuit Braking is enabled. OFF : Normal operation</p> <p><b>Note:</b> When <math>A1-02 = 8</math> [Control Method Selection = EZOLV], this function is available only when you use a PM motor.</p>	749
7D	Short Circuit Braking (N.C.)	<p><b>V/f</b> <b>OLV/PM</b> <b>EZOLV</b></p> <p>Sets operation of Short Circuit Braking (N.C.). ON : Normal operation OFF : Short Circuit Braking is enabled.</p> <p><b>Note:</b> When <math>A1-02 = 8</math> [Control Method Selection = EZOLV], this function is available only when you use a PM motor.</p>	749
82	PI Switch to Aux	<p><b>V/f</b> <b>OLV/PM</b> <b>EZOLV</b></p> <p>Sets <math>YF-xx</math> [PI Auxiliary Control] parameters as primary PI loop parameters and disables <math>b5-xx</math> [PID Control].</p> <p><b>Note:</b> When this input is active, <math>YF-xx</math> [PI Auxiliary Control] parameters will always be the primary PI loop parameters. Parameter <math>YF-20</math> [PI Aux Main PI Speed Control] does not have an effect.</p>	749
83	Dedicated Multi-Setpoint YA-02	<p><b>V/f</b> <b>OLV/PM</b> <b>EZOLV</b></p> <p>Sets the function to set the PID setpoint to <math>YA-02</math> [Setpoint 2].</p> <p><b>Note:</b> If you use this function and one of <math>H1-xx = 3E</math> or <math>3F</math> [PID Setpoint Selection 1 or 2] at the same time, the drive will detect an <math>oPE03</math> [Multi-Function Input Setting Err]. ON : <math>YA-02</math> is PID setpoint. OFF : <math>YA-01</math> [Setpoint 1], <math>YA-03</math> [Setpoint 3], or <math>YA-04</math> [Setpoint 4] is PID setpoint.</p>	749
84	Dedicated Multi-Setpoint YA-03	<p><b>V/f</b> <b>OLV/PM</b> <b>EZOLV</b></p> <p>Sets the function to set the PID setpoint to <math>YA-03</math> [Setpoint 3]. Set this function and <math>H1-xx = 83</math> [Dedicated Multi-Setpoint <math>YA-02</math>] at the same time.</p> <p><b>Note:</b> If you use this function and one of <math>H1-xx = 3E</math> or <math>3F</math> [PID Setpoint Selection 1 or 2] at the same time, the drive will detect an <math>oPE03</math> [Multi-Function Input Setting Err]. ON : <math>YA-03</math> is PID setpoint. OFF : <math>YA-01</math> [Setpoint 1], <math>YA-02</math> [Setpoint 2], or <math>YA-04</math> [Setpoint 4] is PID setpoint.</p>	750
85	Dedicated Multi-Setpoint YA-04	<p><b>V/f</b> <b>OLV/PM</b> <b>EZOLV</b></p> <p>Sets the function to set the PID setpoint to <math>YA-04</math> [Setpoint 4]. Set this function, <math>H1-xx = 83</math> [Dedicated Multi-Setpoint <math>YA-02</math>], and <math>H1-xx = 84</math> [Dedicated Multi-Setpoint <math>YA-03</math>] at the same time.</p> <p><b>Note:</b> If you use this function and one of <math>H1-xx = 3E</math> or <math>3F</math> [PID Setpoint Selection 1 or 2] at the same time, the drive will detect an <math>oPE03</math> [Multi-Function Input Setting Err]. ON : <math>YA-04</math> is PID setpoint. OFF : <math>YA-01</math> [Setpoint 1], <math>YA-02</math> [Setpoint 2], or <math>YA-03</math> [Setpoint 3] is PID setpoint.</p>	750
88	Thermostat Fault	<p><b>V/f</b> <b>OLV/PM</b> <b>EZOLV</b></p> <p>Sets the drive to show the <math>VLTS</math> [Thermostat Fault] when the input terminal is ON.</p> <p><b>Note:</b> This function is active when the drive is running.</p>	750
90	DWEZ Digital Input 1	<p><b>V/f</b> <b>OLV/PM</b> <b>EZOLV</b></p> <p>Sets digital input 1 to use in DriveWorksEZ. Refer to the DriveWorksEZ online manual for more information.</p>	750
91	DWEZ Digital Input 2	<p><b>V/f</b> <b>OLV/PM</b> <b>EZOLV</b></p> <p>Sets digital input 2 to use in DriveWorksEZ. Refer to the DriveWorksEZ online manual for more information.</p>	750
92	DWEZ Digital Input 3	<p><b>V/f</b> <b>OLV/PM</b> <b>EZOLV</b></p> <p>Sets digital input 3 to use in DriveWorksEZ. Refer to the DriveWorksEZ online manual for more information.</p>	750
93	DWEZ Digital Input 4	<p><b>V/f</b> <b>OLV/PM</b> <b>EZOLV</b></p> <p>Sets digital input 4 to use in DriveWorksEZ. Refer to the DriveWorksEZ online manual for more information.</p>	750
94	DWEZ Digital Input 5	<p><b>V/f</b> <b>OLV/PM</b> <b>EZOLV</b></p> <p>Sets digital input 5 to use in DriveWorksEZ. Refer to the DriveWorksEZ online manual for more information.</p>	750
95	DWEZ Digital Input 6	<p><b>V/f</b> <b>OLV/PM</b> <b>EZOLV</b></p> <p>Sets digital input 6 to use in DriveWorksEZ. Refer to the DriveWorksEZ online manual for more information.</p>	750
96	DWEZ Digital Input 7	<p><b>V/f</b> <b>OLV/PM</b> <b>EZOLV</b></p> <p>Sets digital input 7 to use in DriveWorksEZ. Refer to the DriveWorksEZ online manual for more information.</p>	750

## 11.10 H: Terminal Functions

Setting Value	Function	Description	Ref.
9F	DWEZ Disable	<p><b>V/f</b> <b>OLV/PM</b> <b>EZOLV</b></p> <p>Sets operation of the DriveWorksEZ program saved in the drive.            ON : Disabled            OFF : Enabled  <b>Note:</b>            Set <math>A1-07 = 2</math> [<i>DriveWorksEZ Function Selection = Enabled/Disabled wDigital Input</i>] to use this function.</p>	750
A8	PI2 Control Disable	<p><b>V/f</b> <b>OLV/PM</b> <b>EZOLV</b></p> <p>Sets the command to disable the PI2 Control function. Parameter <math>S3-12</math> [<i>PI2 Control Disable Mode Sel</i>] sets the output performance.            ON : Enabled            OFF : Disabled</p>	751
AA	PI2 Control Inverse Operation	<p><b>V/f</b> <b>OLV/PM</b> <b>EZOLV</b></p> <p>Sets the command to change the sign of the PI2 Control input.</p>	751
AB	PI2 Control Integral Reset	<p><b>V/f</b> <b>OLV/PM</b> <b>EZOLV</b></p> <p>Sets the command to reset the PI2 Control integral value.  <b>Note:</b>            This input has priority over <math>H1-xx = AC</math> [<i>MFDI Function Selection = PI2 Control Integral Hold</i>].</p>	751
AC	PI2 Control Integral Hold	<p><b>V/f</b> <b>OLV/PM</b> <b>EZOLV</b></p> <p>Sets the command to lock the PI2 Control integral value.</p>	751
AD	Select PI2 Control PI Parameters	<p><b>V/f</b> <b>OLV/PM</b> <b>EZOLV</b></p> <p>Sets the command to use the <math>S3-06</math> [<i>PI2 Control Proportional Gain</i>] and <math>S3-07</math> [<i>PI2 Control Integral Time</i>] values instead of the <math>b5-02</math> [<i>Proportional Gain (P)</i>] and <math>b5-03</math> [<i>Integral Time (I)</i>] values. Set <math>S3-01 = 0</math> [<i>PI2 Control Enable Selection = Disabled</i>] to enable this function.  <b>Note:</b>            This multi-function input does not have an effect on PI2 Control. Use this input for the primary PI controller (<math>b5-xx</math>).</p>	751
AF	Emergency Override FWD	<p><b>V/f</b> <b>OLV/PM</b> <b>EZOLV</b></p> <p>Sets the command to use the speed set in <math>S6-02</math> [<i>Emergency Override Ref Selection</i>] to run the drive in the forward direction.</p>	751
B0	Emergency Override REV	<p><b>V/f</b> <b>OLV/PM</b> <b>EZOLV</b></p> <p>Sets the command to use the speed set in <math>S6-02</math> [<i>Emergency Override Ref Selection</i>] to run the drive in the reverse direction.</p>	751
B1	Customer Safeties	<p><b>V/f</b> <b>OLV/PM</b> <b>EZOLV</b></p> <p>Sets the command to show that customer safeties are in place.</p>	751
B2	BAS Interlock	<p><b>V/f</b> <b>OLV/PM</b> <b>EZOLV</b></p> <p>Sets the command to show that the dampers are open.</p>	752
B8	Low City Pressure	<p><b>V/f</b> <b>OLV/PM</b> <b>EZOLV</b></p> <p>Sets the command to show that there is not sufficient pressure at the inlet to the pump.            OFF : Insufficient pressure is present on the inlet to the pump  <b>Note:</b>            When <math>Y1-01 = 3</math> [<i>Multiplex Mode = Memobus Network</i>], this function will activate on any drive in the network. An alarm condition will cause other drives in the network to stop the operation and show a "Network Drive Error" "Check Faulted Drive" message.</p>	752
B9	Disable Pre-charge	<p><b>V/f</b> <b>OLV/PM</b> <b>EZOLV</b></p> <p>Sets the command to disable the Pre-charge function.            ON : Pre-charge function is disabled</p>	752
188	!Thermostat Fault	<p><b>V/f</b> <b>OLV/PM</b> <b>EZOLV</b></p> <p>Sets the drive to show the <math>VLTS</math> [<i>Thermostat Fault</i>] when the input terminal is OFF.  <b>Note:</b>            This function is active when the drive is running.</p>	752
1A8	!PI2 Control Disable	<p><b>V/f</b> <b>OLV/PM</b> <b>EZOLV</b></p> <p>Sets the command to disable the PI2 Control function. Parameter <math>S3-12</math> [<i>PI2 Control Disable Mode Sel</i>] sets the output performance.            ON : Disabled            OFF : Enabled</p>	752
1B8	!Low City Pressure	<p><b>V/f</b> <b>OLV/PM</b> <b>EZOLV</b></p> <p>Sets the command to show that there is not sufficient pressure at the inlet to the pump.            ON : Insufficient pressure is present on the inlet to the pump  <b>Note:</b>            When <math>Y1-01 = 3</math> [<i>Multiplex Mode = Memobus Network</i>], this function will activate on any drive in the network. An alarm condition will cause other drives in the network to stop the operation and show a "Network Drive Error" "Check Faulted Drive" message.</p>	752

## ◆ H2: Digital Outputs

No. (Hex.)	Name	Description	Default (Range)	Ref.
H2-01 (040B)	Term M1-M2 Function Selection	<p><b>V/f</b> <b>OLV/PM</b> <b>EZOLV</b></p> <p>Sets the function for MFDO terminal M1-M2.</p> <p><b>Note:</b> Set this parameter to <i>F</i> when the terminal is not being used or to use the terminal in through mode.</p>	0 (0 - 1FF)	755
H2-02 (040C)	Term M3-M4 Function Selection	<p><b>V/f</b> <b>OLV/PM</b> <b>EZOLV</b></p> <p>Sets the function for MFDO terminal M3-M4.</p> <p><b>Note:</b> Set this parameter to <i>F</i> when the terminal is not being used or to use the terminal in through mode.</p>	1 (0 - 1FF)	755
H2-03 (040D)	Term M5-M6 Function Selection	<p><b>V/f</b> <b>OLV/PM</b> <b>EZOLV</b></p> <p>Sets the function for MFDO terminal M5-M6.</p> <p><b>Note:</b> When you do not use this terminal, or when you will use the terminal in through mode, set this parameter to <i>F</i>.</p>	2 (0 - 1FF)	755
H2-06 (0437)	Watt Hour Output Unit Selection	<p><b>V/f</b> <b>OLV/PM</b> <b>EZOLV</b></p> <p>Sets the unit for the output signal when <i>H2-01 to H2-03 = 39</i> [MFDO Function Selection = Watt Hour Pulse Output].</p> <p>0 : 0.1 kWh units 1 : 1 kWh units 2 : 10 kWh units 3 : 100 kWh units 4 : 1000 kWh units</p>	0 (0 - 4)	755
H2-07 (0B3A)	Modbus Register 1 Address Select	<p><b>V/f</b> <b>OLV/PM</b> <b>EZOLV</b></p> <p>Sets the address of the MEMOBUS/Modbus register output to the MFDO terminal.</p>	0001 (0001 - 1FFF)	756
H2-08 (0B3B)	Modbus Register 1 Bit Select	<p><b>V/f</b> <b>OLV/PM</b> <b>EZOLV</b></p> <p>Sets the bit of the MEMOBUS/Modbus register output to the MFDO terminal.</p>	0000 (0000 - FFFF)	756
H2-09 (0B3C)	Modbus Register 2 Address Select	<p><b>V/f</b> <b>OLV/PM</b> <b>EZOLV</b></p> <p>Sets the address of the MEMOBUS/Modbus register output to the MFDO terminal.</p>	0001 (0001 - 1FFF)	756
H2-10 (0B3D)	Modbus Register 2 Bit Select	<p><b>V/f</b> <b>OLV/PM</b> <b>EZOLV</b></p> <p>Sets the bit of the MEMOBUS/Modbus register output to the MFDO terminal.</p>	0000 (0000 - FFFF)	756
H2-40 (0B58)	Mbus Reg 15E0h bit0 Output Func	<p><b>V/f</b> <b>OLV/PM</b> <b>EZOLV</b></p> <p>Sets the MFDO for bit 0 of MEMOBUS register 15E0 (Hex.).</p>	F (0 - 1FF)	756
H2-41 (0B59)	Mbus Reg 15E0h bit1 Output Func	<p><b>V/f</b> <b>OLV/PM</b> <b>EZOLV</b></p> <p>Sets the MFDO for bit 1 of MEMOBUS register 15E0 (Hex.).</p>	F (0 - 1FF)	756
H2-42 (0B5A)	Mbus Reg 15E0h bit2 Output Func	<p><b>V/f</b> <b>OLV/PM</b> <b>EZOLV</b></p> <p>Sets the MFDO for bit 2 of MEMOBUS register 15E0 (Hex.).</p>	F (0 - 1FF)	757
H2-60 (1B46) Expert	Term M1-M2 Secondary Function	<p><b>V/f</b> <b>OLV/PM</b> <b>EZOLV</b></p> <p>Sets the second function for terminal M1-M2. Outputs the logical calculation results of the terminals assigned to functions by <i>H2-01</i> [Term M1-M2 Function Selection].</p>	F (0 - FF)	757
H2-61 (1B47) Expert	Terminal M1-M2 Logical Operation	<p><b>V/f</b> <b>OLV/PM</b> <b>EZOLV</b></p> <p>Sets the logical operation for the functions set in <i>H2-01</i> [Term M1-M2 Function Selection] and <i>H2-60</i> [Term M1-M2 Secondary Function].</p>	0 (0 - 8)	757
H2-62 (1B48) Expert	Terminal M1-M2 Delay Time	<p><b>V/f</b> <b>OLV/PM</b> <b>EZOLV</b></p> <p>Sets the minimum on time used to output the logical calculation results from terminal M1-M2.</p>	0.1 s (0.0 - 25.0 s)	757
H2-63 (1B49) Expert	Term M3-M4 Secondary Function	<p><b>V/f</b> <b>OLV/PM</b> <b>EZOLV</b></p> <p>Sets the second function for terminal M3-M4. Outputs the logical calculation results of the terminals assigned to functions by <i>H2-02</i> [Term M3-M4 Function Selection].</p>	F (0 - FF)	757
H2-64 (1B4A) Expert	Terminal M3-M4 Logical Operation	<p><b>V/f</b> <b>OLV/PM</b> <b>EZOLV</b></p> <p>Sets the logical operation for the functions set in <i>H2-02</i> [Term M3-M4 Function Selection] and <i>H2-63</i> [Term M3-M4 Secondary Function].</p>	0 (0 - 8)	757
H2-65 (1B4B) Expert	Terminal M3-M4 Delay Time	<p><b>V/f</b> <b>OLV/PM</b> <b>EZOLV</b></p> <p>Sets the minimum on time used to output the logical calculation results from terminal M3-M4.</p>	0.1 s (0.0 - 25.0 s)	757



## 11.10 H: Terminal Functions

No. (Hex.)	Name	Description	Default (Range)	Ref.
H2-66 (1B4C) Expert	Term M5-M6 Secondary Function	<b>V/f</b> <b>OLV/PM</b> <b>EZOLV</b> Sets the second function for terminal M5-M6. Outputs the logical calculation results of the terminals assigned to functions by H2-03 [Terminal M5-M6 Function Selection].	F (0 - FF)	758
H2-67 (1B4D) Expert	Terminal M5-M6 Logical Operation	<b>V/f</b> <b>OLV/PM</b> <b>EZOLV</b> Sets the logical operation for the functions set in H2-03 [Term M5-M6 Function Selection] and H2-66 [Term M5-M6 Secondary Function].	0 (0 - 8)	758
H2-68 (1B4E) Expert	Terminal M5-M6 Delay Time	<b>V/f</b> <b>OLV/PM</b> <b>EZOLV</b> Sets the minimum on time used to output the logical calculation results from terminal M5-M6.	0.1 s (0.0 - 25.0 s)	758

### ■ H2-xx: MFDO Setting Values

Setting Value	Function	Description	Ref.
0	During Run	<b>V/f</b> <b>OLV/PM</b> <b>EZOLV</b> The terminal activates when you input a Run command and when the drive is outputting voltage. ON : Drive is running OFF : Drive is stopping	758
1	Zero Speed	<b>V/f</b> <b>OLV/PM</b> <b>EZOLV</b> The terminal activates when the output frequency < E1-09 [Minimum Output Frequency]. <b>Note:</b> Parameter E1-09 is the reference in all control methods. ON : Output frequency < E1-09. OFF : Output frequency ≥ E1-09.	758
2	Speed Agree 1	<b>V/f</b> <b>OLV/PM</b> <b>EZOLV</b> The terminal activates when the output frequency is in the range of the frequency reference ± L4-02 [Speed Agree Detection Width]. <b>Note:</b> The detection function operates in the two motor rotation directions. ON : The output frequency is in the range of "frequency reference ± L4-02". OFF : The output frequency does not align with the frequency reference although the drive is running.	759
3	User-Set Speed Agree 1	<b>V/f</b> <b>OLV/PM</b> <b>EZOLV</b> The terminal activates when the output frequency is in the range of L4-01 [Speed Agree Detection Level] ± L4-02 [Speed Agree Detection Width] and in the range of the frequency reference ± L4-02. <b>Note:</b> The detection function operates in the two motor rotation directions. The drive uses the L4-01 value as the forward/reverse detection level. ON : The output frequency is in the range of "L4-01 ± L4-02" and the range of frequency reference ± L4-02. OFF : The output frequency is not in the range of "L4-01 ± L4-02" or the range of frequency reference ± L4-02.	759
4	Frequency Detection 1	<b>V/f</b> <b>OLV/PM</b> <b>EZOLV</b> The terminal deactivates when the output frequency > "L4-01 [Speed Agree Detection Level] + L4-02 [Speed Agree Detection Width]". After the terminal deactivates, the terminal stays deactivated until the output frequency is at the value of L4-01. <b>Note:</b> The detection function operates in the two motor rotation directions. The drive uses the L4-01 value as the forward/reverse detection level. ON : The output frequency < L4-01, or the output frequency ≤ "L4-01 + L4-02" OFF : The output frequency > "L4-01 + L4-02"	760
5	Frequency Detection 2	<b>V/f</b> <b>OLV/PM</b> <b>EZOLV</b> The terminal activates when the output frequency > L4-01 [Speed Agree Detection Level]. After the terminal activates, the terminal stays activated until the output frequency is at the value of "L4-01 - L4-02 [Speed Agree Detection Width]". <b>Note:</b> The detection function operates in the two motor rotation directions. The drive uses the L4-01 value as the forward/reverse detection level. ON : The output frequency > L4-01 OFF : The output frequency < "L4-01 - L4-02", or the output frequency ≤ L4-01	760
6	Drive Ready	<b>V/f</b> <b>OLV/PM</b> <b>EZOLV</b> The terminal activates when the drive is ready and running.	761
7	DC Bus Undervoltage	<b>V/f</b> <b>OLV/PM</b> <b>EZOLV</b> The terminal activates when the DC bus voltage or control circuit power supply is at the voltage set in L2-05 [Undervoltage Detection Lvl (Uv1)] or less. The terminal also activates when there is a fault with the DC bus voltage. ON : The DC bus voltage ≤ L2-05 OFF : The DC bus voltage > L2-05	761



Setting Value	Function	Description	Ref.
8	During Baseblock (N.O.)	<p><b>V/f</b> <b>OLV/PM</b> <b>EZOLV</b></p> <p>The terminal activates during baseblock. When the drive is in baseblock, the drive output transistor stops switching and does not make DC bus voltage. ON : During baseblock OFF : The drive is not in baseblock.</p>	761
9	Frequency Reference from Keypad	<p><b>V/f</b> <b>OLV/PM</b> <b>EZOLV</b></p> <p>Shows the selected frequency reference source. ON : The keypad is the frequency reference source. OFF : Parameter <i>b1-01</i> [Frequency Reference Selection 1] is the frequency reference source.</p>	761
B	Torque Detection 1 (N.O.)	<p><b>V/f</b> <b>OLV/PM</b> <b>EZOLV</b></p> <p>The terminal activates when the drive detects overtorque or undertorque. ON : The output current/torque &gt; <i>L6-02</i> [Torque Detection Level 1], or the output current/torque &lt; <i>L6-02</i> for longer than the time set in <i>L6-03</i> [Torque Detection Time 1].</p>	762
C	Frequency Reference Loss	<p><b>V/f</b> <b>OLV/PM</b> <b>EZOLV</b></p> <p>The terminal activates when the drive detects a loss of frequency reference.</p>	762
E	Fault	<p><b>V/f</b> <b>OLV/PM</b> <b>EZOLV</b></p> <p>The terminal activates when the drive detects a fault. <b>Note:</b> The terminal will not activate for <i>CPF00</i> and <i>CPF01</i> [Control Circuit Error] faults.</p>	762
F	Not Used	<p><b>V/f</b> <b>OLV/PM</b> <b>EZOLV</b></p> <p>Use this setting for unused terminals or to use terminals in through mode. Also use this setting as the PLC contact output via MEMOBUS/Modbus or the communication option. This signal does not function if you do not configure signals from the PLC.</p>	762
10	Alarm	<p><b>V/f</b> <b>OLV/PM</b> <b>EZOLV</b></p> <p>The terminal activates when the drive detects a minor fault.</p>	762
11	Fault Reset Command Active	<p><b>V/f</b> <b>OLV/PM</b> <b>EZOLV</b></p> <p>The terminal activates when the drive receives the Reset command from the control circuit terminal, serial communications, or the communication option.</p>	762
12	Timer Output	<p><b>V/f</b> <b>OLV/PM</b> <b>EZOLV</b></p> <p>Sets the terminal as the timer output. Use this setting with the timer input set in <i>H1-xx</i> = 18 [MFDI Function Selection = Timer Function].</p>	762
13	Speed Agree 2	<p><b>V/f</b> <b>OLV/PM</b> <b>EZOLV</b></p> <p>The terminal activates when the output frequency is in the range of the frequency reference <math>\pm L4-04</math> [Speed Agree Detection Width (+/-)]. <b>Note:</b> The detection function operates in the two motor rotation directions. ON : The output frequency is in the range of "frequency reference <math>\pm L4-04</math>". OFF : The output frequency is not in the range of "frequency reference <math>\pm L4-04</math>".</p>	763
14	User-Set Speed Agree 2	<p><b>V/f</b> <b>OLV/PM</b> <b>EZOLV</b></p> <p>The terminal activates when the output frequency is in the range of <i>L4-03</i> [Speed Agree Detection Level (+/-)] <math>\pm L4-04</math> [Speed Agree Detection Width (+/-)] and in the range of the frequency reference <math>\pm L4-04</math>. <b>Note:</b> The detection level set in <i>L4-03</i> is a signed value. The drive will only detect in one direction. ON : The output frequency is in the range of "<i>L4-03</i> <math>\pm L4-04</math>" and the range of frequency reference <math>\pm L4-04</math>. OFF : The output frequency is not in the range of "<i>L4-03</i> <math>\pm L4-04</math>" or the range of frequency reference <math>\pm L4-04</math>.</p>	763
15	Frequency Detection 3	<p><b>V/f</b> <b>OLV/PM</b> <b>EZOLV</b></p> <p>The terminal deactivates when the output frequency &gt; "<i>L4-03</i> [Speed Agree Detection Level (+/-)] + <i>L4-04</i> [Speed Agree Detection Width (+/-)]". After the terminal deactivates, the terminal stays deactivated until the output frequency is at the value of <i>L4-03</i>. <b>Note:</b> The detection level set in <i>L4-03</i> is a signed value. The drive will only detect in one direction. ON : The output frequency &lt; <i>L4-03</i>, or the output frequency <math>\leq L4-03 + L4-04</math>. OFF : The output frequency &gt; "<i>L4-03</i> + <i>L4-04</i>".</p>	764
16	Frequency Detection 4	<p><b>V/f</b> <b>OLV/PM</b> <b>EZOLV</b></p> <p>The terminal activates when the output frequency &gt; <i>L4-03</i> [Speed Agree Detection Level (+/-)]. After the terminal activates, the terminal stays activated until the output frequency is at the value of "<i>L4-03</i> - <i>L4-04</i>". <b>Note:</b> The detection level set in <i>L4-03</i> is a signed value. The drive will only detect in one direction. ON : The output frequency &gt; <i>L4-03</i>. OFF : The output frequency &lt; "<i>L4-03</i> - <i>L4-04</i>", or the output frequency <math>\leq L4-03</math>.</p>	764
17	Torque Detection 1 (N.C.)	<p><b>V/f</b> <b>OLV/PM</b> <b>EZOLV</b></p> <p>The terminal deactivates when the drive detects overtorque or undertorque. OFF : The output current/torque &gt; <i>L6-02</i> [Torque Detection Level 1], or the output current/torque &lt; <i>L6-02</i> for longer than the time set in <i>L6-03</i> [Torque Detection Time 1].</p>	765

## 11.10 H: Terminal Functions

Setting Value	Function	Description	Ref.
18	Torque Detection 2 (N.O.)	<p><b>V/f</b> <b>OLV/PM</b> <b>EZOLV</b></p> <p>The terminal activates when the drive detects overtorque or undertorque.            ON : The output current/torque &gt; L6-05 [Torque Detection Level 2], or the output current/torque &lt; L6-05 for longer than the time set in L6-06 [Torque Detection Time 2].</p>	765
19	Torque Detection 2 (N.C.)	<p><b>V/f</b> <b>OLV/PM</b> <b>EZOLV</b></p> <p>The terminal deactivates when the drive detects overtorque or undertorque.            OFF : The output current/torque &gt; L6-05 [Torque Detection Level 2], or the output current/torque &lt; L6-05 for longer than the time set in L6-06 [Torque Detection Time 2].</p>	765
1A	During Reverse	<p><b>V/f</b> <b>OLV/PM</b> <b>EZOLV</b></p> <p>The terminal activates when the motor operates in the reverse direction.            ON : The motor is operating in the reverse direction.            OFF : The motor is operating in the forward direction or the motor stopped.</p>	766
1B	During Baseblock (N.C.)	<p><b>V/f</b> <b>OLV/PM</b> <b>EZOLV</b></p> <p>The terminal deactivates during baseblock. When the drive is in baseblock, the drive output transistor stops switching and does not make DC bus voltage.            ON : The drive is not in baseblock.            OFF : During baseblock</p>	766
1C	Motor 2 Selected	<p><b>V/f</b> <b>OLV/PM</b> <b>EZOLV</b></p> <p>The terminal activates when you select motor 2.            ON : Motor 2 Selected            OFF : Motor 1 Selected</p>	766
1E	Executing Auto-Restart	<p><b>V/f</b> <b>OLV/PM</b> <b>EZOLV</b></p> <p>The terminal activates when the Auto Restart function is trying to restart after a fault.</p>	766
1F	Motor Overload Alarm (oL1)	<p><b>V/f</b> <b>OLV/PM</b> <b>EZOLV</b></p> <p>The terminal activates when the electronic thermal protection value of the motor overload protective function is a minimum of 90% of the detection level.</p>	766
20	Drive Overheat Pre-Alarm (oH)	<p><b>V/f</b> <b>OLV/PM</b> <b>EZOLV</b></p> <p>The terminal activates when the drive heatsink temperature is at the level set with L8-02 [Overheat Alarm Level].</p>	767
21	Safe Torque OFF	<p><b>V/f</b> <b>OLV/PM</b> <b>EZOLV</b></p> <p>The terminal activates (safety stop state) when the safety circuit and safety diagnosis circuit are operating correctly and when terminals H1-HC and H2-HC are OFF (Open).            ON : Safety stop state            OFF : Safety circuit fault or RUN/READY</p>	767
2F	Maintenance Notification	<p><b>V/f</b> <b>OLV/PM</b> <b>EZOLV</b></p> <p>The terminal activates when drive components are at their estimated maintenance period.            Tells you about the maintenance period for these items:</p> <ul style="list-style-type: none"> <li>• IGBT</li> <li>• Cooling Fan</li> <li>• Capacitor</li> <li>• Soft charge bypass relay</li> </ul>	767
30	During Torque Limit	<p><b>V/f</b> <b>OLV/PM</b> <b>EZOLV</b></p> <p>The terminal activates when the torque reference is the torque limit set with L7 parameters, H3-02 or H3-10 [MFAI Function Selection].</p>	767
37	During Frequency Output	<p><b>V/f</b> <b>OLV/PM</b> <b>EZOLV</b></p> <p>The terminal activates when the drive outputs frequency.            ON : The drive is outputting frequency.            OFF : The drive is not outputting frequency.</p>	767
38	Drive Enabled	<p><b>V/f</b> <b>OLV/PM</b> <b>EZOLV</b></p> <p>This terminal activates when the H1-xx = 6A [Drive Enable] terminal activates.</p>	768
39	Watt Hour Pulse Output	<p><b>V/f</b> <b>OLV/PM</b> <b>EZOLV</b></p> <p>Outputs the pulse that shows the watt hours.</p>	768
3A	Drive Overheat Alarm	<p><b>V/f</b> <b>OLV/PM</b> <b>EZOLV</b></p> <p>The terminal activates when the drive heatsink temperature is at the L8-02 [Overheat Alarm Level] setting while L8-03 = 4 [Overheat Pre-Alarm Selection = Operate at Reduced Speed (L8-19)] and the drive is running.</p>	768
3D	During Speed Search	<p><b>V/f</b> <b>OLV/PM</b> <b>EZOLV</b></p> <p>The terminal activates when the drive is doing speed search.</p>	768
42	Pressure Reached	<p><b>V/f</b> <b>OLV/PM</b> <b>EZOLV</b></p> <p>The terminal activates when the pressure feedback is at the Pressure Setpoint.</p>	768
4A	During KEB Ride-Thru	<p><b>V/f</b> <b>OLV/PM</b> <b>EZOLV</b></p> <p>The terminal activates during KEB Ride-Thru.</p>	769

Setting Value	Function	Description	Ref.
4B	During Short Circuit Braking	 The terminal activates during Short Circuit Braking. <b>Note:</b> When $A1-02 = 8$ [Control Method Selection = EZOLV], this function is available only when you use a PM motor.	769
4C	During Fast Stop	 The terminal activates when the fast stop is in operation.	769
4D	oH Pre-Alarm Reduction Limit	 The terminal activates when $L8-03 = 4$ [Overheat Pre-Alarm Selection = Operate at Reduced Speed (L8-19)] and oH [Heatsink Overheat] does not clear after the drive decreases the frequency for 10 cycles.	769
51	Sequence Timer 1	 The terminal activates when Sequence Timer 1 is active.	769
52	Sequence Timer 2	 The terminal activates when Sequence Timer 2 is active.	769
53	Sequence Timer 3	 The terminal activates when Sequence Timer 3 is active.	769
54	Sequence Timer 4	 The terminal activates when Sequence Timer 4 is active.	770
58	UL6 Underload Detected	 The terminal activates when the drive detected UL6 [Underload or Belt Break Detected].	770
60	Internal Cooling Fan Failure	 The terminal activates when the drive detects a cooling fan failure in the drive.	770
61	Pole Position Detection Complete	 The terminal activates when drive receives a Run command and the drive detects the motor magnetic pole position of the PM motor.	770
62	Modbus Reg 1 Status Satisfied	 The terminal activates when the bit specified by H2-08 [Modbus Register 1 Bit Select] for the MEMOBUS register address set with H2-07 [Modbus Register 1 Address Select] activates.	770
63	Modbus Reg 2 Status Satisfied	 The terminal activates when the bit specified by H2-10 [Modbus Register 2 Bit Select] for the MEMOBUS register address set with H2-09 [Modbus Register 2 Address Select] activates.	770
69	External Power 24V Supply	 The terminal activates when there is an external 24V power supply between terminals PS-AC. ON : The external 24V power supply is supplying power. OFF : The external 24V power supply is not supplying power.	770
6A	Data Logger Error	 The terminal activates when the drive detects a LoG [Com Error / Abnormal SD card].	770
71	Low PI2 Control Feedback Level	 The terminal activates when the PI2 Control Feedback Level is less than S3-13 [PI2 Control Low Feedback Lvl].	770
72	High PI2 Control Feedback Level	 The terminal activates when the PI2 Control Feedback Level is more than S3-15 [PI2 Control High Feedback Lvl].	771
89	Output Current Lim	 The terminal activates when the output current limit is limiting the drive output speed.	771
90	DWEZ Digital Outputs 1	 Sets the digital output 1 to use in DriveWorksEZ. Refer to the DriveWorksEZ online manual for more information.	771
91	DWEZ Digital Outputs 2	 Sets the digital output 2 to use in DriveWorksEZ. Refer to the DriveWorksEZ online manual for more information.	771
92	DWEZ Digital Outputs 3	 Sets the digital output 3 to use in DriveWorksEZ. Refer to the DriveWorksEZ online manual for more information.	771
94	Loss of Prime	 The terminal activates when the drive is in an LOP [Loss of Prime] condition.	771
95	Thermostat Fault	 The terminal activates when the terminal set for H1-xx = 88 [MFDI Function Selection = Thermostat Fault] is active.	771
96	High Feedback	 The terminal activates when the drive is in a High Feedback Condition as specified by Y1-11 [High Feedback Level] and Y1-12 [High Feedback Lvl Fault Dly Time] and when the drive detects an HFB [High Feedback Sensed] fault or an HIFB [High Feedback Sensed] alarm.	771

## 11.10 H: Terminal Functions

Setting Value	Function	Description	Ref.
97	Low Feedback	<b>V/f</b> <b>OLV/PM</b> <b>EZOLV</b> The terminal activates when the drive is in a Low Feedback Condition as specified by <i>Y1-08 [Low Feedback Level]</i> and <i>Y1-09 [Low Feedback Lvl Fault Dly Time]</i> and when the drive detects an <i>LFB [Low Feedback Sensed]</i> fault or an <i>LOFB [High Feedback Sensed]</i> alarm.	771
9E	Low PI Auxiliary Control Level	<b>V/f</b> <b>OLV/PM</b> <b>EZOLV</b> The terminal activates when the PI Aux Feedback Level is less than <i>YF-09 [PI Aux Control Low Level Detect]</i> or if the drive detects an <i>LOAUX [Low PI Aux Feedback Level]</i> fault.	771
9F	High PI Auxiliary Control Level	<b>V/f</b> <b>OLV/PM</b> <b>EZOLV</b> The terminal activates when the PI Aux Feedback Level is more than <i>YF-12 [PI Aux Control High Level Detect]</i> or if the drive detects an <i>HIAUX [High PI Aux Feedback Level]</i> fault.	771
A9	RELAY Operator Control	<b>V/f</b> <b>OLV/PM</b> <b>EZOLV</b> The terminal changes to OFF or ON when you push the RELAY ( <b>F3</b> ) button. When the terminal is ON, push <b>F3</b> to turn it OFF. When the terminal is OFF, push <b>F3</b> to turn in ON.	772
AA	Utility Delay	<b>V/f</b> <b>OLV/PM</b> <b>EZOLV</b> The terminal activates when the drive is stopped and is waiting for the timer set in <i>Y4-17 [Utility Start Delay]</i> to expire.	772
AB	Thrust Mode	<b>V/f</b> <b>OLV/PM</b> <b>EZOLV</b> The terminal activates when the output frequency is between 0.0 Hz and the value set in <i>Y4-12 [Thrust Frequency]</i> and the Thrust Bearing function is active.	772
AC	Setpoint Not Maintained	<b>V/f</b> <b>OLV/PM</b> <b>EZOLV</b> The terminal activates when the drive detects <i>NMS [Setpoint Not Met]</i> condition.	772
B2	BAS Interlock	<b>V/f</b> <b>OLV/PM</b> <b>EZOLV</b> The terminal activates when the Run command is active or the drive is outputting the voltage. The drive will use this as an actuation signal for an external damper.	772
B8	Pump Fault	<b>V/f</b> <b>OLV/PM</b> <b>EZOLV</b> The terminal activates when one of these faults is active: <i>LFB [Low Feedback Sensed]</i> , <i>HFB [High Feedback Sensed]</i> , <i>NMS [Setpoint Not Met]</i> , or <i>EFx [External Fault (Terminal Sx)]</i> .	772
B9	Transducer Loss	<b>V/f</b> <b>OLV/PM</b> <b>EZOLV</b> The terminal activates when the current into the analog input associated with PID feedback is more than 21 mA or less than 3 mA, or an <i>FDBKL [WIRE Break]</i> Fault or an <i>FDBKL [Feedback Loss Wire Break]</i> Alarm is active.	772
BA	PI Auxiliary Control Active	<b>V/f</b> <b>OLV/PM</b> <b>EZOLV</b> The terminal activates when the PI Auxiliary Controller has an effect on the output speed.	772
BB	Differential Feedback Exceeded	<b>V/f</b> <b>OLV/PM</b> <b>EZOLV</b> The terminal activates when the difference between the PID Feedback and the value from the terminal set for <i>H3-xx = 2D [Differential Feedback]</i> is more than <i>Y4-18 [Differential Level]</i> for the time set in <i>Y4-19 [Differential Lvl Detection Time]</i> .	772
BC	Sleep Active	<b>V/f</b> <b>OLV/PM</b> <b>EZOLV</b> The terminal activates when the Sleep function is active and the drive is not operating. <b>Note:</b> The terminal will not activate for Sleep Boost function.	773
BD	Start Delay	<b>V/f</b> <b>OLV/PM</b> <b>EZOLV</b> The terminal activates when the Feedback is more than the start level or the Feedback is less than the Inverse PID and the start timer is timing. <b>Note:</b> You must set <i>Y1-04 [Sleep Wake-up Level] ≠ 0</i> and <i>Y1-05 [Sleep Wake-up Level Delay Time] ≠ 0</i> to use this function.	773
BE	Pre-Charge	<b>V/f</b> <b>OLV/PM</b> <b>EZOLV</b> The terminal activates when the drive is in Pre-Charge Mode.	773
C0	HAND Mode	<b>V/f</b> <b>OLV/PM</b> <b>EZOLV</b> The terminal activates when the drive is in HAND Mode operation.	773
C1	AUTO Mode	<b>V/f</b> <b>OLV/PM</b> <b>EZOLV</b> The terminal activates when the drive is in AUTO Mode operation.	773
C2	OFF Mode	<b>V/f</b> <b>OLV/PM</b> <b>EZOLV</b> The terminal activates when the drive is in OFF Mode operation.	773
C3	Main Feedback Lost	<b>V/f</b> <b>OLV/PM</b> <b>EZOLV</b> The terminal activates when the drive loses the main PID feedback.	773
C4	Backup Feedback Lost	<b>V/f</b> <b>OLV/PM</b> <b>EZOLV</b> The terminal activates when the drive loses the backup PID feedback.	773

Setting Value	Function	Description	Ref.
100	!During Run	<p><b>V/f</b> <b>OLV/PM</b> <b>EZOLV</b></p> <p>The terminal deactivates when you input a Run command and when the drive is outputting voltage. ON : Drive is stopping OFF : Drive is running</p>	774
101	!Zero Speed	<p><b>V/f</b> <b>OLV/PM</b> <b>EZOLV</b></p> <p>The terminal deactivates when the output frequency <math>&lt; E1-09</math> [Minimum Output Frequency]. <b>Note:</b> Parameter <math>E1-09</math> is the reference in all control methods. ON : Output frequency <math>\geq</math> value of <math>E1-09</math>. OFF : Output frequency <math>&lt;</math> value of <math>E1-09</math>.</p>	774
102	!Speed Agree 1	<p><b>V/f</b> <b>OLV/PM</b> <b>EZOLV</b></p> <p>The terminal deactivates when the output frequency is in the range of the frequency reference <math>\pm L4-02</math> [Speed Agree Detection Width]. <b>Note:</b> The detection function operates in the two motor rotation directions. ON : The output frequency does not align with the frequency reference although the drive is running. OFF : The output frequency is in the range of "frequency reference <math>\pm L4-02</math>".</p>	774
103	!User-Set Speed Agree 1	<p><b>V/f</b> <b>OLV/PM</b> <b>EZOLV</b></p> <p>The terminal deactivates when the output frequency is in the range of <math>L4-01</math> [Speed Agree Detection Level] <math>\pm L4-02</math> [Speed Agree Detection Width] and in the range of the frequency reference <math>\pm L4-02</math>. <b>Note:</b> The detection function operates in the two motor rotation directions. The drive uses the <math>L4-01</math> value as the forward/reverse detection level. ON : The output frequency is not in the range of "<math>L4-01 \pm L4-02</math>" or the range of frequency reference <math>\pm L4-02</math>. OFF : The output frequency is in the range of "<math>L4-01 \pm L4-02</math>" and the range of frequency reference <math>\pm L4-02</math>.</p>	774
104	!Frequency Detection 1	<p><b>V/f</b> <b>OLV/PM</b> <b>EZOLV</b></p> <p>The terminal activates when the output frequency <math>&gt; L4-01</math> [Speed Agree Detection Level] <math>+ L4-02</math> [Speed Agree Detection Width]. After the terminal activates, the terminal stays activated until the output frequency is at the value of <math>L4-01</math>. <b>Note:</b> The detection function operates in the two motor rotation directions. The drive uses the <math>L4-01</math> value as the forward/reverse detection level. ON : The output frequency <math>&gt; L4-01 + L4-02</math>. OFF : The output frequency <math>&lt; L4-01</math>, or the output frequency <math>\leq L4-01 + L4-02</math></p>	774
105	!Frequency Detection 2	<p><b>V/f</b> <b>OLV/PM</b> <b>EZOLV</b></p> <p>The terminal deactivates when the output frequency <math>&gt; L4-01</math> [Speed Agree Detection Level]. After the terminal deactivates, the terminal stays deactivated until the output frequency is at the value of "<math>L4-01 - L4-02</math> [Speed Agree Detection Width]". <b>Note:</b> The detection function operates in the two motor rotation directions. The drive uses the <math>L4-01</math> value as the forward/reverse detection level. ON : The output frequency <math>&lt; L4-01 - L4-02</math>, or the output frequency <math>\leq L4-01</math> OFF : The output frequency <math>&gt; L4-01</math></p>	774
106	!Drive Ready	<p><b>V/f</b> <b>OLV/PM</b> <b>EZOLV</b></p> <p>The terminal deactivates when the drive is ready and running.</p>	774
107	!DC Bus Undervoltage	<p><b>V/f</b> <b>OLV/PM</b> <b>EZOLV</b></p> <p>The terminal deactivates when the DC bus voltage or control circuit power supply is at the voltage set in <math>L2-05</math> [Undervoltage Detection Lvl (Uv1)] or less. The terminal also deactivates when there is a fault with the DC bus voltage. ON : The DC bus voltage <math>&gt; L2-05</math> OFF : The DC bus voltage <math>\leq L2-05</math></p>	774
108	!During Baseblock (N.O.)	<p><b>V/f</b> <b>OLV/PM</b> <b>EZOLV</b></p> <p>The terminal deactivates during baseblock. When the drive is in baseblock, the drive output transistor stops switching and does not make DC bus voltage. ON : The drive is not in baseblock. OFF : During baseblock.</p>	774
109	!Frequency Reference from Keypad	<p><b>V/f</b> <b>OLV/PM</b> <b>EZOLV</b></p> <p>Shows the selected frequency reference source. ON : Parameter <math>b1-01</math> [Frequency Reference Selection 1] is the frequency reference source. OFF : The keypad is the frequency reference source.</p>	774
10B	!Torque Detection 1 (N.O.)	<p><b>V/f</b> <b>OLV/PM</b> <b>EZOLV</b></p> <p>The terminal deactivates when the drive detects overtorque or undertorque. OFF : The output current/torque <math>&gt; L6-02</math> [Torque Detection Level 1], or <math>&lt; L6-02</math> for longer than the time set with <math>L6-03</math> [Torque Detection Time 1].</p>	774
10C	!Frequency Reference Loss	<p><b>V/f</b> <b>OLV/PM</b> <b>EZOLV</b></p> <p>The terminal deactivates when the drive detects a loss of frequency reference.</p>	774

## 11.10 H: Terminal Functions

Setting Value	Function	Description	Ref.
10E	!Fault	<p><b>V/f</b> <b>OLV/PM</b> <b>EZOLV</b></p> <p>The terminal deactivates when the drive detects a fault.</p> <p><b>Note:</b> The terminal will not deactivate for <i>CPF00</i> and <i>CPF01</i> [Control Circuit Error] faults.</p>	774
110	!Alarm	<p><b>V/f</b> <b>OLV/PM</b> <b>EZOLV</b></p> <p>The terminal deactivates when the drive detects a minor fault.</p>	774
111	!Fault Reset Command Active	<p><b>V/f</b> <b>OLV/PM</b> <b>EZOLV</b></p> <p>The terminal deactivates when the drive receives the Reset command from the control circuit terminal, serial communications, or the communication option.</p>	774
112	!Timer Output	<p><b>V/f</b> <b>OLV/PM</b> <b>EZOLV</b></p> <p>Sets the terminal as the timer output. Use this setting with the timer input set in <i>H1-xx = 118</i> [MFDI Function Selection = !Timer Function].</p>	774
113	!Speed Agree 2	<p><b>V/f</b> <b>OLV/PM</b> <b>EZOLV</b></p> <p>The terminal deactivates when the output frequency is in the range of the frequency reference <math>\pm L4-04</math> [Speed Agree Detection Width (+/-)].</p> <p><b>Note:</b> The detection function operates in the two motor rotation directions. ON : The output frequency is not in the range of "frequency reference <math>\pm L4-04</math>". OFF : The output frequency is in the range of "frequency reference <math>\pm L4-04</math>".</p>	774
114	!User-Set Speed Agree 2	<p><b>V/f</b> <b>OLV/PM</b> <b>EZOLV</b></p> <p>The terminal deactivates when the output frequency is in the range of <math>L4-03</math> [Speed Agree Detection Level (+/-)] <math>\pm L4-04</math> [Speed Agree Detection Width (+/-)] and in the range of the frequency reference <math>\pm L4-04</math>.</p> <p><b>Note:</b> The detection level set in <i>L4-03</i> is a signed value. The drive will only detect in one direction. ON : The output frequency is not in the range of "<math>L4-03 \pm L4-04</math>" or the range of frequency reference <math>\pm L4-04</math>". OFF : The output frequency is in the range of "<math>L4-03 \pm L4-04</math>" and the range of frequency reference <math>\pm L4-04</math>".</p>	774
115	!Frequency Detection 3	<p><b>V/f</b> <b>OLV/PM</b> <b>EZOLV</b></p> <p>The terminal activates when the output frequency <math>&gt; L4-03</math> [Speed Agree Detection Level (+/-)] <math>+ L4-04</math> [Speed Agree Detection Width (+/-)]. After the terminal activates, the terminal stays activated until the output frequency is at the value of <i>L4-03</i>.</p> <p><b>Note:</b> The detection level set in <i>L4-03</i> is a signed value. The drive will only detect in one direction. ON : The output frequency <math>&gt; L4-03 + L4-04</math> OFF : The output frequency <math>&lt; L4-03</math>, or the output frequency <math>\leq L4-03 + L4-04</math></p>	774
116	!Frequency Detection 4	<p><b>V/f</b> <b>OLV/PM</b> <b>EZOLV</b></p> <p>The terminal deactivates when the output frequency <math>&gt; L4-03</math> [Speed Agree Detection Level (+/-)]. After the terminal deactivates, the terminal stays deactivated until the output frequency is at the value of "<math>L4-03 - L4-04</math>".</p> <p><b>Note:</b> The detection level set in <i>L4-03</i> is a signed value. The drive will only detect in one direction. ON : The output frequency <math>&lt; L4-03 - L4-04</math>, or the output frequency <math>\leq L4-03</math> OFF : The output frequency <math>&gt; L4-03</math></p>	774
117	!Torque Detection 1 (N.C.)	<p><b>V/f</b> <b>OLV/PM</b> <b>EZOLV</b></p> <p>The terminal activates when the drive detects overtorque or undertorque.</p> <p>ON : The output current/torque <math>&gt; L6-02</math> [Torque Detection Level 1], or the output current/torque <math>&lt; L6-02</math> for longer than the time set in <i>L6-03</i> [Torque Detection Time 1].</p>	774
118	!Torque Detection 2 (N.O.)	<p><b>V/f</b> <b>OLV/PM</b> <b>EZOLV</b></p> <p>The terminal deactivates when the drive detects overtorque or undertorque.</p> <p>OFF : The output current/torque <math>&gt; L6-05</math> [Torque Detection Level 2], or the output current/torque <math>&lt; L6-05</math> for longer than the time set in <i>L6-06</i> [Torque Detection Time 2].</p>	774
119	!Torque Detection 2 (N.C.)	<p><b>V/f</b> <b>OLV/PM</b> <b>EZOLV</b></p> <p>The terminal activates when the drive detects overtorque or undertorque.</p> <p>ON : The output current/torque <math>&gt; L6-05</math> [Torque Detection Level 2], or the output current/torque <math>&lt; L6-05</math> for longer than the time set in <i>L6-06</i> [Torque Detection Time 2].</p>	774
11A	!During Reverse	<p><b>V/f</b> <b>OLV/PM</b> <b>EZOLV</b></p> <p>The terminal deactivates when the motor operates in the reverse direction.</p> <p>ON : The motor is operating in the forward direction or the motor stopped. OFF : The motor is operating in the reverse direction.</p>	774
11B	!During Baseblock (N.C.)	<p><b>V/f</b> <b>OLV/PM</b> <b>EZOLV</b></p> <p>The terminal activates during baseblock. When the drive is in baseblock, the drive output transistor stops switching and does not make DC bus voltage.</p> <p>ON : During baseblock. OFF : The drive is not in baseblock.</p>	774

Setting Value	Function	Description	Ref.
11C	!Motor 2 Selected	 The terminal deactivates when motor 2 is selected. ON : Motor 1 Selection OFF : Motor 2 Selection	774
11E	!Executing Auto-Restart	 The terminal deactivates when the Auto Restart function is trying to restart after a fault.	774
11F	!Motor Overload Alarm (oL1)	 The terminal deactivates when the electronic thermal protection value of the motor overload protective function is a minimum of 90% of the detection level.	774
120	!Drive Overheat Pre-Alarm (oH)	 The terminal deactivates when the drive heatsink temperature is at the level set with <i>L8-02 [Overheat Alarm Level]</i> .	774
121	!Safe Torque OFF	 The terminal deactivates (safety stop state) when the safety circuit and safety diagnosis circuit are operating correctly and when terminals H1-HC and H2-HC are OFF (Open). ON : Safety circuit fault or RUN/READY OFF : Safety stop state	774
12F	!Maintenance Notification	 The terminal deactivates when drive components are at their estimated maintenance period. Tells the user about the maintenance period for these items: <ul style="list-style-type: none"> <li>• IGBT</li> <li>• Cooling fan</li> <li>• Capacitor</li> <li>• Soft charge bypass relay</li> </ul>	774
130	!During Torque Limit	 The terminal deactivates when the torque reference is the torque limit set with <i>L7 parameters, H3-02, or H3-10 [MFAI Function Selection]</i> .	774
137	!During Frequency Output	 The terminal deactivates when the drive outputs frequency. ON : The drive is not outputting frequency. OFF : The drive is outputting frequency.	774
138	!Drive Enabled	 This terminal deactivates when the <i>H1-xx = 6A [Drive Enable]</i> terminal deactivates.	774
139	!Watt Hour Pulse Output	 Outputs the pulse that shows the watt hours.	774
13A	!Drive Overheat Alarm	 The terminal deactivates when the drive heatsink temperature is at the <i>L8-02 [Overheat Alarm Level]</i> setting while <i>L8-03 = 4 [Overheat Pre-Alarm Selection = Operate at Reduced Speed (L8-19)]</i> and the drive is running.	774
13D	!During Speed Search	 The terminal deactivates when the drive is doing speed search.	774
142	!Pressure Reached	 The terminal deactivates when the pressure feedback is at the Pressure Setpoint.	774
14A	!During KEB Ride-Thru	 The terminal deactivates during KEB Ride-Thru.	774
14B	!During Short Circuit Braking	 The terminal deactivates during Short Circuit Braking. <b>Note:</b> When <i>A1-02 = 8 [Control Method Selection = EZOLV]</i> , this function is available only when you use a PM motor.	774
14C	!During Fast Stop	 The terminal deactivates when the fast stop is in operation.	774
14D	!oH Pre-Alarm Reduction Limit	 The terminal deactivates when <i>L8-03 = 4 [Overheat Pre-Alarm Selection = Operate at Reduced Speed (L8-19)]</i> and <i>oH [Heatsink Overheat]</i> does not clear after the drive decreases the frequency for 10 cycles.	774
151	!Sequence Timer 1	 The terminal deactivates when Sequence Timer 1 is active.	774
152	!Sequence Timer 2	 The terminal deactivates when Sequence Timer 2 is active.	774
153	!Sequence Timer 3	 The terminal deactivates when Sequence Timer 3 is active.	774



## 11.10 H: Terminal Functions

Setting Value	Function	Description	Ref.
154	!Sequence Timer 4	 The terminal deactivates when Sequence Timer 4 is active.	774
158	!UL6 Underload Detected	 The terminal deactivates when the drive detected <i>UL6 [Underload or Belt Break Detected]</i> .	774
160	!Internal Cooling Fan Failure	 The terminal deactivates when the drive detects a cooling fan failure in the drive.	774
161	!Pole Position Detection Complete	 The terminal deactivates when drive receives a Run command and the drive detects the motor magnetic pole position of the PM motor.	774
162	!Modbus Reg 1 Status Satisfied	 The terminal deactivates when the bit specified by <i>H2-08 [Modbus Register 1 Bit Select]</i> for the MEMOBUS register address set with <i>H2-07 [Modbus Register 1 Address Select]</i> activates.	774
163	!Modbus Reg 2 Status Satisfied	 The terminal deactivates when the bit specified by <i>H2-10 [Modbus Register 2 Bit Select]</i> for the MEMOBUS register address set with <i>H2-09 [Modbus Register 2 Address Select]</i> activates.	774
169	!External Power 24V Supply	 The terminal deactivates when there is an external 24V power supply between terminals PS-AC. ON : The external 24V power supply is not supplying power. OFF : The external 24V power supply is supplying power.	774
16A	!Data Logger Error	 The terminal deactivates when the drive detects <i>LoG [Com Error / Abnormal SD card]</i> .	774
171	!Low PI2 Control Feedback Level	 The terminal deactivates when the PI2 Control Feedback Level is less than <i>S3-13 [PI2 Control Low Feedback Lvl]</i> .	774
172	!High PI2 Control Feedback Level	 The terminal deactivates when the PI2 Control Feedback Level is more than <i>S3-15 [PI2 Control High Feedback Lvl]</i> .	774
189	!Output Current Lim	 The terminal deactivates when the output current limit is limiting the drive output speed.	774
190	!DWEZ Digital Outputs 1	 Sets the digital output 1 to use in DriveWorksEZ. Refer to the DriveWorksEZ online manual for more information.	774
191	!DWEZ Digital Outputs 2	 Sets the digital output 2 to use in DriveWorksEZ. Refer to the DriveWorksEZ online manual for more information.	774
192	!DWEZ Digital Outputs 3	 Sets the digital output 3 to use in DriveWorksEZ. Refer to the DriveWorksEZ online manual for more information.	774
194	!Loss of Prime	 The terminal deactivates when the drive is in an <i>LOP [Loss of Prime]</i> condition.	774
195	!Thermostat Fault	 The terminal deactivates when the terminal set for <i>H1-xx = 88 [MFDI Function Selection = Thermostat Fault]</i> is active.	774
196	!High Feedback	 The terminal deactivates when the drive is in a High Feedback Condition as specified by <i>Y1-11 [High Feedback Level]</i> and <i>Y1-12 [High Feedback Lvl Fault Dly Time]</i> and when the drive detects an <i>HFB [High Feedback Sensed]</i> fault or an <i>HIFB [High Feedback Sensed]</i> alarm.	774
197	!Low Feedback	 The terminal deactivates when the drive is in a Low Feedback Condition as specified by <i>Y1-08 [Low Feedback Level]</i> and <i>Y1-09 [Low Feedback Lvl Fault Dly Time]</i> and when the drive detects an <i>LFB [Low Feedback Sensed]</i> fault or an <i>LOFB [High Feedback Sensed]</i> alarm.	774
19E	!Low PI Auxiliary Control Level	 The terminal deactivates when the PI Aux Feedback Level is less than <i>YF-09 [PI Aux Control Low Level Detect]</i> or if the drive detects an <i>LOAUX [Low PI Aux Feedback Level]</i> fault.	774
19F	!High PI Auxiliary Control Level	 The terminal deactivates when the PI Aux Feedback Level is more than <i>YF-12 [PI Aux Control High Level Detect]</i> or if the drive detects an <i>HLAUX [High PI Aux Feedback Level]</i> fault.	774
1A9	!RELAY Operator Control	 The terminal changes to OFF or ON when you push the RELAY () button. When the terminal is ON, push  to turn it OFF. When the terminal is OFF, push  to turn in ON.	774
1AA	!Utility Delay	 The terminal deactivates when the drive is stopped and is waiting for the timer set in <i>Y4-17 [Utility Start Delay]</i> to expire.	774



Setting Value	Function	Description	Ref.
1AB	!Thrust Mode	<b>V/f</b> <b>OLV/PM</b> <b>EZOLV</b> The terminal deactivates when the output frequency is between 0.0 Hz and the value set in Y4-12 [Thrust Frequency] and the Thrust Bearing function is active.	774
1AC	!Setpoint Not Maintained	<b>V/f</b> <b>OLV/PM</b> <b>EZOLV</b> The terminal deactivates when the drive detects NMS [Setpoint Not Met] condition.	774
1B2	!BAS Interlock	<b>V/f</b> <b>OLV/PM</b> <b>EZOLV</b> The terminal deactivates when the Run command is active or the drive is outputting the voltage. The drive will use this as an actuation signal for an external damper.	774
1B8	!Pump Fault	<b>V/f</b> <b>OLV/PM</b> <b>EZOLV</b> The terminal deactivates when one of these faults is active: LFB [Low Feedback Sensed], HFB [High Feedback Sensed], NMS [Setpoint Not Met], or EFX [External Fault (Terminal Sx)].	774
1B9	!Transducer Loss	<b>V/f</b> <b>OLV/PM</b> <b>EZOLV</b> The terminal deactivates when the current into the analog input associated with PID feedback is more than 21 mA or less than 3 mA, or an FDBKL [WIRE Break] Fault or an FDBKL [Feedback Loss Wire Break] Alarm is active.	774
1BA	!PI Auxiliary Control Active	<b>V/f</b> <b>OLV/PM</b> <b>EZOLV</b> The terminal deactivates when the PI Auxiliary Controller has an effect on the output speed.	774
1BB	!Differential Feedback Exceeded	<b>V/f</b> <b>OLV/PM</b> <b>EZOLV</b> The terminal deactivates when the difference between the PID Feedback and the value from the terminal set for H3-xx = 2D [Differential Feedback] is more than Y4-18 [Differential Level] for the time set in Y4-19 [Differential Lvl Detection Time].	774
1BC	!Sleep Active	<b>V/f</b> <b>OLV/PM</b> <b>EZOLV</b> The terminal deactivates when the Sleep function is active and the drive is not operating. <b>Note:</b> The terminal will not deactivate for Sleep Boost function.	774
1BD	!Start Delay	<b>V/f</b> <b>OLV/PM</b> <b>EZOLV</b> The terminal deactivates when the Feedback is more than the start level or the Feedback is less than the Inverse PID and the start timer is timing. <b>Note:</b> You must set Y1-04 [Sleep Wake-up Level] ≠ 0 and Y1-05 [Sleep Wake-up Level Delay Time] ≠ 0 to use this function.	774
1BE	!Pre-Charge	<b>V/f</b> <b>OLV/PM</b> <b>EZOLV</b> The terminal deactivates when the drive is in Pre-Charge Mode.	774
1C0	!HAND Mode	<b>V/f</b> <b>OLV/PM</b> <b>EZOLV</b> The terminal deactivates when the drive is in HAND Mode operation.	774
1C1	!AUTO Mode	<b>V/f</b> <b>OLV/PM</b> <b>EZOLV</b> The terminal deactivates when the drive is in AUTO Mode operation.	774
1C2	!OFF Mode	<b>V/f</b> <b>OLV/PM</b> <b>EZOLV</b> The terminal deactivates when the drive is in OFF Mode operation.	774
1C3	!Main Feedback Lost	<b>V/f</b> <b>OLV/PM</b> <b>EZOLV</b> The terminal deactivates when the drive loses the main PID feedback.	774
1C4	!Backup Feedback Lost	<b>V/f</b> <b>OLV/PM</b> <b>EZOLV</b> The terminal deactivates when the drive loses the backup PID feedback.	774

### ◆ H3: Analog Inputs

No. (Hex.)	Name	Description	Default (Range)	Ref.
H3-01 (0410)	Terminal A1 Signal Level Select	<b>V/f</b> <b>OLV/PM</b> <b>EZOLV</b> Sets the input signal level for MFAI terminal A1. 0 : 0 to 10V (Lower Limit at 0) 2 : 4 to 20 mA 3 : 0 to 20 mA	0 (0 - 3)	776
H3-02 (0434)	Terminal A1 Function Selection	<b>V/f</b> <b>OLV/PM</b> <b>EZOLV</b> Sets the function for MFAI terminal A1.	0 (0 - 31)	776
H3-03 (0411) RUN	Terminal A1 Gain Setting	<b>V/f</b> <b>OLV/PM</b> <b>EZOLV</b> Sets the gain of the analog signal input to MFAI terminal A1.	100.0% (-999.9 - +999.9%)	776
H3-04 (0412) RUN	Terminal A1 Bias Setting	<b>V/f</b> <b>OLV/PM</b> <b>EZOLV</b> Sets the bias of the analog signal input to MFAI terminal A1.	0.0% (-999.9 - +999.9%)	777

## 11.10 H: Terminal Functions

No. (Hex.)	Name	Description	Default (Range)	Ref.
H3-09 (0417)	Terminal A2 Signal Level Select	<b>V/f</b> <b>OLV/PM</b> <b>EZOLV</b> Sets the input signal level for MFAI terminal A2. 0 : 0-10V (LowLim=0) 2 : 4 to 20 mA 3 : 0 to 20 mA	2 (0 - 3)	777
H3-10 (0418)	Terminal A2 Function Selection	<b>V/f</b> <b>OLV/PM</b> <b>EZOLV</b> Sets the function for MFAI terminal A2. <b>Note:</b> The default setting for H3-10 changes when b5-01 [PID Mode Setting] changes: • b5-01 = 0 [Disabled]: 0 • b5-01 ≠ 0: B	Determined by b5-01 (0 - 31)	777
H3-11 (0419) RUN	Terminal A2 Gain Setting	<b>V/f</b> <b>OLV/PM</b> <b>EZOLV</b> Sets the gain of the analog signal input to MFAI terminal A2.	100.0% (-999.9 - +999.9%)	777
H3-12 (041A) RUN	Terminal A2 Bias Setting	<b>V/f</b> <b>OLV/PM</b> <b>EZOLV</b> Sets the bias of the analog signal input to MFAI terminal A2.	0.0% (-999.9 - +999.9%)	778
H3-13 (041B)	Analog Input FilterTime Constant	<b>V/f</b> <b>OLV/PM</b> <b>EZOLV</b> Sets the time constant for primary delay filters on MFAI terminals.	0.03 s (0.00 - 2.00 s)	778
H3-14 (041C)	Analog Input Terminal Enable Sel	<b>V/f</b> <b>OLV/PM</b> <b>EZOLV</b> Sets which terminal or terminals to enable when H1-xx = C [MFDI Function Selection = Analog Terminal Enable Selection] is activated. 1 : Terminal A1 only 2 : Terminal A2 only 3 : Terminals A1 and A2	2 (1 - 3)	778
H3-16 (02F0)	Terminal A1 Offset	<b>V/f</b> <b>OLV/PM</b> <b>EZOLV</b> Sets the offset level for analog signals input to terminal A1. Usually it is not necessary to change this setting.	0 (-500 - +500)	778
H3-17 (02F1)	Terminal A2 Offset	<b>V/f</b> <b>OLV/PM</b> <b>EZOLV</b> Sets the offset level for analog signals input to terminal A2. Usually it is not necessary to change this setting.	0 (-500 - +500)	778
H3-40 (0B5C)	Mbus Reg 15C1h Input Function	<b>V/f</b> <b>OLV/PM</b> <b>EZOLV</b> Sets the MEMOBUS AI1 function.	F (4 - 2E)	779
H3-41 (0B5F)	Mbus Reg 15C2h Input Function	<b>V/f</b> <b>OLV/PM</b> <b>EZOLV</b> Sets the MEMOBUS AI2 function.	F (4 - 2E)	779
H3-42 (0B62)	Mbus Reg 15C3h Input Function	<b>V/f</b> <b>OLV/PM</b> <b>EZOLV</b> Sets the MEMOBUS AI3 function.	F (4 - 2E)	779
H3-43 (117F)	Mbus Reg Inputs FilterTime Const	<b>V/f</b> <b>OLV/PM</b> <b>EZOLV</b> Sets the time constant to apply a primary delay filter to the MEMOBUS analog input register values.	0.00 s (0.00 - 2.00 s)	779

### ■ H3-xx: MFAI Setting Values

Setting Value	Function	Description	Ref.
0	Frequency Reference	<b>V/f</b> <b>OLV/PM</b> <b>EZOLV</b> The input value from the MFAI terminal set with this function becomes the master frequency reference.	779
1	Frequency Gain	<b>V/f</b> <b>OLV/PM</b> <b>EZOLV</b> The drive multiplies the analog frequency reference with the input value from the MFAI set with this function.	780
2	Auxiliary Frequency Reference 1	<b>V/f</b> <b>OLV/PM</b> <b>EZOLV</b> Sets Reference 2 through multi-step speed reference to enable the command reference (Auxiliary Frequency Reference 1) from the analog input terminal set here. This value is a percentage where the Maximum Output Frequency setting is a setting value of 100%. <b>Note:</b> Parameter A1-02 [Control Method Selection] selects which parameter is the maximum output frequency. • A1-02 ≠ 8 [EZOLV]: E1-04 [Maximum Output Frequency] • A1-02 = 8: E9-02 [Maximum Speed]	780

Setting Value	Function	Description	Ref.
3	Auxiliary Frequency Reference 2	<p><b>V/f</b> <b>OLV/PM</b> <b>EZOLV</b></p> <p>Sets Reference 3 through multi-step speed reference to enable the command reference (Auxiliary Frequency Reference 2) from the analog input terminal set here. This value is a percentage where the Maximum Output Frequency setting is a setting value of 100%.</p> <p><b>Note:</b> Parameter A1-02 [Control Method Selection] selects which parameter is the maximum output frequency. • A1-02 ≠ 8 [EZOLV]: E1-04 [Maximum Output Frequency] • A1-02 = 8: E9-02 [Maximum Speed]</p>	780
4	Output Voltage Bias	<p><b>V/f</b> <b>OLV/PM</b> <b>EZOLV</b></p> <p>Set this parameter to input a bias signal and amplify the output voltage.</p>	780
5	Accel/Decel Time Gain	<p><b>V/f</b> <b>OLV/PM</b> <b>EZOLV</b></p> <p>Enters a signal to adjust the gain used for C1-01 to C1-04 [Acceleration/Deceleration Times 1 and 2] and C1-09 [Fast Stop Time] when the full scale analog signal (10 V or 20 mA) is 100%.</p>	780
6	DC Injection Braking Current	<p><b>V/f</b> <b>OLV/PM</b> <b>EZOLV</b></p> <p>Enters a signal to adjust the current level used for DC Injection Braking when the drive rated output current is 100%.</p>	781
7	Torque Detection Level	<p><b>V/f</b> <b>OLV/PM</b> <b>EZOLV</b></p> <p>Enters a signal to adjust the overtorque/undertorque detection level.</p> <p><b>Note:</b> Use this function with L6-01 [Torque Detection Selection 1]. This parameter functions as an alternative to L6-02 [Torque Detection Level 1].</p>	781
8	Stall Prevent Level During Run	<p><b>V/f</b> <b>OLV/PM</b> <b>EZOLV</b></p> <p>Enters a signal to adjust the stall prevention level during run if the drive rated current is 100%.</p>	781
9	Output Frequency Lower Limit	<p><b>V/f</b> <b>OLV/PM</b> <b>EZOLV</b></p> <p>Enters a signal to adjust the output frequency lower limit level as a percentage of the maximum output frequency.</p> <p><b>Note:</b> Parameter A1-02 [Control Method Selection] selects which parameter is the maximum output frequency. • A1-02 ≠ 8 [EZOLV]: E1-04 [Maximum Output Frequency] • A1-02 = 8: E9-02 [Maximum Speed]</p>	782
B	PID Feedback	<p><b>V/f</b> <b>OLV/PM</b> <b>EZOLV</b></p> <p>Enter the PID feedback value as a percentage of the maximum output frequency.</p> <p><b>Note:</b> Parameter A1-02 [Control Method Selection] selects which parameter is the maximum output frequency. • A1-02 ≠ 8 [EZOLV]: E1-04 [Maximum Output Frequency] • A1-02 = 8: E9-02 [Maximum Speed]</p>	782
C	PID Setpoint	<p><b>V/f</b> <b>OLV/PM</b> <b>EZOLV</b></p> <p>Enters the PID setpoint as a percentage of the maximum output frequency.</p> <p><b>Note:</b> Parameter A1-02 [Control Method Selection] selects which parameter is the maximum output frequency. • A1-02 ≠ 8 [EZOLV]: E1-04 [Maximum Output Frequency] • A1-02 = 8: E9-02 [Maximum Speed]</p>	782
D	Frequency Bias	<p><b>V/f</b> <b>OLV/PM</b> <b>EZOLV</b></p> <p>Enters the bias value added to the frequency reference as a percentage of the maximum output frequency.</p> <p><b>Note:</b> Parameter A1-02 [Control Method Selection] selects which parameter is the maximum output frequency. • A1-02 ≠ 8 [EZOLV]: E1-04 [Maximum Output Frequency] • A1-02 = 8: E9-02 [Maximum Speed]</p>	782
E	Motor Temperature (PTC Input)	<p><b>V/f</b> <b>OLV/PM</b> <b>EZOLV</b></p> <p>Uses the motor Positive Temperature Coefficient (PTC) thermistor to prevent heat damage to the motor as a percentage of the current value when the 10 V analog signal is input.</p>	782
F	Not Used	<p><b>V/f</b> <b>OLV/PM</b> <b>EZOLV</b></p> <p>Use this setting for unused terminals or to use terminals in through mode.</p>	783
10	Forward Torque Limit	<p><b>V/f</b> <b>OLV/PM</b> <b>EZOLV</b></p> <p>Enters the forward torque limit when the motor rated torque is 100%.</p>	783
11	Reverse Torque Limit	<p><b>V/f</b> <b>OLV/PM</b> <b>EZOLV</b></p> <p>Enters the load torque limit if the motor rated torque is 100%.</p>	784
12	Regenerative Torque Limit	<p><b>V/f</b> <b>OLV/PM</b> <b>EZOLV</b></p> <p>Enters the regenerative torque limit if the motor rated torque is 100%.</p>	784
15	General Torque Limit	<p><b>V/f</b> <b>OLV/PM</b> <b>EZOLV</b></p> <p>Enters the torque limit that is the same for all quadrants for forward, reverse, and regenerative operation if the motor rated torque is 100%.</p>	784
16	Differential PID Feedback	<p><b>V/f</b> <b>OLV/PM</b> <b>EZOLV</b></p> <p>Enters the PID differential feedback value if the full scale analog signal (10 V or 20 mA) is 100%.</p>	784

## 11.10 H: Terminal Functions

Setting Value	Function	Description	Ref.
1F	Not Used	<b>V/f</b> <b>OLV/PM</b> <b>EZOLV</b> Use this setting for unused terminals or to use terminals in through mode.	784
24	PID Feedback Backup	<b>V/f</b> <b>OLV/PM</b> <b>EZOLV</b> Enters the PID Feedback Backup signal for the drive to use when it loses the primary PID feedback set for H3-xx = B [PID Feedback]. <b>Note:</b> The full-scale of the analog signal goes from b5-71 [Min PID Transducer Scaling] to b5-38 [PID User Unit Display Scaling].	785
25	PI2 Control Setpoint	<b>V/f</b> <b>OLV/PM</b> <b>EZOLV</b> Enters the PI2 Control setpoint level as a percentage of the S3-02 [PI2 Control Transducer Scale] value. <b>Note:</b> Parameters S3-03 [PI2 Control Decimal Place Pos] and S3-04 [PI2 Control Unit Selection] set the resolution and unit.	785
26	PI2 Control Feedback	<b>V/f</b> <b>OLV/PM</b> <b>EZOLV</b> Enters the PI2 Control feedback level as a percentage of the S3-02 [PI2 Control Transducer Scale] value. <b>Note:</b> Parameters S3-03 [PI2 Control Decimal Place Pos] and S3-04 [PI2 Control Unit Selection] set the resolution and unit.	785
27	PI Auxiliary Control Feedback	<b>V/f</b> <b>OLV/PM</b> <b>EZOLV</b> Enters the PI Auxiliary Control feedback value when YF-01 = 1 [PI Aux Control Selection = Enabled]. <b>Note:</b> • The full-scale of the analog signal goes from YF-35 [PI Auxiliary Minimum Transducer Scale] to YF-02 [PI Aux Control Transducer Scale]. • Parameter YF-22 [PI Aux Level Decimal Place Pos] sets the resolution.	785
2B	Emergency Override PID Feedback	<b>V/f</b> <b>OLV/PM</b> <b>EZOLV</b> This input is the PID Feedback source when Emergency Override is running in PID mode (S6-02 = 2 or 3 [Emergency Override Ref Selection = System PID Mode or Independent PID Mode]). <b>Note:</b> • When S6-02 = 2 [Emergency Override Ref Selection = System PID Mode], the full-scale of the analog signal goes from b5-71 [Min PID Transducer Scaling] to b5-38 [PID User Unit Display Scaling]. • When S6-02 = 3 [Independent PID Mode], the full-scale of the analog signal goes from b5-71 to S6-03 [EMOVR Independent PID Scale]. • When you set MEMOBUS register 3A93h bit 4, register 3A95h becomes the Emergency Override Feedback source.	785
2C	Emergency Override PID Setpoint	<b>V/f</b> <b>OLV/PM</b> <b>EZOLV</b> This input is the PID Setpoint source when Emergency Override is running in PID mode (S6-02 = 2 or 3 [Emergency Override Ref Selection = System PID Mode or Independent PID Mode]). <b>Note:</b> • When S6-02 = 2 [Emergency Override Ref Selection = System PID Mode], the full-scale of the analog signal goes from b5-71 [Min PID Transducer Scaling] to b5-38 [PID User Unit Display Scaling]. • When S6-02 = 3 [Independent PID Mode], the full-scale of the analog signal goes from b5-71 to S6-03 [EMOVR Independent PID Scale]. • When you set MEMOBUS register 3A93h bit 5, register 3A96h becomes the Emergency Override Setpoint source.	785
2D	Differential Level Source	<b>V/f</b> <b>OLV/PM</b> <b>EZOLV</b> Enters a feedback value to calculate the Differential Level between the Differential Level Source feedback and the primary PID Feedback [H3-xx = B]. <b>Note:</b> The full-scale of the analog signal goes from b5-71 [Min PID Transducer Scaling] to b5-38 [PID User Unit Display Scaling].	785
2E	HAND Frequency Ref or Setpoint	<b>V/f</b> <b>OLV/PM</b> <b>EZOLV</b> Enters the S5-05 [HAND Frequency Reference] value or the S5-06 [HAND Setpoint] value. When S5-01 = 0 [HAND Frequency Reference Source = HAND Analog Input] and S5-03 = 0 [HAND Mode PI Selection = Disabled], the drive enters HAND Frequency Reference. When b5-01 ≠ 0, S5-01 = 0, and S5-03 = 1 [Enabled], the drive enters HAND Setpoint. <b>Note:</b> • When PID is enabled, the full-scale of the analog signal goes from b5-71 [Min PID Transducer Scaling] to b5-38 [PID User Unit Display Scaling]. • When PID is disabled, the drive enters this analog signal as the percentage of the E1-04 [Maximum Output Frequency] value.	785
30	DWEZ Analog Input 1	<b>V/f</b> <b>OLV/PM</b> <b>EZOLV</b> Use with DriveWorksEZ. Refer to the DriveWorksEZ online manual for more information.	786
31	DWEZ Analog Input 2	<b>V/f</b> <b>OLV/PM</b> <b>EZOLV</b> Use with DriveWorksEZ. Refer to the DriveWorksEZ online manual for more information.	786

## ◆ H4: Analog Outputs

No. (Hex.)	Name	Description	Default (Range)	Ref.
H4-01 (041D)	Terminal FM Analog Output Select	<b>V/f</b> <b>OLV/PM</b> <b>EZOLV</b> Sets the monitor number to send from MFAO terminal FM. Set the <i>x-xx</i> part of the <i>Ux-xx</i> [Monitor]. For example, set <i>H4-01 = 102</i> to monitor <i>U1-02</i> [Output Frequency].	102 (000 - 999)	787
H4-02 (041E) RUN	Terminal FM Analog Output Gain	<b>V/f</b> <b>OLV/PM</b> <b>EZOLV</b> Sets the gain of the monitor signal that is sent from MFAO terminal FM. Sets the analog signal output level from the terminal FM at 10 V or 20 mA as 100% when an output for monitoring items is 100%.	100.0% (-999.9 - +999.9%)	787
H4-03 (041F) RUN	Terminal FM Analog Output Bias	<b>V/f</b> <b>OLV/PM</b> <b>EZOLV</b> Sets the bias of the monitor signal that is sent from MFAO terminal FM. Set the level of the analog signal sent from terminal FM at 10 V or 20 mA as 100% when an output for monitoring items is 0%.	0.0% (-999.9 - +999.9%)	788
H4-04 (0420)	Terminal AM Analog Output Select	<b>V/f</b> <b>OLV/PM</b> <b>EZOLV</b> Sets the monitoring number to be output from the MFAO terminal AM. Set the <i>x-xx</i> part of the <i>Ux-xx</i> [Monitor]. For example, set <i>H4-04 = 103</i> to monitor <i>U1-03</i> [Output Current].	103 (000 - 999)	788
H4-05 (0421) RUN	Terminal AM Analog Output Gain	<b>V/f</b> <b>OLV/PM</b> <b>EZOLV</b> Sets the gain of the monitor signal that is sent from MFAO terminal AM. When an output for monitoring items is 0%, this parameter sets the analog signal output level from the AM terminal at 10 V or 20 mA as 100%.	50.0% (-999.9 - +999.9%)	788
H4-06 (0422) RUN	Terminal AM Analog Output Bias	<b>V/f</b> <b>OLV/PM</b> <b>EZOLV</b> Sets the bias of the monitor signal that is sent from MFAO terminal AM. When an output for monitoring items is 0%, this parameter sets the analog signal output level from the AM terminal at 10 V or 20 mA as 0%.	0.0% (-999.9 - +999.9%)	788
H4-07 (0423)	Terminal FM Signal Level Select	<b>V/f</b> <b>OLV/PM</b> <b>EZOLV</b> Sets the MFAO terminal FM output signal level. <b>Note:</b> Set jumper S5 on the control circuit terminal block accordingly when you change this parameter. 0 : 0 to 10 Vdc 2 : 4 to 20 mA	0 (0, 2)	788
H4-08 (0424)	Terminal AM Signal Level Select	<b>V/f</b> <b>OLV/PM</b> <b>EZOLV</b> Sets the MFAO terminal AM output signal level. <b>Note:</b> Set jumper S5 on the control circuit terminal block accordingly when you change this parameter. 0 : 0 to 10 Vdc 2 : 4 to 20 mA	0 (0, 2)	789
H4-20 (0B53)	Analog Power Monitor 100% Level	<b>V/f</b> <b>OLV/PM</b> <b>EZOLV</b> Sets the level at 10 V when you set <i>U1-08</i> [Output Power] for analog output.	0.00 kW (0.00 - 650.00 kW)	789

## ◆ H5: Serial Communication

No. (Hex.)	Name	Description	Default (Range)	Ref.
H5-01 (0425)	Drive Node Address	<p><b>V/f</b> <b>OLV/PM</b> <b>EZOLV</b></p> <p>Sets the communication slave address for drives.</p> <p><b>Note:</b></p> <ul style="list-style-type: none"> <li>Restart the drive after you change the parameter setting.</li> <li>Setting 0 will not let the drive respond to MEMOBUS/Modbus communications.</li> <li>When <math>Y1-01 = 3</math> [Multiplex Mode = Memobus Network], the setting range changes when the <math>Y9-25</math> [Highest Node Address] setting changes.</li> </ul>	1FH (0 - FFH)	789
H5-02 (0426)	Communication Speed Selection	<p><b>V/f</b> <b>OLV/PM</b> <b>EZOLV</b></p> <p>Sets the communications speed for MEMOBUS/Modbus communications.</p> <p><b>Note:</b></p> <p>Re-energize the drive or set <math>H5-20 = 1</math> [Communication Parameters Reload = Reload Now] after you change the parameter setting.</p> <p>0 : 1200 bps 1 : 2400 bps 2 : 4800 bps 3 : 9600 bps 4 : 19.2 kbps 5 : 38.4 kbps 6 : 57.6 kbps 7 : 76.8 kbps 8 : 115.2 kbps</p>	3 (0 - 8)	789
H5-03 (0427)	Communication Parity Selection	<p><b>V/f</b> <b>OLV/PM</b> <b>EZOLV</b></p> <p>Sets the communications parity used for MEMOBUS/Modbus communications.</p> <p><b>Note:</b></p> <p>Re-energize the drive or set <math>H5-20 = 1</math> [Communication Parameters Reload = Reload Now] after you change the parameter setting.</p> <p>0 : No parity 1 : Even parity 2 : Odd parity</p>	0 (0 - 2)	790
H5-04 (0428)	Communication Error Stop Method	<p><b>V/f</b> <b>OLV/PM</b> <b>EZOLV</b></p> <p>Sets the motor Stopping Method when the drive detects a Modbus Communication Error condition.</p> <p>0 : Ramp to Stop 1 : Coast to Stop 2 : Fast Stop (Use C1-09) 3 : Alarm Only 4 : Run at H5-34 (CE Go-To-Freq)</p>	3 (0 - 4)	790
H5-05 (0429)	Comm Fault Detection Selection	<p><b>V/f</b> <b>OLV/PM</b> <b>EZOLV</b></p> <p>Sets the function that detects <math>CE</math> [Modbus Communication Error] issues during MEMOBUS/Modbus communications.</p> <p>0 : Disabled 1 : Enabled</p>	1 (0, 1)	791
H5-06 (042A)	Drive Transmit Wait Time	<p><b>V/f</b> <b>OLV/PM</b> <b>EZOLV</b></p> <p>Sets the time to wait to send a response message after the drive receives a command message from the master.</p> <p><b>Note:</b></p> <p>Restart the drive after changing the parameter setting.</p>	5 ms (0 - 65 ms)	791
H5-08 (062D)	Communication Protocol Selection	<p><b>V/f</b> <b>OLV/PM</b> <b>EZOLV</b></p> <p>Selects the communication protocol.</p> <p>0 : Modbus/MEMOBUS 1 : Metasys/N2 2 : Apogee/P1 3 : BACnet</p>	0 (0 - 3)	792
H5-09 (0435)	CE Detection Time	<p><b>V/f</b> <b>OLV/PM</b> <b>EZOLV</b></p> <p>Sets the detection time for <math>CE</math> [Modbus Communication Error] issues when communication stops.</p>	2.0 s (0.0 - 10.0 s)	792
H5-10 (0436)	Modbus Register 0025H Unit Sel	<p><b>V/f</b> <b>OLV/PM</b> <b>EZOLV</b></p> <p>Sets the unit of measure used for the MEMOBUS/Modbus communications monitor register 0025H (output voltage reference monitor).</p> <p>0 : 0.1 V units 1 : 1 V units</p>	0 (0, 1)	792

No. (Hex.)	Name	Description	Default (Range)	Ref.
H5-11 (043C)	Comm ENTER Command Mode	<b>V/f</b> <b>OLV/PM</b> <b>EZOLV</b> Sets the function to make the Enter command necessary to change parameters through MEMOBUS/Modbus communications. 0 : ENTER Command Required 1 : ENTER Command Not Required	0 (0, 1)	792
H5-12 (043D)	Run Command Method Selection	<b>V/f</b> <b>OLV/PM</b> <b>EZOLV</b> Sets the input method for the Run command when <i>b1-02 = 2</i> [Run Command Selection 1 = Serial Communications]. 0 : FWD/Stop, REV/Stop 1 : Run/Stop, FWD/REV	0 (0, 1)	792
H5-14 (310D)	BACnet Device Obj ID LOW BITS	<b>V/f</b> <b>OLV/PM</b> <b>EZOLV</b> Sets the lower bits of the BACnet device object ID as a 4-digit hexadecimal number.	0001 (0000 - FFFF)	793
H5-15 (310E)	BACnet Device Obj ID HIGH BITS	<b>V/f</b> <b>OLV/PM</b> <b>EZOLV</b> Sets the upper bits of the BACnet device object ID as a 4-digit hexadecimal number.	0000 (0000 - 003F)	793
H5-18 (11A2)	Motor Speed Filter over Comms	<b>V/f</b> <b>OLV/PM</b> <b>EZOLV</b> Sets the filter time constant used when monitoring motor speed during MEMOBUS/Modbus communications or with a communication option.	0 ms (0 - 100 ms)	793
H5-20 (0B57)	Communication Parameters Reload	<b>V/f</b> <b>OLV/PM</b> <b>EZOLV</b> Sets the function to immediately enable updated MEMOBUS/Modbus communications parameters. 0 : Reload at Next Power Cycle 1 : Reload Now	0 (0, 1)	794
H5-22 (11CF)	Speed Search from MODBUS	<b>V/f</b> <b>OLV/PM</b> <b>EZOLV</b> Enables the MEMOBUS/Modbus communication register Speed Search function (bit0 of 15DFH). 0 : Disabled 1 : Enabled	0 (0, 1)	794
H5-23 (158D)	BACnet Max Master	<b>V/f</b> <b>OLV/PM</b> <b>EZOLV</b> Sets the maximum number of master MAC ID to scan to when the drive polls for the next node (Poll for Master).	7F (1 - 7F)	794
H5-24 (3DA0)	BACnet Max Info Frames	<b>V/f</b> <b>OLV/PM</b> <b>EZOLV</b> Sets the maximum number of information frames for BACnet.	3 (1 - 255)	794
H5-25 (1589) RUN	Function 5A Register 1 Selection	<b>V/f</b> <b>OLV/PM</b> <b>EZOLV</b> Returns the contents of the specified MEMOBUS/Modbus communications register when responding to the master device.	0044H (U1-05) (0000H - FFFFH)	794
H5-26 (158A) RUN	Function 5A Register 2 Selection	<b>V/f</b> <b>OLV/PM</b> <b>EZOLV</b> Returns the contents of the specified MEMOBUS/Modbus communications register when responding to the master device.	0045H (U1-06) (0000H - FFFFH)	794
H5-27 (158B) RUN	Function 5A Register 3 Selection	<b>V/f</b> <b>OLV/PM</b> <b>EZOLV</b> Returns the contents of the specified MEMOBUS/Modbus communications register when responding to the master device.	0042H (U1-03) (0000H - FFFFH)	795
H5-28 (158C) RUN	Function 5A Register 4 Selection	<b>V/f</b> <b>OLV/PM</b> <b>EZOLV</b> Returns the contents of the specified MEMOBUS/Modbus communications register when responding to the master device.	0049H (U1-10) (0000H - FFFFH)	795
H5-33 (3FB3)	Power-up CALL Alarm	<b>V/f</b> <b>OLV/PM</b> <b>EZOLV</b> Enables and disables CALL [Serial Comm Transmission Error] alarm detection. 0 : Disabled 1 : Enabled	1 (0, 1)	795
H5-34 (3FB4) RUN	Comm Error (CE) Go-To-Frequency	<b>V/f</b> <b>OLV/PM</b> <b>EZOLV</b> Sets the speed at which the drive will run when <i>H5-04 = 4</i> [Communication Error Stop Method = Run at H5-34] and there is a CE.	0.0 Hz (0.0 - 400.0 Hz)	795
H5-35 (3FB5) RUN	Comm Error (CE) Go-To-Timeout	<b>V/f</b> <b>OLV/PM</b> <b>EZOLV</b> When <i>H5-04 = 4</i> [Communication Error Stop Method = Run at H5-34] and a CE is present, the drive will run at the <i>H5-34</i> [Comm Error (CE) Go-To-Frequency] speed for this length of time before it triggers a CE fault. <b>Note:</b> Set this parameter to 0 s to disable the time-out.	0 s (0 - 6000 s)	795
H5-36 (3FB6)	CE Fault Restart Select	<b>V/f</b> <b>OLV/PM</b> <b>EZOLV</b> Sets the drive to restart ( <i>L5-01</i> [Number of Auto-Restart Attempts]) after a CE fault. 0 : No Retry 1 : Retry	0 (0, 1)	795

## ◆ H7: Virtual Inputs / Outputs

No. (Hex.)	Name	Description	Default (Range)	Ref.
H7-00 (116F) Expert	Virtual MFIO selection	<p><b>V/f</b> <b>OLV/PM</b> <b>EZOLV</b></p> <p>Sets the function to enable and disable the virtual I/O function. Set this parameter to 1 to operate the virtual I/O function. 0 : Disabled 1 : Enabled</p>	0 (0, 1)	796
H7-01 (1185) Expert	Virtual Multi-Function Input 1	<p><b>V/f</b> <b>OLV/PM</b> <b>EZOLV</b></p> <p>Sets the function that enters the virtual input set in H7-10 [Virtual Multi-Function Output 1].</p> <p><b>Note:</b> Settings 1B [Programming Lockout] and 11B [!Programming Lockout] are not available.</p>	F (1 - 1FF)	796
H7-02 (1186) Expert	Virtual Multi-Function Input 2	<p><b>V/f</b> <b>OLV/PM</b> <b>EZOLV</b></p> <p>Sets the function that enters the virtual input set in H7-12 [Virtual Multi-Function Output 2].</p> <p><b>Note:</b> Settings 1B [Programming Lockout] and 11B [!Programming Lockout] are not available.</p>	F (1 - 1FF)	796
H7-03 (1187) Expert	Virtual Multi-Function Input 3	<p><b>V/f</b> <b>OLV/PM</b> <b>EZOLV</b></p> <p>Sets the function that enters the virtual input set in H7-14 [Virtual Multi-Function Output 3].</p> <p><b>Note:</b> Settings 1B [Programming Lockout] and 11B [!Programming Lockout] are not available.</p>	F (1 - 1FF)	797
H7-04 (1188) Expert	Virtual Multi-Function Input 4	<p><b>V/f</b> <b>OLV/PM</b> <b>EZOLV</b></p> <p>Sets the function that enters the virtual input set in H7-16 [Virtual Multi-Function Output 4].</p> <p><b>Note:</b> Settings 1B [Programming Lockout] and 11B [!Programming Lockout] are not available.</p>	F (1 - 1FF)	797
H7-10 (11A4) Expert	Virtual Multi-Function Output 1	<p><b>V/f</b> <b>OLV/PM</b> <b>EZOLV</b></p> <p>Sets the function for virtual digital output 1.</p>	F (0 - 1FF)	797
H7-11 (11A5) Expert	Virtual Output 1 Delay Time	<p><b>V/f</b> <b>OLV/PM</b> <b>EZOLV</b></p> <p>Sets the minimum ON time for virtual digital output 1.</p>	0.1 s (0.0 - 25.0 s)	797
H7-12 (11A6) Expert	Virtual Multi-Function Output 2	<p><b>V/f</b> <b>OLV/PM</b> <b>EZOLV</b></p> <p>Sets the function for virtual digital output 2.</p>	F (0 - 1FF)	797
H7-13 (11A7) Expert	Virtual Output 2 Delay Time	<p><b>V/f</b> <b>OLV/PM</b> <b>EZOLV</b></p> <p>Sets the minimum ON time for virtual digital output 2.</p>	0.1 s (0.0 - 25.0 s)	797
H7-14 (11A8) Expert	Virtual Multi-Function Output 3	<p><b>V/f</b> <b>OLV/PM</b> <b>EZOLV</b></p> <p>Sets the function for virtual digital output 3.</p>	F (0 - 1FF)	797
H7-15 (11A9) Expert	Virtual Output 3 Delay Time	<p><b>V/f</b> <b>OLV/PM</b> <b>EZOLV</b></p> <p>Sets the minimum ON time for virtual digital output 3.</p>	0.1 s (0.0 - 25.0 s)	798
H7-16 (11AA) Expert	Virtual Multi-Function Output 4	<p><b>V/f</b> <b>OLV/PM</b> <b>EZOLV</b></p> <p>Sets the function for virtual digital output 4.</p>	F (0 - 1FF)	798
H7-17 (11AB) Expert	Virtual Output 4 Delay Time	<p><b>V/f</b> <b>OLV/PM</b> <b>EZOLV</b></p> <p>Sets the minimum ON time for virtual digital output 4.</p>	0.1 s (0.0 - 25.0 s)	798
H7-30 (1177) Expert	Virtual Analog Input Selection	<p><b>V/f</b> <b>OLV/PM</b> <b>EZOLV</b></p> <p>Sets the virtual analog input function.</p>	F (0 - 31)	798



No. (Hex.)	Name	Description	Default (Range)	Ref.
H7-31 (1178) RUN Expert	Virtual Analog Input Gain	<b>V/f</b> <b>OLV/PM</b> <b>EZOLV</b> Sets the virtual analog input gain.	100.0% (-999.9 - 999.9%)	798
H7-32 (1179) RUN Expert	Virtual Analog Input Bias	<b>V/f</b> <b>OLV/PM</b> <b>EZOLV</b> Sets the virtual analog input bias.	0.0% (-999.9 - 999.9%)	798
H7-40 (1163)	Virtual Analog Out Signal Select	<b>V/f</b> <b>OLV/PM</b> <b>EZOLV</b> Sets the signal level of the virtual analog output. 0 : 0 to 100% (Absolute Value) 1 : -100 to 100% 2 : 0 to 100% (Lower Limit at 0)	0 (0 - 2)	798
H7-41 (1164)	Virtual Analog Output Function	<b>V/f</b> <b>OLV/PM</b> <b>EZOLV</b> Sets the monitor to be output from the virtual analog output. Set the <i>x-xx</i> part of the <i>Ux-xx [Monitor]</i> . For example, set H7-41 = 102 to monitor U1-02 [Output Frequency].	102 (0 - 999)	799
H7-42 (1165)	Virtual Analog Output FilterTime	<b>V/f</b> <b>OLV/PM</b> <b>EZOLV</b> Sets the time constant for a primary filter of the virtual analog output.	0.00 s (0.00 - 2.00 s)	799

## 11.11 L: Protection Functions

### ◆ L1: Motor Protection

No. (Hex.)	Name	Description	Default (Range)	Ref.
L1-01 (0480)	Motor Overload (oL1) Protection	<p><b>V/f</b> <b>OLV/PM</b> <b>EZOLV</b></p> <p>Sets the motor overload protection with electronic thermal protectors.</p> <p>0 : Disabled 1 : Variable Torque 4 : PM Variable Torque</p> <p><b>Note:</b> When you connect only one motor to a drive, set <i>L1-01 = 1 or 4 [Variable Torque or PM Variable Torque]</i>. External thermal relays are not necessary in these conditions.</p>	Determined by A1-02 (0 - 4)	224
L1-02 (0481)	Motor Overload Protection Time	<p><b>V/f</b> <b>OLV/PM</b> <b>EZOLV</b></p> <p>Sets the operation time for the electronic thermal protector of the drive to prevent damage to the motor. Usually it is not necessary to change this setting.</p>	1.0 min (0.1 - 5.0 min)	226
L1-03 (0482)	Motor Thermistor oH Alarm Select	<p><b>V/f</b> <b>OLV/PM</b> <b>EZOLV</b></p> <p>Sets drive operation when the PTC input signal entered into the drive is at the <i>oH3 [Motor Overheat (PTC Input)]</i> detection level.</p> <p>0 : Ramp to Stop 1 : Coast to Stop 2 : Fast Stop (Use C1-09) 3 : Alarm Only</p>	3 (0 - 3)	226
L1-04 (0483)	Motor Thermistor oH Fault Select	<p><b>V/f</b> <b>OLV/PM</b> <b>EZOLV</b></p> <p>Sets the drive operation when the PTC input signal to the drive is at the <i>oH4 [Motor Overheat Fault (PTC Input)]</i> detection level.</p> <p>0 : Ramp to Stop 1 : Coast to Stop 2 : Fast Stop (Use C1-09)</p>	1 (0 - 2)	227
L1-05 (0484)	Motor Thermistor Filter Time	<p><b>V/f</b> <b>OLV/PM</b> <b>EZOLV</b></p> <p>Sets the primary delay time constant for the PTC input signal entered to the drive. This parameter prevents accidental motor overheat faults.</p>	0.20 s (0.00 - 10.00 s)	804
L1-08 (1103)	oL1 Current Level	<p><b>V/f</b> <b>OLV/PM</b> <b>EZOLV</b></p> <p>Sets the reference current for the motor 1 thermal overload detection. When the current level &gt; 0.0 A, you cannot set this value &lt; 10% of drive rated current.</p>	0.0 A (0.0 A or 10% to 150% of the drive rated current)	804
L1-09 (1104)	oL1 Current Level for Motor 2	<p><b>V/f</b> <b>OLV/PM</b> <b>EZOLV</b></p> <p>Sets the reference current for the motor 2 thermal overload detection. When the current level &gt; 0.0 A, you cannot set this value &lt; 10% of drive rated current.</p>	0.0 A (0.0 A or 10 to 150% of the drive rated current)	804
L1-13 (046D)	Motor Overload Memory Selection	<p><b>V/f</b> <b>OLV/PM</b> <b>EZOLV</b></p> <p>Sets the function that keeps the current electronic thermal protector value after power loss.</p> <p>0 : Disabled 1 : Enabled 2 : Enabled, using RTC</p> <p><b>Note:</b> The drive saves <i>oL</i> status, time and date when there is a power loss. The drive uses this information and time of power up to calculate <i>oL</i>.</p>	2 (0 - 2)	804
L1-22 (0768) RUN	Leakage Current Filter Time1	<p><b>V/f</b> <b>OLV/PM</b> <b>EZOLV</b></p> <p>Sets the leakage current detection reduction filter time constant during constant speed run.</p> <p><b>Note:</b> You can set this parameter when <i>C6-02 = B [Carrier Frequency Selection = Leakage Current Detection Reduction Rate PWM]</i>.</p>	Determined by C6-02 (0.0 - 60.0 s)	805
L1-23 (0769) RUN	Leakage Current Filter Time2	<p><b>V/f</b> <b>OLV/PM</b> <b>EZOLV</b></p> <p>Sets the leakage current detection reduction filter time constant during acceleration/ deceleration.</p> <p><b>Note:</b></p> <ul style="list-style-type: none"> <li>You can set this parameter when <i>C6-02 = B [Carrier Frequency Selection = Leakage Current Detection Reduction Rate PWM]</i>.</li> <li>When the setting value increases, the current monitor also starts up slowly. Examine the relevant sequence for problems.</li> </ul>	Determined by C6-02 (0.0 - 60.0 s)	805

## ◆ L2: Power Loss Ride Through

No. (Hex.)	Name	Description	Default (Range)	Ref.
L2-01 (0485)	Power Loss Ride Through Select	<p><b>V/f</b> <b>OLV/PM</b> <b>EZOLV</b></p> <p>Sets the drive operation after a momentary power loss.</p> <p>0 : Disabled 1 : Enabled for L2-02 Time 2 : Enabled while CPU Power Active</p> <p><b>Note:</b> When the CPU is inactive, <i>b1-17 [Run Command at Power Up]</i> sets operation at power up.</p>	2 (0 - 2)	807
L2-02 (0486)	Power Loss Ride Through Time	<p><b>V/f</b> <b>OLV/PM</b> <b>EZOLV</b></p> <p>Sets the maximum time that the drive will wait until it tries to restart after power loss.</p>	Determined by o2-04 (0.0 - 25.5 s)	807
L2-03 (0487)	Minimum Baseblock Time	<p><b>V/f</b> <b>OLV/PM</b> <b>EZOLV</b></p> <p>Sets the minimum time to continue the drive output block (baseblock) after a baseblock.</p>	Determined by o2-04 (0.1 - 5.0 s)	808
L2-04 (0488)	Powerloss V/f Recovery Ramp Time	<p><b>V/f</b> <b>OLV/PM</b> <b>EZOLV</b></p> <p>Sets the time for the drive output voltage to go back to the correct voltage after it completes speed searches.</p>	Determined by o2-04 (0.0 - 5.0 s)	808
L2-05 (0489)	Undervoltage Detection Lvl (Uv1)	<p><b>V/f</b> <b>OLV/PM</b> <b>EZOLV</b></p> <p>Sets the voltage at which the drive triggers a <i>Uv1 [DC Bus Undervoltage]</i> fault or at which it activates the KEB function. Usually it is not necessary to change this setting.</p> <p><b>NOTICE: Damage to Equipment.</b> When you set this parameter to a value lower than the default, you must install an AC reactor on the input side of the power supply. If you do not install an AC reactor, it will cause damage to the drive circuitry.</p>	Determined by o2-04 and E1-01 (208 V Class: 150 - 220 V, 480 V Class: 300 - 440 V)	808
L2-06 (048A) Expert	Kinetic Energy Backup Decel Time	<p><b>V/f</b> <b>OLV/PM</b> <b>EZOLV</b></p> <p>Sets the deceleration time during KEB operation to decrease the maximum output frequency to 0.</p>	0.0 s (0.0 - 6000.0 s)	808
L2-07 (048B) Expert	Kinetic Energy Backup Accel Time	<p><b>V/f</b> <b>OLV/PM</b> <b>EZOLV</b></p> <p>Sets the acceleration time to return the frequency to the frequency reference before a power loss after canceling KEB operation.</p>	0.0 s (0.0 - 6000.0 s)	809
L2-08 (048C) Expert	Frequency Gain at KEB Start	<p><b>V/f</b> <b>OLV/PM</b> <b>EZOLV</b></p> <p>Sets the quantity of output frequency reduction used when KEB operation starts as a percentage of the motor rated slip before starting KEB operation.</p>	100% (0 - 300%)	809
L2-09 (048D) Expert	KEB Minimum Frequency Level	<p><b>V/f</b> <b>OLV/PM</b> <b>EZOLV</b></p> <p>Sets the quantity of output frequency reduction used as a percentage of <i>E2-02 [Motor Rated Slip]</i> when KEB operation starts.</p>	20% (0 - 100%)	809
L2-10 (048E) Expert	Minimum KEB Time	<p><b>V/f</b> <b>OLV/PM</b> <b>EZOLV</b></p> <p>Sets the minimum length of time to operate the KEB after the drive detects a momentary power loss.</p>	50 ms (0 - 25500 ms)	809
L2-11 (0461) Expert	KEB DC Bus Voltage Setpoint	<p><b>V/f</b> <b>OLV/PM</b> <b>EZOLV</b></p> <p>Sets the target value that controls the DC bus voltage to a constant level in Single Drive KEB Ride-Thru 2. Sets the DC bus voltage level that completes the KEB operation for all other KEB methods.</p>	Determined by E1-01 (Determined by E1-01)	810
L2-29 (0475) Expert	Kinetic Energy Backup Method	<p><b>V/f</b> <b>OLV/PM</b> <b>EZOLV</b></p> <p>Sets the KEB function operation mode.</p> <p>0 : Single Drive KEB Ride-Thru 1 1 : Single Drive KEB Ride-Thru 2</p>	0 (0 - 1)	810
L2-30 (045E) Expert	KEB Zero Speed Operation	<p><b>V/f</b> <b>OLV/PM</b> <b>EZOLV</b></p> <p>Sets the operation when the output frequency decreases below the zero level (DC braking injection starting frequency) during KEB deceleration.</p> <p>0 : Baseblock 1 : DC/SC Injection Braking</p>	0 (0, 1)	810
L2-31 (045D) Expert	KEB Start Voltage Offset Level	<p><b>V/f</b> <b>OLV/PM</b> <b>EZOLV</b></p> <p>Sets the KEB start voltage offset.</p>	Determined by A1-02 (208 V Class: 0 - 100 V, 480 V Class: 0 - 200 V)	810

## ◆ L3: Stall Prevention

No. (Hex.)	Name	Description	Default (Range)	Ref.
L3-01 (048F)	Stall Prevention during Accel	<p><b>V/f</b> <b>OLV/PM</b> <b>EZOLV</b></p> <p>Sets the method of Stall Prevention During Acceleration.</p> <p>0 : Disabled 1 : Enabled 2 : Intelligent (Ignore Accel Ramp)</p>	1 (0 - 2)	811
L3-02 (0490)	Stall Prevent Level during Accel	<p><b>V/f</b> <b>OLV/PM</b> <b>EZOLV</b></p> <p>Sets the output current level to activate the Stall Prevention function during acceleration as a percentage of the drive rated output current.</p>	Determined by L8-38 (0 - 120%)	813
L3-03 (0491)	Stall Prevent Limit during Accel	<p><b>V/f</b> <b>OLV/PM</b> <b>EZOLV</b></p> <p>Sets the lower limit for the stall prevention level used in the constant output range as a percentage of the drive rated output current.</p>	50% (0 - 100%)	813
L3-04 (0492)	Stall Prevention during Decel	<p><b>V/f</b> <b>OLV/PM</b> <b>EZOLV</b></p> <p>Sets the method that the drive will use to prevent overvoltage faults when decelerating.</p> <p><b>Note:</b> The setting range changes when the A1-02 [Control Method Selection] value changes: • When A1-02 = 5 [OLV/PM], the setting range is 0 to 2. • When A1-02 = 8 [EZOLV], the setting range is 0, 1.</p> <p>0 : Disabled 1 : General Purpose 2 : Intelligent (Ignore Decel Ramp) 4 : Overexcitation/High Flux</p>	1 (Determined by A1-02)	813
L3-05 (0493)	Stall Prevention during RUN	<p><b>V/f</b> <b>OLV/PM</b> <b>EZOLV</b></p> <p>Sets the function to enable and disable Stall Prevention During Run.</p> <p><b>Note:</b> • An output frequency lower than 6 Hz will disable Stall Prevention during Run. The L3-05 and L3-06 [Stall Prevent Level during Run] settings do not have an effect. • The default setting changes when the A1-02 [Control Method Selection] value changes: –A1-02 = 0, 5 [V/f, OLV/PM]: 2 –A1-02 = 8 [EZOLV]: 3</p> <p>0 : Disabled 1 : Deceleration Time 1 (C1-02) 2 : Deceleration Time 2 (C1-04) 3 : Intelligent</p>	Determined by A1-02 (0 - 3)	814
L3-06 (0494)	Stall Prevent Level during Run	<p><b>V/f</b> <b>OLV/PM</b> <b>EZOLV</b></p> <p>Sets the output current level to enable the Stall Prevention function during operation as a percentage of the drive rated output current.</p> <p><b>Note:</b> This parameter is applicable when L3-05 = 1, 2 [Stall Prevention during RUN = Deceleration Time 1 (C1-02), Deceleration Time 2 (C1-04)].</p>	Determined by L8-38 (5 - 120%)	815
L3-11 (04C7)	Overvoltage Suppression Select	<p><b>V/f</b> <b>OLV/PM</b> <b>EZOLV</b></p> <p>Sets the overvoltage suppression function.</p> <p>0 : Disabled 1 : Enabled</p>	0 (0, 1)	815
L3-17 (0462)	DC Bus Regulation Level	<p><b>V/f</b> <b>OLV/PM</b> <b>EZOLV</b></p> <p>Sets the target value for the DC bus voltage when the overvoltage suppression function and the Decel Stall Prevention function (Intelligent Stall Prevention) are active.</p>	208 V Class: 375 V, 480 V Class: 750 V (208 V Class: 150 - 400 V, 480 V Class: 300 - 800 V)	816
L3-20 (0465) Expert	DC Bus Voltage Adjustment Gain	<p><b>V/f</b> <b>OLV/PM</b> <b>EZOLV</b></p> <p>Sets the proportional gain used to control the DC bus voltage.</p>	Determined by A1-02 (0.00 - 5.00)	816
L3-21 (0466) Expert	OVSsuppression Accel/Decel P Gain	<p><b>V/f</b> <b>OLV/PM</b> <b>EZOLV</b></p> <p>Sets the proportional gain to calculate acceleration and deceleration rates.</p>	1.00 (0.10 - 10.00)	816
L3-22 (04F9)	PM Stall Prevention Decel Time	<p><b>V/f</b> <b>OLV/PM</b> <b>EZOLV</b></p> <p>Sets the momentary deceleration time that the drive will use when it tries to accelerate a PM motor and detected motor stalls. This function is applicable when L3-01 = 1 [Stall Prevention during Accel = Enabled].</p>	0.0 s (0.0 - 6000.0 s)	817

No. (Hex.)	Name	Description	Default (Range)	Ref.
L3-23 (04FD)	Stall P Reduction at Constant HP	<b>V/f</b> <b>OLV/PM</b> <b>EZOLV</b> Sets the function to automatically decrease the Stall Prevention Level during Run for Constant Horse Power (CHP) part of the speed range. 0 : Use L3-06 for Entire Speed Range 1 : Automatic Reduction @ CHP Region	0 (0, 1)	817
L3-24 (046E) Expert	Motor Accel Time @ Rated Torque	<b>V/f</b> <b>OLV/PM</b> <b>EZOLV</b> Sets the motor acceleration time to reach the maximum frequency at the motor rated torque for stopped single-drive motors.	Determined by o2-04, E2-11, and E5-01 (0.001 - 10.000 s)	817
L3-25 (046F) Expert	Load Inertia Ratio	<b>V/f</b> <b>OLV/PM</b> <b>EZOLV</b> Sets the ratio between motor inertia and machine inertia.	1.0 (0.1 - 1000.0)	818
L3-26 (0455) Expert	Additional DC Bus Capacitors	<b>V/f</b> <b>OLV/PM</b> <b>EZOLV</b> Sets the capacity for external main circuit capacitors. Usually it is not necessary to change this setting. Sets this parameter when you use the KEB Ride-Thru function.	0 μF (0 to 65000 μF)	818
L3-27 (0456)	Stall Prevention Detection Time	<b>V/f</b> <b>OLV/PM</b> <b>EZOLV</b> Sets a delay time between reaching the Stall Prevention level and starting the Stall Prevention function.	50 ms (0 - 5000 ms)	818
L3-35 (0747) Expert	Speed Agree Width for Auto Decel	<b>V/f</b> <b>OLV/PM</b> <b>EZOLV</b> Sets the width for speed agreement when L3-04 = 2 [Stall Prevention during Decel = Intelligent (Ignore Decel Ramp)]. Usually it is not necessary to change this setting.	0.00 Hz (0.00 - 1.00 Hz)	818

#### ◆ L4: Speed Detection

No. (Hex.)	Name	Description	Default (Range)	Ref.
L4-01 (0499)	Speed Agree Detection Level	<b>V/f</b> <b>OLV/PM</b> <b>EZOLV</b> Sets the level to detect speed agree or motor speed when H2-01 to H2-03 = 2, 3, 4, 5 [MFDO Function Selection = Speed Agree 1, User-Set Speed Agree 1, Frequency Detection 1, Frequency Detection 2].	0.0 Hz (0.0 - 400.0 Hz)	818
L4-02 (049A)	Speed Agree Detection Width	<b>V/f</b> <b>OLV/PM</b> <b>EZOLV</b> Sets the width to detect speed agree or motor speed when H2-01 to H2-03 = 2, 3, 4, 5 [MFDO Function Selection = Speed Agree 1, User-Set Speed Agree 1, Frequency Detection 1, Frequency Detection 2].	2.0 Hz (0.0 - 20.0 Hz)	819
L4-03 (049B)	Speed Agree Detection Level (+/-)	<b>V/f</b> <b>OLV/PM</b> <b>EZOLV</b> Sets the speed agree detection level or motor speed detection level when H2-01 to H2-03 = 13, 14, 15, 16 [MFDO Function Selection = Speed Agree 2, User-Set Speed Agree 2, Frequency Detection 3, Frequency Detection 4].	0.0 Hz (-400.0 - +400.0 Hz)	819
L4-04 (049C)	Speed Agree Detection Width (+/-)	<b>V/f</b> <b>OLV/PM</b> <b>EZOLV</b> Sets the width to detect speed agree or motor speed when H2-01 to H2-03 = 13, 14, 15, 16 [MFDO Function Selection = Speed Agree 2, User-Set Speed Agree 2, Frequency Detection 3, Frequency Detection 4].	2.0 Hz (0.0 - 20.0 Hz)	819
L4-05 (049D)	Fref Loss Detection Selection	<b>V/f</b> <b>OLV/PM</b> <b>EZOLV</b> Sets the operation when the drive detects a loss of frequency reference. 0 : Stop 1 : Run at (L4-06 x Last Reference)	1 (0, 1)	819
L4-06 (04C2)	Frequency Reference @Loss of Ref	<b>V/f</b> <b>OLV/PM</b> <b>EZOLV</b> Sets the frequency reference as a percentage to continue drive operation after it detects a frequency reference loss. The value is a percentage of the frequency reference before the drive detected the loss.	80.0% (0.0 - 100.0%)	819
L4-07 (0470)	Speed Agree Detection Selection	<b>V/f</b> <b>OLV/PM</b> <b>EZOLV</b> Sets the condition that activates speed detection. 0 : No Detection during Baseblock 1 : Detection Always Enabled	0 (0, 1)	820

◆ L5: Fault Restart

No. (Hex.)	Name	Description	Default (Range)	Ref.
L5-01 (049E)	Number of Auto-Restart Attempts	<b>V/f OLV/PM EZOLV</b> Sets the number of times that the drive will try to restart.	0 (0 - 10 times)	821
L5-02 (049F)	Fault Contact at Restart Select	<b>V/f OLV/PM EZOLV</b> Sets the function that sends signals to the MFDO terminal set for <i>Fault</i> [ $H2-xx = E$ ] while the drive is automatically restarting. 0 : Active Only when Not Restarting 1 : Always Active	0 (0, 1)	821
L5-04 (046C)	Interval Method Restart Time	<b>V/f OLV/PM EZOLV</b> Sets the time interval between each Auto Restart attempt.	10.0 s (0.5 - 3600.0 s)	821
L5-07 (0B2A)	Fault Reset Enable Select Grp1	<b>V/f OLV/PM EZOLV</b> Use these 4 digits to set the Auto Restart function for <i>oL1</i> to <i>oL4</i> . From left to right, the digits set <i>oL1</i> , <i>oL2</i> , <i>oL3</i> , and <i>oL4</i> , in order. 0000 : Disabled 0001 : Enabled (—/—/—/oL4) 0010 : Enabled (—/—/oL3/—) 0011 : Enabled (—/—/oL3/oL4) 0100 : Enabled (—/oL2/—/—) 0101 : Enabled (—/oL2/—/oL4) 0110 : Enabled (—/oL2/oL3/—) 0111 : Enabled (—/oL2/oL3/oL4) 1000 : Enabled (oL1/—/—/—) 1001 : Enabled (oL1/—/—/oL4) 1010 : Enabled (oL1/—/oL3/—) 1011 : Enabled (oL1/—/oL3/oL4) 1100 : Enabled (oL1/oL2/—/—) 1101 : Enabled (oL1/oL2/—/oL4) 1110 : Enabled (oL1/oL2/oL3/—) 1111 : Enabled (oL1/oL2/oL3/oL4)	1111 (0000 - 1111)	822
L5-08 (0B2B)	Fault Reset Enable Select Grp2	<b>V/f OLV/PM EZOLV</b> Use these 4 digits to set the Auto Restart function for <i>Uv1</i> , <i>ov</i> , <i>oH1</i> , and <i>GF</i> . From left to right, the digits set <i>Uv1</i> , <i>ov</i> , <i>oH1</i> , and <i>GF</i> , in order. 0000 : Disabled 0001 : Enabled (—/—/—/GF) 0010 : Enabled (—/—/oH1/—) 0011 : Enabled (—/—/oH1/GF) 0100 : Enabled (—/ov/—/—) 0101 : Enabled (—/ov/—/GF) 0110 : Enabled (—/ov/oH1/—) 0111 : Enabled (—/ov/oH1/GF) 1000 : Enabled (Uv1/—/—/—) 1001 : Enabled (Uv1/—/—/GF) 1010 : Enabled (Uv1/—/oH1/—) 1011 : Enabled (Uv1/—/oH1/GF) 1100 : Enabled (Uv1/ov/—/—) 1101 : Enabled (Uv1/ov/—/GF) 1110 : Enabled (Uv1/ov/oH1/—) 1111 : Enabled (Uv1/ov/oH1/GF)	1111 (0000 - 1111)	822
L5-40 (3670)	Low Feedback Flt Retry Selection	<b>V/f OLV/PM EZOLV</b> Sets the drive to do an Auto Restart when the drive detects an <i>LFB</i> [ <i>Low Feedback Sensed</i> ] fault. 0 : No Retry 1 : Retry	0 (0, 1)	823
L5-41 (3671)	Hi Feedback Flt Retry Selection	<b>V/f OLV/PM EZOLV</b> Sets the drive to do an Auto Restart when the drive detects an <i>HFB</i> [ <i>High Feedback Sensed</i> ] fault. 0 : No Retry 1 : Retry	0 (0, 1)	824
L5-42 (3672)	Feedback Loss Fault Retry Select	<b>V/f OLV/PM EZOLV</b> Sets the drive to try an Auto Restart when the drive detects an <i>FDBKL</i> [ <i>WIRE Break</i> ] fault. 0 : No Retry 1 : Retry	0 (0, 1)	825

No. (Hex.)	Name	Description	Default (Range)	Ref.
L5-49 (3679)	Fault Retry Speed Search Select	<b>V/f</b> <b>OLV/PM</b> <b>EZOLV</b> Sets the drive to do a speed search at the start of a Fault Retry. 0 : Disabled 1 : Enabled	1 (0, 1)	825
L5-50 (367A)	Setpoint Not Met Fault Retry Sel	<b>V/f</b> <b>OLV/PM</b> <b>EZOLV</b> Sets the drive to try an Auto Restart when it detects an <i>NMS [SetPoint Not Met]</i> fault. 0 : No Retry 1 : Retry	0 (0, 1)	825
L5-51 (367B)	Loss of Prime Fault Retry Select	<b>V/f</b> <b>OLV/PM</b> <b>EZOLV</b> Sets the drive to try an Auto Restart if it detects an <i>LOP [Loss Of Prime]</i> fault. 0 : No Retry 1 : Retry	0 (0, 1)	825
L5-53 (3251)	Thermostat Fault Retry Selection	<b>V/f</b> <b>OLV/PM</b> <b>EZOLV</b> Sets the drive to try an Auto Restart if it detects a <i>VLTS [Thermostat Fault]</i> fault. <b>Note:</b> • To use this function, set <i>S5-01</i> ≠ 0 [ <i>HAND Frequency Reference Source</i> ≠ <i>HAND Analog Input</i> ] • The drive will only restart after the Thermostat digital input de-activates and the <i>L5-04 [Interval Method Restart Time]</i> timer is expired. 0 : No Retry 1 : Retry	0 (0, 1)	825

◆ L6: Torque Detection

No. (Hex.)	Name	Description	Default (Range)	Ref.
L6-01 (04A1)	Torque Detection Selection 1	<b>V/f</b> <b>OLV/PM</b> <b>EZOLV</b> Sets torque detection conditions that will trigger an overtorque or undertorque response from the drive. 0 : Disabled 1 : oL @ Speed Agree - Alarm only 2 : oL @ RUN - Alarm only 3 : oL @ Speed Agree - Fault 4 : oL @ RUN - Fault 5 : UL @ Speed Agree - Alarm only 6 : UL @ RUN - Alarm only 7 : UL @ Speed Agree - Fault 8 : UL @ RUN - Fault 9 : UL6 @ Speed Agree - Alarm only 10 : UL6 @ RUN - Alarm only 11 : UL6 @ Speed Agree - Fault 12 : UL6 @ RUN - Fault	0 (0 - 12)	828
L6-02 (04A2)	Torque Detection Level 1	<b>V/f</b> <b>OLV/PM</b> <b>EZOLV</b> Sets the detection level for Overtorque/Undertorque Detection 1. In V/f control, drive rated output current = 100% value. In vector control, motor rated torque = 100% value.	15% (0 - 300%)	829
L6-03 (04A3)	Torque Detection Time 1	<b>V/f</b> <b>OLV/PM</b> <b>EZOLV</b> Sets the detection time for Overtorque/Undertorque Detection 1.	10.0 s (0.0 - 10.0 s)	829
L6-04 (04A4)	Torque Detection Selection 2	<b>V/f</b> <b>OLV/PM</b> <b>EZOLV</b> Sets the speed range that detects overtorque and undertorque and the operation of drives (operation status) after detection. 0 : Disabled 1 : oL @ Speed Agree - Alarm only 2 : oL @ RUN - Alarm only 3 : oL @ Speed Agree - Fault 4 : oL @ RUN - Fault 5 : UL @ Speed Agree - Alarm only 6 : UL @ RUN - Alarm only 7 : UL @ Speed Agree - Fault 8 : UL @ RUN - Fault	0 (0 - 8)	829
L6-05 (04A5)	Torque Detection Level 2	<b>V/f</b> <b>OLV/PM</b> <b>EZOLV</b> Sets the detection level for Overtorque/Undertorque Detection 2. In V/f control, drive rated output current = 100% value. In vector control, motor rated torque = 100% value.	150% (0 - 300%)	830

## 11.11 L: Protection Functions

No. (Hex.)	Name	Description	Default (Range)	Ref.
L6-06 (04A6)	Torque Detection Time 2	<input type="checkbox"/> V/f <input type="checkbox"/> OLV/PM <input type="checkbox"/> EZOLV Sets the detection time for Overtorque/Undertorque Detection 2.	0.1 s (0.0 - 10.0 s)	830
L6-13 (062E)	Motor Underload Curve Select	<input type="checkbox"/> V/f <input type="checkbox"/> OLV/PM <input type="checkbox"/> EZOLV Sets the motor underload protection ( <i>UL6 [Undertorque Detection 6]</i> ) based on motor load and sets the level of <i>L6-02 [Torque Detection Level 1]</i> to refer to Fbase or Fmax. 0 : Base Frequency Enable 1 : Max Frequency Enable	0 (0, 1)	830
L6-14 (062F)	Motor Underload Level @ Min Freq	<input type="checkbox"/> V/f <input type="checkbox"/> OLV/PM <input type="checkbox"/> EZOLV Sets the <i>UL6 [Undertorque Detection 6]</i> detection level at minimum frequency by percentage of drive rated current.	15% (0 - 300%)	831

### ◆ L7: Torque Limit

No. (Hex.)	Name	Description	Default (Range)	Ref.
L7-01 (04A7) RUN	Forward Torque Limit	<input type="checkbox"/> V/f <input type="checkbox"/> OLV/PM <input type="checkbox"/> EZOLV Sets the torque limit value for forward motoring as a percentage, where motor rated torque is the 100% value.	200% (0 - 300%)	832
L7-02 (04A8) RUN	Reverse Torque Limit	<input type="checkbox"/> V/f <input type="checkbox"/> OLV/PM <input type="checkbox"/> EZOLV Sets the torque limit value for reversed motoring as a percentage, where motor rated torque is the 100% value.	200% (0 - 300%)	832
L7-03 (04A9) RUN	Forward Regenerative Trq Limit	<input type="checkbox"/> V/f <input type="checkbox"/> OLV/PM <input type="checkbox"/> EZOLV Sets the torque limit value for forward regenerative conditions as a percentage of the motor rated torque.	200% (0 - 300%)	832
L7-04 (04AA) RUN	Reverse Regenerative Trq Limit	<input type="checkbox"/> V/f <input type="checkbox"/> OLV/PM <input type="checkbox"/> EZOLV Sets the torque limit value for reversed regenerative conditions as a percentage of the motor rated torque.	200% (0 - 300%)	833
L7-16 (044D)	Torque Limit Process at Start	<input type="checkbox"/> V/f <input type="checkbox"/> OLV/PM <input type="checkbox"/> EZOLV Assigns a time filter to allow the torque limit to build at start. 0 : Disabled 1 : Enabled	1 (0, 1)	833

### ◆ L8: Drive Protection

No. (Hex.)	Name	Description	Default (Range)	Ref.
L8-02 (04AE)	Overheat Alarm Level	<input type="checkbox"/> V/f <input type="checkbox"/> OLV/PM <input type="checkbox"/> EZOLV Sets the <i>oH</i> detection level temperature.	Determined by o2-04 (50 - 150 °C)	833
L8-03 (04AF)	Overheat Pre-Alarm Selection	<input type="checkbox"/> V/f <input type="checkbox"/> OLV/PM <input type="checkbox"/> EZOLV Sets drive operation if it detects an <i>oH</i> alarm. 0 : Ramp to Stop 1 : Coast to Stop 2 : Fast Stop (Use C1-09) 3 : Alarm Only 4 : Operate at Reduced Speed (L8-19)	4 (0 - 4)	833
L8-05 (04B1)	Input Phase Loss Protection Sel	<input type="checkbox"/> V/f <input type="checkbox"/> OLV/PM <input type="checkbox"/> EZOLV Sets the function to enable and disable input phase loss detection. 0 : Disabled 1 : Enabled	1 (0, 1)	834
L8-07 (04B3)	Output Phase Loss Protection Sel	<input type="checkbox"/> V/f <input type="checkbox"/> OLV/PM <input type="checkbox"/> EZOLV Sets the function to enable and disable output phase loss detection. The drive starts output phase loss detection when the output current decreases to less than 5% of the drive rated current. <b>Note:</b> The drive can incorrectly start output phase loss detection in these conditions: • The motor rated current is very small compared to the drive rating. • The drive is operating a PM motor with a small load. 0 : Disabled 1 : Fault when one phase is lost 2 : Fault when two phases are lost	1 (0 - 2)	835



No. (Hex.)	Name	Description	Default (Range)	Ref.
L8-09 (04B5)	Output Ground Fault Detection	<b>V/f</b> <b>OLV/PM</b> <b>EZOLV</b> Sets the function to enable and disable ground fault protection. 0 : Disabled 1 : Enabled	Determined by o2-04 (0, 1)	835
L8-10 (04B6)	Heatsink Fan Operation Selection	<b>V/f</b> <b>OLV/PM</b> <b>EZOLV</b> Sets operation of the heatsink cooling fan. 0 : During Run, w/ L8-11 Off-Delay 1 : Always On 2 : Temperature-Dependent Fan Ctrl.	0 (0 - 2)	835
L8-11 (04B7)	Heatsink Fan Off-Delay Time	<b>V/f</b> <b>OLV/PM</b> <b>EZOLV</b> Sets the length of time that the drive will wait before it stops the cooling fan after it cancels the Run command when L8-10 = 0 [Heatsink Fan Operation Selection = During Run, w/ L8-11 Off-Delay].	300 s (0 - 300 s)	836
L8-12 (04B8)	Ambient Temperature Setting	<b>V/f</b> <b>OLV/PM</b> <b>EZOLV</b> Sets the ambient temperature of the drive installation area. <b>Note:</b> The setting range changes when the L8-35 [Installation Method Selection] setting changes. • When L8-35 = 0 or 2 [IP20/UL Open Type or IP20/UL Type 1]: -10 °C ~ +60 °C • When L8-35 = 1 or 3 [Side-by-Side Mounting or IP55/UL Type 12]: -10 °C ~ +50 °C	40 °C (Determined by L8-35)	836
L8-15 (04BB)	Drive oL2 @ Low Speed Protection	<b>V/f</b> <b>OLV/PM</b> <b>EZOLV</b> Sets the function to decrease the drive overload level at which the drive will trigger oL2 [Drive Overload] during low speed operation (6 Hz or slower) to prevent damage to the main circuit transistors. <b>Note:</b> Contact Yaskawa or your nearest sales representative before disabling this function at low speeds. If you frequently operate drives with high output current in low speed ranges, it can cause heat stress and decrease the life span of drive IGBTs. 0 : Disabled (No Additional Derate) 1 : Enabled (Reduced oL2 Level)	1 (0, 1)	836
L8-18 (04BE)	Software Current Limit Selection	<b>V/f</b> <b>OLV/PM</b> <b>EZOLV</b> Set the software current limit selection function to prevent damage to the main circuit transistor caused by too much current. 0 : Disabled 1 : Enabled	0 (0, 1)	836
L8-19 (04BF)	Freq Reduction @ oH Pre-Alarm	<b>V/f</b> <b>OLV/PM</b> <b>EZOLV</b> Sets the ratio at which the drive derates the frequency reference during an oH alarm.	20.0% (10.0 - 100.0%)	837
L8-27 (04DD)	Overcurrent Detection Gain	<b>V/f</b> <b>OLV/PM</b> <b>EZOLV</b> Sets the PM motor overcurrent detection level as a percentage of the motor rated current value. <b>Note:</b> Parameter A1-02 [Control Method Selection] selects which parameter is the motor rated current. • A1-02 ≠ 8 [EZOLV]: E5-03 [PM Motor Rated Current (FLA)] • A1-02 = 8: E9-06 [Motor Rated Current (FLA)]	300.0% (0.0 - 1000.0%)	837
L8-29 (04DF)	Output Unbalance Detection Sel	<b>V/f</b> <b>OLV/PM</b> <b>EZOLV</b> Sets the function to detect LF2 [Output Current Imbalance]. 0 : Disabled 1 : Enabled	1 (0, 1)	837
L8-31 (04E1)	LF2 Detection Time	<b>V/f</b> <b>OLV/PM</b> <b>EZOLV</b> Sets the LF2 [Output Current Imbalance] detection time.	3 (1 - 100)	837
L8-35 (04EC)	Installation Method Selection	<b>V/f</b> <b>OLV/PM</b> <b>EZOLV</b> Sets the type of drive installation. 0 : IP20/UL Open Type 1 : Side-by-Side Mounting 2 : IP20/UL Type 1 3 : IP55/UL Type 12	Determined by the drive (0 - 3)	837
L8-38 (04EF)	Carrier Frequency Reduction	<b>V/f</b> <b>OLV/PM</b> <b>EZOLV</b> Sets the carrier frequency reduction function. The drive decreases the carrier frequency when the output current is more than a specified level. 1 : Enabled below 6 Hz 2 : Enabled for All Speeds 3 : Enable at Overload	Determined by o2-04 (1 - 3)	838

## 11.11 L: Protection Functions

No. (Hex.)	Name	Description	Default (Range)	Ref.
L8-41 (04F2)	High Current Alarm Selection	<p><input type="checkbox"/> V/f <input type="checkbox"/> OLV/PM <input checked="" type="checkbox"/> EZOLV</p> <p>Sets the function to cause an <i>HCA</i> [<i>High Current Alarm</i>] when the output current is more than 150% of the drive rated current.</p> <p>0 : Disabled 1 : Enabled</p>	0 (0, 1)	839
L8-90 (0175) Expert	STPo Detection Level (Low Speed)	<p><input type="checkbox"/> V/f <input type="checkbox"/> OLV/PM <input checked="" type="checkbox"/> EZOLV</p> <p>Sets the detection level that the control fault must be equal to or more than to cause an <i>STPo</i> [<i>Motor Step-Out Detected</i>].</p>	0 times (0 - 5000 times)	839
L8-97 (3104)	Carrier Freq Reduce during OH	<p><input type="checkbox"/> V/f <input type="checkbox"/> OLV/PM <input checked="" type="checkbox"/> EZOLV</p> <p>Sets the function to decrease carrier frequency during oH pre-alarm.</p> <p><b>Note:</b> When <i>A1-02</i> = 8 [<i>Control Method Selection</i> = <i>EZOLV</i>], this parameter is available only when <i>E9-01</i> = 0 [<i>Motor Type Selection</i> = <i>Induction (IM)</i>].</p> <p>0 : Disabled 1 : Enabled</p>	0 (0, 1)	839

## ◆ L9: Drive Protection 2

No. (Hex.)	Name	Description	Default (Range)	Ref.
L9-16 (11DC) Expert	FAn1 Detect Time	<p><input type="checkbox"/> V/f <input type="checkbox"/> OLV/PM <input checked="" type="checkbox"/> EZOLV</p> <p>Sets the detection time for <i>FAn1</i> [<i>Drive Cooling Fan Fault</i>]. Yaskawa recommends that you do not change this parameter value.</p>	4.0 s (0.0 - 30.0 s)	839

## 11.12 n: Special Adjustment

### ◆ n1: Hunting Prevention

No. (Hex.)	Name	Description	Default (Range)	Ref.
n1-01 (0580)	Hunting Prevention Selection	<b>V/f</b> <b>OLV/PM</b> <b>EZOLV</b> Sets the function to prevent hunting. 0 : Disabled 1 : Enabled (Normal)	1 (0, 1)	840
n1-02 (0581) Expert	Hunting Prevention Gain Setting	<b>V/f</b> <b>OLV/PM</b> <b>EZOLV</b> Sets the performance of the hunting prevention function. Usually it is not necessary to change this parameter.	1.00 (0.00 - 2.50)	840
n1-03 (0582) Expert	Hunting Prevention Time Constant	<b>V/f</b> <b>OLV/PM</b> <b>EZOLV</b> Sets the primary delay time constant of the hunting prevention function. Usually it is not necessary to change this parameter.	Determined by o2-04 (0 - 500 ms)	840
n1-05 (0530) Expert	Hunting Prevent Gain in Reverse	<b>V/f</b> <b>OLV/PM</b> <b>EZOLV</b> Sets the performance of the hunting prevention function. This parameter adjusts Reverse run. Usually it is not necessary to change this parameter.	0.00 (0.00 - 2.50)	840
n1-13 (1B59) Expert	DC Bus Stabilization Control	<b>V/f</b> <b>OLV/PM</b> <b>EZOLV</b> Sets the oscillation suppression function for the DC bus voltage. 0 : Disabled 1 : Enabled	0 (0, 1)	841
n1-14 (1B5A) Expert	DC Bus Stabilization Time	<b>V/f</b> <b>OLV/PM</b> <b>EZOLV</b> Adjusts the responsiveness of the oscillation suppression function for the DC bus voltage. Set <i>n1-13 = 1</i> [DC Bus Stabilization Control = Enabled] to enable this parameter.	100.0 ms (0.0 - 500.0 ms)	841

### ◆ n3: High Slip/Overexcite Braking

No. (Hex.)	Name	Description	Default (Range)	Ref.
n3-01 (0588) Expert	HSB Deceleration Frequency Width	<b>V/f</b> <b>OLV/PM</b> <b>EZOLV</b> Sets the amount by which the output frequency is to be lowered during high-slip braking, as a percentage of <i>E1-04</i> [Maximum Output Frequency], which represents the 100% value.	5% (1 - 20%)	842
n3-02 (0589) Expert	HSB Current Limit Level	<b>V/f</b> <b>OLV/PM</b> <b>EZOLV</b> Sets the maximum current output during high-slip braking as a percentage, where <i>E2-01</i> [Motor Rated Current (FLA)] is 100%. Also sets the current suppression to prevent exceeding drive overload tolerance.	Determined by L8-38 (0 - 200%)	843
n3-03 (058A) Expert	HSB Dwell Time at Stop	<b>V/f</b> <b>OLV/PM</b> <b>EZOLV</b> Sets the dwell time, a length of time when high-slip braking is ending and during which the motor speed decreases and runs at a stable speed. For a set length of time, the drive will hold the actual output frequency at the minimum output frequency set in <i>E1-09</i> .	1.0 s (0.0 - 10.0 s)	843
n3-04 (058B) Expert	HSB Overload Time	<b>V/f</b> <b>OLV/PM</b> <b>EZOLV</b> Sets the time used to detect <i>oL7</i> [High Slip Braking Overload], which occurs when the output frequency does not change during high-slip braking. Usually it is not necessary to change this parameter.	40 s (30 - 1200 s)	843
n3-13 (0531)	OverexcitationBraking (OEB) Gain	<b>V/f</b> <b>OLV/PM</b> <b>EZOLV</b> Sets the gain value that the drive multiplies by the V/f pattern output value during overexcitation deceleration to calculate the overexcitation level.	1.10 (1.00 - 1.40)	843
n3-21 (0579)	HSB Current Suppression Level	<b>V/f</b> <b>OLV/PM</b> <b>EZOLV</b> Sets the upper limit of the current that is suppressed at the time of overexcitation deceleration as a percentage of the drive rated current.	100% (0 - 150%)	844
n3-23 (057B)	Overexcitation Braking Operation	<b>V/f</b> <b>OLV/PM</b> <b>EZOLV</b> Sets the direction of motor rotation where the drive will enable overexcitation. 0 : Disabled 1 : Enabled Only when Rotating FWD 2 : Enabled Only when Rotating REV	0 (0 - 2)	844

## ◆ n7: EZ Drive

No. (Hex.)	Name	Description	Default (Range)	Ref.
n7-01 (3111) Expert	Damping Gain for Low Frequency	<input type="checkbox"/> V/f <input type="checkbox"/> OLV/PM <input checked="" type="checkbox"/> EZOLV Sets the oscillation suppression gain for the low speed range.	1.0 (0.1 - 10.0)	844
n7-05 (3115) Expert	Response Gain for Load Changes	<input type="checkbox"/> V/f <input type="checkbox"/> OLV/PM <input checked="" type="checkbox"/> EZOLV Sets the response gain related to changes in the load.	50 (10 - 1000)	844
n7-07 (3117) Expert	Speed Calculation Gain1	<input type="checkbox"/> V/f <input type="checkbox"/> OLV/PM <input checked="" type="checkbox"/> EZOLV Sets the speed calculation gain during usual operation. Usually it is not necessary to change this setting.	15.0 (1.0 - 50.0)	844
n7-08 (3118) Expert	Speed Calculation Gain2	<input type="checkbox"/> V/f <input type="checkbox"/> OLV/PM <input checked="" type="checkbox"/> EZOLV Sets the speed calculation gain during a speed search. <b>Note:</b> When E9-01 = 1 [Motor Type Selection = Permanent Magnet (PM)], the setting range is 1.0 - 80.0.	25.0 (1.0 - 50.0)	845
n7-10 (311A) Expert	Pull-in Current Switching Speed	<input type="checkbox"/> V/f <input type="checkbox"/> OLV/PM <input checked="" type="checkbox"/> EZOLV Parameter n8-51 [Pull-in Current @ Acceleration], is in effect when the output frequency is $\leq n7-10$ , where the speed is set as a percentage of rated speed. <b>Note:</b> • The value set in n8-51 [Pull-in Current @ Acceleration] is enabled for speeds that are not higher than n7-10 during deceleration. The value set in b8-01 [Energy Saving Control Selection] is enabled for speeds higher than n7-10. • If there is a large quantity of oscillation when you operate in the low speed range, increase the setting value. • When it is most important to save energy in the low speed range, decrease the setting value.	10.0% (0.0 - 100.0%)	845
n7-11 (311B) Expert	Drv Mode Switch Hysteresis Band	<input type="checkbox"/> V/f <input type="checkbox"/> OLV/PM <input checked="" type="checkbox"/> EZOLV Sets the hysteresis level for Switching Speed set in n7-10 [Pull-in Current Switching Speed]. When the speed is lower than n7-10 + n7-11 during acceleration, the drive enables pull-in current. <b>Note:</b> • The value set in n8-51 [Pull-in Current @ Acceleration] is enabled for speeds that are not higher than n7-10 + n7-11 during acceleration. The value set in b8-01 [Energy Saving Control Selection] is enabled for speeds higher than n7-10 + n7-11. • If there is a large quantity of oscillation when you operate in the low speed range, increase the setting value. • When it is most important to save energy in the low speed range, decrease the setting value.	5.0% (1.0 - 20.0%)	845
n7-13 (311D) Expert	Pull-in Current Switching Time	<input type="checkbox"/> V/f <input type="checkbox"/> OLV/PM <input checked="" type="checkbox"/> EZOLV Sets a time to enable the pull-in current commands. If there is a large quantity of oscillation at speeds around n7-10 [Pull-in Current Switching Speed], decrease the setting in decrements of 20 ms.	100 ms (0 - 1000 ms)	845
n7-17 (3122)	Resistance TemperatureCorrection	<input type="checkbox"/> V/f <input type="checkbox"/> OLV/PM <input checked="" type="checkbox"/> EZOLV Sets the function to adjust for changes in the motor resistance value caused by changes in the temperature. 0 : Invalid 1 : Valid (Only 1 time) 2 : Valid (Every time)	1 (0 to 2)	845

## ◆ n8: PM Motor Control Tuning

No. (Hex.)	Name	Description	Default (Range)	Ref.
n8-23 (0556) Expert	ACR q Gain @PoleEst	<input type="checkbox"/> V/f <input type="checkbox"/> OLV/PM <input checked="" type="checkbox"/> EZOLV Sets the proportional gain for current regulator q-axis control when the drive estimates the initial pole. Usually it is not necessary to change this setting.	0 (0 - 2000)	846
n8-24 (0557) Expert	ACR q Integral Time @PoleEst	<input type="checkbox"/> V/f <input type="checkbox"/> OLV/PM <input checked="" type="checkbox"/> EZOLV Sets the integral time for current regulator q-axis control when the drive estimates the initial pole. Usually it is not necessary to change this setting.	0.0 ms (0.0 - 100.0 ms)	846
n8-25 (0558) Expert	ACR q Limit @PoleEst	<input type="checkbox"/> V/f <input type="checkbox"/> OLV/PM <input checked="" type="checkbox"/> EZOLV Sets the q-axis limit of the current regulator when the drive estimates the initial pole. Usually it is not necessary to change this setting.	0% (0 - 150%)	846

No. (Hex.)	Name	Description	Default (Range)	Ref.
n8-26 (0559) Expert	ACR d Gain @PoleEst	 Sets the proportional gain for current regulator d-axis control when the drive estimates the initial pole. Usually it is not necessary to change this setting.	500 (0 - 2000)	846
n8-27 (055A) Expert	ACR d Integral Time @PoleEst	 Sets the integral time for current regulator d-axis control when the drive estimates the initial pole. Usually it is not necessary to change this setting.	0.0 ms (0.0 - 100.0 ms)	846
n8-28 (055B) Expert	ACR d Lim @PoleEst	 Sets the d-axis limit of the current regulator when the drive estimates the initial pole. Usually it is not necessary to change this setting.	100% (0 - 150%)	846
n8-35 (0562)	Initial Pole Detection Method	 Sets how the drive detects the position of the rotor at start. <b>Note:</b> • When you operate an SPM motor, set $n8-35 = 0$ . When you operate an IPM motor, set $n8-35 = 0$ to $2$ . • When you set $n8-35 = 1$ , do High Frequency Injection Auto-Tuning. 0 : Pull-in 1 : High Frequency Injection	0 (0, 1)	847
n8-36 (0563)	HFI Frequency Level for L Tuning	 Sets the injection frequency for high frequency injection. <b>Note:</b> • Set $n8-35 = 1$ [Initial Pole Detection Method = High Frequency Injection] to enable this parameter. • The drive automatically calculates this value when High Frequency Injection Auto-Tuning completes successfully.	500 Hz (200 - 1000 Hz)	847
n8-37 (0564) Expert	HFI Voltage Amplitude Level	 Sets the high frequency injection amplitude as a percentage where 200 V = 100% for 208 V class drives and 400 V = 100% for a 480 V class drives. Usually it is not necessary to change this setting. <b>Note:</b> • Set $n8-35 = 1$ [Initial Pole Detection Method = High Frequency Injection] to enable this parameter. • The drive automatically calculates this value when High Frequency Injection Auto-Tuning completes successfully.	20.0% (0.0 - 50.0%)	847
n8-39 (0566)	HFI LPF Cutoff Freq	 Sets the low-pass filter shut-off frequency for high frequency injection. <b>Note:</b> • Set $n8-35 = 1$ [Initial Pole Detection Method = High Frequency Injection] to enable this parameter. • The drive automatically calculates this value when High Frequency Injection Auto-Tuning completes successfully.	250 Hz (0 - 1000 Hz)	847
n8-41 (0568) Expert	HFI P Gain	 Sets the response gain for the high frequency injection speed estimation. <b>Note:</b> • Set $n8-35 = 1$ [Initial Pole Detection Method = High Frequency Injection] to enable this parameter. • Set $n8-41 > 0.0$ for IPM motors.	2.5 (-10.0 - +10.0)	847
n8-42 (0569) Expert	HFI I Time	 Sets the integral time constant for the high frequency injection speed estimation. Usually it is not necessary to change this setting. <b>Note:</b> Set $n8-35 = 1$ [Initial Pole Detection Method = High Frequency Injection] to enable this parameter.	0.10 s (0.00 - 9.99 s)	848
n8-45 (0538)	Speed Feedback Detection Gain	 Sets the internal speed feedback detection reduction unit gain as a magnification value. Usually it is not necessary to change this setting.	0.80 (0.00 - 10.00)	848
n8-46 (0539) Expert	PM Phase Compensation Gain	 Sets the gain to compensate for phase differences. Usually it is not necessary to change this setting.	0.3 (0.0 - 10.0)	848
n8-47 (053A)	Pull-in Current Comp Filter Time	 Sets the time constant the drive uses to align the pull-in current reference value with the actual current value. Usually it is not necessary to change this setting.	5.0 s (0.0 - 100.0 s)	848
n8-48 (053B)	Pull-in/Light Load Id Current	 Sets the d-axis current that flows to the motor during run at constant speed as a percentage where $E5-03$ [PM Motor Rated Current (FLA)] = 100%.	30% (0 - 200%)	849

## 11.12 n: Special Adjustment

No. (Hex.)	Name	Description	Default (Range)	Ref.
n8-49 (053C)	Heavy Load Id Current	<input type="checkbox"/> V/f <input checked="" type="checkbox"/> OLV/PM <input type="checkbox"/> EZOLV Sets the d-axis current to that the drive will supply to the motor to run it at a constant speed with a heavy load. Considers <i>E5-03 [PM Motor Rated Current (FLA)]</i> to be 100%. Usually it is not necessary to change this setting.	Determined by E5-01 (-200.0 - +200.0%)	849
n8-50 (053D)	Medium Load Iq Level (High)	<input type="checkbox"/> V/f <input checked="" type="checkbox"/> OLV/PM <input type="checkbox"/> EZOLV Sets the load current level to start high efficiency control as a percentage of <i>E5-03 [PM Motor Rated Current (FLA)]</i> . Usually it is not necessary to change this setting.	80% (50 - 255%)	849
n8-51 (053E)	Pull-in Current @ Acceleration	<input type="checkbox"/> V/f <input checked="" type="checkbox"/> OLV/PM <input type="checkbox"/> EZOLV Sets the pull-in current allowed to flow during acceleration/deceleration as a percentage of the motor rated current. <b>Note:</b> Parameter <i>A1-02 [Control Method Selection]</i> selects which parameter is the motor rated current. • <i>A1-02 = 5 [OLV/PM]</i> : <i>E5-03 [PM Motor Rated Current (FLA)]</i> • <i>A1-02 = 8 [EZOLV]</i> : <i>E9-06 [Motor Rated Current (FLA)]</i>	Determined by A1-02 (0 - 200%)	849
n8-52 (053F) Expert	ACR P Gain	<input type="checkbox"/> V/f <input checked="" type="checkbox"/> OLV/PM <input type="checkbox"/> EZOLV Sets the proportional gain of the current regulator. Usually it is not necessary to change this setting.	10.0 (-100.0 - 100.0)	849
n8-54 (056D) Expert	Voltage Error Compensation Time	<input type="checkbox"/> V/f <input checked="" type="checkbox"/> OLV/PM <input type="checkbox"/> EZOLV Sets the time constant that the drive uses when adjusting for voltage errors.	1.00 s (0.00 - 10.00 s)	850
n8-55 (056E)	Motor to Load Inertia Ratio	<input type="checkbox"/> V/f <input checked="" type="checkbox"/> OLV/PM <input type="checkbox"/> EZOLV Sets the ratio between motor inertia and machine inertia. 0 : Below 1:10 1 : Between 1:10 and 1:30 2 : Between 1:30 and 1:50 3 : Beyond 1:50	0 (0 - 3)	850
n8-56 (056F) Expert	PM High Performance Selection	<input type="checkbox"/> V/f <input checked="" type="checkbox"/> OLV/PM <input type="checkbox"/> EZOLV Usually it is not necessary to change this setting. Sets the high efficiency control method for IPM motor. 0 : Disabled 1 : Enabled (Vd) 2 : Enabled (Vd & Vq)	1 (0 - 2)	851
n8-62 (057D) Expert	Output Voltage Limit Level	<input type="checkbox"/> V/f <input checked="" type="checkbox"/> OLV/PM <input type="checkbox"/> EZOLV Sets the output voltage limit to prevent saturation of the output voltage. Usually it is not necessary to change this parameter. <b>Note:</b> • When <i>A1-02 = 8 [Control Method Selection = EZOLV]</i> , this parameter is available in Expert Mode. • When <i>A1-02 = 8</i> , the default setting is: -208 V Class: 230.0 V -480 V Class: 460.0 V	208 V Class: 200.0 V, 480 V Class: 400.0 V (208 V Class: 0.0 - 240.0 V, 480 V Class: 0.0 - 480.0 V)	851
n8-63 (057E) Expert	Output Voltage Limit P Gain	<input type="checkbox"/> V/f <input checked="" type="checkbox"/> OLV/PM <input type="checkbox"/> EZOLV Sets the proportional gain for output voltage control. Usually it is not necessary to change this setting.	1.00 (0.00 - 100.00)	851
n8-64 (057F) Expert	Output Voltage Limit I Time	<input type="checkbox"/> V/f <input checked="" type="checkbox"/> OLV/PM <input type="checkbox"/> EZOLV Sets the integral time for output voltage control. Usually it is not necessary to change this setting.	0.040 s (0.000 - 5.000)	851
n8-65 (065C) Expert	Speed Fdbk Gain @ oV Suppression	<input type="checkbox"/> V/f <input checked="" type="checkbox"/> OLV/PM <input type="checkbox"/> EZOLV Sets the gain of internal speed feedback detection suppression while the overvoltage suppression function is operating as a magnification value. Usually it is not necessary to change this parameter.	1.50 (0.00 - 10.00)	851
n8-66 (0235) Expert	Output Voltage Limit Filter Time	<input type="checkbox"/> V/f <input checked="" type="checkbox"/> OLV/PM <input type="checkbox"/> EZOLV Sets the filter time constant for output voltage control. Usually it is not necessary to change this setting.	0.020 s (0.000 - 5.000)	852
n8-74 (05C3)	Light Load Iq Level	<input type="checkbox"/> V/f <input checked="" type="checkbox"/> OLV/PM <input type="checkbox"/> EZOLV Set <i>n8-48 [Pull-in/Light Load Id Current]</i> to the percentage of load current (q-axis current) that you will apply, where <i>E5-03 [PM Motor Rated Current (FLA)]</i> = a setting value of 100%.	30% (0 - 255%)	852
n8-75 (05C4)	Medium Load Iq Level (low)	<input type="checkbox"/> V/f <input checked="" type="checkbox"/> OLV/PM <input type="checkbox"/> EZOLV Set <i>n8-78 [Medium Load Id Current]</i> to the percentage of load current (q-axis current) that you will apply, where <i>E5-03 [PM Motor Rated Current (FLA)]</i> = a setting value of 100%.	50% (0 - 255%)	852

No. (Hex.)	Name	Description	Default (Range)	Ref.
n8-76 (05CD) Expert	Id Switching Filter Time	<input type="checkbox"/> V/f <input checked="" type="checkbox"/> OLV/PM <input type="checkbox"/> EZOLV Sets the filter time constant for d-axis current reference. Usually it is not necessary to change this setting.	200 ms (0 - 5000 ms)	852
n8-77 (05CE)	Heavy Load Iq Level	<input type="checkbox"/> V/f <input checked="" type="checkbox"/> OLV/PM <input type="checkbox"/> EZOLV Set n8-49 [Heavy Load Id Current] to the percentage of load current (q-axis current) that you will apply, where E5-03 [PM Motor Rated Current (FLA)] = a setting value of 100%.	90% (0 - 255%)	852
n8-78 (05F4)	Medium Load Id Current	<input type="checkbox"/> V/f <input checked="" type="checkbox"/> OLV/PM <input type="checkbox"/> EZOLV Sets the level of the pull-in current for mid-range loads.	0% (-200 - +200%)	852
n8-79 (05FE)	Pull-in Current @ Deceleration	<input type="checkbox"/> V/f <input checked="" type="checkbox"/> OLV/PM <input type="checkbox"/> EZOLV Sets the pull-in current that can flow during deceleration as a percentage of the E5-03 [PM Motor Rated Current (FLA)]. <b>Note:</b> When n8-79 = 0, the drive will use the value set in n8-51 [Pull-in Current @ Acceleration].	50% (0 - 200%)	853
n8-84 (02D3) Expert	Polarity Detection Current	<input type="checkbox"/> V/f <input checked="" type="checkbox"/> OLV/PM <input type="checkbox"/> EZOLV Sets the current for processing an estimation of the initial motor magnetic pole as a percentage, where E5-03 [PM Motor Rated Current] is the 100% value.	100% (0 - 150%)	853
n8-91 (02F7) Expert	Id Limit at Voltage Saturation	<input type="checkbox"/> V/f <input checked="" type="checkbox"/> OLV/PM <input type="checkbox"/> EZOLV Sets the limit value of feedback output voltage limit Id operation. Usually it is not necessary to change this setting.	-50% (-200 - 0%)	853

## 11.13 o: Keypad-Related Settings

### ◆ o1: Keypad Display

No. (Hex.)	Name	Description	Default (Range)	Ref.
o1-03 (0502)	Frequency Display Unit Selection	<p><b>V/f</b> <b>OLV/PM</b> <b>EZOLV</b></p> <p>Sets the display units for the frequency reference and output frequency.</p> <p>0 : 0.01Hz units 1 : 0.01% units 2 : min<sup>-1</sup> (r/min) unit 3 : User Units (o1-09 ~o1-11)</p>	0 (0 - 3)	858
o1-05 (0504) RUN	LCD Contrast Adjustment	<p><b>V/f</b> <b>OLV/PM</b> <b>EZOLV</b></p> <p>Sets the contrast of the LCD display on the keypad.</p>	5 (0 - 10)	859
o1-09 (051C)	Freq. Reference Display Units	<p><b>V/f</b> <b>OLV/PM</b> <b>EZOLV</b></p> <p>Sets the unit of display for the frequency reference parameters and frequency-related monitors when o1-03 = 3 [Frequency Display Unit Selection = User Units (o1-09 ~ o1-11)].</p> <p>0 : "WC: inches of water column 1 : PSI: pounds per square inch 2 : GPM: gallons/min 3 : °F: Fahrenheit 4 : ft<sup>3</sup>/min: cubic feet/min 5 : m<sup>3</sup>/h: cubic meters/hour 6 : L/h: liters/hour 7 : L/s: liters/sec 8 : bar: bar 9 : Pa: Pascal 10 : °C: Celsius 11 : m: meters 12 : ft: feet 13 : L/min: liters/min 14 : m<sup>3</sup>/min: cubic meters/min 15 : "Hg: Inch Mercury 16 : kPa: kilopascal 48 : %: Percent 49 : Custom(o1-13~15) 50 : None</p>	50 (0 - 50)	859
o1-10 (0520)	User Units Maximum Value	<p><b>V/f</b> <b>OLV/PM</b> <b>EZOLV</b></p> <p>Sets the value that the drive shows as the maximum output frequency.</p>	Determined by o1-03 (1 - 60000)	859
o1-11 (0521)	User Units Decimal Position	<p><b>V/f</b> <b>OLV/PM</b> <b>EZOLV</b></p> <p>Sets the number of decimal places for frequency reference and monitor values.</p> <p>0 : No Decimal Places (XXXXX) 1 : One Decimal Places (XXXX.X) 2 : Two Decimal Places (XXX.XX) 3 : Three Decimal Places (XX.XXX)</p>	Determined by o1-03 (0 - 3)	860
o1-13 (3105)	Freq. Reference Custom Unit 1	<p><b>V/f</b> <b>OLV/PM</b> <b>EZOLV</b></p> <p>Sets the first character of the custom unit display when o1-03 = 3 [Frequency Display Unit Selection = User Units] and o1-09 = 49 [Freq. Reference Display Units = Custom (o1-13~15)].</p>	41 (20 - 7A)	860
o1-14 (3106)	Freq. Reference Custom Unit 2	<p><b>V/f</b> <b>OLV/PM</b> <b>EZOLV</b></p> <p>Sets the second character of the custom unit display when o1-03 = 3 [Frequency Display Unit Selection = User Units] and o1-09 = 49 [Freq. Reference Display Units = Custom (o1-13~15)].</p>	41 (20 - 7A)	860
o1-15 (3107)	Freq. Reference Custom Unit 3	<p><b>V/f</b> <b>OLV/PM</b> <b>EZOLV</b></p> <p>Sets the third character of the custom unit display when o1-03 = 3 [Frequency Display Unit Selection = User Units] and o1-09 = 49 [Freq. Reference Display Units = Custom (o1-13~15)].</p>	41 (20 - 7A)	860
o1-17 (3109)	F3 Key Function Selection	<p><b>V/f</b> <b>OLV/PM</b> <b>EZOLV</b></p> <p>Sets the action when you push the F3 key and the LCD display text above the F3 key.</p> <p>0 : Standard (based on screen) 1 : MONITOR (shortcut) 4 : RLY (ON/OFF H2-XX = A9)</p>	0 (0 - 4)	860



No. (Hex.)	Name	Description	Default (Range)	Ref.
o1-18 (310A)	User Defined Parameter 1	<b>V/f</b> <b>OLV/PM</b> <b>EZOLV</b> Lets you set values to use as reference information.	0 (0 - 999)	861
o1-19 (310B)	User Defined Parameter 2	<b>V/f</b> <b>OLV/PM</b> <b>EZOLV</b> Lets you set values to use as reference information.	0 (0 - 999)	861
o1-24 (11AD) RUN	Custom Monitor 1	<b>V/f</b> <b>OLV/PM</b> <b>EZOLV</b> Sets Custom Monitor 1. You can set a maximum of 12 monitors as user monitors. This parameter is only available on an HOA keypad.	101 (0, 101 - 1299)	861
o1-25 (11AE) RUN	Custom Monitor 2	<b>V/f</b> <b>OLV/PM</b> <b>EZOLV</b> Sets Custom Monitor 2. You can set a maximum of 12 monitors as user monitors. This parameter is only available on an HOA keypad.	102 (0, 101 - 1299)	861
o1-26 (11AF) RUN	Custom Monitor 3	<b>V/f</b> <b>OLV/PM</b> <b>EZOLV</b> Sets Custom Monitor 3. You can set a maximum of 12 monitors as user monitors. This parameter is only available on an HOA keypad. <b>Note:</b> The default setting changes when <i>b5-01 [PID Mode Setting]</i> changes: • <i>b5-01 = 0 [Disabled]</i> : 103 • <i>b5-01 ≠ 0</i> : 501	Determined by b5-01 (0, 101 - 1299)	861
o1-27 (11B0) RUN	Custom Monitor 4	<b>V/f</b> <b>OLV/PM</b> <b>EZOLV</b> Sets Custom Monitor 4. You can set a maximum of 12 monitors as user monitors. This parameter is only available on an HOA keypad.	0 (0, 101 - 1299)	861
o1-28 (11B1) RUN	Custom Monitor 5	<b>V/f</b> <b>OLV/PM</b> <b>EZOLV</b> Sets Custom Monitor 5. You can set a maximum of 12 monitors as user monitors. This parameter is only available on an HOA keypad.	0 (0, 101 - 1299)	861
o1-29 (11B2) RUN	Custom Monitor 6	<b>V/f</b> <b>OLV/PM</b> <b>EZOLV</b> Sets Custom Monitor 6. You can set a maximum of 12 monitors as user monitors. This parameter is only available on an HOA keypad.	0 (0, 101 - 1299)	861
o1-30 (11B3) RUN	Custom Monitor 7	<b>V/f</b> <b>OLV/PM</b> <b>EZOLV</b> Sets Custom Monitor 7. You can set a maximum of 12 monitors as user monitors. This parameter is only available on an HOA keypad.	0 (0, 101 - 1299)	861
o1-31 (11B4) RUN	Custom Monitor 8	<b>V/f</b> <b>OLV/PM</b> <b>EZOLV</b> Sets Custom Monitor 8. You can set a maximum of 12 monitors as user monitors. This parameter is only available on an HOA keypad.	0 (0, 101 - 1299)	861
o1-32 (11B5) RUN	Custom Monitor 9	<b>V/f</b> <b>OLV/PM</b> <b>EZOLV</b> Sets Custom Monitor 9. You can set a maximum of 12 monitors as user monitors. This parameter is only available on an HOA keypad.	0 (0, 101 - 1299)	861
o1-33 (11B6) RUN	Custom Monitor 10	<b>V/f</b> <b>OLV/PM</b> <b>EZOLV</b> Sets Custom Monitor 10. You can set a maximum of 12 monitors as user monitors. This parameter is only available on an HOA keypad.	0 (0, 101 - 1299)	861
o1-34 (11B7) RUN	Custom Monitor 11	<b>V/f</b> <b>OLV/PM</b> <b>EZOLV</b> Sets Custom Monitor 11. You can set a maximum of 12 monitors as user monitors. This parameter is only available on an HOA keypad.	0 (0, 101 - 1299)	861
o1-35 (11B8) RUN	Custom Monitor 12	<b>V/f</b> <b>OLV/PM</b> <b>EZOLV</b> Sets Custom Monitor 12. You can set a maximum of 12 monitors as user monitors. This parameter is only available on an HOA keypad.	0 (0, 101 - 1299)	861
o1-36 (11B9) RUN	LCD Backlight Brightness	<b>V/f</b> <b>OLV/PM</b> <b>EZOLV</b> Sets the intensity of the HOA keypad backlight.	5 (1 - 5)	861
o1-37 (11BA) RUN	LCD Backlight ON/OFF Selection	<b>V/f</b> <b>OLV/PM</b> <b>EZOLV</b> Sets the automatic shut off function for the LCD backlight. 0 : OFF 1 : ON	1 (0, 1)	862
o1-38 (11BB) RUN	LCD Backlight Off-Delay	<b>V/f</b> <b>OLV/PM</b> <b>EZOLV</b> Sets the time until the LCD backlight automatically turns off.	60 s (10 - 300 s)	862
o1-39 (11BC) RUN	Show Initial Setup Screen	<b>V/f</b> <b>OLV/PM</b> <b>EZOLV</b> Sets the function to show the HOA keypad initial setup screen each time you energize the drive. This parameter is only available on an HOA keypad. 0 : No 1 : Yes	1 (0, 1)	862

## 11.13 o: Keypad-Related Settings

No. (Hex.)	Name	Description	Default (Range)	Ref.
o1-40 (11BD) RUN	Home Screen Display Selection	<b>V/f</b> <b>OLV/PM</b> <b>EZOLV</b> Sets the monitor display mode for the Home screen. This parameter is only available on an HOA keypad. 0 : Custom Monitor 1 : Bar Graph 2 : Analog Gauge 3 : Trend Plot	0 (0 - 3)	862
o1-41 (11C1) RUN	1st Monitor Area Selection	<b>V/f</b> <b>OLV/PM</b> <b>EZOLV</b> Sets the horizontal range used to display the monitor set in o1-24 [Custom Monitor 1] as a bar graph. This parameter is only available on an HOA keypad. 0 : +/- Area ( - o1-42 ~ o1-42 ) 1 : + Area ( 0 ~ o1-42 )	0 (0 - 1)	863
o1-42 (11C2) RUN	1st Monitor Area Setting	<b>V/f</b> <b>OLV/PM</b> <b>EZOLV</b> Sets the horizontal axis value used to display the monitor set in o1-24 [Custom Monitor 1] as a bar graph. This parameter is only available on an HOA keypad.	100.0% (0.0 - 100.0%)	863
o1-43 (11C3) RUN	2nd Monitor Area Selection	<b>V/f</b> <b>OLV/PM</b> <b>EZOLV</b> Selects the horizontal range used to display the monitor set in o1-25 [Custom Monitor 2] as a bar graph. This parameter is only available on an HOA keypad. 0 : +/- Area ( - o1-44 ~ o1-44 ) 1 : + Area ( 0 ~ o1-44 )	0 (0 - 1)	863
o1-44 (11C4) RUN	2nd Monitor Area Setting	<b>V/f</b> <b>OLV/PM</b> <b>EZOLV</b> Sets the horizontal axis value used to display the monitor set in o1-25 [Custom Monitor 2] as a bar graph. This parameter is only available on an HOA keypad.	100.0% (0.0 - 100.0%)	863
o1-45 (11C5) RUN	3rd Monitor Area Selection	<b>V/f</b> <b>OLV/PM</b> <b>EZOLV</b> Sets the horizontal range used to display the monitor set in o1-26 [Custom Monitor 3] as a bar graph. This parameter is only available on an HOA keypad. 0 : +/- Area ( - o1-46 ~ o1-46 ) 1 : + Area ( 0 ~ o1-46 )	0 (0 - 1)	863
o1-46 (11C6) RUN	3rd Monitor Area Setting	<b>V/f</b> <b>OLV/PM</b> <b>EZOLV</b> Sets the horizontal axis value used to display the monitor set in o1-26 [Custom Monitor 3] as a bar graph. This parameter is only available on an HOA keypad.	100.0% (0.0 - 100.0%)	863
o1-47 (11C7) RUN	Trend Plot 1 Scale Minimum Value	<b>V/f</b> <b>OLV/PM</b> <b>EZOLV</b> Sets the horizontal axis minimum value used to display the monitor set in o1-24 [Custom Monitor 1] as a trend plot. This parameter is only available on an HOA keypad.	-100.0% (-300.0 - +299.9%)	864
o1-48 (11C8) RUN	Trend Plot 1 Scale Maximum Value	<b>V/f</b> <b>OLV/PM</b> <b>EZOLV</b> Sets the horizontal axis maximum value used to display the monitor set in o1-24 [Custom Monitor 1] as a trend plot. This parameter is only available on an HOA keypad.	100.0% (-299.9 - +300.0%)	864
o1-49 (11C9) RUN	Trend Plot 2 Scale Minimum Value	<b>V/f</b> <b>OLV/PM</b> <b>EZOLV</b> Sets the horizontal axis minimum value used to display the monitor set in o1-25 [Custom Monitor 2] as a trend plot. This parameter is only available on an HOA keypad.	-100.0% (-300.0 - +299.9%)	864
o1-50 (11CA) RUN	Trend Plot 2 Scale Maximum Value	<b>V/f</b> <b>OLV/PM</b> <b>EZOLV</b> Sets the horizontal axis maximum value used to display the monitor set in o1-25 [Custom Monitor 2] as a trend plot. This parameter is only available on an HOA keypad.	100.0% (-299.9 - +300.0%)	864
o1-51 (11CB) RUN	Trend Plot Time Scale Setting	<b>V/f</b> <b>OLV/PM</b> <b>EZOLV</b> Sets the time scale (horizontal axis) to display the trend plot. When you change this setting, the drive automatically adjusts the data sampling time. This parameter is only available on an HOA keypad.	300 s (1 - 3600 s)	864
o1-55 (11EE) RUN	Analog Gauge Area Selection	<b>V/f</b> <b>OLV/PM</b> <b>EZOLV</b> Sets the range used to display the monitor set in o1-24 [Custom Monitor 1] as an analog gauge. This parameter is only available on an HOA keypad. 0 : +/- Area ( - o1-56 ~ o1-56 ) 1 : + Area ( 0 ~ o1-56 )	1 (0, 1)	864
o1-56 (11EF) RUN	Analog Gauge Area Setting	<b>V/f</b> <b>OLV/PM</b> <b>EZOLV</b> Sets the value used to display the monitor set in o1-24 [Custom Monitor 1] as an analog meter. This parameter is only available on an HOA keypad.	100.0% (0.0 - 100.0%)	864
o1-58 (3125)	Motor Power Unit Selection	<b>V/f</b> <b>OLV/PM</b> <b>EZOLV</b> Sets the setting unit for parameters that set the motor rated power. 0 : kW 1 : HP	1 (0, 1)	865

No. (Hex.)	Name	Description	Default (Range)	Ref.
o1-80 (31BA)	Fault Screen Display	Sets a full-screen display message to show on the keypad when a fault or CPF occurs. 0 : OFF 1 : ON	1 (0, 1)	865
o1-81 (31BB)	Alarm Screen Display	Sets a full-screen display message to show on the keypad when an alarm occurs. 0 : OFF 1 : ON	0 (0, 1)	865
o1-82 (31BC)	Message Screen Display	Sets a full-screen display message to show on the keypad when a status message is active. 0 : OFF 1 : ON	0 (0, 1)	865

## ◆ o2: Keypad Operation

No. (Hex.)	Name	Description	Default (Range)	Ref.
o2-02 (0506)	OFF Key Function Selection	Sets the function to use  on the keypad to stop the drive when the Run command source for the drive is REMOTE (external) and not assigned to the keypad. 0 : Disabled 1 : Enabled	1 (0, 1)	866
o2-03 (0507)	User Parameter Default Value	Sets the function to keep the settings of changed parameters as user parameter defaults to use during initialization. 0 : No change 1 : Set defaults 2 : Clear all	0 (0 - 2)	866
o2-04 (0508)	Drive Model (KVA) Selection	Sets the Drive Model code. Set this parameter after you replace the control board.	Determined by the drive (-)	866
o2-05 (0509)	Home Mode Freq Ref Entry Mode	Sets the function that makes it necessary to push  to use the keypad to change the frequency reference value while in Drive Mode. 0 : ENTER Key Required 1 : Immediate / MOP-style	0 (0, 1)	867
o2-06 (050A)	Keypad Disconnect Detection	Sets the function that stops the drive if you disconnect the keypad connection cable from the drive or if you damage the cable while the keypad is the Run command source. 0 : Disabled 1 : Enabled	1 (0, 1)	867
o2-09 (050D)	Reserved	-	-	868
o2-19 (061F)	Parameter Write during $U_v$	Enables and disables the function to change parameter settings during a $U_v$ [DC Bus Undervoltage] condition. 0 : Disabled 1 : Enabled	0 (0, 1)	868
o2-23 (11F8) RUN	External 24V Powerloss Detection	Sets the function to give a warning if the backup external 24 V power supply turns off when the main circuit power supply is in operation. 0 : Disabled 1 : Enabled	0 (0, 1)	868
o2-24 (11FE)	LED Light Function Selection	Sets the function to show the LED status rings and keypad LED lamps. <b>Note:</b> When you use A1-03 [Initialize Parameters] to initialize the drive, the drive will not reset this parameter. 0 : Enable Status Ring & Keypad LED 1 : LED Status Ring Disable 2 : Keypad LED Light Disable	2 (0 - 2)	868

## 11.13 o: Keypad-Related Settings

No. (Hex.)	Name	Description	Default (Range)	Ref.
o2-26 (1563)	Alarm Display at Ext. 24V Power	<p><input type="checkbox"/> V/f <input type="checkbox"/> OLV/PM <input type="checkbox"/> EZOLV</p> <p>When you connect a backup external 24 V power supply, this parameter sets the function to trigger an alarm when the main circuit power supply voltage decreases.</p> <p><b>Note:</b> The drive will not run when it is operating from one 24-V external power supply.</p> <p>0 : Disabled 1 : Enabled</p>	1 (0, 1)	868
o2-27 (1565)	bCE Detection Selection	<p><input type="checkbox"/> V/f <input type="checkbox"/> OLV/PM <input type="checkbox"/> EZOLV</p> <p>Sets drive operation if the Bluetooth device is disconnected when you operate the drive in Bluetooth Mode.</p> <p>0 : Ramp to Stop 1 : Coast to Stop 2 : Fast Stop (Use C1-09) 3 : Alarm Only 4 : No Alarm Display</p>	3 (0 - 4)	869

## ◆ o3: Copy Keypad Function

No. (Hex.)	Name	Description	Default (Range)	Ref.
o3-01 (0515)	Copy Keypad Function Selection	<p><input type="checkbox"/> V/f <input type="checkbox"/> OLV/PM <input type="checkbox"/> EZOLV</p> <p>Sets the function that saves and copies drive parameters to a different drive with the keypad.</p> <p>0 : Copy Select 1 : Backup (drive → keypad) 2 : Restore (keypad → drive) 3 : Verify (check for mismatch) 4 : Erase (backup data of keypad)</p>	0 (0 - 4)	869
o3-02 (0516)	Copy Allowed Selection	<p><input type="checkbox"/> V/f <input type="checkbox"/> OLV/PM <input type="checkbox"/> EZOLV</p> <p>Sets the copy function when o3-01 = 1 [Copy Keypad Function Selection = Backup (drive → keypad)].</p> <p>0 : Disabled 1 : Enabled</p>	0 (0, 1)	869
o3-04 (0B3E)	Select Backup/Restore Location	<p><input type="checkbox"/> V/f <input type="checkbox"/> OLV/PM <input type="checkbox"/> EZOLV</p> <p>Sets the storage location for drive parameters when you back up and restore parameters. This parameter is only available on an HOA keypad.</p> <p>0 : Memory Location 1 1 : Memory Location 2 2 : Memory Location 3 3 : Memory Location 4</p>	0 (0 - 3)	870
o3-05 (0BDA)	Select Items to Backup/Restore	<p><input type="checkbox"/> V/f <input type="checkbox"/> OLV/PM <input type="checkbox"/> EZOLV</p> <p>Sets which parameters the drive backs up, restores, and references. This parameter is only available on an HOA keypad.</p> <p>0 : Standard Parameters 1 : Standard + DWEZ Parameters</p>	1 (0, 1)	870
o3-06 (0BDE)	Auto Parameter Backup Selection	<p><input type="checkbox"/> V/f <input type="checkbox"/> OLV/PM <input type="checkbox"/> EZOLV</p> <p>Sets the function that automatically backs up parameters. This parameter is only available on an HOA keypad.</p> <p>0 : Disabled 1 : Enabled</p>	1 (0, 1)	870
o3-07 (0BDF)	Auto Parameter Backup Interval	<p><input type="checkbox"/> V/f <input type="checkbox"/> OLV/PM <input type="checkbox"/> EZOLV</p> <p>Sets the interval at which the automatic parameter backup function saves parameters from the drive to the keypad.</p> <p><b>Note:</b> This parameter is only available when using an LCD keypad.</p> <p>0 : Every 10 minutes 1 : Every 30 minutes 2 : Every 60 minutes 3 : Every 12 hours</p>	1 (0 - 3)	870

## ◆ o4: Maintenance Monitors

No. (Hex.)	Name	Description	Default (Range)	Ref.
o4-01 (050B)	Elapsed Operating Time Setting	<b>V/f</b> <b>OLV/PM</b> <b>EZOLV</b> Sets the initial value of the cumulative drive operation time in 10-hour units.	0 h (0 - 9999 h)	871
o4-02 (050C)	Elapsed Operating Time Selection	<b>V/f</b> <b>OLV/PM</b> <b>EZOLV</b> Sets the condition that counts the cumulative operation time. 0 : U4-01 Shows Total Power-up Time 1 : U4-01 Shows Total RUN Time	1 (0, 1)	871
o4-03 (050E)	Fan Operation Time Setting	<b>V/f</b> <b>OLV/PM</b> <b>EZOLV</b> Sets the value from which to start the cumulative drive cooling fan operation time in 10-hour units.	0 h (0 - 9999 h)	871
o4-05 (051D)	Capacitor Maintenance Setting	<b>V/f</b> <b>OLV/PM</b> <b>EZOLV</b> Sets the U4-05 [ <i>CapacitorMaintenance</i> ] monitor value.	0% (0 - 150%)	871
o4-07 (0523)	Softcharge Relay Maintenance Set	<b>V/f</b> <b>OLV/PM</b> <b>EZOLV</b> Sets the U4-06 [ <i>PreChargeRelayMainte</i> ] monitor value.	0% (0 - 150%)	872
o4-09 (0525)	IGBT Maintenance Setting	<b>V/f</b> <b>OLV/PM</b> <b>EZOLV</b> Sets the U4-07 [ <i>IGBT Maintenance</i> ] monitor value.	0% (0 - 150%)	872
o4-11 (0510)	Fault Trace/History Init (U2/U3)	<b>V/f</b> <b>OLV/PM</b> <b>EZOLV</b> Resets the records of Monitors U2-xx [ <i>Fault Trace</i> ] and U3-xx [ <i>Fault History</i> ]. 0 : Disabled 1 : Enabled	0 (0, 1)	872
o4-12 (0512)	kWh Monitor Initialization	<b>V/f</b> <b>OLV/PM</b> <b>EZOLV</b> Resets the monitor values for U4-10 [ <i>kWh, Lower 4 Digits</i> ] and U4-11 [ <i>kWh, Upper 5 Digits</i> ]. 0 : No Reset 1 : Reset	0 (0, 1)	872
o4-13 (0528)	RUN Command Counter @ Initialize	<b>V/f</b> <b>OLV/PM</b> <b>EZOLV</b> Resets the monitor values for U4-02 [ <i>Num of Run Commands</i> ], U4-24 [ <i>Number of Runs (Low)</i> ], and U4-25 [ <i>Number of Runs (High)</i> ]. 0 : No Reset 1 : Reset	0 (0, 1)	873
o4-22 (154F) RUN	Time Format	<b>V/f</b> <b>OLV/PM</b> <b>EZOLV</b> Sets the time display format. This parameter is only available on an HOA keypad. 0 : 24 Hour Clock 1 : 12 Hour Clock 2 : 12 Hour JP Clock	1 (0 - 2)	873
o4-23 (1550) RUN	Date Format	<b>V/f</b> <b>OLV/PM</b> <b>EZOLV</b> Sets the date display format. This parameter is only available on an HOA keypad. 0 : YYYY/MM/DD 1 : DD/MM/YYYY 2 : MM/DD/YYYY	2 (0 - 2)	873
o4-24 (310F) RUN	bAT Detection Selection	<b>V/f</b> <b>OLV/PM</b> <b>EZOLV</b> Sets operation when the drive detects bAT [ <i>Keypad Battery Low Voltage</i> ] and TiM [ <i>Keypad Time Not Set</i> ]. 0 : Disable 1 : Enable (Alarm Detected) 2 : Enable (Fault Detected)	0 (0 - 2)	873

## ◆ o5: Log Function

No. (Hex.)	Name	Description	Default (Range)	Ref.
o5-01 (1551) RUN	Log Start/Stop Selection	<b>V/f</b> <b>OLV/PM</b> <b>EZOLV</b> Sets the data log function. This parameter is only available on an HOA keypad. 0 : OFF 1 : ON	0 (0 - 1)	876
o5-02 (1552) RUN	Log Sampling Interval	<b>V/f</b> <b>OLV/PM</b> <b>EZOLV</b> Sets the data log sampling cycle. This parameter is only available on an HOA keypad.	100 ms (100 - 60000 ms)	876

## 11.13 o: Keypad-Related Settings

No. (Hex.)	Name	Description	Default (Range)	Ref.
o5-03 (1553) RUN	Log Monitor Data 1	<b>V/f</b> <b>OLV/PM</b> <b>EZOLV</b> Sets the data log monitor. This parameter is only available on an HOA keypad.	101 (000, 101 - 1299)	877
o5-04 (1554) RUN	Log Monitor Data 2	<b>V/f</b> <b>OLV/PM</b> <b>EZOLV</b> Sets the data log monitor. This parameter is only available on an HOA keypad.	102 (000, 101 - 1299)	877
o5-05 (1555) RUN	Log Monitor Data 3	<b>V/f</b> <b>OLV/PM</b> <b>EZOLV</b> Sets the data log monitor. This parameter is only available on an HOA keypad.	103 (000, 101 - 1299)	877
o5-06 (1556) RUN	Log Monitor Data 4	<b>V/f</b> <b>OLV/PM</b> <b>EZOLV</b> Sets the data log monitor. This parameter is only available on an HOA keypad.	107 (000, 101 - 1299)	877
o5-07 (1557) RUN	Log Monitor Data 5	<b>V/f</b> <b>OLV/PM</b> <b>EZOLV</b> Sets the data log monitor. This parameter is only available on an HOA keypad.	108 (000, 101 - 1299)	877
o5-08 (1558) RUN	Log Monitor Data 6	<b>V/f</b> <b>OLV/PM</b> <b>EZOLV</b> Sets the data log monitor. This parameter is only available on an HOA keypad. <b>Note:</b> When $A1-02 = 0$ or $5$ [Control Method Selection = <i>V/f</i> , <i>OLV/PM</i> ], the default setting is $0$ .	105 (000, 101 - 1299)	878
o5-09 (1559) RUN	Log Monitor Data 7	<b>V/f</b> <b>OLV/PM</b> <b>EZOLV</b> Sets the data log monitor. This parameter is only available on an HOA keypad.	110 (000, 101 - 1299)	878
o5-10 (155A) RUN	Log Monitor Data 8	<b>V/f</b> <b>OLV/PM</b> <b>EZOLV</b> Sets the data log monitor. This parameter is only available on an HOA keypad.	112 (000, 101 - 1299)	878
o5-11 (155B) RUN	Log Monitor Data 9	<b>V/f</b> <b>OLV/PM</b> <b>EZOLV</b> Sets the data log monitor. This parameter is only available on an HOA keypad.	000 (000, 101 - 1299)	878
o5-12 (155C) RUN	Log Monitor Data 10	<b>V/f</b> <b>OLV/PM</b> <b>EZOLV</b> Sets the data log monitor. This parameter is only available on an HOA keypad.	000 (000, 101 - 1299)	878

## 11.14 q: DriveWorksEZ Parameters

### ◆ q1-01 to qx-xx: Reserved for DriveWorksEZ

No. (Hex.)	Name	Description	Default (Range)
q1-01 to qx-xx (1600 - xxxx)	Reserved for DriveWorksEZ	<span style="background-color: black; color: white; padding: 2px;">V/f</span> <span style="background-color: black; color: white; padding: 2px;">OLV/PM</span> <span style="background-color: black; color: white; padding: 2px;">EZOLV</span> These parameters are reserved for use with DriveWorksEZ.	Refer to "DriveWorksEZ Operation Manual".

## 11.15 r: DWEZ Connection 1-20

### ◆ r1-01 to r1-40: DriveWorksEZ Connection Parameters 1 to 20 (Upper / Lower)

No. (Hex.)	Name	Description	Default (Range)
r1-01 to r1-40: (1840 - 1867)	DriveWorksEZ Connection Parameters 1 to 20 (Upper / Lower)	<span style="background-color: black; color: white; padding: 2px;">V/f</span> <span style="background-color: black; color: white; padding: 2px;">OLV/IPM</span> <span style="background-color: black; color: white; padding: 2px;">EZOLV</span> DriveWorksEZ Connection Parameters 1 to 20 (Upper / Lower)	0 (0 - FFFFH)



## 11.16 S: Special Applications

### ◆ S1: Dynamic Noise Control

No. (Hex.)	Name	Description	Default (Range)	Ref.
S1-01 (3200)	Dynamic Noise Control	<b>V/f</b> <b>OLV/PM</b> <b>EZOLV</b> Sets the function that decreases the output voltage in variable torque applications to decrease audible noise. 0 : Disabled 1 : Enabled	1 (0, 1)	880
S1-02 (3201)	Voltage Reduction Rate	<b>V/f</b> <b>OLV/PM</b> <b>EZOLV</b> Sets the rate at which the drive will decrease the output voltage as a percentage of the V/f pattern when operating with no load.	50.0% (50.0 - 100.0%)	881
S1-03 (3202)	Voltage Restoration Level	<b>V/f</b> <b>OLV/PM</b> <b>EZOLV</b> Sets the level at which the drive will start to restore the voltage as a percentage of the drive rated torque.	20.0% (0.0 - 90.0%)	881
S1-04 (3203)	Voltage Restoration Off Level	<b>V/f</b> <b>OLV/PM</b> <b>EZOLV</b> Sets the level at which voltage restoration for the V/f pattern is complete as a percentage of the drive rated torque. If the output is more than S1-04, the drive will control the voltage as specified by the V/f pattern setting. <b>Note:</b> The lower limit of this parameter is the value of S1-03 [Voltage Restoration Level] + 10.0%.	50.0% (10.0 - 100.0%)	881
S1-05 (3204)	Volt Restore Sensitivity Time K	<b>V/f</b> <b>OLV/PM</b> <b>EZOLV</b> Sets the level of sensitivity of the output torque and L.P.F time constant for the voltage reduction rate. You can adjust the level of sensitivity with the load response.	1.000 s (0.000 - 3.000 s)	881
S1-06 (3205)	Volt Restore Impact Load Time K	<b>V/f</b> <b>OLV/PM</b> <b>EZOLV</b> Sets the voltage restoration time constant when you add an impact load.	0.050 s (0.000 - 1.000 s)	881
S1-07 (324C)	Output Phase Loss Level	<b>V/f</b> <b>OLV/PM</b> <b>EZOLV</b> Decreases the output phase loss level when Dynamic Noise control is active.	100.0% (10.0 - 100.0%)	881

### ◆ S2: Sequence Run Timers

No. (Hex.)	Name	Description	Default (Range)	Ref.
S2-01 (3206)	Timer 1 Start Time	<b>V/f</b> <b>OLV/PM</b> <b>EZOLV</b> Sets the start time for timer 1. <b>Note:</b> • Default is when o4-22 = 1 [Time Format = 12 Hour Clock]. When o4-22 = 0 [24 Hour Clock], default is 00:00. When o4-22 = 2 [12 Hour JP Clock], default is 00:00 AM. • Range is when o4-22 = 1. When o4-22 = 0, range is 00:00 to 24:00. When o4-22 = 2, range is 00:00 AM to 11:59 PM.	12:00 (12:00 AM - 11:59 PM)	885
S2-02 (3207)	Timer 1 Stop Time	<b>V/f</b> <b>OLV/PM</b> <b>EZOLV</b> Sets the stop time for timer 1. <b>Note:</b> • Default is when o4-22 = 1 [Time Format = 12 Hour Clock]. When o4-22 = 0 [24 Hour Clock], default is 00:00. When o4-22 = 2 [12 Hour JP Clock], default is 00:00 AM. • Range is when o4-22 = 1. When o4-22 = 0, range is 00:00 to 24:00. When o4-22 = 2, range is 00:00 AM to 11:59 PM.	12:00 (12:00 AM - 11:59 PM)	885
S2-03 (3208)	Timer 1 Day Selection	<b>V/f</b> <b>OLV/PM</b> <b>EZOLV</b> Sets the days for which sequence timer 1 is active. 0 : Timer Disabled 1 : Daily 2 : Mon - Fri 3 : Sat - Sun 4 : Monday 5 : Tuesday 6 : Wednesday 7 : Thursday 8 : Friday 9 : Saturday 10 : Sunday	0 (0 - 10)	885

## 11.16 S: Special Applications

No. (Hex.)	Name	Description	Default (Range)	Ref.
S2-04 (3209)	Timer 1 Sequence Selection	<p><b>V/f</b> <b>OLV/PM</b> <b>EZOLV</b></p> <p>Sets the drive response when sequence timer 1 is active.</p> <p>0 : Digital Out Only 1 : Run 2 : Run - PID Disable 3 : Allow Alternation</p>	0 (0 - 3)	886
S2-05 (320A)	Timer 1 Reference Source	<p><b>V/f</b> <b>OLV/PM</b> <b>EZOLV</b></p> <p>Selects the frequency reference source to run the drive when sequence timer 1 is active (only applicable when <math>S2-04 &gt; 0</math> [Timer 1 Sequence Selection ≠ Digital Out Only]).</p> <p>0 : Operator (d1-01/YA-01) 1 : Operator (d1-02/YA-02) 2 : Operator (d1-03/YA-03) 3 : Operator (d1-04/YA-04) 4 : Terminals 5 : Serial Com 6 : Option PCB 8 : Set by b1-01</p> <p><b>Note:</b> For reference source 0 to 3, the drive will use <i>d1-xx</i> frequency reference when PID mode is disabled and <i>YA-xx</i> setpoint when PID is enabled.</p>	0 (0 - 8)	886
S2-06 (320B)	Timer 2 Start Time	<p><b>V/f</b> <b>OLV/PM</b> <b>EZOLV</b></p> <p>Sets the start time for timer 2.</p> <p><b>Note:</b></p> <ul style="list-style-type: none"> <li>• Default is when <math>o4-22 = 1</math> [Time Format = 12 Hour Clock]. When <math>o4-22 = 0</math> [24 Hour Clock], default is 00:00. When <math>o4-22 = 2</math> [12 Hour JP Clock], default is 00:00 AM.</li> <li>• Range is when <math>o4-22 = 1</math>. When <math>o4-22 = 0</math>, range is 00:00 to 24:00. When <math>o4-22 = 2</math>, range is 00:00 AM to 11:59 PM.</li> </ul>	12:00 (12:00 AM - 11:59 PM)	886
S2-07 (320C)	Timer 2 Stop Time	<p><b>V/f</b> <b>OLV/PM</b> <b>EZOLV</b></p> <p>Sets the stop time for timer 2.</p> <p><b>Note:</b></p> <ul style="list-style-type: none"> <li>• Default is when <math>o4-22 = 1</math> [Time Format = 12 Hour Clock]. When <math>o4-22 = 0</math> [24 Hour Clock], default is 00:00. When <math>o4-22 = 2</math> [12 Hour JP Clock], default is 00:00 AM.</li> <li>• Range is when <math>o4-22 = 1</math>. When <math>o4-22 = 0</math>, range is 00:00 to 24:00. When <math>o4-22 = 2</math>, range is 00:00 AM to 11:59 PM.</li> </ul>	12:00 (12:00 AM - 11:59 PM)	886
S2-08 (320D)	Timer 2 Day Selection	<p><b>V/f</b> <b>OLV/PM</b> <b>EZOLV</b></p> <p>Sets the days for which sequence timer 2 is active.</p> <p>0 : Timer disabled 1 : Daily 2 : Mon - Fri 3 : Sat - Sun 4 : Monday 5 : Tuesday 6 : Wednesday 7 : Thursday 8 : Friday 9 : Saturday 10 : Sunday</p>	0 (0 - 10)	887
S2-09 (320E)	Timer 2 Sequence Selection	<p><b>V/f</b> <b>OLV/PM</b> <b>EZOLV</b></p> <p>Sets the drive response when sequence timer 2 is active.</p> <p>0 : Digital Out Only 1 : Run 2 : Run - PID Disable 3 : Allow Alternation</p>	0 (0 - 3)	887

No. (Hex.)	Name	Description	Default (Range)	Ref.
S2-10 (320F)	Timer 2 Reference Source	<p><b>V/f</b> <b>OLV/PM</b> <b>EZOLV</b></p> <p>Selects the frequency reference source to run the drive when sequence timer 2 is active (only applicable when <math>S2-09 &gt; 0</math> [Timer 2 Sequence Selection <math>\neq 0</math>]).</p> <p>0 : Operator (d1-01/YA-01)  1 : Operator (d1-02/YA-02)  2 : Operator (d1-03/YA-03)  3 : Operator (d1-04/YA-04)  4 : Terminals  5 : Serial Com  6 : Option PCB  8 : Set by b1-01</p> <p><b>Note:</b>  For reference source 0 to 3, the drive will use <math>d1-xx</math> frequency reference when PID mode is disabled and <math>YA-xx</math> setpoint when PID is enabled.</p>	0 (0 - 8)	887
S2-11 (3210)	Timer 3 Start Time	<p><b>V/f</b> <b>OLV/PM</b> <b>EZOLV</b></p> <p>Sets the start time for timer 3.</p> <p><b>Note:</b></p> <ul style="list-style-type: none"> <li>• Default is when <math>o4-22 = 1</math> [Time Format = 12 Hour Clock]. When <math>o4-22 = 0</math> [24 Hour Clock], default is 00:00. When <math>o4-22 = 2</math> [12 Hour JP Clock], default is 00:00 AM.</li> <li>• Range is when <math>o4-22 = 1</math>. When <math>o4-22 = 0</math>, range is 00:00 to 24:00. When <math>o4-22 = 2</math>, range is 00:00 AM to 11:59 PM.</li> </ul>	12:00 (12:00 AM - 11:59 PM)	888
S2-12 (3211)	Timer 3 Stop Time	<p><b>V/f</b> <b>OLV/PM</b> <b>EZOLV</b></p> <p>Sets the stop time for timer 3.</p> <p><b>Note:</b></p> <ul style="list-style-type: none"> <li>• Default is when <math>o4-22 = 1</math> [Time Format = 12 Hour Clock]. When <math>o4-22 = 0</math> [24 Hour Clock], default is 00:00. When <math>o4-22 = 2</math> [12 Hour JP Clock], default is 00:00 AM.</li> <li>• Range is when <math>o4-22 = 1</math>. When <math>o4-22 = 0</math>, range is 00:00 to 24:00. When <math>o4-22 = 2</math>, range is 00:00 AM to 11:59 PM.</li> </ul>	12:00 (12:00 AM - 11:59 PM)	888
S2-13 (3212)	Timer 3 Day Selection	<p><b>V/f</b> <b>OLV/PM</b> <b>EZOLV</b></p> <p>Sets the days for which sequence timer 3 is active.</p> <p>0 : Timer Disabled  1 : Daily  2 : Mon - Fri  3 : Sat - Sun  4 : Monday  5 : Tuesday  6 : Wednesday  7 : Thursday  8 : Friday  9 : Saturday  10 : Sunday</p>	0 (0 - 10)	888
S2-14 (3213)	Timer 3 Sequence Selection	<p><b>V/f</b> <b>OLV/PM</b> <b>EZOLV</b></p> <p>Sets the drive response when sequence timer 3 is active.</p> <p>0 : Digital Out Only  1 : Run  2 : Run - PID Disable  3 : Allow Alternation</p>	0 (0 - 3)	888
S2-15 (3214)	Timer 3 Reference Source	<p><b>V/f</b> <b>OLV/PM</b> <b>EZOLV</b></p> <p>Selects the frequency reference source to run the drive when sequence timer 3 is active (only applicable when <math>S2-14 &gt; 0</math> [Timer 3 Sequence Selection <math>\neq</math> Digital Out Only]).</p> <p>0 : Operator (d1-01/YA-01)  1 : Operator (d1-02/YA-02)  2 : Operator (d1-03/YA-03)  3 : Operator (d1-04/YA-04)  4 : Terminals  5 : Serial Com  6 : Option PCB  8 : Set by b1-01</p> <p><b>Note:</b>  For reference source 0 to 3, the drive will use <math>d1-xx</math> frequency reference when PID mode is disabled and <math>YA-xx</math> setpoint when PID is enabled.</p>	0 (0 - 8)	889

## 11.16 S: Special Applications

No. (Hex.)	Name	Description	Default (Range)	Ref.
S2-16 (3215)	Timer 4 Start Time	<p><b>V/f</b> <b>OLV/PM</b> <b>EZOLV</b></p> <p>Sets the start time for timer 4.</p> <p><b>Note:</b></p> <ul style="list-style-type: none"> <li>• Default is when <math>o4-22 = 1</math> [Time Format = 12 Hour Clock]. When <math>o4-22 = 0</math> [24 Hour Clock], default is 00:00. When <math>o4-22 = 2</math> [12 Hour JP Clock], default is 00:00 AM.</li> <li>• Range is when <math>o4-22 = 1</math>. When <math>o4-22 = 0</math>, range is 00:00 to 24:00. When <math>o4-22 = 2</math>, range is 00:00 AM to 11:59 PM.</li> </ul>	12:00 (12:00 AM - 11:59 PM)	889
S2-17 (3216)	Timer 4 Stop Time	<p><b>V/f</b> <b>OLV/PM</b> <b>EZOLV</b></p> <p>Sets the stop time for timer 4.</p> <p><b>Note:</b></p> <ul style="list-style-type: none"> <li>• Default is when <math>o4-22 = 1</math> [Time Format = 12 Hour Clock]. When <math>o4-22 = 0</math> [24 Hour Clock], default is 00:00. When <math>o4-22 = 2</math> [12 Hour JP Clock], default is 00:00 AM.</li> <li>• Range is when <math>o4-22 = 1</math>. When <math>o4-22 = 0</math>, range is 00:00 to 24:00. When <math>o4-22 = 2</math>, range is 00:00 AM to 11:59 PM.</li> </ul>	12:00 (12:00 AM - 11:59 PM)	889
S2-18 (3217)	Timer 4 Day Selection	<p><b>V/f</b> <b>OLV/PM</b> <b>EZOLV</b></p> <p>Sets the days for which sequence timer 4 is active.</p> <p>0 : Timer disabled            1 : Daily            2 : Mon - Fri            3 : Sat - Sun            4 : Monday            5 : Tuesday            6 : Wednesday            7 : Thursday            8 : Friday            9 : Saturday            10 : Sunday</p>	0 (0 - 10)	889
S2-19 (3218)	Timer 4 Sequence Selection	<p><b>V/f</b> <b>OLV/PM</b> <b>EZOLV</b></p> <p>Sets the drive response when sequence timer 4 is active.</p> <p>0 : Digital Out Only            1 : Run            2 : Run - PID Disable            3 : Allow Alternation</p>	0 (0 - 3)	890
S2-20 (3219)	Timer 4 Reference Source	<p><b>V/f</b> <b>OLV/PM</b> <b>EZOLV</b></p> <p>Selects the frequency reference source to run the drive when sequence timer 4 is active (only applicable when <math>S2-19 &gt; 0</math> [Timer 4 Sequence Selection <math>\neq</math> Digital Out Only]).</p> <p>0 : Operator (d1-01/YA-01)            1 : Operator (d1-02/YA-02)            2 : Operator (d1-03/YA-03)            3 : Operator (d1-04/YA-04)            4 : Terminals            5 : Serial Com            6 : Option PCB            8 : Set by b1-01</p> <p><b>Note:</b></p> <p>For reference source 0 to 3, the drive will use <math>d1-xx</math> frequency reference when PID mode is disabled and <math>YA-xx</math> setpoint when PID is enabled.</p>	0 (0 - 8)	890

### ◆ S3: PI2 Control

No. (Hex.)	Name	Description	Default (Range)	Ref.
S3-01 (321A)	PI2 Control Enable Selection	<p><b>V/f</b> <b>OLV/PM</b> <b>EZOLV</b></p> <p>Sets when the PI Auxiliary Control function is enabled:</p> <p>0 : Disabled 1 : Always 2 : Drive Running 3 : Motor Running</p>	0 (0 - 3)	891
S3-02 (321B) RUN	PI2 Control Transducer Scale	<p><b>V/f</b> <b>OLV/PM</b> <b>EZOLV</b></p> <p>Sets the full scale (10 V or 20 mA) output of the pressure transducer that is connected to the analog input terminals programmed for PI2 (Setpoint or Feedback).</p> <p><b>Note:</b> Parameters <i>S3-04 [PI2 Control Unit Selection]</i>, <i>S3-03 [PI2 Control Decimal Place Pos]</i>, and <i>S3-02 [PI2 Control Transducer Scale]</i> set the unit, resolution, and upper limit.</p>	100.00 (1.00 - 600.00)	891
S3-03 (321C) RUN	PI2 Control Decimal Place Pos	<p><b>V/f</b> <b>OLV/PM</b> <b>EZOLV</b></p> <p>Sets the decimal place display for secondary PI units.</p> <p>0 : No Decimal Places (XXXXX) 1 : One Decimal Places (XXXX.X) 2 : Two Decimal Places (XXX.XX) 3 : Three Decimal Places (XX.XXX)</p>	2 (0 - 3)	892
S3-04 (321D) RUN	PI2 Control Unit Selection	<p><b>V/f</b> <b>OLV/PM</b> <b>EZOLV</b></p> <p>Sets the units displayed for the PI2 Control parameters and monitor.</p> <p>0 : "WC: inches of water column 1 : PSI: pounds per square inch 2 : GPM: gallons/min 3 : °F: Fahrenheit 4 : ft³/min: cubic feet/min 5 : m³/h: cubic meters/hour 6 : L/h: liters/hour 7 : L/s: liters/sec 8 : bar: bar 9 : Pa: Pascal 10 : °C: Celsius 11 : m: meters 12 : ft: feet 13 : L/min: liters/min 14 : m³/min: cubic meters/min 15 : "Hg: Inch Mercury 16 : kPa: kilopascal 48 : %: Percent 49 : Custom(S3-18~20) 50 : None</p>	48 (0 - 50)	892
S3-05 (321E) RUN	PI2 Control Setpoint	<p><b>V/f</b> <b>OLV/PM</b> <b>EZOLV</b></p> <p>Sets the PI2 Control target setpoint.</p> <p><b>Note:</b> Parameters <i>S3-04 [PI2 Control Unit Selection]</i>, <i>S3-03 [PI2 Control Decimal Place Pos]</i>, and <i>S3-02 [PI2 Control Transducer Scale]</i> set the unit, resolution, and upper limit.</p>	0.00 (0.00 - 600.00)	892
S3-06 (321F) RUN	PI2 Control Proportional Gain	<p><b>V/f</b> <b>OLV/PM</b> <b>EZOLV</b></p> <p>Sets the proportional gain of the PI2 Control. Set this parameter to 0.00 to disable proportional control.</p>	1.00 (0.00 - 25.00)	893
S3-07 (3220) RUN	PI2 Control Integral Time	<p><b>V/f</b> <b>OLV/PM</b> <b>EZOLV</b></p> <p>Sets the integral time for the suction pressure control. Set this parameter to 0.00 to disable the integrator.</p>	1.0 s (0.0 - 360.0 s)	893
S3-08 (3221) RUN	PI2 Control Integral Max Limit	<p><b>V/f</b> <b>OLV/PM</b> <b>EZOLV</b></p> <p>Sets the maximum output possible from the integrator.</p>	100.0% (0.0 - 100.0%)	893
S3-09 (3222) RUN	PI2 Control Output Upper Limit	<p><b>V/f</b> <b>OLV/PM</b> <b>EZOLV</b></p> <p>Sets the maximum output possible from the PI Auxiliary Control function.</p>	100.0% (0.0 - 100.0%)	893

## 11.16 S: Special Applications

No. (Hex.)	Name	Description	Default (Range)	Ref.
S3-10 (3223) RUN	PI2 Control Output Lower Limit	<b>V/f</b> <b>OLV/PM</b> <b>EZOLV</b> Sets the minimum output possible from the PI Auxiliary Control function.	0.0% (-100.0 - +100.0%)	893
S3-11 (3224)	PI2 Control Output Level Sel	<b>V/f</b> <b>OLV/PM</b> <b>EZOLV</b> Sets the PI2 controller output direction. 0 : Direct Acting (Normal Output) 1 : Inverse Acting (Reverse Output)	0 (0, 1)	893
S3-12 (3225) RUN	PI2 Control Disable Mode Sel	<b>V/f</b> <b>OLV/PM</b> <b>EZOLV</b> Sets what U5-20 [PI2 Control Output] will output when disabled. 0 : No Output (0%) 1 : Lower Limit (S3-10) 2 : Setpoint	0 (0 - 2)	894
S3-13 (3226) RUN	PI2 Control Low Feedback Lvl	<b>V/f</b> <b>OLV/PM</b> <b>EZOLV</b> Sets the secondary PI low feedback detection level. <b>Note:</b> Parameters S3-04 [PI2 Control Unit Selection], S3-03 [PI2 Control Decimal Place Pos], and S3-02 [PI2 Control Transducer Scale] set the unit, resolution, and upper limit.	0.00 (0.00 - 600.00)	894
S3-14 (3227) RUN	PI2 Control Low Feedback Time	<b>V/f</b> <b>OLV/PM</b> <b>EZOLV</b> Sets the secondary PI low feedback detection delay time in seconds.	1.0 s (0.0 - 25.5 s)	894
S3-15 (3228) RUN	PI2 Control High Feedback Lvl	<b>V/f</b> <b>OLV/PM</b> <b>EZOLV</b> Sets the secondary PI high feedback detection level. <b>Note:</b> Parameters S3-04 [PI2 Control Unit Selection], S3-03 [PI2 Control Decimal Place Pos], and S3-02 [PI2 Control Transducer Scale] set the unit, resolution, and upper limit.	100.00 (0.00 - 600.00)	894
S3-16 (3229) RUN	PI2 Control High Feedback Time	<b>V/f</b> <b>OLV/PM</b> <b>EZOLV</b> Sets the secondary PI high feedback detection delay time in seconds.	1.0 s (0.0 - 25.5 s)	894
S3-17 (322A) RUN	PI2 Control Feedback Det Sel	<b>V/f</b> <b>OLV/PM</b> <b>EZOLV</b> Sets when the low and high feedback detection multifunction outputs (71h and 72h) for PI2 Control are active. 0 : While PI2 Control Enabled 1 : Always <b>Note:</b> Feedback level detection compares PI2 Control Feedback from analog input H3-xx = 26 [MFAI Function Selection = PI2 Control Feedback] to these parameters: • S3-13 [PI2 Control Low Feedback Lvl] for low feedback level detection • S3-15 [PI2 Control High Feedback Lvl] for high feedback level detection	0 (0, 1)	894
S3-18 (322B) RUN	PI2 Control Custom Unit 1	<b>V/f</b> <b>OLV/PM</b> <b>EZOLV</b> Sets the first character of the PI2 Control custom unit display when S3-04 = 49 [PI2 Control Unit Selection = Custom(S3-18-20)].	41 (20 - 7A)	895
S3-19 (322C) RUN	PI2 Control Custom Unit 2	<b>V/f</b> <b>OLV/PM</b> <b>EZOLV</b> Sets the second character of the PI2 Control custom unit display when S3-04 = 49 [PI2 Control Unit Selection = Custom(S3-18-20)].	41 (20 - 7A)	895
S3-20 (322D) RUN	PI2 Control Custom Unit 3	<b>V/f</b> <b>OLV/PM</b> <b>EZOLV</b> Sets the third character of the PI2 Control custom unit display when S3-04 = 49 [PI2 Control Unit Selection = Custom(S3-18-20)].	41 (20 - 7A)	895

## ◆ S5: Hand/Off/Auto Operation

No. (Hex.)	Name	Description	Default (Range)	Ref.
S5-01 (322F)	HAND Frequency Reference Source	<p><b>V/f</b> <b>OLV/PM</b> <b>EZOLV</b></p> <p>Sets the frequency reference source when HAND Mode is active.</p> <p>0 : HAND Analog Input 1 : HAND Ref S5-05 or PID SP S5-06 2 : Set by b1-01</p>	1 (0 - 2)	899
S5-02 (3230)	HAND/AUTO Switchover During Run	<p><b>V/f</b> <b>OLV/PM</b> <b>EZOLV</b></p> <p>Sets the function to enable or disable switching between HAND and AUTO Mode during run.</p> <p>0 : Disabled 1 : Enabled</p>	1 (0, 1)	899
S5-03 (3231) RUN	HAND Mode PID Selection	<p><b>V/f</b> <b>OLV/PM</b> <b>EZOLV</b></p> <p>Sets the function to enable or disable PI function when HAND mode is active.</p> <p>0 : Disabled 1 : Enabled</p> <p><b>Note:</b> If <i>b5-01 = 0 [PID Mode Setting = Disabled]</i>, the drive disables Hand Mode PID.</p>	0 (0, 1)	899
S5-04 (3232)	HAND-OFF-AUTO Behavior	<p><b>V/f</b> <b>OLV/PM</b> <b>EZOLV</b></p> <p>Sets the drive behavior when the drive is in HAND Mode, OFF Mode, or AUTO Mode.</p> <p>0 : Legacy 1 : Normal</p> <p><b>Note:</b> When you set this parameter to 1, the drive will always be in AUTO Mode when you energize the drive.</p>	1 (0, 1)	900
S5-05 (3233) RUN	HAND Frequency Reference	<p><b>V/f</b> <b>OLV/PM</b> <b>EZOLV</b></p> <p>Sets the frequency reference when HAND Mode is active, PID is disabled and <i>S5-01 = 1 [HAND Frequency Reference Source = HAND Ref S5-05 or PID SP S5-06]</i>.</p>	0.00 Hz (0.00 - 400.00 Hz)	900
S5-06 (3234) RUN	HAND Setpoint	<p><b>V/f</b> <b>OLV/PM</b> <b>EZOLV</b></p> <p>Sets the System Setpoint when HAND Mode is active, PID is enabled and <i>S5-01 = 1 [HAND Frequency Reference Source = HAND Ref S5-05 or PID SP S5-06]</i>.</p> <p><b>Note:</b> Parameters <i>b5-46 [PID Unit Display Selection]</i>, <i>b5-38 [PID User Unit Display Scaling]</i>, and <i>b5-39 [PID User Unit Display Digits]</i> set the unit, range, and resolution.</p>	0.0 (0.0 - 6000.0)	900
S5-07 (3235)	Operation HAND Key	<p><b>V/f</b> <b>OLV/PM</b> <b>EZOLV</b></p> <p>Sets the HAND key on the HOA keypad to let you switch between HAND Mode and AUTO Mode.</p> <p>0 : Disabled 1 : Enabled</p>	1 (0, 1)	900
S5-08 (3D31) RUN	HAND Reference Prime Loss Level	<p><b>V/f</b> <b>OLV/PM</b> <b>EZOLV</b></p> <p>Sets the level at which the drive will detect the Loss of Prime in the pump.</p> <p><b>Note:</b></p> <ul style="list-style-type: none"> <li>If these conditions occur at the same time, the drive will detect <i>LOP [Loss of Prime]</i>: <ul style="list-style-type: none"> <li>The monitor set by <i>Y1-18 [Prime Loss Detection Method] ≤ S5-08</i> for longer than <i>Y1-20 [Prime Loss Time]</i></li> <li>Output frequency <math>\geq S5-05</math> [<i>HAND Frequency Reference</i>]</li> </ul> </li> <li>The drive response to the Loss of Prime condition changes when the <i>Y1-22 [Prime Loss Selection]</i> setting changes.</li> <li>Parameter <i>Y1-18 [Prime Loss Detection Method]</i> sets the units for this parameter.</li> </ul>	0.0 (0.0 - 1000.0)	900
S5-10 (3280) RUN	AUTO Key Memory at Power Down	<p><b>V/f</b> <b>OLV/PM</b> <b>EZOLV</b></p> <p>Sets the function to keep the AUTO Mode status when you de-energize the drive.</p> <p>0 : Disabled 1 : Enabled w/ Memory 2 : AUTO Mode</p>	2 (0 - 2)	901

## ◆ S6: Protection

No. (Hex.)	Name	Description	Default (Range)	Ref.
S6-01 (3236)	Emergency Override Speed	<p><b>V/f</b> <b>OLV/PM</b> <b>EZOLV</b></p> <p>Sets the speed command for emergency override mode when <math>S6-02 = 0</math> [Emergency Override Ref Selection = Use S6-01 Reference].</p> <p><b>Note:</b></p> <ul style="list-style-type: none"> <li>When <math>A1-02 = 8</math> [Control Method Selection = EZOLV], <math>E1-09</math> [Minimum Output Frequency] (<math>E9-04</math> [Base Frequency]) sets the lower limit, and <math>E1-04</math> [Maximum Output Frequency] (<math>E9-02</math> [Maximum Speed]) sets the upper limit.</li> <li>Parameter default is lower-limited to <math>E1-09</math> (<math>E9-04</math> when <math>A1-02 = 8</math>). The default setting will automatically increase when <math>E1-09</math> (<math>E9-04</math>) &gt; <math>S6-01</math>.</li> </ul>	1.50 Hz (1.50 - 60.00 Hz)	905
S6-02 (3237)	Emergency Override Ref Selection	<p><b>V/f</b> <b>OLV/PM</b> <b>EZOLV</b></p> <p>Sets the Emergency Override Speed Source:</p> <p>0 : Use S6-01 Reference 1 : Use Frequency Reference 2 : System PID Mode 3 : Independent PID Mode</p>	0 (0 - 3)	905
S6-03 (323A)	EMOVR Independent PID Scale	<p><b>V/f</b> <b>OLV/PM</b> <b>EZOLV</b></p> <p>Sets the scaling on the Emergency PID Feedback and Setpoint (if programmed) Analog Inputs.</p> <p><b>Note:</b></p> <ul style="list-style-type: none"> <li><math>S6-05</math> [EMOVR Independent PID Unit Digit] sets the resolution for this parameter.</li> <li><math>S6-04</math> [EMOVR Independent PID Unit] sets the units for this parameter.</li> </ul>	100.00 (0.10 - 600.00)	905
S6-04 (323B)	EMOVR Independent PID Unit	<p><b>V/f</b> <b>OLV/PM</b> <b>EZOLV</b></p> <p>0 : "WC: inches of water column 1 : PSI: pounds per square inch 2 : GPM: gallons/min 3 : °F: Fahrenheit 4 : ft<sup>3</sup>/min: cubic feet/min 5 : m<sup>3</sup>/h: cubic meters/hour 6 : L/h: liters/hour 7 : L/s: liters/sec 8 : bar: bar 9 : Pa: Pascal 10 : °C: Celsius 11 : m: meters 12 : ft: feet 13 : L/min: liters/min 14 : m<sup>3</sup>/min: cubic meters/min 15 : "Hg: Inch Mercury 16 : kPa: kilopascal 48 : %: Percent 49 : Custom(b5-68~70) 50 : None</p>	48 (0 - 50)	905
S6-05 (323C)	EMOVR Independent PID Unit Digit	<p><b>V/f</b> <b>OLV/PM</b> <b>EZOLV</b></p> <p>Sets the number of digits for <math>S6-06</math> [EMOVR PID Setpoint] when <math>S6-02 = 3</math> [Emergency Override Ref Selection = Independent PID Mode].</p> <p>0 : No Decimal Places (XXXXXX) 1 : One Decimal Places (XXXX.X) 2 : Two Decimal Places (XXX.XX) 3 : Three Decimal Places (XX.XXX)</p>	2 (0 - 3)	906
S6-06 (323D) RUN	EMOVR PID Setpoint	<p><b>V/f</b> <b>OLV/PM</b> <b>EZOLV</b></p> <p>Sets the PID Setpoint when <math>S6-02 = 3</math> [Emergency Override Ref Selection = Independent PID Mode].</p> <p><b>Note:</b></p> <p>When <math>S6-02 = 3</math>: units and resolution are dependent on <math>S6-04</math> [EMOVR Independent PID Unit] and <math>S6-05</math> [EMOVR Independent PID Unit Digit]. Value is internally limited to 300% of <math>S6-03</math> [EMOVR Independent PID Scale].</p>	0.00 (0 - 600.00)	906
S6-07 (323E)	EMOVR Fault Suppression Mode	<p><b>V/f</b> <b>OLV/PM</b> <b>EZOLV</b></p> <p>Sets the drive to let Emergency Override disable faults during operation.</p> <p>0 : Fault Suppression 1 : Test Mode</p>	0 (0, 1)	906



No. (Hex.)	Name	Description	Default (Range)	Ref.
S6-08 (323F)	EMOVR Drive Enable Input Mode	<p><b>V/f</b> <b>OLV/PM</b> <b>EZOLV</b></p> <p>Sets whether the Drive Enable Input (if programmed) must be inactive (drive is disabled) for Emergency Override to function.</p> <p>0 : Drive Enable Status Ignored 1 : EMOVRun Only When Drive Disabled</p> <p><b>Note:</b> You must program Drive Enable to a Digital Input for this parameter to have an effect.</p>	0 (0, 1)	906
S6-09 (3240)	Emergency Override Min Speed	<p><b>V/f</b> <b>OLV/PM</b> <b>EZOLV</b></p> <p>When Emergency Override is active, the output frequency is lower-limited to this value.</p> <p><b>Note:</b> When <math>A1-02 = 8</math> [Control Method Selection = EZOLV], the range is 0.00 to 120.00 Hz.</p>	0.00 Hz (0.00 - 400.00 Hz)	907
S6-10 (3241)	Emergency Override Max Speed	<p><b>V/f</b> <b>OLV/PM</b> <b>EZOLV</b></p> <p>When Emergency Override is active, the output frequency is upper-limited to this value.</p> <p><b>Note:</b></p> <ul style="list-style-type: none"> <li>When <math>A1-02 = 8</math> [Control Method Selection = EZOLV], the range is 0.00 to 120.00 Hz.</li> <li>Set this parameter to 0.00 Hz to disable the limit.</li> </ul>	0.00 Hz (0.00 - 400.00)	907
S6-11 (3242) Expert	EMOVR Drive Protection Fault ON	<p><b>V/f</b> <b>OLV/PM</b> <b>EZOLV</b></p> <p>Sets the bit to enable fault detection during Emergency Override.</p> <p>bit 0 : Uv1 - DC Bus Undervoltage bit 1 : CoF - Current Offset Fault bit 2 : dWF1 - EEPROM Memory DWEZ Data Error bit 3 : Err - EEPROM Write Error bit 4 : Reserved bit 5 : Reserved bit 6 : oL2 - Drive Overload bit 7 : oPr - Operator Connection bit 8 : PF - Input Phase Loss bit 9 : Reserved bit 10 : Reserved bit 11 : oH - Heatsink Overheat bit 12 : oH1 - Heatsink Overheat bit 13 : OD - Output Disconnect bit 14 : FAn1 - Cooling Fan Fault bit 15 : ov2 - DC Bus Overvoltage 2</p> <p><b>Note:</b> The drive sets the bits in Hex.</p>	0 (0 - FFFF)	907
S6-12 (3243) Expert	EMOVR Motor Protection Fault ON	<p><b>V/f</b> <b>OLV/PM</b> <b>EZOLV</b></p> <p>Sets the bit to enable fault detection during Emergency Override.</p> <p>bit 0 : LF - Output Phase Loss bit 1 : LF2 - Output Current Imbalance bit 2 : oH3 - Motor Overheat PTC Input bit 3 : oH4 - Motor Overheat PTC Input bit 4 : Reserved bit 5 : oL1 - Motor Overload bit 6 : oL3 - Overtorque Detection 1 bit 7 : oL4 - Overtorque Detection 2 bit 8 : oL7 - High Slip Braking Overload bit 9 : Reserved bit 10 : UL3 - Undertorque Detection 1 bit 11 : UL4 - Undertorque Detection 2 bit 12 : UL6 - Motor Underload bit 13 : Reserved bit 14 : oS - Overspeed bit 15 : dEv: Speed Deviation</p> <p><b>Note:</b> The drive sets the bits in Hex.</p>	0 (0 - FFFF)	907

## 11.16 S: Special Applications

No. (Hex.)	Name	Description	Default (Range)	Ref.
S6-13 (3244) Expert	EMOVR Option Fault ON	<p><b>V/f</b> <b>OLV/PM</b> <b>EZOLV</b></p> <p>Sets the bit to enable fault detection during Emergency Override.</p> <p>bit 0 : bUS - Option Communication bit 1 : CE - Communication Error bit 2 : Reserved bit 3 : EF0 - Option Card External Fault bit 4 : PE1 - PLC Fault 1 bit 5 : PE2 - PLC Fault 2 bit 6 : nSE - Node Setup Error bit 7 to 15 : Reserved</p> <p><b>Note:</b> The drive sets the bits in Hex.</p>	0 (0 - FFFF)	908
S6-14 (3245) Expert	EMOVR Application 1 Fault ON	<p><b>V/f</b> <b>OLV/PM</b> <b>EZOLV</b></p> <p>Sets the bit to enable fault detection during Emergency Override.</p> <p>bit 0 : EFX - External Faults bit 1 : Reserved bit 2 : HLCE - High Level Communications Error bit 3 : bAT - Keypad Battery Low Voltage bit 4 : TiM - Keypad Time Not Set bit 5 : bCE - Bluetooth Communication Fault bit 6 : dWF2 - DriveWorksEZ Fault 2 bit 7 : dWF3 - DriveWorksEZ Fault 3 bit 8 : dWFL - DriveWorksEZ Fault bit 9 : MSL - Net Master Lost bit 10 : VLTS - Thermostat Fault bit 11 to 15 : Reserved</p> <p><b>Note:</b> The drive sets the bits in Hex.</p>	0 (0 - FFFF)	908
S6-16 (3247)	EMOVR Customer Safety Mode	<p><b>V/f</b> <b>OLV/PM</b> <b>EZOLV</b></p> <p>Sets the status for the customer safety input (when programmed) that must occur for Emergency Override to function.</p> <p>0 : Customer Safety Ignored 1 : EMOVRun Only When Safety OK 2 : EMOVRun Only When Safety NOT OK</p> <p><b>Note:</b> You must set a customer safety to a Digital Input for this parameter to have an effect.</p>	0 (0 - 2)	909
S6-17 (3248)	EMOVR BAS Interlock Mode	<p><b>V/f</b> <b>OLV/PM</b> <b>EZOLV</b></p> <p>Sets the status for the BAS Interlock input (when programmed) that must occur for Emergency Override to function.</p> <p>0 : BAS Interlock Ignored 1 : EMOVRun Only When Interlock OK 2 : EMOVRun When Interlock NOT OK</p> <p><b>Note:</b> Parameter has no effect if BAS Interlock is not programmed to a Digital Input.</p>	0 (0 - 2)	909
S6-23 (324E)	OV2 Detect Time	<p><b>V/f</b> <b>OLV/PM</b> <b>EZOLV</b></p> <p>Sets the detection time of <i>ov2</i> [DC Bus Overvoltage 2] in 0.1 s increments.</p> <p><b>Note:</b> Set this parameter to 0.0 s to disable <i>ov2</i> detection.</p>	10.0 s (0.0 - 1200.0 s)	909

## 11.17 T: Motor Tuning

### ◆ T0: Tuning Mode Selection

No. (Hex.)	Name	Description	Default (Range)	Ref.
T0-00 (1197)	Tuning Mode Selection	<div style="display: flex; justify-content: space-between; align-items: center;"> <span style="background-color: #ccc; padding: 2px;">V/f</span> <span style="background-color: #ccc; padding: 2px;">OLV/PM</span> <span style="background-color: #ccc; padding: 2px;">EZOLV</span> </div> Sets the type of Auto-Tuning. 0 : Motor Parameter Tuning	0 (0)	910

### ◆ T1: Induction Motor Auto-Tuning

No. (Hex.)	Name	Description	Default (Range)	Ref.
T1-00 (0700)	Motor 1/Motor 2 Selection	<div style="display: flex; justify-content: space-between; align-items: center;"> <span style="background-color: #ccc; padding: 2px;">V/f</span> <span style="background-color: #ccc; padding: 2px;">OLV/PM</span> <span style="background-color: #ccc; padding: 2px;">EZOLV</span> </div> Sets which motor to tune when motor 1/2 switching is enabled. You can only use the keypad to set this parameter. You cannot use external input terminals to set it. <b>Note:</b> This parameter is enabled when $H1-xx = 16$ [Motor 2 Selection] is set. When $H1-xx \neq 16$ the keypad will not show this parameter. 1 : Motor 1 (sets E1-xx, E2-xx) 2 : Motor 2 (sets E3-xx, E4-xx)	1 (1, 2)	910
T1-01 (0701)	Auto-Tuning Mode Selection	<div style="display: flex; justify-content: space-between; align-items: center;"> <span style="background-color: #ccc; padding: 2px;">V/f</span> <span style="background-color: #ccc; padding: 2px;">OLV/PM</span> <span style="background-color: #ccc; padding: 2px;">EZOLV</span> </div> Sets the type of Auto-Tuning. 0 : Rotational Auto-Tuning 2 : Stationary Line-Line Resistance	0 (0, 2)	910
T1-02 (0702)	Motor Rated Power	<div style="display: flex; justify-content: space-between; align-items: center;"> <span style="background-color: #ccc; padding: 2px;">V/f</span> <span style="background-color: #ccc; padding: 2px;">OLV/PM</span> <span style="background-color: #ccc; padding: 2px;">EZOLV</span> </div> Uses the units set in $o1-58$ [Motor Power Unit Selection] to set the motor rated output power.	Determined by $o2-04$ (0.00 - 650.00 HP)	911
T1-03 (0703)	Motor Rated Voltage	<div style="display: flex; justify-content: space-between; align-items: center;"> <span style="background-color: #ccc; padding: 2px;">V/f</span> <span style="background-color: #ccc; padding: 2px;">OLV/PM</span> <span style="background-color: #ccc; padding: 2px;">EZOLV</span> </div> Sets the rated voltage (V) of the motor. Enter the base speed voltage for constant output motors.	Determined by $o2-04$ (208 V Class: 0.0 - 255.5 V, 480 V Class: 0.0 - 511.0 V)	911
T1-04 (0704)	Motor Rated Current	<div style="display: flex; justify-content: space-between; align-items: center;"> <span style="background-color: #ccc; padding: 2px;">V/f</span> <span style="background-color: #ccc; padding: 2px;">OLV/PM</span> <span style="background-color: #ccc; padding: 2px;">EZOLV</span> </div> Sets the rated current (A) of the motor.	Determined by $o2-04$ (10% to 200% of the drive rated current)	911
T1-05 (0705)	Motor Base Frequency	<div style="display: flex; justify-content: space-between; align-items: center;"> <span style="background-color: #ccc; padding: 2px;">V/f</span> <span style="background-color: #ccc; padding: 2px;">OLV/PM</span> <span style="background-color: #ccc; padding: 2px;">EZOLV</span> </div> Sets the base frequency (Hz) of the motor.	60.0 Hz (0.0 - 400.0 Hz)	911
T1-06 (0706)	Number of Motor Poles	<div style="display: flex; justify-content: space-between; align-items: center;"> <span style="background-color: #ccc; padding: 2px;">V/f</span> <span style="background-color: #ccc; padding: 2px;">OLV/PM</span> <span style="background-color: #ccc; padding: 2px;">EZOLV</span> </div> Sets the number of motor poles.	4 (2 to 120)	911
T1-07 (0707)	Motor Base Speed	<div style="display: flex; justify-content: space-between; align-items: center;"> <span style="background-color: #ccc; padding: 2px;">V/f</span> <span style="background-color: #ccc; padding: 2px;">OLV/PM</span> <span style="background-color: #ccc; padding: 2px;">EZOLV</span> </div> Sets the motor base speed for Auto-Tuning ( $\text{min}^{-1}$ (r/min)).	1750 $\text{min}^{-1}$ (r/min) (0 - 24000 $\text{min}^{-1}$ (r/min))	911
T1-11 (070B)	Motor Iron Loss	<div style="display: flex; justify-content: space-between; align-items: center;"> <span style="background-color: #ccc; padding: 2px;">V/f</span> <span style="background-color: #ccc; padding: 2px;">OLV/PM</span> <span style="background-color: #ccc; padding: 2px;">EZOLV</span> </div> Sets the iron loss to calculate the energy-saving coefficient.	Determined by E2-10 or E4-10 (0 - 6535 W)	912

### ◆ T2: PM Motor Auto-Tuning

No. (Hex.)	Name	Description	Default (Range)	Ref.
T2-01 (0750)	PM Auto-Tuning Selection	<div style="display: flex; justify-content: space-between; align-items: center;"> <span style="background-color: #ccc; padding: 2px;">V/f</span> <span style="background-color: #ccc; padding: 2px;">OLV/PM</span> <span style="background-color: #ccc; padding: 2px;">EZOLV</span> </div> Sets the type of Auto-Tuning for PM motors. 0 : Manual Entry w/ Motor Data Sheet 1 : Stationary (Ld, Lq, R) 2 : Stationary (R Only) 4 : Rotational (Ld, Lq, R, back-EMF) 5 : High Frequency Injection	0 (0 - 5)	912
T2-02 (0751)	PM Motor Code Selection	<div style="display: flex; justify-content: space-between; align-items: center;"> <span style="background-color: #ccc; padding: 2px;">V/f</span> <span style="background-color: #ccc; padding: 2px;">OLV/PM</span> <span style="background-color: #ccc; padding: 2px;">EZOLV</span> </div> Enter the PM motor code as specified by the rotation speed and motor output.	FFFF (0000 - FFFF)	912

## 11.17 T: Motor Tuning

No. (Hex.)	Name	Description	Default (Range)	Ref.
T2-03 (0752)	PM Motor Type	<input type="checkbox"/> V/f <input checked="" type="checkbox"/> OLV/PM <input type="checkbox"/> EZOLV Sets the type of PM motor the drive will operate. 0 : IPM motor 1 : SPM motor	1 (0, 1)	912
T2-04 (0730)	PM Motor Rated Power	<input type="checkbox"/> V/f <input checked="" type="checkbox"/> OLV/PM <input type="checkbox"/> EZOLV Uses the units set in o1-58 [Motor Power Unit Selection] to set the PM motor rated output power.	Determined by o2-04 (0.00 - 650.00 HP)	913
T2-05 (0732)	PM Motor Rated Voltage	<input type="checkbox"/> V/f <input checked="" type="checkbox"/> OLV/PM <input type="checkbox"/> EZOLV Sets the rated voltage (V) of the motor.	208 V Class: 230.0 V, 480 V Class: 460.0 V (208 V Class: 0.0 - 255.0 V, 480 V Class: 0.0 - 510.0 V)	913
T2-06 (0733)	PM Motor Rated Current	<input type="checkbox"/> V/f <input checked="" type="checkbox"/> OLV/PM <input type="checkbox"/> EZOLV Sets the rated current (A) of the motor.	Determined by o2-04 (10% to 200% of the drive rated current)	913
T2-07 (0753)	PM Motor Base Frequency	<input type="checkbox"/> V/f <input checked="" type="checkbox"/> OLV/PM <input type="checkbox"/> EZOLV Sets the base frequency (Hz) of the motor.	60.0 Hz (0.0 - 400.0 Hz)	913
T2-08 (0734)	Number of PM Motor Poles	<input type="checkbox"/> V/f <input checked="" type="checkbox"/> OLV/PM <input type="checkbox"/> EZOLV Sets the number of motor poles.	4 (2 - 120)	913
T2-10 (0754)	PM Motor Stator Resistance	<input type="checkbox"/> V/f <input checked="" type="checkbox"/> OLV/PM <input type="checkbox"/> EZOLV Sets the stator resistance for each motor phase. <b>Note:</b> This parameter does not set line-to-line resistance.	Determined by T2-02 (0.000 - 65.000 Ω)	913
T2-11 (0735)	PM Motor d-Axis Inductance	<input type="checkbox"/> V/f <input checked="" type="checkbox"/> OLV/PM <input type="checkbox"/> EZOLV Sets the d-axis inductance of the motor on a per phase basis.	Determined by T2-02 (0.00 - 600.00 mH)	913
T2-12 (0736)	PM Motor q-Axis Inductance	<input type="checkbox"/> V/f <input checked="" type="checkbox"/> OLV/PM <input type="checkbox"/> EZOLV Sets the q-axis inductance of the motor on a per phase basis.	Determined by T2-02 (0.00 - 600.00 mH)	914
T2-13 (0755)	Back-EMF Units Selection	<input type="checkbox"/> V/f <input checked="" type="checkbox"/> OLV/PM <input type="checkbox"/> EZOLV Sets the units that the drive uses to set the induced voltage constant. 0 : mV/(rev/min) 1 : mV/(rad/sec)	0 (0, 1)	914
T2-14 (0737)	Back-EMF Voltage Constant (Ke)	<input type="checkbox"/> V/f <input checked="" type="checkbox"/> OLV/PM <input type="checkbox"/> EZOLV Sets the motor induced voltage constant (Ke).	Determined by T2-13 (0.0 - 2000.0)	914
T2-15 (0756)	Pull-In Current Level	<input type="checkbox"/> V/f <input checked="" type="checkbox"/> OLV/PM <input type="checkbox"/> EZOLV Sets the level of the pull-in current as a percentage of E5-03 [PM Motor Rated Current (FLA)]. Usually it is not necessary to change this setting.	30% (0 - 120%)	914

## ◆ T4: EZ Tuning

No. (Hex.)	Name	Description	Default (Range)	Ref.
T4-01 (3130)	EZ Tuning Mode Selection	<input type="checkbox"/> V/f <input type="checkbox"/> OLV/PM <input checked="" type="checkbox"/> EZOLV Sets the type of Auto-Tuning for EZOLV control. 0 : Motor Parameter Setting 1 : Line-to-Line Resistance	0 (0, 1)	915
T4-02 (3131)	Motor Type Selection	<input type="checkbox"/> V/f <input type="checkbox"/> OLV/PM <input checked="" type="checkbox"/> EZOLV Sets the type of motor. 0 : Induction (IM) 1 : Permanent Magnet (PM) 2 : Synchronous Reluctance (SynRM)	0 (0, 1, 2)	915
T4-03 (3132)	Motor Max Revolutions	<input type="checkbox"/> V/f <input type="checkbox"/> OLV/PM <input checked="" type="checkbox"/> EZOLV Sets the maximum motor revolutions (min <sup>-1</sup> ).	- ((40 to 120 Hz) × 60 × 2 / E9-08)	915
T4-04 (3133)	Motor Rated Revolutions	<input type="checkbox"/> V/f <input type="checkbox"/> OLV/PM <input checked="" type="checkbox"/> EZOLV Sets rated rotation speed (min <sup>-1</sup> ) of the motor.	- ((40 Hz to 120 Hz) × 60 × 2/E9-08)	915
T4-05 (3134)	Motor Rated Frequency	<input type="checkbox"/> V/f <input type="checkbox"/> OLV/PM <input checked="" type="checkbox"/> EZOLV Sets the rated frequency (Hz) of the motor.	Determined by E9-01 and o2-04 (40.0 - 120.0 Hz)	915

No. (Hex.)	Name	Description	Default (Range)	Ref.
T4-06 (3135)	Motor Rated Voltage	<input type="checkbox"/> V/f <input type="checkbox"/> OL/PM <input checked="" type="checkbox"/> EZOLV Sets the rated voltage (V) of the motor.	208 V Class: 230.0 V, 480 V Class: 460.0 V (208 V Class: 0.0 - 255.0 V, 480 V Class: 0.0 - 510.0 V)	915
T4-07 (3136)	Motor Rated Current	<input type="checkbox"/> V/f <input type="checkbox"/> OL/PM <input checked="" type="checkbox"/> EZOLV Sets the rated current (A) of the motor.	Determined by o2-04 (10% to 200% of the drive rated current)	916
T4-08 (3137)	Motor Rated Capacity	<input type="checkbox"/> V/f <input type="checkbox"/> OL/PM <input checked="" type="checkbox"/> EZOLV Sets the motor rated power in the units set in o1-58 [Motor Power Unit Selection].	Determined by E9-10 (0.10 - 650.00 HP)	916
T4-09 (3138)	Number of Poles	<input type="checkbox"/> V/f <input type="checkbox"/> OL/PM <input checked="" type="checkbox"/> EZOLV Sets the number of motor poles.	Determined by E9-01 (2 - 120)	916

## 11.18 U: Monitors

### ◆ U1: Operation Status Monitors

No. (Hex.)	Name	Description	MFAO Signal Level
U1-01 (0040)	Frequency Reference	<p><b>V/f</b> <b>OLV/IPM</b> <b>EZOLV</b></p> <p>Shows the frequency reference value. Parameter <i>o1-03</i> [Keypad Display Unit Selection] sets the display units. Unit: 0.01 Hz</p>	10 V = Maximum frequency
U1-02 (0041)	Output frequency	<p><b>V/f</b> <b>OLV/IPM</b> <b>EZOLV</b></p> <p>Shows the output frequency. Parameter <i>o1-03</i> [Keypad Display Unit Selection] sets the display units. Unit: 0.01 Hz</p>	10 V = Maximum frequency
U1-03 (0042)	Output Current	<p><b>V/f</b> <b>OLV/IPM</b> <b>EZOLV</b></p> <p>Shows the output current. The keypad shows the value of <i>U1-03</i> in amperes (A). When you use serial communications to show the monitor, the current is "8192 = drive rated current (A)". Use the formula: "Numerals being displayed / 8192 × drive rated current (A)" to use the serial communication current value shown in the monitor. Unit: Determined by the drive model. • 0.01 A: 2011 to 2046, 4005 to 4014 • 0.1 A: 2059 to 2273, 4021 to 4302</p>	10 V = Drive rated current
U1-04 (0043)	Control Method	<p><b>V/f</b> <b>OLV/IPM</b> <b>EZOLV</b></p> <p>Shows the drive control method. 0 : V/f Control 5 : PM Open Loop Vector 8 : EZ Vector Control</p>	No signal output available
U1-05 (0044)	Motor Speed	<p><b>V/f</b> <b>OLV/IPM</b> <b>EZOLV</b></p> <p>Shows the detected motor speed. Parameter <i>o1-03</i> [Keypad Display Unit Selection] sets the display units. Unit: 0.01 Hz</p>	10 V = Maximum frequency
U1-06 (0045)	Output Voltage Ref	<p><b>V/f</b> <b>OLV/IPM</b> <b>EZOLV</b></p> <p>Shows the output voltage reference. Unit: 0.1 V</p>	208 V class: 10 V = 200 V <sub>rms</sub> 480 V class: 10 V = 400 V <sub>rms</sub>
U1-07 (0046)	DC Bus Voltage	<p><b>V/f</b> <b>OLV/IPM</b> <b>EZOLV</b></p> <p>Shows the DC bus voltage. Unit: 1 V</p>	208 V class: 10 V = 400 V 480 V class: 10 V = 800 V
U1-08 (0047)	Output Power	<p><b>V/f</b> <b>OLV/IPM</b> <b>EZOLV</b></p> <p>Shows the internally-calculated output power. When you change <i>A1-02</i> [Control Method Selection], it will also change the signal level of the analog output. • <i>A1-02</i> = 0: Drive capacity (kW) • <i>A1-02</i> = 5: PM Motor Rated Power [<i>E5-02</i>] (kW) • <i>A1-02</i> = 8: Motor Rated Power [<i>E9-07</i>] (kW) Unit: Determined by the drive model. • 0.01 kW: 2011 to 2046, 4005 to 4014 • 0.1 kW: 2059 to 2273, 4021 to 4302</p>	10 V: Drive capacity (motor rated power) kW
U1-09 (0048)	Torque Reference	<p><b>V/f</b> <b>OLV/IPM</b> <b>EZOLV</b></p> <p>Shows the internal torque reference value. Unit: 0.1%</p>	10 V = Motor rated torque
U1-10 (0049)	Input Terminal Status	<p><b>V/f</b> <b>OLV/IPM</b> <b>EZOLV</b></p> <p>Shows the status of the MFDI terminal where 1 = (ON) and 0 = (OFF). For example, <i>U1-10</i> shows "00000011" when terminals S1 and S2 are ON. bit0 : Terminal S1 (MFDI 1) bit1 : Terminal S2 (MFDI 2) bit2 : Terminal S3 (MFDI 3) bit3 : Terminal S4 (MFDI 4) bit4 : Terminal S5 (MFDI 5) bit5 : Terminal S6 (MFDI 6) bit6 : Terminal S7 (MFDI 7) bit7 : Not used (normal value of 0).</p>	No signal output available

No. (Hex.)	Name	Description	MFAO Signal Level
U1-11 (004A)	Output Terminal Status	<p><b>V/f</b> <b>OLV/PM</b> <b>EZOLV</b></p> <p>Shows the status of the MFDO terminal where 1 = (ON) and 0 = (OFF). For example, <i>U1-11</i> shows "00000011" when terminals M1 and M3 are ON.</p> <p><b>Note:</b> When <i>H2-xx = 100 to 1C4</i> [<i>Inverse Output of Function</i>], the monitor will show the value before inversion.</p> <p>bit 0 : Terminals M1-M2 bit 1 : Terminals M3-M4 bit 2 : Terminals M5-M6 bit 3 : Not used (normal value of 0). bit 4 : Not used (normal value of 0). bit 5 : Not used (normal value of 0). bit 6 : Not used (normal value of 0). bit 7 : Fault relay MA/MB-MC</p>	No signal output available
U1-12 (004B)	Drive Status	<p><b>V/f</b> <b>OLV/PM</b> <b>EZOLV</b></p> <p>Shows drive status where 1 = ON and 0 = OFF. For example, <i>U1-12</i> shows "00000101" during run with the Reverse Run command.</p> <p>bit0 : During Run bit1 : During zero-speed bit2 : During reverse bit3 : During fault reset signal input bit4 : During speed agreement bit5 : Drive ready bit6 : During minor fault detection bit7 : During fault detection</p>	No signal output available
U1-13 (004E)	Terminal A1 Level	<p><b>V/f</b> <b>OLV/PM</b> <b>EZOLV</b></p> <p>Shows the signal level of terminal A1. Unit: 0.1%</p>	10 V = 100%
U1-14 (004F)	Terminal A2 Level	<p><b>V/f</b> <b>OLV/PM</b> <b>EZOLV</b></p> <p>Shows the signal level of terminal A2. Unit: 0.1%</p>	10 V = 100%
U1-16 (0053)	SFS Output Frequency	<p><b>V/f</b> <b>OLV/PM</b> <b>EZOLV</b></p> <p>Shows the output frequency after soft start. Shows the frequency with acceleration and deceleration times and S-curves. Parameter <i>o1-03</i> [<i>Keypad Display Unit Selection</i>] sets the display units. Unit: 0.01 Hz</p>	10 V = Maximum frequency
U1-18 (0061)	oPE Fault Parameter	<p><b>V/f</b> <b>OLV/PM</b> <b>EZOLV</b></p> <p>Shows the parameter number that caused the <i>oPE02</i> [<i>Parameter Range Setting Error</i>] or <i>oPE08</i> [<i>Parameter Selection Error</i>].</p>	No signal output available
U1-19 (0066)	MEMOBUS/Modbus Error Code	<p><b>V/f</b> <b>OLV/PM</b> <b>EZOLV</b></p> <p>Shows the contents of the MEMOBUS/Modbus communication error where 1 = "error" and 0 = "no error". For example, <i>U1-19</i> shows "00000001" when there is a CRC error.</p> <p>bit0 : CRC Error bit1 : Data Length Error bit2 : Not used (normal value of 0). bit3 : Parity Error bit4 : Overrun Error bit5 : Framing Error bit6 : Timed Out bit7 : Not used (normal value of 0).</p>	No signal output available
U1-25 (004D)	SoftwareNumber Flash	<p><b>V/f</b> <b>OLV/PM</b> <b>EZOLV</b></p> <p>Shows the FLASH ID.</p>	No signal output available
U1-26 (005B)	SoftwareNumber ROM	<p><b>V/f</b> <b>OLV/PM</b> <b>EZOLV</b></p> <p>Shows the ROM ID.</p>	No signal output available
U1-50 (1199) Expert	Virtual Analog Input	<p><b>V/f</b> <b>OLV/PM</b> <b>EZOLV</b></p> <p>Shows the virtual analog input value.</p>	Determined by H7-40
U1-60 (1089)	System Setpoint	<p><b>V/f</b> <b>OLV/PM</b> <b>EZOLV</b></p> <p>Shows the PID Setpoint. Unit: 0.01%</p> <p><b>Note:</b> Parameters <i>b5-46</i> [<i>PID Unit Display Selection</i>], <i>b5-38</i> [<i>PID User Unit Display Scaling</i>], and <i>b5-39</i> [<i>PID User Unit Display Digits</i>] set the unit, scaling, and resolution.</p>	No signal output available

No. (Hex.)	Name	Description	MFAO Signal Level
U1-61 (108A)	System Feedback	<p><b>V/f</b> <b>OLV/IPM</b> <b>EZOLV</b></p> <p>Shows the PID Feedback. Unit: 0.01% <b>Note:</b> Parameters <i>b5-46 [PID Unit Display Selection]</i>, <i>b5-38 [PID User Unit Display Scaling]</i>, and <i>b5-39 [PID User Unit Display Digits]</i> set the unit, scaling, and resolution.</p>	No signal output available
U1-64 (108D)	Motor Speed	<p><b>V/f</b> <b>OLV/IPM</b> <b>EZOLV</b></p> <p>Shows the absolute value of the parameter <i>U1-02 [Output Frequency]</i> converted to RPM. Unit: 1 RPM</p>	No signal output available
U1-99 (3BAE)	Anti-No-Flow Timer	<p><b>V/f</b> <b>OLV/IPM</b> <b>EZOLV</b></p> <p>Shows the value of the anti-no-flow timer. When this value is at the <i>Y2-24 [Anti-No-Flow Detection Time]</i> setting, the anti-no-flow feature starts to decrease the output frequency. Unit: 0.1 s</p>	No signal output available

◆ U2: Fault Trace

No. (Hex.)	Name	Description	MFAO Signal Level
U2-01 (0080)	Current Fault	<p><b>V/f</b> <b>OLV/IPM</b> <b>EZOLV</b></p> <p>Shows the fault that the drive has when viewing the monitor.</p>	No signal output available
U2-02 (0081)	Previous Fault	<p><b>V/f</b> <b>OLV/IPM</b> <b>EZOLV</b></p> <p>Shows the fault that occurred most recently.</p>	No signal output available
U2-03 (0082)	Freq Reference@Fault	<p><b>V/f</b> <b>OLV/IPM</b> <b>EZOLV</b></p> <p>Shows the frequency reference at the fault that occurred most recently. Use <i>U1-01 [Frequency Reference]</i> to monitor the frequency reference value. Unit: 0.01 Hz</p>	No signal output available
U2-04 (0083)	Output Freq @ Fault	<p><b>V/f</b> <b>OLV/IPM</b> <b>EZOLV</b></p> <p>Shows the output frequency at the fault that occurred most recently. Use <i>U1-02 [Output Frequency]</i> to monitor the actual output frequency. Unit: 0.01 Hz</p>	No signal output available
U2-05 (0084)	Output Current@Fault	<p><b>V/f</b> <b>OLV/IPM</b> <b>EZOLV</b></p> <p>Shows the output current at the fault that occurred most recently. Use <i>U1-03 [Output Current]</i> to monitor the output current. The keypad shows the value of <i>U1-03</i> in amperes (A). When you use serial communications to show the monitor, the current is "8192 = drive rated current (A)". Use the formula: "Numerals being displayed / 8192 × drive rated current (A)" to use the serial communication current value shown in the monitor. Unit: Determined by the drive model. • 0.01 A: 2011 to 2046, 4005 to 4014 • 0.1 A: 2059 to 2273, 4021 to 4302</p>	No signal output available
U2-06 (0085)	Motor Speed @ Fault	<p><b>V/f</b> <b>OLV/IPM</b> <b>EZOLV</b></p> <p>Shows the motor speed at the fault that occurred most recently. Use <i>U1-05 [Motor Speed]</i> to monitor the motor speed. Unit: 0.01 Hz</p>	No signal output available
U2-07 (0086)	Output Voltage@Fault	<p><b>V/f</b> <b>OLV/IPM</b> <b>EZOLV</b></p> <p>Shows the output voltage reference at the fault that occurred most recently. Use <i>U1-06 [Output Voltage Ref]</i> to monitor the output voltage reference. Unit: 0.1 V</p>	No signal output available
U2-08 (0087)	DC Bus Voltage@Fault	<p><b>V/f</b> <b>OLV/IPM</b> <b>EZOLV</b></p> <p>Shows the DC bus voltage at the fault that occurred most recently. Use <i>U1-07 [DC Bus Voltage]</i> to monitor the DC bus voltage. Unit: 1 V</p>	No signal output available
U2-09 (0088)	Output Power @ Fault	<p><b>V/f</b> <b>OLV/IPM</b> <b>EZOLV</b></p> <p>Shows the output power at the fault that occurred most recently. Use <i>U1-08 [Output Power]</i> to monitor the output power. Unit: 0.1 kW</p>	No signal output available
U2-10 (0089)	Torque Ref @ Fault	<p><b>V/f</b> <b>OLV/IPM</b> <b>EZOLV</b></p> <p>Shows the torque reference at the fault that occurred most recently as a percentage of the motor rated torque. Use <i>U1-09 [Torque Reference]</i> to monitor the torque reference. Unit: 0.1%</p>	No signal output available



No. (Hex.)	Name	Description	MFAO Signal Level
U2-11 (008A)	Input Terminal Status @ Fault	<p><b>V/f</b> <b>OLV/PM</b> <b>EZOLV</b></p> <p>Shows the status of the MFDI terminals at the most recent fault where 1 = (ON) and 0 = (OFF). For example, U2-11 shows "00000011" when terminals S1 and S2 are ON. Use U1-10 [Input Terminal Status] to monitor the MFDI terminal status.</p> <p>bit 0 : Terminal S1 bit 1 : Terminal S2 bit 2 : Terminal S3 bit 3 : Terminal S4 bit 4 : Terminal S5 bit 5 : Terminal S6 bit 6 : Terminal S7 bit 7 : Not used (normal value of 0).</p>	No signal output available
U2-12 (008B)	Output Terminal Status @ Fault	<p><b>V/f</b> <b>OLV/PM</b> <b>EZOLV</b></p> <p>Shows the status of the MFDO terminals at the most recent fault where 1 = (ON) and 0 = (OFF). For example, U2-12 shows "00000011" when terminals M1 and M3 are ON. Use U1-11 [Output Terminal Status] to monitor the MFDO terminal status.</p> <p>bit 0 : Terminals M1-M2 bit 1 : Terminals M3-M4 bit 2 : Terminals M5-M6 bit 3 : Not used (normal value of 0). bit 4 : Not used (normal value of 0). bit 5 : Not used (normal value of 0). bit 6 : Not used (normal value of 0). bit 7 : Fault relay MA/MB-MC</p>	No signal output available
U2-13 (008C)	Operation Status @ Fault	<p><b>V/f</b> <b>OLV/PM</b> <b>EZOLV</b></p> <p>Shows the status of the MFDO terminals at the most recent fault where 1 = (ON) and 0 = (OFF). For example, U2-13 shows "00000001" during run. Use U1-12 [Drive Status] to monitor the MFDO terminal status.</p> <p>bit0 : During Run bit1 : During zero-speed bit2 : During reverse bit3 : During fault reset signal input bit4 : During speed agreement bit5 : Drive ready bit6 : During minor fault detection bit7 : During fault detection</p>	No signal output available
U2-14 (008D)	Elapsed Time @ Fault	<p><b>V/f</b> <b>OLV/PM</b> <b>EZOLV</b></p> <p>Shows the cumulative operation time of the drive at the fault that occurred most recently. Use U4-01 [Cumulative Ope Time] to monitor the cumulative operation time. Unit: 1 h</p>	No signal output available
U2-15 (07E0)	SFS Output @ Fault	<p><b>V/f</b> <b>OLV/PM</b> <b>EZOLV</b></p> <p>Shows the output frequency after soft start at the fault that occurred most recently. Use U1-16 [SFS Output Frequency] to monitor the output frequency after soft start. Unit: 0.01 Hz</p>	No signal output available
U2-16 (07E1)	q-Axis Current@Fault	<p><b>V/f</b> <b>OLV/PM</b> <b>EZOLV</b></p> <p>Shows the q-Axis current of the motor at the fault that occurred most recently. Use U6-01 [Iq Secondary Current] to monitor the q-Axis current of the motor. Unit: 0.1 %</p>	No signal output available
U2-17 (07E2)	d-Axis Current@Fault	<p><b>V/f</b> <b>OLV/PM</b> <b>EZOLV</b></p> <p>Shows the d-Axis current of the motor at the fault that occurred most recently. Use U6-02 [Id ExcitationCurrent] to monitor the d-Axis current of the motor. Unit: 0.1 %</p>	No signal output available
U2-20 (008E)	Heatsink Temp @Fault	<p><b>V/f</b> <b>OLV/PM</b> <b>EZOLV</b></p> <p>Shows the heatsink temperature at the fault that occurred most recently. Use U4-08 [Heatsink Temperature] to monitor the temperature of the heatsink. Unit: 1 °C</p>	No signal output available

No. (Hex.)	Name	Description	MFAO Signal Level
U2-21 (1166) Expert	STPo Detect @ Fault	<p><b>V/f</b> <b>OLV/IPM</b> <b>EZOLV</b></p> <p>Monitors conditions to detect <i>STPo</i> [<i>Motor Step-Out Detected</i>] faults. The bit for each condition is shown as ON or OFF.                      bit0 : Excessive current                      bit1 : Induced voltage deviation                      bit2 : d-axis current deviation                      bit3 : Motor lock at startup                      bit4 : Acceleration stall continue                      bit5 : Acceleration stall repeat                      bit6 : Not used (normal value of 0).                      bit7 : Not used (normal value of 0).</p>	No signal output available
U2-30 (3008)	Fault 1 YYYY	<p><b>V/f</b> <b>OLV/IPM</b> <b>EZOLV</b></p> <p>Shows the year when the most recent fault occurred.</p>	No signal output available
U2-31 (3009)	Fault 1 MMDD	<p><b>V/f</b> <b>OLV/IPM</b> <b>EZOLV</b></p> <p>Shows the month and day when the most recent fault occurred.</p>	No signal output available
U2-32 (300A)	Fault 1 HHMM	<p><b>V/f</b> <b>OLV/IPM</b> <b>EZOLV</b></p> <p>Shows the time when the most recent fault occurred.</p>	No signal output available

### ◆ U3: Fault History

No. (Hex.)	Name	Description	MFAO Signal Level
U3-01 (0090)	1st MostRecent Fault	<p><b>V/f</b> <b>OLV/IPM</b> <b>EZOLV</b></p> <p>Shows the fault history of the most recent fault.  <b>Note:</b>                      The drive saves this fault history to two types of registers at the same time for the MEMOBUS/Modbus communications.</p>	No signal output available
U3-02 (0091)	2nd MostRecent Fault	<p><b>V/f</b> <b>OLV/IPM</b> <b>EZOLV</b></p> <p>Shows the fault history of the second most recent fault.  <b>Note:</b>                      The drive saves this fault history to two types of registers at the same time for the MEMOBUS/Modbus communications.</p>	No signal output available
U3-03 (0092)	3rd MostRecent Fault	<p><b>V/f</b> <b>OLV/IPM</b> <b>EZOLV</b></p> <p>Shows the fault history of the third most recent fault.  <b>Note:</b>                      The drive saves this fault history to two types of registers at the same time for the MEMOBUS/Modbus communications.</p>	No signal output available
U3-04 (0093)	4th MostRecent Fault	<p><b>V/f</b> <b>OLV/IPM</b> <b>EZOLV</b></p> <p>Shows the fault history of the fourth most recent fault.  <b>Note:</b>                      The drive saves this fault history to two types of registers at the same time for the MEMOBUS/Modbus communications.</p>	No signal output available
U3-05 (0804)	5th MostRecent Fault	<p><b>V/f</b> <b>OLV/IPM</b> <b>EZOLV</b></p> <p>Shows the fault history of the fifth most recent fault.</p>	No signal output available
U3-06 (0805)	6th MostRecent Fault	<p><b>V/f</b> <b>OLV/IPM</b> <b>EZOLV</b></p> <p>Shows the fault history of the sixth most recent fault.</p>	No signal output available
U3-07 (0806)	7th MostRecent Fault	<p><b>V/f</b> <b>OLV/IPM</b> <b>EZOLV</b></p> <p>Shows the fault history of the seventh most recent fault.</p>	No signal output available
U3-08 (0807)	8th MostRecent Fault	<p><b>V/f</b> <b>OLV/IPM</b> <b>EZOLV</b></p> <p>Shows the fault history of the eighth most recent fault.</p>	No signal output available
U3-09 (0808)	9th MostRecent Fault	<p><b>V/f</b> <b>OLV/IPM</b> <b>EZOLV</b></p> <p>Shows the fault history of the ninth most recent fault.</p>	No signal output available
U3-10 (0809)	10th MostRecentFault	<p><b>V/f</b> <b>OLV/IPM</b> <b>EZOLV</b></p> <p>Shows the fault history of the tenth most recent fault.</p>	No signal output available
U3-11 (0094)	ElapsedTime@1stFault	<p><b>V/f</b> <b>OLV/IPM</b> <b>EZOLV</b></p> <p>Shows the cumulative operation time when the most recent fault occurred.  <b>Note:</b>                      The drive saves this cumulative operation time to two types of registers at the same time for the MEMOBUS/Modbus communications.                      Unit: 1 h</p>	No signal output available

No. (Hex.)	Name	Description	MFAO Signal Level
U3-12 (0095)	ElapsedTime@2ndFault	<b>V/f</b> <b>OLV/PM</b> <b>EZOLV</b> Shows the cumulative operation time when the second most recent fault occurred. <b>Note:</b> The drive saves this cumulative operation time to two types of registers at the same time for the MEMOBUS/Modbus communications. Unit: 1 h	No signal output available
U3-13 (0096)	ElapsedTime@3rdFault	<b>V/f</b> <b>OLV/PM</b> <b>EZOLV</b> Shows the cumulative operation time when the third most recent fault occurred. <b>Note:</b> The drive saves this cumulative operation time to two types of registers at the same time for the MEMOBUS/Modbus communications. Unit: 1 h	No signal output available
U3-14 (0097)	ElapsedTime@4thFault	<b>V/f</b> <b>OLV/PM</b> <b>EZOLV</b> Shows the cumulative operation time when the fourth most recent fault occurred. <b>Note:</b> The drive saves this cumulative operation time to two types of registers at the same time for the MEMOBUS/Modbus communications. Unit: 1 h	No signal output available
U3-15 (080E)	ElapsedTime@5thFault	<b>V/f</b> <b>OLV/PM</b> <b>EZOLV</b> Shows the cumulative operation time when the fifth most recent fault occurred. Unit: 1 h	No signal output available
U3-16 (080F)	ElapsedTime@6thFault	<b>V/f</b> <b>OLV/PM</b> <b>EZOLV</b> Shows the cumulative operation time when the sixth most recent fault occurred. Unit: 1 h	No signal output available
U3-17 (0810)	ElapsedTime@7thFault	<b>V/f</b> <b>OLV/PM</b> <b>EZOLV</b> Shows the cumulative operation time when the seventh most recent fault occurred. Unit: 1 h	No signal output available
U3-18 (0811)	ElapsedTime@8thFault	<b>V/f</b> <b>OLV/PM</b> <b>EZOLV</b> Shows the cumulative operation time when the eighth most recent fault occurred. Unit: 1 h	No signal output available
U3-19 (0812)	ElapsedTime@9thFault	<b>V/f</b> <b>OLV/PM</b> <b>EZOLV</b> Shows the cumulative operation time when the ninth most recent fault occurred. Unit: 1 h	No signal output available
U3-20 (0813)	ElapsedTime@10 Fault	<b>V/f</b> <b>OLV/PM</b> <b>EZOLV</b> Shows the cumulative operation time when the tenth most recent fault occurred. Unit: 1 h	No signal output available
U3-21 (300B)	Fault 1 YYYY	<b>V/f</b> <b>OLV/PM</b> <b>EZOLV</b> Shows the year when the most recent fault occurred.	No signal output available
U3-22 (300C)	Fault 1 MMDD	<b>V/f</b> <b>OLV/PM</b> <b>EZOLV</b> Shows the month and day when the most recent fault occurred.	No signal output available
U3-23 (300D)	Fault 1 HHMM	<b>V/f</b> <b>OLV/PM</b> <b>EZOLV</b> Shows the time when the most recent fault occurred.	No signal output available
U3-24 (300E)	Fault 2 YYYY	<b>V/f</b> <b>OLV/PM</b> <b>EZOLV</b> Shows the year when the second most recent fault occurred.	No signal output available
U3-25 (300F)	Fault 2 MMDD	<b>V/f</b> <b>OLV/PM</b> <b>EZOLV</b> Shows the month and day when the second most recent fault occurred.	No signal output available
U3-26 (3010)	Fault 2 HHMM	<b>V/f</b> <b>OLV/PM</b> <b>EZOLV</b> Shows the time when the second most recent fault occurred.	No signal output available
U3-27 (3011)	Fault 3 YYYY	<b>V/f</b> <b>OLV/PM</b> <b>EZOLV</b> Shows the year when the third most recent fault occurred.	No signal output available
U3-28 (3012)	Fault 3 MMDD	<b>V/f</b> <b>OLV/PM</b> <b>EZOLV</b> Shows the month and day when the third most recent fault occurred.	No signal output available
U3-29 (3013)	Fault 3 HHMM	<b>V/f</b> <b>OLV/PM</b> <b>EZOLV</b> Shows the time when the third most recent fault occurred.	No signal output available
U3-30 (3014)	Fault 4 YYYY	<b>V/f</b> <b>OLV/PM</b> <b>EZOLV</b> Shows the year when the fourth most recent fault occurred.	No signal output available
U3-31 (3015)	Fault 4 MMDD	<b>V/f</b> <b>OLV/PM</b> <b>EZOLV</b> Shows the month and day when the fourth most recent fault occurred.	No signal output available

No. (Hex.)	Name	Description	MFAO Signal Level
U3-32 (3016)	Fault 4 HHMM	<b>V/f</b> <b>OLV/IPM</b> <b>EZOLV</b> Shows the time when the fourth most recent fault occurred.	No signal output available
U3-33 (3017)	Fault 5 YYYY	<b>V/f</b> <b>OLV/IPM</b> <b>EZOLV</b> Shows the year when the fifth most recent fault occurred.	No signal output available
U3-34 (3018)	Fault 5 MMDD	<b>V/f</b> <b>OLV/IPM</b> <b>EZOLV</b> Shows the month and day when the fifth most recent fault occurred.	No signal output available
U3-35 (3019)	Fault 5 HHMM	<b>V/f</b> <b>OLV/IPM</b> <b>EZOLV</b> Shows the time when the fifth most recent fault occurred.	No signal output available
U3-36 (301A)	Fault 6 YYYY	<b>V/f</b> <b>OLV/IPM</b> <b>EZOLV</b> Shows the year when the sixth most recent fault occurred.	No signal output available
U3-37 (301B)	Fault 6 MMDD	<b>V/f</b> <b>OLV/IPM</b> <b>EZOLV</b> Shows the month and day when the sixth most recent fault occurred.	No signal output available
U3-38 (301C)	Fault 6 HHMM	<b>V/f</b> <b>OLV/IPM</b> <b>EZOLV</b> Shows the time when the sixth most recent fault occurred.	No signal output available
U3-39 (301D)	Fault 7 YYYY	<b>V/f</b> <b>OLV/IPM</b> <b>EZOLV</b> Shows the year when the seventh most recent fault occurred.	No signal output available
U3-40 (301E)	Fault 7 MMDD	<b>V/f</b> <b>OLV/IPM</b> <b>EZOLV</b> Shows the month and day when the seventh most recent fault occurred.	No signal output available
U3-41 (301F)	Fault 7 HHMM	<b>V/f</b> <b>OLV/IPM</b> <b>EZOLV</b> Shows the time when the seventh most recent fault occurred.	No signal output available
U3-42 (3020)	Fault 8 YYYY	<b>V/f</b> <b>OLV/IPM</b> <b>EZOLV</b> Shows the year when the eighth most recent fault occurred.	No signal output available
U3-43 (3021)	Fault 8 MMDD	<b>V/f</b> <b>OLV/IPM</b> <b>EZOLV</b> Shows the month and day when the eighth most recent fault occurred.	No signal output available
U3-44 (3022)	Fault 8 HHMM	<b>V/f</b> <b>OLV/IPM</b> <b>EZOLV</b> Shows the time when the eighth most recent fault occurred.	No signal output available
U3-45 (3023)	Fault 9 YYYY	<b>V/f</b> <b>OLV/IPM</b> <b>EZOLV</b> Shows the year when the ninth most recent fault occurred.	No signal output available
U3-46 (3024)	Fault 9 MMDD	<b>V/f</b> <b>OLV/IPM</b> <b>EZOLV</b> Shows the month and day when the ninth most recent fault occurred.	No signal output available
U3-47 (3025)	Fault 9 HHMM	<b>V/f</b> <b>OLV/IPM</b> <b>EZOLV</b> Shows the time when the ninth most recent fault occurred.	No signal output available
U3-48 (3026)	Fault 10 YYYY	<b>V/f</b> <b>OLV/IPM</b> <b>EZOLV</b> Shows the year when the tenth most recent fault occurred.	No signal output available
U3-49 (3027)	Fault 10 MMDD	<b>V/f</b> <b>OLV/IPM</b> <b>EZOLV</b> Shows the month and day when the tenth most recent fault occurred.	No signal output available
U3-50 (3028)	Fault 10 HHMM	<b>V/f</b> <b>OLV/IPM</b> <b>EZOLV</b> Shows the time when the tenth most recent fault occurred.	No signal output available

## ◆ U4: Maintenance Monitors

No. (Hex.)	Name	Description	MFAO Signal Level
U4-01 (004C)	Cumulative Ope Time	<p><b>V/f</b> <b>OLV/PM</b> <b>EZOLV</b></p> <p>Shows the cumulative operation time of the drive.</p> <p>Use parameter <i>o4-01 [Elapsed Operating Time Setting]</i> to reset this monitor. Use parameter <i>o4-02 [Elapsed Operating Time Selection]</i> to select the cumulative operation times from:</p> <ul style="list-style-type: none"> <li>The time from when the drive is energized until it is de-energized.</li> <li>The time at which the Run command is turned ON.</li> </ul> <p>The maximum value that the monitor will show is <i>99999</i>. After this value is more than <i>99999</i>, the drive automatically resets it and starts to count from <i>0</i> again.</p> <p>Unit: 1 h</p> <p><b>Note:</b> The MEMOBUS/Modbus communication data is shown in 10 h units. Use register 0099H for data in 1 h units.</p>	10 V: 99999 h
U4-02 (0075)	Num of Run Commands	<p><b>V/f</b> <b>OLV/PM</b> <b>EZOLV</b></p> <p>Shows how many times that the drive has received a Run command.</p> <p>Use parameter <i>o4-13 [RUN Command Counter @ Initialize]</i> to reset this monitor. The maximum value that the monitor will show is <i>65535</i>. After this value is more than <i>65535</i>, the drive automatically resets it and starts to count from <i>0</i> again.</p> <p>Unit: 1</p>	10 V: 65535 times
U4-03 (0067)	Cooling Fan Ope Time	<p><b>V/f</b> <b>OLV/PM</b> <b>EZOLV</b></p> <p>Shows the cumulative operation time of the cooling fans.</p> <p>Use parameter <i>o4-03 [Fan Operation Time Setting]</i> to reset this monitor. The maximum value that the monitor will show is <i>99999</i>. After this value is more than <i>99999</i>, the drive automatically resets it and starts to count from <i>0</i> again.</p> <p>Unit: 1 h</p> <p><b>Note:</b> The MEMOBUS/Modbus communication data is shown in 10 h units. Use register 009BH for data in 1 h units.</p>	10 V: 99999 h
U4-04 (007E)	Cool Fan Maintenance	<p><b>V/f</b> <b>OLV/PM</b> <b>EZOLV</b></p> <p>Shows the cumulative operation time of the cooling fans as a percentage of the estimated performance life of the cooling fans.</p> <p>The default value is 0. The value counts up from 0.</p> <p>Use <i>o4-03 [Fan Operation Time Setting]</i> to reset this monitor.</p> <p>Unit: 1%</p> <p><b>Note:</b> Replace the cooling fans when this monitor is at 90%.</p>	10 V: 100%
U4-05 (007C)	CapacitorMaintenance	<p><b>V/f</b> <b>OLV/PM</b> <b>EZOLV</b></p> <p>Shows the operation time of the electrolytic capacitors for the main circuit and control circuit as a percentage of the estimated performance life of the electrolytic capacitors.</p> <p>The default value is 0. The value counts up from 0.</p> <p>Use <i>o4-05 [Capacitor Maintenance Setting]</i> to reset this monitor.</p> <p>Unit: 1%</p> <p><b>Note:</b> Replace the electrolytic capacitor when this monitor is at 90%.</p>	10 V: 100%
U4-06 (07D6)	PreChargeRelayMainte	<p><b>V/f</b> <b>OLV/PM</b> <b>EZOLV</b></p> <p>Shows the operation time of the soft charge bypass relay as a percentage of the estimated performance life of the soft charge bypass relay.</p> <p>The default value is 0. The value counts up from 0.</p> <p>Use <i>o4-07 [Softcharge Relay Maintenance Set]</i> to reset this monitor.</p> <p>Unit: 1%</p> <p><b>Note:</b> Replace the drive when this monitor is at 90%.</p>	10 V: 100%
U4-07 (07D7)	IGBT Maintenance	<p><b>V/f</b> <b>OLV/PM</b> <b>EZOLV</b></p> <p>Shows the operation time of the IGBTs as a percentage of the estimated performance life of the IGBTs.</p> <p>The default value is 0. The value counts up from 0.</p> <p>Use <i>o4-09 [IGBT Maintenance Setting]</i> to reset this monitor.</p> <p>Unit: 1%</p> <p><b>Note:</b> Replace the drive when this monitor is at 90%.</p>	10 V: 100%
U4-08 (0068)	Heatsink Temperature	<p><b>V/f</b> <b>OLV/PM</b> <b>EZOLV</b></p> <p>Shows the heatsink temperature of the drive.</p> <p>Unit: 1 °C</p>	10 V: 100 °C

# 11.18 U: Monitors

No. (Hex.)	Name	Description	MFAO Signal Level
U4-09 (005E)	LED Check	<p><b>V/f</b> <b>OLV/IPM</b> <b>EZOLV</b></p> <p>Turns on the LED Status Ring and all of the keypad LEDs to make sure that the LEDs operate correctly.</p> <ol style="list-style-type: none"> <li>Set <math>o2-24 = 0</math> [<i>LED Light Function Selection = Enable Status Ring &amp; Keypad LED</i>].</li> <li>Push  when U4-09 is the top monitor shown on the keypad. All LEDs on the keypad and LED Status Ring will turn on.</li> </ol> <p><b>Note:</b> When Safety input 2 CH is open (STo), READY will flash.</p>	No signal output available
U4-10 (005C)	kWh, Lower 4 Digits	<p><b>V/f</b> <b>OLV/IPM</b> <b>EZOLV</b></p> <p>Shows the lower 4 digits of the watt hour value for the drive. Unit: 1 kWh</p> <p><b>Note:</b> The watt hour is displayed in 9 digits. Monitor U4-11 [<i>kWh, Upper 5 Digits</i>] shows the upper 5 digits and U4-10 shows the lower 4 digits. Example for 12345678.9 kWh: U4-10: 678.9 kWh U4-11: 12345 MWh</p>	No signal output available
U4-11 (005D)	kWh, Upper 5 Digits	<p><b>V/f</b> <b>OLV/IPM</b> <b>EZOLV</b></p> <p>Shows the upper 5 digits of the watt hour value for the drive. Unit: 1 MWh</p> <p><b>Note:</b> Monitor U4-11 shows the upper 5 digits and U4-10 [<i>kWh, Lower 4 Digits</i>] shows the lower 4 digits. Example for 12345678.9 kWh: U4-10: 678.9 kWh U4-11: 12345 MWh</p>	No signal output available
U4-13 (07CF)	Peak Hold Current	<p><b>V/f</b> <b>OLV/IPM</b> <b>EZOLV</b></p> <p>Shows the hold value of the peak value (rms) for the drive output current. Use U4-14 [<i>PeakHold Output Freq</i>] to show the drive output frequency at the time that the drive holds the output current. The drive will hold the peak hold current at the next start up and restart of the power supply. The drive keeps the held value during baseblock (during stop). The keypad shows the value of U4-13 in amperes (A). When you use serial communications to show the monitor, the current is "8192 = drive rated current (A)." Use the formula: "Numerals being displayed / 8192 × drive rated current (A)" to use the serial communication current value shown in the monitor. Unit: Determined by the drive model. • 0.01 A: 2011 to 2046, 4005 to 4014 • 0.1 A: 2059 to 2273, 4021 to 4302</p>	No signal output available
U4-14 (07D0)	PeakHold Output Freq	<p><b>V/f</b> <b>OLV/IPM</b> <b>EZOLV</b></p> <p>Shows the output frequency at which the peak value (rms) of the drive output current is held. The peak hold current can be monitored by U4-13 [<i>Peak Hold Current</i>]. The peak hold output frequency will be cleared at the next startup and restart of the power supply. The drive keeps the value that was under hold during baseblock (during stop). Unit: 0.01 Hz</p>	No signal output available
U4-16 (07D8)	Motor oL1 Level	<p><b>V/f</b> <b>OLV/IPM</b> <b>EZOLV</b></p> <p>Shows the integrated value of oL1 [<i>Motor Overload</i>] as a percentage of oL1 detection level. Unit: 0.1%</p>	10 V: 100%
U4-18 (07DA)	Reference Source	<p><b>V/f</b> <b>OLV/IPM</b> <b>EZOLV</b></p> <p>Shows the selected frequency reference source. The keypad shows the frequency reference source as "XY-nn" as specified by these rules: X: Frequency reference • 1: b1-01 [<i>Frequency Reference Selection 1</i>] Y-nn: Frequency reference source • 0-01: Keypad (d1-01 [<i>Reference 1</i>]) • 1-00: Analog input (unassigned) • 1-01: MFAI terminal A1 • 1-02: MFAI terminal A2 • 2-02 to 2-17: Multi-step speed reference (d1-02 to d1-17 [<i>Reference 2 to 8, Jog Reference</i>]) • 3-01: Serial communications • 4-01: Communication option card • 7-01: DriveWorksEZ • 9-01: Up/Down command • B-00: Hand Reference 1 (Analog) • B-01: Hand Reference 1 (S5-05 [<i>HAND Frequency Reference</i>])</p>	No signal output available

No. (Hex.)	Name	Description	MFAO Signal Level
U4-19 (07DB)	Modbus FreqRef (dec)	<p><b>V/f</b> <b>OLV/PM</b> <b>EZOLV</b></p> <p>Shows the frequency reference sent to the drive from the MEMOBUS/Modbus communications as a decimal. Unit: 0.01%</p>	10 V: Maximum frequency
U4-20 (07DC)	Option Freq Ref(dec)	<p><b>V/f</b> <b>OLV/PM</b> <b>EZOLV</b></p> <p>Shows the frequency reference sent to the drive from the communication option as a decimal. Unit: 0.01%</p>	10 V: Maximum frequency
U4-21 (07DD)	Run Cmd Source	<p><b>V/f</b> <b>OLV/PM</b> <b>EZOLV</b></p> <p>Shows the selected Run command source. The keypad shows the Run command source as "XY-nn" as specified by these rules: X: Run command</p> <ul style="list-style-type: none"> <li>• 0: OFF</li> <li>• 1: AUTO</li> <li>• 2: HAND</li> <li>• 3: JOG, Emergency Override</li> </ul> <p>Y: Run command source</p> <ul style="list-style-type: none"> <li>• 0: Keypad</li> <li>• 1: Control circuit terminal</li> <li>• 3: Serial communications</li> <li>• 4: Communication option card</li> <li>• 7: DriveWorksEZ</li> </ul> <p>nn: Run command limit status data</p> <ul style="list-style-type: none"> <li>• 00: No limit status.</li> <li>• 01: The Run command stayed ON when the drive stopped in Programming Mode.</li> <li>• 03: The Run command is in standby after the drive was energized until the soft charge bypass contactor turns ON.</li> </ul> <p><b>Note:</b> The drive will detect <math>Uv1</math> [DC Bus Undervoltage] or <math>Uv</math> [Undervoltage] if the soft charge bypass contactor does not turn ON after 10 s.</p> <ul style="list-style-type: none"> <li>• 04: Will not restart after run stop.</li> <li>• 05: An MFDI terminal caused a Fast stop or you pushed  on the keypad to ramp the motor to stop.</li> <li>• 06: <math>b1-17 = 0</math> [Run Command at Power Up = Disregard Existing RUN Command].</li> <li>• 07: During baseblock while coast to stop with timer.</li> <li>• 08: Frequency reference is less than <math>E1-09</math> [Minimum Output Frequency] during baseblock.</li> <li>• 09: Waiting for the Enter command from PLC.</li> </ul>	No signal output available
U4-22 (07DE)	Modbus CmdData (hex)	<p><b>V/f</b> <b>OLV/PM</b> <b>EZOLV</b></p> <p>Shows the operation signal (register 0001H) sent to the drive from MEMOBUS/Modbus communications as a 4-digit hexadecimal number (zero suppress). The keypad shows the operation signal as specified by these rules:</p> <ul style="list-style-type: none"> <li>bit 0 : Forward run/Stop</li> <li>bit 1 : Reverse run/Stop</li> <li>bit 2 : External fault</li> <li>bit 3 : Fault Reset</li> <li>bit 4 : Multi-function input 1</li> <li>bit 5 : Multi-function input 2</li> <li>bit 6 : Multi-function input 3</li> <li>bit 7 : Multi-function input 4</li> <li>bit 8 : Multi-function input 5</li> <li>bit 9 : Multi-function input 6</li> <li>bit A : Multi-function input 7</li> <li>bit B : Not used (normal value of 0).</li> <li>bit C : Not used (normal value of 0).</li> <li>bit D : Not used (normal value of 0).</li> <li>bit E : Not used (normal value of 0).</li> <li>bit F : Not used (normal value of 0).</li> </ul>	No signal output available

No. (Hex.)	Name	Description	MFAO Signal Level
U4-23 (07DF)	Option CmdData (hex)	<p><b>V/f</b> <b>OLV/IPM</b> <b>EZOLV</b></p> <p>Shows the operation signal (register 0001H) sent to the drive from MEMOBUS/Modbus communications as a 4-digit hexadecimal number. The keypad shows the operation signal as specified by these rules:</p> <p>bit 0 : Forward run/Stop  bit 1 : Reverse run/Stop  bit 2 : External fault  bit 3 : Fault Reset  bit 4 : Multi-function input 1  bit 5 : Multi-function input 2  bit 6 : Multi-function input 3  bit 7 : Multi-function input 4  bit 8 : Multi-function input 5  bit 9 : Multi-function input 6  bit A : Multi-function input 7  bit B : Not used (normal value of 0).  bit C : Not used (normal value of 0).  bit D : Not used (normal value of 0).  bit E : Not used (normal value of 0).  bit F : Not used (normal value of 0).</p>	No signal output available
U4-24 (07E6)	Number of Runs (Low)	<p><b>V/f</b> <b>OLV/IPM</b> <b>EZOLV</b></p> <p>Shows the lower 4 digits of the drive run count.</p> <p><b>Note:</b>  The drive run count is an 8-digit number. Monitor <i>U4-25 [Number of Runs(High)]</i> shows the upper 4 digits and <i>U4-24</i> shows the lower 4 digits.</p>	No signal output available
U4-25 (07E7)	Number of Runs(High)	<p><b>V/f</b> <b>OLV/IPM</b> <b>EZOLV</b></p> <p>Shows the upper 4 digits of the drive run count.</p> <p><b>Note:</b>  The drive run count is an 8-digit number. Monitor <i>U4-25</i> shows the upper 4 digits and <i>U4-24 [Number of Runs (Low)]</i> shows the lower 4 digits.</p>	No signal output available
U4-52 (1592)	Torque Ref from Comm	<p><b>V/f</b> <b>OLV/IPM</b> <b>EZOLV</b></p> <p>Shows the torque reference that the drive received from a serial communication option card or from MEMOBUS/Modbus communications as a decimal number.</p> <p>Unit: 0.1%</p>	10 V: 100%
U4-61 (3096) Expert	Total EMOVR Run Time	<p><b>V/f</b> <b>OLV/IPM</b> <b>EZOLV</b></p> <p>Shows the length of time that the drive operated in Emergency Override Mode.</p> <p>Unit: 1 min</p> <p><b>Note:</b></p> <ul style="list-style-type: none"> <li>The maximum value is 60,000 min.</li> <li>This monitor does not accumulate operation time when <i>S6-07 = 1 [EMOVR Fault Suppression Mode = Test Mode]</i>.</li> </ul>	No signal output available

◆ U5: PID Monitors

No. (Hex.)	Name	Description	MFAO Signal Level
U5-01 (0057)	PID Feedback	<p><b>V/f</b> <b>OLV/IPM</b> <b>EZOLV</b></p> <p>Shows the PID control feedback value.</p> <p>Unit: 0.01%</p> <p><b>Note:</b>  Parameters <i>b5-46 [PID Unit Display Selection]</i>, <i>b5-38 [PID User Unit Display Scaling]</i>, and <i>b5-39 [PID User Unit Display Digits]</i> set the unit, scaling, and resolution.</p>	10 V = Maximum frequency
U5-02 (0063)	PID Input	<p><b>V/f</b> <b>OLV/IPM</b> <b>EZOLV</b></p> <p>Shows the change between the PID setpoint and PID feedback (the quantity of PID input) as a percentage of the maximum output frequency.</p> <p>Unit: 0.01%</p>	10 V: Maximum frequency
U5-03 (0064)	PID Output	<p><b>V/f</b> <b>OLV/IPM</b> <b>EZOLV</b></p> <p>Shows the PID control output as a percentage of the maximum output frequency.</p> <p>Unit: 0.01%</p>	10 V: Maximum frequency



No. (Hex.)	Name	Description	MFAO Signal Level
U5-04 (0065)	PID Setpoint	<b>V/f</b> <b>OLV/PM</b> <b>EZOLV</b> Shows the PID setpoint. Unit: 0.01% <b>Note:</b> Parameters <i>b5-46 [PID Unit Display Selection]</i> , <i>b5-38 [PID User Unit Display Scaling]</i> , and <i>b5-39 [PID User Unit Display Digits]</i> set the unit, scaling, and resolution.	10 V = Maximum frequency
U5-05 (07D2)	PID DifferentialFdbk	<b>V/f</b> <b>OLV/PM</b> <b>EZOLV</b> Shows the PID differential feedback value as a percentage of the maximum output frequency. This monitor is available after you set <i>H3-02</i> or <i>H3-10 = 16 [Terminal A1/A2 Function Selection = Differential PID Feedback]</i> . Unit: 0.01%	10 V = Maximum frequency
U5-06 (07D3)	PID Fdbk-Diff PID Fdbk	<b>V/f</b> <b>OLV/PM</b> <b>EZOLV</b> Shows the difference from calculating " <i>U5-05 [PID DifferentialFdbk] - U5-01 [PID Feedback]</i> ". Unit: 0.01% <b>Note:</b> <i>U5-01 [PID Feedback] = U5-06</i> when <i>H3-02</i> or <i>H3-10 ≠ 16 [Terminal A1/A2 Function Selection ≠ Differential PID Feedback]</i> .	10 V = Maximum frequency
U5-07 (0072)	AUTO Mode Freq Ref	<b>V/f</b> <b>OLV/PM</b> <b>EZOLV</b> Shows the Frequency reference value at AUTO Mode. Unit: 0.01 Hz <b>Note:</b> Parameter <i>o1-03 [Frequency Display Unit Selection]</i> sets the display unit.	No signal output available
U5-08 (0073)	HAND Mode Freq Ref	<b>V/f</b> <b>OLV/PM</b> <b>EZOLV</b> Shows the Frequency reference value at HAND Mode. Unit: 0.01 Hz <b>Note:</b> Parameter <i>o1-03 [Frequency Display Unit Selection]</i> sets the display unit.	No signal output available
U5-14 (086B)	PID Out2 Upr4 Digits	<b>V/f</b> <b>OLV/PM</b> <b>EZOLV</b> Shows the custom PI output. Monitor <i>U5-14</i> shows the upper four digits and <i>U5-15 [PID Out2 Lwr4 Digits]</i> shows the lower four digits. The drive uses <i>b5-43 [PID Out2 Monitor MAX Upper4 Dig]</i> and <i>b5-44 [PID Out2 Monitor MAX Lower4 Dig]</i> to scale the monitors. Unit: 1 <b>Note:</b> Parameter <i>b5-41 [PID Output 2 Unit]</i> sets the display unit.	10 V = $b5-43 \times 10000$
U5-15 (086C)	PID Out2 Lwr4 Digits	<b>V/f</b> <b>OLV/PM</b> <b>EZOLV</b> Shows the custom PI output. Monitor <i>U5-14</i> shows the upper four digits and <i>U5-15 [PID Out2 Lwr4 Digits]</i> shows the lower four digits. The drive uses <i>b5-43 [PID Out2 Monitor MAX Upper4 Dig]</i> and <i>b5-44 [PID Out2 Monitor MAX Lower4 Dig]</i> to scale the monitors. Unit: 0.01 <b>Note:</b> Parameter <i>b5-41 [PID Output 2 Unit]</i> sets the display unit.	$b5-43 > 0$ : 10 V = 10000 $b5-43 = 0$ : 10 V = $b5-44$
U5-16 (086D)	PI Aux Ctrl Feedback	<b>V/f</b> <b>OLV/PM</b> <b>EZOLV</b> Shows the PI Auxiliary Control Feedback level from the terminal set for <i>H3-xx = 27 [PI Auxiliary Control Feedback]</i> . Unit: PSI <b>Note:</b> Parameters <i>YF-21 [PI Aux Ctrl Level Unit Selection]</i> and <i>YF-22 [PI Aux Level Decimal Place Pos]</i> set the unit and resolution.	No signal output available
U5-17 (086E)	PI2 Control Setpoint	<b>V/f</b> <b>OLV/PM</b> <b>EZOLV</b> Shows the PI2 Control setpoint. <b>Note:</b> Parameters <i>S3-04 [PI2 Control Unit Selection]</i> and <i>S3-03 [PI2 Control Decimal Place Pos]</i> set the unit and resolution.	10 V = S3-02
U5-18 (086F)	PI2 Control Feedback	<b>V/f</b> <b>OLV/PM</b> <b>EZOLV</b> Shows the PI2 Control Feedback Level from the terminal set for <i>H3-xx = 26 [PI2 Control Feedback]</i> . <b>Note:</b> Parameters <i>S3-04 [PI2 Control Unit Selection]</i> and <i>S3-03 [PI2 Control Decimal Place Pos]</i> set the unit and resolution.	10 V = S3-02

No. (Hex.)	Name	Description	MFAO Signal Level
U5-19 (0870)	PI2 Control Input	<p><b>V/f</b> <b>OLV/IPM</b> <b>EZOLV</b></p> <p>Shows the PI2 Control input (deviation between PI target and feedback).</p> <p><b>Note:</b> Parameters <i>S3-04 [PI2 Control Unit Selection]</i> and <i>S3-03 [PI2 Control Decimal Place Pos]</i> set the unit and resolution.</p>	10 V = S3-02
U5-20 (0871)	PI2 Control Output	<p><b>V/f</b> <b>OLV/IPM</b> <b>EZOLV</b></p> <p>Shows the PI2 Control output.</p> <p><b>Note:</b>  <ul style="list-style-type: none"> <li>Parameters <i>S3-04 [PI2 Control Unit Selection]</i> and <i>S3-03 [PI2 Control Decimal Place Pos]</i> set the unit and resolution.</li> <li>The drive operation while <i>H1-xx = A8</i> or <i>IA8 [PI2 Control Disable]</i> changes when the <i>S3-12 [PI2 Control Disable Mode Sel]</i> setting changes.</li> </ul> </p>	10 V = S3-02
U5-30 (3000)	Time Hr Min HHMM	<p><b>V/f</b> <b>OLV/IPM</b> <b>EZOLV</b></p> <p>Shows the current time (Hours and Minutes).</p>	No signal output available
U5-31 (3001)	Date Year	<p><b>V/f</b> <b>OLV/IPM</b> <b>EZOLV</b></p> <p>Shows the current year.</p>	No signal output available
U5-32 (3002)	Date Mo Day MMDD	<p><b>V/f</b> <b>OLV/IPM</b> <b>EZOLV</b></p> <p>Shows the current date (Month and Date).</p>	No signal output available
U5-33 (3003)	Date Week	<p><b>V/f</b> <b>OLV/IPM</b> <b>EZOLV</b></p> <p>Shows the current date of the week.</p> <p>bit 0 : Sunday bit 1 : Monday bit 2 : Tuesday bit 3 : Wednesday bit 4 : Thursday bit 5 : Friday bit 6 : Saturday bit 7 : Not used (normal value of 0).</p>	No signal output available
U5-79 (3B9A)	PID Feedback Backup	<p><b>V/f</b> <b>OLV/IPM</b> <b>EZOLV</b></p> <p>Shows the <i>PID Feedback Backup [H3-xx = 24]</i> signal that the drive uses when it loses the <i>PID Feedback [H3-xx = B]</i>.</p> <p>Unit: 0.01%</p> <p><b>Note:</b> Parameters <i>b5-46 [PID Unit Display Selection]</i>, <i>b5-38 [PID User Unit Display Scaling]</i>, and <i>b5-39 [PID User Unit Display Digits]</i> set the unit, scaling, and resolution.</p>	No signal output available
U5-81 (3B9C)	Diff Level Source	<p><b>V/f</b> <b>OLV/IPM</b> <b>EZOLV</b></p> <p>Shows the Differential Feedback signal from the terminal set for <i>H3-xx = 2D [Differential Level Source]</i>.</p> <p>Unit: 0.00%</p> <p><b>Note:</b> Parameters <i>b5-46 [PID Unit Display Selection]</i>, <i>b5-38 [PID User Unit Display Scaling]</i>, and <i>b5-39 [PID User Unit Display Digits]</i> set the unit, scaling, and resolution.</p>	No signal output available
U5-99 (1599)	Setpoint	<p><b>V/f</b> <b>OLV/IPM</b> <b>EZOLV</b></p> <p>Shows the PID setpoint command.</p> <p>Unit: 0.01%</p> <p><b>Note:</b> Parameters <i>b5-46 [PID Unit Display Selection]</i>, <i>b5-38 [PID User Unit Display Scaling]</i>, and <i>b5-39 [PID User Unit Display Digits]</i> set the unit, scaling, and resolution.</p>	10 V = Maximum frequency

## ◆ U6: Operation Status Monitors

No. (Hex.)	Name	Description	MFAO Signal Level
U6-01 (0051)	Iq Secondary Current	<p><b>V/f</b> <b>OLV/IPM</b> <b>EZOLV</b></p> <p>Shows the value calculated for the motor secondary current (q-Axis) as a percentage of the motor rated secondary current.</p> <p>Unit: 0.1%</p>	10 V: Motor secondary rated current
U6-02 (0052)	Id ExcitationCurrent	<p><b>V/f</b> <b>OLV/IPM</b> <b>EZOLV</b></p> <p>Shows the value calculated for the motor excitation current (d-Axis) as a percentage of the motor rated secondary current.</p> <p>Unit: 0.1%</p>	10 V: Motor secondary rated current

No. (Hex.)	Name	Description	MFAO Signal Level
U6-03 (0054)	ASR Input	<input type="checkbox"/> V/f <input type="checkbox"/> OLV/PM <input checked="" type="checkbox"/> EZOLV Shows the ASR input value as a percentage of the maximum frequency. Unit: 0.01%	10 V: Maximum frequency
U6-04 (0055)	ASR Output	<input type="checkbox"/> V/f <input type="checkbox"/> OLV/PM <input checked="" type="checkbox"/> EZOLV Shows the ASR output value as a percentage of the motor rated secondary current. Unit: 0.01%	10 V: Motor secondary rated current
U6-05 (0059)	OutputVoltageRef: Vq	<input type="checkbox"/> V/f <input type="checkbox"/> OLV/PM <input checked="" type="checkbox"/> EZOLV Shows the drive internal voltage reference for motor secondary current control (q-Axis). Unit: 0.1 V	208 V class: 10 V = 200 Vrms 480 V class: 10 V = 400 Vrms
U6-06 (005A)	OutputVoltageRef: Vd	<input type="checkbox"/> V/f <input type="checkbox"/> OLV/PM <input checked="" type="checkbox"/> EZOLV Shows the drive internal voltage reference for motor excitation current control (d-Axis). Unit: 0.1 V	208 V class: 10 V = 200 Vrms 480 V class: 10 V = 400 Vrms
U6-10 (07C1) Expert	ContAxisDeviation Δθ	<input type="checkbox"/> V/f <input type="checkbox"/> OLV/PM <input checked="" type="checkbox"/> EZOLV Shows the deviation between the γδ-Axis that the drive uses for motor control and the dq-Axis. Unit: 0.1 °	5 V: 180 °
U6-14 (07CB) Expert	MagPolePosition(Obs)	<input type="checkbox"/> V/f <input type="checkbox"/> OLV/PM <input checked="" type="checkbox"/> EZOLV Shows the value of the flux position estimation. Unit: 0.1 °	10 V: 180 °
U6-17 (07D1) Expert	Energy Save Coeff	<input checked="" type="checkbox"/> V/f <input type="checkbox"/> OLV/PM <input type="checkbox"/> EZOLV Shows the total time of direction of motor rotation detections for Speed Estimation Speed Searches. This value adjusts b3-26 [Direction Determination Level]. <b>Note:</b> Upper limit is +32767 and lower limit is -32767.	No signal output available
U6-21 (07D5)	Offset Frequency	<input type="checkbox"/> V/f <input type="checkbox"/> OLV/PM <input checked="" type="checkbox"/> EZOLV Shows the total value of d7-01 to d7-03 [Offset Frequency 1 to 3] selected with Add Offset Frequency 1 to 3 [H1-xx = 44 to 46]. Unit: 0.1%	10 V: Maximum Frequency
U6-31 (007B)	TorqueDetect Monitor	<input type="checkbox"/> V/f <input type="checkbox"/> OLV/PM <input checked="" type="checkbox"/> EZOLV Monitors the torque reference or the output current after applying the filter. Unit: 0.1%	10 V:100%
U6-36 (0720) Expert	Comm Errors-Host	<input type="checkbox"/> V/f <input type="checkbox"/> OLV/PM <input checked="" type="checkbox"/> EZOLV Shows the number of inter-CPU communication errors. When you de-energize the drive, this value resets to 0.	No signal output available
U6-37 (0721) Expert	Comm Errors-Sensor	<input type="checkbox"/> V/f <input type="checkbox"/> OLV/PM <input checked="" type="checkbox"/> EZOLV Shows the number of inter-CPU communication errors. When you de-energize the drive, this value resets to 0.	No signal output available
U6-57 (07C4)	PolePolarityDeterVal	<input type="checkbox"/> V/f <input type="checkbox"/> OLV/PM <input checked="" type="checkbox"/> EZOLV Shows the change from the integrated current when the drive finds the polarity. Unit: 1 <b>Note:</b> If the change from the integrated current is less than 819, increase n8-84 [Polarity Detection Current]. U6-57 = 8192 is equivalent to the motor rated current.	No signal output available
U6-80 (07B0)	Option IP Address 1	<input type="checkbox"/> V/f <input type="checkbox"/> OLV/PM <input checked="" type="checkbox"/> EZOLV Shows the currently available local IP Address (1st octet).	No signal output available
U6-81 (07B1)	Option IP Address 2	<input type="checkbox"/> V/f <input type="checkbox"/> OLV/PM <input checked="" type="checkbox"/> EZOLV Shows the currently available local IP Address (2nd octet).	No signal output available
U6-82 (07B2)	Option IP Address 3	<input type="checkbox"/> V/f <input type="checkbox"/> OLV/PM <input checked="" type="checkbox"/> EZOLV Shows the currently available local IP Address (3rd octet).	No signal output available
U6-83 (07B3)	Option IP Address 4	<input type="checkbox"/> V/f <input type="checkbox"/> OLV/PM <input checked="" type="checkbox"/> EZOLV Shows the currently available local IP Address (4th octet).	No signal output available
U6-84 (07B4)	Online Subnet 1	<input type="checkbox"/> V/f <input type="checkbox"/> OLV/PM <input checked="" type="checkbox"/> EZOLV Shows the currently available subnet mask (1st octet).	No signal output available
U6-85 (07B5)	Online Subnet 2	<input type="checkbox"/> V/f <input type="checkbox"/> OLV/PM <input checked="" type="checkbox"/> EZOLV Shows the currently available subnet mask (2nd octet).	No signal output available
U6-86 (07B6)	Online Subnet 3	<input type="checkbox"/> V/f <input type="checkbox"/> OLV/PM <input checked="" type="checkbox"/> EZOLV Shows the currently available subnet mask (3rd octet).	No signal output available

No. (Hex.)	Name	Description	MFAO Signal Level
U6-87 (07B7)	Online Subnet 4	<b>V/f</b> <b>OLV/IPM</b> <b>EZOLV</b> Shows the currently available subnet mask (4th octet).	No signal output available
U6-88 (07B8)	Online Gateway 1	<b>V/f</b> <b>OLV/IPM</b> <b>EZOLV</b> Shows the currently available Gateway address (1st octet).	No signal output available
U6-89 (07B9)	Online Gateway 2	<b>V/f</b> <b>OLV/IPM</b> <b>EZOLV</b> Shows the currently available Gateway address (2nd octet).	No signal output available
U6-90 (07F0)	Online Gateway 3	<b>V/f</b> <b>OLV/IPM</b> <b>EZOLV</b> Shows the currently available Gateway address (3rd octet).	No signal output available
U6-91 (07F1)	Online Gateway 4	<b>V/f</b> <b>OLV/IPM</b> <b>EZOLV</b> Shows the currently available Gateway address (4th octet).	No signal output available
U6-92 (07F2)	Online Speed	<b>V/f</b> <b>OLV/IPM</b> <b>EZOLV</b> Shows the currently available communications speed. 10: 10 Mbps 100: 100 Mbps	No signal output available
U6-93 (07F3)	Online Duplex	<b>V/f</b> <b>OLV/IPM</b> <b>EZOLV</b> Shows the currently available Duplex setting.	No signal output available
U6-98 (07F8)	First Fault	<b>V/f</b> <b>OLV/IPM</b> <b>EZOLV</b> Shows the contents of the most recent communication options fault (Modbus TCP/IP, EtherNet/IP).	No signal output available
U6-99 (07F9)	Current Fault	<b>V/f</b> <b>OLV/IPM</b> <b>EZOLV</b> Shows the contents of current fault from communication options (Modbus TCP/IP, EtherNet/IP).	No signal output available

## ◆ U8: DriveWorksEZ Monitors

No. (Hex.)	Name	Description	MFAO Signal Level
U8-01 (1950)	DWEZ Monitor 1	<b>V/f</b> <b>OLV/IPM</b> <b>EZOLV</b> Shows DWEZ Monitor 1. (Display range: 0.00% to 999.99%) Unit: 0.01%	10 V = 100%
U8-02 (1951)	DWEZ Monitor 2	<b>V/f</b> <b>OLV/IPM</b> <b>EZOLV</b> Shows DWEZ Monitor 2. (Display range: 0.00% to 999.99%) Unit: 0.01%	10 V = 100%
U8-03 (1952)	DWEZ Monitor 3	<b>V/f</b> <b>OLV/IPM</b> <b>EZOLV</b> Shows DWEZ Monitor 3. (Display range: 0.00% to 999.99%) Unit: 0.01%	10 V = 100%
U8-04 (1953)	DWEZ Monitor 4	<b>V/f</b> <b>OLV/IPM</b> <b>EZOLV</b> Shows DWEZ Monitor 4. (Display range: 0.00% to 999.99%) Unit: 0.01%	10 V = 100%
U8-05 (1954)	DWEZ Monitor 5	<b>V/f</b> <b>OLV/IPM</b> <b>EZOLV</b> Shows DWEZ Monitor 5. (Display range: 0.00% to 999.99%) Unit: 0.01%	10 V = 100%
U8-06 (1955)	DWEZ Monitor 6	<b>V/f</b> <b>OLV/IPM</b> <b>EZOLV</b> Shows DWEZ Monitor 6. (Display range: 0.00% to 999.99%) Unit: 0.01%	10 V = 100%
U8-07 (1956)	DWEZ Monitor 7	<b>V/f</b> <b>OLV/IPM</b> <b>EZOLV</b> Shows DWEZ Monitor 7. (Display range: -999.9% to +999.99%) Unit: 0.01%	10 V = 100%
U8-08 (1957)	DWEZ Monitor 8	<b>V/f</b> <b>OLV/IPM</b> <b>EZOLV</b> Shows DWEZ Monitor 8. (Display range: -999.9% to +999.99%) Unit: 0.01%	10 V = 100%
U8-09 (1958)	DWEZ Monitor 9	<b>V/f</b> <b>OLV/IPM</b> <b>EZOLV</b> Shows DWEZ Monitor 9. (Display range: -999.9% to +999.99%) Unit: 0.01%	10 V = 100%
U8-10 (1959)	DWEZ Monitor 10	<b>V/f</b> <b>OLV/IPM</b> <b>EZOLV</b> Shows DWEZ Monitor 10.	No signal output available

No. (Hex.)	Name	Description	MFAO Signal Level
U8-11 (195A)	DWEZ Version 1	<b>V/f</b> <b>OLV/PM</b> <b>EZOLV</b> Shows the Upper three digits of the user ID. When you click the setting button on the title bar of the PC tool to open the setting screen, you can confirm the user ID with the primary user ID display.	No signal output available
U8-12 (195B)	DWEZ Version 2	<b>V/f</b> <b>OLV/PM</b> <b>EZOLV</b> Shows the lower five digits of the user ID. When you click the setting button on the title bar of the PC tool to open the setting screen, you can confirm the user ID with the primary user ID display.	No signal output available
U8-13 (195C)	DWEZ Version 3	<b>V/f</b> <b>OLV/PM</b> <b>EZOLV</b> Shows the software ID.	No signal output available
U8-18 (1961)	DWEZ Platform Ver	<b>V/f</b> <b>OLV/PM</b> <b>EZOLV</b> Shows the DriveWorksEZ platform version.	No signal output available
U8-21 (1964)	DWEZ Monitor 21	<b>V/f</b> <b>OLV/PM</b> <b>EZOLV</b> Shows DWEZ Monitor 21. (Display range: -999.9% to +999.99%) Unit: 0.01%	10 V = 100%
U8-22 (1965)	DWEZ Monitor 22	<b>V/f</b> <b>OLV/PM</b> <b>EZOLV</b> Shows DWEZ Monitor 22. Unit: The number of decimal points shown is set with Q2-21.	10 V = 100%
U8-23 (1966)	DWEZ Monitor 23	<b>V/f</b> <b>OLV/PM</b> <b>EZOLV</b> Shows DWEZ Monitor 23. Unit: The number of decimal points shown is set with Q2-22.	10 V = 100%
U8-24 (1967)	DWEZ Monitor 24	<b>V/f</b> <b>OLV/PM</b> <b>EZOLV</b> Shows DWEZ Monitor 24. Unit: The number of decimal points shown is set with Q2-23.	10 V = 100%
U8-25 (1968)	DWEZ Monitor 25	<b>V/f</b> <b>OLV/PM</b> <b>EZOLV</b> Shows DWEZ Monitor 25. Unit: The number of decimal points shown is set with Q2-24.	10 V = 100%
U8-31 (196E)	DWEZ Monitor 31	<b>V/f</b> <b>OLV/PM</b> <b>EZOLV</b> Shows DWEZ Monitor 31. (Display range: 0.00% to 999.99%) Unit: 0.01%	10 V = 100%
U8-32 (196F)	DWEZ Monitor 32	<b>V/f</b> <b>OLV/PM</b> <b>EZOLV</b> Shows DWEZ Monitor 32. (Display range: 0.00% to 999.99%) Unit: 0.01%	10 V = 100%
U8-33 (1970)	DWEZ Monitor 33	<b>V/f</b> <b>OLV/PM</b> <b>EZOLV</b> Shows DWEZ Monitor 33. (Display range: 0.00% to 999.99%) Unit: 0.01%	10 V = 100%
U8-34 (1971)	DWEZ Monitor 34	<b>V/f</b> <b>OLV/PM</b> <b>EZOLV</b> Shows DWEZ Monitor 34. (Display range: 0.00% to 999.99%) Unit: 0.01%	10 V = 100%
U8-35 (1972)	DWEZ Monitor 35	<b>V/f</b> <b>OLV/PM</b> <b>EZOLV</b> Shows DWEZ Monitor 35. (Display range: 0.00% to 999.99%) Unit: 0.01%	10 V = 100%
U8-36 (1973)	DWEZ Monitor 36	<b>V/f</b> <b>OLV/PM</b> <b>EZOLV</b> Shows DWEZ Monitor 36. (Display range: 0.00% to 999.99%) Unit: 0.01%	10 V = 100%
U8-37 (1974)	DWEZ Monitor 37	<b>V/f</b> <b>OLV/PM</b> <b>EZOLV</b> Shows DWEZ Monitor 37. (Display range: -999.9% to +999.99%) Unit: 0.01%	10 V = 100%
U8-38 (1975)	DWEZ Monitor 38	<b>V/f</b> <b>OLV/PM</b> <b>EZOLV</b> Shows DWEZ Monitor 38. (Display range: -999.9% to +999.99%) Unit: 0.01%	10 V = 100%
U8-39 (1976)	DWEZ Monitor 39	<b>V/f</b> <b>OLV/PM</b> <b>EZOLV</b> Shows DWEZ Monitor 39. (Display range: -999.9% to +999.99%) Unit: 0.01%	10 V = 100%
U8-40 (1977)	DWEZ Monitor 40	<b>V/f</b> <b>OLV/PM</b> <b>EZOLV</b> Shows DWEZ Monitor 40.	No signal output available
U8-51 (1982)	DWEZ Monitor 51	<b>V/f</b> <b>OLV/PM</b> <b>EZOLV</b> Shows DWEZ Monitor 51. (Display range: -999.9% to +999.99%) Unit: 0.01%	10 V = 100%

## 11.18 U: Monitors

No. (Hex.)	Name	Description	MFAO Signal Level
U8-52 (1983)	DWEZ Monitor 52	<p><b>V/f</b> <b>OLV/IPM</b> <b>EZOLV</b></p> <p>Shows DWEZ Monitor 52. Unit: The number of decimal points shown is set with Q2-41.</p>	10 V = 100%
U8-53 (1984)	DWEZ Monitor 53	<p><b>V/f</b> <b>OLV/IPM</b> <b>EZOLV</b></p> <p>Shows DWEZ Monitor 53. Unit: The number of decimal points shown is set with Q2-42.</p>	10 V = 100%
U8-54 (1985)	DWEZ Monitor 54	<p><b>V/f</b> <b>OLV/IPM</b> <b>EZOLV</b></p> <p>Shows DWEZ Monitor 54. Unit: The number of decimal points shown is set with Q2-43.</p>	10 V = 100%
U8-55 (1986)	DWEZ Monitor 55	<p><b>V/f</b> <b>OLV/IPM</b> <b>EZOLV</b></p> <p>Shows DWEZ Monitor 55. Unit: The number of decimal points shown is set with Q2-44.</p>	10 V = 100%
U8-60 (198B)	RemoteIO Status	<p><b>V/f</b> <b>OLV/IPM</b> <b>EZOLV</b></p> <p>Shows the operation status of Remote IO as 1 (ON) and 0 (OFF). If the DriveWorksEZ MEMOBUS master active signal is ON, for example, the monitor shows <i>U8-60 = 00000001</i>.</p> <p>bit 0 : Bit 0: DriveWorksEZ MEMOBUS Master Active bit 1 : Not used (normal value of 0) bit 2 : Not used (normal value of 0) bit 3 : Not used (normal value of 0) bit 4 : Not used (normal value of 0) bit 5 : Not used (normal value of 0) bit 6 : Not used (normal value of 0) bit 7 : Not used (normal value of 0)</p>	No signal output available
U8-61 (198C)	RemoteDI Monitor 0-7bit	<p><b>V/f</b> <b>OLV/IPM</b> <b>EZOLV</b></p> <p>Shows the operation status of Remote DI1 to DI8 as 1 (ON) and 0 (OFF). If Remote DI1 and DI2 are ON, for example, the monitor shows <i>U8-61 = 00000011</i>.</p> <p>bit 0 : Remote DI1 bit 1 : Remote DI2 bit 2 : Remote DI3 bit 3 : Remote DI4 bit 4 : Remote DI5 bit 5 : Remote DI6 bit 6 : Remote DI7 bit 7 : Remote DI8</p>	No signal output available
U8-62 (198D)	RemoteDI Monitor 8-Fbit	<p><b>V/f</b> <b>OLV/IPM</b> <b>EZOLV</b></p> <p>Shows the operation status of Remote DI9 to DI16 as 1 (ON) and 0 (OFF). If Remote DI9 and DI10 are ON, for example, the monitor shows <i>U8-62 = 00000011</i>.</p> <p>bit 0 : Remote DI9 bit 1 : Remote DI10 bit 2 : Remote DI11 bit 3 : Remote DI12 bit 4 : Remote DI13 bit 5 : Remote DI14 bit 6 : Remote DI15 bit 7 : Remote DI16</p>	No signal output available

No. (Hex.)	Name	Description	MFAO Signal Level
U8-63 (198E)	RemoteDO Monitor 0-7bit	<p><b>V/f</b> <b>OLV/PM</b> <b>EZOLV</b></p> <p>Shows the operation status of Remote DO1 to DO8 as 1 (ON) and 0 (OFF). If Remote DO1 and DO2 are ON, for example, the monitor shows <i>U8-63 = 00000011</i>.</p> <p>bit 0 : Remote DO1 bit 1 : Remote DO2 bit 2 : Remote DO3 bit 3 : Remote DO4 bit 4 : Remote DO5 bit 5 : Remote DO6 bit 6 : Remote DO7 bit 7 : Remote DO8</p>	No signal output available
U8-64 (198F)	RemoteDO Monitor 8-Fbit	<p><b>V/f</b> <b>OLV/PM</b> <b>EZOLV</b></p> <p>Shows the operation status of Remote DO9 to DO16 as 1 (ON) and 0 (OFF). If Remote DO9 and DO10 are ON, for example, the monitor shows <i>U8-64 = 00000011</i>.</p> <p>bit 0 : Remote DO9 bit 1 : Remote DO10 bit 2 : Remote DO11 bit 3 : Remote DO12 bit 4 : Remote DO13 bit 5 : Remote DO14 bit 6 : Remote DO15 bit 7 : Remote DO16</p>	No signal output available

### ◆ UA: Network Multiplexing

No. (Hex.)	Name	Description	MFAO Signal Level
UA-01 (1EC1)	Network PID Feedback	<p><b>V/f</b> <b>OLV/PM</b> <b>EZOLV</b></p> <p>Shows the Network PID Feedback recognized by the MEMOBUS Network.</p> <p><b>Note:</b> Parameters <i>b5-46 [PID Unit Display Selection]</i>, <i>b5-38 [PID User Unit Display Scaling]</i>, and <i>b5-39 [PID User Unit Display Digits]</i> set the unit, range, and resolution. Unit: 0.01%</p>	No signal output available
UA-02 (1EC2)	Network Activity	<p><b>V/f</b> <b>OLV/PM</b> <b>EZOLV</b></p> <p>Shows network traffic. When this number changes between 0.0% to 100.0%, there is activity. When the number stays near 0.0%, there is no activity.</p> <p>The unit is followed by an identifier that changes as specified by network status:</p> <ul style="list-style-type: none"> <li>&lt;-&gt;: Drive cannot communicate to other drives</li> <li>&lt;+&gt;: Drive is a Node on a network</li> <li>&lt;M&gt;: Drive is the Master on an Network</li> </ul> <p>Unit: 0.1%</p>	No signal output available
UA-03 (1EC3)	Time to Alternation	<p><b>V/f</b> <b>OLV/PM</b> <b>EZOLV</b></p> <p>Shows the how much time until the drive requests alternation. This is specified in <i>Y9-04 [Alternation Mode]</i>.</p> <p>Unit: 1 min</p>	No signal output available
UA-04 (1EC4)	Running Queue No	<p><b>V/f</b> <b>OLV/PM</b> <b>EZOLV</b></p> <p>Shows the position in the MEMOBUS Multiplex Running Queue.</p>	No signal output available

### ◆ UC: BACnet Diagnostic Monitors

No. (Hex.)	Name	Description	MFAO Signal Level
UC-01 (3DB0)	BN MSTP Net Health	<p><b>V/f</b> <b>OLV/PM</b> <b>EZOLV</b></p> <p>Shows a number between 0.0% and 100.0% that identifies the health of the MSTP network. This number is dependent on the number of CRC errors, token losses, token retries, and net deadtime perceived.</p> <p>Unit: 0.1%</p>	No signal output available
UC-02 (3DB1)	BACnet Tokens Rx	<p><b>V/f</b> <b>OLV/PM</b> <b>EZOLV</b></p> <p>Shows the number of received MSTP Tokens after you energize the drive.</p> <p>Unit: 1</p>	No signal output available

## 11.18 U: Monitors

No. (Hex.)	Name	Description	MFAO Signal Level
UC-03 (3DB2)	BACnet Tokens Tx	<b>V/f</b> <b>OLV/IPM</b> <b>EZOLV</b> Shows the number of transmitted MSTP Tokens after you energize the drive. Unit: 1	No signal output available
UC-04 (3DB3)	BACnet Messages Rx	<b>V/f</b> <b>OLV/IPM</b> <b>EZOLV</b> Shows the number of messages with data (non-token, non-polling) received by the drive. Unit: 1	No signal output available
UC-05 (3DB4)	BACnet Messages Tx	<b>V/f</b> <b>OLV/IPM</b> <b>EZOLV</b> Shows the number of messages with data (non-token, non-polling) transmitted by the drive. Unit: 1	No signal output available
UC-06 (3DB5)	MSTP Next Node Addr	<b>V/f</b> <b>OLV/IPM</b> <b>EZOLV</b> Shows the next known node in the MSTP loop. This is the node to which the drive will pass the token.	No signal output available
UC-07 (3DB6)	MSTP Prev Node Addr	<b>V/f</b> <b>OLV/IPM</b> <b>EZOLV</b> Shows the previous known node in the MSTP loop. This is the node from which the drive received the token.	No signal output available
UC-08 (3DB7)	MSTP H MAC Found	<b>V/f</b> <b>OLV/IPM</b> <b>EZOLV</b> Shows the highest MAC address found on the network. This will report the highest value MAC address to which the token was passed by any node on the MSTP loop.	No signal output available
UC-09 (3DB8)	MSTP L MAC Found	<b>V/f</b> <b>OLV/IPM</b> <b>EZOLV</b> Shows the lowest MAC address found on the network. This will report the lowest value MAC address to which the token was passed by any node on the MSTP loop.	No signal output available
UC-10 (3DB9)	MSTP # Nodes Found	<b>V/f</b> <b>OLV/IPM</b> <b>EZOLV</b> Shows the number of unique nodes that transmitted a token on the local MSTP loop. Unit: 1	No signal output available
UC-11 (3DBA)	# of BN COV Sbscript	<b>V/f</b> <b>OLV/IPM</b> <b>EZOLV</b> Shows the number of COV subscriptions requested by the nodes on the BACnet network. This is limited to the number of objects that support COV subscriptions. Unit: 1	No Signal output available
UC-12 (3DBB)	MSTP Loop Tlme	<b>V/f</b> <b>OLV/IPM</b> <b>EZOLV</b> Shows the number of milliseconds between drive transmitted token and drive token received, showing how long the MSTP loop took to pass the token to all nodes on the MSTP network. Unit: 1 ms	No signal output available
UC-13 (3DBC)	BN MSTP CRC Errors	<b>V/f</b> <b>OLV/IPM</b> <b>EZOLV</b> Shows the number of CRC errors detected after you energize the drive. Unit: 1	No signal output available
UC-14 (3DBD)	BN MSTP Tokens Lost	<b>V/f</b> <b>OLV/IPM</b> <b>EZOLV</b> Shows the number of token losses seen by the unit since power-on. This is sensed by a net deadtime of greater than 500 ms. Unit: 1	No signal output available
UC-15 (3DBE)	BN MSTP Tokens Retry	<b>V/f</b> <b>OLV/IPM</b> <b>EZOLV</b> Shows the number of token retries seen by the unit since power-on. This is sensed by two subsequent token frames seen from the same node to the same node with the same CRC. Unit: 1	No signal output available
UC-16 (3DBF)	BN MSTP Silence Avg	<b>V/f</b> <b>OLV/IPM</b> <b>EZOLV</b> Shows the average net deadtime (space between active messages), averaged over a 60 packet period. Unit: 1.0 ms	No signal output available



# 11.19 Y: Application Features

## ◆ Y1: Application Basics

No. (Hex.)	Name	Description	Default (Range)	Ref.
Y1-01 (3C00)	Multiplex Mode	<b>V/f</b> <b>OLV/PM</b> <b>EZOLV</b> Sets the base operation mode of the drive controller. 0 : Drive Only 3 : Memobus Network	0 (0, 3)	917
Y1-04 (3C03) RUN	Sleep Wake-up Level	<b>V/f</b> <b>OLV/PM</b> <b>EZOLV</b> Sets the level that feedback must be less than for the time set in Y1-05 [Sleep Wake-up Level Delay Time] to start the system. This level also sets the wake up level when the drive is in Sleep Mode. When Y1-04 < 0, the feedback level must decrease this amount to less than the setpoint. <b>Note:</b> • When PID operates in reverse mode, the feedback value must increase to more than the start level for the time set in Y1-05 for the system to start. • When Y2-01 = 5 [Sleep Level Type = Output Frequency (non-PID)], the drive will ignore this parameter. • When Y1-01 = 3 [Multiplex Mode = Memobus Network], function is active only on the first drive in the network. Drives that are staging or in alternation will not undergo this process. • Set this parameter to 0.0 to disable the function. • Range is 0.00 to 99.99 with a delta symbol (Δ) to identify Delta to Setpoint. • Display unit and scaling change when the system units change.	0.0% (0.00 - 99.99%)	917
Y1-05 (3C04) RUN	Sleep Wake-up Level Delay Time	<b>V/f</b> <b>OLV/PM</b> <b>EZOLV</b> Sets the drive to start the System again when the feedback decreases to less than Y1-04 [Sleep Wake-up Level] for the time set in this parameter.	1 s (0 - 3600 s)	917
Y1-06 (3C05) RUN	Minimum Speed	<b>V/f</b> <b>OLV/PM</b> <b>EZOLV</b> Sets the minimum frequency at which the drive will run. The drive applies this setting to HAND and AUTO modes. <b>Note:</b> • The unit, decimal place, and setting range change when the Y1-07 [Minimum Speed Units] setting changes: –Y1-07 = 0 [Hz]: The setting range is 0.0 Hz to E1-04 Hz. –Y1-07 = 1 [RPM]: The setting range is 0 RPM to (E1-04 × 60) RPM. • When A1-02 = 8 [Control Method Selection = EZ Vector Control], the range is 0.0 Hz to (E9-02 × 2) Hz.	0.0 Hz Determined by Y1-07	917
Y1-07 (3C06)	Minimum Speed Units	<b>V/f</b> <b>OLV/PM</b> <b>EZOLV</b> Sets the units and decimal place for Y1-06 [Minimum Speed]. 0 : Hz 1 : RPM <b>Note:</b> Changing Y1-07 will set Y1-06 [Minimum Speed] to the default value.	0 (0, 1)	918
Y1-08 (3C07) RUN	Low Feedback Level	<b>V/f</b> <b>OLV/PM</b> <b>EZOLV</b> Sets the lower detection level for the PID feedback. <b>Note:</b> • Parameters b5-46 [PID Unit Display Selection], b5-38 [PID User Unit Display Scaling], and b5-39 [PID User Unit Display Digits] set the unit, scaling, and resolution. • Range is 0.00 to 99.99 with a delta symbol (Δ) to identify Delta to Setpoint.	0.00% (0.00 - 99.99%)	918
Y1-09 (3C08) RUN	Low Feedback Lvl Fault Dly Time	<b>V/f</b> <b>OLV/PM</b> <b>EZOLV</b> Sets the delay time for the drive to detect an LFB [Low Feedback Sensed] fault after the feedback level decreases to less than the value set in Y1-08 [Low Feedback Level]. <b>Note:</b> • Set Y1-10 = 0 [Low Feedback Selection = Fault (and Digital Output)] to enable this parameter. • When Y1-01 = 3 [Multiplex Mode = Memobus Network], Y9-18 [Staging Mode] uses this value to calculate the quick de-stage feedback level.	10 s (0 - 3600 s)	918
Y1-10 (3C09)	Low Feedback Selection	<b>V/f</b> <b>OLV/PM</b> <b>EZOLV</b> Sets the drive response when the feedback decreases to less than Y1-08 [Low Feedback Level] for longer than the time set in Y1-09 [Low Feedback Lvl Fault Dly Time]. 0 : Fault (and Digital Output) 1 : Alarm (and Digital Output) 2 : Digital Output Only	0 (0 - 2)	918

## 11.19 Y: Application Features

No. (Hex.)	Name	Description	Default (Range)	Ref.
Y1-11 (3C0A) RUN	High Feedback Level	<p><b>V/f</b> <b>OLV/PM</b> <b>EZOLV</b></p> <p>Sets the upper detection level for the PID feedback.</p> <p><b>Note:</b></p> <ul style="list-style-type: none"> <li>Parameters <i>b5-46 [PID Unit Display Selection]</i>, <i>b5-38 [PID User Unit Display Scaling]</i>, and <i>b5-39 [PID User Unit Display Digits]</i> set the unit, scaling, and resolution.</li> <li>Range is 0.00 to 99.99 with a delta symbol (<math>\Delta</math>) to identify Delta to Setpoint.</li> </ul>	0.00% (0.00 - 99.99%)	919
Y1-12 (3C0B) RUN	High Feedback Lvl Fault Dly Time	<p><b>V/f</b> <b>OLV/PM</b> <b>EZOLV</b></p> <p>Sets the delay time between when the drive detects high feedback until the drive faults on an <i>HFB [High Feedback Sensed]</i> fault.</p> <p><b>Note:</b></p> <p>This parameter is effective only when <i>Y1-13 = 0 [High Feedback Selection = Fault (and Digital Output)]</i>.</p>	5 s (0 - 3600 s)	919
Y1-13 (3C0C)	High Feedback Selection	<p><b>V/f</b> <b>OLV/PM</b> <b>EZOLV</b></p> <p>Sets the drive response when the feedback increased to more than <i>Y1-11 [High Feedback Level]</i> for longer than the time set in <i>Y1-12 [High Feedback Lvl Fault Dly Time]</i>.</p> <p>0 : Fault (and Digital Output) 1 : Alarm (and Digital Output) 2 : Digital Output Only</p>	0 (0 - 2)	919
Y1-14 (3C0D) RUN	Feedback Hysteresis Level	<p><b>V/f</b> <b>OLV/PM</b> <b>EZOLV</b></p> <p>Sets the hysteresis level for low and high level feedback detection.</p> <p><b>Note:</b></p> <p>Parameters <i>b5-46 [PID Unit Display Selection]</i>, <i>b5-38 [PID User Unit Display Scaling]</i>, and <i>b5-39 [PID User Unit Display Digits]</i> set the unit, scaling, and resolution.</p>	0.0% (0.0 - 10.00%)	920
Y1-15 (3C0E) RUN	Maximum Setpoint Difference	<p><b>V/f</b> <b>OLV/PM</b> <b>EZOLV</b></p> <p>Sets a percentage of difference between the setpoint and the feedback. The difference must be more than this value for the time set in <i>Y1-16 [Not Maintaining Setpoint Time]</i> to trigger the drive response set in <i>Y1-17 [Not Maintaining Setpoint Sel]</i>.</p> <p><b>Note:</b></p> <ul style="list-style-type: none"> <li>Unit and decimal place change when the system units change.</li> <li>If there is a fault, the drive will coast to a stop.</li> <li>Set this parameter to 0.0 to disable the function.</li> <li>This function is only active during run when in Auto Mode.</li> <li>When <i>Y1-01 = 3 [Multiplex Mode = Memobus Network]</i>, the function is active on the lead drive, but will stop all drives running on the network if there is an <i>NMS [Setpoint Not Met]</i> fault (system fault).</li> </ul>	0.0% (0.0 - 6000.0%)	920
Y1-16 (3C0F) RUN	Not Maintaining Setpoint Time	<p><b>V/f</b> <b>OLV/PM</b> <b>EZOLV</b></p> <p>Sets the delay time before a Setpoint Not Met condition occurs. The drive must detect the setpoint difference set in <i>Y1-15 [Maximum Setpoint Difference]</i> before the timer will start.</p> <p><b>Note:</b></p> <p>Set <i>Y1-15 = 0 [Maximum Setpoint Difference = 0]</i> to disable this function.</p>	60 s (0 - 3600 s)	920
Y1-17 (3C10)	Not Maintaining Setpoint Sel	<p><b>V/f</b> <b>OLV/PM</b> <b>EZOLV</b></p> <p>Sets the drive response when the feedback increases to more or decreases to less than the setpoint for more than the amount set in <i>Y1-15 [Maximum Setpoint Difference]</i>.</p> <p>0 : Fault (and Digital Output) 1 : Alarm (and Digital Output) 2 : Digital Output Only</p>	0 (0 - 2)	920
Y1-18 (3C11)	Prime Loss Detection Method	<p><b>V/f</b> <b>OLV/PM</b> <b>EZOLV</b></p> <p>Sets the units and quantity that the drive will use to determine <i>LOP [Loss of Prime]</i>.</p> <p>0 : Current (A) 1 : Power (kW) 2 : Torque (%)</p>	0 (0 - 2)	921
Y1-19 (3C12) RUN	Prime Loss Level	<p><b>V/f</b> <b>OLV/PM</b> <b>EZOLV</b></p> <p>Sets the level to detect the <i>LOP [Loss of Prime]</i> in the pump when in Auto or Sleep Boost Mode.</p> <p><b>Note:</b></p> <p><i>Y1-18 [Prime Loss Detection Method]</i> selection sets the units for this parameter.</p>	0.0 (0.0 - 1000.0)	921
Y1-20 (3C13) RUN	Prime Loss Time	<p><b>V/f</b> <b>OLV/PM</b> <b>EZOLV</b></p> <p>Sets the delay time before the drive detects an <i>LOP [Loss of Prime]</i> condition. The timer starts when the drive detects the conditions in <i>Y1-18 [Prime Loss Detection Method]</i> and <i>Y1-19 [Prime Loss Level]</i>.</p>	20 s (0 - 600 s)	922

No. (Hex.)	Name	Description	Default (Range)	Ref.
Y1-21 (3C14)	Prime Loss Activation Freq	<p><b>V/f</b> <b>OLV/PM</b> <b>EZOLV</b></p> <p>Sets the frequency level above which the drive enables Loss of Prime detection.</p> <p><b>Note:</b></p> <ul style="list-style-type: none"> <li>When <math>A1-02 = 8</math> [Control Method Selection = EZOLV], the upper limit is the Hz equivalent of <math>E9-02</math> [Maximum Speed].</li> <li>When <math>H1-xx = 16</math> [MFDI Function Selection = Motor 2 Selection] for Motor 2, the upper limit is the larger value between <math>E1-04</math> [Maximum Output Frequency] and <math>E3-04</math> [Motor 2 Maximum Output Frequency].</li> </ul>	0.0 Hz (0.0 - E1-04 Hz)	922
Y1-22 (3C15)	Prime Loss Selection	<p><b>V/f</b> <b>OLV/PM</b> <b>EZOLV</b></p> <p>Sets the drive response when the drive is in the Loss of Prime condition.</p> <p>0 : Fault (and Digital Output) 1 : Alarm (and Digital Output) 2 : Digital Output Only</p>	0 (0 - 2)	922
Y1-23 (3C16)	Prime Loss Max Restart Time	<p><b>V/f</b> <b>OLV/PM</b> <b>EZOLV</b></p> <p>Sets the time in minutes that the drive will wait before it tries a restart after a restart fails or after it does not do a restart because of a fault.</p>	0.2 min (0.2 - 6000.0 min)	922
Y1-40 (3C27) RUN	Maximum Speed	<p><b>V/f</b> <b>OLV/PM</b> <b>EZOLV</b></p> <p>Sets the maximum speed.</p> <p><b>Note:</b></p> <p>This parameter is not effective when <math>Y1-40 = 0.0</math> Hz or <math>Y1-40 &gt; E1-04</math> [Maximum Output Frequency] <math>\times</math> <math>d2-01</math> [Frequency Reference Upper Limit].</p>	0.0 Hz (Determined by A1-02)	922

## ◆ Y2: PID Sleep and Protection

No. (Hex.)	Name	Description	Default (Range)	Ref.
Y2-01 (3C64)	Sleep Level Type	<p><b>V/f</b> <b>OLV/PM</b> <b>EZOLV</b></p> <p>Sets the data source that the drive uses to know when to activate the Sleep Function.</p> <p>0 : Output Frequency 1 : Output Current 2 : Feedback 3 : Output Speed (RPM) 5 : Output Frequency (non-PID)</p> <p><b>Note:</b></p> <ul style="list-style-type: none"> <li>Feedback depends on PID direction operation.</li> <li>When the Sleep Function is active, the keypad will show the "Sleep" Alarm.</li> </ul>	5 (0 - 5)	923
Y2-02 (3C65) RUN	Sleep Level	<p><b>V/f</b> <b>OLV/PM</b> <b>EZOLV</b></p> <p>Sets the level that the level type set in <math>Y2-01</math> [Sleep Level Type] must be at for the time set in <math>Y2-03</math> [Sleep Delay Time] for the drive to enter Sleep Mode.</p> <p><b>Note:</b></p> <ul style="list-style-type: none"> <li>When you set this parameter to 0.0, this function will not be active.</li> <li>This function is active only when the drive operates in AUTO Mode.</li> <li>When <math>Y2-01 = 5</math> [Output Frequency (non-PID)], the drive will disable the Sleep function when you set this parameter to 0.0.</li> <li>When <math>Y2-01 \neq 5</math>, the drive will set the sleep level to the largest value from <math>d2-02</math> [Frequency Reference Lower Limit], <math>Y1-06</math> [Minimum Speed], and <math>Y4-12</math> [Thrust Frequency] when you set this parameter to 0.0.</li> </ul>	0.0 (0.0 - 6000.0)	924
Y2-03 (3C66) RUN	Sleep Delay Time	<p><b>V/f</b> <b>OLV/PM</b> <b>EZOLV</b></p> <p>Sets the delay time before the drive enters Sleep Mode when the drive is at the sleep level set in <math>Y2-02</math> [Sleep Level].</p>	5 s (0 - 3600 s)	924
Y2-04 (3C67) RUN	Sleep Activation Level	<p><b>V/f</b> <b>OLV/PM</b> <b>EZOLV</b></p> <p>Sets the level above which the output frequency must increase to activate the Sleep Function when <math>Y2-01 = 0, 3, \text{ or } 5</math> [Sleep Level Type = Output Frequency, Output Speed (RPM), or Output Frequency (non-PID)].</p> <p><b>Note:</b></p> <ul style="list-style-type: none"> <li>When you set this parameter to 0.0, this function will not be active, and the Sleep Function will activate above the minimum speed (largest value from <math>d2-02</math> [Frequency Reference Lower Limit], <math>Y1-06</math> [Minimum Speed], and <math>Y4-12</math> [Thrust Frequency]).</li> <li>The unit for this parameter is usually Hz. When <math>Y2-01 = 3</math> [Sleep Level Type = Output Speed (RPM)], the unit is RPM.</li> </ul>	0.0 (0.0 - 6000.0)	924

No. (Hex.)	Name	Description	Default (Range)	Ref.
Y2-05 (3C68) RUN	Sleep Boost Level	<p><b>V/f</b> <b>OLV/PM</b> <b>EZOLV</b></p> <p>Sets the quantity of boost that the drive applies to the setpoint before it goes to sleep.</p> <p><b>Note:</b></p> <ul style="list-style-type: none"> <li>Parameters <i>b5-46 [PID Unit Display Selection]</i>, <i>b5-38 [PID User Unit Display Scaling]</i>, and <i>b5-39 [PID User Unit Display Digits]</i> set the unit, scaling, and resolution.</li> <li>Set this parameter to 0.00 to disable Sleep Boost Function.</li> </ul>	0.00 (0.00 - 600.00)	924
Y2-06 (3C69) RUN	Sleep Boost Hold Time	<p><b>V/f</b> <b>OLV/PM</b> <b>EZOLV</b></p> <p>Sets the length of time that the drive will keep the boosted pressure before it goes to sleep.</p>	5.0 s (0.5 - 160.0 s)	924
Y2-07 (3C6A) RUN	Sleep Boost Max Time	<p><b>V/f</b> <b>OLV/PM</b> <b>EZOLV</b></p> <p>Sets the length of time that the system (feedback) has to reach the boosted setpoint. The system must reach the boosted setpoint in the time set in this parameter, or it will go to sleep.</p>	20.0 s (1.0 - 160.0 s)	925
Y2-08 (3C6B) RUN	Delta Feedback Drop Level	<p><b>V/f</b> <b>OLV/PM</b> <b>EZOLV</b></p> <p>Sets the level of the PID Error (set-point minus feedback) to deactivate the Sleep Mode operation.</p> <p><b>Note:</b></p> <ul style="list-style-type: none"> <li>Parameters <i>b5-46 [PID Unit Display Selection]</i>, <i>b5-38 [PID User Unit Display Scaling]</i>, and <i>b5-39 [PID User Unit Display Digits]</i> set the unit, scaling, and resolution.</li> <li>Set this parameter to 0.00 to disable the function.</li> </ul>	0.00 (0.00 - 600.00)	925
Y2-09 (3C6C) RUN	Feedback Drop Detection Time	<p><b>V/f</b> <b>OLV/PM</b> <b>EZOLV</b></p> <p>Sets the time during which the software monitors the feedback to detect a flow/no-flow condition. Refer to Y2-08 [<i>Delta Feedback Drop Level</i>] for more information.</p>	10.0 s (0.0 - 3600.0 s)	925
Y2-23 (3C7A) RUN	Anti-No-Flow Bandwidth	<p><b>V/f</b> <b>OLV/PM</b> <b>EZOLV</b></p> <p>Sets the quantity of PI error bandwidth that the drive uses to detect an Anti- No-Flow condition.</p> <p><b>Note:</b></p> <p>Do not set this parameter value too high, because operation can become unstable.</p>	0.00% (0.00 - 2.00%)	925
Y2-24 (3C7B) RUN	Anti-No-Flow Detection Time	<p><b>V/f</b> <b>OLV/PM</b> <b>EZOLV</b></p> <p>Sets the time delay before the drive starts the increased deceleration rate after it detects Anti-No-Flow.</p>	10.0 s (1.0 - 60.0 s)	925
Y2-25 (3C7C) RUN	Anti-No-Flow Release Level	<p><b>V/f</b> <b>OLV/PM</b> <b>EZOLV</b></p> <p>Sets the amount below the setpoint which the feedback must decrease before the drive will disengage Anti-No-Flow and return to normal PI operation.</p> <p><b>Note:</b></p> <p>Parameters <i>b5-46 [PID Unit Display Selection]</i>, <i>b5-38 [PID User Unit Display Scaling]</i>, and <i>b5-39 [PID User Unit Display Digits]</i> set the unit, scaling, and resolution.</p>	0.30% (0.00 - 10.00%)	925

#### ◆ Y4: Application Advanced

No. (Hex.)	Name	Description	Default (Range)	Ref.
Y4-01 (3CFA) RUN	Pre-Charge Level	<p><b>V/f</b> <b>OLV/PM</b> <b>EZOLV</b></p> <p>Sets the level at which the drive will activate the pre-charge function when the drive is running at the frequency set in Y4-02 [<i>Pre-Charge Frequency</i>].</p> <p><b>Note:</b></p> <ul style="list-style-type: none"> <li>The drive will stop when one of these conditions is true: <ul style="list-style-type: none"> <li>The feedback level increases to more than Y4-01</li> <li>The pre-charge time set in Y4-03 [<i>Pre-Charge Time</i>] expires</li> </ul> </li> <li>Parameters <i>b5-46 [PID Unit Display Selection]</i>, <i>b5-38 [PID User Unit Display Scaling]</i>, and <i>b5-39 [PID User Unit Display Digits]</i> set the unit, scaling, and resolution.</li> </ul>	0.00 (0.00 - 600.00)	926
Y4-02 (3CFB) RUN	Pre-Charge Frequency	<p><b>V/f</b> <b>OLV/PM</b> <b>EZOLV</b></p> <p>Sets the frequency at which the pre-charge function will operate.</p> <p><b>Note:</b></p> <ul style="list-style-type: none"> <li>When <i>A1-02 = 8 [Control Method Selection = EZOLV]</i>, the upper limit is the Hz equivalent of E9-02 [<i>Maximum Speed</i>].</li> <li>When <i>H1-xx = 16 [MFDI Function Selection = Motor 2 Selection]</i> for Motor 2, the upper limit is the larger value between E1-04 [<i>Maximum Output Frequency</i>] and E3-04 [<i>Motor 2 Maximum Output Frequency</i>].</li> </ul>	0.0 Hz (0.0 - E1-04 Hz)	926

No. (Hex.)	Name	Description	Default (Range)	Ref.
Y4-03 (3CFC) RUN	Pre-Charge Time	<b>V/f</b> <b>OLV/PM</b> <b>EZOLV</b> Sets the length of time that the Pre-Charge function will run. <b>Note:</b> • Set this parameter to 0.0 to disable the function. • When $Y1-01 = 3$ [ <i>Multiplex Mode = Memobus Network</i> ], the function is active only on the first drive to run in the network.	0.0 min (0.0 - 3600.0 min)	926
Y4-05 (3CFE) RUN	Pre-Charge Loss of Prime Level	<b>V/f</b> <b>OLV/PM</b> <b>EZOLV</b> Sets the level at which the drive will detect loss of prime in the pump. <b>Note:</b> Parameter $Y1-18$ [ <i>Prime Loss Detection Method</i> ] sets units.	0.0 (0.0 - 1000.0)	926
Y4-11 (3D04) RUN	Thrust Acceleration Time	<b>V/f</b> <b>OLV/PM</b> <b>EZOLV</b> Sets the time at which the drive output frequency will ramp up to the reference frequency set in $Y4-12$ [ <i>Thrust Frequency</i> ].	1.0 s (0.0 - 600.0 s)	926
Y4-12 (3D05) RUN	Thrust Frequency	<b>V/f</b> <b>OLV/PM</b> <b>EZOLV</b> Sets the Thrust Frequency that the drive will use to know which acceleration and deceleration time to use. The drive will accelerate to this frequency in the $Y4-11$ [ <i>Thrust Acceleration Time</i> ] time and decelerate from this frequency in the $Y4-13$ [ <i>Thrust Deceleration Time</i> ] time. <b>Note:</b> • When $A1-02 = 8$ [ <i>Control Method Selection = EZOLV</i> ], the upper limit is the Hz equivalent of $E9-02$ [ <i>Maximum Speed</i> ]. • When $H1-xx = 16$ [ <i>MFDI Function Selection = Motor 2 Selection</i> ] for Motor 2, the upper limit is the larger value between $E1-04$ [ <i>Maximum Output Frequency</i> ] and $E3-04$ [ <i>Motor 2 Maximum Output Frequency</i> ].	0.0 Hz (0.0 - E1-04 Hz)	927
Y4-13 (3D06) RUN	Thrust Deceleration Time	<b>V/f</b> <b>OLV/PM</b> <b>EZOLV</b> Sets the length of time necessary for the drive to go from the Thrust Frequency in $Y4-12$ [ <i>Thrust Frequency</i> ] to stop when Thrust Mode is active.	5.0 s (0.0 - 600.0 s)	927
Y4-17 (3D0A) RUN	Utility Start Delay	<b>V/f</b> <b>OLV/PM</b> <b>EZOLV</b> Sets the length of time that the drive will delay starting at power-up.	0.0 min (0.0 - 1000.0 min)	927
Y4-18 (3D0B) RUN	Differential Level	<b>V/f</b> <b>OLV/PM</b> <b>EZOLV</b> Sets the maximum difference that the drive will allow when it subtracts the Differential Feedback from the Primary PID Feedback. <b>Note:</b> • The drive will respond as specified by the setting in $Y4-20$ [ <i>Differential Level Detection Selection</i> ] when the difference increases to more than the value set in this parameter for the time set in $Y4-19$ [ <i>Differential Level Detection Time</i> ]. • Parameters $b5-46$ [ <i>PID Unit Display Selection</i> ], $b5-38$ [ <i>PID User Unit Display Scaling</i> ], and $b5-39$ [ <i>PID User Unit Display Digits</i> ] set the unit, scaling, and resolution. • Set this parameter to 0.00 to disable Differential Feedback Detection.	0.00% (-99.99 - +99.99%)	928
Y4-19 (3D0C) RUN	Differential Lvl Detection Time	<b>V/f</b> <b>OLV/PM</b> <b>EZOLV</b> Sets the length of time that the difference between PID Feedback and the Differential Feedback must be more than $Y4-18$ [ <i>Differential Level</i> ] before the drive will respond as specified by $Y4-20$ [ <i>Differential Level Detection Selection</i> ].	10 s (0 - 3600 s)	928
Y4-20 (3D0D) RUN	Differential Level Detection Sel	<b>V/f</b> <b>OLV/PM</b> <b>EZOLV</b> Sets the drive response during a Differential Level Detected condition. 0 : Fault (and Digital Out) 1 : Alarm (and Digital Out) 2 : Digital Out Only	0 (0 - 2)	928
Y4-22 (3D0F) RUN	Low City On-Delay Time	<b>V/f</b> <b>OLV/PM</b> <b>EZOLV</b> Sets the length of time that the drive will wait to stop when the drive detects a Low City Pressure condition.	10 s (1 - 1000 s)	928
Y4-23 (3D10) RUN	Low City Off-Delay Time	<b>V/f</b> <b>OLV/PM</b> <b>EZOLV</b> Sets the length of time that the drive will wait to start again after you clear a Low City Pressure condition.	5 s (0 - 1000 s)	928
Y4-24 (3D11) RUN	Low City Alarm Text	<b>V/f</b> <b>OLV/PM</b> <b>EZOLV</b> Sets the alarm message to show on the keypad when the drive detects a Low City Pressure condition. 0 : Low City Pressure 1 : Low Suction Pressure 2 : Low Water in Tank	0 (0 - 2)	929
Y4-36 (3D1D) RUN	Pressure Reached Exit Conditions	<b>V/f</b> <b>OLV/PM</b> <b>EZOLV</b> Sets how the digital output responds to Feedback changes after it activates. 0 : Hysteresis Above & Below 1 : Hysteresis 1-Way	1 (0, 1)	929

## 11.19 Y: Application Features

No. (Hex.)	Name	Description	Default (Range)	Ref.
Y4-37 (3D1E) RUN	Pressure Reached Hysteresis Lvl	<p><b>V/f</b> <b>OLV/PM</b> <b>EZOLV</b></p> <p>Sets the hysteresis level that will cause the drive to exit the Pressure Reached condition.</p> <p><b>Note:</b> Parameters <i>b5-46 [PID Unit Display Selection]</i>, <i>b5-38 [PID User Unit Display Scaling]</i>, and <i>b5-39 [PID User Unit Display Digits]</i> set the unit, scaling, and resolution.</p>	0.30 (0.01 - 10.00)	929
Y4-38 (3D1F) RUN	Pressure Reached On Delay Time	<p><b>V/f</b> <b>OLV/PM</b> <b>EZOLV</b></p> <p>Sets the length of time that the drive will wait before it activates the Pressure Reached condition.</p>	1.0 s (0.1 - 60.0 s)	929
Y4-39 (3D20) RUN	Pressure Reached Off Delay Time	<p><b>V/f</b> <b>OLV/PM</b> <b>EZOLV</b></p> <p>Sets the length of time that the drive will wait before it deactivates the Pressure Reached condition.</p>	1.0 s (0.1 - 60.0 s)	929
Y4-40 (3D21) RUN	Pressure Reached Detection Sel	<p><b>V/f</b> <b>OLV/PM</b> <b>EZOLV</b></p> <p>Sets the drive status that triggers the Pressure Reached Detection digital output.</p> <p>0 : Always 1 : Drive Running 2 : Run Command</p>	0 (0 - 2)	930
Y4-41 (3D22) RUN	Diff Lvl Src Fdbk Backup Select	<p><b>V/f</b> <b>OLV/PM</b> <b>EZOLV</b></p> <p>Sets the function to enable or disable <i>Differential Level Source [H3-xx = 2D]</i> as the backup transducer if there is a failure with the primary PID Feedback transducer [<i>H3-xx = B</i>] and the PID Feedback Backup transducer [<i>H3-xx = 24</i>] is not available.</p> <p>0 : Disabled 1 : Enabled</p>	0 (0, 1)	930
Y4-42 (3D23)	Output Disconnect Detection Sel	<p><b>V/f</b> <b>OLV/PM</b> <b>EZOLV</b></p> <p>Sets the drive response when you open the output disconnect then connect it again.</p> <p>0 : Disabled 1 : Alarm - Speed Search 2 : Alarm - Start at Zero 3 : Fault</p> <p><b>Note:</b> When the Output Disconnect is active, the drive internally disables Output Phase Loss Detection of more than one phase.</p>	0 (0 - 3)	930
Y4-43 (3D24)	Output Disconnect Inject Current	<p><b>V/f</b> <b>OLV/PM</b> <b>EZOLV</b></p> <p>Sets the level of DC injection current during output disconnect as a percentage of the drive rated current.</p>	30% (5 - 50%)	931

## ◆ Y9: Network Multiplex Options

No. (Hex.)	Name	Description	Default (Range)	Ref.
Y9-01 (3DF4)	Lead Drive Selection	<p><b>V/f</b> <b>OLV/PM</b> <b>EZOLV</b></p> <p>Sets how to select the new Lead Drive.</p> <p><b>Note:</b></p> <ul style="list-style-type: none"> <li>When <i>Y9-01 = 1</i>, MEMOBUS network uses monitor <i>U4-01 [Cumulative Ope Time]</i>. The settings of <i>o4-01 [Elapsed Operating Time Setting]</i> and <i>o4-02 [Elapsed Operating Time Selection]</i> will have a direct effect on this parameter. Yaskawa recommends to keep <i>o4-02 = 1 [U4-01 Shows Total RUN Time]</i>.</li> <li>When <i>U4-01 &gt; 65535</i> hours, alternation timer has reached its maximum value. Yaskawa recommends to reset the runtime hours (<i>o4-01</i>) on all the drives to keep the function working correctly.</li> </ul> <p>0 : Next Available 1 : Lowest Runtime 2 : Stop History</p>	1 (0 - 2)	935
Y9-02 (3DF5)	System Feedback Source	<p><b>V/f</b> <b>OLV/PM</b> <b>EZOLV</b></p> <p>Sets the signal to use for PID Feedback when <i>Y1-01 = 3 [Multiplex Mode = Memobus Network]</i>.</p> <p>0 : Analog Only 1 : Ana-&gt;Net, No Alarm 2 : Ana-&gt;Net, Alarm 3 : Network Only</p>	0 (0 - 3)	935

No. (Hex.)	Name	Description	Default (Range)	Ref.
Y9-03 (3DF6) RUN	Alternation Time	<b>V/f</b> <b>OLV/PM</b> <b>EZOLV</b> Sets how much time a drive will request for the alternation, which is set in Y9-04 [Alternation Mode]. <b>Note:</b> • Parameter Y9-19 [Alternation Time Unit] sets the unit text. • Set this parameter to 0 to disable the alternation function.	24 H (0 - 1000 H)	936
Y9-04 (3DF7)	Alternation Mode	<b>V/f</b> <b>OLV/PM</b> <b>EZOLV</b> Sets how the drive does alternation. <b>Note:</b> You can use this parameter only when Y1-03 = 3 [Multiplex Mode = Memobus Network]. 0 : FIFO Auto 1 : FIFO Forced 2 : LIFO 3 : FIFO @Sleep	0 (0 - 3)	936
Y9-05 (3DF8)	Lag Drive Mode	<b>V/f</b> <b>OLV/PM</b> <b>EZOLV</b> Sets the function of the Lag Drives. 0 : Fixed Speed 2 : Turn Off 3 : Follow Lead Speed	0 (0 - 3)	937
Y9-06 (3DF9) RUN	Lag Fixed Speed	<b>V/f</b> <b>OLV/PM</b> <b>EZOLV</b> Sets the speed at which the drive will run when the drive set in Y9-05 = 0 [Lag Drive Mode = Fixed Speed] changes from a lead to a lag and the time set in Y9-07 [Lag Fixed Speed Delay] is expired.	55.0 Hz (0.0 - 400.0 Hz)	937
Y9-07 (3DFA) RUN	Lag Fixed Speed Delay	<b>V/f</b> <b>OLV/PM</b> <b>EZOLV</b> Sets how long the drive holds its current speed before the drive operates as specified in Y9-05 [Lag Drive Mode] when the drive changes from a Lead to a Lag and Y9-05 ≠ 1 [Fixed Speed].	5 s (0 - 1000 s)	937
Y9-08 (3DFB)	Staging Mode	<b>V/f</b> <b>OLV/PM</b> <b>EZOLV</b> Sets the method to determine when it is necessary to stage a new drive to keep the setpoint. 0 : Output Frequency 1 : Feedback 2 : Feedback + Fout	0 (0 - 2)	937
Y9-09 (3DFC) RUN	Staging Frequency Level	<b>V/f</b> <b>OLV/PM</b> <b>EZOLV</b> Sets the level above which the output frequency must increase before the Lead Drive will send a request for a new Lead Drive through the MEMOBUS network. <b>Note:</b> • When A1-02 = 8 [Control Method Selection = EZOLV], the range is 0.0 - 120.0 Hz. • Parameter Y9-08 [Staging Mode] sets the condition to request for a new Lead Drive. – Y9-08 = 0 [Output Frequency]: The output frequency must increase to more than this level for the time set in Y9-11 [Staging Delay Time] to request for a new Lead Drive. – Y9-08 = 2 [Feedback + Fout]: The delta feedback (setpoint minus feedback) must be more than Y9-10 [Staging Delta Feedback Level] level for the time set in Y9-11 [Staging Delay Time] and the output frequency must increase to more than this level to request for a new Lead Drive.	59.5 Hz (0.0 - 400.0 Hz)	938
Y9-10 (3DFD) RUN	Staging Delta Feedback Level	<b>V/f</b> <b>OLV/PM</b> <b>EZOLV</b> Sets the level above which the difference between the setpoint and feedback must increase before the lead drive will send a request for a new Lead Drive through the MEMOBUS network. <b>Note:</b> • When b5-09 = 0 [PID Output Level Selection = Normal Output (Direct Acting)], the drive uses the setpoint minus the feedback to determine the delta feedback level. • When b5-09 = 1 [Reverse Output (Reverse Acting)], the drive uses the feedback minus the setpoint to determine the delta feedback level. • Parameter Y9-08 [Staging Mode] sets the condition to request for a new Lead Drive: – Y9-08 = 1 [Feedback]: The difference between the setpoint and feedback must increase to more than this level for the time set in Y9-11 [Staging Delay Time] to request for a new Lead Drive. – Y9-08 = 2 [Feedback + Fout]: The difference between the setpoint and feedback must increase to more than this level and the output frequency must be more than Y9-09 [Staging Frequency Level] for the time set in Y9-11 [Staging Delay Time] to request for a new Lead Drive.	0.40 (0.00 - 600.00)	938
Y9-11 (3DFE) RUN	Staging Delay Time	<b>V/f</b> <b>OLV/PM</b> <b>EZOLV</b> Sets the delay time before adding a new Lead Drive to the system.	10 s (0 - 3600 s)	938



## 11.19 Y: Application Features

No. (Hex.)	Name	Description	Default (Range)	Ref.
Y9-12 (3DFE)	De-staging Mode	<p><b>V/f</b> <b>OLV/PM</b> <b>EZOLV</b></p> <p>Sets the method to determine when it is necessary to de-stage the previous Lead Drive to keep the setpoint.            0 : Output Frequency            1 : Feedback            2 : Feedback + Fout</p>	0 (0 - 2)	938
Y9-13 (3E00) RUN	De-staging Frequency Level	<p><b>V/f</b> <b>OLV/PM</b> <b>EZOLV</b></p> <p>Sets the level below which the output frequency must decrease before the Lead Drive will request to be removed from the system through the MEMOBUS network.</p> <p><b>Note:</b></p> <ul style="list-style-type: none"> <li>When <math>A1-02 = 8</math> [Control Method Selection = EZOLV], the range is 0.0 - 120.0 Hz.</li> <li>Parameter Y9-12 [De-staging Mode] sets the condition to request for the removal:               <ul style="list-style-type: none"> <li>Y9-12 = 0 [Output Frequency]: The output frequency must decrease to less than this level for the time set in Y9-15 [De-staging Delay Time] to request for the removal.</li> <li>Y9-12 = 2 [Feedback + Fout]: The output frequency must decrease to less than this level and the difference between the feedback and setpoint must be more than Y9-14 [De-staging Delta Feedback Level] for the time set in Y9-15 [De-staging Delay Time] to request for the removal.</li> </ul> </li> </ul>	40.0 Hz (0.0 - 400.0 Hz)	939
Y9-14 (3E01) RUN	De-staging Delta Feedback Level	<p><b>V/f</b> <b>OLV/PM</b> <b>EZOLV</b></p> <p>Sets the level above which the difference between the feedback and setpoint must increase before the lead drive will request to be removed from the system through the MEMOBUS network.</p> <p><b>Note:</b></p> <ul style="list-style-type: none"> <li>When <math>b5-09 = 0</math> [PID Output Level Selection = Normal Output (Direct Acting)], the drive uses the feedback minus the setpoint to determine the delta feedback level.</li> <li>When <math>b5-09 = 1</math> [Reverse Output (Reverse Acting)], the drive uses the setpoint minus the feedback to determine the delta feedback level.</li> <li>Parameter Y9-12 [De-staging Mode] sets the condition to request for the removal:               <ul style="list-style-type: none"> <li>Y9-12 = 1 [Feedback]: The difference between the feedback and setpoint must increase to more than this level for the time set in Y9-15 [De-staging Delay Time] to request for the removal.</li> <li>Y9-12 = 2 [Feedback + Fout]: The difference between the feedback and setpoint must increase to more than this level and the output frequency must be less than Y9-13 [De-staging Frequency Level] level for the time set in Y9-15 [De-staging Delay Time] to request for the removal.</li> </ul> </li> <li>Parameters <math>b5-46</math> [PID Unit Display Selection], <math>b5-38</math> [PID User Unit Display Scaling], and <math>b5-39</math> [PID User Unit Display Digits] set the unit, range, and resolution.</li> </ul>	0.00 (0.00 - 600.00)	939
Y9-15 (3E02) RUN	De-staging Delay Time	<p><b>V/f</b> <b>OLV/PM</b> <b>EZOLV</b></p> <p>Sets the delay time before removing the Lead Drive from the system.</p>	10 s (0 - 3600 s)	939
Y9-16 (3E03) RUN	Stabilization Time	<p><b>V/f</b> <b>OLV/PM</b> <b>EZOLV</b></p> <p>Sets the time used to keep the system stable when you stage or de-stage a drive.</p> <p><b>Note:</b> Lead-lag control and pump protection is stopped during the stabilization time.</p>	3 s (0 - 3600 s)	939
Y9-17 (3E04) RUN	Setpoint Modifier	<p><b>V/f</b> <b>OLV/PM</b> <b>EZOLV</b></p> <p>Sets the value by which the system setpoint is incremented as specified by the number of drives that are running.</p>	0.00 (-99.99 - +99.99)	940
Y9-18 (3E05) RUN	High Feedback De-stage Level	<p><b>V/f</b> <b>OLV/PM</b> <b>EZOLV</b></p> <p>Sets the feedback level to trigger a quick de-stage as a percentage of Y1-11 [High Feedback Level].</p> <p><b>Note:</b></p> <ul style="list-style-type: none"> <li>The quick de-stage ignores parameters Y9-12 [De-staging Mode] to Y9-15 [De-staging Delay Time] and only uses an internal 2 s delay.</li> <li>Set this parameter to 0.0 to disable the function.</li> </ul>	97.0% (0.0 - 100.0%)	940
Y9-19 (3E06) RUN	Alternation Time Unit	<p><b>V/f</b> <b>OLV/PM</b> <b>EZOLV</b></p> <p>Sets the units for Y9-03 [Alternation Time]. You can set this parameter to 1 [Minutes (min)] during commission to test the alternation function.</p> <p><b>Note:</b> You can use this parameter only when Y1-03 = 3 [Multiplex Mode = Memobus Network].</p> <p>0 : Hours (H)            1 : Minutes (min)</p>	0 (0, 1)	940
Y9-20 (3E07)	Allow Network Run	<p><b>V/f</b> <b>OLV/PM</b> <b>EZOLV</b></p> <p>Sets when the drive will respond to a network Run command.</p> <p>0 : Always            1 : First/Alternation            2 : First Only            3 : Alternation Only</p>	0 (0 - 3)	940



No. (Hex.)	Name	Description	Default (Range)	Ref.
Y9-21 (3E08) RUN	Run Priority	<p><b>V/f</b> <b>OLV/PM</b> <b>EZOLV</b></p> <p>Sets the Lead Drive selection priority to override the Y9-01 [Lead Drive Selection] selection.</p> <p><b>Note:</b></p> <ul style="list-style-type: none"> <li>The drive with the lowest Y9-21 value has the highest priority and will become the Lead Drive first. If more than one drive has the lowest Y9-21 value, then Y9-01 [Lead Drive Selection] selects which drive becomes the lead.</li> <li>When you set Y9-21 to the same value for all drives on the MEMOBUS network, it will disable this function. If more than one drive has the same Y9-21 value, then Y9-01 will select the next Lead Drive.</li> <li>To give First Drive (and Lead Drive) control back to the drive with highest priority level set in Y9-21, set Y9-24 [Lead Swap at Sleep Delay Time] on the other drives with a lower priority level.</li> </ul>	8 (1 - 16)	940
Y9-22 (3E09) RUN	System Fault Retry Attempts	<p><b>V/f</b> <b>OLV/PM</b> <b>EZOLV</b></p> <p>Sets the number of times that the MEMOBUS Network will allow automatic restarts of system faults. The drive uses L5-04 [Interval Method Restart Time] to select the time to try a system fault restart.</p> <p><b>Note:</b></p> <p>Set this parameter to the same value for all drives on the network for correct operation.</p>	5 (0 - 10)	941
Y9-23 (3E0A)	Max Drives Allowed to Run	<p><b>V/f</b> <b>OLV/PM</b> <b>EZOLV</b></p> <p>Sets the maximum number of drives that can run on the system.</p>	4 (1 - 4)	941
Y9-24 (3E0B) RUN	Lead Swap at Sleep Delay Time	<p><b>V/f</b> <b>OLV/PM</b> <b>EZOLV</b></p> <p>Sets the length of time that the Lead Drive will be in Sleep Mode before the drive will request for a swap when there is another drive available with a lower Y9-21 [Run Priority] setting.</p> <p><b>Note:</b></p> <p>Set this parameter to 0 to disable the function.</p>	0 s (0 - 7200 s)	941
Y9-25 (3E0C)	Highest Node Address	<p><b>V/f</b> <b>OLV/PM</b> <b>EZOLV</b></p> <p>Sets the highest possible node address in the MEMOBUS network.</p> <p><b>Note:</b></p> <p>For optimal network performance, set the serial communication address H5-01 [Drive Node Address] beginning with 01H consecutively up to the last drive and then set this parameter to the final H5-01 address.</p>	4 (2 - 4)	941
Y9-26 (3E0D)	Master Time-out	<p><b>V/f</b> <b>OLV/PM</b> <b>EZOLV</b></p> <p>Sets the minimum length of time that the slave drives will wait for a message from the master before they do the action set in Y9-27 [Network Recovery].</p>	4.0 s (1.0 - 10.0 s)	941
Y9-27 (3E0E)	Network Recovery	<p><b>V/f</b> <b>OLV/PM</b> <b>EZOLV</b></p> <p>Sets the slave drive response when it does not receive a message from the master for the time set in Y9-26 [Master Time-out].</p> <p>0 : Automatic 1 : Slave/Resume 2 : Slave/Stop 3 : Fault MSL</p>	0 (0 - 3)	941
Y9-28 (3E0F)	NETSCAN Alarm Time	<p><b>V/f</b> <b>OLV/PM</b> <b>EZOLV</b></p> <p>Sets the length of time that the slave drives will wait for a message from the master before they will show a NETSC [NETSCAN Waiting for Master] alarm.</p> <p><b>Note:</b></p> <p>If the network response is late or many node drives are offline, increase the value of this parameter. The master identifies an offline drive as node 1 to Y9-25 [Highest Node Address] that does not have a power supply, has connection problems, or is not connected to the network.</p>	2.0 s (1.0 - 10.0 s)	942
Y9-29 (3E10) RUN	Network AUTO Start Delay	<p><b>V/f</b> <b>OLV/PM</b> <b>EZOLV</b></p> <p>Sets the length of time that the network will wait before it selects and starts the Lead Drive after the First Drive on the network is in AUTO Mode.</p>	2.0 s (0.0 - 60.0 s)	942
Y9-30 (3E11) RUN	Lag Speed Follower Gain	<p><b>V/f</b> <b>OLV/PM</b> <b>EZOLV</b></p> <p>Sets the gain applied to the speed of the current Lead Drive when Y9-05 = 3 [Lag Drive Mode = Follow Lead Speed]. Set the bias to apply in Y9-31 [Lag Speed Follower Bias].</p>	100.0% (0.0 - 300.0%)	942
Y9-31 (3E12) RUN	Lag Speed Follower Bias	<p><b>V/f</b> <b>OLV/PM</b> <b>EZOLV</b></p> <p>Sets the bias applied to the speed of the current Lead Drive when Y9-05 = 3 [Lag Drive Mode = Follow Lead Speed]. Set the gain to apply in Y9-30 [Lag Speed Follower Gain].</p>	0.00 Hz (-60.00 - +60.00 Hz)	942
Y9-32 (3E13) RUN	Lag Follower Deceleration Rate	<p><b>V/f</b> <b>OLV/PM</b> <b>EZOLV</b></p> <p>Sets the deceleration time when the Y9-33 [Lag Follower Decel Activ Time] timer is running and the drive is running as Lag Drive Speed Follower (Y9-05 = 3 [Lag Drive Mode = Follow Lead Speed]).</p>	60.0 s (0.0 - 1000.0 s)	942

## 11.19 Y: Application Features

No. (Hex.)	Name	Description	Default (Range)	Ref.
Y9-33 (3E14) RUN	Lag Follower Decel Activ Time	<p><b>V/f</b> <b>OLV/PM</b> <b>EZOLV</b></p> <p>Sets the time during which the deceleration time set in Y9-32 [<i>Lag Follower Deceleration Rate</i>] is effective. The drive will use the standard deceleration rate when it is expired.</p> <p><b>Note:</b> Set this parameter to 0.0 to disable the function.</p>	0.0 s (0.0 - 3600.0 s)	943
Y9-34 (3E15) RUN	Low Feedback De-stage	<p><b>V/f</b> <b>OLV/PM</b> <b>EZOLV</b></p> <p>Sets the low feedback level that will trigger a quick de-stage.</p> <p><b>Note:</b></p> <ul style="list-style-type: none"> <li>Parameters b5-46 [<i>PID Unit Display Selection</i>], b5-38 [<i>PID User Unit Display Scaling</i>], and b5-39 [<i>PID User Unit Display Digits</i>] set the unit, range, and resolution.</li> <li>The quick de-stage ignores Y9-12 [<i>De-staging Mode</i>] and Y9-15 [<i>De-staging Delay Time</i>] and only uses an internal 2 s delay.</li> <li>Set this parameter to 0.00 to disable the function.</li> </ul>	0.00 (0.00 - 600.00)	943
Y9-35 (3E16) RUN	Alternation Stabilize Time	<p><b>V/f</b> <b>OLV/PM</b> <b>EZOLV</b></p> <p>Sets the maximum length of time the drive will stay running after it is called to alternate-out. The drive will be in Alternation Stabilization Mode during this time.</p> <p><b>Note:</b> Set this parameter to 0 to disable the function.</p>	0 s (0 - 1000 s)	943
Y9-36 (3E17) RUN	Alternation Stabilize Bias	<p><b>V/f</b> <b>OLV/PM</b> <b>EZOLV</b></p> <p>Sets the minimum quantity of PID error applied to the drive during Alternation Stabilization Mode. A lower value can cause it to stay running longer, while a higher value will make the change faster, but it will have a larger pressure change.</p> <p><b>Note:</b> Set as a percentage of b5-38 [<i>PID Unit Scaling</i>].</p>	0.50% (0.00 - 10.00%)	943
Y9-50 (3E25)	PI Auxiliary Control Source	<p><b>V/f</b> <b>OLV/PM</b> <b>EZOLV</b></p> <p>Sets the signal to use for PI Auxiliary Control [YF-xx] when Y1-01 = 3 [<i>Multiplex Mode = Memobus Network</i>].</p> <p>0 : Analog Only 1 : Ana-&gt;Net, No Alrm 2 : Ana-&gt;Net, Alarm 3 : Network Only</p> <p><b>Note:</b></p> <ul style="list-style-type: none"> <li>Drives that have YF-19 = 0 [<i>PI Aux Ctrl Feedback WireBreak = Disabled</i>] and Y9-50 ≠ 3 will have wire-break detection and will continuously send valid or invalid PI Aux Feedback signals to the Network.</li> <li>When YF-19 = 2 [<i>Fault (no retry, coast to stop)</i>] and Y9-50 ≠ 3, the PI Auxiliary Feedback detection will cause an alarm(not a fault) when one of these conditions is true: <ul style="list-style-type: none"> <li>-The drive is in HAND Mode</li> <li>-There is no Lead Drive on the network</li> <li>-The drive is not in AUTO Mode</li> </ul> </li> </ul>	0 (0 - 3)	943
Y9-51 (3E26)	PI Aux Control Turn-Off Method	<p><b>V/f</b> <b>OLV/PM</b> <b>EZOLV</b></p> <p>Sets the MEMOBUS Multiplex response to the PI Aux Control.</p> <p>0 : Disabled 1 : Enabled</p>	0 (0, 1)	944
Y9-98 (3E55)	Network Parameter Push	<p><b>V/f</b> <b>OLV/PM</b> <b>EZOLV</b></p> <p>Sets how the system sends System-wide parameters into the MEMOBUS Multiplex network.</p> <p>0 : Disabled 1 : Enabled/Prompt</p>	1 (0, 1)	944

## ◆ YA: Preset Setpoint

No. (Hex.)	Name	Description	Default (Range)	Ref.
YA-01 (3E58) RUN	Setpoint 1	<p><b>V/f</b> <b>OLV/PM</b> <b>EZOLV</b></p> <p>Sets the PID Setpoint when <math>b1-01 = 0</math> [Frequency Reference Selection 1 = Keypad or Multi-Speed Selection].</p> <p><b>Note:</b> Parameters <math>b5-46</math> [PID Unit Display Selection], <math>b5-38</math> [PID User Unit Display Scaling], and <math>b5-39</math> [PID User Unit Display Digits] set the unit, scaling, and resolution.</p>	0.00 (0.00 - 600.00)	946
YA-02 (3E59) RUN	Setpoint 2	<p><b>V/f</b> <b>OLV/PM</b> <b>EZOLV</b></p> <p>Sets the PID Setpoint as specified by the Multi-Setpoint digital inputs.</p> <p><b>Note:</b> Parameters <math>b5-46</math> [PID Unit Display Selection], <math>b5-38</math> [PID User Unit Display Scaling], and <math>b5-39</math> [PID User Unit Display Digits] set the unit, scaling, and resolution.</p>	0.00 (0.00 - 600.00)	946
YA-03 (3E5A) RUN	Setpoint 3	<p><b>V/f</b> <b>OLV/PM</b> <b>EZOLV</b></p> <p>Sets the PID Setpoint as specified by the Multi-Setpoint digital inputs.</p> <p><b>Note:</b> Parameters <math>b5-46</math> [PID Unit Display Selection], <math>b5-38</math> [PID User Unit Display Scaling], and <math>b5-39</math> [PID User Unit Display Digits] set the unit, scaling, and resolution.</p>	0.00 (0.00 - 600.00)	946
YA-04 (3E5B) RUN	Setpoint 4	<p><b>V/f</b> <b>OLV/PM</b> <b>EZOLV</b></p> <p>Sets the PID Setpoint as specified by the Multi-Setpoint digital inputs.</p> <p><b>Note:</b> Parameters <math>b5-46</math> [PID Unit Display Selection], <math>b5-38</math> [PID User Unit Display Scaling], and <math>b5-39</math> [PID User Unit Display Digits] set the unit, scaling, and resolution.</p>	0.00 (0.00 - 600.00)	946

## ◆ YC: Foldback Features

No. (Hex.)	Name	Description	Default (Range)	Ref.
YC-01 (3EBC)	Output Current Limit Select	<p><b>V/f</b> <b>OLV/PM</b> <b>EZOLV</b></p> <p>Sets the function to enable or disable the output current regulator.</p> <p>0 : Disabled 1 : Enabled</p>	0 (0, 1)	947
YC-02 (3EBD) RUN	Current Limit	<p><b>V/f</b> <b>OLV/PM</b> <b>EZOLV</b></p> <p>Sets the current limit.</p> <p><b>Note:</b> Value is internally limited to 300% of the drive rated current set in <math>n9-01</math> [Inverter Rated Current].</p>	0.0 A (0.0 - 1000.0 A)	947

## ◆ YF: PI Auxiliary Control

No. (Hex.)	Name	Description	Default (Range)	Ref.
YF-01 (3F50)	PI Aux Control Selection	<p><b>V/f</b> <b>OLV/PM</b> <b>EZOLV</b></p> <p>Sets the PI Auxiliary Control function.</p> <p>0 : Disabled 1 : Enabled</p>	0 (0, 1)	948
YF-02 (3F51) RUN	PI Aux Control Transducer Scale	<p><b>V/f</b> <b>OLV/PM</b> <b>EZOLV</b></p> <p>Sets the full scale (10 V or 20 mA) output of the pressure transducer connected to the analog input terminal programmed for <math>H3-xx = 27</math> [PI Aux Control Feedback Level].</p> <p><b>Note:</b> Parameters <math>YF-21</math> [PI Aux Ctrl Level Unit Selection] and <math>YF-22</math> [PI Aux Level Decimal Place Pos] set the unit and resolution.</p>	145.0 (1.0 - 6000.0)	948
YF-03 (3F52) RUN	PI Aux Control Setpoint	<p><b>V/f</b> <b>OLV/PM</b> <b>EZOLV</b></p> <p>Sets the level to which the drive will try to regulate.</p> <p><b>Note:</b> Parameters <math>YF-21</math> [PI Aux Ctrl Level Unit Selection] and <math>YF-22</math> [PI Aux Level Decimal Place Pos] set the unit and resolution.</p>	20.0 PSI (0.0 - 6000.0)	948

## 11.19 Y: Application Features

No. (Hex.)	Name	Description	Default (Range)	Ref.
YF-04 (3F53) RUN	PI Aux Control Minimum Level	<p><b>V/f</b> <b>OLV/PM</b> <b>EZOLV</b></p> <p>Sets the level below which the drive must be for longer than YF-05 [PI Aux Control Sleep Delay Time] before the drive goes to sleep and turns off all lag pumps.</p> <p><b>Note:</b></p> <ul style="list-style-type: none"> <li>Set this parameter to 0.0 to disable the function.</li> <li>Parameters YF-21 [PI Aux Ctrl Level Unit Selection] and YF-22 [PI Aux Level Decimal Place Pos] set the unit and resolution.</li> </ul>	10.0 PSI (0.0 - 6000.0)	949
YF-05 (3F54) RUN	PI Aux Control Sleep Delay Time	<p><b>V/f</b> <b>OLV/PM</b> <b>EZOLV</b></p> <p>Sets the length of time that the drive will delay before it goes to sleep after the level is less than YF-04 [PI Aux Control Minimum Level] (when YF-23 = 1 [PI Aux Ctrl Output Level Select = Inverse Acting]) or more than YF-24 [PI Auxiliary Ctrl Maximum Level] (when YF-23 = 0 [Direct Acting]).</p>	5 s (0 - 3600 s)	949
YF-06 (3F55) RUN	PI Aux Control Wake-up Level	<p><b>V/f</b> <b>OLV/PM</b> <b>EZOLV</b></p> <p>Sets the level to wake up the drive when the drive after YF-04 [PI Aux Control Minimum Level] or YF-24 [PI Auxiliary Ctrl Maximum Level] put the drive to sleep.</p> <p><b>Note:</b></p> <ul style="list-style-type: none"> <li>Parameter YF-23 [PI Aux Ctrl Output Level Select] sets the condition to wake up the drive. <ul style="list-style-type: none"> <li>YF-23 = 0 [Direct Acting]: The PI Aux Feedback must be less than the level set in this parameter for longer than the time set in YF-07 to wake up.</li> <li>YF-23 = 1 [Inverse Acting]: The PI Aux Feedback must be more than the level set in this parameter for longer than the time set in YF-07 [PI Aux Control Wake-up Time] to wake up.</li> </ul> </li> <li>Parameters YF-21 [PI Aux Ctrl Level Unit Selection] and YF-22 [PI Aux Level Decimal Place Pos] set the unit and resolution.</li> </ul>	30.0 PSI (0.0 - 999.9 PSI)	949
YF-07 (3F56)	PI Aux Control Wake-up Time	<p><b>V/f</b> <b>OLV/PM</b> <b>EZOLV</b></p> <p>Sets the time to wake up the drive when the drive after YF-04 [PI Aux Control Minimum Level] or YF-24 [PI Auxiliary Ctrl Maximum Level] put the drive to sleep.</p> <p><b>Note:</b></p> <ul style="list-style-type: none"> <li>Parameter YF-23 [PI Aux Ctrl Output Level Select] sets the condition to wake up the drive. <ul style="list-style-type: none"> <li>YF-23 = 0 [Direct Acting]: The PI Aux Feedback must be less than the level set in YF-06 for longer than the time set in YF-07 to wake up.</li> <li>YF-23 = 1 [Inverse Acting]: The PI Aux Feedback must be more than the level set in YF-06 [PI Aux Control Wake-up Level] for longer than the time set in YF-07 to wake up.</li> </ul> </li> </ul>	1 s (0 - 3600 s)	949
YF-08 (3F57) RUN	PI Aux Control Minimum Speed	<p><b>V/f</b> <b>OLV/PM</b> <b>EZOLV</b></p> <p>Sets the minimum speed at which the drive can run when the PI Auxiliary Control has an effect on the output speed.</p> <p><b>Note:</b></p> <p>The drive will use Y1-06 [Minimum Speed] and Y4-12 [Thrust Frequency] as the minimum speed when PI Aux Control does not have an effect on the output speed or when you set YF-08 &lt; Y1-06 and Y4-12.</p>	0.00 Hz (0.00 - 400.00 Hz)	949
YF-09 (3F58) RUN	PI Aux Control Low Level Detect	<p><b>V/f</b> <b>OLV/PM</b> <b>EZOLV</b></p> <p>Sets the level below which the drive must be for longer than YF-10 [PI Aux Control Low Lvl Det Time] to respond as specified by YF-11 [PI Aux Control Low Level Det Sel].</p> <p><b>Note:</b></p> <ul style="list-style-type: none"> <li>Set this parameter to 0.0 to disable the function.</li> <li>Parameter YF-10 only applies to when YF-11 = 2 and 3 [Fault and Auto-Restart (time set by YF-15)].</li> <li>Range is 0.0 to 999.9 with a delta symbol (Δ) to identify Delta to Setpoint.</li> <li>Parameters YF-21 [PI Aux Ctrl Level Unit Selection] and YF-22 [PI Aux Level Decimal Place Pos] set the unit and resolution.</li> </ul>	0.0 PSI (0.0 - 999.9 PSI)	950
YF-10 (3F59) RUN	PI Aux Low Level Detection Time	<p><b>V/f</b> <b>OLV/PM</b> <b>EZOLV</b></p> <p>Sets the length of time that the PI Aux Feedback must be less than YF-09 [PI Aux Control Low Lvl Detection] to trigger a drive response when YF-11 = 2 and 3 [PI Aux Control Low Level Det Sel = Fault and Auto-Restart (time set by YF-15)].</p>	0.1 s (0.0 - 300.0 s)	950
YF-11 (3F5A)	PI Aux Control Low Level Det Sel	<p><b>V/f</b> <b>OLV/PM</b> <b>EZOLV</b></p> <p>Sets drive response when the PI Aux Feedback decreases to less than YF-09 [PI Aux Control Low Lvl Detection] for longer than YF-10 [PI Aux Control Low Lvl Det Time].</p> <p>0 : No Display 1 : Alarm Only 2 : Fault 3 : Auto-Restart (time set by YF-15)</p> <p><b>Note:</b></p> <ul style="list-style-type: none"> <li>Set YF-01 = 1 [PI Aux Control Selection = Enabled] and YF-09 [PI Aux Control Low Level Detect] &gt; 0 to enable PI Aux Low Level Detection.</li> <li>Parameter YF-10 only applies when YF-11 = 2 or 3.</li> </ul>	1 (0 - 3)	950

No. (Hex.)	Name	Description	Default (Range)	Ref.
YF-12 (3F5B) RUN	PI Aux Control High Level Detect	<p><b>V/f</b> <b>OLV/PM</b> <b>EZOLV</b></p> <p>Sets the value above which the level must be for longer than YF-13 [PI Aux High Level Detection Time] to respond as specified by YF-14 [PI Aux Hi Level Detection Select].</p> <p><b>Note:</b></p> <ul style="list-style-type: none"> <li>Set this parameter to 0.0 to disable the function.</li> <li>Parameter YF-13 only applies to when YF-14 = 2 and 3 [Fault and Auto-Restart (time set by YF-15)].</li> <li>Range is 0.0 to 999.9 with a delta symbol (<math>\Delta</math>) to identify Delta to Setpoint.</li> <li>Parameters YF-21 [PI Aux Ctrl Level Unit Selection] and YF-22 [PI Aux Level Decimal Place Pos] set the unit and resolution.</li> </ul>	0.0 PSI (0.0 - 999.9 PSI)	951
YF-13 (3F5C) RUN	PI Aux High Level Detection Time	<p><b>V/f</b> <b>OLV/PM</b> <b>EZOLV</b></p> <p>Sets the length of time that the level must be more than YF-12 [PI Aux Control High Level Detect] before the drive will respond when YF-14 = 2, 3 [PI Aux Hi Level Detection Select].</p>	0.1 s (0.0 - 300.0 s)	951
YF-14 (3F5D)	PI Aux Control Hi Level Det Sel	<p><b>V/f</b> <b>OLV/PM</b> <b>EZOLV</b></p> <p>Sets the drive response when the PI Aux Feedback increases to more than the YF-12 [PI Aux Control High Level Detect] level for longer than the time set in YF-13 [PI Aux High Level Detection Time].</p> <p>0 : NoDisplay (Digital Output Only) 1 : Alarm Only 2 : Fault 3 : Auto-Restart (time set by YF-15)</p> <p><b>Note:</b></p> <ul style="list-style-type: none"> <li>Set YF-01 = 1 [PI Aux Control Selection = Enabled] and YF-12 [PI Aux Control High Level Detect] &gt; 0 to enable PI Aux High Level Detection.</li> <li>Parameter YF-13 only applies when YF-14 = 2 or 3</li> </ul>	1 (0 - 3)	951
YF-15 (3F5E)	PI Aux Level Detect Restart Time	<p><b>V/f</b> <b>OLV/PM</b> <b>EZOLV</b></p> <p>Sets the length of time the drive will wait before it tries an Auto-Restart of LOAUX [Low PI Aux Feedback Level] or HIAUX [High PI Aux Feedback Level] fault.</p>	5.0 min (0.1 - 6000.0 min)	952
YF-16 (3F5F) RUN	PI Auxiliary Control P Gain	<p><b>V/f</b> <b>OLV/PM</b> <b>EZOLV</b></p> <p>Sets the proportional gain for the suction pressure control.</p>	2.00 (0.00 - 25.00)	952
YF-17 (3F60) RUN	PI Auxiliary Control I Time	<p><b>V/f</b> <b>OLV/PM</b> <b>EZOLV</b></p> <p>Sets the integral time for the suction pressure control.</p> <p><b>Note:</b></p> <p>Set this parameter to 0.0 to disable the integrator.</p>	5.0 s (0.0 - 360.0 s)	952
YF-18 (3F61)	PI Aux Control Detect Time Unit	<p><b>V/f</b> <b>OLV/PM</b> <b>EZOLV</b></p> <p>Sets the time unit for YF-10 [PI Aux Control Low Lvl Det Time] and YF-13 [PI Aux High Level Detection Time].</p> <p>0 : Minutes (min) 1 : Seconds (sec)</p>	1 (0, 1)	952
YF-19 (3F62)	PI Aux Ctrl Feedback WireBreak	<p><b>V/f</b> <b>OLV/PM</b> <b>EZOLV</b></p> <p>Sets how the analog input selected for PI Aux Feedback will respond when it is programmed to receive a 4 mA to 20 mA signal and the signal is lost.</p> <p>0 : Disabled 1 : Alarm Only 2 : Fault (no retry, coast to stop)</p>	2 (0 - 2)	952
YF-20 (3F63)	PI Aux Main PI Speed Control	<p><b>V/f</b> <b>OLV/PM</b> <b>EZOLV</b></p> <p>Sets if the PI Auxiliary Controller has an effect on output speed.</p> <p>0 : Disabled 1 : Enabled</p>	1 (0, 1)	952

No. (Hex.)	Name	Description	Default (Range)	Ref.
YF-21 (3F64)	PI Aux Ctrl Level Unit Selection	<p><b>V/f</b> <b>OLV/PM</b> <b>EZOLV</b></p> <p>Set the units shown for the PI Aux Level parameters and monitors.</p> <p>0 : "WC: inches of water column            1 : PSI: pounds per square inch            2 : GPM: gallons/min            3 : °F: Fahrenheit            4 : ft³/min: cubic feet/min            5 : m³/h: cubic meters/hour            6 : L/h: liters/hour            7 : L/s: liters/sec            8 : bar: bar            9 : Pa: Pascal            10 : °C: Celsius            11 : m: meters            12 : ft: feet            13 : L/min: liters/min            14 : m³/min: cubic meters/min            15 : "Hg: Inch Mercury            16 : kPa: kilopascal            48 : %: Percent            49 : Custom (YF-32 ~ 34)            50 : None</p>	1 (0 - 50)	953
YF-22 (3F65)	PI Aux Level Decimal Place Pos	<p><b>V/f</b> <b>OLV/PM</b> <b>EZOLV</b></p> <p>Sets the number of decimal places for the PI Aux Level parameters and monitors.</p> <p>0 : No Decimal Places (XXXXX)            1 : One Decimal Places (XXXX.X)            2 : Two Decimal Places (XXX.XX)            3 : Three Decimal Places (XX.XXX)</p>	1 (0 - 3)	953
YF-23 (3F66)	PI Aux Ctrl Output Level Select	<p><b>V/f</b> <b>OLV/PM</b> <b>EZOLV</b></p> <p>Sets the PI Auxiliary Controller to be Direct-acting or Inverse-acting.</p> <p>0 : Direct Acting            1 : Inverse Acting</p>	1 (0, 1)	953
YF-24 (3F67) RUN	PI Auxiliary Ctrl Maximum Level	<p><b>V/f</b> <b>OLV/PM</b> <b>EZOLV</b></p> <p>Sets the maximum level for PI Auxiliary Control. When the level is more than this setting for longer than YF-05 [PI Aux Control Sleep Delay Time], the drive will go to sleep and turn off all lag drives.</p> <p><b>Note:</b></p> <ul style="list-style-type: none"> <li>Set this parameter to 0.0 to disable the function.</li> <li>Parameters YF-21 [PI Aux Ctrl Level Unit Selection] and YF-22 [PI Aux Level Decimal Place Pos] set the unit and resolution.</li> </ul>	0.0 PSI (0.0 - 6000.0 PSI)	954
YF-25 (3F68) RUN	PI Aux Control Activation Level	<p><b>V/f</b> <b>OLV/PM</b> <b>EZOLV</b></p> <p>Sets the level to activate the PI Auxiliary Control.</p> <p><b>Note:</b></p> <ul style="list-style-type: none"> <li>The drive response changes when the YF-23 [PI Aux Ctrl Output Level Select] setting changes.</li> <li>–YF-23 = 0 [Direct Acting]: When the PI Aux Feedback level is more than this setting for longer than YF-26 [PI Aux Control Activation Delay], the drive will activate the PI Auxiliary Control to control the output frequency.</li> <li>–YF-23 = 1 [Inverse Acting]: When the PI Aux Feedback level is less than this setting for longer than YF-26, the drive will activate PI Auxiliary Control to control the output frequency.</li> <li>When you set this parameter to 0.0 PSI, PI Auxiliary Control is always enabled.</li> <li>Parameters YF-21 [PI Aux Ctrl Level Unit Selection] and YF-22 [PI Aux Level Decimal Place Pos] set the unit and resolution.</li> </ul>	0.0 PSI (0.0 - 6000.0 PSI)	954
YF-26 (3F69) RUN	PI Aux Control Activation Delay	<p><b>V/f</b> <b>OLV/PM</b> <b>EZOLV</b></p> <p>Sets the delay time to activate the PI Auxiliary Control.</p> <p><b>Note:</b></p> <ul style="list-style-type: none"> <li>The drive response changes when the YF-23 [PI Aux Ctrl Output Level Select] setting changes.</li> <li>–YF-23 = 0 [Direct Acting]: When the PI Aux Feedback level is more than YF-25 [PI Aux Control Activation Level] for longer than this time, the drive will activate the PI Auxiliary Control to control the output frequency.</li> <li>–YF-23 = 1 [Inverse Acting]: When the PI Aux Feedback level is less than YF-25 for longer than this time, the drive will activate PI Auxiliary Control to control the output frequency.</li> <li>When you set this parameter to 0.0 PSI, PI Auxiliary Control is always enabled.</li> </ul>	2 s (0 - 3600 s)	954

No. (Hex.)	Name	Description	Default (Range)	Ref.
YF-32 (3F6F)	PI Aux Custom Unit Character 1	<b>V/f</b> <b>OLV/PM</b> <b>EZOLV</b> Sets the first character of the PI Aux custom unit display when <i>YF-21 = 49</i> [ <i>PI Aux Ctrl Level Unit Selection = Custom (YF-32 ~ 34)</i> ].	41 (20 - 7A)	954
YF-33 (3F70)	PI Aux Custom Unit Character 2	<b>V/f</b> <b>OLV/PM</b> <b>EZOLV</b> Sets the second character of the PI Aux custom unit display when <i>YF-21 = 49</i> [ <i>PI Aux Ctrl Level Unit Selection = Custom (YF-32 ~ 34)</i> ].	41 (20 - 7A)	955
YF-34 (3F71)	PI Aux Custom Unit Character 3	<b>V/f</b> <b>OLV/PM</b> <b>EZOLV</b> Sets the third character of the PI Aux custom unit display when <i>YF-21 = 49</i> [ <i>PI Aux Ctrl Level Unit Selection = Custom (YF-32 ~ 34)</i> ].	41 (20 - 7A)	955
YF-35 (3F72) RUN	PI Aux Minimum Transducer Scale	<b>V/f</b> <b>OLV/PM</b> <b>EZOLV</b> Sets the minimum scale output of the pressure transducer that is connected to the terminal set for <i>H3-xx = 27</i> [ <i>MFAI Function Selection = PI Auxiliary Control Feedback</i> ]. <b>Note:</b> • To enable this parameter, set it to less than <i>YF-02</i> [ <i>PI Aux Control Transducer Scale</i> ]. If you set it to more than <i>YF-02</i> , it will disable the PI Auxiliary Feedback (set to 0). • Parameters <i>YF-21</i> [ <i>PI Aux Ctrl Level Unit Selection</i> ] and <i>YF-22</i> [ <i>PI Aux Level Decimal Place Pos</i> ] set the unit and resolution.	0.0 PSI (-999.9 - +999.9 PSI)	955

## 11.20 Parameters that Change from the Default Settings with A1-02 [Control Method Selection]

The values for parameter *A1-02* changes the default settings for the parameters in these tables:

### ◆ A1-02 = 0 [V/f]

No.	Name	Range	Unit	Control Method (A1-02 Setting)
				V/f (0)
b2-13	Short Circuit Brake Time @ Stop	0.00 - 25.50	0.01 s	-
b3-08	Speed Estimation ACR P Gain	0.00 - 6.00	0.01	0.50 *1
b3-09	Speed Estimation ACR I Time	0.0 - 1000.0	0.1 ms	2.0
b3-10	Speed Estimation Detection Gain	1.00 - 1.20 *2	0.01	1.05
b3-14	Bi-directional Speed Search	0 - 1	1	0 *3
b3-24	Speed Search Method Selection	1 - 2	1	2
b8-19	E-Save Search Injection Freq	10 - 300	1 Hz	-
C2-01	S-Curve Time @ Start of Accel	0.00 - 10.00	0.01 s	0.20
C3-02	Slip Compensation Delay Time	0 - 10000	1 ms	2000
C4-01	Torque Compensation Gain	0.00 - 2.50	0.01	1.00
C4-02	Torque Compensation Delay Time	0 - 60000	1 ms	200
C5-01	ASR Proportional Gain 1	0.00 - 300.00	0.01	-
C5-02	ASR Integral Time 1	0.000 - 60.000	0.001 s	-
C5-03	ASR Proportional Gain 2	0.00 - 300.00	0.01	-
C5-04	ASR Integral Time 2	0.000 - 60.000	0.001 s	-
C5-06	ASR Delay Time	0.000 - 0.500	0.001 s	-
C6-02	Carrier Frequency Selection	1 - F	1	1 *1
E1-04	Maximum Output Frequency	40.0 - 400.0 *4	0.1 Hz	60.0 *5
E1-05	Maximum Output Voltage	0.0 - 255.0 *6	0.1 V	230.0 *5
E1-06	Base Frequency	0.0 - 400.0 *4	0.1 Hz	60.0 *5
E1-09	Minimum Output Frequency	0.0 - 400.0 *4	0.1 Hz	1.5 *5
L1-01	Motor Overload (oL1) Protection	0 - 4	1	1
L2-31	KEB Start Voltage Offset Level	0 - 100 *6	1 V	0
L3-05	Stall Prevention during RUN	0 - 3	1	2
L3-20	DC Bus Voltage Adjustment Gain	0.00 - 5.00	0.01	1.00
n8-51	Pull-in Current @ Acceleration	0 - 200	1%	-
o1-03	Frequency Display Unit Selection	0 - 3	1	0
o5-08	Log Monitor Data 6	000, 101 - 1299	1	000

\*1 The default setting changes when the setting for *o2-04* [Drive Model Selection] changes.

\*2 The setting range changes when the *A1-02* [Control Method Selection] setting changes.

\*3 When *b3-24* = 1, the default value is 1.

\*4 The setting range varies depending on the setting of *E5-01* [PM Motor Code Selection] when *A1-02* = 5 [Control Method Selection = PM Open Loop Vector].

\*5 The default setting changes when the drive model and *E1-03* [V/f Pattern Selection] change.

\*6 This is the value for 208 V class drives. Double the value for 480 V class drives.



## ◆ A1-02 = 5 and 8 [OLV/PM and EZOLV]

No.	Name	Range	Unit	Control Method (A1-02 Setting)	
				OLV/PM (5)	EZOLV (8)
b2-13	Short Circuit Brake Time @ Stop	0.00 - 25.50	0.01 s	0.50	0.00 <sup>*1</sup>
b3-08	Speed Estimation ACR P Gain	0.00 - 6.00	0.01	0.30	0.60 <sup>*2</sup>
b3-09	Speed Estimation ACR I Time	0.0 - 1000.0	0.1 ms	2.0	10.0
b3-10	Speed Estimation Detection Gain	1.00 - 1.20 <sup>*3</sup>	0.01	-	1.00
b3-14	Bi-directional Speed Search	0 - 1	1	-	0
b3-24	Speed Search Method Selection	1 - 2	1	-	1 <sup>*4</sup>
b8-19	E-Save Search Injection Freq	10 - 300	1 Hz	-	20
C2-01	S-Curve Time @ Start of Accel	0.00 - 10.00	0.01 s	1.00	1.00
C3-02	Slip Compensation Delay Time	0 - 10000	1 ms	-	200
C4-01	Torque Compensation Gain	0.00 - 2.50	0.01	0.00	0.00
C4-02	Torque Compensation Delay Time	0 - 60000	1 ms	100	200
C5-01	ASR Proportional Gain 1	0.00 - 300.00	0.01	-	10.00
C5-02	ASR Integral Time 1	0.000 - 60.000	0.001 s	-	0.500
C5-03	ASR Proportional Gain 2	0.00 - 300.00	0.01	-	10.00
C5-04	ASR Integral Time 2	0.000 - 60.000	0.001 s	-	0.500
C5-06	ASR Delay Time	0.000 - 0.500	0.001 s	-	0.004
C6-02	Carrier Frequency Selection	1 - F	1	2 <sup>*2</sup>	2 <sup>*2</sup>
E1-04	Maximum Output Frequency	40.0 - 400.0	0.1 Hz	Determined by E5-01	-
E1-05	Maximum Output Voltage	0.0 - 255.0 <sup>*6</sup>	0.1 V	Determined by E5-01	-
E1-06	Base Frequency	0.0 - 400.0	0.1 Hz	Determined by E5-01	-
E1-09	Minimum Output Frequency	0.0 - 400.0	0.1 Hz	Determined by E5-01	-
L1-01	Motor Overload (oL1) Protection	0 - 4	1	4	1 <sup>*7</sup>
L2-31	KEB Start Voltage Offset Level	0 - 100 <sup>*6</sup>	1 V	50	50
L3-05	Stall Prevention during RUN	0 - 3	1	2	3
L3-20	DC Bus Voltage Adjustment Gain	0.00 - 5.00	0.01	0.65	0.65
n8-51	Pull-in Current @ Acceleration	0 - 200	1%	50	80
o1-03	Frequency Display Unit Selection	0 - 3	1	2	0 <sup>*8</sup>
o5-08	Log Monitor Data 6	000, 101 - 1299	1	000	105

\*1 Enabled only when E9-01 = 1 [Motor Type Selection = Permanent Magnet (PM)]

\*2 The default setting is different for different models.

- 2011 - 2114, 4005 - 4052: 0.6
- 2143 - 2273, 4065 - 4302: 0.3

\*3 The setting range changes when the A1-02 [Control Method Selection] setting changes.

\*4 The default settings are different for different motor types.

- E9-01 = 0 [Motor Type Selection = Induction (IM)]: 2
- E9-01 = 1, 2 [Permanent Magnet (PM), Synchronous Reluctance (SynRM)]: 1

\*5 The unit of measure changes when o2-04 changes.

\*6 This is the value for 208 V class drives. Double the value for 480 V class drives.

\*7 The default settings are different for different motor types.

- E9-01 = 0 [Motor Type Selection = Induction (IM)]: 1
- E9-01 = 1, 2 [Permanent Magnet (PM), Synchronous Reluctance (SynRM)]: 4

## 11.20 Parameters that Change from the Default Settings with A1-02 [Control Method Selection]

---

- \*8 The default settings are different for different motor types.
- $E9-01 = 0$  [*Motor Type Selection = Induction (IM)*]: 0
  - $E9-01 = 1, 2$  [*Permanent Magnet (PM), Synchronous Reluctance (SynRM)*]: 1

## 11.21 Parameters Changed by E1-03 [V/f Pattern Selection]

The values for parameters *A1-02 [Control Method Selection]* and *E1-03 [V/f Pattern Selection]* change the default settings for the parameters in these tables:

**Table 11.1 Parameters Changed by E1-03: 2011, 2017 and 4005 to 4011**

No.	E1-03	E1-04	E1-05 <sup>*1</sup>	E1-06	E1-07	E1-08 <sup>*1</sup>	E1-09	E1-10 <sup>*1</sup>
Unit	-	Hz	V	Hz	Hz	V	Hz	V
Setting Value	0	50.0	230.0	50.0	2.5	17.3	1.3	10.4
	1	60.0	230.0	60.0	3.0	17.3	1.5	10.4
	2	60.0	230.0	50.0	3.0	17.3	1.5	10.4
	3	72.0	230.0	60.0	3.0	17.3	1.5	10.4
	4	50.0	230.0	50.0	25.0	40.3	1.3	9.2
	5	50.0	230.0	50.0	25.0	57.5	1.3	10.4
	6	60.0	230.0	60.0	30.0	40.3	1.5	9.2
	7	60.0	230.0	60.0	30.0	57.5	1.5	10.4
	8	50.0	230.0	50.0	2.5	21.9	1.3	12.7
	9	50.0	230.0	50.0	2.5	27.6	1.3	15
	A	60.0	230.0	60.0	3.0	21.9	1.5	12.7
	B	60.0	230.0	60.0	3.0	27.6	1.5	17.3
	C	90.0	230.0	60.0	3.0	17.3	1.5	10.4
	D	120.0	230.0	60.0	3.0	17.3	1.5	10.4
	E	180.0	230.0	60.0	3.0	17.3	1.5	10.4
	F	60.0 <sup>*2</sup>	230.0 <sup>*2</sup>	60.0 <sup>*2</sup>	30.0 <sup>*2</sup>	57.5 <sup>*2</sup>	1.5 <sup>*2</sup>	10.2 <sup>*2</sup>
Control Method (A1-02 Setting)	OLV/PM (5)	<sup>*3</sup>	<sup>*3</sup>	<sup>*3</sup>	-	-	<sup>*3</sup>	-

\*1 This is the value for 208 V class drives. Double the value for 480 V class drives.

\*2 These values are the default settings for *E1-04 to E1-10* and *E3-04 to E3-10 [V/f Pattern for Motor 2]*. These settings are the same as those for the V/f pattern when *E1-03 = 7 [VT, 60 Hz, 50% Vmid reduction]*.

\*3 The default setting varies depending on the setting of *E5-01 [PM Motor Code Selection]*.

## 11.21 Parameters Changed by E1-03 [V/f Pattern Selection]

**Table 11.2 Parameters Changed by E1-03: 2024 to 2169 and 4014 to 4065**

No.	E1-03	E1-04	E1-05 *1	E1-06	E1-07	E1-08 *1	E1-09	E1-10 *1
Unit	-	Hz	V	Hz	Hz	V	Hz	V
Setting Value	0	50.0	230.0	50.0	2.5	16.1	1.3	8.05
	1	60.0	230.0	60.0	3.0	16.1	1.5	8.05
	2	60.0	230.0	50.0	3.0	16.1	1.5	8.05
	3	72.0	230.0	60.0	3.0	16.1	1.5	8.05
	4	50.0	230.0	50.0	25.0	40.3	1.3	6.9
	5	50.0	230.0	50.0	25.0	57.5	1.3	8.05
	6	60.0	230.0	60.0	30.0	40.3	1.5	6.9
	7	60.0	230.0	60.0	30.0	57.5	1.5	8.05
	8	50.0	230.0	50.0	2.5	20.7	1.3	10.4
	9	50.0	230.0	50.0	2.5	26.5	1.3	12.7
	A	60.0	230.0	60.0	3.0	20.7	1.5	10.4
	B	60.0	230.0	60.0	3.0	26.5	1.5	15
	C	90.0	230.0	60.0	3.0	16.1	1.5	8.05
	D	120.0	230.0	60.0	3.0	16.1	1.5	8.05
	E	180.0	230.0	60.0	3.0	16.1	1.5	8.05
	F	60.0 *2	230.0 *2	60.0 *2	30.0 *2	57.5 *2	1.5 *2	8.1 *2
Control Method (A1-02 Setting)	OLV/PM (5)	*3	*3	*3	-	-	*3	-

\*1 This is the value for 208 V class drives. Double the value for 480 V class drives.

\*2 These values are the default settings for E1-04 to E1-10 and E3-04 to E3-10 [V/f Pattern for Motor 2]. These settings are the same as those for the V/f pattern when E1-03 = 7 [VT, 60 Hz, 50% Vmid reduction].

\*3 The default setting varies depending on the setting of E5-01 [PM Motor Code Selection].

**Table 11.3 Parameters Changed by E1-03: 2211 to 2273 and 4077 to 4302**

No.	E1-03	E1-04	E1-05 *1	E1-06	E1-07	E1-08 *1	E1-09	E1-10 *1
Unit	-	Hz	V	Hz	Hz	V	Hz	V
Setting Value	0	50.0	230.0	50.0	2.5	13.8	1.3	6.9
	1	60.0	230.0	60.0	3.0	13.8	1.5	6.9
	2	60.0	230.0	50.0	3.0	13.8	1.5	6.9
	3	72.0	230.0	60.0	3.0	13.8	1.5	6.9
	4	50.0	230.0	50.0	25.0	40.3	1.3	5.75
	5	50.0	230.0	50.0	25.0	57.5	1.3	6.9
	6	60.0	230.0	60.0	30.0	40.3	1.5	5.75
	7	60.0	230.0	60.0	30.0	57.5	1.5	6.9
	8	50.0	230.0	50.0	2.5	17.3	1.3	8.05
	9	50.0	230.0	50.0	2.5	23	1.3	10.4
	A	60.0	230.0	60.0	3.0	17.3	1.5	8.05
	B	60.0	230.0	60.0	3.0	23	1.5	12.7
	C	90.0	230.0	60.0	3.0	13.8	1.5	6.9
	D	120.0	230.0	60.0	3.0	13.8	1.5	6.9
	E	180.0	230.0	60.0	3.0	13.8	1.5	6.9
	F	60.0 *2	230.0 *2	60.0 *2	30.0 *2	57.5 *2	1.5 *2	6.9 *2
Control Method (A1-02 Setting)	OLV/PM (5)	*3	*3	*3	-	-	*3	-

- \*1 This is the value for 208 V class drives. Double the value for 480 V class drives.
- \*2 These values are the default settings for *E1-04 to E1-10* and *E3-04 to E3-10* [*V/f Pattern for Motor 2*]. These settings are the same as those for the V/f pattern when *E1-03 = 7* [*VT, 60 Hz, 50% Vmid reduction*].
- \*3 The default setting varies depending on the setting of *E5-01* [*PM Motor Code Selection*].

## 11.22 Defaults by o2-04 [Drive Model (kVA) Selection]

The values for parameter *o2-04* changes the default settings for the parameters in these tables:

### ◆ 208 V Class

No. #/	Name	Unit	Default							
			2011	2017	2024	2031	2046	2059	2075	2088
-	Drive Model	-	2011	2017	2024	2031	2046	2059	2075	2088
o2-04	Drive Model (KVA) Selection	Hex.	65	67	68	6A	6B	6D	6E	6F
E2-11 (E4-11, E5-02)	Motor Rated Power	HP (kW)	3 (2.2)	5 (3.7)	7.5 (5.5)	10 (7.5)	15 (11)	20 (15)	25 (18.5)	30 (22)
b3-04	V/f Gain during Speed Search	%	100	100	100	100	100	100	100	100
b3-06	Speed Estimation Current Level 1	-	0.5	0.5	0.5	0.5	0.5	0.5	0.5	0.5
b3-08	Speed Estimation ACR P Gain	-	0.50	0.50	0.50	0.50	0.50	0.50	0.50	0.50
b3-11	Spd Est Method Switch-over Level	%	5.0	5.0	5.0	5.0	5.0	5.0	5.0	5.0
b3-12	Speed Search Current Deadband	-	2.5	2.5	2.5	2.5	2.5	2.5	2.5	2.5
b3-26	Direction Determination Level	-	1000	1000	1000	1000	1000	1000	1000	1000
b8-04	Energy Saving Coefficient Value	-	156.8	122.9	94.75	72.69	70.44	63.13	57.87	51.79
C6-02	Carrier Frequency Selection	-	2	2	2	2	2	2	2	2
E2-01 (E4-01)	Motor Rated Current (FLA)	A	10.6	16.7	24.2	30.8	46.2	59.4	74.8	88
E2-02 (E4-02)	Motor Rated Slip	Hz	2.90	2.73	1.50	1.30	1.70	1.60	1.67	1.70
E2-03 (E4-03)	Motor No-Load Current	A	3.00	4.50	5.10	8.00	11.2	15.2	15.7	18.5
E2-05 (E4-05)	Motor Line-to-Line Resistance	Ω	1.601	0.771	0.399	0.288	0.230	0.138	0.101	0.079
E2-06 (E4-06)	Motor Leakage Inductance	%	18.4	19.6	18.2	15.5	19.5	17.2	20.1	19.5
E2-10 (E4-10)	Motor Iron Loss	W	77	112	172	262	245	272	505	538
E5-01	PM Motor Code Selection	-	FFFF	FFFF	FFFF	FFFF	FFFF	FFFF	FFFF	FFFF
L2-02	Power Loss Ride Through Time	s	0.7	0.9	1.5	1.8	2.0	2.0	2.0	2.0
L2-03	Minimum Baseblock Time	s	0.5	0.6	0.7	0.8	0.9	1	1	1
L2-04	Powerloss V/f Recovery Ramp Time	s	0.3	0.3	0.3	0.3	0.3	0.6	0.6	0.6

No. */	Name	Unit	Default							
			2011	2017	2024	2031	2046	2059	2075	2088
-	Drive Model	-	2011	2017	2024	2031	2046	2059	2075	2088
o2-04	Drive Model (KVA) Selection	Hex.	65	67	68	6A	6B	6D	6E	6F
E2-11 (E4-11, E5-02)	Motor Rated Power	HP (kW)	3 (2.2)	5 (3.7)	7.5 (5.5)	10 (7.5)	15 (11)	20 (15)	25 (18.5)	30 (22)
L2-05	Undervoltage Detection Lvl (Uv1)	-	190	190	190	190	190	190	190	190
L3-24	Motor Accel Time for Inertia Cal	s	0.145	0.154	0.168	0.175	0.265	0.244	0.317	0.355
L8-02	Overheat Alarm Level	°C	95	95	125	125	125	125	115	115
L8-09	Output Ground Fault Detection	-	0	0	0	0	1	1	1	1
L8-35	Installation Method Selection	-	2 *3	2 *3	2 *3	2 *3	2 *3	2 *3	2 *3	2 *3
L8-38 *2	Carrier Frequency Reduction	-	2	2	2	2	2	2	2	2
n1-01	Hunting Prevention Selection	-	1	1	1	1	1	1	1	1
n1-03	Hunting Prevention Time Constant	ms	10	10	10	10	10	10	10	10

- \*1 Parameters within parentheses are for motor 2.
- \*2 You can use this parameter only when A1-02 = 0 [Control Method Selection = V/f].
- \*3 When you use an IP55/UL Type 12 drive, the factory default setting is 3 [IP55/UL Type 12].

No. */	Name	Unit	Default				
			2114	2143	2169	2211	2273
-	Drive Model	-	2114	2143	2169	2211	2273
o2-04	Drive Model (KVA) Selection	Hex.	70	72	73	74	75
E2-11 (E4-11, E5-02)	Motor Rated Power	HP (kW)	40 (30)	50 (37)	60 (45)	75 (55)	100 (75)
b3-04	V/f Gain during Speed Search	%	80	80	80	80	80
b3-06	Speed Estimation Current Level 1	-	0.5	0.5	0.5	0.5	0.7
b3-08	Speed Estimation ACR P Gain	-	0.50	0.50	0.50	0.50	0.50
b3-11	Spd Est Method Switch-over Level	%	5.0	5.0	5.0	5.0	5.0
b3-12	Speed Search Current Deadband	-	2.5	2.5	2.5	2.5	2.5
b3-26	Direction Determination Level	-	1000	1000	1000	1000	1000
b8-04	Energy Saving Coefficient Value	-	46.27	38.16	35.78	31.35	23.10
C6-02	Carrier Frequency Selection	-	2	2	2	2	2
E2-01 (E4-01)	Motor Rated Current (FLA)	A	114	143	169	211	273
E2-02 (E4-02)	Motor Rated Slip	Hz	1.80	1.33	1.60	1.43	1.39
E2-03 (E4-03)	Motor No-Load Current	A	21.9	38.2	44.0	45.6	72.0

## 11.22 Defaults by o2-04 [Drive Model (kVA) Selection]

No. */	Name	Unit	Default				
			2114	2143	2169	2211	2273
-	Drive Model	-	2114	2143	2169	2211	2273
o2-04	Drive Model (KVA) Selection	Hex.	70	72	73	74	75
E2-11 (E4-11, E5-02)	Motor Rated Power	HP (kW)	40 (30)	50 (37)	60 (45)	75 (55)	100 (75)
E2-05 (E4-05)	Motor Line-to-Line Resistance	Ω	0.064	0.039	0.030	0.022	0.023
E2-06 (E4-06)	Motor Leakage Inductance	%	20.8	18.8	20.2	20.5	20.0
E2-10 (E4-10)	Motor Iron Loss	W	699	823	852	960	1200
E5-01	PM Motor Code Selection	-	FFFF	FFFF	FFFF	FFFF	FFFF
L2-02	Power Loss Ride Through Time	s	2.0	2.0	2.0	2.0	2.0
L2-03	Minimum Baseblock Time	s	1.1	1.1	1.2	1.3	1.5
L2-04	Powerloss V/f Recovery Ramp Time	s	0.6	0.6	1	1	1
L2-05	Undervoltage Detection Lvl (UV1)	-	190	190	190	190	190
L3-24	Motor Accel Time for Inertia Cal	s	0.323	0.32	0.387	0.317	0.533
L8-02	Overheat Alarm Level	°C	115	110	110	110	110
L8-09	Output Ground Fault Detection	-	1	1	1	1	1
L8-35	Installation Method Selection	-	2 *3	2 *3	2 *3	0	0
L8-38 *2	Carrier Frequency Reduction	-	2	2	2	2	2
n1-01	Hunting Prevention Selection	-	1	1	1	1	1
n1-03	Hunting Prevention Time Constant	ms	10	10	10	10	10

\*1 Parameters within parentheses are for motor 2.

\*2 You can use this parameter only when A1-02 = 0 [Control Method Selection = V/f].

\*3 When you use an IP55/UL Type 12 drive, the factory default setting is 3 [IP55/UL Type 12].

## ◆ 480 V Class

No. */	Name	Unit	Default								
			4005	4008xF	4008xV 4008xT	4011	4014	4021	4027	4034	4040
-	Drive Model	-	4005	4008xF	4008xV 4008xT	4011	4014	4021	4027	4034	4040
o2-04	Drive Model (KVA) Selection	Hex.	95	97	BB	99	9A	9B	9D	9E	9F
E2-11 (E4-11, E5-02)	Motor Rated Power	HP (kW)	3 (2.2)	5 (3.7)	5 (3.7)	7.5 (5.5)	10 (7.5)	15 (11)	20 (15)	25 (18.5)	30 (22)
b3-04	V/f Gain during Speed Search	%	100	100	100	100	100	100	100	100	100
b3-06	Speed Estimation Current Level 1	-	0.5	0.5	0.5	0.5	0.5	0.5	0.5	0.5	0.5
b3-08	Speed Estimation ACR P Gain	-	0.50	0.50	0.50	0.50	0.50	0.50	0.50	0.50	0.50



No. */	Name	Unit	Default								
			4005	4008xF	4008xV 4008xT	4011	4014	4021	4027	4034	4040
-	Drive Model	-	4005	4008xF	4008xV 4008xT	4011	4014	4021	4027	4034	4040
o2-04	Drive Model (KVA) Selection	Hex.	95	97	BB	99	9A	9B	9D	9E	9F
E2-11 (E4-11, E5-02)	Motor Rated Power	HP (kW)	3 (2.2)	5 (3.7)	5 (3.7)	7.5 (5.5)	10 (7.5)	15 (11)	20 (15)	25 (18.5)	30 (22)
b3-11	Spd Est Method Switch-over Level	%	5.0	5.0	5.0	5.0	5.0	5.0	5.0	5.0	5.0
b3-12	Speed Search Current Deadband	-	2.5	2.5	2.5	2.5	2.5	2.5	2.5	2.5	2.5
b3-26	Direction Determination Level	-	1000	1000	1000	1000	1000	1000	1000	1000	1000
b8-04	Energy Saving Coefficient Value	-	313.6	245.8	245.8	189.5	145.38	140.88	126.26	115.74	103.58
C6-02	Carrier Frequency Selection	-	2	2	2	2	2	2	2	2	2
E2-01 (E4-01)	Motor Rated Current (FLA)	A	4.80	7.60	7.60	11.00	14.00	21.0	27.0	34.0	40.0
E2-02 (E4-02)	Motor Rated Slip	Hz	3.00	2.70	2.70	1.50	1.30	1.70	1.60	1.67	1.70
E2-03 (E4-03)	Motor No-Load Current	A	1.5	2.3	2.3	2.6	4	5.6	7.6	7.8	9.2
E2-05 (E4-05)	Motor Line-to-Line Resistance	Ω	6.495	3.333	3.333	1.595	1.152	0.922	0.550	0.403	0.316
E2-06 (E4-06)	Motor Leakage Inductance	%	18.7	19.3	19.3	18.2	15.5	19.6	17.2	20.1	23.5
E2-10 (E4-10)	Motor Iron Loss	W	77	130	130	193	263	385	440	508	586
E5-01	PM Motor Code Selection	-	FFFF	FFFF	FFFF	FFFF	FFFF	FFFF	FFFF	FFFF	FFFF
L2-02	Power Loss Ride Through Time	s	0.7	0.9	0.9	1.3	1.3	1.7	2.0	2.0	2.0
L2-03	Minimum Baseblock Time	s	0.5	0.6	0.6	0.7	0.8	0.9	1.0	1.0	1.0
L2-04	Powerloss V/f Recovery Ramp Time	s	0.3	0.3	0.3	0.3	0.3	0.3	0.6	0.6	0.6
L2-05	Undervoltage Detection Lvl (Uv1)	-	380	380	380	380	380	380	380	380	380
L3-24	Motor Accel Time for Inertia Cal	s	0.145	0.154	0.154	0.168	0.175	0.265	0.244	0.317	0.355
L8-02	Overheat Alarm Level	°C	115	115	95	95	95	127	127	127	123
L8-09	Output Ground Fault Detection	-	0	0	0	0	0	0	0	0	1
L8-35	Installation Method Selection	-	2 *3	2	3	2 *3	2 *3	2 *3	2 *3	2 *3	2 *3

## 11.22 Defaults by o2-04 [Drive Model (kVA) Selection]

No. */	Name	Unit	Default								
			4005	4008xF	4008xV 4008xT	4011	4014	4021	4027	4034	4040
-	Drive Model	-	4005	4008xF	4008xV 4008xT	4011	4014	4021	4027	4034	4040
o2-04	Drive Model (KVA) Selection	Hex.	95	97	BB	99	9A	9B	9D	9E	9F
E2-11 (E4-11, E5-02)	Motor Rated Power	HP (kW)	3 (2.2)	5 (3.7)	5 (3.7)	7.5 (5.5)	10 (7.5)	15 (11)	20 (15)	25 (18.5)	30 (22)
L8-38 *2	Carrier Frequency Reduction	-	2	2	2	2	2	2	2	2	2
n1-01	Hunting Prevention Selection	-	1	1	1	1	1	1	1	1	1
n1-03	Hunting Prevention Time Constant	ms	10	10	10	10	10	10	10	10	10

\*1 Parameters within parentheses are for motor 2.

\*2 You can use this parameter only when  $A1-02 = 0$  [Control Method Selection = V/f].

\*3 When you use an IP55/UL Type 12 drive, the factory default setting is 3 [IP55/UL Type 12].

No. */	Name	Unit	Default								
			4052	4065	4077	4096	4124	4156	4180	4240	4302
-	Drive Model	-	4052	4065	4077	4096	4124	4156	4180	4240	4302
o2-04	Drive Model (KVA) Selection	Hex.	A0	A2	A3	A4	A5	A6	A7	A8	A9
E2-11 (E4-11, E5-02)	Motor Rated Power	HP (kW)	40 (30)	50 (37)	60 (45)	75 (55)	100 (75)	125 (90)	150 (110)	200 (150)	250 (185)
b3-04	V/f Gain during Speed Search	%	100	100	100	80	60	60	60	60	60
b3-06	Speed Estimation Current Level 1	-	0.5	0.5	0.5	0.5	0.7	0.7	0.7	0.7	0.7
b3-08	Speed Estimation ACR P Gain	-	0.50	0.50	0.50	0.50	0.80	0.80	0.80	0.80	0.80
b3-11	Spd Est Method Switch-over Level	%	5.0	5.0	5.0	5.0	5.0	5.0	5.0	5.0	5.0
b3-12	Speed Search Current Deadband	-	2.5	2.5	2.5	2.5	2.5	2.5	2.5	2.5	2.5
b3-26	Direction Determination Level	-	1000	1000	1000	1000	1000	1000	1000	1000	1000
b8-04	Energy Saving Coefficient Value	-	92.54	76.32	71.56	67.2	46.2	38.91	36.23	32.79	30.57
C6-02	Carrier Frequency Selection	-	2	2	2	2	2	2	2	2	1
E2-01 (E4-01)	Motor Rated Current (FLA)	A	52.0	65.0	77.0	96.0	124.0	156.0	180.0	240.0	302.0
E2-02 (E4-02)	Motor Rated Slip	Hz	1.80	1.33	1.60	1.46	1.39	1.40	1.40	1.38	1.30
E2-03 (E4-03)	Motor No-Load Current	A	10.9	19.1	22	24	36	40	49	58	81

No. */	Name	Unit	Default								
			4052	4065	4077	4096	4124	4156	4180	4240	4302
-	Drive Model	-	4052	4065	4077	4096	4124	4156	4180	4240	4302
o2-04	Drive Model (KVA) Selection	Hex.	A0	A2	A3	A4	A5	A6	A7	A8	A9
E2-11 (E4-11, E5-02)	Motor Rated Power	HP (kW)	40 (30)	50 (37)	60 (45)	75 (55)	100 (75)	125 (90)	150 (110)	200 (150)	250 (185)
E2-05 (E4-05)	Motor Line-to-Line Resistance	Ω	0.269	0.155	0.122	0.088	0.092	0.056	0.046	0.035	0.025
E2-06 (E4-06)	Motor Leakage Inductance	%	20.7	18.8	19.9	20.0	20.0	20.0	20.0	20.0	20.0
E2-10 (E4-10)	Motor Iron Loss	W	750	925	1125	1260	1600	1760	2150	2350	3200
E5-01	PM Motor Code Selection	-	FFFF	FFFF	FFFF	FFFF	FFFF	FFFF	FFFF	FFFF	FFFF
L2-02	Power Loss Ride Through Time	s	2.0	2.0	2.0	2.0	2.0	2.0	2.0	2.0	2.0
L2-03	Minimum Baseblock Time	s	1.1	1.1	1.2	1.2	1.3	1.5	1.7	1.7	1.9
L2-04	Powerloss V/f Recovery Ramp Time	s	0.6	0.6	0.6	1.0	1.0	1.0	1.0	1.0	1.8
L2-05	Undervoltage Detection Lvl (Uv1)	-	380	380	380	380	380	380	380	380	380
L3-24	Motor Accel Time for Inertia Cal	s	0.323	0.320	0.387	0.317	0.533	0.592	0.646	0.673	0.864
L8-02	Overheat Alarm Level	°C	123	123	120	124	124	110	120	120	125
L8-09	Output Ground Fault Detection	-	1	1	1	1	1	1	1	1	1
L8-35	Installation Method Selection	-	2 *3	2 *3	2 *3	2 *3	2 *3	2 *3	0	0	0
L8-38 *2	Carrier Frequency Reduction	-	2	2	2	2	2	2	2	2	2
n1-01	Hunting Prevention Selection	-	1	1	1	1	1	1	1	1	1
n1-03	Hunting Prevention Time Constant	ms	10	10	10	10	30	30	30	30	30

- \*1 Parameters within parentheses are for motor 2.
- \*2 You can use this parameter only when A1-02 = 0 [Control Method Selection = V/f].
- \*3 When you use an IP55/UL Type 12 drive, the factory default setting is 3 [IP55/UL Type 12].



## Parameter Details

---

12.1	Section Safety .....	608
12.2	A: Initialization Parameters.....	609
12.3	b: Application .....	625
12.4	C: Tuning .....	671
12.5	d: References .....	684
12.6	E: Motor Parameters.....	694
12.7	F: Options.....	713
12.8	H: Terminal Functions .....	727
12.9	L: Protection Functions .....	800
12.10	n: Special Adjustment.....	840
12.11	o: Keypad-Related Settings .....	854
12.12	S: Special Applications.....	880
12.13	T: Auto-Tuning.....	910
12.14	Y: Application Features.....	917

## 12.1 Section Safety

 **DANGER**

**Do not ignore the safety messages in this manual.**

If you ignore the safety messages in this manual, it will cause serious injury or death. The manufacturer is not responsible for injuries or damage to equipment.

## 12.2 A: Initialization Parameters

*A* parameters [Initialization Parameters] set the operating environment and operating conditions for the drive.

### ◆ A1: Initialization

*A1* parameters set the operating environment and operating conditions for the drive. For example, these parameters set the keypad language, the control method, and the parameter access level for the drive.

#### ■ A1-00: Language Selection

No. (Hex.)	Name	Description	Default (Range)
A1-00 (0100) RUN	Language Selection	 Sets the language for the keypad.	0 (0 - 6)

**Note:**

When you initialize the drive with parameter *A1-03* [Initialize Parameters], the drive will not reset this parameter.

**0 : English**

**1 : Japanese**

**2 : German**

**3 : French**

**4 : Italian**

**5 : Spanish**

**6 : Portuguese**

#### ■ A1-01: Access Level Selection

No. (Hex.)	Name	Description	Default (Range)
A1-01 (0101) RUN	Access Level Selection	 Sets user access to parameters. The access level controls which parameters the keypad will display and which parameters the user can set.	2 (0 - 4)

**0 : Operation Only**

Access to *A1-00* [Language Selection], *A1-01*, *A1-04* [Password], and the *U* Monitors.

**1 : User Parameters**

Access to *A1-00*, *A1-01*, *A1-04*, and parameters registered to *A2-01* to *A2-32* [User Parameters 1 to 32].

**2 : Advanced Level**

Access to all parameters, but not Expert Mode parameters.

**3 : Expert Level**

Access to all parameters including Expert Mode parameters.

**4 : Lock Parameters**

Parameters that you can see are the same as *Advanced Level*, but parameters that you can change are only *A1-01* and *A1-04*.

The keypad will show the message [Parameters Locked]:

- In the HOME screen, the keypad will show the message [Parameters Locked] on the second line.

10:00 am FWD Rdy Home
<b>OFF</b> Parameters Locked
-----
Freq Reference (KPD)
U1-01 Hz 40.00
-----
Output Frequency
U1-02 Hz 40.00
-----
Menu

- If you try to change a parameter setting, the keypad will show the warning [LOCK] [Parameters Locked] for 2 s. To clear this warning, push one of the keys on the keypad.

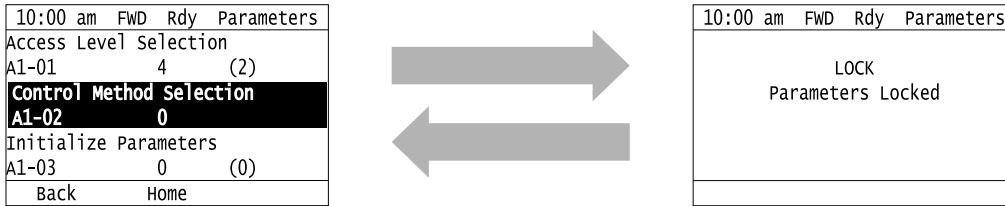

Table 12.1 shows which keypad screens are available for each A1-01 settings.

**Table 12.1 Access Level and Available Keypad Screens**

Mode	Keypad Screen	A1-01 Setting				
		0	1	2	3	4
Drive Mode	Monitors	Yes	Yes	Yes	Yes	Yes
Programming Mode	Parameters	Yes	Yes	Yes	Yes	Yes
	User Custom Parameters	No	Yes	Yes	Yes	No
	Parameter Backup/Restore	No	No	Yes	Yes	No
	Modified Parameters/Fault Log	No	No	Yes	Yes	Yes
	Auto-Tuning	No	No	Yes	Yes	No
	Initial Setup Screen	No	No	Yes	Yes	No
	Diagnostic Tools	No	No	Yes	Yes	No

**Note:**

- When you use A1-04 and A1-05 [Password Setting] to set a password, you cannot change these parameters:
  - A1-01
  - A1-02 [Control Method Selection]
  - A1-03 [Initialize Parameters]
  - A1-06 [Application Preset]
  - A1-07 [DriveWorksEZ Function Selection]
  - A2-01 to A2-32
- When H1-xx = 1B [MFDI Function Selection = Programming Lockout], you must activate the terminal to change parameter settings.
- When you use serial communications, you must send the Enter command from the controller to the drive and complete the serial communication write process before you can use the keypad to change parameter settings.

**■ A1-02: Control Method Selection**

No. (Hex.)	Name	Description	Default (Range)
A1-02 (0102)	Control Method Selection	<b>V/f</b> <b>OLV/PM</b> <b>EZOLV</b> Sets the control method for the drive application and the motor.	0 (0 - 8)

**Note:**

When you change the A1-02 setting, the parameter values specified by A1-02 are changed to their default values.

**0 : V/f Control**

Use this control method in these applications and conditions:



- For general variable-speed control applications in which a high level of responsiveness or high-precision speed control is not necessary.
- To connect more than one motor to one drive
- When there is not sufficient data to set the motor parameters
- When it is not possible to do Auto-Tuning. The speed control range is 1:40.

### 5 : PM Open Loop Vector

The drive controls an IPM motor or SPM motor in this control method. Use this control method for general variable-speed control applications in which a high level of responsiveness or high-precision speed control are not necessary. The speed control range is 1:20.

### 8 : EZ Vector Control

The drive controls SynRM (Synchronous Reluctance Motors) in this control method. This control method uses an easier procedure to operate motors with more efficiency. Use this control method for derating torque applications, for example, fans and pumps.

## ■ A1-03: Initialize Parameters

No. (Hex.)	Name	Description	Default (Range)
A1-03 (0103)	Initialize Parameters	<b>V/f</b> <b>OLVPM</b> <b>EZOLV</b> Sets parameters to default values.	0 (0 - 3410)

#### Note:

- After you initialize the drive, the drive automatically sets  $A1-03 = 0$ .
- User Parameters can save the parameter values for your application and use these values as default values for drive initialization.
- To use the 2 motor switchover function, first turn OFF the terminal to which  $H1-xx = 16$  [MFDI Function Selection = Motor 2 Selection] is set, then change the A1-03 setting. An incorrect procedure will trigger  $oPE08$  [Parameter Selection Error].

### 0 : No Initialization

#### 1110 : User Initialization

Sets parameters to the values set by the user as user settings. Set  $o2-03 = 1$  [User Parameter Default Value = Set defaults] to save the user settings.

You can save the adjusted parameter settings from the test run as user-set default values to the drive. When you make changes to the parameter values after you save the settings as User Parameter Settings, initialize with  $A1-03 = 1110$  for the drive to set the parameters to the User Parameter Setting value.

Follow this procedure to save User Parameter setting values and to do a User Initialization:

1. Set parameters correctly for the application.
2. Set  $o2-03 = 1$  [User Parameter Default Value = Set defaults].  
This saves parameter settings for a User Initialization.  
The drive will automatically set  $o2-03 = 0$ .
3. Set  $A1-03 = 1110$  to reset to the saved parameter settings.  
When you initialize the drive, the drive sets the parameter values to the User Parameter setting values.

#### 2220 : 2-Wire Initialization

Sets MFDI terminal S1 to Forward Run and terminal S2 to Reverse Run, and resets all parameters to default settings.

#### 3330 : 3-Wire Initialization

Sets MFDI terminal S1 to Run, terminal S2 to Stop, and terminal S5 to FWD/REV, and resets all parameters to default settings.

#### 3410 : HVAC Initialization

Initializes the drive to factory default settings and then sets these parameters:

- $H1-03 = B1$  [Terminal S3 Function Selection = Customer Safeties]
- $H1-04 = B2$  [Terminal S4 Function Selection = BAS Interlock]
- $H1-05 = AF$  [Terminal S5 Function Selection = Emergency Override FWD]
- $H2-03 = B2$  [Term M5-M6 Function Selection = BAS Interlock]

## 12.2 A: Initialization Parameters

### Note:

After the drive does an HVAC Initialization, the keypad will show *H1-03*, *H1-04*, *H1-05* and *H2-03* in the Modified Parameters list. The drive will not initialize the parameters in [Table 12.2](#) when *A1-03* = 2220, 3330.

**Table 12.2 Parameters that are not Initialized Using a 2-Wire Sequence or a 3-Wire Sequence**

No.	Name
A1-00	Language Selection
A1-02	Control Method Selection
A1-07	DriveWorksEZ Function Selection
E1-03	V/f Pattern Selection
E5-01	PM Motor Code Selection
E5-02	PM Motor Rated Power
E5-03	PM Motor Rated Current (FLA)
E5-04	PM Motor Pole Count
E5-05	PM Motor Resistance (ohms/phase)
E5-06	PM d-axis Inductance (mH/phase)
E5-07	PM q-axis Inductance (mH/phase)
E5-09	PM Back-EMF V <sub>peak</sub> (mV/(rad/s))
E5-24	PM Back-EMF L-L V <sub>rms</sub> (mV/rpm)
F6-08	Comm Parameter Reset @Initialize
F6-xx/F7-xx	Communication Option Parameters Set <i>F6-08</i> = 1 [ <i>Comm Parameter Reset @Initialize</i> = Reset Back to Factory Default] to initialize communication option card parameters.
L8-35	Installation Method Selection
o2-04	Drive Model (KVA) Selection
o2-24	LED Light Function Selection
q1-xx - q8-xx	DriveWorksEZ Parameters
r1-xx	DWEZ Connection 1-20

### Note:

- Set *A1-06* [*Application Preset*] to let the drive automatically set the best parameter settings for the selected application. The drive does not initialize *A1-02* when *A1-03* = 2220, 3330.
- When *A1-03* = 2220, 3330, the drive automatically sets *A1-05* [*Password Setting*] = 0000. Make sure that you set the password again for applications where a password is necessary.

## ■ A1-04: Password

No. (Hex.)	Name	Description	Default (Range)
A1-04 (0104)	Password	<div style="display: flex; gap: 5px;"> <span style="background-color: #333; color: #fff; padding: 2px 5px;">V/f</span> <span style="background-color: #000; color: #fff; padding: 2px 5px;">OLV/PM</span> <span style="background-color: #000; color: #fff; padding: 2px 5px;">EZOLV</span> </div> Entry point for the password set in <i>A1-05</i> [ <i>Password Setting</i> ]. The user can view the settings of parameters that are locked without entering the password. Enter the correct password in this parameter to change parameter settings.	0000 (0000 - 9999)

If the password entered in *A1-04* does not agree with the password setting in *A1-05*, you cannot change these parameters:

- *A1-01* [*Access Level Selection*]
- *A1-02* [*Control Method Selection*]
- *A1-03* [*Initialize Parameters*]
- *A1-06* [*Application Preset*]
- *A1-07* [*DriveWorksEZ Function Selection*]
- *A2-01* to *A2-32* [*User Parameter 1 to 32*]















To lock parameter settings after making changes without changing the password, enter the incorrect password in *A1-04* and push .

### Enter the Password to Unlock Parameters

Use this procedure to unlock parameter settings.



Set the password in *A1-05 [Password Setting]*, and show the Parameter Setting Mode screen on the keypad.

This procedure verifies the password, and makes sure that the parameter settings are unlocked.

1. Push  or  to select "A: Initialization Parameters", then push .
2. Push  or  to select [*A1-04*], then push .  
You can now change parameter settings.
3. Push  or  to move the digit and enter the password.
4. Push  to confirm the password.  
The drive unlocks the parameters and automatically shows the Parameters Screen.
5. Push  or  to show [*A1-02*], then push .
6. Push  or  to make sure that you can change the setting value.

Push  (Back) until the keypad shows the Parameter Setup Mode screen.



### ■ A1-05: Password Setting

No. (Hex.)	Name	Description	Default (Range)
A1-05 (0105)	Password Setting	   Sets a password to lock parameters and prevent changes to parameter settings. Enter the correct password in <i>A1-04 [Password]</i> to unlock parameters and accept changes.	0000 (0000 - 9999)

This parameter locks these parameters:

- *A1-01 [Access Level Selection]*
- *A1-02 [Control Method Selection]*
- *A1-03 [Initialize Parameters]*
- *A1-06 [Application Preset]*
- *A1-07 [DriveWorksEZ Function Selection]*
- *A2-01 to A2-32 [User Parameter 1 to 32]*

#### Note:

- Usually, the keypad will not show *A1-05*. To show and set *A1-05*, show *A1-04 [Password]* and then push  and  on the keypad at the same time.
- After you set *A1-05*, the keypad will not show it again until you enter the correct password in *A1-04*. Make sure that you remember the *A1-05* setting value. If you do not know the *A1-05* setting value, contact Yaskawa or your nearest sales representative.
- When *A1-03 = 2220, 3330 [2-Wire Initialization, 3-Wire Initialization]*, the drive is initialized to *A1-05 = 0000*. Be sure to set the password again when a password is necessary for the application.
- Change the setting value in *A1-05* to change the password. The new setting value becomes the new password.
- When you use the password to unlock and change a parameter, enter a value other than the password in *A1-04* to lock the parameter again with the same password.
- If *A1-04 ≠ A1-05*, MEMOBUS Communication cannot read or write *A1-05*.

### ■ A1-06: Application Preset

**WARNING!** *Sudden Movement Hazard. Check the I/O signals and the external sequences for the drive before you set the Application Preset function. When you set the Application Preset function (*A1-06 ≠ 0*), it changes the I/O terminal functions for the drive and it can cause equipment to operate unusually. This can cause serious injury or death.*

## 12.2 A: Initialization Parameters

No. (Hex.)	Name	Description	Default (Range)
A1-06 (0127)	Application Preset	<div style="display: flex; gap: 5px;"> <span>V/f</span> <span>OLV/PM</span> <span>EZOLV</span> </div> Sets the drive to operate in selected application conditions.	0 (0 - 8)

The drive software contains the application presets shown below. Set *A1-06* to align with the application to let the drive automatically set the best parameter settings for the selected application. The drive saves parameters frequently used for the application in parameters *A2-01* to *A2-16* [*User Parameters 1 to 16*] for easy configuration and reference in [*User Custom Parameters*] in the main menu.

- General purpose fan
- Fan with PID Control function
- Return fan
- Cooling tower fan
- Secondary pump
- Pump with PID control function
- Pump network multiplex

**Note:**

- Before you set *A1-06*, make sure that you set *A1-03* = 2220, 3330 [*Initialize Parameters = 2-Wire Initialization, 3-Wire Initialization*] to initialize parameters.
- It is not possible to change the *A1-06* value. To set an application preset, first set *A1-03* = 2220 to initialize parameters, then set this parameter. If initializing all parameters will cause a problem, do not change the settings.  
If you set *A2-33* = 1 [*User Parameter Auto Selection = Enabled: Auto Save Recent Parm*s] to set parameters to *A2-17* to *A2-32* [*User Parameters 17 to 32*] automatically, the drive will reset these parameters when you change the *A1-06* setting.

### 0 : No Preset Selected

The drive saves the parameters in [Table 12.3](#) as user parameters.

**Table 12.3 Parameters Saved as User Parameters with the No Preset Selected**

User Parameter No.	Parameter No. Saved	Name
A2-01	A1-02	Control Method Selection
A2-02	b1-01	Frequency Reference Selection 1
A2-03	b1-02	Run Command Selection 1
A2-04	b1-03	Stopping Method Selection
A2-05	C1-01	Acceleration Time 1
A2-06	C1-02	Deceleration Time 1
A2-07	C6-02	Carrier Frequency Selection
A2-08	d1-01	Reference 1
A2-09	d1-02	Reference 2
A2-10	d1-03	Reference 3
A2-11	d1-04	Reference 4
A2-12	d1-17	Jog Reference
A2-13	E1-01	Input AC Supply Voltage
A2-14	E1-03	V/f Pattern Selection
A2-15	E1-04	Maximum Output Frequency
A2-16	E1-05	Maximum Output Voltage
A2-17	E1-06	Base Frequency
A2-18	E1-09	Minimum Output Frequency
A2-19	E1-13	Base Voltage
A2-20	E2-01	Motor Rated Current (FLA)
A2-21	E2-04	Motor Pole Count
A2-22	E2-11	Motor Rated Power

User Parameter No.	Parameter No. Saved	Name
A2-23	H4-02	Terminal FM Analog Output Gain
A2-24	L1-01	Motor Overload (oL1) Protection
A2-25	L3-04	Stall Prevention during Decel

## 1 : General Purpose Fan

The drive automatically sets the parameters in [Table 12.4](#) for a general purpose fan application.

**Table 12.4 Best Parameter Settings for General Purpose Fan Applications**

No.	Name	Optimal Value
A1-02	Control Method Selection	0: V/f Control
b1-03	Stopping Method Selection	1: Coast to Stop
b1-04	Reverse Operation Selection	1: Reverse Disabled
C1-01	Acceleration Time 1	60.0 s
L5-01	Number of Auto-Restart Attempts	10

The drive saves the parameters in [Table 12.5](#) as user parameters.

**Table 12.5 Parameters Saved as User Parameters with the General Purpose Fan Preset**

User Parameter No.	Parameter No. Saved	Name
A2-01	b1-03	Stopping Method Selection
A2-02	b1-04	Reverse Operation Selection
A2-03	b2-09	Pre-heat Current 2
A2-04	b5-01	PID Mode Setting
A2-05	b5-03	Integral Time (I)
A2-06	b5-08	PID Primary Delay Time Constant
A2-07	b5-09	PID Output Level Selection
A2-08	C1-01	Acceleration Time 1
A2-09	d2-03	Analog Frequency Ref Lower Limit
A2-10	H1-07	Terminal S7 Function Selection
A2-11	H3-01	Terminal A1 Signal Level Select
A2-12	H3-02	Terminal A1 Function Selection
A2-13	H3-10	Terminal A2 Function Selection
A2-14	L5-01	Number of Auto-Restart Attempts
A2-15	o1-24	Custom Monitor 1
A2-16	o1-25	Custom Monitor 2
A2-17	o1-26	Custom Monitor 3
A2-18	Y1-04	Sleep Wake-up Level
A2-19	Y1-05	Sleep Wake-up Level Delay Time
A2-20	Y1-08	Low Feedback Level
A2-21	Y1-09	Low Feedback Lvl Fault Dly Time
A2-22	Y2-01	Sleep Level Type
A2-23	Y2-02	Sleep Level
A2-24	Y2-03	Sleep Delay Time
A2-25	Y2-04	Sleep Activation Level

## 2 : Fan w/ PID Control

## 12.2 A: Initialization Parameters

The drive automatically sets the parameters in [Table 12.6](#) for a fan with PID control application.

**Table 12.6 Best Parameter Settings for Fan with PID Control Applications**

No.	Name	Optimal Value
A1-02	Control Method Selection	0: V/f Control
b1-03	Stopping Method Selection	1: Coast to Stop
b1-04	Reverse Operation Selection	1: Reverse Disabled
b5-01	PID Mode Setting	1: Standard
b5-03	Integral Time (I)	30.0 s
b5-08	PID Primary Delay Time Constant	2.00 s
C1-01	Acceleration Time 1	60.0 s
H3-10	Terminal A2 Function Selection	B: PID Feedback
L5-01	Number of Auto-Restart Attempts	10
Y1-08	Low Feedback Level	2.00%
Y1-09	Low Feedback Lvl Fault Dly Time	25 s

The drive saves the parameters in [Table 12.7](#) as user parameters.

**Table 12.7 Parameters Saved as User Parameters with the Fan with PID Control Preset**

User Parameter No.	Parameter No. Saved	Name
A2-01	b1-03	Stopping Method Selection
A2-02	b1-04	Reverse Operation Selection
A2-03	b2-09	Pre-heat Current 2
A2-04	b5-01	PID Mode Setting
A2-05	b5-03	Integral Time (I)
A2-06	b5-08	PID Primary Delay Time Constant
A2-07	b5-09	PID Output Level Selection
A2-08	C1-01	Acceleration Time 1
A2-09	d2-03	Analog Frequency Ref Lower Limit
A2-10	H1-07	Terminal S7 Function Selection
A2-11	H3-01	Terminal A1 Signal Level Select
A2-12	H3-02	Terminal A1 Function Selection
A2-13	H3-10	Terminal A2 Function Selection
A2-14	L5-01	Number of Auto-Restart Attempts
A2-15	o1-24	Custom Monitor 1
A2-16	o1-25	Custom Monitor 2
A2-17	o1-26	Custom Monitor 3
A2-18	Y1-04	Sleep Wake-up Level
A2-19	Y1-05	Sleep Wake-up Level Delay Time
A2-20	Y1-08	Low Feedback Level
A2-21	Y1-09	Low Feedback Lvl Fault Dly Time
A2-22	Y2-01	Sleep Level Type
A2-23	Y2-02	Sleep Level
A2-24	Y2-03	Sleep Delay Time
A2-25	Y2-04	Sleep Activation Level

### 3 : Return Fan w/ PID Control

The drive automatically sets the parameters in [Table 12.8](#) for a return fan with PID control application.

**Table 12.8 Best Parameter Settings for Return Fan with PID Control Applications**

No.	Name	Optimal Value
A1-02	Control Method Selection	0: V/f Control
b1-03	Stopping Method Selection	1: Coast to Stop
b1-04	Reverse Operation Selection	1: Reverse Disabled
b5-01	PID Mode Setting	1: Standard
b5-03	Integral Time (I)	30.0 s
b5-08	PID Primary Delay Time Constant	2.00 s
C1-01	Acceleration Time 1	60.0 s
H3-01	Terminal A1 Signal Level Select	2: 4 to 20 mA
H3-02	Terminal A1 Function Selection	B: PID Feedback
H3-10	Terminal A2 Function Selection	16: Differential PID Feedback
L5-01	Number of Auto-Restart Attempts	10
o1-27	Custom Monitor 4	505: PID DifferentialFdbk
Y1-08	Low Feedback Level	2.00%
Y1-09	Low Feedback Lvl Fault Dly Time	25 s

The drive saves the parameters in [Table 12.9](#) as user parameters.

**Table 12.9 Parameters Saved as User Parameters with the Return Fan with PID Control Preset**

User Parameter No.	Parameter No. Saved	Name
A2-01	b1-03	Stopping Method Selection
A2-02	b1-04	Reverse Operation Selection
A2-03	b2-09	Pre-heat Current 2
A2-04	b5-01	PID Mode Setting
A2-05	b5-03	Integral Time (I)
A2-06	b5-08	PID Primary Delay Time Constant
A2-07	b5-09	PID Output Level Selection
A2-08	C1-01	Acceleration Time 1
A2-09	d2-03	Analog Frequency Ref Lower Limit
A2-10	H1-07	Terminal S7 Function Selection
A2-11	H3-01	Terminal A1 Signal Level Select
A2-12	H3-02	Terminal A1 Function Selection
A2-13	H3-10	Terminal A2 Function Selection
A2-14	L5-01	Number of Auto-Restart Attempts
A2-15	o1-24	Custom Monitor 1
A2-16	o1-25	Custom Monitor 2
A2-17	o1-26	Custom Monitor 3
A2-18	Y1-04	Sleep Wake-up Level
A2-19	Y1-05	Sleep Wake-up Level Delay Time
A2-20	Y1-08	Low Feedback Level
A2-21	Y1-09	Low Feedback Lvl Fault Dly Time
A2-22	Y2-01	Sleep Level Type
A2-23	Y2-02	Sleep Level

## 12.2 A: Initialization Parameters

User Parameter No.	Parameter No. Saved	Name
A2-24	Y2-03	Sleep Delay Time
A2-25	Y2-04	Sleep Activation Level

### 4 : Cooling Tower Fan

The drive automatically sets the parameters in [Table 12.10](#) for a cooling tower fan application.

**Table 12.10 Best Parameter Settings for Cooling Tower Fan Applications**

No.	Name	Optimal Value
A1-02	Control Method Selection	0: V/f Control
b1-03	Stopping Method Selection	1: Coast to Stop
b1-04	Reverse Operation Selection	0: Reverse Enabled
C1-01	Acceleration Time 1	60.0 s
L5-01	Number of Auto-Restart Attempts	10

The drive saves the parameters in [Table 12.11](#) as user parameters.

**Table 12.11 Parameters Saved as User Parameters with the Cooling Tower Fan Preset**

User Parameter No.	Parameter No. Saved	Name
A2-01	b1-03	Stopping Method Selection
A2-02	b1-04	Reverse Operation Selection
A2-03	b2-09	Pre-heat Current 2
A2-04	b5-01	PID Mode Setting
A2-05	b5-03	Integral Time (I)
A2-06	b5-08	PID Primary Delay Time Constant
A2-07	b5-09	PID Output Level Selection
A2-08	C1-01	Acceleration Time 1
A2-09	d2-03	Analog Frequency Ref Lower Limit
A2-10	H1-07	Terminal S7 Function Selection
A2-11	H3-01	Terminal A1 Signal Level Select
A2-12	H3-02	Terminal A1 Function Selection
A2-13	H3-10	Terminal A2 Function Selection
A2-14	L5-01	Number of Auto-Restart Attempts
A2-15	o1-24	Custom Monitor 1
A2-16	o1-25	Custom Monitor 2
A2-17	o1-26	Custom Monitor 3
A2-18	Y1-04	Sleep Wake-up Level
A2-19	Y1-05	Sleep Wake-up Level Delay Time
A2-20	Y1-08	Low Feedback Level
A2-21	Y1-09	Low Feedback Lvl Fault Dly Time
A2-22	Y2-01	Sleep Level Type
A2-23	Y2-02	Sleep Level
A2-24	Y2-03	Sleep Delay Time
A2-25	Y2-04	Sleep Activation Level

### 5 : Cooling Tower Fan w/ PID

The drive automatically sets the parameters in [Table 12.12](#) for a cooling tower fan with PID control application.



**Table 12.12 Best Parameter Settings for Cooling Tower Fan with PID Control Applications**

No.	Name	Optimal Value
A1-02	Control Method Selection	0: V/f Control
b1-03	Stopping Method Selection	1: Coast to Stop
b1-04	Reverse Operation Selection	0: Reverse Enabled
b5-01	PID Mode Setting	1: Standard
b5-03	Integral Time (I)	30.0 s
b5-08	PID Primary Delay Time Constant	2.00 s
b5-09	PID Output Level Selection	1: Reverse Output (Reverse Acting)
C1-01	Acceleration Time 1	60.0 s
H3-10	Terminal A2 Function Selection	B: PID Feedback
L5-01	Number of Auto-Restart Attempts	10
Y1-04	Sleep Wake-up Level	-5.00
Y1-05	Sleep Wake-up Level Delay Time	30 s
Y1-08	Low Feedback Level	2.00%
Y1-09	Low Feedback Lvl Fault Dly Time	25 s
Y2-01	Sleep Level Type	0: Output Frequency
Y2-02	Sleep Level	10.8
Y2-03	Sleep Delay Time	30 s

The drive saves the parameters in [Table 12.13](#) as user parameters.

**Table 12.13 Parameters Saved as User Parameters with the Cooling Tower Fan with PID Control Preset**

User Parameter No.	Parameter No. Saved	Name
A2-01	b1-03	Stopping Method Selection
A2-02	b1-04	Reverse Operation Selection
A2-03	b2-09	Pre-heat Current 2
A2-04	b5-01	PID Mode Setting
A2-05	b5-03	Integral Time (I)
A2-06	b5-08	PID Primary Delay Time Constant
A2-07	b5-09	PID Output Level Selection
A2-08	C1-01	Acceleration Time 1
A2-09	d2-03	Analog Frequency Ref Lower Limit
A2-10	H1-07	Terminal S7 Function Selection
A2-11	H3-01	Terminal A1 Signal Level Select
A2-12	H3-02	Terminal A1 Function Selection
A2-13	H3-10	Terminal A2 Function Selection
A2-14	L5-01	Number of Auto-Restart Attempts
A2-15	o1-24	Custom Monitor 1
A2-16	o1-25	Custom Monitor 2
A2-17	o1-26	Custom Monitor 3
A2-18	Y1-04	Sleep Wake-up Level
A2-19	Y1-05	Sleep Wake-up Level Delay Time
A2-20	Y1-08	Low Feedback Level
A2-21	Y1-09	Low Feedback Lvl Fault Dly Time
A2-22	Y2-01	Sleep Level Type

## 12.2 A: Initialization Parameters

User Parameter No.	Parameter No. Saved	Name
A2-23	Y2-02	Sleep Level
A2-24	Y2-03	Sleep Delay Time
A2-25	Y2-04	Sleep Activation Level

### 6 : Secondary Pump

The drive automatically sets the parameters in [Table 12.14](#) for a secondary pump application.

**Table 12.14 Best Parameter Settings for Secondary Pump Applications**

No.	Name	Optimal Value
A1-02	Control Method Selection	0: V/f Control
b1-04	Reverse Operation Selection	1: Reverse Disabled
C1-01	Acceleration Time 1	20.0 s
d2-03	Analog Frequency Ref Lower Limit	20.0%
L5-01	Number of Auto-Restart Attempts	10

The drive saves the parameters in [Table 12.15](#) as user parameters.

**Table 12.15 Parameters Saved as User Parameters with the Secondary Pump Preset**

User Parameter No.	Parameter No. Saved	Name
A2-01	b1-03	Stopping Method Selection
A2-02	b1-04	Reverse Operation Selection
A2-03	b2-09	Pre-heat Current 2
A2-04	b5-01	PID Mode Setting
A2-05	b5-03	Integral Time (I)
A2-06	b5-08	PID Primary Delay Time Constant
A2-07	b5-09	PID Output Level Selection
A2-08	C1-01	Acceleration Time 1
A2-09	d2-03	Analog Frequency Ref Lower Limit
A2-10	H1-07	Terminal S7 Function Selection
A2-11	H3-01	Terminal A1 Signal Level Select
A2-12	H3-02	Terminal A1 Function Selection
A2-13	H3-10	Terminal A2 Function Selection
A2-14	L5-01	Number of Auto-Restart Attempts
A2-15	o1-24	Custom Monitor 1
A2-16	o1-25	Custom Monitor 2
A2-17	o1-26	Custom Monitor 3
A2-18	Y1-04	Sleep Wake-up Level
A2-19	Y1-05	Sleep Wake-up Level Delay Time
A2-20	Y1-08	Low Feedback Level
A2-21	Y1-09	Low Feedback Lvl Fault Dly Time
A2-22	Y2-01	Sleep Level Type
A2-23	Y2-02	Sleep Level
A2-24	Y2-03	Sleep Delay Time
A2-25	Y2-04	Sleep Activation Level

### 7 : Pump w/ PID Control

The drive automatically sets the parameters in [Table 12.16](#) for a pump with PID control application.

**Table 12.16 Optimal Settings for Pump with PID Control Applications**

No.	Name	Optimal Value
A1-02	Control Method Selection	0: V/f Control
b1-04	Reverse Operation Selection	1: Reverse Disabled
b5-01	PID Mode Setting	1: Standard
b5-03	Integral Time (I)	15.0 s
b5-08	PID Primary Delay Time Constant	1.00 s
C1-01	Acceleration Time 1	20.0 s
d2-03	Analog Frequency Ref Lower Limit	20.0%
H3-10	Terminal A2 Function Selection	B: PID Feedback
L5-01	Number of Auto-Restart Attempts	10
L5-49	Fault Retry Speed Search Select	0: Disabled
S5-10	AUTO Key Memory at Power Down	1: Enabled w/ Memory
Y1-04	Sleep Wake-up Level	-5.00
Y1-05	Sleep Wake-up Level Delay Time	30 s
Y1-08	Low Feedback Level	2.00%
Y1-09	Low Feedback Lvl Fault Dly Time	25 s
Y2-01	Sleep Level Type	0: Output Frequency
Y2-02	Sleep Level	20.0
Y2-03	Sleep Delay Time	30 s

The drive saves the parameters in [Table 12.17](#) as user parameters.

**Table 12.17 Parameters Saved as User Parameters with the Pump with PID Control Preset**

User Parameter No.	Parameter No. Saved	Name
A2-01	b1-03	Stopping Method Selection
A2-02	b1-04	Reverse Operation Selection
A2-03	b2-09	Pre-heat Current 2
A2-04	b5-01	PID Mode Setting
A2-05	b5-03	Integral Time (I)
A2-06	b5-08	PID Primary Delay Time Constant
A2-07	b5-09	PID Output Level Selection
A2-08	C1-01	Acceleration Time 1
A2-09	d2-03	Analog Frequency Ref Lower Limit
A2-10	H1-07	Terminal S7 Function Selection
A2-11	H3-01	Terminal A1 Signal Level Select
A2-12	H3-02	Terminal A1 Function Selection
A2-13	H3-10	Terminal A2 Function Selection
A2-14	L5-01	Number of Auto-Restart Attempts
A2-15	o1-24	Custom Monitor 1
A2-16	o1-25	Custom Monitor 2
A2-17	o1-26	Custom Monitor 3
A2-18	Y1-04	Sleep Wake-up Level
A2-19	Y1-05	Sleep Wake-up Level Delay Time
A2-20	Y1-08	Low Feedback Level

## 12.2 A: Initialization Parameters

User Parameter No.	Parameter No. Saved	Name
A2-21	Y1-09	Low Feedback Lvl Fault Dly Time
A2-22	Y2-01	Sleep Level Type
A2-23	Y2-02	Sleep Level
A2-24	Y2-03	Sleep Delay Time
A2-25	Y2-04	Sleep Activation Level

### 8 : Pump Network Multiplex

The drive automatically sets the parameters in [Table 12.18](#) for a pump network multiplex application.

**Table 12.18 Optimal Settings for Pump Network Multiplex Applications**

No.	Name	Optimal Value
A1-02	Control Method Selection	0: V/f Control
b1-01	Frequency Reference Selection 1	0: Keypad
b1-02	Run Command Selection 1	0: Keypad
b5-01	PID Mode Setting	1: Standard
b5-39	PID User Unit Display Digits	1: One Decimal Places (XXXX.X)
b5-46	PID Unit Display Selection	1: PSI (pounds per square inch)
C1-01	Acceleration Time 1	20.0 s
C1-02	Deceleration Time 1	20.0 s
H2-02	Term M3-M4 Function Selection	42: Pressure Reached
H2-03	Term M5-M6 Function Selection	37: During Frequency Output
H3-09	Terminal A2 Signal Level Select	2: 4 to 20 mA
H3-10	Terminal A2 Function Selection	B: PID Feedback
L5-01	Number of Auto-Restart Attempts	5
L5-49	Fault Retry Speed Search Select	0: Disabled
S5-05	HAND Frequency Reference	40.00 Hz
S5-10	AUTO Key Memory at Power Down	1: Enabled w/ Memory
Y1-01	Multiplex Mode	3: Memobus Network
Y1-04	Sleep Wake-up Level	-10.0
Y1-06	Minimum Speed	40.0
Y1-11	High Feedback Level	100.0
Y2-01	Sleep Level Type	0: Output Frequency
Y2-23	Anti-No-Flow Bandwidth	0.40%
Y4-12	Thrust Frequency	30.0 Hz
Y4-17	Utility Start Delay	0.2 min
Y9-06	Lag Fixed Speed	54.0 Hz
YA-01	Setpoint 1	80.0%



The drive saves the parameters in [Table 12.19](#) as user parameters.

**Table 12.19 Parameters Saved as User Parameters with the Pump Network Multiplex Preset**

User Parameter No.	Parameter No. Saved	Name
A2-01	b1-03	Stopping Method Selection
A2-02	b1-04	Reverse Operation Selection
A2-03	b2-09	Pre-heat Current 2
A2-04	b5-01	PID Mode Setting

User Parameter No.	Parameter No. Saved	Name
A2-05	b5-03	Integral Time (I)
A2-06	b5-08	PID Primary Delay Time Constant
A2-07	b5-09	PID Output Level Selection
A2-08	C1-01	Acceleration Time 1
A2-09	d2-03	Analog Frequency Ref Lower Limit
A2-10	H1-07	Terminal S7 Function Selection
A2-11	H3-01	Terminal A1 Signal Level Select
A2-12	H3-02	Terminal A1 Function Selection
A2-13	H3-10	Terminal A2 Function Selection
A2-14	L5-01	Number of Auto-Restart Attempts
A2-15	o1-24	Custom Monitor 1
A2-16	o1-25	Custom Monitor 2
A2-17	o1-26	Custom Monitor 3
A2-18	Y1-04	Sleep Wake-up Level
A2-19	Y1-05	Sleep Wake-up Level Delay Time
A2-20	Y1-08	Low Feedback Level
A2-21	Y1-09	Low Feedback Lvl Fault Dly Time
A2-22	Y2-01	Sleep Level Type
A2-23	Y2-02	Sleep Level
A2-24	Y2-03	Sleep Delay Time
A2-25	Y2-04	Sleep Activation Level

### ■ A1-07: DriveWorksEZ Function Selection

No. (Hex.)	Name	Description	Default (Range)
A1-07 (0128)	DriveWorksEZ Function Selection	   Sets the drive to operate with DriveWorksEZ.	0 (0 - 2)

DriveWorksEZ is a simple visual programming tool that lets you connect function blocks to customize the drive and add PLC functions.

#### Note:

- DriveWorksEZ will overwrite drive settings when it uses MFDI/MFDO and MFAI/MFAO. When you use DriveWorksEZ to make changes to the drive, the changes will stay after you disable DriveWorksEZ.
- For more information about DriveWorksEZ, contact Yaskawa or your nearest sales representative.

#### 0 : DWEZ Disabled



#### 1 : DWEZ Enabled

#### 2 : Enabled/Disabled wDigital Input

Set  $H1-xx = 9F$  [MFDI Function Select = DWEZ Disable]. Deactivate the digital input to enable programs made with DriveWorksEZ. Activate the terminal to disable the programs.

If  $A1-07 = 1$  [DriveWorksEZ Function Selection = DWEZ Enabled], and the MFDI terminal set to  $H1-xx = 9F$  activates, the drive will continue to disable DWEZ.

### ■ A1-11: Firmware Update Lock

No. (Hex.)	Name	Description	Default (Range)
A1-11 (111D) Expert	Firmware Update Lock	   Protects the drive firmware. When you enable the protection, you cannot update the drive firmware.	0 (0, 1)

### 0 : Disabled

Lock is disabled.

### 1 : Enabled

Lock is enabled.

### ■ A1-12: Bluetooth ID

No. (Hex.)	Name	Description	Default (Range)
A1-12 (1564)	Bluetooth ID	<div style="display: flex; gap: 5px;"> <span style="border: 1px solid black; padding: 2px;">V/f</span> <span style="border: 1px solid black; padding: 2px;">OLV/PM</span> <span style="border: 1px solid black; padding: 2px;">EZOLV</span> </div> <p>Sets the password necessary to use Bluetooth to control the drive with a smartphone or tablet.</p>	- (0000 - 9999)

*A1-12 = 0000* disables Bluetooth connection. Set *A1-12 ≠ 0000* to enable Bluetooth connection. When you use *A1-03 [Initialize Parameters]* to initialize the drive, the drive will not reset *A1-12*.

## ◆ A2: User Parameters

You can register frequently used parameters and recently changed parameters here to access them quickly. You can show the registered parameters in [User Custom Parameters] in the main menu.

### ■ A2-01 to A2-32: User Parameters 1 to 32

No. (Hex.)	Name	Description	Default (Range)
A2-01 to A2-32 (0106 - 0125)	User Parameters 1 to 32	<div style="display: flex; gap: 5px;"> <span style="border: 1px solid black; padding: 2px;">V/f</span> <span style="border: 1px solid black; padding: 2px;">OLV/PM</span> <span style="border: 1px solid black; padding: 2px;">EZOLV</span> </div> <p>You can select a maximum of 32 parameters for the drive and set them to parameters <i>A2-01 to A2-32</i>. The [User Parameters] section of the keypad main menu shows the set parameters. You can immediately access these set parameters.</p>	Parameters in No Preset Selected Mode (Determined by A1-01, A1-02, A1-07)

**Note:**

- When the *A1-06 [Application Preset]* value changes, the settings for *A2-01 to A2-32* change.
- You must set *A1-01 = 1 [Access Level Selection = User Parameters]* to access parameters *A2-01 to A2-32*.
- When *A1-07 = 1 or 2 [DriveWorksEZ Function Selection = DWEZ Enabled or Enabled/Disabled wDigital Input]*, the drive saves *qx-xx [DriveWorksEZ Parameters]* to *A2-01 to A2-32*.

The drive saves these parameters to *A2-01 to A2-32*.

- The drive saves a maximum of 32 parameters.

**Note:**

Set *A1-01 = 2 [Advanced Level]* or *A1-01 = 3 [Expert Level]* to save the necessary parameters.

- The drive automatically saves changed parameters to *A2-17 to A2-32*.

**Note:**

Set *A2-33 = 1 [User Parameter Auto Selection = Enabled: Auto Save Recent Parm]*.

### ■ A2-33: User Parameter Auto Selection

No. (Hex.)	Name	Description	Default (Range)
A2-33 (0126)	User Parameter Auto Selection	<div style="display: flex; gap: 5px;"> <span style="border: 1px solid black; padding: 2px;">V/f</span> <span style="border: 1px solid black; padding: 2px;">OLV/PM</span> <span style="border: 1px solid black; padding: 2px;">EZOLV</span> </div> <p>Sets the automatic save feature for changes to parameters <i>A2-17 to A2-32 [User Parameters 17 to 32]</i>.</p>	Determined by A1-06 (0, 1)

### 0 : Disabled: Manual Entry Required

Set User Parameters manually.

### 1 : Enabled: Auto Save Recent Parm

The drive automatically registers changed parameter *A2-17 to A2-32*. The drive automatically saves the most recently changed parameter to *A2-17*, and saves a maximum of 16 parameters. After the drive registers 16 parameters, when you save a new parameter, the drive will remove a parameter from the User Parameter list to make space for the new parameter. The drive removes parameters with First In, First Out.

You can show the registered parameters in [User Custom Parameters] in the main menu.

## 12.3 b: Application



*b* parameters set these functions:

- Frequency reference source/Run command source
- Stopping method settings
- DC Injection Braking
- Speed Search
- Timer Function
- PID control
- Energy Savings Control



### ◆ b1: Operation Mode Selection

*b1* parameters set the operation mode for the drive.

#### ■ b1-01: Frequency Reference Selection 1



No. (Hex.)	Name	Description	Default (Range)
b1-01 (0180)	Frequency Reference Selection 1	   Sets the input method for the frequency reference.	1 (0 - 3)

Note:

- Push  on the keypad to set the input mode to HAND and enter the frequency reference from the keypad.
- When the drive receives a Run command when the frequency reference is 0 Hz or less than the *E1-09* [Minimum Output Frequency] value,  on the keypad will flash. Examine the setting for the frequency reference input and enter a value  $\geq E1-09$ .

#### 0 : Keypad

The drive uses the keypad to enter the frequency reference and also switches the PID setpoint to *YA-01* [Setpoint 1].

Use  and  on the keypad to change the frequency reference.

#### 1 : Analog Input

The drive uses MFAI terminals A1 and A2 to input an analog frequency reference with a voltage or current input signal.

#### • Voltage Input

Refer to [Table 12.20](#) to use a voltage signal input to one of the MFAI terminals.

Table 12.20 Frequency Reference Voltage Input

Terminal	Terminal Signal Level	Parameter Settings				Note
		Signal Level Selection	Function Selection	Gain	Bias	
A1	0 - 10 V	H3-01 = 0	H3-02 = 0 [Frequency Reference]	H3-03	H3-04	Set Jumper Switch S1 to "V" for voltage input.
A2	0 - 10 V	H3-09 = 0	H3-10 = 0 [Frequency Reference]	H3-11	H3-12	Set Jumper Switch S1 to "V" for voltage input.

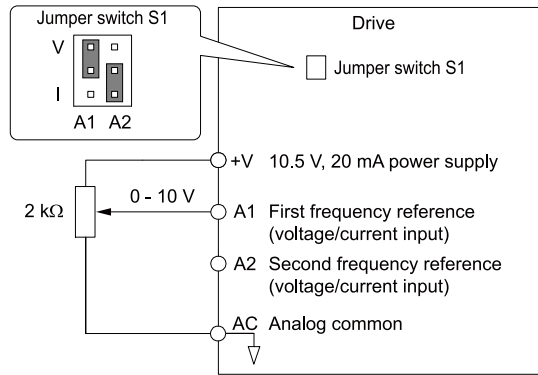

Figure 12.1 Example of Setting the Frequency Reference with a Voltage Signal to Terminal A1

**Note:**

You can also use this diagram to wire terminal A2.

• **Current Input**

Refer to [Table 12.21](#) to use a current signal input to one of the MFAI terminals.

Table 12.21 Frequency Reference Current Input

Terminal	Signal Level	Parameter Settings				Note
		Signal Level Selection	Function Selection	Gain	Bias	
A1	4 - 20 mA	H3-01 = 2	H3-02 = 0 [Frequency Reference]	H3-03	H3-04	Set Jumper Switch S1 to "I" for current input.
	0 - 20 mA	H3-01 = 3				
A2	4 - 20 mA	H3-09 = 2	H3-10 = 0 [Frequency Reference]	H3-11	H3-12	Set Jumper Switch S1 to "I" for current input.
	0 - 20 mA	H3-09 = 3				

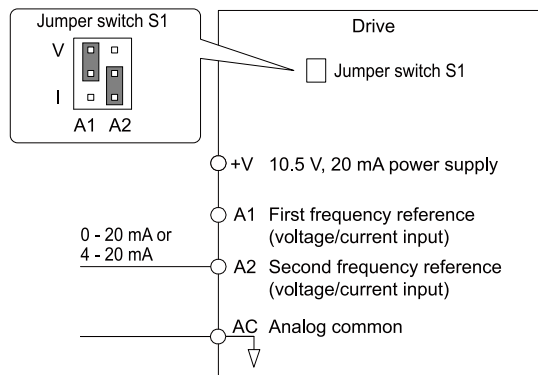

Figure 12.2 Example of Setting the Frequency Reference with a Current Signal to Terminal A2

**Note:**

You can also use this diagram to wire terminal A1.

Changing between Master and Auxiliary Frequency References

Use the multi-step speed reference function to change the frequency reference input between terminals A1 and A2.

**2 : Serial Communications**

The drive uses serial communications to enter the frequency reference.

**3 : Option PCB**

The drive uses a communications option card or input option card connected to the drive to enter the frequency reference.

Refer to the instruction manual included with the option card to install and set the option card.

**Note:**

If *b1-01* = 3, but you did not connect a communications option card, *oPE05 [Run Cmd/Freq Ref Source Sel Err]* will flash on the keypad.



## ■ b1-02: Run Command Selection 1

No. (Hex.)	Name	Description	Default (Range)
b1-02 (0181)	Run Command Selection 1	 Sets the input method for the Run command.	7 (0 - 9)

### 0 : Keypad

The drive uses the keypad to enter the Run command.

**Note:**

The  on the keypad is on while keypad is the Run command source.

### 1 : Digital Input

The drive uses the control circuit terminals to enter the Run command. Select the input method for the Run command with an *HI-xx* parameter.

Set *HI-xx* = 0, 40 to 43 [*3-Wire Sequence, Run Command (2-Wire Sequence)*]. The default setting is 2-wire sequence 1.

#### • 2-wire Sequence 1

This sequence has two input types: FWD/Stop and REV/Stop. Set *A1-03* = 2220 [*Initialize Parameters = 2-Wire Initialization*] to initialize the drive and set terminals S1 and S2 for a 2-wire sequence.

#### • 2-wire Sequence 2

This sequence has two input types: Run/Stop and FWD/REV.

#### • 3-Wire Sequence

This sequence has three input types: Run, Stop, and FWD/REV. Set *A1-03* = 3330 [*Initialize Parameters = 3-Wire Initialization*] to initialize the drive and set terminals S1, S2, and S5 for a 3-wire sequence.

### 2 : Serial Communications

The drive uses serial communications to enter the Run command.

### 3 : Option PCB

The drive uses a communications option card or input option card connected to the drive to enter the Run command. Refer to the instruction manual included with the option card to install and set the option card.

**Note:**

If *b1-02* = 3, but you did not connect an communications option card, *oPE05* [*Run Cmd/Freq Ref Source Sel Err*] will flash on the keypad.

### 7 : AUTO Command + Term Run

The drive uses the AUTO Command to put the drive into AUTO Mode, and use the terminal set for Run [*HI-xx* = 40, 41, or 42] to enter the Run command.

### 8 : AUTO Command + Serial Run

The drive uses the AUTO Command to put the drive into AUTO Mode, and use the Serial Run command (register 0001) to enter the Run command.

### 9 : AUTO Command + Option Run

The drive uses the AUTO Command to put the drive into AUTO Mode, and use a communications or input option connected to the drive to enter the Run command.

**Note:**

If you use these parameter settings at the same time, the drive will detect an *oPE05* [*Run Cmd/Freq Ref Source Sel Err*]:

- *S5-04* = 0 [*HAND-OFF-AUTO Behavior = Legacy*] and *b1-02* = 0 to 3
- *S5-10* = 2 [*AUTO Key Memory at Power Down = AUTO Mode*] and *b1-02* = 0

## ■ b1-03: Stopping Method Selection

No. (Hex.)	Name	Description	Default (Range)
b1-03 (0182)	Stopping Method Selection	 Sets the method to stop the motor after removing a Run command or entering a Stop command.	1 (0 - 3)

**Note:**

When  $A1-02 = 5$  or  $8$  [Control Method Selection = OLV/PM or EZOLV], the setting range is 0, 1, 3.

Select the applicable stopping method for the application from these four options:

**0 : Ramp to Stop**

When you enter the Stop command or turn OFF the Run command, the drive ramps the motor to stop.

The drive ramps the motor to stop as specified by the deceleration time. The default setting for the deceleration time is  $C1-02$  [Deceleration Time 1]. The actual deceleration time changes as the load conditions change (for example, mechanical loss and inertia).

If the output frequency is less than or equal to the value set in  $b2-01$  [DC Injection/Zero SpeedThreshold] during deceleration, the drive will do DC Injection Braking or Short Circuit Braking as specified by the control method.

• **Ramp to Stop with V/f Control Method**

Parameter  $b2-01$  sets the frequency to start DC Injection Braking at stop. If the output frequency is less than or equal to the value set in  $b2-01$  during deceleration, the drive will do DC Injection Braking for the time set in  $b2-04$  [DC Inject Braking Time at Stop].

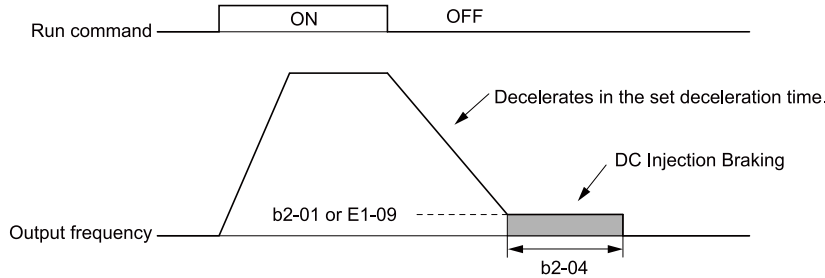

**b2-01: DC Injection/Zero SpeedThreshold**  
**b2-04: DC Inject Braking Time at Stop**

**E1-09: Minimum Output Frequency**

**Figure 12.3 Ramp to Stop with V/f Control Method**

**Note:**

When  $b2-01 \leq E1-09$  [Minimum Output Frequency], the drive will start DC Injection Braking from the frequency set in  $E1-09$ .

• **Ramp to Stop with OLV/PM and EZOLV Control Methods**

Parameter  $b2-01$  sets the frequency to start Short Circuit Braking. When the output frequency is less than or equal to the value set in  $b2-01$  during deceleration, the drive will do Short Circuit Braking for the time set in  $b2-13$  [Short Circuit Brake Time @ Stop]. When  $b2-04 \neq 0$ , the drive will do DC Injection Braking for the time set in  $b2-04$  when Short Circuit Braking is complete.

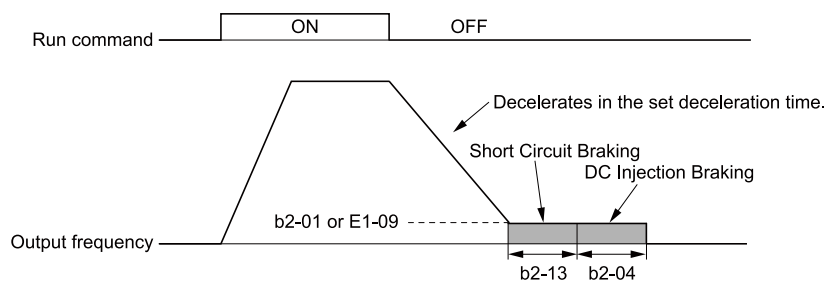

**b2-01: DC Injection/Zero SpeedThreshold**  
**b2-04: DC Inject Braking Time at Stop**

**b2-13: Short Circuit Brake Time @ Stop**  
**E1-09: Minimum Output Frequency**

**Figure 12.4 Ramp to Stop with OLV/PM and EZOLV Control Methods**

**Note:**

When  $b2-01 \leq E1-09$ , the drive will start Short Circuit Braking from the frequency set in  $E1-09$ .

If  $b2-01 = 0$  Hz and  $E1-09 = 0$  Hz, the drive will not do Short Circuit Braking.

**1 : Coast to Stop**

When you enter the Stop command or turn OFF the Run command, the drive turns OFF the output and coasts the motor to stop.

Load conditions will have an effect on the deceleration rate as the motor coasts to stop (for example, mechanical loss and inertia).

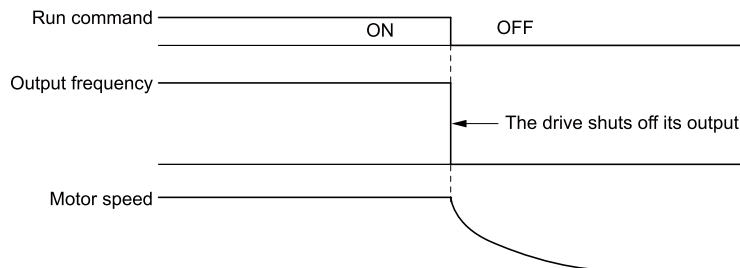

**Figure 12.5 Coast to Stop**

**Note:**

The drive ignores the Run command for the time set in *L2-03 [Minimum Baseblock Time]* when you enter a Stop command or switch OFF the Run command. Make sure that the motor stops completely before you enter a Run command. Use DC Injection or Speed Search to restart the motor before it stops.

## 2 : DC Injection Braking to Stop

When you enter the Stop command or turn OFF the Run command, the drive turns OFF the output for the time set in *L2-03*. The drive waits for the minimum baseblock time and then injects the amount of DC current into the motor set in *b2-02 [DC Injection Braking Current]* to stop the motor with DC current.

DC Injection Braking stops the motor more quickly than coast to stop.

**Note:**

If *A1-02 = 5*, DC Injection Braking to Stop is not available.

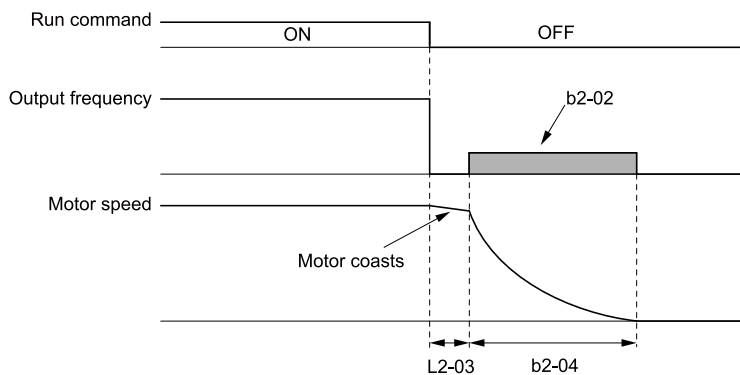

**b2-02: DC Injection Braking Current**  
**b2-04: DC Inject Braking Time at Stop**

**L2-03: Minimum Baseblock Time**

**Figure 12.6 DC Injection Braking to Stop**

The value set in *b2-04* and the output frequency when the drive receives the Stop command determine the DC Injection Braking time. The drive calculates the DC Injection Braking time as in [Figure 12.7](#).

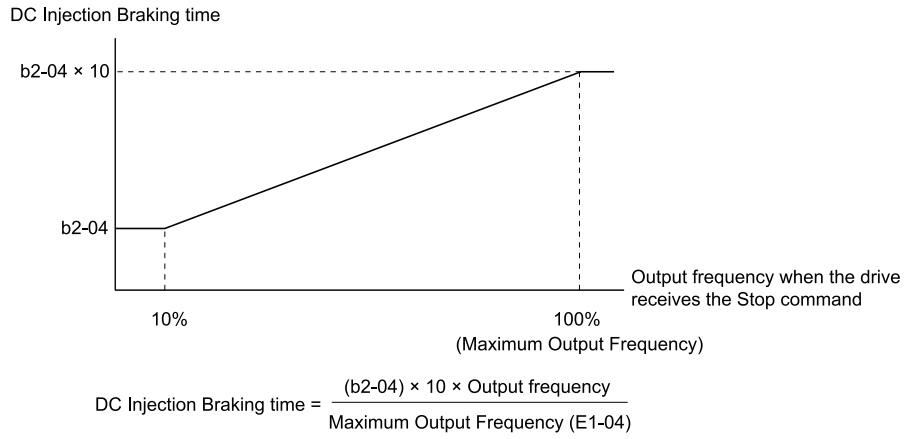

**b2-04: DC Inject Braking Time at Stop**

**E1-04: Maximum Output Frequency**

**Figure 12.7 DC Injection Braking Time and Output Frequency**

**Note:**

If the drive detects *oC* [Overcurrent] when it uses DC Injection Braking to stop the motor, set *L2-03* to a high value that will not trigger *oC*.

**3 : Coast to Stop with Timer**

When you enter the Stop command or turn OFF the Run command, the drive turns OFF the output and coasts the motor to stop. The drive ignores the Run command until the “Run wait time *t*” is expired.

To start the drive again, enter the Run command after the “Run wait time *t*” is expired.

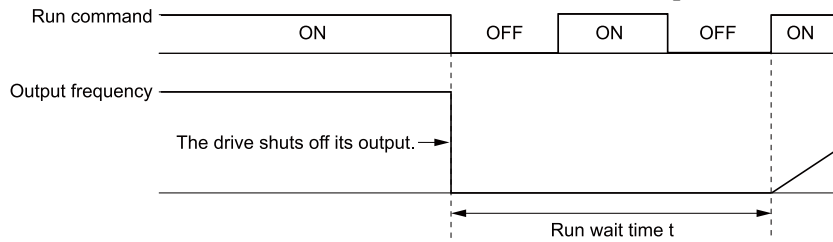

**Figure 12.8 Coast to Stop with Timer**

The active deceleration time and the output frequency when drive receives the Stop command determine the length of “Run wait time *t*”.

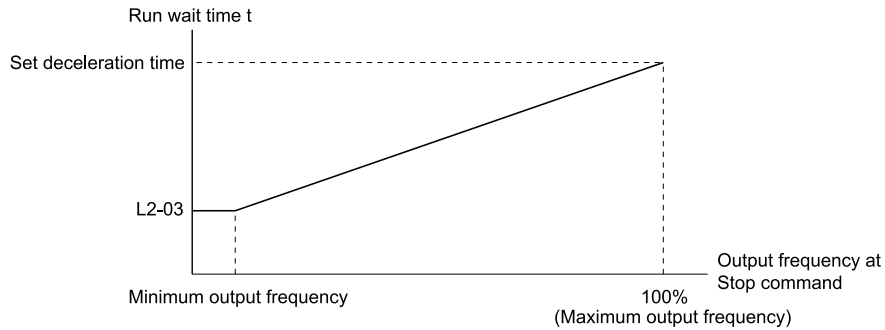

**L2-03: Minimum Baseblock Time**

**Figure 12.9 Run Wait Time and Output Frequency**

**■ b1-04: Reverse Operation Selection**

No. (Hex.)	Name	Description	Default (Range)
b1-04 (0183)	Reverse Operation Selection	<div style="display: flex; gap: 5px;"> <span style="border: 1px solid black; padding: 2px;">V/f</span> <span style="border: 1px solid black; padding: 2px;">OLV/PM</span> <span style="border: 1px solid black; padding: 2px;">EZOLV</span> </div> Sets the reverse operation function. Disable reverse operation in fan or pump applications where reverse rotation is dangerous.	1 (0, 1)

When reverse operation is prohibited, the drive will not accept a Reverse operation command.

### 0 : Reverse Enabled

The drive will accept a Reverse operation command.

### 1 : Reverse Disabled

The drive will not accept a Reverse operation command.

## ■ b1-08: Run Command Select in PRG Mode

No. (Hex.)	Name	Description	Default (Range)
b1-08 (0187)	Run Command Select in PRG Mode	 Sets the conditions for the drive to accept a Run command entered from an external source when using the keypad to set parameters.	0 (0 - 2)

As a safety precaution, when the drive is in Programming Mode, it will not respond to a Run command.

This parameter helps prevent accidents that can occur if the motor starts to rotate because the drive received a Run command from an external source while the user is programming the drive. You can also set the drive to not show the Programming Mode when a Run command is active.

#### Note:

Refer to this table for Drive Mode and Programming Mode functions.

Mode	Keypad Screen	Function
Drive Mode	Monitors	Sets monitor display.
Programming Mode	Parameters	Changes parameter settings.
	User Custom Parameters	Shows the User Parameters.
	Parameter Backup/Restore	Saves parameters to the keypad as backup.
	Modified Parameters/Fault Log	Shows modified parameters and fault history.
	Auto-Tuning	Auto-Tunes the drive.
	Initial Setup Screen	Changes initial settings.
	Diagnostic Tools	Sets data logs and backlight.

### 0 : Disregard RUN while Programming

The drive does not accept the Run command when setting the parameters in the Programming Mode.

### 1 : Accept RUN while Programming

The drive accepts a Run command entered from an external source when setting the parameters in Programming Mode.

### 2 : Allow Programming Only at Stop

The drive does not allow the user to enter the Programming Mode while the drive is operating. The keypad does not display the Programming Mode while the drive is operating.

## ■ b1-11: Run Delay @ Stop

No. (Hex.)	Name	Description	Default (Range)
b1-11 (01DF)	Run Delay @ Stop	 Sets the amount of time that the drive will not accept the Run command again after the Run command is removed.	0.0 s (0.0 - 6000.0 s)

#### Note:

- This parameter will operate for both AUTO Mode and HAND Mode.
- This parameter will operate when the drive goes to sleep then wakes up.
- The time set in this parameter does not apply for faults or Auto-Restarts.
- When there is an active Run command while the time set in *b1-11* is active, the keypad will show a *[Start Delay]* message as specified by the *o1-82 [Message Screen Display]* display format.

**Coast to Stop with Timer Function**

When  $b1-03 = 3$  [Stopping Method Selection = Coast to Stop with Timer], the drive operates as:

1. The drive operates at an output frequency > 0.
2. The Run command is removed and the drive coasts to stop.
3. The drive will set the coast-timer based on  $b1-11$ :
  - When  $b1-11 = 0.0\text{ s}$ ,  $C1-02$  [Deceleration Time 1] and the output frequency set the coast-timer.
  - When  $b1-11 > 0.0\text{ s}$ ,  $b1-11$  is the coast-timer.
4. When the drive receives the Run command again during the time set in  $b1-11$ , the drive will restart when the timer expires and it is not necessary to cycle the Run command.

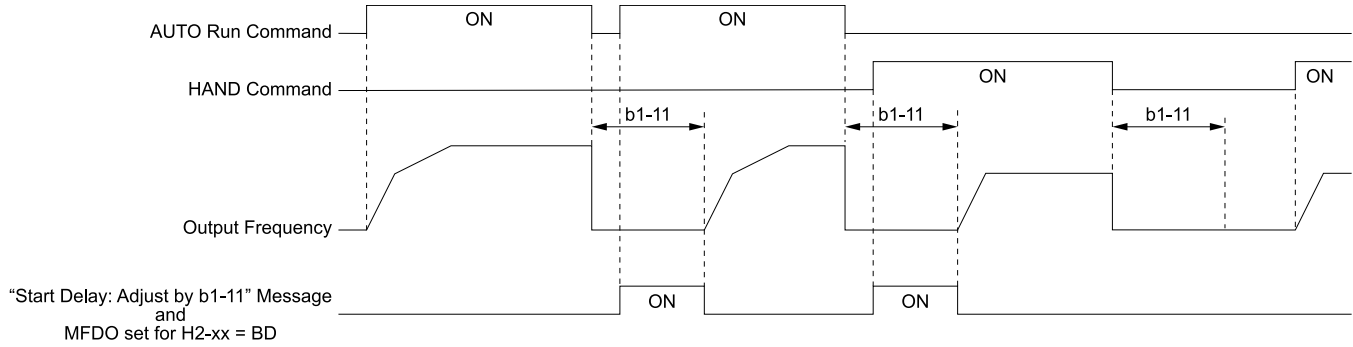

**b1-11: Run Delay @ Stop**

**H2-xx = BD: Start Delay**

**Figure 12.10 Coast To Stop With Timer when  $b1-11 > 0$**

**Ramp to Stop, Coast to Stop or DC Injection to Stop Functions when  $b1-03 \neq 3$**

When  $b1-03 = 0$  or  $2$  [Ramp to Stop or DC Injection Braking to Stop], the drive operates as:

1. The drive operates at an output frequency > 0.
2. When you remove the Run command or the drive goes to sleep, the  $b1-11$  timer immediately starts while ramping or coasting.
3. When the drive receives the Run command again during the time set in  $b1-11$ , the drive will restart when the timer expires and it is not necessary to cycle the Run command.

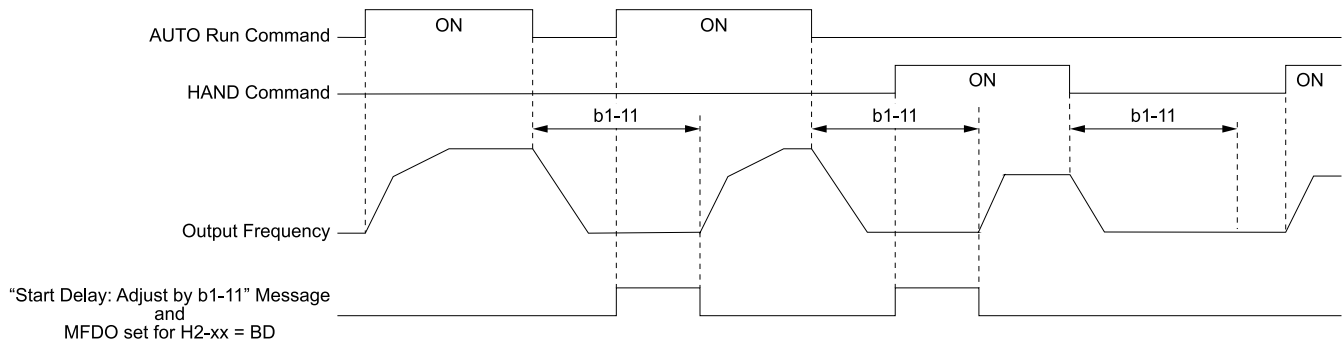

**b1-11: Run Delay @ Stop**

**H2-xx = BD: Start Delay**

**Figure 12.11 Ramp To Stop when  $b1-11 > 0$**

**■ b1-12: Run Delay Memory Selection**

No. (Hex.)	Name	Description	Default (Range)
b1-12 (01E0)	Run Delay Memory Selection	<div style="display: flex; gap: 5px;"> <span style="border: 1px solid black; padding: 2px;">V/f</span> <span style="border: 1px solid black; padding: 2px;">OLV/PM</span> <span style="border: 1px solid black; padding: 2px;">EZOLV</span> </div> Sets how the drive saves Run Delay Timer to the EEPROM during power loss.	2 (0 - 2)

**0 : Disabled**

The drive does not save the Run Delay timer during power loss.

When the drive power is restored, the drive will not apply the delay time set in  $b1-11$ .

Figure 12.12 shows the example of drive operation when:

- $b1-03 = 3$  [Stopping Method Selection = Coast to Stop with Timer]
- $b1-11 = 60.0\text{ s}$
- $b1-12 = 0$

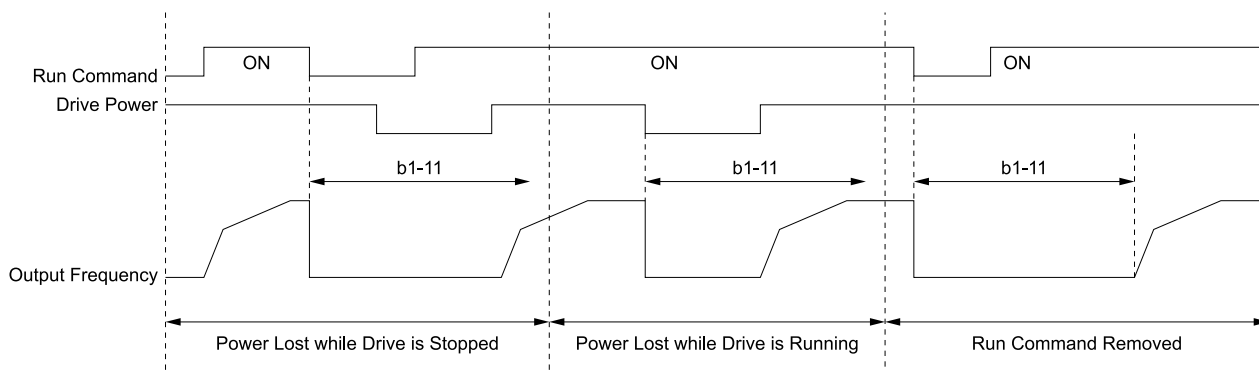

**b1-11: Run Delay @ Stop**

**Figure 12.12 Run Delay Memory Disabled**

### 1 : Only at Stop

The drive saves Run Delay timer only when the drive is stopped.

When the drive is running and it loses power, the drive will not apply the delay time set in  $b1-11$  when power is restored. When the drive is stopped with  $b1-11$  counting down and it loses power, the drive will apply the delay time set in  $b1-11$  based on the time elapsed during the power outage.

Figure 12.13 shows the example of drive operation when:

- $b1-03 = 3$
- $b1-11 = 60.0\text{ s}$
- $b1-12 = 1$

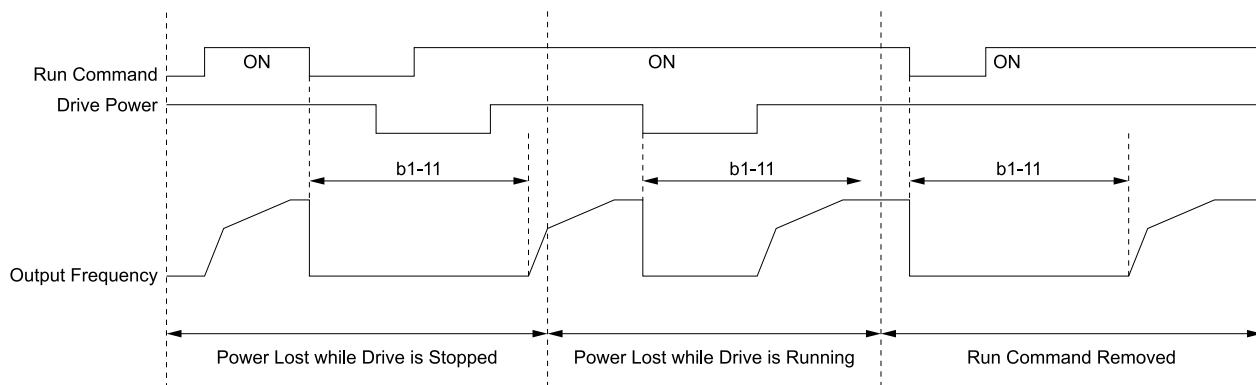

**b1-11: Run Delay @ Stop**

**Figure 12.13 Run Delay Memory Only at Stop**

### 2 : Running & Stop

The drive always saves the Run Delay timer.

When the drive is running and it loses power, the drive will save-off the maximum delay time set in  $b1-11$ . When power is restored, the drive will apply that time minus the time elapsed during the power outage. When the drive is stopped with  $b1-11$  counting down and it loses power, the drive will apply the delay time set in  $b1-11$  based on the time elapsed during the power outage.

Figure 12.14 shows the example of drive operation when:

- $b1-03 = 3$

## 12.3 b: Application

- $b1-11 = 60.0\text{ s}$
- $b1-12 = 2$

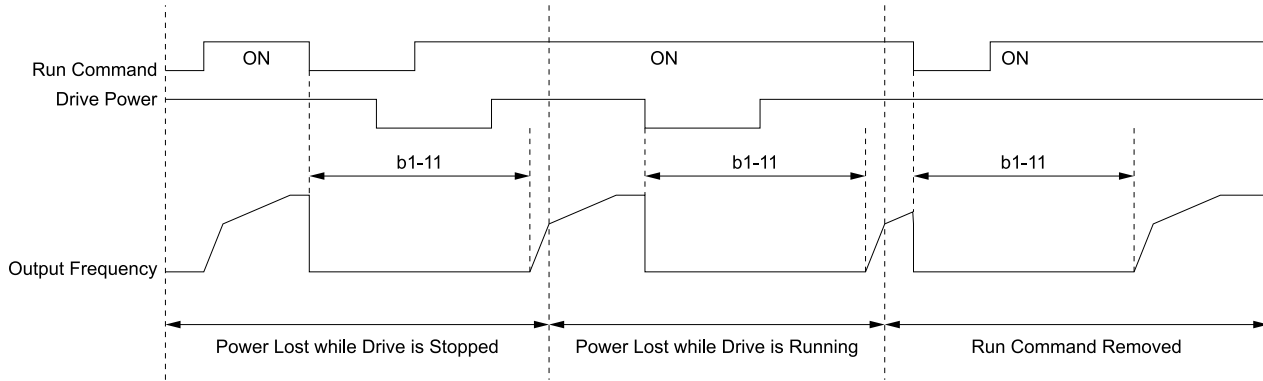

**b1-11: Run Delay @ Stop**

**Figure 12.14 Run Delay Memory Running & Stop**

### ■ b1-14: Phase Order Selection

No. (Hex.)	Name	Description	Default (Range)
b1-14 (01C3)	Phase Order Selection	<input type="checkbox"/> V/f <input type="checkbox"/> OL/PM <input type="checkbox"/> EZOLV Sets the phase order for output terminals U/T1, V/T2, and W/T3. This parameter can align the Forward Run command from the drive and the forward direction of the motor without changing wiring.	0 (0, 1)

**Note:**

When you use A1-03 [Initialize Parameters] to initialize the drive, the drive will not reset this parameter.

**0 : Standard**

**1 : Switch Phase Order**

### ■ b1-17: Run Command at Power Up

No. (Hex.)	Name	Description	Default (Range)
b1-17 (01C6)	Run Command at Power Up	<input type="checkbox"/> V/f <input type="checkbox"/> OL/PM <input type="checkbox"/> EZOLV Sets drive response when the CPU changes from de-energized to energized and there is an active Run command. Set this parameter in applications where energizing or de-energizing the drive enables the Run command. When the CPU stays energized during loss of power, L2-01 [Power Loss Ride Through Select] sets operation.	1 (0, 1)

#### 0 : Disregard Existing RUN Command

The drive does not start to operate the application when you apply power, even when there is an existing Run command.

Enter the Run command again to operate the application.

**Note:**

When you energize the drive, if there is an existing Run command enabled from an external source,  on the keypad will flash quickly.

#### 1 : Accept Existing RUN Command

When there is an existing Run command, the drive starts to operate the application when you apply power.

**WARNING! Sudden Movement Hazard.** When you use a 3-Wire sequence, set A1-03 = 3330 [Initialize Parameters = 3-Wire Initialization] and make sure that b1-17 = 0 [Run Command at Power Up = Disregard Existing RUN Command] (default). If you do not correctly set the drive parameters for 3-Wire operation before you energize the drive, the motor can suddenly rotate when you energize the drive.



## ■ b1-40: Deceleration Abort Time

No. (Hex.)	Name	Description	Default (Range)
b1-40 (3BCF)	Deceleration Abort Time	<b>V/f</b> <b>OLV/PM</b> <b>EZOLV</b> Sets the maximum time until the drive shuts off the output to decelerate to stop.	0.0 s (0.0 - 6000.0 s)

### Note:

Set this parameter to 0.0 s to disable this function.

When  $b1-40 > 0.0$  s, the drive will coast-to-stop when you remove the Run command and decelerate for the time set in  $b1-40$ . Refer to [Figure 12.15](#) for the timing chart.

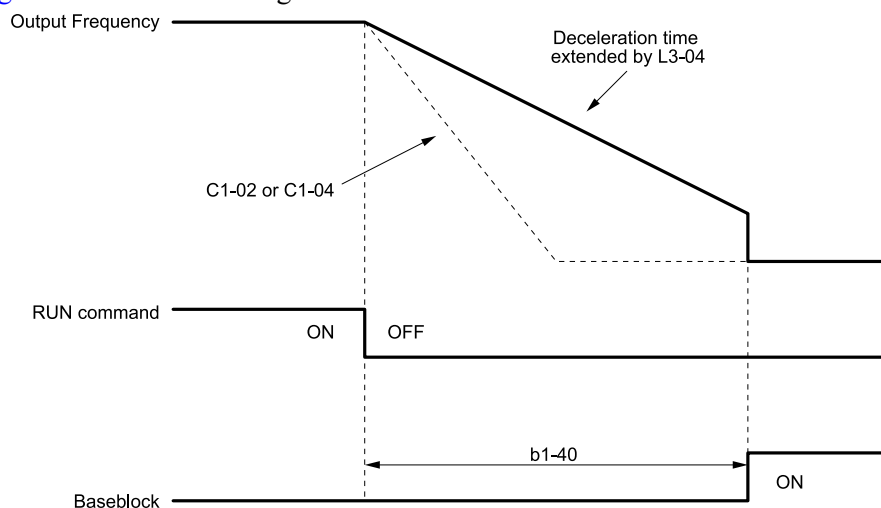

**b1-40: Deceleration Abort Time**  
**C1-02: Deceleration Time 1**

**C1-04: Deceleration Time 2**  
**L3-04: Stall Prevention during Decel**

Figure 12.15 Deceleration Abort Time Chart

## ◆ b2: DC Injection Braking and Short Circuit Braking

$b2$  parameters set the DC Injection Braking and Short Circuit Braking functions.

- DC Injection Braking: A braking method that injects DC current into the motor windings. This function should not be used too frequently, because it generates a fair amount of heat in the motor.
- Short Circuit Braking: A braking method for PM motors.

### ■ b2-01: DC Injection/Zero SpeedThreshold

No. (Hex.)	Name	Description	Default (Range)
b2-01 (0189)	DC Injection/Zero SpeedThreshold	<b>V/f</b> <b>OLV/PM</b> <b>EZOLV</b> Sets the frequency to start DC Injection Braking or Short Circuit Braking near the end of a stop ramp.	Determined by A1-02 (0.0 - 10.0 Hz)

### Note:

This parameter is available when  $b1-03 = 0$  [Stopping Method Selection = Ramp to Stop].

When the control method selected in  $A1-02$  [Control Method Selection] changes, the  $b2-01$  function changes.

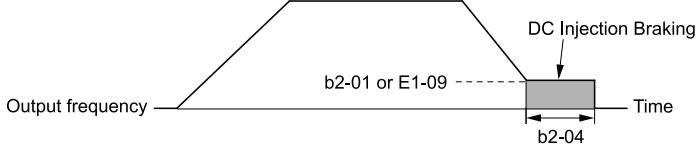
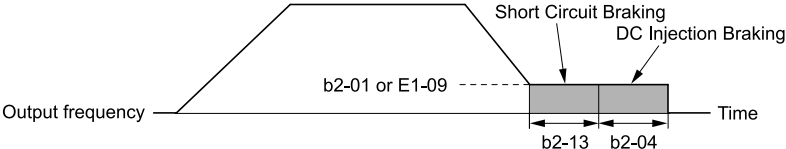
A1-02 Settings	Function of b2-01
0 [V/f]	<p>b2-01 sets the frequency to start DC Injection Braking at stop. When the output frequency is less than or equal to the value set in b2-01, the drive will inject the quantity of DC current set in b2-02 [DC Injection Braking Current] into the motor for the time set in b2-04 [DC Inject Braking Time at Stop].</p>  <p><b>b2-01: DC Injection/Zero SpeedThreshold    E1-09: Minimum Output Frequency</b>  <b>b2-04: DC Inject Braking Time at Stop</b></p> <p><b>Figure 12.16 DC Injection Braking at Stop</b></p> <p><b>Note:</b>  When <math>b2-01 \leq E1-09</math> [Minimum Output Frequency], the drive will start DC Injection Braking from the frequency set in E1-09.</p>
5, 8 [OLV/PM, EZOLV]	<p>b2-01 sets the frequency to start Short Circuit Braking at stop. When the output frequency is less than or equal to the value set in b2-01, the drive will do Short Circuit Braking for the time set in b2-13 [Short Circuit Brake Time @ Stop]. When b2-04 &gt; 0.00 s, the drive will complete Short Circuit Braking, then do DC Injection Braking for the time set in b2-04.</p>  <p><b>b2-01: DC Injection/Zero SpeedThreshold    b2-13: Short Circuit Brake Time @ Stop</b>  <b>b2-04: DC Inject Braking Time at Stop    E1-09: Minimum Output Frequency</b></p> <p><b>Figure 12.17 Short Circuit Braking at Stop</b></p> <p><b>Note:</b>  When <math>b2-01 \leq E1-09</math>, the drive will start Short Circuit Braking from the frequency set in E1-09. If <math>b2-01</math> and <math>E1-09 = 0</math> Hz, the drive will not do Short Circuit Braking.</p>

■ **b2-02: DC Injection Braking Current**

No. (Hex.)	Name	Description	Default (Range)
b2-02 (018A)	DC Injection Braking Current	<div style="display: flex; align-items: center;"> <span style="border: 1px solid black; padding: 2px;">V/f</span> <span style="border: 1px solid black; padding: 2px; margin-left: 5px;">OLV/PM</span> <span style="border: 1px solid black; padding: 2px; margin-left: 5px;">EZOLV</span> </div> <p>Sets the DC Injection Braking current as a percentage of the drive rated current.</p>	50% (0 - 100%)

When the DC Injection Braking current is more than 50%, the drive decreases the carrier frequency to 1 kHz. The motor rated current determines the quantity of DC Injection Braking current that the drive can use.

The DC Injection Braking current level has an effect on the strength of the magnetic field that locks the motor shaft. As the current level increases, the motor windings will supply more heat. Do not set this parameter higher than the level that is necessary to hold the motor shaft.

■ **b2-03: DC Inject Braking Time at Start**

No. (Hex.)	Name	Description	Default (Range)
b2-03 (018B)	DC Inject Braking Time at Start	<div style="display: flex; align-items: center;"> <span style="border: 1px solid black; padding: 2px;">V/f</span> <span style="border: 1px solid black; padding: 2px; margin-left: 5px;">OLV/PM</span> <span style="border: 1px solid black; padding: 2px; margin-left: 5px;">EZOLV</span> </div> <p>Sets the DC Injection Braking Time at start.</p>	0.00 s (0.00 - 10.00 s)

This function stops then restarts a coasting motor and increases motor flux to make high starting torque (a process called initial excitation). Set this parameter to 0.00 to disable the function.

**Note:**

To restart a coasting motor, use DC Injection Braking to stop and then restart the motor, or enable Speed Search. Enable DC Injection Braking or Speed Search to prevent *ov* [Overvoltage] and *oC* [Overcurrent] faults.

### ■ b2-04: DC Inject Braking Time at Stop

No. (Hex.)	Name	Description	Default (Range)
b2-04 (018C)	DC Inject Braking Time at Stop	<input checked="" type="checkbox"/> V/f <input checked="" type="checkbox"/> OLV/PM <input checked="" type="checkbox"/> EZOLV Sets the DC Injection Braking Time at stop.	0.00 s (0.00 - 10.00 s)

This function fully stops a motor with a large inertia during deceleration and will not let the inertia continue to rotate the motor.

Set this parameter to 0.00 to disable the function.

When a longer time is necessary to stop the motor, increase the value.

### ■ b2-09: Pre-heat Current 2

No. (Hex.)	Name	Description	Default (Range)
b2-09 (01E1)	Pre-heat Current 2	<input checked="" type="checkbox"/> V/f <input checked="" type="checkbox"/> OLV/PM <input checked="" type="checkbox"/> EZOLV Sets the percentage of motor rated output current used with MFDI HI-xx = 50 [MFDI Function Selection = Motor Pre-heat 2] for the motor pre-heat function.	5% (0 - 100%)

### ■ b2-12: Short Circuit Brake Time @ Start

No. (Hex.)	Name	Description	Default (Range)
b2-12 (01BA)	Short Circuit Brake Time @ Start	<input checked="" type="checkbox"/> V/f <input checked="" type="checkbox"/> OLV/PM <input checked="" type="checkbox"/> EZOLV Sets the Short Circuit Braking time at start.	0.00 s (0.00 - 25.50 s)

This function stops and restarts a coasting PM motor. The drive short circuits all the three motor phases to make braking torque in the motor.

Set this parameter to 0.00 to disable the function.

**Note:**

Short circuit Braking will let external forces rotate the PM motor. Use DC Injection Braking to prevent motor rotation from external forces.

### ■ b2-13: Short Circuit Brake Time @ Stop

No. (Hex.)	Name	Description	Default (Range)
b2-13 (01BB)	Short Circuit Brake Time @ Stop	<input checked="" type="checkbox"/> V/f <input checked="" type="checkbox"/> OLV/PM <input checked="" type="checkbox"/> EZOLV Sets the Short Circuit Braking time at stop.	Determined by A1-02 (0.00 - 25.50 s)

This function fully stops a PM motor with a large inertia during deceleration and will not let the inertia continue to rotate the motor.

Short Circuit Braking operates for the time set in *b2-13* when output frequency is less than the value set in *b2-01* [DC Injection/Zero SpeedThreshold] or *E1-09* [Minimum Output Frequency].

Set this parameter to 0.00 to disable the function.

### ■ b2-18: Short Circuit Braking Current

No. (Hex.)	Name	Description	Default (Range)
b2-18 (0177)	Short Circuit Braking Current	<input checked="" type="checkbox"/> V/f <input checked="" type="checkbox"/> OLV/PM <input checked="" type="checkbox"/> EZOLV Sets the Short Circuit Braking Current as a percentage of the motor rated current.	100.0% (0.0 - 200.0%)

**Note:**

Parameter *A1-02* [Control Method Selection] selects which parameter is the motor rated current.

- *A1-02* = 5 [OLV/PM]: *E5-03* [PM Motor Rated Current (FLA)]

- *A1-02* = 8 [EZOLV]: *E9-06* [Motor Rated Current (FLA)]

The Short Circuit Braking current cannot be higher than the drive rated current, although you can use *b2-18* to set a higher current level. The maximum rated current is 120%.

## ◆ b3: Speed Search

The Speed Search function detects the actual speed of a coasting motor, then restarts the motor before the motor stops. Use Speed Search in these conditions:

- To continue operation after momentary power loss
- To switch from commercial power supply to drive power
- To restart a coasting fan

For example, the drive output turns off and the motor coasts when there is a momentary loss of power. After you return power, the drive does Speed Search on the coasting motor, and restarts the motor from the detected speed.

When you use a PM motor, enable *b3-01 [Speed Search at Start Selection]*.

There are two types of Speed Search for induction motors: Current Detection and Speed Estimation. Use parameter *b3-24 [Speed Search Method Selection]* to select the type of Speed Search.

Parameter settings are different for different types of Speed Search. Refer to [Table 12.22](#) for more information.

### Note:

Cells marked with "x" apply and cells marked with "-" do not apply.

**Table 12.22 Speed Search and Related Parameters**

Parameters	Speed Estimation	Current Detection 2
	b3-24 = 1	b3-24 = 2
b3-01 [Speed Search at Start Selection]	x	x
b3-02 [SpeedSearch Deactivation Current]	x	-
b3-03 [Speed Search Deceleration Time]	-	x
b3-04 [V/f Gain during Speed Search]	x	-
b3-05 [Speed Search Delay Time]	x	x
b3-06 [Speed Estimation Current Level 1]	x	-
b3-07 [Speed Estimation Current Level 2]	x	-
b3-08 [Speed Estimation ACR P Gain]	x	-
b3-09 [Speed Estimation ACR I Time]	x	-
b3-10 [Speed Estimation Detection Gain]	x	-
b3-11 [Spd Est Method Switch-over Level]	x	-
b3-12 [Speed Search Current Deadband]	x	-
b3-14 [Bi-directional Speed Search]	x	x
b3-17 [Speed Est Retry Current Level]	x	x
b3-18 [Speed Est Retry Detection Time]	x	x
b3-19 [Speed Search Restart Attempts]	x	x
b3-25 [Speed Search Wait Time]	x	x
b3-26 [Direction Determination Level]	x	-
b3-27 [Speed Search RUN/BB Priority]	x	x
b3-29 [Speed Search Back-EMF Threshold]	-	-
b3-31 [Spd Search Current Reference Lvl]	-	x
b3-32 [Spd Search Current Complete Lvl]	-	x
b3-39 [Regen Judgment Lv of Spd Search]	-	x
b3-54 [Search Time]	-	-
b3-55 [Current Increment Time]	-	-
b3-56 [InverseRotationSearch WaitTime]	-	x

**Note:**

- To use Speed Estimation Speed Search with V/f Control, do Rotational Auto-Tuning before you set the Speed Search function. If the wire length between the drive and motor changed since the last time you did Auto-Tuning, do Stationary Auto-Tuning for Line-to-Line Resistance process again.
- If  $A1-02 = 5$  [PM Open Loop Vector] and the wiring distance between the motor and drive is long or if the motor is coasting at more than or equal to 200 Hz, do not use Speed Search to restart the motor. Use Short Circuit Braking.

## ■ Current Detection 2

Use this Speed Search function with induction motors. Set  $b3-24 = 2$  [Speed Search Method Selection = Current Detection 2]. Current Detection Speed Search injects current into the motor to detect the speed of an induction motor. Speed Search increases the output voltage for the time set in  $L2-04$  [Powerloss V/f Recovery Ramp Time], starting from the maximum output frequency or the frequency reference.

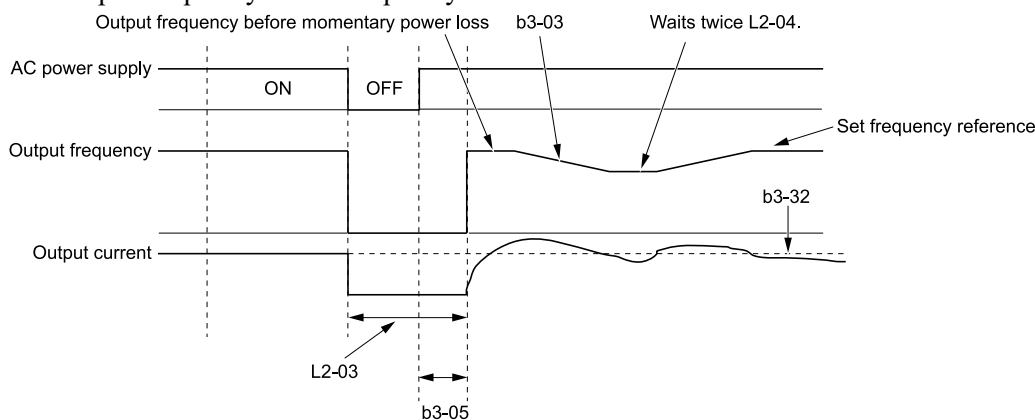

**b3-03: Speed Search Deceleration Time**

**b3-05: Speed Search Delay Time**

**b3-32: Spd Search Current Complete Lvl**

**L2-03: Minimum Baseblock Time**

**L2-04: Powerloss V/f Recovery Ramp Time**

**Figure 12.18 Current Detection 2 after a Momentary Power Loss**

**Note:**

After you restore power, the drive will not do Speed Search until the time set in  $b3-05$  [Speed Search Delay Time] expires. This means that the drive will not always start Speed Search when time set in  $L2-03$  [Minimum Baseblock Time] expires.

If you enter the Run command at the same time as Speed Search, the drive will not do Speed Search until the time set in  $L2-03$  expires. When  $L2-03 < b3-05$ , the drive will use the wait time set in  $b3-05$ .

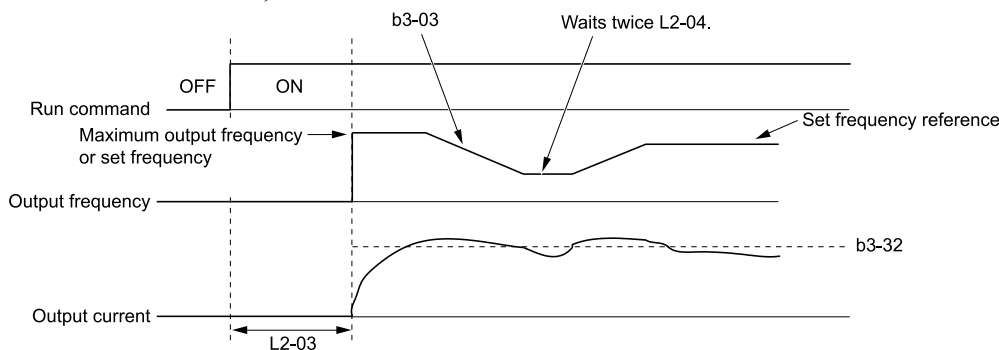

**b3-03: Speed Search Deceleration Time**

**b3-32: Spd Search Current Complete Lvl**

**L2-03: Minimum Baseblock Time**

**L2-04: Powerloss V/f Recovery Ramp Time**

**Figure 12.19 Speed Search Selection at Start (Current Detection Type)**

**WARNING!** Sudden Movement Hazard. Do not do Current Detection Speed Search with light loads or a stopped motor. If you do Auto-Tuning in these conditions, the motor can suddenly accelerate and cause serious injury or death.

**Note:**

- You cannot use Current Detection Speed Search with PM motors.
- If the drive detects *oL1* [Motor Overload] during Current Detection Speed Search, decrease *b3-03*.
- If the drive detects *oC* [Overcurrent] or *ov* [Overvoltage] during Current Detection Speed Search after the drive recovers from a momentary power loss, increase *L2-03*.
- If *b3-01* = 1 [Speed Search at Start Selection = Enabled], too much current will flow when the motor starts. If there is too much current at start it will decrease the service life of the drive IGBTs over time.

■ **Speed Estimation**

Use this Speed Search function with induction motors. Set *b3-24* = 1 [Speed Search Method Selection = Speed Estimation]. This function uses less current and has a shorter search time than other functions. This function lets you do Speed Search when the motor is rotating in reverse. When you return power after a power loss, the motor will not suddenly accelerate.

**Note:**

You cannot do Speed Estimation Speed Search in these conditions:

- When you operate more than one motor with one drive
- When you use a high-speed motor (200 Hz or higher)
- When you use a 1.5 kW or smaller motor.
- When the motor output is more than 1 frame size smaller than the drive capacity
- When there is a long wiring distance between the drive and motor

For these conditions, use Current Detection Speed Search.

Speed Estimation Speed Search uses these two steps to estimate the motor speed:

1. Residual Voltage Search

When there is a short baseblock time, the drive searches for residual voltage. The drive uses the residual voltage in the motor to estimate the motor speed and direction of rotation. The drive outputs the estimated motor speed as frequency, then uses the deceleration rate set in *L2-04* to increase the voltage. When the output voltage aligns with the V/f pattern, the drive accelerates or decelerates the motor to the frequency reference. If the drive cannot estimate the motor speed because of low residual voltage, it will automatically do Current Injection.

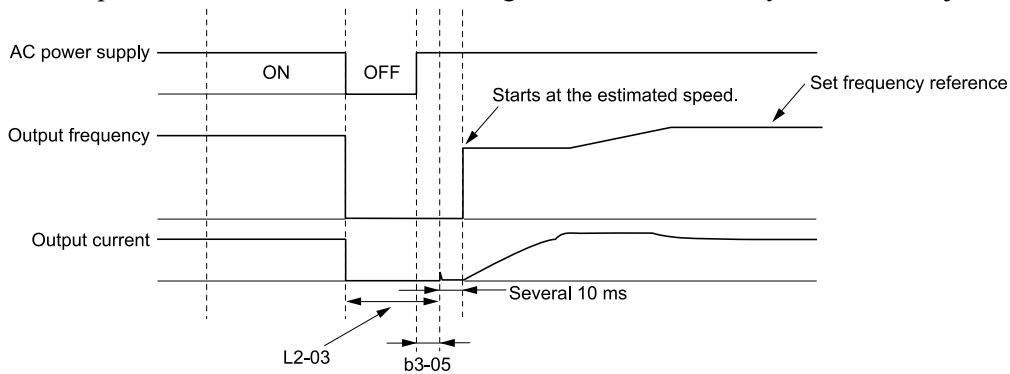

**b3-05: Speed Search Delay Time**

**L2-03: Minimum Baseblock Time**

**Figure 12.20 Speed Search after Baseblock**

**Note:**

After you return power, the drive waits for the time set in *b3-05*. When power loss is longer than the time set in *L2-03*, the drive will start Speed Search when the time set in *b3-05* is expired after the power recovery.

2. Current Injection

If there is not sufficient residual voltage in the motor, the drive does Current Injection. The drive injects the quantity of DC current set in *b3-06* [Speed Estimation Current Level 1] into the motor windings to estimate the motor speed and direction of rotation. The drive outputs the estimated motor speed as frequency, then uses the deceleration rate set in *L2-04* to increase the voltage. When the output voltage aligns with the V/f pattern, the drive accelerates or decelerates the motor to the frequency reference.

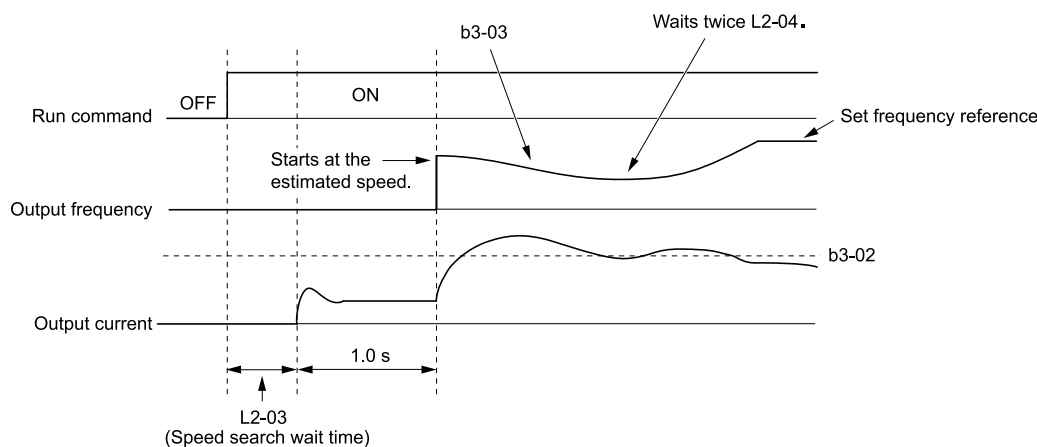

**b3-02: SpeedSearch Deactivation Current**  
**b3-03: Speed Search Deceleration Time**

**L2-03: Minimum Baseblock Time**  
**L2-04: Powerloss V/f Recovery Ramp Time**

**Figure 12.21 Speed Search Selection at Start**

**Note:**

Set the lower limit of the delay time to *b3-05* for when Speed Search starts.

## Speed Search Operation Conditions

These conditions apply to Speed Search operation. When  $A1-02 = 0$  [Control Method Selection = V/f Control], set *b3-24* [Speed Search Method Selection] before you do Speed Search.

- Do Speed Search with each Run Command  
The drive ignores a Speed Search command from the external terminals.
- Use an MFDI to do an External Speed Search Command  
To use an MFDI to do Speed Search, input the Run command at the same time that terminal Sx set for Speed Search activates, or after Speed Search activates.  
Set Speed Search to *H1-xx* to do the function externally. You cannot set external Speed Search 1 and 2 at the same time.

**Table 12.23 Execute Speed Search via the Digital Input Terminals**

H1-xx Setting	Name	Current Detection 2	Speed Estimation
61	Speed Search from Fmax	ON: Speed Search starts from <i>E1-04</i> [Maximum Output Frequency].	External Speed Search commands 1 and 2 work the same.
62	Speed Search from Fref	ON: Speed Search starts from the frequency reference immediately before you input the Speed Search command.	The drive estimates the motor speed, then starts Speed Search from the estimated speed.

- Do Speed Search with Each Auto Restart  
Set *L5-01* [Number of Auto-Restart Attempts] = 1 or more. After an Auto Restart fault, the drive automatically does Speed Search.
- Do Speed Search after Momentary Power Loss  
Set *L2-01* = 1, 2 [Power Loss Ride Through Select = Enabled for L2-02 Time, Enabled while CPU Power Active].
- Do Speed Search after You Clear the External Baseblock Command  
When there is an active Run command and the output frequency is higher than the minimum frequency, clear the external baseblock command to do Speed Search.

## b3-01: Speed Search at Start Selection

No. (Hex.)	Name	Description	Default (Range)
b3-01 (0191)	Speed Search at Start Selection	<input type="checkbox"/> V/f <input type="checkbox"/> OLVP/M <input type="checkbox"/> EZOLV Sets the drive to do a Speed Search each time the drive receives a Run command.	0 (0, 1)

### 0 : Disabled

Enter a Run command to start to operate the drive at the minimum output frequency.

## 12.3 b: Application

When you enable the Run command and input the *Speed Search from Fmax or Fref* [H1-xx = 61, 62] from a multi-function input terminal, the drive will do Speed Search and start to operate the motor.

### 1 : Enabled

Enter the Run command to do Speed Search. The drive completes Speed Search then starts to operate the motor.

#### Note:

If you set  $b3-01 = 1$  when  $b3-24 = 2$  [Speed Search Method Selection = Current Detection 2], too much current flows at start. Too much current at start will decrease the service life of the drive IGBT.

### ■ b3-02: SpeedSearch Deactivation Current

No. (Hex.)	Name	Description	Default (Range)
b3-02 (0192)	SpeedSearch Deactivation Current	<div style="display: flex; gap: 5px;"> <span>V/f</span> <span>OLV/PM</span> <span>EZOLV</span> </div> Sets the current level that stops Speed Search as a percentage of the drive rated output current. Usually it is not necessary to change this setting.	120% (0 - 200%)

If the drive cannot restart the motor, decrease this setting.

### ■ b3-03: Speed Search Deceleration Time

No. (Hex.)	Name	Description	Default (Range)
b3-03 (0193)	Speed Search Deceleration Time	<div style="display: flex; gap: 5px;"> <span>V/f</span> <span>OLV/PM</span> <span>EZOLV</span> </div> Sets the deceleration time during Speed Search operation. Set the length of time to decelerate from the maximum output frequency to the minimum output frequency.	2.0 s (0.1 - 10.0 s)

This is the output frequency deceleration time used by Current Detection Speed Search and by the Current Injection Method of Speed Estimation Speed Search.

#### Note:

- When  $A1-02 = 8$  [Control Method Selection = EZOLV], this parameter takes effect only in Expert Mode.
- If the drive detects  $oL1$  [Motor Overload] during Current Detection Speed Search, decrease the value set in  $b3-03$ .

### ■ b3-04: V/f Gain during Speed Search

No. (Hex.)	Name	Description	Default (Range)
b3-04 (0194)	V/f Gain during Speed Search	<div style="display: flex; gap: 5px;"> <span>V/f</span> <span>OLV/PM</span> <span>EZOLV</span> </div> Sets the ratio used to reduce the V/f during searches to reduce the output current during speed searches.	Determined by $\alpha 2-04$ (10 - 100)

Use this formula to calculate the output voltage during Speed Search:

Output voltage during Speed Search = Configured V/f  $\times$  b3-04

When the current detection search operates correctly, this configuration is not necessary.

### ■ b3-05: Speed Search Delay Time

No. (Hex.)	Name	Description	Default (Range)
b3-05 (0195)	Speed Search Delay Time	<div style="display: flex; gap: 5px;"> <span>V/f</span> <span>OLV/PM</span> <span>EZOLV</span> </div> Sets the Speed Search delay time to activate a magnetic contactor installed between the drive and motor.	0.2 s (0.0 - 100.0 s)

When you use a magnetic contactor between the drive and motor, you must close the contactor before the drive will do Speed Search. This parameter sets a delay time to activate the magnetic contactor.

### ■ b3-06: Speed Estimation Current Level 1

No. (Hex.)	Name	Description	Default (Range)
b3-06 (0196) Expert	Speed Estimation Current Level 1	<div style="display: flex; gap: 5px;"> <span>V/f</span> <span>OLV/PM</span> <span>EZOLV</span> </div> Sets the level of current that flows to the motor during Speed Estimation Speed Search as a coefficient of the motor rated current. Usually it is not necessary to change this setting.	Determined by $\alpha 2-04$ (0.0 - 2.0)



When the speed estimation value is the minimum output frequency, increase this setting. You can do this when the motor coasts at a high speed while the drive estimates the speed during Speed Estimation Speed Search. The limit of the output current during speed search is automatically the drive rated current.

**Note:**

When the drive cannot accurately estimate the speed after you adjust this parameter, use Current Detection Speed Search.

### ■ b3-07: Speed Estimation Current Level 2

No. (Hex.)	Name	Description	Default (Range)
b3-07 (0197) Expert	Speed Estimation Current Level 2	<div style="display: flex; gap: 5px;"> <span>V/f</span> <span>OLV/PM</span> <span>EZOLV</span> </div> <p>Sets the level of current that flows to the motor during Speed Estimation Speed Search as a coefficient of E2-03 [Motor No-Load Current] or E4-03 [Motor 2 Rated No-Load Current]. Usually it is not necessary to change this setting.</p>	1.0 (0.0 - 3.0)

During Speed Estimation Speed Searches, when the speed estimation value aligns with the minimum output frequency, increase the setting value in 0.1-unit increments. The limit of the output current during speed search is automatically the drive rated current.

### ■ b3-08: Speed Estimation ACR P Gain

No. (Hex.)	Name	Description	Default (Range)
b3-08 (0198)	Speed Estimation ACR P Gain	<div style="display: flex; gap: 5px;"> <span>V/f</span> <span>OLV/PM</span> <span>EZOLV</span> </div> <p>Sets the proportional gain for the automatic current regulator during Speed Estimation Speed Search. Also adjusts speed search responsiveness. Usually it is not necessary to change this setting.</p>	Determined by A1-02 and o2-04 (0.00 - 6.00)

### ■ b3-09: Speed Estimation ACR I Time

No. (Hex.)	Name	Description	Default (Range)
b3-09 (0199)	Speed Estimation ACR I Time	<div style="display: flex; gap: 5px;"> <span>V/f</span> <span>OLV/PM</span> <span>EZOLV</span> </div> <p>Sets the integral time for the automatic current regulator during Speed Estimation Speed Search. Also adjusts speed search responsiveness. Usually it is not necessary to change this setting.</p>	Determined by A1-02 when A1-02 ≠ 5 20.0 when A1-02 = 5 (0.0 - 1000.0 ms)

### ■ b3-10: Speed Estimation Detection Gain

No. (Hex.)	Name	Description	Default (Range)
b3-10 (019A) Expert	Speed Estimation Detection Gain	<div style="display: flex; gap: 5px;"> <span>V/f</span> <span>OLV/PM</span> <span>EZOLV</span> </div> <p>Sets the gain to correct estimated frequencies from Speed Estimation Speed Search.</p>	1.05 (1.00 - 1.20)

If the drive detects *ov* [DC Bus Overvoltage] when you restart the motor, increase the setting value.

**Note:**

When A1-02 = 8 [Control Method Selection = EZOLV], the default setting is 1.00 and the setting range is 1.00 - 1.10.

### ■ b3-11: Spd Est Method Switch-over Level

No. (Hex.)	Name	Description	Default (Range)
b3-11 (019B) Expert	Spd Est Method Switch-over Level	<div style="display: flex; gap: 5px;"> <span>V/f</span> <span>OLV/PM</span> <span>EZOLV</span> </div> <p>Uses the quantity of voltage in the motor to automatically switch the search method within the type of speed measurement.</p>	5.0% (0.5 - 100.0%)

**Note:**

- 208 V class at 100% = 200 V
- 480 V class at 100% = 400 V

### ■ b3-12: Speed Search Current Deadband

No. (Hex.)	Name	Description	Default (Range)
b3-12 (019C) Expert	Speed Search Current Deadband	<div style="display: flex; gap: 5px;"> <span style="border: 1px solid black; border-radius: 3px; padding: 2px;">V/f</span> <span style="border: 1px solid black; border-radius: 3px; padding: 2px;">OLV/PM</span> <span style="border: 1px solid black; border-radius: 3px; padding: 2px;">EZOLV</span> </div> Sets the minimum current detection level during Speed Search. If the drive does not do Speed Estimation, increase this setting in 0.1-unit increments.	determined by o2-04 (2.0 - 10.0)

### ■ b3-14: Bi-directional Speed Search

No. (Hex.)	Name	Description	Default (Range)
b3-14 (019E)	Bi-directional Speed Search	<div style="display: flex; gap: 5px;"> <span style="border: 1px solid black; border-radius: 3px; padding: 2px;">V/f</span> <span style="border: 1px solid black; border-radius: 3px; padding: 2px;">OLV/PM</span> <span style="border: 1px solid black; border-radius: 3px; padding: 2px;">EZOLV</span> </div> Sets the direction of Speed Search to the direction of the frequency reference or in the motor rotation direction as detected by the drive.	Determined by A1-02, b3-24, and E9-01 (0, 1)

#### 0 : Disabled

The drive uses the frequency reference to detect the direction of motor rotation.

#### 1 : Enabled

The drive detects the direction of motor rotation during Speed Search.

##### Note:

- Refer to [Parameters that Change from the Default Settings with A1-02 \[Control Method Selection\] on page 594](#) for information about the initial value of *b3-14* that applies when you set these parameters:
  - A1-02 = 0, 8 [Control Method Selection = V/f, EZOLV]
  - E9-01 = 0 [Motor Type Selection = Induction (IM)]
  - b3-24 = 1 [Speed Search Method Selection = Speed Estimation Speed Search]
- The initial value of *b3-14* is 0 when you set these parameters:
  - A1-02 = 0, 8
  - E9-01 = 0
  - b3-24 = 2 [Current Detection 2]
- Refer to [Parameters that Change from the Default Settings with A1-02 \[Control Method Selection\] on page 594](#) for information about the initial value of *b3-14* that applies when you set these parameters:
  - A1-02 = 8 [EZOLV]
  - E9-01 = 1, 2 [Permanent Magnet (PM), Synchronous Reluctance (SynRM)]
- When you change *A1-02*, *b3-24*, and *E9-01*, also set *b3-14*.

### ■ b3-17: Speed Est Retry Current Level

No. (Hex.)	Name	Description	Default (Range)
b3-17 (01F0) Expert	Speed Est Retry Current Level	<div style="display: flex; gap: 5px;"> <span style="border: 1px solid black; border-radius: 3px; padding: 2px;">V/f</span> <span style="border: 1px solid black; border-radius: 3px; padding: 2px;">OLV/PM</span> <span style="border: 1px solid black; border-radius: 3px; padding: 2px;">EZOLV</span> </div> Sets the current level for the search retry function in Speed Estimation Speed Search as a percentage where drive rated current is a setting value of 100%.	110% (0 - 200%)

When a large quantity of current flows during Speed Estimation Speed Search, the drive temporarily stops operation to prevent overvoltage and overcurrent. When the current is at the level set in *b3-17*, the drive tries speed search again.

### ■ b3-18: Speed Est Retry Detection Time

No. (Hex.)	Name	Description	Default (Range)
b3-18 (01F1) Expert	Speed Est Retry Detection Time	<div style="display: flex; gap: 5px;"> <span style="border: 1px solid black; border-radius: 3px; padding: 2px;">V/f</span> <span style="border: 1px solid black; border-radius: 3px; padding: 2px;">OLV/PM</span> <span style="border: 1px solid black; border-radius: 3px; padding: 2px;">EZOLV</span> </div> Sets the length of time that the drive will wait to retry Speed Estimation Speed Search when too much current flow stopped the Speed Search.	0.10 s (0.00 - 1.00 s)

When the current is more than the level set in *b3-17* [*Speed Est Retry Current Level*] during the time set in *b3-18*, the drive tries speed search again.

### ■ b3-19: Speed Search Restart Attempts

No. (Hex.)	Name	Description	Default (Range)
b3-19 (01F2)	Speed Search Restart Attempts	<input type="checkbox"/> V/f <input type="checkbox"/> OLV/PM <input type="checkbox"/> EZOLV Sets the number of times to restart Speed Search if Speed Search does not complete.	3 times (0 - 10 times)

If the drive does the number of Speed Search restarts set in this parameter, it will trigger an *SER* [*Speed Search Retries Exceeded*] error.

### ■ b3-24: Speed Search Method Selection

No. (Hex.)	Name	Description	Default (Range)
b3-24 (01C0)	Speed Search Method Selection	<input type="checkbox"/> V/f <input type="checkbox"/> OLV/PM <input type="checkbox"/> EZOLV Sets the Speed Search method when you start the motor or when you return power after a momentary power loss.	Determined by A1-02 (1, 2)

**Note:**

- The default setting is different for different control methods.
  - A1-02 = 0 [*Control Method Selection = V/f*]: 2
  - A1-02 = 8 [*EZOLV*] and E9-01 = 0 [*Motor Type Selection = Induction (IM)*]: 2
  - A1-02 = 8 and E9-01 ≠ 0: 1
- When A1-02 = 8 and E9-01 = 1, 2, set b3-24 = 1. If b3-24 = 2, the drive will detect *oPE08* [*Parameter Selection Error*].

Set b3-01 = 1 [*Speed Search at Start Selection = Enabled*] to do Speed Search at start. Set L2-01 = 1 [*Power Loss Ride Through Select = Enabled for L2-02 Time*] to do Speed Search after you restore power after a momentary power loss.

#### 1 : Speed Estimation

The drive uses the residual voltage from a short baseblock time to estimate the motor speed.

If there is not sufficient residual voltage, then the drive will inject DC current into the motor to estimate the motor speed.

#### 2 : Current Detection 2

The drive will inject DC current into the motor to estimate motor speed.

### ■ b3-25: Speed Search Wait Time

No. (Hex.)	Name	Description	Default (Range)
b3-25 (01C8) Expert	Speed Search Wait Time	<input type="checkbox"/> V/f <input type="checkbox"/> OLV/PM <input type="checkbox"/> EZOLV Sets the length of time the drive will wait to start the Speed Search Retry function.	0.5 s (0.0 - 30.0 s)

If the drive detects these faults during speed search, increase the setting value:

- oC* [*Overcurrent*]
- ov* [*Overvoltage*]
- SER* [*Speed Search Retries Exceeded*]

### ■ b3-26: Direction Determination Level

No. (Hex.)	Name	Description	Default (Range)
b3-26 (01C7) Expert	Direction Determination Level	<input type="checkbox"/> V/f <input type="checkbox"/> OLV/PM <input type="checkbox"/> EZOLV Sets the level to find the motor rotation direction. Increase the value if the drive cannot find the direction.	1000 (40 to 60000)

### ■ b3-27: Speed Search RUN/BB Priority

No. (Hex.)	Name	Description	Default (Range)
b3-27 (01C9) Expert	Speed Search RUN/BB Priority	<input type="checkbox"/> V/f <input checked="" type="checkbox"/> OL/PM <input checked="" type="checkbox"/> EZOLV Sets the conditions necessary to start Speed Search.	0 (0, 1)

Executes *Speed Search from Fmax or Fref* [ $H1-xx = 61/62$ ] for initial speed searches or from the MFDI terminal.

**0 : SS Only if RUN Applied Before BB**

**1 : SS Regardless of RUN/BB Sequence**

### ■ b3-29: Speed Search Back-EMF Threshold

No. (Hex.)	Name	Description	Default (Range)
b3-29 (077C) Expert	Speed Search Back-EMF Threshold	<input type="checkbox"/> V/f <input checked="" type="checkbox"/> OL/PM <input checked="" type="checkbox"/> EZOLV Sets the induced voltage for motors that use Speed Search. The drive will start Speed Search when the motor induced voltage level is the same as the setting value. Usually it is not necessary to change this setting.	10% (0 - 10%)

To make adjustments, gradually decrease the setting value. If you decrease the setting value too much, speed search will not operate correctly.

### ■ b3-31: Spd Search Current Reference Lvl

No. (Hex.)	Name	Description	Default (Range)
b3-31 (0BC0) Expert	Spd Search Current Reference Lvl	<input type="checkbox"/> V/f <input checked="" type="checkbox"/> OL/PM <input checked="" type="checkbox"/> EZOLV Sets the current level that decreases the output current during Current Detection Speed Search.	1.50 (1.50 - 3.50)

Set this parameter as a ratio of  $E2-03$  [Motor No-Load Current]. The setting is a ratio with respect to 30% of the motor rated current when  $E2-03 \leq E2-01$  [Motor Rated Current (FLA)]  $\times 0.3$ .

**Note:**

When  $A1-02 = 8$  [Control Method Selection = EZOLV], the setting is a ratio with respect to  $E9-06$  [Motor Rated Current (FLA)]  $\times 0.5$ .

### ■ b3-32: Spd Search Current Complete Lvl

No. (Hex.)	Name	Description	Default (Range)
b3-32 (0BC1) Expert	Spd Search Current Complete Lvl	<input type="checkbox"/> V/f <input checked="" type="checkbox"/> OL/PM <input checked="" type="checkbox"/> EZOLV Sets the current level that completes Speed Search.	1.20 (0.00 - 1.49)

The Current Detection Speed Search gradually decreases the output frequency to search for the motor speed when the output current is equal to or less than Speed Search Current Complete Level.

Set this parameter as a ratio of  $E2-03$  [Motor No-Load Current]. The setting is a ratio with respect to 30% of the motor rated current when  $E2-03 \leq E2-01$  [Motor Rated Current (FLA)]  $\times 0.3$ .

**Note:**

When  $A1-02 = 8$  [Control Method Selection = EZOLV], the setting is a ratio with respect to  $E9-06$  [Motor Rated Current (FLA)]  $\times 0.5$ .

### ■ b3-39: Regen Judgment Lv of Spd Search

No. (Hex.)	Name	Description	Default (Range)
b3-39 (1B8F) Expert	Regen Judgment Lv of Spd Search	<input type="checkbox"/> V/f <input checked="" type="checkbox"/> OL/PM <input checked="" type="checkbox"/> EZOLV Sets the level to determine the regenerative state during speed search. Usually it is not necessary to change this setting.	15% (0 - 50%)

**Note:**

This parameter is only available in the drive software versions PRG: 01013 and later.

If the drive does not complete the speed search, increase the setting value in 5% increments after the drive stops.  
If the drive detects *ov* [Overvoltage] during speed search, decrease the setting value in 5% increments after the drive stops.

### ■ b3-54: Search Time

No. (Hex.)	Name	Description	Default (Range)
b3-54 (3123)	Search Time	V/f OLV/PM EZOLV Sets the length of time that the drive will run Speed Search.	400 ms (10 - 2000 ms)

If you set this parameter too low, Speed Search will not operate correctly.

If the drive detects *oC* [Overcurrent] immediately after Speed Search Starts:

- Increase the value of *L2-03* [Minimum Baseblock Time] and decrease the motor speed you use to start Speed Search.
- Increases the setting value of *b3-08* [Speed Estimation ACR P Gain].
- Increase the value of *b3-54*.

If the drive detects *oC* or *ov* [DC Bus Overvoltage] during Speed Search, increase the value of *b3-08*.

### ■ b3-55: Current Increment Time

No. (Hex.)	Name	Description	Default (Range)
b3-55 (3124) Expert	Current Increment Time	V/f OLV/PM EZOLV Sets the length of time that the drive will increase the current from zero current to the setting value of <i>b3-06</i> [Speed Estimation Current Level 1].	10 ms (10 - 2000 ms)

Gradually increase the setting value when a large quantity of current flows after speed search starts. If you set this value too high, speed search will not operate correctly.

### ■ b3-56: InverseRotationSearch WaitTime

No. (Hex.)	Name	Description	Default (Range)
b3-56 (3126)	InverseRotationSearch WaitTime	V/f OLV/PM EZOLV Sets the wait time until the drive starts inverse rotation search after it completes forward search when you do inverse rotation search during Current Detection Speed Search.	Determined by <i>o2-04</i> (0.1 - 5.0 s)

## ◆ b4: Timer Function

The drive uses timers to delay activating and deactivating MFDO terminals.

Timers prevent sensors and switches from making chattering noise.

There are two types of timers:

- Timers that set a delay for timer inputs and timer outputs.  
These timers delay activating and deactivating of the MFDI and MFDOs.  
To enable this function, set *H1-xx* = 18 [MFDI Function Select = Timer Function], and set *H2-01* to *H2-03* = 12 [MFDO Function Select = Timer Output].
- Timers that set a delay to activate and deactivate MFDO terminals.  
These timers delay activating and deactivating MFDO terminals.  
To enable this function, set delay times in parameters *b4-03* to *b4-08*.

### ■ Timer Function Operation

- Timers that Set a Delay for Timer Inputs and Timer Outputs  
Triggers timer output if the timer input is active for longer than the time set in *b4-01* [Timer Function ON-Delay Time]. Triggers timer output late for the time set in *b4-02* [Timer Function OFF-Delay Time]. Figure 12.22 shows an example of how the timer function works.

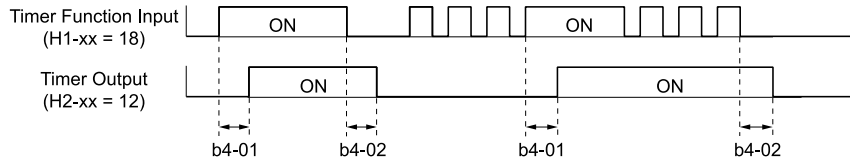

Figure 12.22 Example of Timer Function Operation

• Setting On/Off-delay Time for MFDO

Figure 12.23 uses H2-01 terminals to show an example of how the timer function works. Use b4-03 [Terminal M1-M2 ON-Delay Time] and b4-04 [Terminal M1-M2 OFF-Delay Time] to set this function.

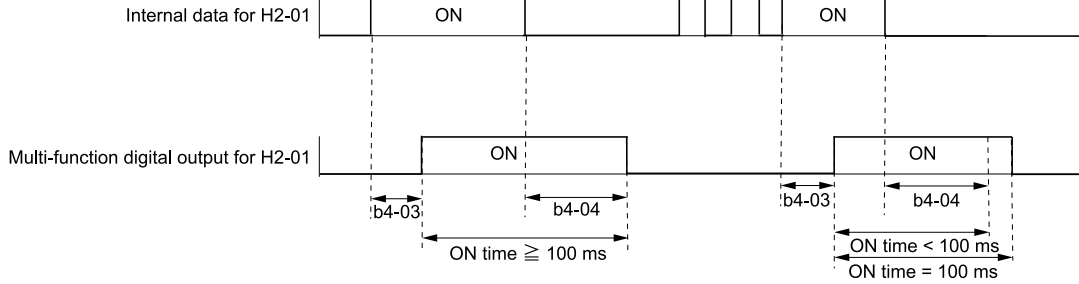

Figure 12.23 Example of How the Timer Function Works with H2-01 Terminals

Note:

When the terminal is triggered, it continues for a minimum of 100 ms. The on/off-delay time of MFDO terminal does not have an effect.

■ b4-01: Timer Function ON-Delay Time

No. (Hex.)	Name	Description	Default (Range)
b4-01 (01A3)	Timer Function ON-Delay Time	<input type="checkbox"/> V/f <input type="checkbox"/> OL/PM <input type="checkbox"/> EZOLV Sets the ON-delay time for the timer input.	0.0 s (0.0 - 3000.0 s)

■ b4-02: Timer Function OFF-Delay Time

No. (Hex.)	Name	Description	Default (Range)
b4-02 (01A4)	Timer Function OFF-Delay Time	<input type="checkbox"/> V/f <input type="checkbox"/> OL/PM <input type="checkbox"/> EZOLV Sets the OFF-delay time for the timer input.	0.0 s (0.0 - 3000.0 s)

■ b4-03: Terminal M1-M2 ON-Delay Time

No. (Hex.)	Name	Description	Default (Range)
b4-03 (0B30) Expert	Terminal M1-M2 ON-Delay Time	<input type="checkbox"/> V/f <input type="checkbox"/> OL/PM <input type="checkbox"/> EZOLV Sets the delay time to activate the contact after the function set in H2-01 activates.	0 ms (0 - 65000 ms)

■ b4-04: Terminal M1-M2 OFF-Delay Time

No. (Hex.)	Name	Description	Default (Range)
b4-04 (0B31) Expert	Terminal M1-M2 OFF-Delay Time	<input type="checkbox"/> V/f <input type="checkbox"/> OL/PM <input type="checkbox"/> EZOLV Sets the delay time to deactivate the contact after the function set in H2-01 deactivates.	0 ms (0 - 65000 ms)

■ b4-05: Terminal M3-M4 ON-Delay Time

No. (Hex.)	Name	Description	Default (Range)
b4-05 (0B32) Expert	Terminal M3-M4 ON-Delay Time	<input type="checkbox"/> V/f <input type="checkbox"/> OL/PM <input type="checkbox"/> EZOLV Sets the delay time to activate the contact after the function set in H2-02 activates.	0 ms (0 - 65000 ms)

### ■ b4-06: Terminal M3-M4 OFF-Delay Time

No. (Hex.)	Name	Description	Default (Range)
b4-06 (0B33) Expert	Terminal M3-M4 OFF-Delay Time	<b>V/f</b> <b>OLV/PM</b> <b>EZOLV</b> Sets the delay time to deactivate the contact after the function set in <i>H2-02</i> deactivates.	0 ms (0 - 65000 ms)

### ■ b4-07: Terminal M5-M6 ON-Delay Time

No. (Hex.)	Name	Description	Default (Range)
b4-07 (0B34) Expert	Terminal M5-M6 ON-Delay Time	<b>V/f</b> <b>OLV/PM</b> <b>EZOLV</b> Sets the delay time to activate the contact after the function set in <i>H2-03</i> activates.	0 ms (0 - 65000 ms)

### ■ b4-08: Terminal M5-M6 OFF-Delay Time

No. (Hex.)	Name	Description	Default (Range)
b4-08 (0B35) Expert	Terminal M5-M6 OFF-Delay Time	<b>V/f</b> <b>OLV/PM</b> <b>EZOLV</b> Sets the delay time to deactivate the contact after the function set in <i>H2-03</i> deactivates.	0 ms (0 - 65000 ms)

## ◆ b5: PID Control

The drive has a PID control function. You can control drive output to adjust the proportional gain, integral time, and derivative time that has an effect on the bias between the target value and the feedback value to align the target value with the detected value. Use this function to adjust the drive output to accurately match the flow, pressure, and temperature in the application match the target value.

Use a combination of these controls to increase the performance:

- **P control**  
P control has a proportional effect on the deviation. It outputs the product (the controlled output) proportional to the deviation. You cannot use only the offset from P control to get to zero deviation.
- **I control**  
I control is the integral of the deviation. It uses an integral value of the deviation to output the product (the controlled output). I control helps align the feedback value and the target value. If you use the proportional effect (P Control) only, it will cause offset. If you use the proportional effect with the integral operation, it will gradually remove the offset over time.
- **D control**  
D control is the derivative of the deviation. If there are sudden, large changes in the deviation or feedback value, it will have an effect on drive output. It quickly returns drive output to the value before the sudden change. It multiplies a time constant by a derivative value of the deviation (slope of the deviation), and adds that result to PID input to calculate the deviation of the signal, then it corrects the deviation.

**Note:**

D control causes less stable operation because the noise changes the deviation signal. Use D control only when necessary.

### ■ PID Control Operation

Figure 12.24 shows PID control operation. The modified output (output frequency) changes when the drive uses PID control to keep the deviation (the difference between the target value and the feedback value) constant.

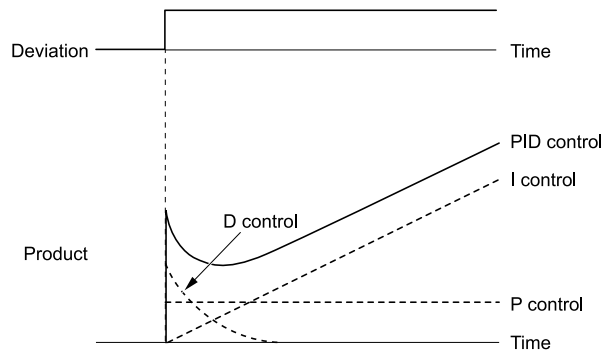

Figure 12.24 PID Control Operation

■ PID Control Applications

Table 12.24 shows applications for PID control.

Table 12.24 PID Control Applications

Application	Control Content	Sensors Used
Speed Control	<ul style="list-style-type: none"> <li>The drive uses a feedback signal for the machine speed, and adjusts that speed to align with the target value.</li> <li>The drive uses speed data from other machinery as the target value to do synchronous control. The drive then adds that target value to the feedback from the machine it is operating to align its speed with the other machinery.</li> </ul>	Tacho generator
Pressure control	The drive uses feedback from the actual pressure to hold constant pressure.	Pressure sensor
Flow control	The drive uses feedback from the actual flow to hold constant flow.	Flow rate sensor
Temperature control	The drive uses feedback from the actual temperature to control a fan and hold constant temperature.	Thermocoupler, thermistor

■ Input Methods for the PID Setpoint

Use *b5-01 [PID Mode Setting]* to select how the PID setpoint is input to the drive.

One of the inputs in Table 12.25 will be the PID setpoint.

When the inputs in Table 12.25 are disabled, the frequency reference set in *b1-01 [Frequency Reference Selection 1]* will be the PID setpoint.

Table 12.25 Input Methods for the PID Setpoint

Input Methods for the PID Setpoint	Setting Value
MFAI terminal A1	Set H3-02 = C [Terminal A1 Function Selection = PID Setpoint].
MFAI terminal A2	Set H3-10 [Terminal A2 Function Selection] = C.
MEMOBUS/Modbus register 0006H	Sets MEMOBUS/Modbus register 000FH (Control Selection Setting) bit 1 to 1 (PID setpoint input). Enters the PID setpoint to MEMOBUS/Modbus register 0006H (PID setpoint, 0.01% units, signed).

**Note:**

If you set two inputs for the PID setpoint, it will trigger operation error *oPE07 [Analog Input Selection Error]*.

■ Entering the PID Feedback Value

You can use two methods to input the PID feedback value to the drive. One method uses a single feedback signal for usual PID control. The other method uses two signals. The difference between those signals sets the deviation.

• Use One Feedback Signal

Use Table 12.26 to select how the feedback signal is input to the drive for PID control.



Table 12.26 PID Feedback Input Method

PID Feedback Input Method	Setting Value
MFAI terminal A1	Set H3-02 = B [PID Feedback].
MFAI terminal A2	Set H3-10 = B.
MEMOBUS/Modbus register 15FFH	Enters the PID feedback to MEMOBUS/Modbus register 15FFH (PID Feedback, 0.01% units, signed).

- **Use Two Feedback Signals and Calculate the Deviation from the Difference Between Those Signals**  
Use Table 12.27 to select how the second feedback value is input to the drive. The drive calculates the deviation of the second feedback value. Set H3-02 or H3-10 = 16 [Terminal A1/A2 Function Selection = Differential PID Feedback] to enable the second feedback signal used to calculate the deviation.

Table 12.27 PID Differential Feedback Input Method

PID Differential Feedback Input Method	Setting Value
MFAI terminal A1	Set H3-02 = 16.
MFAI terminal A2	Set H3-10 = 16.

**Note:**

If you set more than one of H3-02 and H3-10 to 16, the drive will detect oPE07 [Analog Input Selection Error].

## ■ PID Control Block Diagram

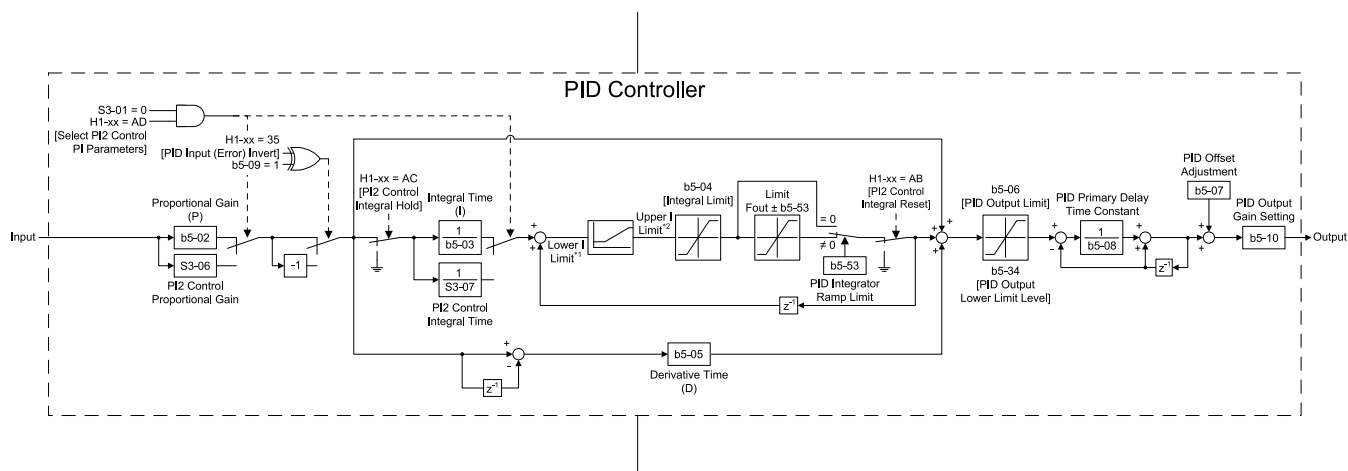

Figure 12.25 PID Block Diagram

- \*1 The drive uses the largest value of Y1-06 [Minimum Speed], Y4-12 [Thrust Frequency], or d2-02 [Frequency Reference Lower Limit] for Lower I Limit. When the drive is in Emergency Override Mode, it uses the largest value of Y1-06, Y4-12, d2-02, or S6-09 [Emergency Override Min Speed].
- \*2 The drive uses the smallest value of Y1-40 [Maximum Speed], E1-04 [Maximum Output Frequency], or d2-01 [Frequency Reference Upper Limit] for Upper I Limit. When the drive is in Emergency Override Mode, it uses the smallest value of Y1-40, E1-04, d2-01, or S6-10 [Emergency Override Max Speed].

## 12.3 b: Application

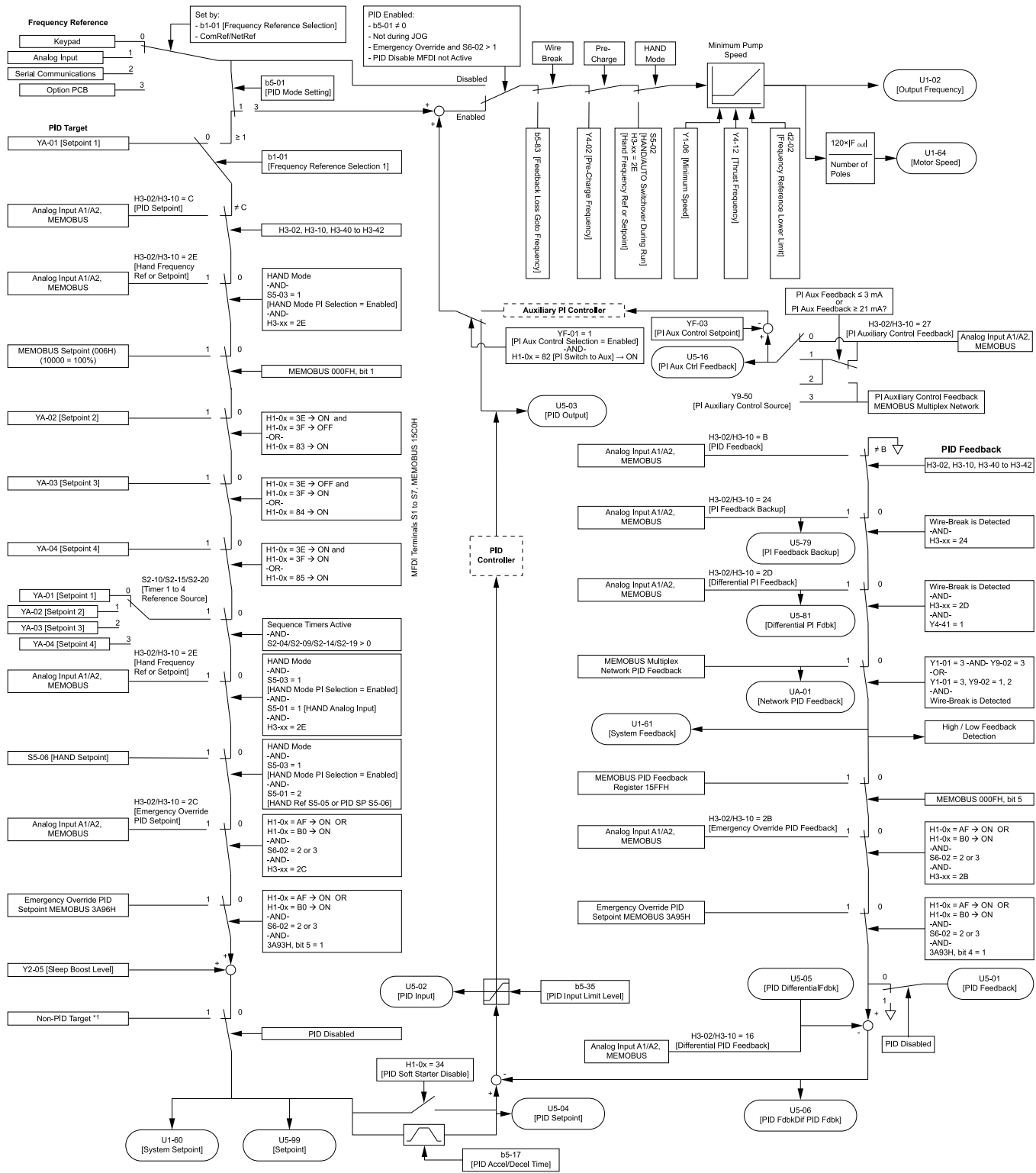

Figure 12.26 Sequence of Speed References to the PID Controller

\*1 Refer to Non-PID Setpoint selection for High/Low Feedback Detection.

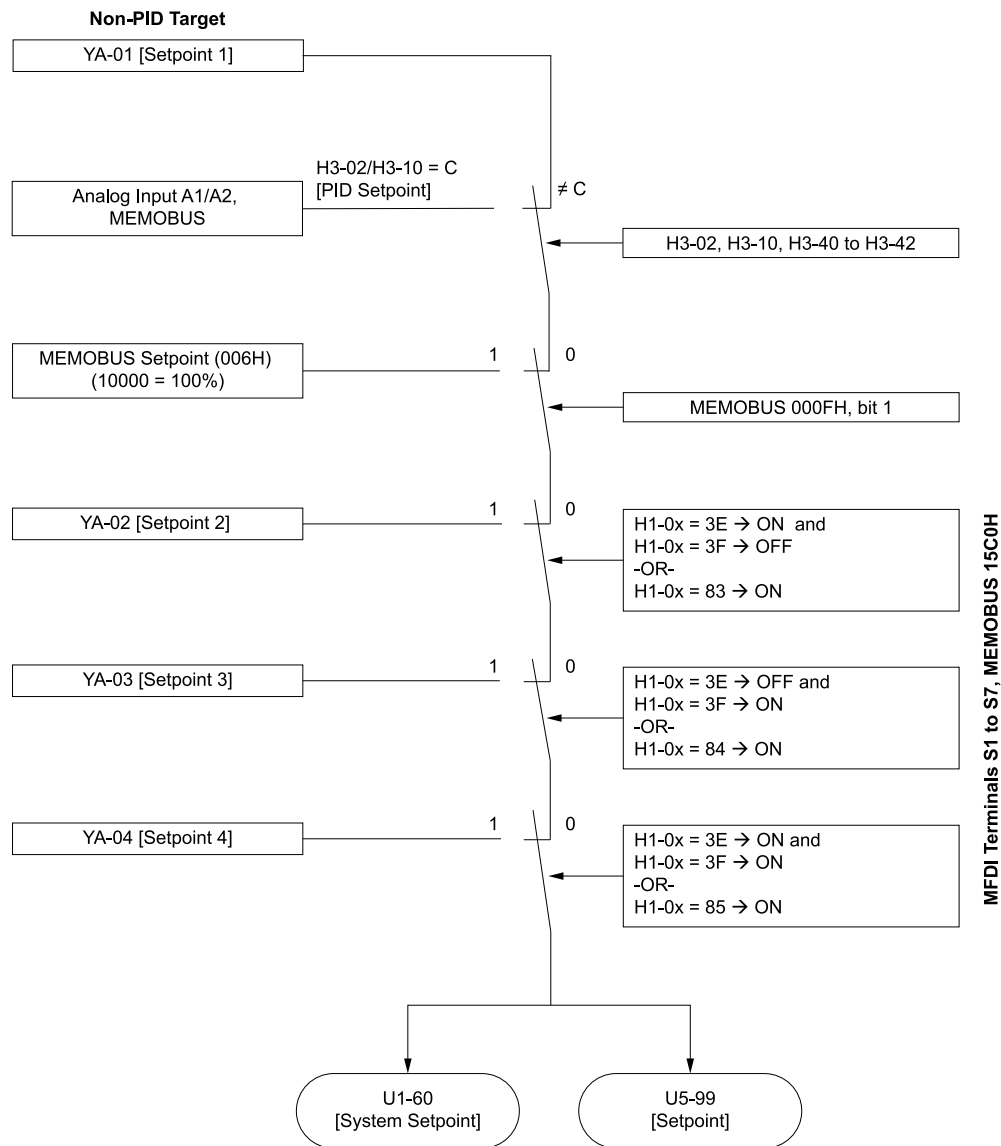

Figure 12.27 High/Low Feedback Detection Non-PID Setpoint

### ■ Fine-Tuning PID

Fine-tune the following parameter settings to have PID control eliminate problems with overshoot and oscillation.

- *b5-02 [Proportional Gain (P)]*
- *b5-03 [Integral Time (I)]*
- *b5-05 [Derivative Time (D)]*
- *b5-08 [PID Primary Delay Time Constant]*

## 12.3 b: Application

Purpose	Procedure	Results
Prevent overshoot.	<ul style="list-style-type: none"> <li>Set <i>b5-05 [Derivative Time (D)]</i> to a smaller value.</li> <li>Set <i>b5-03 [Integral Time (I)]</i> to a larger value.</li> </ul>	<p>Response</p> <p>Before adjustment</p> <p>After adjustment</p> <p>Time</p>
Quickly stabilize control.	<ul style="list-style-type: none"> <li>Set <i>b5-05 [Derivative Time (D)]</i> to a larger value.</li> <li>Set <i>b5-03 [Integral Time (I)]</i> to a smaller value.</li> </ul>	<p>Response</p> <p>After adjustment</p> <p>Before adjustment</p> <p>Time</p>
Prevent long-cycle oscillations.	Set <i>b5-03 [Integral Time (I)]</i> to a larger value.	<p>Response</p> <p>Before adjustment</p> <p>After adjustment</p> <p>Time</p>
Prevent short-cycle oscillations.	<ul style="list-style-type: none"> <li>Set <i>b5-05 [Derivative Time (D)]</i> to a smaller value.</li> <li>If you set <i>b5-05 = 0.00 [Derivative Time (D) = disabling D control]</i> and it does not stop oscillation, then set <i>b5-02 [Proportional Gain (P)]</i> to a smaller value or set <i>b5-08 [PID Primary Delay Time Constant]</i> to a larger value.</li> </ul>	<p>Response</p> <p>Before adjustment</p> <p>After adjustment</p> <p>Time</p>

### ■ System Units

The drive uses *b5-38 [PID User Unit Display Scaling]*, *b5-39 [PID Setpoint Display Digits]*, and *b5-46 [PID Unit Display Selection]* together to apply the user-set PID setpoint and display units at any time.

Parameter *b5-38* sets the scaling and *b5-46* sets the units-text to the parameters and monitors shown in [Table 12.28](#) and [Table 12.29](#).

**Note:**

When you change *b5-38* and *b5-46*, the drive will not automatically convert the parameters in [Table 12.28](#).

For example, when you set *YA-01* = 70.0 [PSI] and change these parameters:

- *b5-46* from 1 [PSI] to 8 [Bar]
- *b5-38* from 145.0 to 10.0

The drive changes only the unit setting and *YA-01* will be 70.0 [Bar]. When the setpoint value after you change *b5-38* and *b5-46* is more than *b5-38*, the drive internally limits the setpoint value to 200% of *b5-38*. The drive regards the *YA-01* setting as 20.0 [Bar].

**Table 12.28 Parameters Set by b5-38 and b5-46**

Parameter Groups	No.
b5	b5-71 [Min PID Transducer Scaling]
S5	<ul style="list-style-type: none"> <li>• S5-06 [HAND Setpoint]</li> <li>• S5-12 [HAND Setpoint 2]</li> </ul>
Y1	<ul style="list-style-type: none"> <li>• Y1-04 [Sleep Wake-up Level]</li> <li>• Y1-08 [Low Feedback Level]</li> <li>• Y1-11 [High Feedback Level]</li> <li>• Y1-14 [High Feedback Hysteresis Level]</li> <li>• Y1-15 [Maximum Setpoint Difference]</li> </ul>
Y2	<ul style="list-style-type: none"> <li>• Y2-05 [Sleep Boost Level]</li> <li>• Y2-08 [Delta Feedback Drop Level]</li> <li>• Y2-25 [Anti-No-Flow Release Level]</li> </ul>
Y4	<ul style="list-style-type: none"> <li>• Y4-01 [Pre-Charge Level]</li> <li>• Y4-18 [Differential Level]</li> <li>• Y4-37 [Pressure Reached Hysteresis Lvl]</li> </ul>
Y9	<ul style="list-style-type: none"> <li>• Y9-10 [Staging Delta Feedback Level]</li> <li>• Y9-14 [De-staging Delta Feedback Level]</li> <li>• Y9-17 [Setpoint Modifier]</li> <li>• Y9-34 [Low Feedback De-stage]</li> </ul>
YA	<ul style="list-style-type: none"> <li>• YA-01 [Setpoint 1]</li> <li>• YA-02 [Setpoint 2]</li> <li>• YA-03 [Setpoint 3]</li> <li>• YA-04 [Setpoint 4]</li> </ul>

**Table 12.29 Monitors Set by b5-38 and b5-46**

Monitor Groups	No.
U1	<ul style="list-style-type: none"> <li>• U1-60 [System Setpoint]</li> <li>• U1-61 [System Feedback]</li> </ul>
U5	<ul style="list-style-type: none"> <li>• U5-01 [PID Feedback]</li> <li>• U5-04 [PID Setpoint]</li> <li>• U5-79 [PI Feedback Backup]</li> <li>• U5-81 [Differential PI Fdbk]</li> <li>• U5-99 [PID Setpoint Command]</li> </ul>
UA	UA-01 [Network PID Feedback]

**Full-Scale of the PID Analog Input Signals**

The full-scale of the analog signals listed in this table go from *b5-71* [Min PID Transducer Scaling] to *b5-38* [PID User Unit Display Scaling].

H3-xx Setting	MFAI	H3-xx Setting	MFAI
B	PID Feedback	2B	Emergency Override PID Feedback
C	PID Setpoint	2D	Differential Level Source
24	PID Feedback Backup	2E	HAND Frequency Ref or Setpoint <sup>*1</sup>

\*1 Only when *b5-01* = 1 [PID Mode Setting = Standard] and *S5-03* = 1 [HAND Mode PID Selection = Enabled]

**Note:**

When you set *b5-71* < 0, the drive appropriately scales the setpoint and feedback values of the drive, but internally limits to 0 when the reported value from the transducer is negative.

**Custom Units**

These selections are available for custom system units:

**Table 12.30 Settings and Characters**

Settings	Characters	Settings	Characters
20	SPACE	4E	N
21	!	4F	O
22	"	50	P
23	#	51	Q
24	\$	52	R
25	%	53	S
26	&	54	T
27	'	55	U
28	(	56	V
29	)	57	W
2A	*	58	X
2B	+	59	Y
2C	,	5A	Z
2D	-	61	a
2E	.	62	b
2F	/	63	c
30	0	64	d
31	1	65	e
32	2	66	f
33	3	67	g
34	4	68	h
35	5	69	i
36	6	6A	j
37	7	6B	k
38	8	6C	l
39	9	6D	m
41	A	6E	n
42	B	6F	o
43	C	70	p
44	D	71	q
45	E	72	r
46	F	73	s
47	G	74	t
48	H	75	u
49	I	76	v
4A	J	77	w
4B	K	78	x
4C	L	79	y
4D	M	7A	z

## ■ b5-01: PID Mode Setting

No. (Hex.)	Name	Description	Default (Range)
b5-01 (01A5)	PID Mode Setting	<b>V/f</b> <b>OLV/PM</b> <b>EZOLV</b> Sets the type of PID control.	0 (0 - 3)

### 0 : Disabled

### 1 : Standard

The drive does D control on the difference between the feedback value and the PID setpoint output through *U5-02* [PID Input].

### 3 : Fref + PID Trim

The drive adds the frequency reference to the PID output. The drive does D control on the difference between the feedback value and the PID setpoint output through *U5-02*.

#### Note:

- When you set *b5-01* = 1 or 3 from the keypad, the drive will automatically set *H3-10* = B [Terminal A2 Function Selection = PID Feedback] and *o1-26* = 501 [Custom Monitor 3 = PID Feedback]. The drive will also update the defaults for *H3-10* and *o1-26* when you change *b5-01*.
- When you set *b5-01* = 0 from the keypad, the drive will automatically set *H3-10* = 0 [Frequency Reference] and *o1-26* = 103 [Output Current].
- When you set *b5-01* from a different method, for example MEMOBUS, the drive will automatically update the defaults for *H3-10* and *o1-26*, but it will not update the parameters.

## ■ b5-02: Proportional Gain (P)

No. (Hex.)	Name	Description	Default (Range)
b5-02 (01A6) RUN	Proportional Gain (P)	<b>V/f</b> <b>OLV/PM</b> <b>EZOLV</b> Sets the proportional gain (P) that is applied to PID input.	2.00 (0.00 - 25.00)

Larger values decrease errors, but can cause oscillations. Smaller values let too much offset between the setpoint and feedback.

Set *b5-02* = 0.00 to disable P control.

## ■ b5-03: Integral Time (I)

No. (Hex.)	Name	Description	Default (Range)
b5-03 (01A7) RUN	Integral Time (I)	<b>V/f</b> <b>OLV/PM</b> <b>EZOLV</b> Sets the integral time (I) that is applied to PID input.	0.5 s (0.0 - 360.0 s)

Set a short integral time in *b5-03* to remove the offset faster. If the integral time is too short, it can cause overshoot or oscillation.

Set *b5-03* = 0.0 to disable I control.

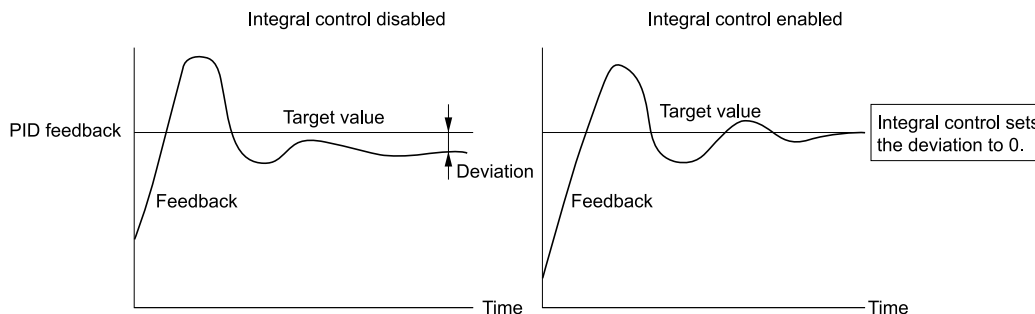

Figure 12.28 Integral Time and Deviation

### ■ b5-04: Integral Limit

No. (Hex.)	Name	Description	Default (Range)
b5-04 (01A8) RUN	Integral Limit	<input type="checkbox"/> V/f <input type="checkbox"/> OLV/IPM <input type="checkbox"/> EZOLV Sets the upper limit for integral control (I) as a percentage of the Maximum Output Frequency.	100.0% (0.0 - 100.0%)

Applications with loads that quickly change will cause the output of the PID function to oscillate. Set this parameter to a low value to prevent oscillation, mechanical loss, and motor speed loss.

### ■ b5-05: Derivative Time (D)

No. (Hex.)	Name	Description	Default (Range)
b5-05 (01A9) RUN	Derivative Time (D)	<input type="checkbox"/> V/f <input type="checkbox"/> OLV/IPM <input type="checkbox"/> EZOLV Sets the derivative time (D) for PID control. This parameter adjusts system responsiveness.	0.00 s (0.00 - 10.00 s)

When you increase the time setting, it will increase controller responsiveness, but it can also cause vibration. When you decrease the time setting, it will suppress overshoot and decrease controller responsiveness.

Set *b5-05* = 0.00 to disable D control.

### ■ b5-06: PID Output Limit

No. (Hex.)	Name	Description	Default (Range)
b5-06 (01AA) RUN	PID Output Limit	<input type="checkbox"/> V/f <input type="checkbox"/> OLV/IPM <input type="checkbox"/> EZOLV Sets the maximum possible output from the PID controller as a percentage of the Maximum Output Frequency.	100.0% (0.0 - 100.0%)

### ■ b5-07: PID Offset Adjustment

No. (Hex.)	Name	Description	Default (Range)
b5-07 (01AB) RUN	PID Offset Adjustment	<input type="checkbox"/> V/f <input type="checkbox"/> OLV/IPM <input type="checkbox"/> EZOLV Sets the offset for the PID control output as a percentage of the Maximum Output Frequency.	0.0% (-100.0 - +100.0%)

### ■ b5-08: PID Primary Delay Time Constant

No. (Hex.)	Name	Description	Default (Range)
b5-08 (01AC) RUN Expert	PID Primary Delay Time Constant	<input type="checkbox"/> V/f <input type="checkbox"/> OLV/IPM <input type="checkbox"/> EZOLV Sets the primary delay time constant for the PID control output. Usually it is not necessary to change this setting.	0.00 s (0.00 - 10.00 s)

Prevents resonance if there is a large quantity of mechanical friction or if rigidity is unsatisfactory. Set the value larger than the resonant frequency cycle. A value that is too large will decrease drive responsiveness.

### ■ b5-09: PID Output Level Selection

No. (Hex.)	Name	Description	Default (Range)
b5-09 (01AD)	PID Output Level Selection	<input type="checkbox"/> V/f <input type="checkbox"/> OLV/IPM <input type="checkbox"/> EZOLV Sets the polarity of the PID output.	0 (0, 1)

Use this parameter in applications that decrease the drive output frequency when you increase the PID setpoint.

#### 0 : Normal Output (Direct Acting)

A positive PID input increases the PID output (direct acting).

#### 1 : Reverse Output (Reverse Acting)



A positive PID input decreases the PID output (reverse acting).

### ■ b5-10: PID Output Gain Setting

No. (Hex.)	Name	Description	Default (Range)
b5-10 (01AE) RUN	PID Output Gain Setting	<input type="checkbox"/> V/f <input type="checkbox"/> OLV/PM <input type="checkbox"/> EZOLV Sets the amount of gain to apply to the PID output.	1.00 (0.00 - 25.00)

Applies a gain to the PID output and can help when  $b5-01 = 3$  [ $PID\ Mode\ Setting = Fref + PID\ Trim$ ].

### ■ b5-11: PID Output Reverse Selection

No. (Hex.)	Name	Description	Default (Range)
b5-11 (01AF)	PID Output Reverse Selection	<input type="checkbox"/> V/f <input type="checkbox"/> OLV/PM <input type="checkbox"/> EZOLV Sets the function that enables and disables reverse motor rotation for negative PID control output.	0 (0, 1)

When  $b5-01 = 3$  [ $PID\ Mode\ Setting = Fref + PID\ Trim$ ], this parameter is disabled. There is no limit for PID output. The drive will operate the same as setting 1 [ $Negative\ Output\ Accepted$ ].

#### 0 : Lower Limit is Zero

When PID output is negative, PID output is limited to 0 and drive output is shut off.

#### 1 : Negative Output Accepted

When the PID output is negative, the motor will rotate in reverse. When  $b1-04 = 1$  [ $Reverse\ Operation\ Selection = Reverse\ Disabled$ ], the lower limit is 0.

### ■ b5-17: PID Accel/Decel Time

No. (Hex.)	Name	Description	Default (Range)
b5-17 (01B5) RUN	PID Accel/Decel Time	<input type="checkbox"/> V/f <input type="checkbox"/> OLV/PM <input type="checkbox"/> EZOLV Raises or lowers the PID setpoint using the acceleration and deceleration times set to the drive. This is a soft-starter for the PID setpoint.	0.0 s (0.0 - 6000.0 s)

The drive usually uses the acceleration and deceleration times set in  $C1-xx$  [ $Accel\ and\ Decel\ Times$ ], but when PID control is enabled, the drive applies  $C1-xx$  after PID output. If you frequently change the PID setpoint, the drive responsiveness decreases. When resonance with PID control causes hunting, overshoot, or undershoot, set  $b5-17$  for longer acceleration and deceleration times.

Decrease  $C1-xx$  until hunting stops, then use  $b5-17$  to check the acceleration and deceleration. To enable and disable the setting in  $b5-17$  through an MFDI terminal, set  $PID\ Soft\ Starter\ Disable$  [ $H1-xx = 34$ ].

### ■ b5-28: PID Feedback Square Root Sel

No. (Hex.)	Name	Description	Default (Range)
b5-28 (01EA)	PID Feedback Square Root Sel	<input type="checkbox"/> V/f <input type="checkbox"/> OLV/PM <input type="checkbox"/> EZOLV Enables and disables the square root of the PID Feedback compared to the PID Setpoint to set an appropriate drive output for the correct system regulation.	0 (0, 1)

0 : Disabled

1 : Enabled

### ■ b5-29: PID Feedback Square Root Gain

No. (Hex.)	Name	Description	Default (Range)
b5-29 (01EB)	PID Feedback Square Root Gain	<input type="checkbox"/> V/f <input type="checkbox"/> OLV/PM <input type="checkbox"/> EZOLV Sets the multiplier applied to the square root of the feedback.	0.00 (0.00 - 2.00)

### ■ b5-30: PID Feedback Offset

No. (Hex.)	Name	Description	Default (Range)
b5-30 (01EC)	PID Feedback Offset	<input type="checkbox"/> V/f <input type="checkbox"/> OLV/PM <input type="checkbox"/> EZOLV Sets PID feedback Offset as a percentage of maximum frequency.	0.00% (0.00 - 100.00%)

### ■ b5-34: PID Output Lower Limit Level

No. (Hex.)	Name	Description	Default (Range)
b5-34 (019F) RUN	PID Output Lower Limit Level	<input type="checkbox"/> V/f <input type="checkbox"/> OLV/PM <input type="checkbox"/> EZOLV Sets the output lower limit for the PID control as a percentage of the Maximum Output Frequency.	0.0% (-100.0 - +100.0%)

Use a lower limit to keep PID control output from dropping below a fixed level.

Set this parameter to 0.0% to disable this function.

### ■ b5-35: PID Input Limit Level

No. (Hex.)	Name	Description	Default (Range)
b5-35 (01A0) RUN	PID Input Limit Level	<input type="checkbox"/> V/f <input type="checkbox"/> OLV/PM <input type="checkbox"/> EZOLV Sets the output upper limit for the PID control as a percentage of the Maximum Output Frequency.	1000.0% (0.0 - 1000.0%)

A large input value for PID control makes a high output. The drive applies this limit to the negative and positive domains.

### ■ b5-38: PID User Unit Display Scaling

No. (Hex.)	Name	Description	Default (Range)
b5-38 (01FE)	PID User Unit Display Scaling	<input type="checkbox"/> V/f <input type="checkbox"/> OLV/PM <input type="checkbox"/> EZOLV Sets the value that the drive sets or shows as the PID setpoint when at the maximum output frequency.	100.00 (0.01 - 600.00)

Refer to [System Units on page 654](#) for more information.

### ■ b5-39: PID User Unit Display Digits

No. (Hex.)	Name	Description	Default (Range)
b5-39 (01FF)	PID User Unit Display Digits	<input type="checkbox"/> V/f <input type="checkbox"/> OLV/PM <input type="checkbox"/> EZOLV Sets the number of digits to set and show the PID setpoint.	2 (0 - 3)

Refer to [System Units on page 654](#) for more information.

**0 : No Decimal Places (XXXXX)**

**1 : One Decimal Places (XXXX.X)**

**2 : Two Decimal Places (XXX.XX)**

**3 : Three Decimal Places (XX.XXX)**

### ■ b5-41: PID Output 2 Unit

No. (Hex.)	Name	Description	Default (Range)
b5-41 (0160)	PID Output 2 Unit	<input type="checkbox"/> V/f <input type="checkbox"/> OLV/PM <input type="checkbox"/> EZOLV Sets the display units in U5-14 [PID Out2 Upr4 Digits] and U5-15 [PID Out2 Lwr4 Digits].	0 (0 - 50)

**0 : "WC: inches of water column**

**1 : PSI: pounds per square inch**

**2 : GPM: gallons/min**

- 3 : °F: Fahrenheit**  
**4 : ft<sup>3</sup>/min: cubic feet/min**  
**5 : m<sup>3</sup>/h: cubic meters/hour**  
**6 : L/h: liters/hour**  
**7 : L/s: liters/sec**  
**8 : bar: bar**  
**9 : Pa: Pascal**  
**10 : °C: Celsius**  
**11 : m: meters**  
**12 : ft: feet**  
**13 : L/min: liters/min**  
**14 : m<sup>3</sup>/min: cubic meters/min**  
**15 : "Hg: Inch Mercury**  
**16 : kPa: kilopascal**  
**48 : %: Percent**  
**49 : Custom(b5-68~70)**  
**50 : None**

#### ■ b5-42: PID Output 2 Calc Mode

No. (Hex.)	Name	Description	Default (Range)
b5-42 (0161) RUN	PID Output 2 Calc Mode	<div style="display: flex; gap: 5px;"> <span>V/f</span> <span>OLV/PM</span> <span>EZOLV</span> </div> Sets how to calculate the original PID output.	0 (0 - 3)

#### 0 : Linear

The monitor displays PID output

##### Note:

When the PID output is 0, *b5-45 [PID Out2 Monitor MIN for Linear]* will set the minimum value. If the minimum value is set to be more than or equal to the maximum value, *U5-14 [PID Out2 Upr4 Digits]* and *U5-15 [PID Out2 Lwr4 Digits]* will be limited to 0.

#### 1 : Square Root

The monitor displays square root PID output

#### 2 : Quadratic

The monitor displays  $1/(\text{PID output})^2$

#### 3 : Cubic

The monitor displays  $1/(\text{PID output})^3$

##### Note:

Used for *U5-14* and *U5-15* only.

#### ■ b5-43: PID Out2 Monitor MAX Upper4 Dig

No. (Hex.)	Name	Description	Default (Range)
b5-43 (0162) RUN	PID Out2 Monitor MAX Upper4 Dig	<div style="display: flex; gap: 5px;"> <span>V/f</span> <span>OLV/PM</span> <span>EZOLV</span> </div> Sets the upper 4 digits of the maximum monitor value. Used with <i>b5-44 [PID Out2 Monitor MAX Lower4 Dig]</i> to set maximum monitor value of <i>U5-14 [PID Out2 Upr4 Digits]</i> and <i>U5-15 [PID Out2 Lwr4 Digits]</i> at maximum frequency.	0 (0 - 9999)

##### Note:

Used for *U5-14 [PID Out2 Upr4 Digits]* and *U5-15 [PID Out2 Lwr4 Digits]* only.

### ■ b5-44: PID Out2 Monitor MAX Lower4 Dig

No. (Hex.)	Name	Description	Default (Range)
b5-44 (0163) RUN	PID Out2 Monitor MAX Lower4 Dig	<input type="checkbox"/> V/f <input type="checkbox"/> OLV/PM <input type="checkbox"/> EZOLV Sets the lower 4 digits of the maximum monitor value. Used with b5-43 [PID Out2 Monitor MAX Upper4 Dig] to set maximum monitor value of U5-14 [PID Out2 Upr4 Digits] and U5-15 [PID Out2 Lwr4 Digits] at maximum frequency.	0.00 (0.00 - 99.99)

**Note:**

Used for U5-14 [PID Out2 Upr4 Digits] and U5-15 [PID Out2 Lwr4 Digits] only.

### ■ b5-45: PID Out2 Monitor MIN for Linear

No. (Hex.)	Name	Description	Default (Range)
b5-45 (0164) RUN	PID Out2 Monitor MIN for Linear	<input type="checkbox"/> V/f <input type="checkbox"/> OLV/PM <input type="checkbox"/> EZOLV Sets the minimum display value to show when at zero speed. Only effective when b5-42 = 0 [PID Output 2 Calc Mode = Linear].	0.0 (0.0 - 999.9)

**Note:**

Used for U5-14 [PID Out2 Upr4 Digits] and U5-15 [PID Out2 Lwr4 Digits] only.

### ■ b5-46: PID Unit Display Selection

No. (Hex.)	Name	Description	Default (Range)
b5-46 (0165)	PID Unit Display Selection	<input type="checkbox"/> V/f <input type="checkbox"/> OLV/PM <input type="checkbox"/> EZOLV Sets the units-text for the PID Display.	48 (0 - 50)

Refer to [System Units on page 654](#) for more information.

**0 : "WC: inches of water column**

**1 : PSI: pounds per square inch**

**2 : GPM: gallons/min**

**3 : °F: Fahrenheit**

**4 : ft<sup>3</sup>/min: cubic feet/min**

**5 : m<sup>3</sup>/h: cubic meters/hour**

**6 : L/h: liters/hour**

**7 : L/s: liters/sec**

**8 : bar: bar**

**9 : Pa: Pascal**

**10 : °C: Celsius**

**11 : m: meters**

**12 : ft: feet**

**13 : L/min: liters/min**

**14 : m<sup>3</sup>/min: cubic meters/min**

**15 : "Hg: Inch Mercury**

**16 : kPa: kilopascal**

**48 : %: Percent**

**49 : Custom(b5-68~70)**

**50 : None**

### ■ b5-53: PID Integrator Ramp Limit

No. (Hex.)	Name	Description	Default (Range)
b5-53 (0B8F) RUN	PID Integrator Ramp Limit	<input type="checkbox"/> V/f <input type="checkbox"/> OL/PM <input type="checkbox"/> EZOLV Sets the responsiveness of PID control when the PID feedback changes quickly.	0.0 Hz (0.0 - 10.0 Hz)

**Note:**

- This parameter is disabled when set to 0.0 Hz.
- When  $b5-53 > 0.0$  Hz and the drive enables the integrator ramp limit, the PID integrator value limit is the range set by the output frequency  $\pm b5-53$ .
- When the PID feedback changes quickly, gradually decrease the value of this parameter in increments of 0.1 Hz to decrease the speed of the response of PID control.

### ■ b5-61: PID Trim Mode Lower Limit Sel

No. (Hex.)	Name	Description	Default (Range)
b5-61 (119A)	PID Trim Mode Lower Limit Sel	<input type="checkbox"/> V/f <input type="checkbox"/> OL/PM <input type="checkbox"/> EZOLV Sets the function that adjusts the PID output in relation to the frequency reference.	0 (0, 1)

#### 0 : Disabled

Does not adjust the PID output with the frequency reference.

#### 1 : Enabled

Adjusts the PID output in relation to the frequency reference. The setting value of  $b5-62$  [PID Trim Mode Lower Limit Value] sets the lower limit of the post-adjustment value. The maximum output frequency sets the upper limit.

**Note:**

- Set  $b5-01 = 3$  [PID Mode Setting = Fref + PID Trim] to enable this parameter.
- When  $b5-61 = 1$ , you can use this formula to adjust PID output proportional to the frequency reference:

$$U5-03 = U5-03 \times \left| \frac{Fref}{Fmax} \right|^{*1}$$

$U5-03$  [PID Output],  $Fref$  [Frequency Reference], and  $Fmax$  [Maximum Output Frequency]

\*1 Lower limit =  $b5-62$ , Upper limit = Maximum output frequency

### ■ b5-62: PID Trim Mode Lower Limit Value

No. (Hex.)	Name	Description	Default (Range)
b5-62 (119B)	PID Trim Mode Lower Limit Value	<input type="checkbox"/> V/f <input type="checkbox"/> OL/PM <input type="checkbox"/> EZOLV Sets the PID Trim Mode Lower Limit Value as a percentage of the maximum output frequency.	0.00% (0.00 - 100.00%)

**Note:**

Set  $b5-01 = 3$  [PID Mode Setting = Fref + PID Trim] to enable this parameter.

### ■ b5-68: System Unit Custom Character 1

No. (Hex.)	Name	Description	Default (Range)
b5-68 (3C1F)	System Unit Custom Character 1	<input type="checkbox"/> V/f <input type="checkbox"/> OL/PM <input type="checkbox"/> EZOLV Sets the first character of the custom unit display when $b5-46 = 49$ [PID Unit Display Selection = Custom (B5-68~70)] or when $b5-41 = 49$ [PID Output 2 Unit = Custom (B5-68~70)].	41 (20 - 7A)

Refer to [Custom Units on page 656](#) for more information about available selections.

### ■ b5-69: System Unit Custom Character 2

No. (Hex.)	Name	Description	Default (Range)
b5-69 (3C20)	System Unit Custom Character 2	<div style="display: flex; gap: 5px;"> <span>V/f</span> <span>OLV/PM</span> <span>EZOLV</span> </div> Sets the second character of the custom unit display when $b5-46 = 49$ [PID Unit Display Selection = Custom (B5-68~70)] or when $b5-41 = 49$ [PID Output 2 Unit = Custom (B5-68~70)].	41 (20 - 7A)

Refer to [Custom Units on page 656](#) for more information about available selections.

### ■ b5-70: System Unit Custom Character 3

No. (Hex.)	Name	Description	Default (Range)
b5-70 (3C21)	System Unit Custom Character 3	<div style="display: flex; gap: 5px;"> <span>V/f</span> <span>OLV/PM</span> <span>EZOLV</span> </div> Sets the third character of the custom unit display when $b5-46 = 49$ [PID Unit Display Selection = Custom (B5-68~70)] or when $b5-41 = 49$ [PID Output 2 Unit = Custom (B5-68~70)].	41 (20 - 7A)

Refer to [Custom Units on page 656](#) for more information about available selections.

### ■ b5-71: Min PID Transducer Scaling

No. (Hex.)	Name	Description	Default (Range)
b5-71 (3C22)	Min PID Transducer Scaling	<div style="display: flex; gap: 5px;"> <span>V/f</span> <span>OLV/PM</span> <span>EZOLV</span> </div> Sets the minimum PID level corresponding to the lowest analog input signal level.	0.00 (-99.99 - +99.99)

**Note:**

- To enable this parameter, you must set  $b5-71 < b5-38$  [PID User Unit Display Scaling]. If you set  $b5-71 > b5-38$ , the drive will disable all PID analog inputs.
- Parameters  $b5-46$  [PID Unit Display Selection],  $b5-38$ , and  $b5-39$  [PID User Unit Display Digits] set the unit, scaling, and resolution.

When you set  $b5-71 < 0$ , the drive appropriately scales the setpoint and feedback values of the drive, but internally limits to 0 when the reported value from the transducer is negative.

[Figure 12.29](#) shows an example of the transducer scaling lower limit when:

- $b5-01 = 1$  [PID Mode Setting = Standard]
- $b5-46 = 3$  [ $^{\circ}$ F: Fahrenheit]
- $b5-71 < 0.00$
- $H3-09 = 0$  [Terminal A2 Signal Level Select = 0-10V (LowLim=0)]
- $H3-10 = B$  [Terminal A2 Function Selection = PID Feedback]

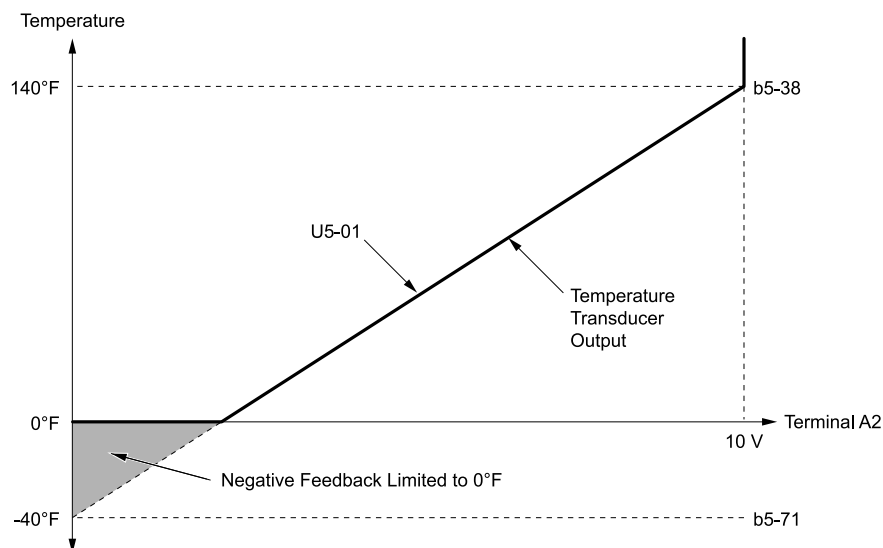

**b5-38: PID User Unit Display Scaling**  
**b5-71: Min PID Transducer Scaling**

**U5-01: PID Feedback**

Figure 12.29 Transducer Scaling Lower Limit

## ■ b5-82: Feedback Loss 4 ~ 20mA Detect Sel

No. (Hex.)	Name	Description	Default (Range)
b5-82 (31B0)	Feedback Loss 4 ~ 20mA Detect Sel	<input type="checkbox"/> V/f <input type="checkbox"/> OL/PM <input type="checkbox"/> EZOLV Sets the drive to do a 4 to 20 mA wire-break detection on the analog input set for PID feedback.	2 (0 - 3)

### 0 : Disabled

**Note:**

Drives with  $b5-82 = 0$  and  $Y9-02 \neq 3$  [System Feedback Source  $\neq$  Network Only] will not have feedback loss detection and will continuously send the analog PID feedback to the network when the signal is good or bad.

### 1 : Alarm Only

### 2 : Fault

**Note:**

When  $b5-82 = 2$  and  $Y9-02 \neq 3$ , PID feedback detection will trigger an alarm if one of these conditions is true:

- The drive is in HAND Mode
- There is no lead drive on the network
- The drive is not in AUTO Mode

### 3 : Run At b5-83

**Note:**

If you enable Wire-Break detection, set  $b5-83$  [Feedback Loss GoTo Frequency]  $<$   $Y9-09$  [Staging Frequency Level], and set  $b5-82 = 3$ , and you lose network feedback, the network will request for a de-stage. During an FLGT [Feedback Loss, Go To Freq  $b5-83$ ] alarm, the lag drives that are operating will continue to operate at the speed set in  $Y9-05$  [Lag Drive Mode].

If the drive detects a Wire-Break, the drive will respond as specified by  $b5-82$ .

**Note:**

- A: The keypad shows an FDBKL [Feedback Loss Wire Break] alarm.
- F: The drive detects an FDBKL [WIRE Break] fault.
- R: The drive operates at  $b5-83$  [Feedback Loss GoTo Frequency] and shows an FDBKL alarm.

b5-82 Setting	Drive Mode								
	OFF	Y4-17 [Utility Start Delay]	Pre-Charge	AUTO (Simplex)	HAND Mode PID	Sleep Boost	Y2-08 [Delta Feedback Drop Level]	Sleep	HAND Mode
0	-	-	-	-	-	-	-	-	-
1	A	A	A	A	A	A	A	A	A
2	A	F	F	F	F	F	F	F	A
3	A	A *1	R *2	R	R	R	R	R	A

\*1 The keypad will show the *FLGT* [Feedback Loss, Go To Freq b5-83] alarm. The drive will run at b5-83 after Utility Delay is expired.

\*2 The drive will operate at Y4-02 [Pre-Charge Frequency] while Pre-Charge is active.

**Note:**

- If the drive is set in a mode where the fault will occur, the drive will detect the fault only when the drive is in operation. If the drive is not in operation, the drive will detect an alarm. Refer to Figure 12.30 for an example where b5-82 = 2 [Fault] and the drive is OFF.
- If the Feedback Loss fault is set to L5-42 = 1 [Feedback Loss Fault Retry Select = Retry], the drive will use the L5-04 [Interval Method Restart Time] timer when it Auto-Restarts.

**PID Feedback Loss Detection Start Delay**

You can use b5-86 [Feedback Loss Start Delay] to delay the PID Feedback Loss Detection at start. Feedback Loss detection will still be active when b5-86 timer has started, but the drive will only detect an alarm. When b5-86 expires, the drive will use the b5-82 setting to start the appropriate action. Refer to Figure 12.30 for more information.

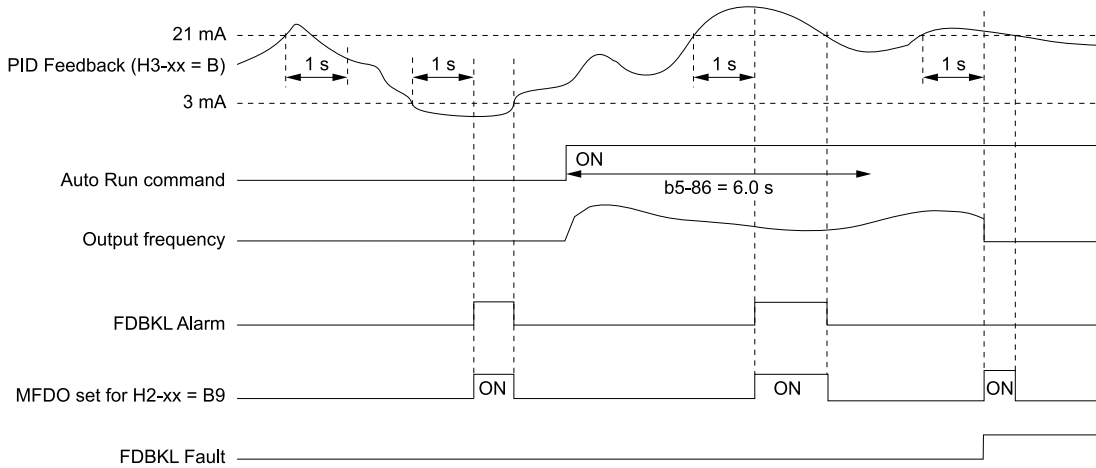

**b5-86: Feedback Loss Start Delay**  
**H2-xx = B9: Transducer Loss**  
**H3-xx = B: PID Feedback**

**FDBKL Alarm: Feedback Loss Wire Break**  
**FDBKL Fault: WIRE Break**

**Figure 12.30 Time Chart for the Wire Break Detection when b5-82 = 2 [Fault]**

**PID Feedback Loss Go To Frequency Timeout**

The drive will apply this feature only when b5-82 = 3 [Run At b5-83] and it detects a Feedback Loss. Parameter b5-85 [Feedback Loss GoTo Freq Timeout] sets the length of time that the drive will run at the frequency set in b5-83 [Feedback Loss GoTo Frequency].

- When b5-85 = 0 sec, the drive will operate at the b5-83 speed indefinitely.
- When b5-85 > 0 sec, the drive will only operate at the b5-83 speed for the time specified in b5-85, after which the drive will fault on an *FDBKL* [WIRE Break] fault.

Refer to Figure 12.31 for more information.



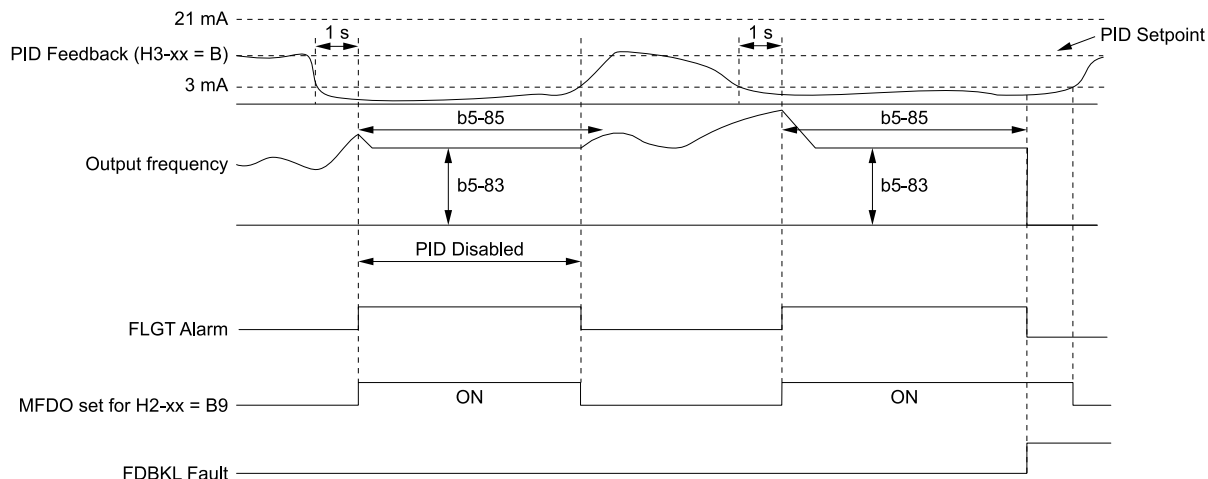

**b5-83: Feedback Loss GoTo Frequency**                      **H3-xx = B: PID Feedback**  
**b5-85: Feedback Loss GoTo Freq Timeout**                      **FDBKL Fault: WIRE Break**  
**b5-86: Feedback Loss Start Delay**                      **FLGT Alarm: Feedback Loss, Go To Freq b5-83**  
**H2-xx = B9: Transducer Loss**

Figure 12.31 Time Chart for the Wire Break Detection when b5-82 = 3

### Backup PID Feedback Transducer Input

When you set  $H3-xx = 24$  [MFAI Function Selection = PID Feedback Backup], the drive will activate the PID Feedback Backup signal.

- If the primary PID Feedback ( $H3-xx = B$  [PID Feedback]) is lost, the system will automatically use the backup PID Feedback from the MFAI terminal set for  $H3-xx = 24$  and flash a *Bu-Fb* [Main Fdbk Lost Using Backup Fdbk] alarm.
- If the main PID Feedback is operational, but the backup PID Feedback is lost, the drive will show a *BuFbl* [Backup Fdbk Lost Chk/Repl Xducer] alarm. If the main and backup PID Feedback devices are lost, the drive will use the *b5-82* [Feedback Loss 4 ~ 20mA Detect Sel] setting.

**Note:**

To enable the *FDBKL* [WIRE Break] detection correctly, use a 4 to 20 mA operation in these conditions:

- Use a 4 to 20 mA signal for transducers.
  - Program the drive analog inputs and set Jumper Switch S1 to "I" for current input.
- If you set the analog input for voltage, the drive will disable the detection mechanism.

### ■ b5-83: Feedback Loss GoTo Frequency

No. (Hex.)	Name	Description	Default (Range)
b5-83 (31B1) RUN	Feedback Loss GoTo Frequency	<b>V/f</b> <b>OLV/PM</b> <b>EZOLV</b> Sets the speed at which the drive will run if the drive detects a 4 to 20 mA wire-break on the PID Feedback and $b5-82 = 3$ [Feedback Loss 4 ~ 20mA Detect Sel = Run At b5-83].	0.0 Hz (0.0 - 400.0 Hz)

**Note:**

When  $A1-02 = 8$  [Control Method Selection = EZ Vector Control], the range is 0.0 to 120.0 Hz.

### ■ b5-84: Feedback Loss Loss Of Prime Lvl

No. (Hex.)	Name	Description	Default (Range)
b5-84 (31B2) RUN	Feedback Loss Loss Of Prime Lvl	<b>V/f</b> <b>OLV/PM</b> <b>EZOLV</b> Sets the level at which the drive will detect Loss of Prime in the pump.	0.0 A (0.0 - 1000.0 A)

## 12.3 b: Application

### Note:

- A Loss of Prime condition occurs when the measured quantity set by Y1-18 [Prime Loss Detection Method] decreases to this level for the time set in Y1-20 [Loss of Prime Time] and the output frequency is at the Y4-02 [Pre-Charge Frequency] level.
- The drive will respond to the Loss of Prime condition as specified by Y1-22 [Loss of Prime Selection].
- Display unit and scaling are dependent on System Units.

### ■ b5-85: Feedback Loss GoTo Freq Timeout

No. (Hex.)	Name	Description	Default (Range)
b5-85 (31B3) RUN	Feedback Loss GoTo Freq Timeout	<div style="display: flex; gap: 5px;"> <span>V/f</span> <span>OLV/PM</span> <span>EZOLV</span> </div> <p>When b5-82 = 3 [Feedback Loss 4 ~ 20mA Detect Sel = Run At b5-83] and the Feedback signal is lost, the drive will run at the b5-83 [Feedback Loss Goto Frequency] speed for this length of time, after which the drive will fault on FDBKL [WIRE Break].</p>	0 s (0 - 6000 s)

### Note:

Set this parameter to 0 s to disable the function.

### ■ b5-86: Feedback Loss Start Delay

No. (Hex.)	Name	Description	Default (Range)
b5-86 (31B4) RUN	Feedback Loss Start Delay	<div style="display: flex; gap: 5px;"> <span>V/f</span> <span>OLV/PM</span> <span>EZOLV</span> </div> <p>When you initiate an AUTO Run command, the drive will wait for this length of time before it will fault on FDBKL [WIRE Break] or use parameter b5-83 [Feedback Loss Goto Frequency].</p>	0.0 s (0.0 - 120.0 s)

## ◆ b8: Energy Saving

Energy-saving control operates the motor at its most efficient level to improve overall system operating efficiency.

When you use V/f Control, set these parameters:

- b8-01 [Energy Saving Control Selection]
- b8-04 [Energy Saving Coefficient Value]
- b8-05 [Power Detection Filter Time]
- b8-06 [Search Operation Voltage Limit]

### Note:

- Energy-saving control is not appropriate for applications with sudden changes in the load or applications driving heavy loads.
- Energy-saving control maximizes operation based on precise motor data set to the drive. Do Auto-Tuning and enter the correct information about the motor before you use Energy-saving control.

### ■ b8-01: Energy Saving Control Selection

No. (Hex.)	Name	Description	Default (Range)
b8-01 (01CC)	Energy Saving Control Selection	<div style="display: flex; gap: 5px;"> <span>V/f</span> <span>OLV/PM</span> <span>EZOLV</span> </div> <p>Sets the Energy-saving control function.</p>	0 (0, 1)

0 : Disabled

1 : Enabled

### ■ b8-04: Energy Saving Coefficient Value

No. (Hex.)	Name	Description	Default (Range)
b8-04 (01CF) Expert	Energy Saving Coefficient Value	<div style="display: flex; gap: 5px;"> <span>V/f</span> <span>OLV/PM</span> <span>EZOLV</span> </div> <p>Sets the Energy-saving control coefficient to maintain maximum motor efficiency. The default setting is for Yaskawa motors.</p>	Determined by E2-11 and o2-04 (0.00 - 655.00)

When you use a motor from a different manufacturer, increase the setting value in 5% increments to find the minimum value for U1-08 [Output Power] at light loads.

When you decrease the setting value, it decreases the output voltage and decreases power consumption. If the setting value is too low, the motor will stall.

**Note:**

- When you do Rotational Auto-Tuning, the drive will automatically set the energy-saving coefficient.
- The minimum values and the maximum values are different for different drive models.
  - 2011 to 2024, 4005 and 4008: 0.0 - 2000.0
  - 2031 to 2273, 4011 to 4302: 0.00 - 655.00

### ■ b8-05: Power Detection Filter Time

No. (Hex.)	Name	Description	Default (Range)
b8-05 (01D0) Expert	Power Detection Filter Time	<div style="display: flex; justify-content: space-between; align-items: center;"> <span>V/f</span> <span>OLV/PM</span> <span>EZOLV</span> </div> Sets the time constant to measure output power.	20 ms (0 - 2000 ms)

Decrease the setting value to increase responsiveness to load changes. If you set the value too low during operation at light loads, motor speed is not stable.

### ■ b8-06: Search Operation Voltage Limit

No. (Hex.)	Name	Description	Default (Range)
b8-06 (01D1) Expert	Search Operation Voltage Limit	<div style="display: flex; justify-content: space-between; align-items: center;"> <span>V/f</span> <span>OLV/PM</span> <span>EZOLV</span> </div> Sets the voltage limit for Search Operation as a percentage of the motor rated voltage.	0% (0 - 100%)

The Search Operation changes the output voltage in small increments to find a setpoint at which the drive can use minimum power to operate.

Set this parameter to 0 to disable Search Operation. This will not disable Energy-saving control.

If the setting value is too low, the motor will stall when loads suddenly increase.

### ■ b8-19: E-Save Search Frequency

No. (Hex.)	Name	Description	Default (Range)
b8-19 (0B40) Expert	E-Save Search Frequency	<div style="display: flex; justify-content: space-between; align-items: center;"> <span>V/f</span> <span>OLV/PM</span> <span>EZOLV</span> </div> Sets the frequency of Energy-saving control search operations. Usually it is not necessary to change this setting.	Determined by A1-02 (10 - 300 Hz)

**Note:**

- If low inertia causes vibration in the machine, increase the setting value in 10 Hz increments and check the response. If  $A1-02 = 8$  [Control Method Selection = EZOLV], increase the setting value in 1 Hz increments.
- To make the motor more efficient, decrease the setting value in 1 Hz increments until the point immediately before machine vibration starts to occur.

### ■ b8-20: E-Save Search Width

No. (Hex.)	Name	Description	Default (Range)
b8-20 (0B41) Expert	E-Save Search Width	<div style="display: flex; justify-content: space-between; align-items: center;"> <span>V/f</span> <span>OLV/PM</span> <span>EZOLV</span> </div> Sets the amplitude of Energy-saving control search operations.	1.0 degrees (0.1 - 5.0 degrees)

An increase in the value can make the operational efficiency better. However, if the load inertia is small, it may be necessary to adjust the value to prevent machine vibration.

**Note:**

- If low inertia causes vibration in the machine, decrease the setting value in 1.0-degree increments and check the response.
- To make the motor more efficient, increase the setting value in 1.0-degree increments until the point immediately before machine vibration starts to occur.

### ■ b8-28: Over Excitation Action Selection

No. (Hex.)	Name	Description	Default (Range)
b8-28 (0B8B) Expert	Over Excitation Action Selection	<div style="display: flex; gap: 5px;"> <span>V/f</span> <span>OLV/PM</span> <span style="background-color: #cccccc;">EZOLV</span> </div> Sets the function for excitation operation.	0 (0, 1)

When operation is not stable at low speeds, set this parameter to 1 to enable the function.

**0 : Disabled**

**1 : Enabled**

### ■ b8-29: Energy Saving Priority Selection

No. (Hex.)	Name	Description	Default (Range)
b8-29 (0B8C)	Energy Saving Priority Selection	<div style="display: flex; gap: 5px;"> <span>V/f</span> <span>OLV/PM</span> <span style="background-color: #cccccc;">EZOLV</span> </div> Sets the priority of drive response between changes to the load or Energy-saving control. Enable this to prioritize energy-saving control. Disable this to prioritize tracking related to fast load changes, and prevent motor stall.	0 (0, 1)

Enable this parameter when there are small changes in the load. It is possible that the motor cannot respond correctly to changes in the load.

**0 : Priority: Drive Response**

**1 : Priority: Energy Savings**

## 12.4 C: Tuning

*C* parameters adjust drive operation, including:

- Acceleration Time
- Deceleration Time
- Slip Compensation
- Torque Compensation
- Carrier Frequency

### ◆ C1: Accel & Decel Time

You can set two different acceleration and deceleration time pairs in the drive. When you activate and deactivate *H1-xx = 7, 16* [*MFDI Function Selection = Accel/Decel Time Selection 1, Motor 2 Selection*], you can switch acceleration and deceleration times during run.

Acceleration time parameters always set the time to accelerate from 0 Hz to *E1-04* [*Maximum Output Frequency*]. Deceleration time parameters always set the time to decelerate from *E1-04* to 0 Hz.

*C1-01* [*Acceleration Time 1*] and *C1-02* [*Deceleration Time 1*] are the default active accel/decel settings.

Parameter	Range
C1-01 [Acceleration Time 1]	0.1 to 6000.0 s
C1-02 [Deceleration Time 1]	
C1-03 [Acceleration Time 2]	
C1-04 [Deceleration Time 2]	
C1-05 [Acceleration Time 3]	
C1-06 [Deceleration Time 3]	
C1-07 [Acceleration Time 4]	
C1-08 [Deceleration Time 4]	

### ■ Use MFDIs to Switch Acceleration Times

Table 12.31 shows the different acceleration and deceleration times.

**Table 12.31 Accel/Decel Times and Active Parameters**

H1-xx = 7 [Accel/Decel Time Selection 1]	Active Parameter	
	Acceleration Time	Deceleration Time
OFF	C1-01 [Acceleration Time 1]	C1-02 [Deceleration Time 1]
ON	C1-03 [Acceleration Time 2]	C1-04 [Deceleration Time 2]

Figure 12.32 shows an operation example to change acceleration and deceleration times. It is necessary to set *b1-03 = 0* [*Stopping Method Selection = Ramp to Stop*] for this example.

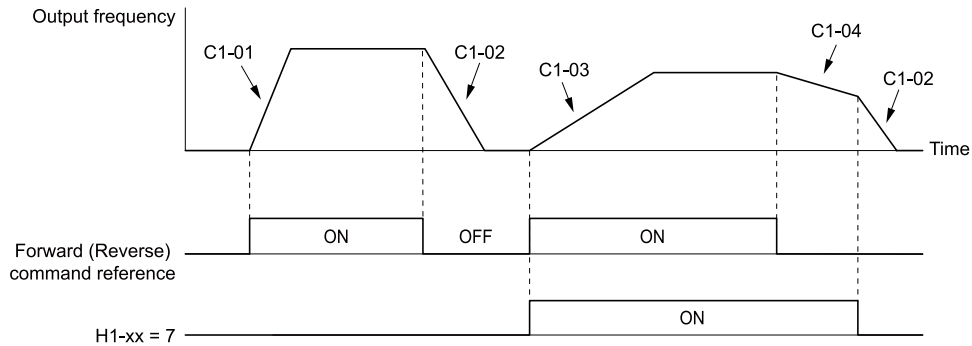

**C1-01: Acceleration Time 1**  
**C1-02: Deceleration Time 1**  
**C1-03: Acceleration Time 2**

**C1-04: Deceleration Time 2**  
**H1-xx = 7: Accel/Decel Time Selection 1**

Figure 12.32 Timing Diagram of Acceleration and Deceleration Times

■ Use Motor Selection to Switch Acceleration and Deceleration Times

When you set  $H1-xx = 16$  [MFDI Function Selection = Motor 2 Selection], you can activate and deactivate the input terminal to switch between motor 1 and motor 2.

**Note:**

You cannot use the Motor 2 Selection function with PM motors.

Table 12.32 shows the possible acceleration and deceleration time combinations when you use the Motor 2 Selection function.

Table 12.32 Motor Selection and Acceleration and Deceleration Times

H1-xx = 7 [Accel/Decel Time Selection 1]	H1-xx = 16 [Motor 2 Selection]			
	Motor 2 Selection: OFF		Motor 2 Selection: ON *1	
	Acceleration Time	Deceleration Time	Acceleration Time	Deceleration Time
OFF	C1-01	C1-02	C1-05	C1-06
ON	C1-03	C1-04	C1-07	C1-08

\*1 For software version PRG: 01011, when Motor 2 Selection is ON, the drive sets acceleration and deceleration times to 10.0 s.

■ C1-01: Acceleration Time 1

No. (Hex.)	Name	Description	Default (Range)
C1-01 (0200) RUN	Acceleration Time 1	<b>V/f</b> <b>OLV/PM</b> <b>EZOLV</b> Sets the length of time to accelerate from zero to maximum output frequency.	30.0 s (0.1 - 6000.0 s)

■ C1-02: Deceleration Time 1

No. (Hex.)	Name	Description	Default (Range)
C1-02 (0201) RUN	Deceleration Time 1	<b>V/f</b> <b>OLV/PM</b> <b>EZOLV</b> Sets the length of time to decelerate from maximum output frequency to zero.	30.0 s (0.1 - 6000.0 s)

■ C1-03: Acceleration Time 2

No. (Hex.)	Name	Description	Default (Range)
C1-03 (0202) RUN	Acceleration Time 2	<b>V/f</b> <b>OLV/PM</b> <b>EZOLV</b> Sets the length of time to accelerate from zero to maximum output frequency.	30.0 s (0.1 - 6000.0 s)

### ■ C1-04: Deceleration Time 2

No. (Hex.)	Name	Description	Default (Range)
C1-04 (0203) RUN	Deceleration Time 2	<input type="checkbox"/> V/f <input type="checkbox"/> OLV/PM <input type="checkbox"/> EZOLV Sets the length of time to decelerate from maximum output frequency to zero.	30.0 s (0.1 - 6000.0 s)

### ■ C1-05: Acceleration Time 3

No. (Hex.)	Name	Description	Default (Range)
C1-05 (0204) RUN	Acceleration Time 3	<input type="checkbox"/> V/f <input type="checkbox"/> OLV/PM <input type="checkbox"/> EZOLV Sets the length of time to accelerate from zero to maximum output frequency.	30.0 s (0.1 - 6000.0 s)

### ■ C1-06: Deceleration Time 3

No. (Hex.)	Name	Description	Default (Range)
C1-06 (0205) RUN	Deceleration Time 3	<input type="checkbox"/> V/f <input type="checkbox"/> OLV/PM <input type="checkbox"/> EZOLV Sets the length of time to decelerate from maximum output frequency to zero.	30.0 s (0.1 - 6000.0 s)

### ■ C1-07: Acceleration Time 4

No. (Hex.)	Name	Description	Default (Range)
C1-07 (0206) RUN	Acceleration Time 4	<input type="checkbox"/> V/f <input type="checkbox"/> OLV/PM <input type="checkbox"/> EZOLV Sets the length of time to accelerate from zero to maximum output frequency.	30.0 s (0.1 - 6000.0 s)

### ■ C1-08: Deceleration Time 4

No. (Hex.)	Name	Description	Default (Range)
C1-08 (0207) RUN	Deceleration Time 4	<input type="checkbox"/> V/f <input type="checkbox"/> OLV/PM <input type="checkbox"/> EZOLV Sets the length of time to decelerate from maximum output frequency to zero.	30.0 s (0.1 - 6000.0 s)

### ■ C1-09: Fast Stop Time

No. (Hex.)	Name	Description	Default (Range)
C1-09 (0208) RUN	Fast Stop Time	<input type="checkbox"/> V/f <input type="checkbox"/> OLV/PM <input type="checkbox"/> EZOLV Sets the length of time that the drive will decelerate to zero for a Fast Stop.	10.0 s (0.1 - 6000.0 s)

These conditions will start the Fast Stop function:

- When the drive received the Fast Stop command from the MFDI terminal
- When you set *Fast Stop (Use C1-09)* for a parameter to set a stopping method when the drive detected a fault Set  $H1-xx = 15, 17$  [*MFDI Function Selection = Fast Stop (N.O.), Fast Stop (N.C.)*].

When the drive receives the Fast Stop command, the motor ramps to stop in the deceleration time set in *C1-09*. After the drive receives the Fast Stop command, you cannot start the drive operation again until deceleration is complete. To clear the Fast Stop condition, deactivate the Fast Stop command, deactivate the Run command, then activate the Run command again.

The terminal set for  $H2-xx = 4C$  [*MFDO Function Selection = During Fast Stop*] will activate during Fast Stop.

**Note:**

If you decelerate the drive too quickly, the drive will detect an *ov [Overvoltage]* fault and shut off the output, and the motor will coast to stop. To prevent motor coasting and stop the motor quickly and safely, make sure to set a Fast Stop time in *C1-09*.

## ◆ C2: S-Curve Characteristics

Use S-curve characteristics to smooth acceleration and deceleration and to minimize abrupt shock to the load. Set S-curve characteristic time during acceleration/deceleration at start and acceleration/deceleration at stop. The following figure explains how S-curves are applied.

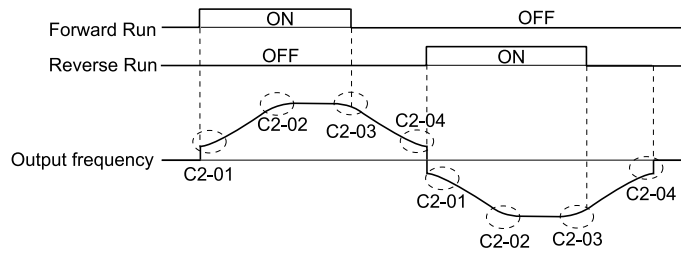

Figure 12.33 S-Curve Timing Diagram - Forward/Reverse Operation

### Note:

- If *STPo* [*Motor Step-Out Detected*] occurs when starting a PM motor, try increasing the value set to *C2-01*.
- Setting the S-curve will increase the acceleration and deceleration times.

$$\text{Acceleration time} = \text{Selected acceleration time} + \frac{C2-01 + C2-02}{2}$$

$$\text{Deceleration time} = \text{Selected deceleration time} + \frac{C2-03 + C2-04}{2}$$

### ■ C2-01: S-Curve Time @ Start of Accel

No. (Hex.)	Name	Description	Default (Range)
C2-01 (020B)	S-Curve Time @ Start of Accel	<input type="checkbox"/> V/f <input type="checkbox"/> OLV/PM <input type="checkbox"/> EZOLV Sets the S-curve acceleration time at start.	Determined by A1-02 (0.00 - 10.00 s)

### ■ C2-02: S-Curve Time @ End of Accel

No. (Hex.)	Name	Description	Default (Range)
C2-02 (020C)	S-Curve Time @ End of Accel	<input type="checkbox"/> V/f <input type="checkbox"/> OLV/PM <input type="checkbox"/> EZOLV Sets the S-curve acceleration time at completion.	0.20 s (0.00 - 10.00 s)

### ■ C2-03: S-Curve Time @ Start of Decel

No. (Hex.)	Name	Description	Default (Range)
C2-03 (020D)	S-Curve Time @ Start of Decel	<input type="checkbox"/> V/f <input type="checkbox"/> OLV/PM <input type="checkbox"/> EZOLV Sets the S-curve deceleration time at start.	0.20 s (0.00 - 10.00 s)

### ■ C2-04: S-Curve Time @ End of Decel

No. (Hex.)	Name	Description	Default (Range)
C2-04 (020E)	S-Curve Time @ End of Decel	<input type="checkbox"/> V/f <input type="checkbox"/> OLV/PM <input type="checkbox"/> EZOLV Sets the S-curve deceleration time at completion.	0.00 s (0.00 - 10.00 s)

## ◆ C3: Slip Compensation

The Slip Compensation function improves the speed accuracy of an induction motor. As loads on induction motors increase, motor slip increases and motor speed decreases. By adjusting the output frequency in accordance with the motor load, it compensates the slip and makes the motor speed equal to the frequency reference.



### ■ C3-01: Slip Compensation Gain

No. (Hex.)	Name	Description	Default (Range)
C3-01 (020F) RUN	Slip Compensation Gain	<b>V/f</b> <b>OLV/PM</b> <b>EZOLV</b> Sets the gain for the slip compensation function. Usually it is not necessary to change this setting.	0.0 (0.0 - 2.5)

**Note:**

Correctly set these parameters before you change the slip compensation gain:

- E2-01 [Motor Rated Current (FLA)]
- E2-02 [Motor Rated Slip]
- E2-03 [Motor No-Load Current]

Use these settings to adjust this parameter as necessary:

- If the motor speed is slower than the frequency reference, increase the setting of this parameter in 0.1-unit increments.
- If the motor speed is higher than the frequency reference, decrease the setting of this parameter in 0.1-unit increments.

### ■ C3-02: Slip Compensation Delay Time

No. (Hex.)	Name	Description	Default (Range)
C3-02 (0210) RUN	Slip Compensation Delay Time	<b>V/f</b> <b>OLV/PM</b> <b>EZOLV</b> Sets the slip compensation delay time when speed is unstable or when the slip compensation response is too slow. Usually it is not necessary to change this setting.	Determined by A1-02 (0 - 10000 ms)

Use these settings to adjust this parameter as necessary:

- When the speed is not stable, increase the setting.
- When the slip compensation response is too slow, decrease the setting.

### ■ C3-21: Motor 2 Slip Compensation Gain

No. (Hex.)	Name	Description	Default (Range)
C3-21 (033E) RUN	Motor 2 Slip Compensation Gain	<b>V/f</b> <b>OLV/PM</b> <b>EZOLV</b> Sets the gain for the motor 2 slip compensation function. Usually it is not necessary to change this setting.	0.0 (0.0 - 2.5)

**Note:**

Correctly set these parameters before you change the slip compensation gain:

- E4-01 [Motor 2 Rated Current]
- E4-02 [Motor 2 Rated Slip]
- E4-03 [Motor 2 Rated No-Load Current]

Use these settings to adjust this parameter as necessary:

- If the motor speed is slower than the frequency reference, increase the setting of this parameter in 0.1-unit increments.
- If the motor speed is higher than the frequency reference, decrease the setting of this parameter in 0.1-unit increments.

### ■ C3-22: Motor 2 Slip Comp Delay Time

No. (Hex.)	Name	Description	Default (Range)
C3-22 (0241) RUN	Motor 2 Slip Comp Delay Time	<b>V/f</b> <b>OLV/PM</b> <b>EZOLV</b> Sets the slip compensation delay time for motor 2 when speed is unstable or when the slip compensation response is too slow. Usually it is not necessary to change this setting.	2000 (0 - 10000 ms)

Use these settings to adjust this parameter as necessary:

- When the speed is not stable, increase the setting.

- When the slip compensation response is too slow, decrease the setting.

### ■ C3-29: Slip Compensation Gain @ Low Spd

No. (Hex.)	Name	Description	Default (Range)
C3-29 (1B5D) RUN Expert	Slip Compensation Gain @ Low Spd	<b>V/f</b> <b>OLV/PM</b> <b>EZOLV</b> Sets the slip compensation gain at low speed. Usually it is not necessary to change this setting.	0.0 (0.0 - 2.5)

Use these settings to adjust this parameter as necessary:

- If the motor speed is slower than the frequency reference, increase the setting of this parameter in 0.1-unit increments.
- If the motor speed is higher than the frequency reference, decrease the setting of this parameter in 0.1-unit increments.

## ◆ C4: Torque Compensation

Torque compensation is a function that increases voltage to increase output torque as compensation for insufficient torque production at start-up or low-speed operation.

Voltage drops due to motor winding resistance cause torque generating voltage to decrease, which causes insufficient torque. If the main circuit cable connecting the drive and motor is long, this can also cause insufficient torque due to voltage drops.

**Note:**

Set the motor parameters and V/f pattern properly before setting *C4* parameters.

### ■ C4-01: Torque Compensation Gain

No. (Hex.)	Name	Description	Default (Range)
C4-01 (0215) RUN	Torque Compensation Gain	<b>V/f</b> <b>OLV/PM</b> <b>EZOLV</b> Sets the gain for the torque compensation function. Use this parameter value for motor 1 when you operate multiple motors.	Determined by A1-02 (0.00 - 2.50)

Adjust the setting in these control methods and conditions:

A1-02 [Control Method Selection]	Status	Adjustment
0 [V/f Control] 8 [EZ Vector Control]	Torque is not sufficient during low-speed operation of 10 Hz or less.	Increase the setting in 0.05-unit increments.
	There is vibration in the motor when you operate the drive with a light load.	Decrease the setting in 0.05-unit decrements.
	The cable between the drive and motor is too long.	Increase the setting in 0.05-unit increments.

**Note:**

- Adjust *C4-01* to make sure that the output current is not more than the drive rated current during low-speed operation.
- When *A1-02* = 5 [*PM Open Loop Vector*], usually it is not necessary to change this setting. Setting this value too high can cause overcompensation and motor oscillation.
- When *A1-02* = 8 [*EZ Vector Control*], you cannot change the setting while the drive is running.

### ■ C4-02: Torque Compensation Delay Time

No. (Hex.)	Name	Description	Default (Range)
C4-02 (0216) RUN	Torque Compensation Delay Time	<b>V/f</b> <b>OLV/PM</b> <b>EZOLV</b> Sets the torque compensation delay time. Usually it is not necessary to change this setting.	Determined by A1-02 (0 - 60000 ms)

**Note:**

If *A1-02* = 5, 8 [*Control Method Selection* = *OLV/PM, EZOLV*], you cannot change the setting while the drive is running.

Set this parameter in these conditions:

- If there is vibration in the motor, increase the setting.
- If the motor speed or motor torque response is too slow, decrease the setting.

### ■ C4-07: Motor 2 Torque Compensation Gain

No. (Hex.)	Name	Description	Default (Range)
C4-07 (0341) RUN	Motor 2 Torque Compensation Gain	<b>V/f</b> <b>OLV/PM</b> <b>EZOLV</b> Sets the gain for motor 2 torque compensation function when you use the Motor Switch function.	1.00 (0.00 - 2.50)

In V/f Control, adjust the value in 0.05-unit increments for these conditions:

- When torque is not sufficient during low-speed operation of 10 Hz or less, increase the setting value
- When there is vibration in the motor or when the motor hunts when operating the drive with a light load, decrease the setting value
- When you use a long motor cable, increase the setting.

**Note:**

Adjust C4-07 and make sure that the output current is not more than the drive rated current during low-speed operation.

### ■ C4-23: Current Control Gain

No. (Hex.)	Name	Description	Default (Range)
C4-23 (1583) Expert	Current Control Gain	<b>V/f</b> <b>OLV/PM</b> <b>EZOLV</b> Current control gain. Usually it is not necessary to change this parameter.	1.00 (0.50 - 2.50)

## ◆ C5: Auto Speed Regulator (ASR)

The ASR adjusts the torque reference to decrease the difference between frequency reference and motor speed. You can use this function only when you set A1-02 = 8 [Control Method Selection = EZOLV].

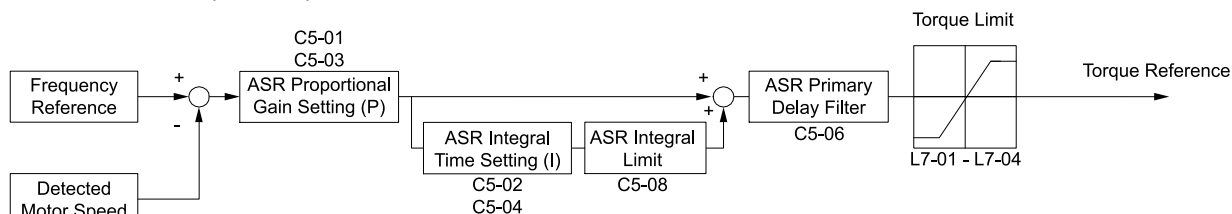

Figure 12.34 Speed Control Block Diagrams for EZOLV

**Note:**

The detected speed is the speed estimation value.

### ■ Before You Adjust ASR Parameters

- Do Auto-Tuning and set up all motor data correctly.
- Always connect the load to the motor when you make adjustments.
- Use analog output signals to monitor U1-16 [SFS Output Frequency] and U1-05 [Motor Speed] when you adjust the ASR.

### ■ ASR Adjustment Procedure for EZOLV

Do this procedure to adjust ASR parameters:

1. Run the motor at zero speed or low speed and increase C5-01 [ASR Proportional Gain 1] until immediately before vibration starts to occur.
2. Run the motor at zero speed or low speed and decrease C5-02 [ASR Integral Time 1] until immediately before vibration starts to occur.
3. Check for oscillation when you run the motor at maximum speed.

4. If oscillation occurs, increase *C5-02* and decrease *C5-01*.  
When there is no oscillation, the adjustment procedure is complete.
5. Set the low-speed gain. Run the motor at zero speed or low speed and increase *C5-03* [ASR Proportional Gain 2] until immediately before vibration starts to occur.

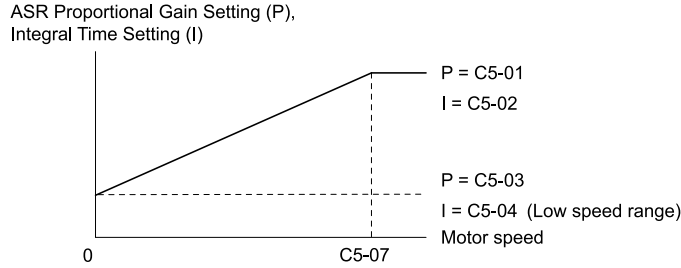

**C5-01: ASR Proportional Gain 1**  
**C5-02: ASR Integral Time 1**  
**C5-03: ASR Proportional Gain 2**

**C5-04: ASR Integral Time 2**  
**C5-07: ASR Gain Switchover Frequency**

**Figure 12.35 Low-speed/High-speed Gain Settings**

6. Set the low-speed integral time. Run the motor at zero speed or low speed and decrease *C5-04* [ASR Integral Time 2] until immediately before vibration starts to occur.
7. Set *C5-07* [ASR Gain Switchover Frequency].
8. Check for oscillation when you run the motor at speeds higher than *C5-07*.

**Note:**

- If overshooting occurs when acceleration ends, decrease *C5-01* and increase *C5-02*.
- If there is undershoot at stop, decrease *C5-03* and increase *C5-04*.

**■ Use MFDI Switch for Proportional Gain**

You can use the input terminals set for *H1-xx = 77* [ASR Gain (*C5-03*) Select] to switch the proportional gains set with *C5-01* and *C5-03*. When the configured input terminal is deactivated, the proportional gain set for *C5-01* is selected. When the terminal is activated, the proportional gain set for *C5-03* is selected. The proportional gain changes linearly over the time set in *C5-02* [ASR Integral Time 1]. The signals from this MFDI are more important than *C5-07* [ASR Gain Switchover Frequency].

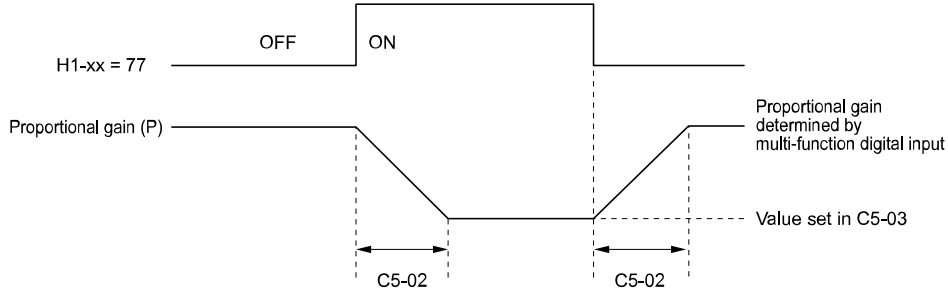

**C5-02: ASR Integral Time 1**  
**C5-03: ASR Proportional Gain 2**

**H1-xx = 77: ASR Gain (*C5-03*) Select**

**Figure 12.36 Proportional Gain through Multi-function Digital Input Switch**

**■ Speed Waveform Monitoring Method**

To make small adjustments of ASR parameters, monitor the speed waveforms when you make the adjustments. [Table 12.33](#) shows example settings of parameters to monitor speed waveforms.

Table 12.33 Example Settings of MFAO Terminals to Monitor Speed Waveforms

No.	Name	Setting Value	Description
H4-01	Terminal FM Analog Output Select	116	Lets you use terminal FM to monitor U1-16 [SFS Output Frequency].
H4-02	Terminal FM Analog Output Gain	100.0%	
H4-03	Terminal FM Analog Output Bias	0.0%	
H4-04	Terminal AM Analog Output Select	105	Lets you use the terminal AM to monitor U1-05 [Motor Speed].
H4-05	Terminal AM Analog Output Gain	50.0%	
H4-06	Terminal AM Analog Output Bias	0.0%	
H4-07	Terminal FM Signal Level Select	0	Lets you monitor in a 0 V to 10 V range.
H4-08	Terminal AM Signal Level Select	0	

These settings cause this MFAO configuration. The MFAO common is terminal AC:

- Terminal FM: Outputs the output frequency after SFS in a 0 V to 10 V (0% to 100%) range.
- Terminal AM: Outputs the motor speed in a 0 V to 10 V (0% to 200%) range.

Yaskawa recommends that you monitor the output frequency after SFS and the motor speed for delays in response and differences in reference values.

### ■ Adjust ASR Parameters

Use Table 12.34 to adjust ASR. The table shows the parameters for motor 1. To operate motor 2, set the motor 2 parameters in the same method.

#### Note:

When you adjust the proportional gain and integral time, adjust the proportional gain first.

Table 12.34 ASR Response and Possible Solutions

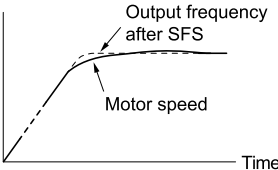
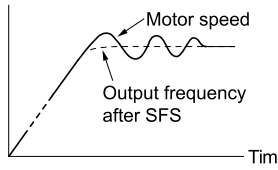
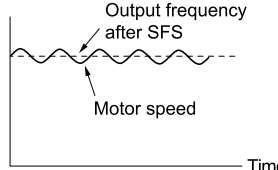
Problem		Possible Solutions
Speed response is slow.		<ul style="list-style-type: none"> <li>• Increase C5-01/C5-03 [ASR Proportional Gain].</li> <li>• Decrease C5-02/C5-04 [ASR Integral Time].</li> </ul>
Overshoot or undershoot occurs at the end of acceleration or deceleration.		<ul style="list-style-type: none"> <li>• Decrease C5-01/C5-03.</li> <li>• Increase C5-02/C5-04.</li> </ul>
Vibration and oscillation occur at constant speed.		<ul style="list-style-type: none"> <li>• Decrease C5-01/C5-03.</li> <li>• Increase C5-02/C5-04.</li> <li>• Increase C5-06 [ASR Delay Time].</li> </ul>

### ■ C5-01: ASR Proportional Gain 1

No. (Hex.)	Name	Description	Default (Range)
C5-01 (021B) RUN	ASR Proportional Gain 1	<div style="display: flex; gap: 5px;"> <span>V/f</span> <span>OLV/PM</span> <span style="border: 1px solid black; padding: 2px;">EZOLV</span> </div> Sets the gain to adjust ASR response.	Determined by A1-02 (0.00 - 300.00)

A higher gain provides a higher speed response. Usually, the gain increases with larger loads. Too much gain will cause vibration.

**Note:**

- The drive usually sets Motor 1 ASR with *C5-01* and *C5-02* [*ASR Integral Time 1*]. You can set *H1-xx = 77* [*MFDI Function Selection = ASR Gain (C5-03) Select*] to switch between *C5-01* and *C5-03* [*ASR Proportional Gain 2*]. You can also use *C5-01* and *C5-02* as alternatives to *C5-03* and *C5-04*, respectively, when the speed is less than or equal to the frequency set in *C5-07* [*ASR Gain Switchover Frequency*].
- The drive automatically adjusts *C5-01* in ASR Tuning.

■ **C5-02: ASR Integral Time 1**

No. (Hex.)	Name	Description	Default (Range)
C5-02 (021C) RUN	ASR Integral Time 1	<input type="checkbox"/> V/f <input type="checkbox"/> OLV/PM <input checked="" type="checkbox"/> EZOLV Sets the ASR integral time.	Determined by A1-02 (0.000 - 60.000 s)

When you increase the integral time, the responsiveness will decrease. An integral time that is too short can cause oscillation.

■ **C5-03: ASR Proportional Gain 2**

No. (Hex.)	Name	Description	Default (Range)
C5-03 (021D) RUN	ASR Proportional Gain 2	<input type="checkbox"/> V/f <input type="checkbox"/> OLV/PM <input checked="" type="checkbox"/> EZOLV Sets the gain to adjust ASR response.	Determined by A1-02 (0.00 - 300.00)

A higher gain provides a higher speed response. Usually, the gain increases with larger loads. Too much gain will cause vibration.

■ **C5-04: ASR Integral Time 2**

No. (Hex.)	Name	Description	Default (Range)
C5-04 (021E) RUN	ASR Integral Time 2	<input type="checkbox"/> V/f <input type="checkbox"/> OLV/PM <input checked="" type="checkbox"/> EZOLV Sets the ASR integral time.	Determined by A1-02 (0.000 - 60.000 s)

When you increase the integral time, the responsiveness will decrease. An integral time that is too short can cause oscillation.

■ **C5-06: ASR Delay Time**

No. (Hex.)	Name	Description	Default (Range)
C5-06 (0220)	ASR Delay Time	<input type="checkbox"/> V/f <input type="checkbox"/> OLV/PM <input checked="" type="checkbox"/> EZOLV Sets the filter time constant of the torque reference output from the speed loop. Usually it is not necessary to change this setting.	Determined by A1-02 (0.000 - 0.500 s)

If you have a load with low rigidity or if oscillation is a problem, decrease *C5-01* in 2-unit decrements or decrease *C5-06* in 0.001-unit decrements.

■ **C5-07: ASR Gain Switchover Frequency**

No. (Hex.)	Name	Description	Default (Range)
C5-07 (0221)	ASR Gain Switchover Frequency	<input type="checkbox"/> V/f <input type="checkbox"/> OLV/PM <input checked="" type="checkbox"/> EZOLV Sets the frequency where the drive will switch between these parameters: <i>C5-01</i> and <i>C5-03</i> [ <i>ASR Proportional Gain 1/2</i> ] <i>C5-02</i> and <i>C5-04</i> [ <i>ASR Integral Time 1/2</i> ]	Determined by A1-02 (Determined by A1-02)

Switching the proportional gain and integral time in the low or high speed range can help operation become stable. A good switching point is 80% of the frequency where oscillation occurs or at 80% of the maximum output frequency.

**Note:**

An MFDI set for *H1-xx = 77* [*MFDI Function Selection = ASR Gain (C5-03) Select*] will have priority over the ASR gain switching frequency.

## ■ C5-08: ASR Integral Limit

No. (Hex.)	Name	Description	Default (Range)
C5-08 (0222)	ASR Integral Limit	V/f OLV/PM EZOLV Set the upper limit of the ASR integral amount as a percentage of the rated load.	400% (0 - 400%)

## ◆ C6: Carrier Frequency

*C6 parameters* select the carrier frequency and set the upper and lower limits of carrier frequencies.

### ■ C6-02: Carrier Frequency Selection

No. (Hex.)	Name	Description	Default (Range)
C6-02 (0224)	Carrier Frequency Selection	V/f OLV/PM EZOLV Sets the carrier frequency for the transistors in the drive.	Determined by A1-02 and o2-04 (Determined by A1-02)

Changes to the switching frequency will decrease audible noise and decrease leakage current.

**Note:**

When you increase the carrier frequency to more than the default setting, it will automatically decrease the drive current rating.

**1 : 2.0 kHz**

**2 : 5.0 kHz**

**3 : 8.0 kHz**

**4 : 10.0 kHz**

**5 : 12.5 kHz**

**7 : Swing PWM1 (Audible Sound 1)**

**8 : Swing PWM2 (Audible Sound 2)**

**9 : Swing PWM3 (Audible Sound 3)**

**A : Swing PWM4 (Audible Sound 4)**

**B : Leakage Current Rejection PWM**

**F : User Defined (C6-03 to C6-05)**

Use *C6-03 to C6-05* to set detailed setting values.

**Note:**

- The carrier frequency for Swing PWM 1 to 4 is equivalent to 2.0 kHz. Swing PWM applies a special PWM pattern to decrease the audible noise.
- When *A1-02 = 5 or 8* [Control Method Selection = OLV/PM or EZOLV], you cannot set to 7 to A
- Setting *B* uses a PWM pattern that decreases the leakage current that the drive detects over long wiring distances. This can help decrease alarm detection and decrease problems with the current monitor from leakage current over long wiring distances.

**Table 12.35 Guidelines for Carrier Frequency Parameter Setup**

Symptom	Remedy
Speed and torque are not stable at low speed.	Decrease the carrier frequency.
Speed and torque are not stable at low speed.	Decrease the carrier frequency.
Too much leakage current from the drive.	Decrease the carrier frequency.
Wiring between the drive and motor is too long.	Decrease the carrier frequency. <b>Note:</b> If the motor cable is too long, it can be necessary to decrease the carrier frequency. Refer to <a href="#">Table 12.36</a> for the wiring distance and decrease the carrier frequency.
Audible motor noise is too loud.	Increase the carrier frequency. Use Swing PWM. <b>Note:</b> The default carrier frequency is Swing PWM 1 ( <i>C6-02 = 7</i> ), with a 2 kHz base. You can increase the carrier frequency, but this will also decrease the drive rated current.

**Table 12.36 Wiring Distance**

Wiring Distance	50 m (164 ft) Maximum	100 m (328 ft) Maximum	More than 100 m (328 ft)
C6-02 [Carrier Frequency Selection]	1 to F (12.5 kHz maximum)	1 to 2 (5 kHz maximum), 7	1 (2 kHz maximum), 7

**Note:**

- When  $A1-02 = 5$  [Control Method Selection = OLV/PM], the maximum cable length is 100 m (328 ft).
- When the wiring length for drive models 4005 and 4008 is more than 10 m, you must decrease the carrier frequency or output current.

■ **C6-03: Carrier Frequency Upper Limit**

No. (Hex.)	Name	Description	Default (Range)
C6-03 (0225)	Carrier Frequency Upper Limit	<div style="display: flex; gap: 5px;"> <span>V/f</span> <span>OLV/PM</span> <span>EZOLV</span> </div> Sets the upper limit of the carrier frequency. Set $C6-02 = F$ [Carrier Frequency Selection = User Defined (C6-03 to C6-05)] to set this parameter.	Determined by C6-02 (1.0 - 12.5 kHz)

**Setting a Fixed User-Defined Carrier Frequency**

When you cannot use  $C6-02$  to set a carrier frequency between set selectable values, you can set the value in  $C6-03$ . The carrier frequency will be fixed to the value set to  $C6-03$ .

When  $A1-02 = 0$  [Control Method Selection = V/f], set  $C6-03 = C6-04$  [Carrier Frequency Lower Limit] to fix the carrier frequency.

**Setting a Variable Carrier Frequency to Agree with the Output Frequency**

When  $A1-02 = 0$ , set  $C6-03$ ,  $C6-04$ , and  $C6-05$  [Carrier Freq Proportional Gain] as shown in Figure 12.37 to make the carrier frequency change linearly with the output frequency.

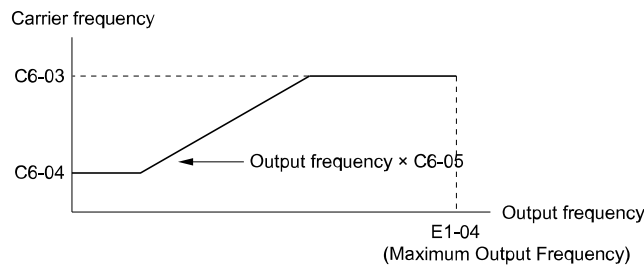

**C6-03: Carrier Frequency Upper Limit**  
**C6-04: Carrier Frequency Lower Limit**

**C6-05: Carrier Freq Proportional Gain**  
**E1-04: Maximum Output Frequency**

**Figure 12.37 Setting a Variable Carrier Frequency to Agree with the Output Frequency**

**Note:**

- When  $C6-05 \leq 7$ , the drive disables  $C6-04$ . The carrier frequency is fixed to the value set to  $C6-03$ .
- If these conditions are true at the same time, the drive will detect *oPE11* [Carrier Frequency Setting Error]:
  - $C6-05 \geq 6$
  - $C6-04 \geq C6-03$
- When  $A1-02 = 0, 5, 8$  [Control Method Selection = V/f, OLV/PM, EZOLV], in the area where the output frequency is more than  $C6-03$  and  $C6-12$ , the carrier frequency = output frequency  $\times$  12, and it will change with the output frequency.

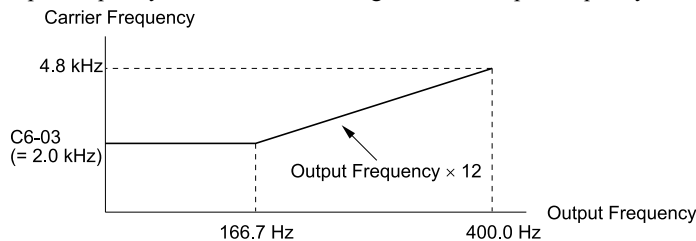

**Figure 12.38 Carrier Frequency when C6-03 = 2.0 kHz, E1-04 = 400.0 Hz**



### ■ C6-04: Carrier Frequency Lower Limit

No. (Hex.)	Name	Description	Default (Range)
C6-04 (0226)	Carrier Frequency Lower Limit	<div style="display: flex; gap: 5px;"> <span style="background-color: #333; color: white; padding: 2px;">V/f</span> <span style="border: 1px solid #ccc; border-radius: 3px; padding: 2px;">OLV/PM</span> <span style="border: 1px solid #ccc; border-radius: 3px; padding: 2px;">EZOLV</span> </div> Sets the lower limit of the carrier frequency. Set $C6-02 = F$ [Carrier Frequency Selection = User Defined (C6-03 to C6-05)] to set this parameter.	Determined by C6-02 (1.0 - 12.5 kHz)

Set  $C6-03$  [Carrier Frequency Upper Limit],  $C6-04$ , and  $C6-05$  [Carrier Freq Proportional Gain] to make the carrier frequency change linearly with the output frequency.

**Note:**

If these conditions are true at the same time, the drive will detect  $oPE11$  [Carrier Frequency Setting Error]:

- $C6-04 \geq C6-03$
- $C6-05 \geq 6$

### ■ C6-05: Carrier Freq Proportional Gain

No. (Hex.)	Name	Description	Default (Range)
C6-05 (0227)	Carrier Freq Proportional Gain	<div style="display: flex; gap: 5px;"> <span style="background-color: #333; color: white; padding: 2px;">V/f</span> <span style="border: 1px solid #ccc; border-radius: 3px; padding: 2px;">OLV/PM</span> <span style="border: 1px solid #ccc; border-radius: 3px; padding: 2px;">EZOLV</span> </div> Sets the proportional gain for the carrier frequency. Set $C6-02 = F$ [Carrier Frequency Selection = User Defined (C6-03 to C6-05)] to set this parameter.	Determined by C6-02 (0 - 99)

Set  $C6-03$  [Carrier Frequency Upper Limit],  $C6-04$  [Carrier Frequency Lower Limit], and  $C6-05$  to make the carrier frequency change linearly with the output frequency.

## 12.5 d: References

$d$  parameters [References] set the frequency reference input method and dead band range. They also set the field weakening function.

**WARNING! Sudden Movement Hazard.** Use fast stop circuits to safely and quickly stop the drive. After you wire the fast stop circuits, you must check their operation. Test the operation of the fast stop function before you use the drive. If you do not test the fast stop circuit before you operate the drive, it can cause serious injury or death.

### ◆ d1: Frequency Reference

Figure 12.39 shows the frequency reference input method, command source selection method and priority descriptions.

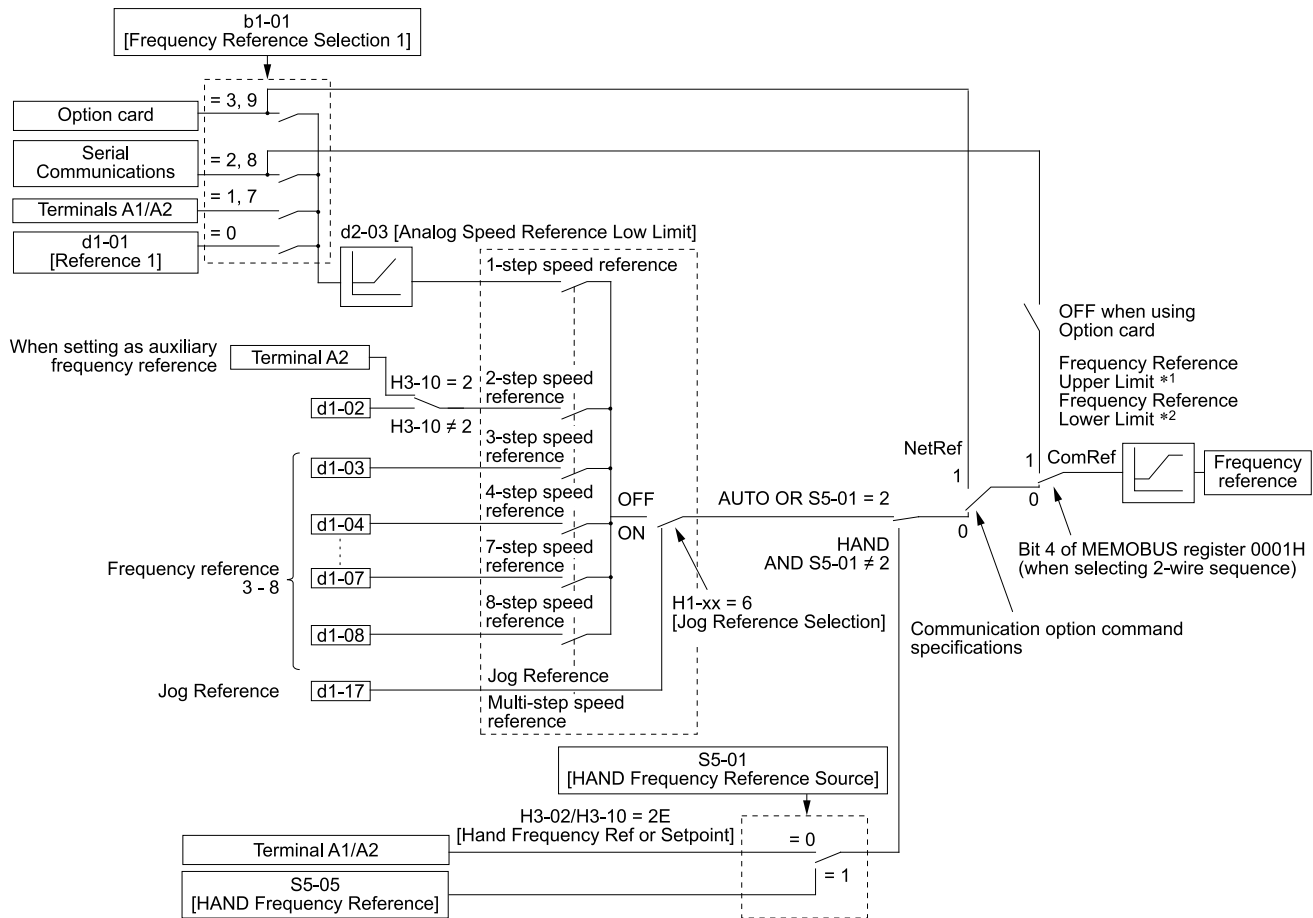

Figure 12.39 Frequency Reference Setting Hierarchy

- \*1 The drive uses the smallest value of Y1-40 [Maximum Speed], E1-04 [Maximum Output Frequency], or d2-01 [Frequency Reference Upper Limit] for Frequency Reference Upper Limit. When the drive is in Emergency Override Mode, it uses the smallest value of Y1-40, E1-04, d2-01, or S6-10 [Emergency Override Max Speed].
- \*2 The drive uses the largest value of Y1-06 [Minimum Speed], Y4-12 [Thrust Frequency], or d2-02 [Frequency Reference Lower Limit] for Frequency Reference Lower Limit. When the drive is in Emergency Override Mode, it uses the largest value of Y1-06, Y4-12, d2-02, or S6-09 [Emergency Override Min Speed].

### ■ Multi-Step Speed Operation

The drive has a multi-step speed operation function that can set many frequency references in advance. Set frequency references in  $d1-xx$  parameters. You can select the set frequency references with MFDI signals from an external source. Activate and deactivate the digital input to select the frequency reference to change the motor speed in steps. You can use the 8-step frequency reference and one Jog Frequency Reference (JOG command) to switch the speed to the maximum 9-step speeds.

**Note:**

- The Jog Frequency Reference (JOG command) overrides all other frequency references.
- You can use the MFDI to switch the frequency reference when the motor is running. The drive will apply the enabled acceleration and deceleration times.
- The default settings for Multi-Step Speed Reference 1 (master frequency reference) and Multi-Step Speed Reference 2 (auxiliary frequency reference) are the analog frequency reference.  
Also, voltage command input terminal A1 and current input terminal A2 for Multi-Step Speed Reference 1 (master frequency reference) are added internally by default. The drive uses Multi-Step Speed Reference 1 when the signal is connected to an analog input terminal.

## ■ Setting Procedures for Multi-step Speed Operation

### Use an Analog Input as Reference 1 and 2

This section gives information about the procedures to set these examples:

- Multi-Step Speed 6 (6 types of frequency references)
- When you set the voltage input of analog inputs from terminals A1 and A2 to 0 V to 10 V (Lower Limit at 0)

Procedure	Configuration Parameter	Task Contents
1	Reference 1	<ol style="list-style-type: none"> <li>1. Set <math>b1-01 = 1</math> [Frequency Reference Selection 1 = Analog Input].</li> <li>2. Set <math>H3-02 = 0</math> [Terminal A1 Function Selection = Frequency Reference].</li> <li>3. Set <math>H3-01 = 0</math> [Terminal A1 Signal Level Select = 0 to 10 V (Lower Limit at 0)].</li> </ol>
2	Reference 2	<ol style="list-style-type: none"> <li>1. Set <math>H3-10 = 2</math> [Terminal A2 Function Selection = Auxiliary Frequency Reference 1].</li> <li>2. Set <math>H3-09 = 0</math> [Terminal A2 Signal Level Select = 0 to 10 V (Lower Limit at 0)].</li> </ol>
3	Signal type of analog input	Set Jumper switch S1 on the control circuit board to the V-side (voltage) to set terminal A2 for voltage input. <b>Note:</b> Set this before you energize the drive.
4	Reference 3	Set the value of $d1-03$ [Reference 3].
5	Reference 4	Set the value of $d1-04$ [Reference 4].
6	Reference 5	Set the value of $d1-05$ [Reference 5].
7	Jog Reference	Set $d1-17$ [Jog Reference] to the jog speed.
8	External digital input (3 inputs)	Set the Multi-Step Speed Reference 1 to 3 [ $H1-xx = 3, 4, 5$ ] to one of the MFDI terminals S1 to S7.
9	JOG command	Set the Jog Reference Selection [ $H1-xx = 6$ ] to one of the MFDI terminals S1 to S7.

### Use the Maximum 9-Step Speed with All Digital Inputs

This section is the procedure to set the 9-step speeds (9 types of frequency references) without an analog input.

Procedure	Configuration Parameter	Task Contents
1	Reference 1	<ol style="list-style-type: none"> <li>1. Set <math>b1-01 = 0</math> [Frequency Reference Selection 1 = Keypad].</li> <li>2. Set the value of <math>d1-01</math> [Reference 1].</li> </ol>
2	Reference 2	Set the value of $d1-02$ [Reference 2].
3	Reference 3	<ol style="list-style-type: none"> <li>1. Set <math>H3-10 = F</math> [Terminal A2 Function Selection = Not Used], and disables the analog reference.</li> <li>2. Set the value of <math>d1-03</math> [Reference 3].</li> </ol>
4	Reference 4 to 8	Set the values of $d1-04$ to $d1-08$ [Reference 4 to 8].
5	Jog Reference	Set $d1-17$ [Jog Reference] to the jog speed.
6	External digital input (3 inputs)	Set Multi-Step Speed Reference 1 to 3 [ $H1-xx = 3, 4, 5$ ] to one of the MFDI terminals S1 to S7.
7	JOG command	Set the Jog Reference Selection [ $H1-xx = 6$ ] to one of the MFDI terminals S1 to S7.

### Multi-step Speed Operation Combinations

Refer to [Table 12.37](#) and [Figure 12.40](#) for information about multi-step speed reference combinations. The selected frequency reference changes when the combination of digital input signals from an external source changes.

**Table 12.37 Multi-step Speed Reference and MFDI Terminal Combinations**

Related Parameters	Multi-Step Speed Reference 1 H1-xx = 3	Multi-Step Speed Reference 2 H1-xx = 4	Multi-Step Speed Reference 3 H1-xx = 5	Jog Reference H1-xx = 6
Reference 1 (set in b1-01)	OFF	OFF	OFF	OFF
Reference 2 (d1-02 or terminals A1, A2)	ON	OFF	OFF	OFF
Reference 3 (d1-03 or terminals A1, A2)	OFF	ON	OFF	OFF
Reference 4 (d1-04)	ON	ON	OFF	OFF
Reference 5 (d1-05)	OFF	OFF	ON	OFF
Reference 6 (d1-06)	ON	OFF	ON	OFF
Reference 7 (d1-07)	OFF	ON	ON	OFF
Reference 8 (d1-08)	ON	ON	ON	OFF
Jog Reference (d1-17) *1	-	-	-	ON

\*1 The Jog Frequency Reference (JOG command) overrides all other frequency references.

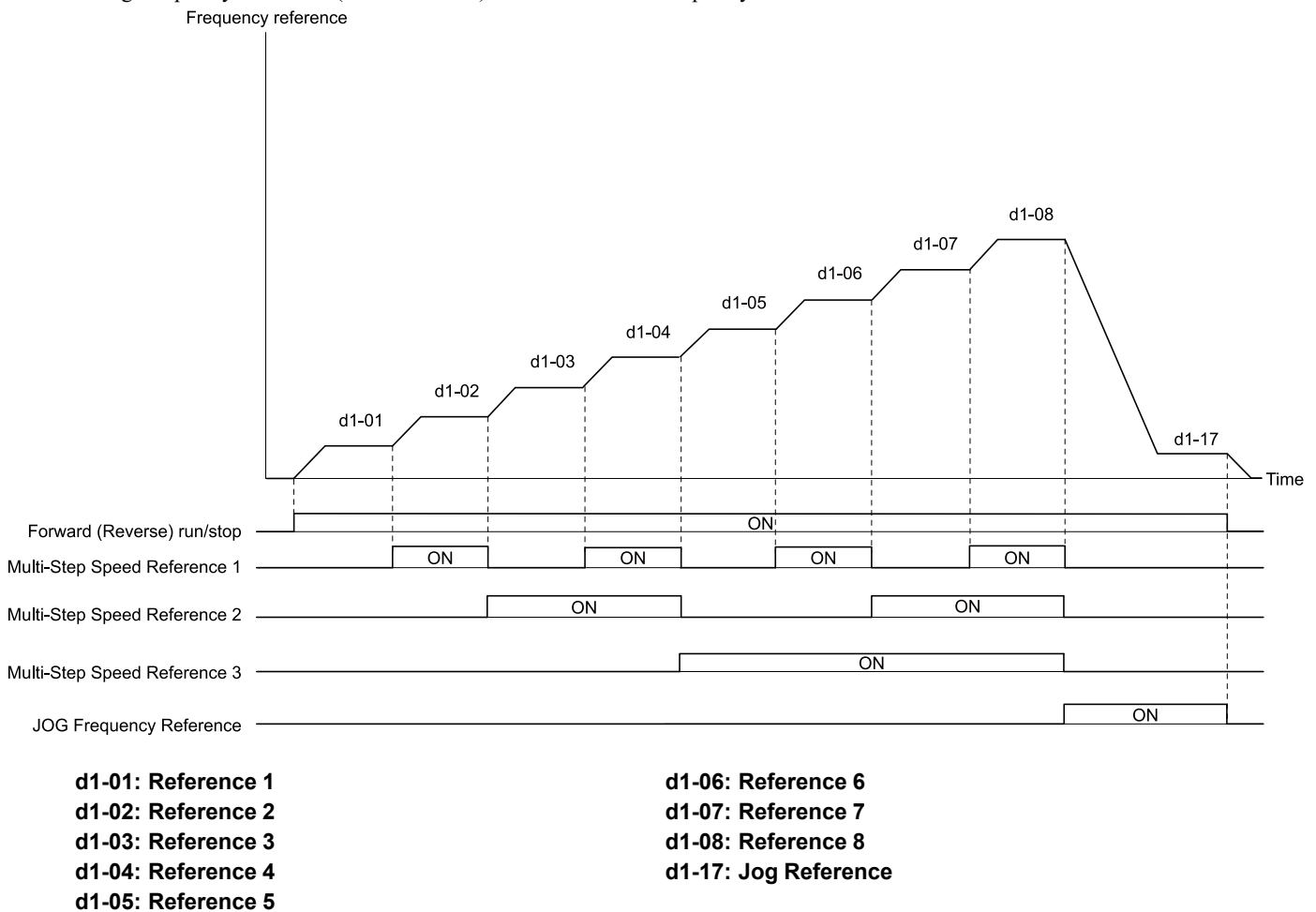

**Figure 12.40 Time Chart for Multi-step Speed Reference/JOG Reference**

■ **d1-01: Reference 1**

No. (Hex.)	Name	Description	Default (Range)
d1-01 (0280) RUN	Reference 1	<b>V/f</b> <b>OLV/PM</b> <b>EZOLV</b> Sets the frequency reference in the units from o1-03 [Frequency Display Unit Selection].	0.00 Hz (0.00 - 400.00 Hz)

**Note:**

- The upper limit value changes when the *E1-04 [Maximum Output Frequency]* and *d2-01 [Frequency Reference Upper Limit]* values change. Calculate the upper limit value with this formula:  
Upper limit value =  $(E1-04) \times (d2-01) / 100$
- To set *d1-01* to 1-step speed parameter in a multi-step speed operation, set *b1-01* = 0 [*Frequency Reference Selection 1 = Keypad*].

**d1-02: Reference 2**

No. (Hex.)	Name	Description	Default (Range)
d1-02 (0281) RUN	Reference 2	<b>V/f</b> <b>OLV/PM</b> <b>EZOLV</b> Sets the frequency reference in the units from <i>o1-03 [Frequency Display Unit Selection]</i> .	0.00 Hz (0.00 - 400.00 Hz)

**Note:**

- The upper limit value changes when the *E1-04 [Maximum Output Frequency]* and *d2-01 [Frequency Reference Upper Limit]* values change.
- To set *d1-02* to Multi-Step Speed 2, set *H3-02* and *H3-10* ≠ 2 [*MFAI Function Select ≠ Auxiliary Frequency Reference 1*].

**d1-03: Reference 3**

No. (Hex.)	Name	Description	Default (Range)
d1-03 (0282) RUN	Reference 3	<b>V/f</b> <b>OLV/PM</b> <b>EZOLV</b> Sets the frequency reference in the units from <i>o1-03 [Frequency Display Unit Selection]</i> .	0.00 Hz (0.00 - 400.00 Hz)

**Note:**

- The upper limit value changes when the *E1-04 [Maximum Output Frequency]* and *d2-01 [Frequency Reference Upper Limit]* values change.
- To set *d1-03* to Multi-Step Speed 3, set *H3-02* and *H3-10* ≠ 3 [*MFAI Function Select ≠ Auxiliary Frequency Reference 2*].

**d1-04: Reference 4**

No. (Hex.)	Name	Description	Default (Range)
d1-04 (0283) RUN	Reference 4	<b>V/f</b> <b>OLV/PM</b> <b>EZOLV</b> Sets the frequency reference in the units from <i>o1-03 [Frequency Display Unit Selection]</i> .	0.00 Hz (0.00 - 400.00 Hz)

**Note:**

- The upper limit value changes when the *E1-04 [Maximum Output Frequency]* and *d2-01 [Frequency Reference Upper Limit]* values change.
- This parameter sets the frequency reference of Multi-Step Speed 4.

**d1-05: Reference 5**

No. (Hex.)	Name	Description	Default (Range)
d1-05 (0284) RUN	Reference 5	<b>V/f</b> <b>OLV/PM</b> <b>EZOLV</b> Sets the frequency reference in the units from <i>o1-03 [Frequency Display Unit Selection]</i> .	0.00 Hz (0.00 - 400.00 Hz)

**Note:**

- The upper limit value changes when the *E1-04 [Maximum Output Frequency]* and *d2-01 [Frequency Reference Upper Limit]* values change.
- This parameter sets the frequency reference of Multi-Step Speed 5.



**d1-06: Reference 6**

No. (Hex.)	Name	Description	Default (Range)
d1-06 (0285) RUN	Reference 6	<b>V/f</b> <b>OLV/PM</b> <b>EZOLV</b> Sets the frequency reference in the units from <i>o1-03 [Frequency Display Unit Selection]</i> .	0.00 Hz (0.00 - 400.00 Hz)

**Note:**

- The upper limit value changes when the *E1-04 [Maximum Output Frequency]* and *d2-01 [Frequency Reference Upper Limit]* values change.
- This parameter sets the frequency reference of Multi-Step Speed 6.



■ **d1-07: Reference 7**

No. (Hex.)	Name	Description	Default (Range)
d1-07 (0286) RUN	Reference 7	   Sets the frequency reference in the units from <i>o1-03 [Frequency Display Unit Selection]</i> .	0.00 Hz (0.00 - 400.00 Hz)

**Note:**

- The upper limit value changes when the *E1-04 [Maximum Output Frequency]* and *d2-01 [Frequency Reference Upper Limit]* values change.
- This parameter sets the frequency reference of Multi-Step Speed 7.



■ **d1-08: Reference 8**

No. (Hex.)	Name	Description	Default (Range)
d1-08 (0287) RUN	Reference 8	   Sets the frequency reference in the units from <i>o1-03 [Frequency Display Unit Selection]</i> .	0.00 Hz (0.00 - 400.00 Hz)

**Note:**

- The upper limit value changes when the *E1-04 [Maximum Output Frequency]* and *d2-01 [Frequency Reference Upper Limit]* values change.
- This parameter sets the frequency reference of Multi-Step Speed 8.

■ **d1-17: Jog Reference**

No. (Hex.)	Name	Description	Default (Range)
d1-17 (0292) RUN	Jog Reference	   Sets the Jog frequency reference in the units from <i>o1-03 [Frequency Display Unit Selection]</i> . Set <i>H1-xx = 6 [MFD1 Function Selection = Jog Reference Selection]</i> to use the Jog frequency reference.	6.00 Hz (0.00 - 400.00 Hz)

**Note:**

The upper limit value changes when the *E1-04 [Maximum Output Frequency]* and *d2-01 [Frequency Reference Upper Limit]* values change.

◆ **d2: Reference Limits**

*d2 parameters* set the upper and lower frequency limits to control the motor speed. Apply these parameters to for example, run the motor at low-speed due to mechanical strength concerns, or if the motor should not be run at low speed because of lubrication issues with the gears and bearings.

The upper frequency limit is set in *d2-01 [Frequency Reference Upper Limit]* and the lower limit is set in *d2-02 [Frequency Reference Lower Limit]*.

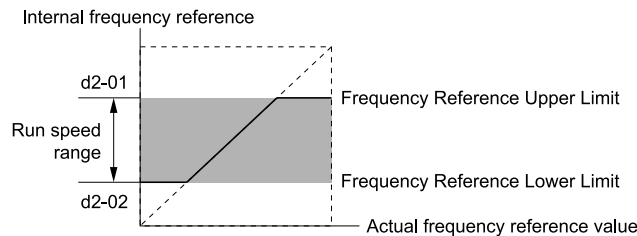

Figure 12.41 Upper and Lower Frequency Limits

### ■ d2-01: Frequency Reference Upper Limit

No. (Hex.)	Name	Description	Default (Range)
d2-01 (0289)	Frequency Reference Upper Limit	<b>V/f</b> <b>OLV/PM</b> <b>EZOLV</b> Sets maximum limit for all frequency references. The maximum output frequency is 100%.	100.0% (0.0 - 110.0%)

When the frequency reference is more than the value set in *d2-01* the drive will continue to operate at the value set in *d2-01*.

### ■ d2-02: Frequency Reference Lower Limit

No. (Hex.)	Name	Description	Default (Range)
d2-02 (028A)	Frequency Reference Lower Limit	<b>V/f</b> <b>OLV/PM</b> <b>EZOLV</b> Sets minimum limit for all frequency references. The maximum output frequency is 100%.	0.0% (0.0 - 110.0%)

When the frequency reference is less than the value set in *d2-02*, the drive will continue to operate at the value set in *d2-02*. The motor will accelerate to the *d2-02* value after the drive receives a Run command and a lower frequency reference than *d2-02* has been entered.

### ■ d2-03: Analog Frequency Ref Lower Limit

No. (Hex.)	Name	Description	Default (Range)
d2-03 (0293)	Analog Frequency Ref Lower Limit	<b>V/f</b> <b>OLV/PM</b> <b>EZOLV</b> Sets the lower limit for the master frequency reference (the first frequency of the multi-step speed reference) as a percentage. The maximum output frequency is 100%.	0.0% (0.0 - 110.0%)

This parameter does not change the lower limit of Jog reference, frequency reference for multi-step speed operation, or the auxiliary frequency reference.

The drive operates at the value set in *d2-03* when the frequency reference decreases to less than the value set in *d2-03*.

**Note:**

When lower limits are set to parameters *d2-02* [*Frequency Reference Lower Limit*] and *d2-03*, the drive uses the larger value as the lower limit.

### ◆ d3: Jump Frequency

The Jump frequency is a function that sets the dead band to a specified frequency band. If a machine that operated at constant speed is operated with variable speed, it can make resonance. To operate the machine without resonance from the natural frequency of the machinery mechanical system, use a frequency band jump.

You can program the drive to have three different Jump frequencies. Sets *d3-01* [*Jump Frequency 1*] to *d3-03* [*Jump Frequency 3*] to the center value for the frequency to avoid and sets *d3-04* [*Jump Frequency Width*] to be 1/2 of the total band to avoid.

When you input a frequency reference that is the same as or near the Jump frequency width, the frequency reference changes automatically.

The drive accelerates or decelerates the motor smoothly until the frequency reference is not in the range of the Jump frequency band. The drive will use the active accel/decel time to go through the specified dead band range. If the frequency reference is not in the range of the Jump frequency band, switch to constant speed operation.

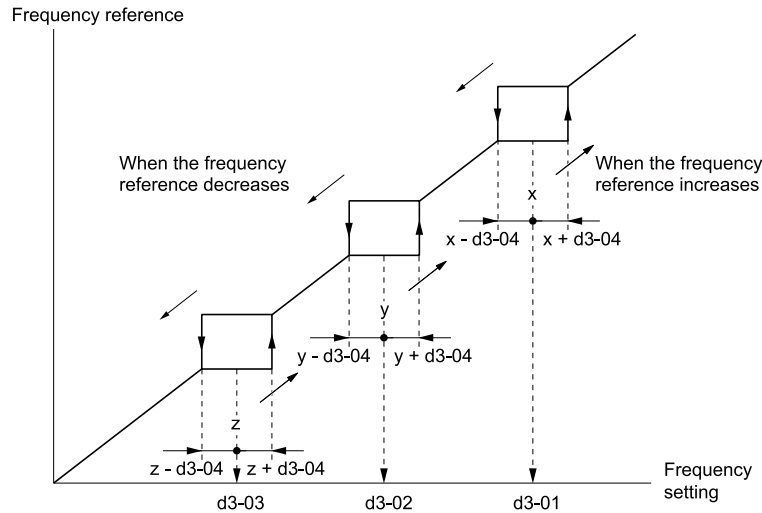

Figure 12.42 Jump Frequency

**Note:**

- When you set Jump Frequencies 1 to 3, make sure that the parameters do not overlap. The drive will not indicate this condition.
- When the drive is in the range of the Jump frequency, the frequency reference changes automatically. When the drive jumps frequencies, the output frequency changes smoothly as specified by the values set in C1-01 [Acceleration Time 1] and C1-02 [Deceleration Time 1].

■ **d3-01: Jump Frequency 1**

No. (Hex.)	Name	Description	Default (Range)
d3-01 (0294)	Jump Frequency 1	<b>V/f</b> <b>OLV/IPM</b> <b>EZOLV</b> Sets the median value of the frequency band that the drive will avoid.	0.0 Hz (0.0 - 400.0 Hz)

**Note:**

Set this parameter to 0.0 Hz to disable the Jump frequency.

■ **d3-02: Jump Frequency 2**

No. (Hex.)	Name	Description	Default (Range)
d3-02 (0295)	Jump Frequency 2	<b>V/f</b> <b>OLV/IPM</b> <b>EZOLV</b> Sets the median value of the frequency band that the drive will avoid.	0.0 Hz (0.0 - 400.0 Hz)

**Note:**

Set this parameter to 0.0 Hz to disable the Jump frequency.

■ **d3-03: Jump Frequency 3**

No. (Hex.)	Name	Description	Default (Range)
d3-03 (0296)	Jump Frequency 3	<b>V/f</b> <b>OLV/IPM</b> <b>EZOLV</b> Sets the median value of the frequency band that the drive will avoid.	0.0 Hz (0.0 - 400.0 Hz)

**Note:**

Set this parameter to 0.0 Hz to disable the Jump frequency.

■ **d3-04: Jump Frequency Width**

No. (Hex.)	Name	Description	Default (Range)
d3-04 (0297)	Jump Frequency Width	<b>V/f</b> <b>OLV/IPM</b> <b>EZOLV</b> Sets the width of the frequency band that the drive will avoid.	1.0 Hz (Determined by A1-02)



## ◆ d4: Frequency Ref Up/Down & Hold

The *d4* parameters set the Frequency Reference Hold function and Up/Down commands.

- Frequency Reference Hold Function Command: This acceleration/deceleration ramp hold command uses an MFDI to momentarily stop the acceleration/deceleration of the motor, and continues to operate the motor at the output frequency at which the command reference was input. Turn OFF the acceleration/deceleration ramp hold command to continue acceleration/deceleration.
- Up/Down command: The Up/Down command is a function to activate and deactivate an MFDI to increase and decrease the frequency reference. The Up/Down command overrides frequency references from the analog input terminal and keypad.

### ■ d4-01: Freq Reference Hold Selection

No. (Hex.)	Name	Description	Default (Range)
d4-01 (0298)	Freq Reference Hold Selection	<b>V/f</b> <b>OLV/PM</b> <b>EZOLV</b> Sets the function that saves the frequency reference after a Stop command or when de-energizing the drive.	0 (0, 1)

Set *H1-xx* [MFDI Function Selection] to one of these values to enable this parameter:

- *A* [Accel/Decel Ramp Hold]
- *10/11* [Up/Down Command]

#### 0 : Disabled

- Acceleration/Deceleration Ramp Hold  
When you enter a Stop command or de-energize the drive, the hold value is reset to 0 Hz. The drive will use the active frequency reference when it restarts.
- Up/Down Command  
When you enter a Stop command or de-energize the drive, the frequency reference value is reset to 0 Hz. The drive will start from 0 Hz when it restarts.

#### 1 : Enabled

- Acceleration/Deceleration Ramp Hold  
When you clear the Run command or de-energize the drive, it will save the last hold value. The drive will use the saved value as the frequency reference when it restarts.

#### Note:

When you energize the drive, continuously enable the MFDI terminal set for *Accel/Decel Ramp Hold* [*H1-xx = A*]. If the digital input does not activate, the drive will clear the hold value and set it to 0 Hz.

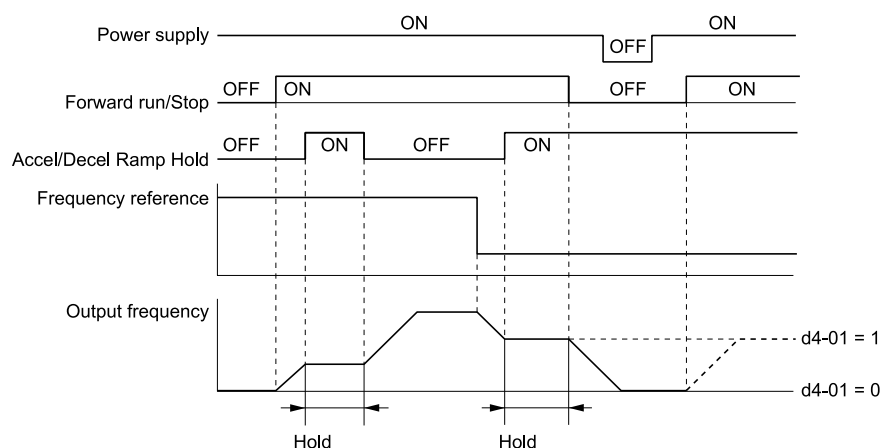

Figure 12.43 Frequency Reference Hold with Accel/Decel Hold Function

- Up/Down Command  
When you clear the Run command or de-energize the drive, it will save the frequency reference value. The drive will use the saved value as the frequency reference when it restarts.

### Remove the Saved Frequency Reference Value

The procedure to remove the saved frequency reference value is different for different functions. Use these methods to remove the value:

- Release the input programmed for *Accel/Decel Ramp Hold* [ $H1-xx = A$ ].
- Set an Up or Down command while no Run command is active.

### ■ d4-10: Up/Down Freq Lower Limit Select

No. (Hex.)	Name	Description	Default (Range)
d4-10 (02B6)	Up/Down Freq Lower Limit Select	<input type="checkbox"/> V/f <input type="checkbox"/> OLV/PM <input type="checkbox"/> EZOLV Sets the lower frequency limit for the Up/Down function.	0 (0, 1)

### 0 : Greater of d2-02 or Analog

The higher value between  $d2-02$  [*Frequency Reference Lower Limit*] and an analog input programmed for *Frequency Reference* [ $H3-02, H3-10 = 0$ ] sets the lower frequency reference limit.

#### Note:

When you use *External Reference 1/2 Selection* [ $H1-xx = 2$ ] to switch between the Up/Down function and an analog input as the reference source, the analog value becomes the lower reference limit when the Up/Down command is active. Set  $d4-10 = 1$  to isolate the Up/Down function and the analog input value.

### 1 : d2-02

You can only use  $d2-02$  to set the lower limit of the frequency reference.

## ◆ d6: Field Weakening

$d6$  parameters set the field weakening function.

The field weakening function decreases the energy consumption of the motor. It decreases the output voltage of the drive to a set level. The function decreases the motor excitation current inversely proportional to speed in a constant output range, and does not let the induced voltage of the motor become more than the power supply voltage. To enable this function, set *Field Weakening* [ $H1-xx = 63$ ] ON.

#### Note:

Use the Field Weakening function in constant light-load applications. To control the energy consumption of the motor for other load conditions, use the  $b8$  parameters [*Energy Saving*].

### ■ d6-01: Field Weakening Level

No. (Hex.)	Name	Description	Default (Range)
d6-01 (02A0)	Field Weakening Level	<input type="checkbox"/> V/f <input type="checkbox"/> OLV/PM <input type="checkbox"/> EZOLV Sets the drive output voltage as a percentage of $E1-05$ [ <i>Maximum Output Voltage</i> ] when $H1-xx = 63$ [ <i>Field Weakening</i> ] is activated.	80% (0 - 100%)

### ■ d6-02: Field Weakening Frequency Limit

No. (Hex.)	Name	Description	Default (Range)
d6-02 (02A1)	Field Weakening Frequency Limit	<input type="checkbox"/> V/f <input type="checkbox"/> OLV/PM <input type="checkbox"/> EZOLV Sets the minimum output frequency to start field weakening.	0.0 Hz (0.0 - 400.0 Hz)

To enable the Field Weakening command, make sure that these two conditions are true:

- The output frequency  $\geq d6-02$ .
- There is a speed agreement status.

## ◆ d7: Offset Frequency

The drive will use 3 digital signal inputs to add or subtract the set frequency (offset frequency) to/from the frequency reference and correct the speed. The drive uses the terminal set in  $H1-xx = 44$  to  $46$  [*MFDI Function Selection = Add*

Offset Frequency 1 (d7-01) to Add Offset Frequency 3 (d7-03)] to set the offset frequency. When you close more than one input at the same time, the drive adds the selected offset values together.

Figure 12.44 shows the Offset frequency function:

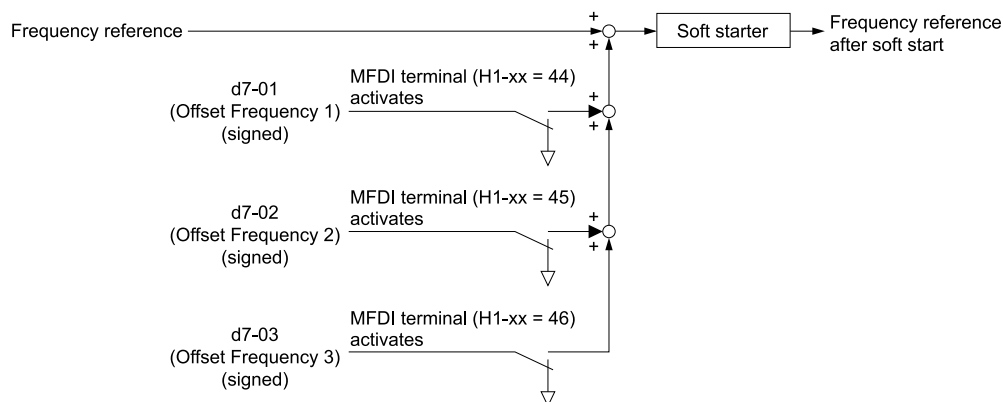

Figure 12.44 Offset Frequency Operation

### ■ d7-01: Offset Frequency 1

No. (Hex.)	Name	Description	Default (Range)
d7-01 (02B2) RUN	Offset Frequency 1	<b>V/f</b> <b>OLV/PM</b> <b>EZOLV</b> Uses $H1-xx = 44$ [MFDI Function Select = Add Offset Frequency 1 (d7-01)] as a percentage of the Maximum Output Frequency to add or subtract the set frequency to/from the frequency reference.	0.0% (-100.0 - +100.0%)

### ■ d7-02: Offset Frequency 2

No. (Hex.)	Name	Description	Default (Range)
d7-02 (02B3) RUN	Offset Frequency 2	<b>V/f</b> <b>OLV/PM</b> <b>EZOLV</b> Uses $H1-xx = 45$ [MFDI Function Select = Add Offset Frequency 2 (d7-02)] as a percentage of the Maximum Output Frequency to add or subtract the set frequency to/from the frequency reference.	0.0% (-100.0 - +100.0%)

### ■ d7-03: Offset Frequency 3

No. (Hex.)	Name	Description	Default (Range)
d7-03 (02B4) RUN	Offset Frequency 3	<b>V/f</b> <b>OLV/PM</b> <b>EZOLV</b> Uses $H1-xx = 46$ [MFDI Function Select = Add Offset Frequency 3 (d7-03)] as a percentage of the Maximum Output Frequency to add or subtract the set frequency to/from the frequency reference.	0.0% (-100.0 - +100.0%)

## 12.6 E: Motor Parameters

*E* parameters cover drive input voltage, V/f pattern, and motor parameters.

### ◆ E1: V/f Pattern for Motor 1

*E1* parameters set the drive input voltage and motor V/f characteristics. To switch drive operation from one motor to another motor, set the V/f characteristics for motor 1.

#### ■ V/f Pattern Settings

The drive uses a V/f pattern to adjust the output voltage relative to the frequency reference.

This product has been preconfigured with 15 voltage/frequency (V/f) patterns. Use *E1-03 [V/f Pattern Selection]* to select the V/f pattern that is appropriate for the application.

Additionally, one custom V/f pattern is available. Set *E1-03 = F [Custom]* and then manually set parameters *E1-04 to E1-10*.

**Table 12.38 Predefined V/f Patterns**

Setting Value	Specification	Characteristic	Application
0	Const Trq, 50Hz base, 50Hz max	Constant torque	For general purpose applications. This pattern is used when the load torque is constant without any rotation speed such as that used for linear conveyor systems.
1	Const Trq, 60Hz base, 60Hz max		
2	Const Trq, 50Hz base, 60Hz max		
3	Const Trq, 60Hz base, 72Hz max		
4	VT, 50Hz, 65% Vmid reduction	Derated torque characteristics	This pattern is used for torque loads proportional to 2 or 3 times the rotation speed, such as is the case with fans and pumps.
5	VT, 50Hz, 50% Vmid reduction		
6	VT, 60 Hz, 65% Vmid reduction		
7	VT, 60 Hz, 50% Vmid reduction		
8	High Trq, 50Hz, 25% Vmin boost	High starting torque	This pattern is used when strong torque is required during startup.
9	High Trq, 50Hz, 65% Vmin boost		
A	High Trq, 60Hz, 25% Vmin boost		
B	High Trq, 60Hz, 65% Vmin boost		
C	High Freq, 60Hz base, 90Hz max	Constant output	This pattern is used to rotate motors at greater than 60 Hz. Output voltage is constant when operating at greater than 60 Hz.
D	High Freq, 60Hz base, 120Hz max		
E	High Freq, 60Hz base, 180Hz max		
F	Custom	Derated torque characteristics	Enables a custom V/f pattern by changing <i>E1-04 to E1-13 [V/f Pattern for Motor 1]</i> . The default settings for <i>E1-04 to E1-13</i> are the same as <i>Setting Value 7 [VT, 60 Hz, 50% Vmid reduction]</i> .

**Note:**

When you manually set V/f patterns, note these items:

- To set linear V/f characteristics at frequencies lower than  $E1-06$  [Base Frequency], set  $E1-07 = E1-09$  [Mid Point A Frequency = Minimum Output Frequency]. In this application, the drive ignores  $E1-08$  [Mid Point A Voltage].
- Set the five frequencies as specified by these rules: Incorrect settings will cause  $oPE10$  [V/f Data Setting Error].  
 $E1-09 \leq E1-07 < E1-06 \leq E1-11 \leq E1-04$  [Minimum Output Frequency  $\leq$  Mid Point A Frequency  $<$  Base Frequency  $\leq$  Mid Point B Frequency  $\leq$  Maximum Output Frequency]
- Setting  $E1-11 = 0$  [Mid Point B Frequency = 0 Hz] disables  $E1-12$  [Mid Point B Voltage]. Ensure that the four frequencies are set according to the following rules;  
 $E1-09 \leq E1-07 < E1-06 \leq E1-04$
- When you use  $A1-03$  [Initialize Parameters] to initialize the drive, it will not reset  $E1-03$ .

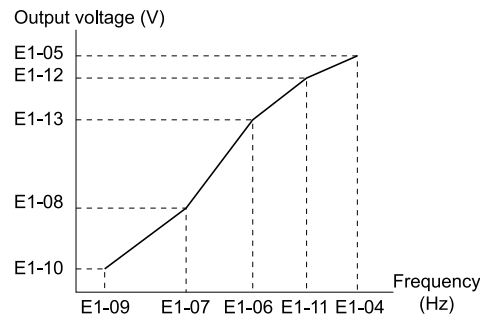

Figure 12.45 V/f Pattern

## ■ E1-01: Input AC Supply Voltage

No. (Hex.)	Name	Description	Default (Range)
E1-01 (0300)	Input AC Supply Voltage	<input checked="" type="radio"/> V/f <input type="radio"/> OLVP/M <input type="radio"/> EZOLV Sets the drive input voltage.	208 V Class: 240 V, 480 V Class: 480 V (208 V Class: 155 - 255 V, 480 V Class: 310 - 510 V)

**NOTICE: Damage to Equipment.** Set  $E1-01$  [Input AC Supply Voltage] to align with the drive input voltage (not motor voltage). If this parameter is incorrect, the protective functions of the drive will not operate correctly and it can cause damage to the drive.

### Values Related to the Drive Input Voltage

The value set in  $E1-01$  is the base value that the drive uses for the motor protective functions in Table 12.39. With a 480 V class drive, the detection level changes for some motor protective functions.

Table 12.39 Values Related to the Drive Input Voltage

Voltage	E1-01 Setting	Approximate Values			
		ov Detection Level	L2-05 [Undervoltage Detection Lvl (Uv1)]	L2-11 [KEB DC Bus Voltage Setpoint]	L3-17 [DC Bus Regulation Level]
208 V class	All settings	410 V	190 V	260 V	375 V
480 V class	Setting value $\geq$ 400 V	820 V	380 V	500 V	750 V
	Setting value $<$ 400 V	820 V	350 V	460 V	750 V

## ■ E1-03: V/f Pattern Selection

No. (Hex.)	Name	Description	Default (Range)
E1-03 (0302)	V/f Pattern Selection	<input checked="" type="radio"/> V/f <input type="radio"/> OLVP/M <input type="radio"/> EZOLV Sets the V/f pattern for the drive and motor. You can use one of the preset patterns or you can make a custom pattern.	F (Determined by $A1-02$ )

**Note:**

- Set the correct V/f pattern for the application and operation area. An incorrect V/f pattern can decrease motor torque and increase current from overexcitation.
- Parameter  $A1-03$  [Initialize Parameters] will not initialize the value of  $E1-03$ .

## 0 : Const Trq, 50Hz base, 50Hz max

## 12.6 E: Motor Parameters

Use this constant torque pattern for general applications. Use this pattern when the load torque is constant without any rotation speed, for example with linear conveyor systems.

**Note:**

The voltage values in the figures are for 208 V class drives. Multiply the values by 2 for 480 V class drives.

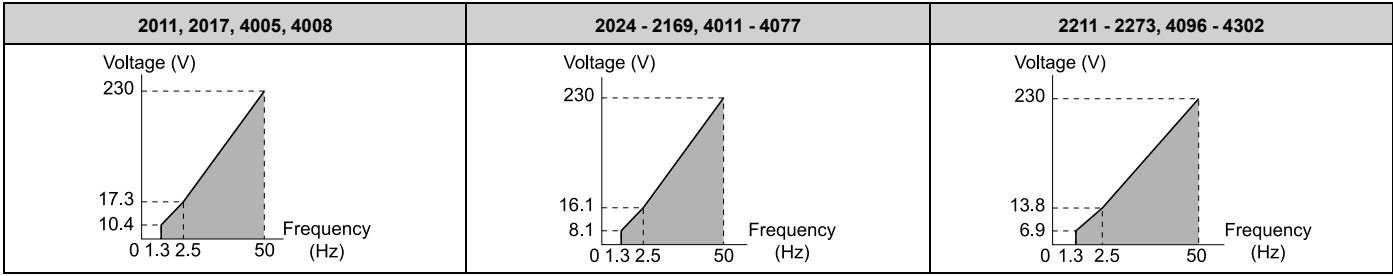

### 1 : Const Trq, 60Hz base, 60Hz max

Use this constant torque pattern for general applications. Use this pattern when the load torque is constant without any rotation speed, for example with linear conveyor systems.

**Note:**

The voltage values in the figures are for 208 V class drives. Multiply the values by 2 for 480 V class drives.

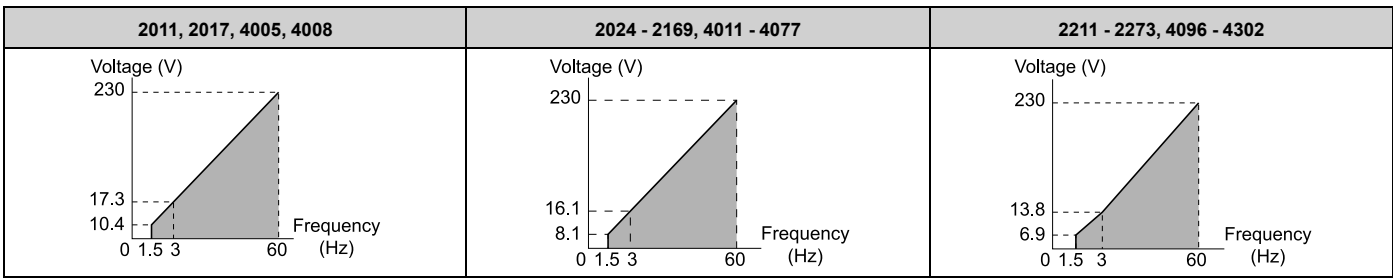

### 2 : Const Trq, 50Hz base, 60Hz max

Use this constant torque pattern for general applications. Use this pattern when the load torque is constant without any rotation speed, for example with linear conveyor systems.

**Note:**

The voltage values in the figures are for 208 V class drives. Multiply the values by 2 for 480 V class drives.

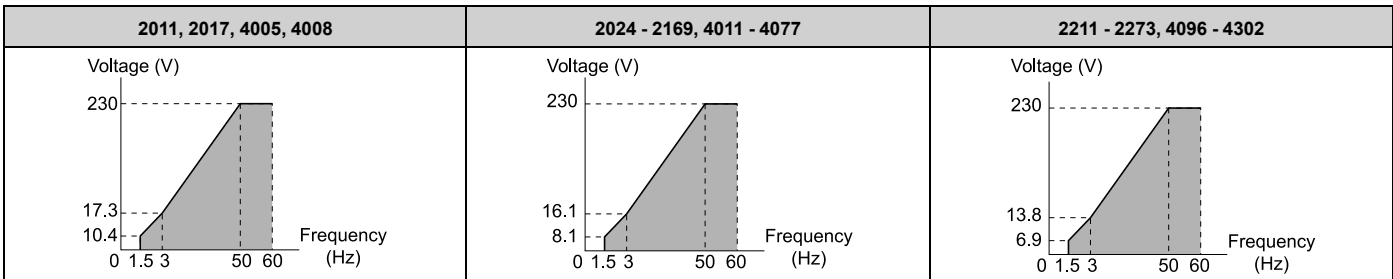

### 3 : Const Trq, 60 Hz base, 72 Hz max

Use this constant torque pattern for general applications. Use this pattern when the load torque is constant without any rotation speed, for example with linear conveyor systems.

**Note:**

The voltage values in the figures are for 208 V class drives. Multiply the values by 2 for 480 V class drives.

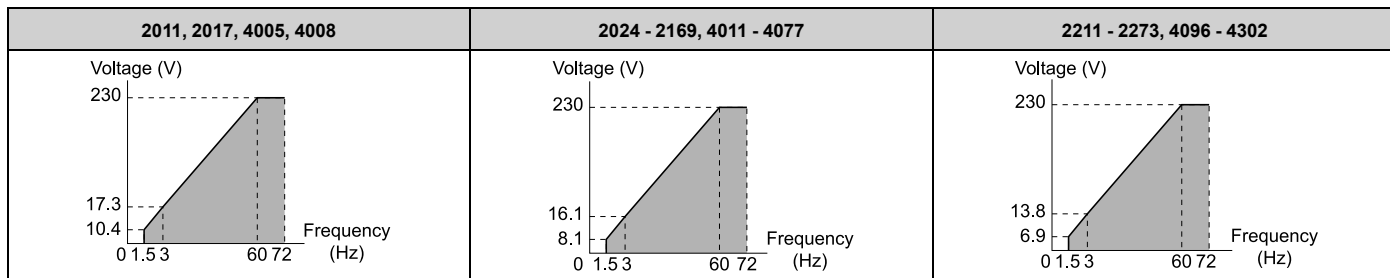

**4 : VT, 50Hz, 65% Vmid reduction**

Use this derated torque pattern for torque loads proportional to three times the rotation speed. For example, fans and pumps.

**Note:**

The voltage values in the figures are for 208 V class drives. Multiply the values by 2 for 480 V class drives.

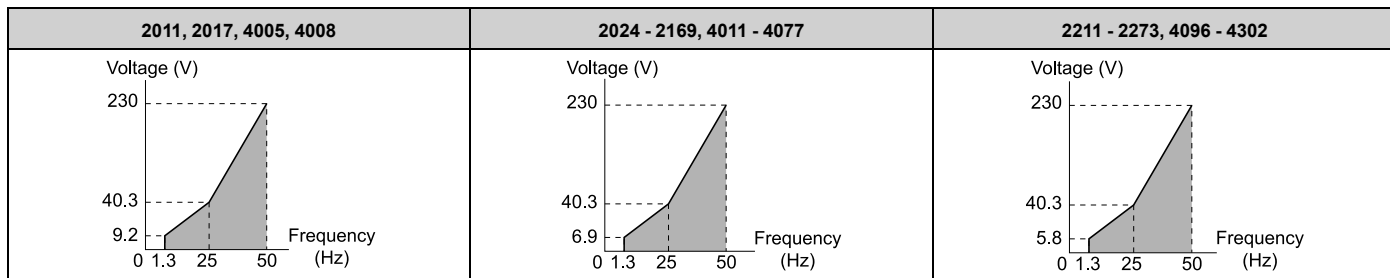

**5 : VT, 50Hz, 50% Vmid reduction**

Use this derated torque pattern for torque loads proportional to two times the rotation speed. For example, fans and pumps.

**Note:**

The voltage values in the figures are for 208 V class drives. Multiply the values by 2 for 480 V class drives.

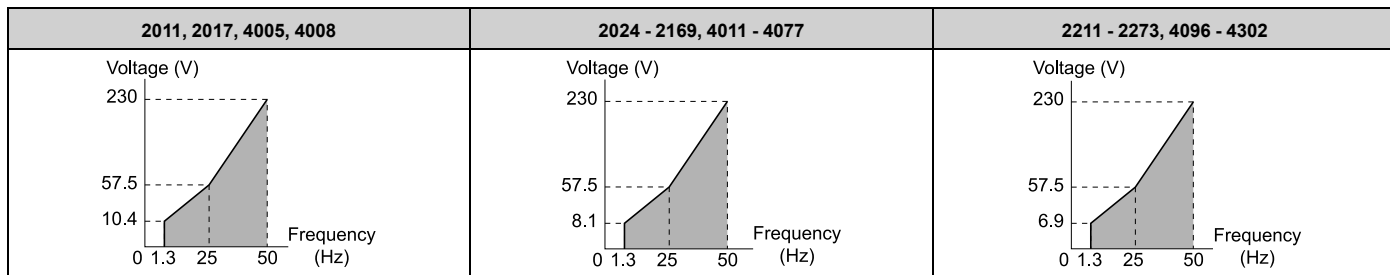

**6 : VT, 60 Hz, 65% Vmid reduction**

Use this derated torque pattern for torque loads proportional to three times the rotation speed. For example, fans and pumps.

**Note:**

The voltage values in the figures are for 208 V class drives. Multiply the values by 2 for 480 V class drives.

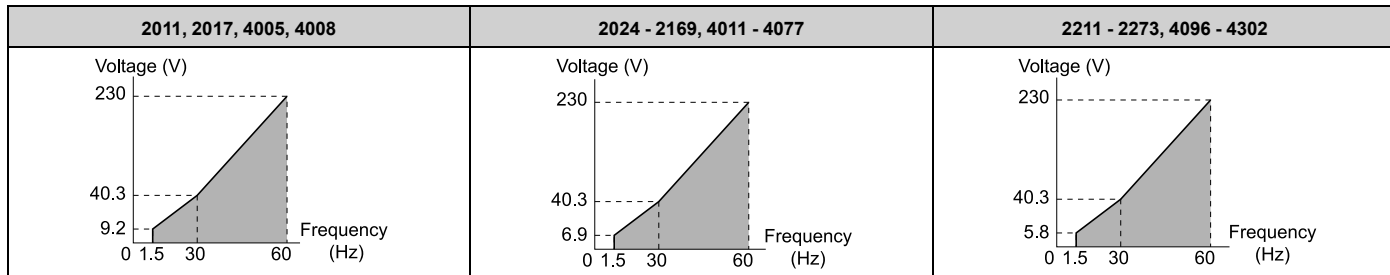

**7 : VT, 60Hz, 50% Vmid reduction**

## 12.6 E: Motor Parameters

Use this derated torque pattern for torque loads proportional to two times the rotation speed. For example, fans and pumps.

**Note:**

The voltage values in the figures are for 208 V class drives. Multiply the values by 2 for 480 V class drives.

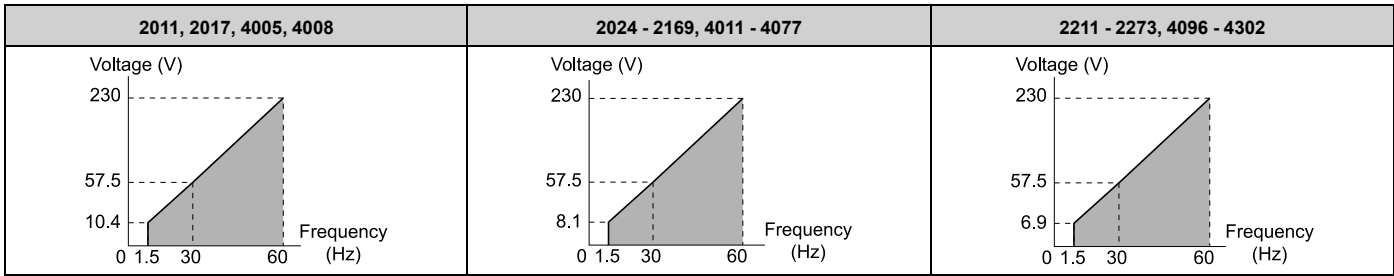

### 8 : High Trq, 50Hz, 25% Vmin boost

Use this pattern when moderate torque is necessary during start up.

Select this pattern only in these conditions:

- The wiring distance between the drive and motor is 150 m (492.1 ft) minimum.
- There is an AC reactor connected to the drive output.

**Note:**

The voltage values in the figures are for 208 V class drives. Multiply the values by 2 for 480 V class drives.

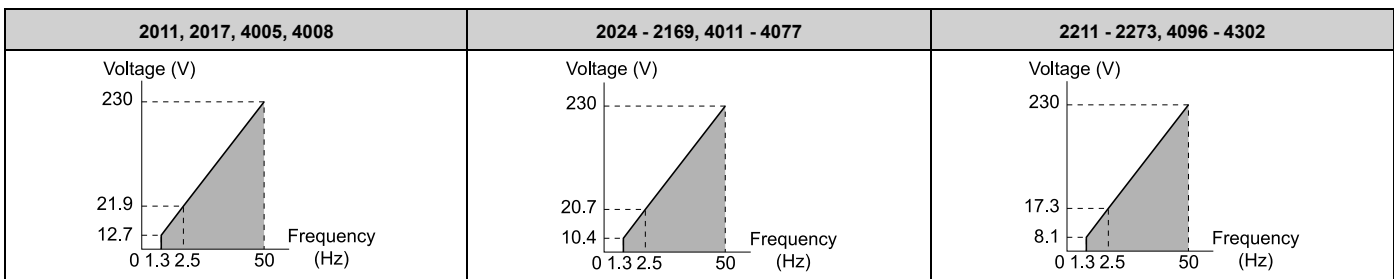

### 9 : High Trq, 50Hz, 65% Vmin boost

Use this pattern when high torque is necessary during start up.

Select this pattern only in these conditions:

- The wiring distance between the drive and motor is 150 m (492.1 ft) minimum.
- There is an AC reactor connected to the drive output.

**Note:**

The voltage values in the figures are for 208 V class drives. Multiply the values by 2 for 480 V class drives.

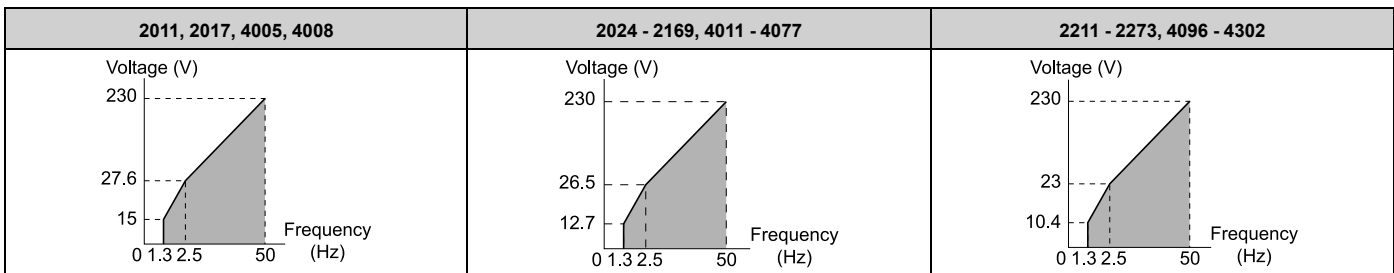

### A : High Trq, 60Hz, 25% Vmin boost

Use this pattern when moderate torque is necessary during start up.

Select this pattern only in these conditions:

- The wiring distance between the drive and motor is 150 m (492.1 ft) minimum.
- There is an AC reactor connected to the drive output.



**Note:**

The voltage values in the figures are for 208 V class drives. Multiply the values by 2 for 480 V class drives.

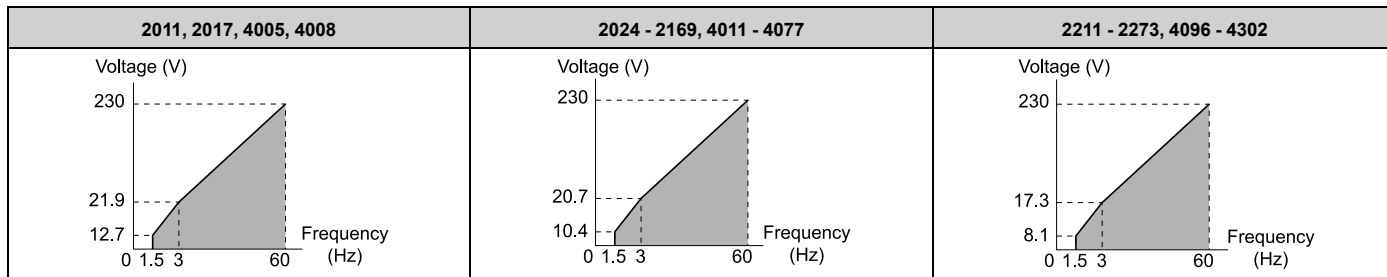

**B : High Trq, 60Hz, 65% Vmin boost**

Use this pattern when high torque is necessary during start up.

Select this pattern only in these conditions:

- The wiring distance between the drive and motor is 150 m (492.1 ft) minimum.
- There is an AC reactor connected to the drive output.

**Note:**

The voltage values in the figures are for 208 V class drives. Multiply the values by 2 for 480 V class drives.

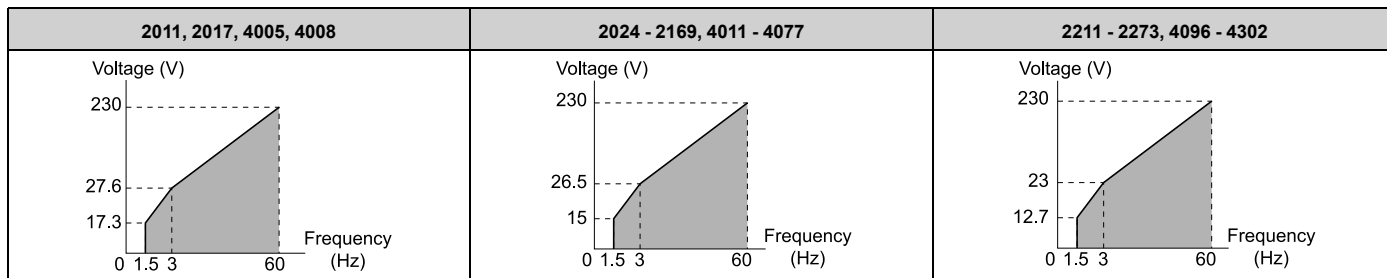

**C : High Freq, 60Hz base, 90Hz max**

Use this constant output pattern to rotate motors at more than 60 Hz. Output voltage is constant when you operate at more than 60 Hz.

**Note:**

The voltage values in the figures are for 208 V class drives. Multiply the values by 2 for 480 V class drives.

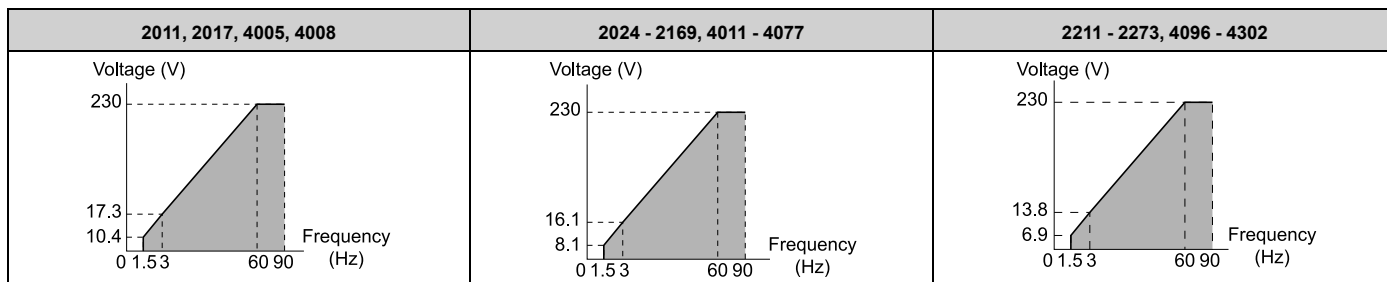

**D : High Freq, 60Hz base, 120Hz max**

Use this constant output pattern to rotate motors at more than 60 Hz. Output voltage is constant when you operate at more than 60 Hz.

**Note:**

The voltage values in the figures are for 208 V class drives. Multiply the values by 2 for 480 V class drives.

## 12.6 E: Motor Parameters

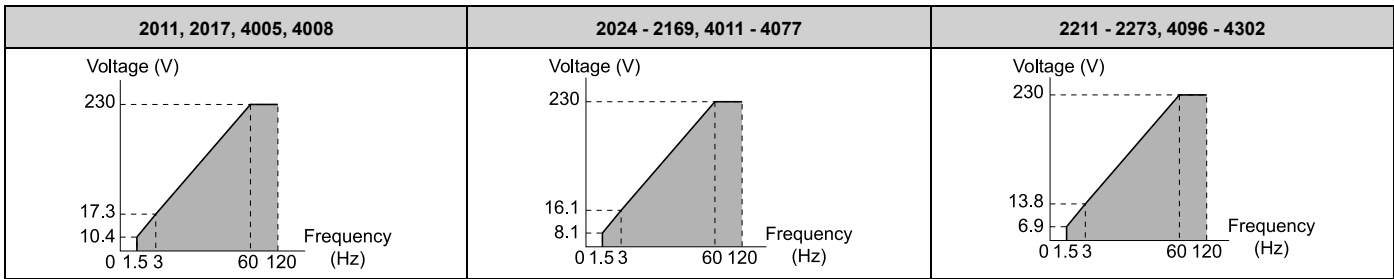

### E : High Freq, 60Hz base, 180Hz max

Use this constant output pattern to rotate motors at more than 60 Hz. Output voltage is constant when you operate at more than 60 Hz.

#### Note:

The voltage values in the figures are for 208 V class drives. Multiply the values by 2 for 480 V class drives.

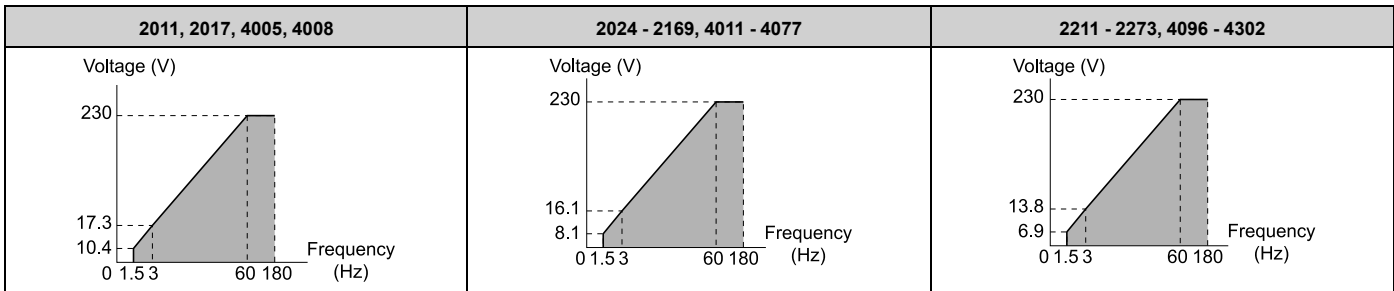

### F : Custom

Set *E1-04* to *E1-13* [*V/f Pattern for Motor 1*] to set the values for this custom pattern.

The default settings are the same as setting value 7 [*VT, 60Hz, 50% Vmid reduction*].

#### ■ E1-04: Maximum Output Frequency

No. (Hex.)	Name	Description	Default (Range)
E1-04 (0303)	Maximum Output Frequency	<input checked="" type="radio"/> V/f <input type="radio"/> OLVP/PM <input type="radio"/> EZOLV Sets the maximum output frequency for the V/f pattern.	Determined by A1-02 and E5-01 (Determined by A1-02 and E5-01)

#### ■ E1-05: Maximum Output Voltage

No. (Hex.)	Name	Description	Default (Range)
E1-05 (0304)	Maximum Output Voltage	<input checked="" type="radio"/> V/f <input type="radio"/> OLVP/PM <input type="radio"/> EZOLV Sets the maximum output voltage for the V/f pattern.	208 V Class: 230.0 V, 480 V Class: 460.0 V (208 V Class: 0.0 - 255.0 V, 480 V Class: 0.0 - 510.0 V)

#### ■ E1-06: Base Frequency

No. (Hex.)	Name	Description	Default (Range)
E1-06 (0305)	Base Frequency	<input checked="" type="radio"/> V/f <input type="radio"/> OLVP/PM <input type="radio"/> EZOLV Sets the base frequency for the V/f pattern.	Determined by A1-02 and E5-01 (0.0 - E1-04)

### ■ E1-07: Mid Point A Frequency

No. (Hex.)	Name	Description	Default (Range)
E1-07 (0306)	Mid Point A Frequency	<b>V/f</b> OLV/PM EZOLV Sets a middle output frequency for the V/f pattern.	Determined by E1-03 (0.0 - E1-04)

### ■ E1-08: Mid Point A Voltage

No. (Hex.)	Name	Description	Default (Range)
E1-08 (0307)	Mid Point A Voltage	<b>V/f</b> OLV/PM EZOLV Sets a middle output voltage for the V/f pattern.	Determined by o2-04 (208 V Class: 0.0 - 255.0 V, 480 V Class: 0.0 - 510.0 V)

**Note:**

Default setting is determined by o2-04 [Drive Model (KVA) Selection].

### ■ E1-09: Minimum Output Frequency

No. (Hex.)	Name	Description	Default (Range)
E1-09 (0308)	Minimum Output Frequency	<b>V/f</b> OLV/PM EZOLV Sets the minimum output frequency for the V/f pattern.	Determined by A1-02 and E5-01 (Determined by A1-02, E1-04, and E5-01)

### ■ E1-10: Minimum Output Voltage

No. (Hex.)	Name	Description	Default (Range)
E1-10 (0309)	Minimum Output Voltage	<b>V/f</b> OLV/PM EZOLV Sets the minimum output voltage for the V/f pattern.	Determined by E1-03 (208 V Class: 0.0 - 255.0 V, 480 V Class: 0.0 - 510.0 V)

### ■ E1-11: Mid Point B Frequency

No. (Hex.)	Name	Description	Default (Range)
E1-11 (030A) Expert	Mid Point B Frequency	<b>V/f</b> OLV/PM EZOLV Sets a middle output frequency for the V/f pattern.	0.0 Hz (0.0 - E1-04)

**Note:**

Set this parameter to 0.0 to disable the function.

### ■ E1-12: Mid Point B Voltage

No. (Hex.)	Name	Description	Default (Range)
E1-12 (030B) Expert	Mid Point B Voltage	<b>V/f</b> OLV/PM EZOLV Sets a middle point voltage for the V/f pattern.	0.0 V (208 V Class: 0.0 - 255.0 V, 480 V Class: 0.0 - 510.0 V)

**Note:**

Set this parameter to 0.0 to disable the function.

### ■ E1-13: Base Voltage

No. (Hex.)	Name	Description	Default (Range)
E1-13 (030C) Expert	Base Voltage	<b>V/f</b> OLV/PM EZOLV Sets the base voltage for the V/f pattern.	0.0 V (208 V Class: 0.0 - 255.0 V, 480 V Class: 0.0 - 510.0 V)

**Note:**

- After Auto-Tuning, the value of  $E1-13 = E1-05$  [Maximum Output Voltage].
- When  $E1-13 = 0.0$ , use the value of  $E1-05$  to control the voltage.

### ◆ E2: Motor Parameters

$E2$  parameters [Motor Parameters] set induction motor data. To switch drive operation from one motor to another motor, configure the first motor (motor 1).

Doing Auto-Tuning automatically sets the  $E2$  parameters to the optimal values. If you cannot do Auto-Tuning, set the  $E2$  parameters manually.

**Note:**

If you set  $A1-02$  [Control Method Selection] to these control methods, the keypad will not show  $E2-xx$ :

- 5 [PM Open Loop Vector]
- 8 [EZ Vector Control]

#### ■ E2-01: Motor Rated Current (FLA)

No. (Hex.)	Name	Description	Default (Range)
E2-01 (030E)	Motor Rated Current (FLA)	<div style="display: flex; gap: 5px;"> <span>V/f</span> <span>OLV/PM</span> <span>EZOLV</span> </div> Sets the motor rated current in amps.	Determined by o2-04 (10% to 200% of the drive rated current)

**Note:**

- If  $E2-01 < E2-03$  [Motor No-Load Current] the drive will detect  $oPE02$  [Parameter Range Setting Error].
- The default settings and setting ranges are in these units:
  - 0.01 A: 2011 to 2046, 4005 to 4014
  - 0.1 A: 2059 to 2273, 4021 to 4302

The value set for  $E2-01$  becomes the reference value for motor protection and the torque limit. Enter the motor rated current as written on the motor nameplate. The value of  $E2-01$  is automatically set to the value input for “Motor Rated Current” by the Auto-Tuning process.

#### ■ E2-02: Motor Rated Slip

No. (Hex.)	Name	Description	Default (Range)
E2-02 (030F)	Motor Rated Slip	<div style="display: flex; gap: 5px;"> <span>V/f</span> <span>OLV/PM</span> <span>EZOLV</span> </div> Sets motor rated slip.	Determined by o2-04 (0.000 - 20.000 Hz)

This parameter value becomes the base slip compensation value. The drive automatically sets this parameter during Auto-Tuning. When you cannot do Auto-Tuning, calculate the motor rated slip with the information on the motor nameplate and this formula:

$$E2-02 = f - (n \times p) / 120$$

- f: Motor rated frequency (Hz)
- n: Rated motor speed ( $\text{min}^{-1}$  (r/min))
- p: Number of motor poles

#### ■ E2-03: Motor No-Load Current

No. (Hex.)	Name	Description	Default (Range)
E2-03 (0310)	Motor No-Load Current	<div style="display: flex; gap: 5px;"> <span>V/f</span> <span>OLV/PM</span> <span>EZOLV</span> </div> Sets the no-load current for the motor in amps when operating at the rated frequency and the no-load voltage.	Determined by o2-04 (0 to E2-01)

**Note:**

The default settings and setting ranges are in these units:

- 0.01 A: 2011 to 2046, 4005 to 4014
- 0.1 A: 2059 to 2273, 4021 to 4302

The drive automatically sets this parameter during Auto-Tuning. When you cannot do Auto-Tuning, you can also use the motor no-load current on the motor test report to enter this value manually. Contact the motor manufacturer to receive a copy of the motor test report.

**Note:**

The default setting of the no-load current is for operation with a 4-pole motor recommended by Yaskawa.

### ■ E2-04: Motor Pole Count

No. (Hex.)	Name	Description	Default (Range)
E2-04 (0311)	Motor Pole Count	<input checked="" type="radio"/> V/f <input type="radio"/> OLV/PM <input type="radio"/> EZOLV Sets the number of motor poles.	4 (2 - 120)

**Note:**

When  $A1-02 = 0$  [Control Method Selection = V/f], the maximum value is 120.

Auto-Tuning automatically sets this parameter to the value of [Number of Motor Poles].

### ■ E2-05: Motor Line-to-Line Resistance

No. (Hex.)	Name	Description	Default (Range)
E2-05 (0312)	Motor Line-to-Line Resistance	<input checked="" type="radio"/> V/f <input type="radio"/> OLV/PM <input type="radio"/> EZOLV Sets the line-to-line resistance for the motor stator windings.	Determined by o2-04 (0.000 - 65.000 Ω)

**Note:**

This value is the motor line-to-line resistance. Do not set this parameter with the resistance per phase.

Auto-Tuning automatically sets this parameter. If you cannot do Auto-Tuning, use the test report from the motor manufacturer to configure the settings. Use one of these formulas to calculate the motor line-to-line resistance:

- E-type insulation: [the resistance value (Ω) shown on the test report at 75 °C] × 0.822
- B-type insulation: [the resistance value (Ω) shown on the test report at 75 °C] × 0.822
- F-type insulation: [the resistance value (Ω) shown on the test report at 115 °C] × 0.728

### ■ E2-06: Motor Leakage Inductance

No. (Hex.)	Name	Description	Default (Range)
E2-06 (0313)	Motor Leakage Inductance	<input checked="" type="radio"/> V/f <input type="radio"/> OLV/PM <input type="radio"/> EZOLV Sets the voltage drop from motor leakage inductance when the motor is operating at the rated frequency and rated current. This value is a percentage of Motor Rated Voltage.	Determined by o2-04 (0.0 - 60.0%)

The drive automatically sets this parameter during Auto-Tuning.

**Note:**

The motor nameplate does not usually show the quantity of voltage drop. If you do not know the value of the motor leakage inductance, contact the motor manufacturer to receive a copy of the motor test report.

### ■ E2-10: Motor Iron Loss

No. (Hex.)	Name	Description	Default (Range)
E2-10 (0317)	Motor Iron Loss	<input checked="" type="radio"/> V/f <input type="radio"/> OLV/PM <input type="radio"/> EZOLV Sets the motor iron loss.	Determined by o2-04 (0 - 65535 W)

### ■ E2-11: Motor Rated Power

No. (Hex.)	Name	Description	Default (Range)
E2-11 (0318)	Motor Rated Power	<input checked="" type="radio"/> V/f <input type="radio"/> OLV/PM <input type="radio"/> EZOLV Sets the motor rated output in the units from o1-58 [Motor Power Unit Selection].	Determined by o2-04 (0.00 - 650.00 HP)

The drive automatically sets this parameter to the value input for “Motor Rated Power” during Auto-Tuning.

### ◆ E3: V/f Pattern for Motor 2

E3 parameters [V/f Pattern for Motor 2] set the control mode and V/f pattern used for motor 2.

**Note:**

V/f preset patterns equivalent to those set with E1-03 [V/f Pattern Selection] are not available for E3 parameters. Use E3-04 [Motor 2 Maximum Output Frequency] to E3-10 [Motor 2 Minimum Output Voltage] to manually set the V/f pattern.

#### ■ Notes on Manually Setting V/f Patterns

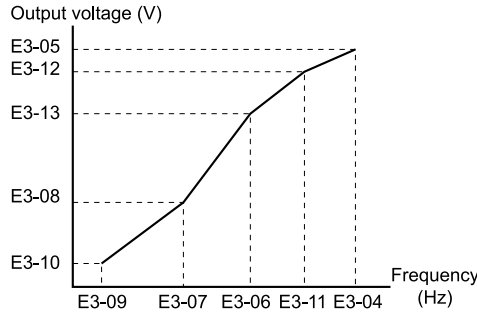

Figure 12.46 Motor 2 V/f Pattern Diagram

- To configure a linear V/f pattern at frequencies lower than E3-06 [Motor 2 Base Frequency], set E3-07 = E3-09 [Motor 2 Mid Point A Frequency = Motor 2 Minimum Output Frequency]. In this application, the drive ignores E1-08 [Mid Point A Voltage].
- Set the five frequencies as specified by these rules:  
 $E3-09 \leq E3-07 < E3-06 \leq E3-11 \leq E3-04$  [Motor 2 Minimum Output Frequency ≤ Motor 2 Mid Point A Frequency < Motor 2 Base Frequency ≤ Motor 2 Mid Point B Frequency ≤ Motor 2 Maximum Output Frequency]  
 Incorrect settings will trigger oPE10 [V/f Data Setting Error].
- If E3-11 = 0.0 Hz, the drive will ignore the V/f pattern settings.
- When you use A1-03 [Initialize Parameters] to initialize the drive, the drive will reset the manually set values for E3-04 to E3-13 [Motor 2 Base Voltage] to default values.

#### ■ E3-01: Motor 2 Control Mode Selection

No. (Hex.)	Name	Description	Default (Range)
E3-01 (0319)	Motor 2 Control Mode Selection	<input checked="" type="radio"/> V/f <input type="radio"/> OL/IFM <input type="radio"/> EZOLV Sets the control method for motor 2.	0 (0)

**Note:**

- Parameter L1-01 [Motor Overload (oL1) Protection] sets the protection operation of oL1 [Motor Overload] the same as Motor 1.
- When you use parameter A1-03 [Initialize Parameters] to initialize the drive, this parameter is not reset.

#### 0 : V/f Control

#### ■ E3-04: Motor 2 Maximum Output Frequency

No. (Hex.)	Name	Description	Default (Range)
E3-04 (031A)	Motor 2 Maximum Output Frequency	<input checked="" type="radio"/> V/f <input type="radio"/> OL/IFM <input type="radio"/> EZOLV Set the maximum output frequency for the motor 2 V/f pattern.	Determined by E3-01 (40.0 - 400.0 Hz)

#### ■ E3-05: Motor 2 Maximum Output Voltage

No. (Hex.)	Name	Description	Default (Range)
E3-05 (031B)	Motor 2 Maximum Output Voltage	<input checked="" type="radio"/> V/f <input type="radio"/> OL/IFM <input type="radio"/> EZOLV Sets the maximum output voltage for the motor 2 V/f pattern.	Determined by E3-01 (208 V Class: 0.0 - 255.0 V, 480 V Class: 0.0 - 510.0 V)

### ■ E3-06: Motor 2 Base Frequency

No. (Hex.)	Name	Description	Default (Range)
E3-06 (031C)	Motor 2 Base Frequency	<input checked="" type="checkbox"/> V/f <input type="checkbox"/> OLV/PM <input type="checkbox"/> EZOLV Sets the base frequency for the motor 2 V/f pattern.	Determined by E3-01 (0.0 - E3-04)

### ■ E3-07: Motor 2 Mid Point A Frequency

No. (Hex.)	Name	Description	Default (Range)
E3-07 (031D)	Motor 2 Mid Point A Frequency	<input checked="" type="checkbox"/> V/f <input type="checkbox"/> OLV/PM <input type="checkbox"/> EZOLV Sets a middle output frequency for the motor 2 V/f pattern.	Determined by E3-01 (0.0 - E3-04)

### ■ E3-08: Motor 2 Mid Point A Voltage

No. (Hex.)	Name	Description	Default (Range)
E3-08 (031E)	Motor 2 Mid Point A Voltage	<input checked="" type="checkbox"/> V/f <input type="checkbox"/> OLV/PM <input type="checkbox"/> EZOLV Sets a middle output voltage for the motor 2 V/f pattern.	Determined by E3-01 (208 V Class: 0.0 - 255.0 V, 480 V Class: 0.0 - 510.0 V)

### ■ E3-09: Motor 2 Minimum Output Frequency

No. (Hex.)	Name	Description	Default (Range)
E3-09 (031F)	Motor 2 Minimum Output Frequency	<input checked="" type="checkbox"/> V/f <input type="checkbox"/> OLV/PM <input type="checkbox"/> EZOLV Sets the minimum output frequency for the motor 2 V/f pattern.	Determined by E3-01 (0.0 - E3-04)

### ■ E3-10: Motor 2 Minimum Output Voltage

No. (Hex.)	Name	Description	Default (Range)
E3-10 (0320)	Motor 2 Minimum Output Voltage	<input checked="" type="checkbox"/> V/f <input type="checkbox"/> OLV/PM <input type="checkbox"/> EZOLV Sets the minimum output voltage for the motor 2 V/f pattern.	Determined by E3-01 (208 V Class: 0.0 - 255.0 V, 480 V Class)

### ■ E3-11: Motor 2 Mid Point B Frequency

No. (Hex.)	Name	Description	Default (Range)
E3-11 (0345) Expert	Motor 2 Mid Point B Frequency	<input checked="" type="checkbox"/> V/f <input type="checkbox"/> OLV/PM <input type="checkbox"/> EZOLV Sets a middle output frequency for the motor 2 V/f pattern. Set this parameter to adjust the V/f pattern for the constant output range. Usually it is not necessary to change this parameter.	0.0 Hz (0.0 - E3-04)

**Note:**

- Set this parameter to 0.0 to disable the function.
- When you initialize the drive, this parameter is reset to the default value.

### ■ E3-12: Motor 2 Mid Point B Voltage

No. (Hex.)	Name	Description	Default (Range)
E3-12 (0346) Expert	Motor 2 Mid Point B Voltage	<input checked="" type="checkbox"/> V/f <input type="checkbox"/> OLV/PM <input type="checkbox"/> EZOLV Sets a middle output voltage for the motor 2 V/f pattern. Set this parameter to adjust the V/f pattern for the constant output range. Usually it is not necessary to change this parameter.	0.0 V (208 V Class: 0.0 - 255.0 V, 480 V Class: 0.0 - 510.0 V)

**Note:**

- Set this parameter to 0.0 to disable the function.
- When you initialize the drive, this parameter is reset to the default value.
- The setting value changes automatically when you do Auto-Tuning (rotational and stationary 1 or 2).

### ■ E3-13: Motor 2 Base Voltage

No. (Hex.)	Name	Description	Default (Range)
E3-13 (0347) Expert	Motor 2 Base Voltage	<input checked="" type="checkbox"/> V/f <input type="checkbox"/> OLV/PM <input type="checkbox"/> EZOLV Sets the base voltage for the motor 2 V/f pattern. Set this parameter to adjust the V/f pattern for the constant output range. Usually it is not necessary to change this parameter.	0.0 V (208 V Class: 0.0 - 255.0 V, 480 V Class: 0.0 - 510.0 V)

**Note:**

- When you initialize the drive, this parameter is reset to the default value.
- The setting value changes automatically when you do Auto-Tuning (rotational and stationary 1 or 2).

### ◆ E4: Motor 2 Parameters

*E4 parameters [Motor 2 Parameters]* set induction motor data. To switch drive operation from one motor to a different motor, configure motor 2.

Auto-Tuning automatically sets the *E4 parameters* to the best values for the application. If you cannot do Auto-Tuning, set the *E4 parameters* manually.

**Note:**

*E3-xx* and *E4-xx* are available when *H1-xx = 16* [MFDI Function Select = Motor 2 Selection].

### ■ E4-01: Motor 2 Rated Current

No. (Hex.)	Name	Description	Default (Range)
E4-01 (0321)	Motor 2 Rated Current	<input checked="" type="checkbox"/> V/f <input type="checkbox"/> OLV/PM <input type="checkbox"/> EZOLV Sets the motor rated current for motor 2 in amps.	Determined by o2-04 (10% to 200% of the drive rated current)

**Note:**

- If  $E4-01 \leq E4-03$  [Motor 2 Rated No-Load Current], the drive will detect *oPE02* [Parameter Range Setting Error].
- The default settings and setting ranges are in these units:  
 -0.01 A: 2011 to 2046, 4005 to 4014  
 -0.1 A: 2059 to 2273, 4021 to 4302

The value set for *E4-01* becomes the reference value for motor protection and the torque limit. Enter the motor rated current written on the motor nameplate. Auto-Tuning automatically sets the value of *E4-01* to the value input for [Motor Rated Current].

### ■ E4-02: Motor 2 Rated Slip

No. (Hex.)	Name	Description	Default (Range)
E4-02 (0322)	Motor 2 Rated Slip	<input checked="" type="checkbox"/> V/f <input type="checkbox"/> OLV/PM <input type="checkbox"/> EZOLV Sets the motor rated slip for motor 2.	Determined by o2-04 (0.000 - 20.000 Hz)

The value set in *E4-02* becomes the base slip compensation value. The drive sets this parameter during Rotational Auto-Tuning and Stationary Auto-Tuning. If you cannot do Auto-Tuning, use the information written on the motor nameplate and this formula to calculate the motor rated slip:

$$E4-02 = f - (n \times p) / 120$$

- *f*: Motor rated frequency (Hz)
- *n*: Rated motor speed ( $\text{min}^{-1}$  (r/min))
- *p*: Number of motor poles

### ■ E4-03: Motor 2 Rated No-Load Current

No. (Hex.)	Name	Description	Default (Range)
E4-03 (0323)	Motor 2 Rated No-Load Current	<input checked="" type="checkbox"/> V/f <input type="checkbox"/> OLV/PM <input type="checkbox"/> EZOLV Sets the no-load current for motor 2 in amps when operating at the rated frequency and the no-load voltage.	Determined by o2-04 (Less than 0 - E4-01)



**Note:**

The display units for this parameter are different for different drive models.

- 0.01 A: 2011 to 2046, 4005 to 4014
- 0.1 A: 2059 to 2273, 4021 to 4302

You can also manually enter the motor no-load current shown on the motor test report to *E4-03*. Contact the motor manufacturer to receive a copy of the motor test report.

**Note:**

The default setting of the no-load current is for a 4-pole motor recommended by Yaskawa.

### ■ E4-04: Motor 2 Motor Poles

No. (Hex.)	Name	Description	Default (Range)
E4-04 (0324)	Motor 2 Motor Poles	<input type="checkbox"/> V/f <input type="checkbox"/> OLV/PM <input type="checkbox"/> EZOLV Sets the number of poles for motor 2.	4 (2 - 120)

Auto-Tuning automatically sets *E4-04* to the value input for [Number of Motor Poles].

### ■ E4-05: Motor 2 Line-to-Line Resistance

No. (Hex.)	Name	Description	Default (Range)
E4-05 (0325)	Motor 2 Line-to-Line Resistance	<input type="checkbox"/> V/f <input type="checkbox"/> OLV/PM <input type="checkbox"/> EZOLV Sets the line-to-line resistance for the motor 2 stator windings.	Determined by o2-04 (0.000 - 65.000 Ω)

**Note:**

This value is the line-to-line resistance for motor 2. Do not set this parameter with the resistance per phase.

Auto-Tuning automatically sets this parameter. If you cannot do Auto-Tuning, use the test report from the motor manufacturer to configure the settings. Use one of these formulas to calculate the motor line-to-line resistance:

- E-type insulation: [the resistance value (Ω) shown on the test report at 75 °C] × 0.822
- B-type insulation: [the resistance value (Ω) shown on the test report at 75 °C] × 0.822
- F-type insulation: [the resistance value (Ω) shown on the test report at 115 °C] × 0.728

### ■ E4-06: Motor 2 Leakage Inductance

No. (Hex.)	Name	Description	Default (Range)
E4-06 (0326)	Motor 2 Leakage Inductance	<input type="checkbox"/> V/f <input type="checkbox"/> OLV/PM <input type="checkbox"/> EZOLV Sets the voltage drop from motor 2 leakage inductance as a percentage of Motor Rated Voltage when motor 2 operates at the rated frequency and rated current.	Determined by o2-04 (0.0 - 60.0%)

The drive sets this parameter during Rotational Auto-Tuning and Stationary Auto-Tuning.

**Note:**

You cannot usually find the quantity of voltage drop on the motor nameplate. If you do not know the value of the motor 2 leakage inductance, get the test report from the motor manufacturer.

### ■ E4-10: Motor 2 Iron Loss

No. (Hex.)	Name	Description	Default (Range)
E4-10 (0340)	Motor 2 Iron Loss	<input type="checkbox"/> V/f <input type="checkbox"/> OLV/PM <input type="checkbox"/> EZOLV Sets the motor iron loss for motor 2.	Determined by o2-04 (0 - 65535 W)

### ■ E4-11: Motor 2 Rated Power

No. (Hex.)	Name	Description	Default (Range)
E4-11 (0327)	Motor 2 Rated Power	<input type="checkbox"/> V/f <input type="checkbox"/> OLV/PM <input type="checkbox"/> EZOLV Sets the motor rated power in the units from o1-58 [Motor Power Unit Selection].	Determined by o2-04 (0.00 - 650.00 HP)

Auto-Tuning automatically sets this parameter to the value input for [Motor Rated Power].

## ◆ E5: PM Motor Settings

*E5 parameters* set PM motor data.

Set *E5-01* to the motor code when you use a PM motor recommended by Yaskawa and the drive will automatically set *E5* and other related motor parameters to the optimal values.

Do Auto-Tuning for all other PM motors. If information from motor nameplates or test reports is available, you can enter the *E5 parameters* manually.

### Note:

- The keypad shows *E5-xx* only when *A1-02* = 5 [Control Method Selection = OLV/PM].
- If you use *A1-03* [Initialize Parameters] to initialize the drive, it will not reset *E5-xx parameters*.

### ■ E5-01: PM Motor Code Selection

No. (Hex.)	Name	Description	Default (Range)
E5-01 (0329)	PM Motor Code Selection	<div style="display: flex; justify-content: space-between; align-items: center;"> <span>V/f</span> <span style="background-color: #ccc; border: 1px solid #000; padding: 2px;">OLV/PM</span> <span style="background-color: #ccc; border: 1px solid #000; padding: 2px;">EZOLV</span> </div> Sets the motor code for Yaskawa PM motors. The drive uses the motor code to automatically set some parameters to their correct settings.	FFFF (0000 - FFFF)

### Note:

If the drive hunts or shows an alarm after you enter a motor code, use the keypad to enter the value shown on the nameplate to *E5-xx*.

### ■ E5-02: PM Motor Rated Power

No. (Hex.)	Name	Description	Default (Range)
E5-02 (032A)	PM Motor Rated Power	<div style="display: flex; justify-content: space-between; align-items: center;"> <span>V/f</span> <span style="background-color: #ccc; border: 1px solid #000; padding: 2px;">OLV/PM</span> <span style="background-color: #ccc; border: 1px solid #000; padding: 2px;">EZOLV</span> </div> Sets the PM motor rated output in the units set in <i>o1-58</i> [Motor Power Unit Selection].	Determined by <i>o2-04</i> (0.13 - 650.00 HP)

The drive will automatically set this parameter the next time you do Auto-Tuning.

- PM Motor Parameter Settings
- PM Stationary Auto-Tuning
- PM Rotational Auto-Tuning

### ■ E5-03: PM Motor Rated Current (FLA)

No. (Hex.)	Name	Description	Default (Range)
E5-03 (032B)	PM Motor Rated Current (FLA)	<div style="display: flex; justify-content: space-between; align-items: center;"> <span>V/f</span> <span style="background-color: #ccc; border: 1px solid #000; padding: 2px;">OLV/PM</span> <span style="background-color: #ccc; border: 1px solid #000; padding: 2px;">EZOLV</span> </div> Sets the PM motor rated current (FLA).	Determined by <i>o2-04</i> (10% to 200% of the drive rated current)

### Note:

When the drive model changes, the display units for this parameter also change.

- 0.01 A: 2011 to 2046, 4005 to 4014
- 0.1 A: 2059 to 2273, 4021 to 4302

The drive automatically sets *E5-03* to the value input for “PM Motor Rated Current” after you do these types of Auto-Tuning:

- PM Motor Parameter Settings
- PM Stationary Auto-Tuning
- PM StaTun for Stator Resistance
- PM Rotational Auto-Tuning

### ■ E5-04: PM Motor Pole Count

No. (Hex.)	Name	Description	Default (Range)
E5-04 (032C)	PM Motor Pole Count	<div style="display: flex; justify-content: space-between; align-items: center;"> <span>V/f</span> <span style="background-color: #ccc; border: 1px solid #000; padding: 2px;">OLV/PM</span> <span style="background-color: #ccc; border: 1px solid #000; padding: 2px;">EZOLV</span> </div> Sets the number of PM motor poles.	4 (2 - 120)

**Note:**

When  $A1-02 = 5$  or  $8$  [OLV/PM or EZOLV], the maximum value is 48.

These types of Auto-Tuning will automatically set this parameter to the value of [Number of Motor Poles]:

- PM Motor Parameter Settings
- PM Stationary Auto-Tuning
- PM Rotational Auto-Tuning

### ■ E5-05: PM Motor Resistance (ohms/phase)

No. (Hex.)	Name	Description	Default (Range)
E5-05 (032D)	PM Motor Resistance (ohms/phase)	<input type="checkbox"/> V/f <input checked="" type="checkbox"/> OLV/PM <input type="checkbox"/> EZOLV Sets the resistance per phase of a PM motor. Set 50% of the line-to-line resistance.	0.100 Ω (0.000 - 65.000 Ω)

PM motor Auto-Tuning automatically sets this parameter to the value of [PM Motor Stator Resistance].

**Note:**

Do not change the setting calculated by Auto-Tuning unless it is necessary.

### ■ E5-06: PM d-axis Inductance (mH/phase)

No. (Hex.)	Name	Description	Default (Range)
E5-06 (032E)	PM d-axis Inductance (mH/phase)	<input type="checkbox"/> V/f <input checked="" type="checkbox"/> OLV/PM <input type="checkbox"/> EZOLV Sets the PM motor d-axis inductance.	1.00 mH (0.00 - 300.00 mH)

PM motor Auto-Tuning automatically sets this parameter to the value of [PM Motor d-Axis Inductance].

**Note:**

Do not change the setting calculated by Auto-Tuning unless it is necessary.

### ■ E5-07: PM q-axis Inductance (mH/phase)

No. (Hex.)	Name	Description	Default (Range)
E5-07 (032F)	PM q-axis Inductance (mH/phase)	<input type="checkbox"/> V/f <input checked="" type="checkbox"/> OLV/PM <input type="checkbox"/> EZOLV Sets the PM motor q-axis inductance.	1.00 mH (0.00 - 600.00 mH)

PM motor Auto-Tuning automatically sets this parameter to the value of [PM Motor q-Axis Inductance].

**Note:**

Do not change the setting calculated by Auto-Tuning unless it is necessary.

### ■ E5-09: PM Back-EMF Vpeak (mV/(rad/s))

No. (Hex.)	Name	Description	Default (Range)
E5-09 (0331)	PM Back-EMF Vpeak (mV/(rad/s))	<input type="checkbox"/> V/f <input checked="" type="checkbox"/> OLV/PM <input type="checkbox"/> EZOLV Sets the peak value of PM motor induced voltage.	0.0 mV/(rad/sec) (0.0 - 2000.0 mV/(rad/s))

Set this parameter when you use an IPM motor with derated torque or an IPM motor with constant torque.

PM motor Auto-Tuning automatically sets this parameter to the value of [Back-EMF Voltage Constant (Ke)].

When  $E5-01 = FFFF$ , only set  $E5-09$  or  $E5-24$  [PM Back-EMF L-L  $V_{rms}$  (mV/rpm)] as the induced voltage constant.

**Note:**

When you set this parameter, also set  $E5-24 = 0.0$ . The drive will detect  $oPE08$  [Parameter Selection Error] in these conditions:

- $E5-09 = 0.0$  and  $E5-24 = 0.0$
- $E5-09 \neq 0.0$  and  $E5-24 \neq 0.0$

■ **E5-24: PM Back-EMF L-L Vrms (mV/rpm)**

No. (Hex.)	Name	Description	Default (Range)
E5-24 (0353)	PM Back-EMF L-L Vrms (mV/rpm)	<input type="radio"/> V/f <input checked="" type="radio"/> OLV/PM <input type="radio"/> EZOLV Sets the RMS value for PM motor line voltage.	0.1 mV/min <sup>-1</sup> (0.0 - 6500.0 mV/min <sup>-1</sup> )

Set this parameter when you use an SPM motor.

PM motor Auto-Tuning automatically sets this parameter to the value of [Back-EMF Voltage Constant (Ke)].

When E5-01 = FFFF, only set E5-09 [PM Back-EMF Vpeak (mV/(rad/s))] or E5-24 as the induced voltage constant.

**Note:**

When you set this parameter, also set E5-09 = 0.0. The drive will detect oPE08 [Parameter Selection Error] in these conditions:

- E5-09 = 0.0 and E5-24 = 0.0
- E5-09 ≠ 0.0 and E5-24 ≠ 0.0

◆ **E9: Motor Setting**

E9 parameters set SynRM motors. Set these parameters to derate torque applications when a high level of responsiveness and accurate speed control are not necessary. Auto-Tuning the drive will automatically set the E9 parameters.

If you cannot do EZ Tuning, you can also manually set the E9 parameters.

■ **E9-01: Motor Type Selection**

No. (Hex.)	Name	Description	Default (Range)
E9-01 (11E4)	Motor Type Selection	<input type="radio"/> V/f <input type="radio"/> OLV/PM <input checked="" type="radio"/> EZOLV Sets the type of motor.	0 (0 - 2)

EZ Tuning automatically sets this parameter to the value of [Motor Type Selection].

**0 : Induction (IM)**

**1 : Permanent Magnet (PM)**

**2 : Synchronous Reluctance (SynRM)**

■ **E9-02: Maximum Speed**

No. (Hex.)	Name	Description	Default (Range)
E9-02 (11E5)	Maximum Speed	<input type="radio"/> V/f <input type="radio"/> OLV/PM <input checked="" type="radio"/> EZOLV Sets the maximum speed of the motor.	Determined by E9-01 (40.0 - 120.0 Hz)

EZ Tuning automatically sets this parameter to the value of [Motor Max Revolutions].

■ **E9-03: Rated Speed**

No. (Hex.)	Name	Description	Default (Range)
E9-03 (11E6)	Rated Speed	<input type="radio"/> V/f <input type="radio"/> OLV/PM <input checked="" type="radio"/> EZOLV Sets the rated rotation speed of the motor.	Determined by E9-01 (100 - 7200 min <sup>-1</sup> )

EZ Tuning automatically sets this parameter to the value of [Rated Speed].

**Note:**

Set E9-01 = 0 [Motor Type Selection = Induction (IM)] before you set this parameter.

■ **E9-04: Base Frequency**

No. (Hex.)	Name	Description	Default (Range)
E9-04 (11E7)	Base Frequency	<input type="radio"/> V/f <input type="radio"/> OLV/PM <input checked="" type="radio"/> EZOLV Sets the rated frequency of the motor.	Determined by E9-01 (40.0 - 120.0 Hz)

EZ Tuning automatically sets this parameter to the value of [Base Frequency].

### ■ E9-05: Base Voltage

No. (Hex.)	Name	Description	Default (Range)
E9-05 (11E8)	Base Voltage	V/f OLV/PM EZOLV Sets the rated voltage of the motor.	208 V Class: 230.0 V, 480 V Class: 460.0 V (208 V Class: 0.0 - 255.0 V, 480 V Class: 0.0 - 510.0 V)

EZ Tuning automatically sets this parameter to the value of [Base Voltage].

### ■ E9-06: Motor Rated Current (FLA)

No. (Hex.)	Name	Description	Default (Range)
E9-06 (11E9)	Motor Rated Current (FLA)	V/f OLV/PM EZOLV Sets the motor rated current in amps.	Determined by E9-01 and o2-04 (10% to 200% of the drive rated current)

**Note:**

When the drive model changes, the display units for this parameter also change.

- 0.01 A: 2011 to 2046, 4005 to 4014
- 0.1 A: 2059 to 2273, 4021 to 4302

The setting value of *E9-06* is the reference value for motor protection. Enter the motor rated current shown on the motor nameplate. Auto-Tuning the drive will automatically set *E9-06* to the value input for “Motor Rated Current”.

### ■ E9-07: Motor Rated Power

No. (Hex.)	Name	Description	Default (Range)
E9-07 (11EA)	Motor Rated Power	V/f OLV/PM EZOLV Sets the motor rated output in the units from o1-58 [Motor Power Unit Selection].	Determined by E9-02 and o2-04 (0.00 - 650.00 kW)

Auto-Tuning automatically sets this parameter to the value of [Motor Rated Power (kW)].

### ■ E9-08: Motor Pole Count

No. (Hex.)	Name	Description	Default (Range)
E9-08 (11EB)	Motor Pole Count	V/f OLV/PM EZOLV Sets the number of motor poles.	4 (2 to 120)

Auto-Tuning automatically sets this parameter to the value of [Number of Motor Poles].

### ■ E9-09: Motor Rated Slip

No. (Hex.)	Name	Description	Default (Range)
E9-09 (11EC)	Motor Rated Slip	V/f OLV/PM EZOLV Sets the motor rated slip.	0.000 Hz (0.000 - 20.000 Hz)

The setting value of this parameter is the slip compensation reference value.

The drive uses the setting values of *E9-03*, *E9-04*, and *E9-08* to calculate this parameter. When Motor Rated Slip = 0, Auto-Tuning automatically sets this parameter to the value of [Motor Rated Slip].

**Note:**

Set *E9-01* = 0 [Motor Type Selection = Induction (IM)] before you set this parameter.

### ■ E9-10: Motor Line-to-Line Resistance

No. (Hex.)	Name	Description	Default (Range)
E9-10 (11ED)	Motor Line-to-Line Resistance	<div style="display: flex; gap: 5px;"> <span>V/f</span> <span>OLV/PM</span> <span style="background-color: #333; color: white; padding: 2px;">EZOLV</span> </div> Sets the line-to-line resistance for the motor stator windings.	Determined by o2-04 (0.000 - 65.000 Ω)

**Note:**

This value is the motor line-to-line resistance. Do not set this parameter with the resistance per phase.

Stationary Auto-Tuning automatically sets this parameter. If you cannot do Stationary Auto-Tuning, use the test report from the motor manufacturer. Use one of these formulas to calculate the motor line-to-line resistance:

- E-type insulation: [the resistance value (Ω) shown on the test report at 75 °C] × 0.822
- B-type insulation: [the resistance value (Ω) shown on the test report at 75 °C] × 0.822
- F-type insulation: [the resistance value (Ω) shown on the test report at 115 °C] × 0.728

## 12.7 F: Options

*F* parameters set communication option card parameters, which function as interfaces for fieldbus communication.

### ◆ F6, F7: Communication Options and Ethernet Options

*F6* and *F7* parameters set the basic communication settings and method of fault detection for the communication option card. The communication option card parameters include common option card parameters and communication protocol-specific parameters.

The following table lists the parameters that you must set for each communication option card.

Refer to the manual for each communication option card for more information about how to install, wire, and configure the option card before you start communication.

**WARNING!** *Sudden Movement Hazard. Do test runs and examine the drive to make sure that the command references are correct. If you set the command reference incorrectly, it can cause damage to the drive or serious injury or death.*

**Note:**

Cells marked with “x” apply and cells marked with “-” do not apply.

**Table 12.40 Correspondence Between Communication Protocols and Parameters**

Parameter	LonWorks SI-W3	Modbus TCP/IP SI-EM3	Modbus TCP/IP JOHB-SMP3	PROFINET SI-EP3	PROFINET JOHB-SMP3	EtherNet/IP SI-EN3	EtherNet/IP JOHB-SMP3	BACnet/IP JOHB-SMP3
F6-01 to F6-03	x	x	x	x	x	x	x	x
F6-04, F6-06	x	x	x	x	x	x	x	-
F6-07, F6-08	x	x	x	x	x	x	x	x
F6-14	x	x	x	x	x	x	x	x
F6-16	x	x	x	x	x	x	x	x
F6-48, F6-49	-	-	-	-	-	-	-	x
F7-01 to F7-15	-	x	x	x	x	x	x	x
F7-16	-	x	x	-	-	-	-	-
F7-17 to F7-42	-	-	-	x	x	x	x	-
F7-50 to F7-57	-	-	-	-	-	-	-	x

### ■ Gateway Mode

**Note:**

When you use Gateway Mode, do not install the communication option in slave drives. If you install a communication option in a slave drive, the drive commands and responses will not synchronize.

In gateway mode, you can use one communication option to communicate with more than one drive.

You can use one communication option to connect a maximum of five drives to fieldbus communications. Refer to [Figure 12.47](#) for more information.

When you install a communication option on the master drive, you can use the RS-485 communication card to transmit data and slave drives without a communication option can receive it.

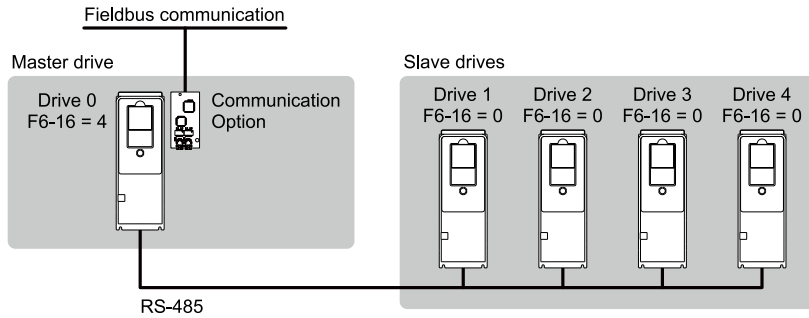

**F6-16: Gateway Mode**  
**F6-16 = 0: Disabled**

**F6-16 = 4: Enabled: 4 Slave Drives**

**Figure 12.47 Connection Examples in Gateway Mode**

**Table 12.41 Specification**

Item	Specification
Applicable options	All the options that support the MEMOBUS access function (for example, PROFINET, EtherNet/IP, etc.)
Number of connected drives	Maximum: 5 units
Communication Specifications	MEMOBUS/Modbus (RTUmode) communications
Commands/responses	The controller can send this data to each drive (Drive 0 to Drive 4): <ul style="list-style-type: none"> <li>• Control commands: Run commands and frequency references</li> <li>• Control responses: Output frequency and drive status (during run, faults)</li> <li>• Read and write parameters</li> <li>• Read monitors</li> </ul>
Synchronous control	Not supported

**Note:**

- The communication speed in gateway mode is slower than the speed in fieldbus communications. Make sure that the speed is acceptable for your system.
- Response speed with the communication option is slower than the speed with point-to-point communications.
- Set H5-03 [Communication Parity Selection] to the same value on the master drive and slave drives.

**WARNING! Injury to Personnel.** Separately prepare safety protection equipment and systems, for example fast stop switches. If the motor does not stop correctly from the disconnection of communications cable or electrical interference, it can cause serious injury.

**Configuring Gateway Mode**

Table 12.42 shows sample settings to connect 4 slave drives:

**Table 12.42 Sample Settings for Using Gateway Mode**

	F6-16 [Gateway Mode]	H5-01 [Drive Node Address] *1	H5-02 [Communication Speed Selection] H5-03 [Communication Parity Selection]	H5-06 [Drive Transmit Wait Time]	H5-09 [CE Detection Time]	b1-01 [Frequency Reference Selection 1]	b1-02 [Run Command Selection 1]
Drive 0 (Master Drive)	1 - 4 *2	1F (Default)	*5	5 ms (factory default) *6	≥ 2.0 s *7	3 [Option PCB]	3 [Option PCB]
Drive 1 (Slave drive)	0	01 *3 *4	*5	5 ms (factory default) *6	≥ 0.9 s *7	2 [Serial Communications] *8	2 [Serial Communications] *8
Drive 2 (Slave drive)	0	02 *3 *4	*5	5 ms (factory default) *6	≥ 0.9 s *7	2 [Serial Communications] *8	2 [Serial Communications] *8
Drive 3 (Slave drive)	0	03 *3 *4	*5	5 ms (factory default) *6	≥ 0.9 s *7	2 [Serial Communications] *8	2 [Serial Communications] *8
Drive 4 (Slave drive)	0	04 *3 *4	*5	5 ms (factory default) *6	≥ 0.9 s *7	2 [Serial Communications] *8	2 [Serial Communications] *8

- \*1 Restart the drive to apply the new settings.
- \*2 Specify the number of slave drives you will connect.
- \*3 Setting 0 will not let the drive respond to MEMOBUS/Modbus communications.
- \*4 Set a slave address that is different from other slave devices.



- \*5 Enter the same value that you use for the master drive.
- \*6 To correctly detect the response timeout, do not change the value of *H5-06* from the default value.
- \*7 Set  $H5-09 \geq 0.9$ . When  $H5-09 < 0.9$ , the drive will detect *CE [Modbus Communication Error]* before it detects a response timeout.
- \*8 On each slave drive, set *b1-01 [Frequency Reference Selection 1]* and *b1-02 [Run Command Selection 1]* to 2 [*Serial Communications*].

### Gateway Mode Overview

In gateway mode, the drive operates as shown in [Table 12.43](#).

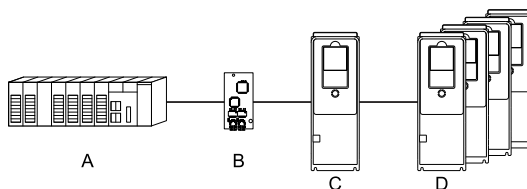

**A - Controller**

**B - Communication Option**

**C - Master Drive (Drive 0)**

**D - Slave Drives (Drives 1 to 4)**

**Table 12.43 Operation in Gateway Mode**

Controller to Communication Option Card	Communication Option Card to Master Drive (Drive 0)	Master Drive (Drive 0) to Slave Drives (Drives 1 to 4)
<ul style="list-style-type: none"> <li>• The controller and card communicate in the format of each fieldbus communications protocol.</li> <li>• Drive 0 sends commands and monitors through normal fieldbus communications.</li> <li>• The special registers of Drive 0 use read and write to send commands to and monitor Drives 1 to 4.</li> </ul>	Field bus communication data is written to and read from the special registers of Drive 0.	<ul style="list-style-type: none"> <li>• Uses MEMOBUS communications .</li> <li>• Drive 0 sends data from its special registers to Drives 1 to 4.</li> </ul>

**Note:**

Energize the slave drives before you energize the master drive. If you energize the master drive before you energize the slave drives, the drive detects *CE [Modbus Communication Error]*.

### Operations at the Time of Communication Error

Communication Error	Error Codes	Operation
From controller to communication option	bUS	<ul style="list-style-type: none"> <li>• Master drive Detects <i>bUS [Option Communication Error]</i> and operates as specified by <i>F6-01 [Communication Error Selection]</i>.</li> <li>• Slave drive Detects <i>CE [Modbus Communication Error]</i> and operates as specified by <i>H5-04 [Communication Error Stop Method]</i>.</li> </ul> <p><b>Note:</b></p> <ul style="list-style-type: none"> <li>• After error detection, each drive can continue the operation specified by the last received command if the <i>F6-01</i> and <i>H5-04</i> settings agree. Because the controller cannot stop the operation, you must supply a stopping method, for example an emergency stop switch.</li> <li>• If you set <math>H5-05 = 0</math> [<i>Comm Fault Detection Selection = Disabled</i>], the drive will not detect <i>CE</i>. The <i>H5-04</i> setting does not have an effect.</li> </ul>
From communication option to master drive	oFAxx	<ul style="list-style-type: none"> <li>• Master drive Detects <i>oFAxx</i> and coasts to stop.</li> <li>• Slave drive Detects <i>hLCE [High Level Communication Errors]</i> and coasts to stop.</li> </ul>
From master drive to slave drive	CE	<p>The master drive stops communicating with the slave drive in these conditions: Reset the fault to restart communication.</p> <p>The slave drive detects <i>CE</i> after <i>H5-09 [CE Detection Time]</i> is expired. Then it operates in as specified with <i>H5-04 [Communication Error Stop Method]</i>.</p> <ul style="list-style-type: none"> <li>• A message error occurred in the send data from the slave drive 10 consecutive times.</li> <li>• Response from the slave drive timed out 10 consecutive times.</li> </ul>

## Gateway Special Register Specification

Table 12.44 Command Data



Register No. (Hex.)	Description		
15C5	Command source update		This flag enables command updates.
	bit 0	Drive 1 Update Command Enabled	To input the Run command and frequency reference at the same time, write all commands, then change the bit value from 0 to 1.
	bit 1	Drive 2 Update Command Enabled	
	bit 2	Drive 3 Update Command Enabled	
	bit 3	Drive 4 Update Command Enabled	
	bit 4	Update Register Access Command Enabled	
	bit 5 - F	Reserved	
15C6	Run Command (Drive 1)		
	bit 0	H5-12 = 0: FWD/Stop 0 = Stop 1 = Forward run	
		H5-12 = 1: Run/Stop 0 = Stop 1 = Run	
	bit 1	H5-12 = 0: REV/Stop 0 = Stop 1 = Reverse run	
		H5-12 = 1: FWD/REV 0 = Forward run 1 = Reverse run	
	bit 2	External fault	
	bit 3	Fault Reset	
	bit 4	ComRef	
	bit 5	ComCtrl	
bit 6 - F	Reserved		
15C7	Frequency Reference (Drive 1)		The unit of measure changes when <i>ol-03</i> changes.
15C8	Run Command (Drive 2)		Refer to "15C6: Run Command (Drive 1)" for more information.
15C9	Frequency Reference (Drive 2)		The unit of measure changes when <i>ol-03</i> changes.
15CA	Run Command (Drive 3)		Refer to "15C6: Run Command (Drive 1)" for more information.
15CB	Frequency Reference (Drive 3)		The unit of measure changes when <i>ol-03</i> changes.
15CC	Run Command (Drive 4)		Refer to "15C6: Run Command (Drive 1)" for more information.
15CD	Frequency Reference (Drive 4)		The unit of measure changes when <i>ol-03</i> changes.
15CE	Slave Address for Reg. Access + Read/Write		
	bit 0 bit 1 bit 2 bit 3	Slave address 0: Broadcast Messages (MEMOBUS) 1: Drive 1 2: Drive 2 3: Drive 3 4: Drive 4 5: Broadcast Messages (run command and frequency reference)	When bit 0 to 3 = 0, access is enabled for broadcast messages only. When bit 0 to 3 = 5, access is enabled for Run command and frequency reference broadcast messages only. Drive 0 is excluded.
	bit 4	0: Read, 1: Write	
	bit 5 - F	Reserved	
	15CF	Register number	
15D0	Data (write register)		

Table 12.45 Monitor Data

Register No. (Hex.)	Description		
15E7	Drive Status (Drive 1)		
	bit 0	During Run	
	bit 1	During Reverse Run	
	bit 2	Drive ready	
	bit 3	Fault	
	bit 4	Frequency Reference Setting Fault	1: Upper/Lower Limit Fault
	bit 5	No response from slave	1: Response has timed out.
	bit 6	Communication Error	1: The drive detected a fault from a slave.
	bit 7	No response from slave 10 consecutive attempts.	1: Timeout occurred 10 consecutive times.
	bit 8	Communication fault occurred 10 consecutive times.	1: Fault has occurred from a slave 10 consecutive times.
	bit 9	Receive broadcast command while drive is running	1: Drive operates as specified by the broadcast message command.
	bit A	Communication error with master drive	1: The slave cannot communicate with the master because of a communication error.
	bit B - D	Reserved	
	bit E	ComRef status	
bit F	ComCtrl status		
15E8	Output frequency or frequency reference (Drive Status Bit 1: ON) (Drive 1) Drive Status Bit 4 = 0 [Output Frequency] Drive Status Bit 4 = 1 [Frequency Reference]	The unit of measure changes when <i>o1-03</i> changes. Outputs when: <ul style="list-style-type: none"> <li>• Normal operation: Output frequency</li> <li>• Drive detects Frequency Reference Setting Fault: Frequency reference when the error occurs</li> </ul> Clears the value when the drive detects a communication error or communication stops.	
15E9	Drive Status (Drive 2)	Refer to "15E7: Drive Status (Drive 1)" for more information.	
15EA	Output frequency or frequency reference (Drive Status Bit 4: ON) (Drive 2)	The unit of measure changes when <i>o1-03</i> changes. Outputs when: <ul style="list-style-type: none"> <li>• Normal operation: Output frequency</li> <li>• Drive detects Frequency Reference Setting Fault: Frequency reference when the error occurs</li> </ul> Clears the value when the drive detects a communication error or communication stops.	
15EB	Drive Status (Drive 3)	Refer to "15E7: Drive Status (Drive 1)" for more information.	
15EC	Output frequency or frequency reference (Drive Status Bit 4: ON) (Drive 3)	The unit of measure changes when <i>o1-03</i> changes. Outputs when: <ul style="list-style-type: none"> <li>• Normal operation: Output frequency</li> <li>• Drive detects Frequency Reference Setting Fault: Frequency reference when the error occurs</li> </ul> Clears the value when the drive detects a communication error or communication stops.	
15ED	Drive Status (Drive 4)	Refer to "15E7: Drive Status (Drive 1)" for more information.	
15EE	Output frequency or frequency reference (Drive Status Bit 4: ON) (Drive 4)	The unit of measure changes when <i>o1-03</i> changes. Outputs when: <ul style="list-style-type: none"> <li>• Normal operation: Output frequency</li> <li>• Drive detects Frequency Reference Setting Fault: Frequency reference when the error occurs</li> </ul> Clears the value when the drive detects a communication error or communication stops.	

Register No. (Hex.)	Description	
15EF	Slave Address for Reg. Access + During MEMOBUS process & ErrCode	
	bit 0 bit 1 bit 2 bit 3 bit 4 bit 5 bit 6 bit 7	00H: MEMOBUS/Modbus Communication Complete 02H: Register number not registered 21H: Upper/Lower Limit Fault 22H: Write Mode Error 23H: Write performed during <i>U<sub>v</sub></i> 24H: Write performed while writing parameter settings FFH: During MEMOBUS/Modbus Communication
	bit 8 bit 9 bit A	Slave address 0: Broadcast Messages (MEMOBUS) 1: Drive 1 2: Drive 2 3: Drive 3 4: Drive 4 5: Broadcast Messages (run command and frequency reference)
	bit B - F	Reserved
15F0	Register number	
15F1	Data (write register)	

■ **F6-01: Communication Error Selection**

No. (Hex.)	Name	Description	Default (Range)
F6-01 (03A2)	Communication Error Selection	   Sets the method to stop the motor or let the motor continue operating when the drive detects <i>bUS</i> [Option Communication Error].	1 (0 - 5)

**0 : Ramp to Stop**

The drive ramps the motor to stop in the deceleration time. Fault relay output terminal MA-MC turns ON, and MB-MC turns OFF.

**1 : Coast to Stop**

The output turns off and the motor coasts to stop. Fault relay output terminal MA-MC turns ON, and MB-MC turns OFF.

**2 : Fast Stop (Use C1-09)**

The drive stops the motor in the deceleration time set in *C1-09* [Fast Stop Time]. Fault relay output terminal MA-MC turns ON, and MB-MC turns OFF.

**3 : Alarm Only**

The keypad shows *bUS* and the drive continues operation at the current frequency reference.

**Note:**

Separately prepare safety protection equipment and systems, for example fast stop switches.

The output terminal set for *Alarm* [*H2-01 to H2-03 = 10*] activates.

**4 : Alarm (Run at d1-04)**

The keypad shows *bUS* and the drive continues operation at the speed set in *d1-04* [Reference 4].

**Note:**

Separately prepare safety protection equipment and systems, for example fast stop switches.

**5 : Alarm - Ramp Stop**

The drive stops the motor in the deceleration time set in *C1-02* [Deceleration Time 1].

After you remove the *bUS* alarm, the motor will accelerate to the frequency reference you set before.

### ■ F6-02: Comm External Fault (EF0) Detect

No. (Hex.)	Name	Description	Default (Range)
F6-02 (03A3)	Comm External Fault (EF0) Detect	<input checked="" type="checkbox"/> V/f <input checked="" type="checkbox"/> OLV/PM <input checked="" type="checkbox"/> EZOLV Sets the conditions at which <i>EF0</i> [Option Card External Fault] is detected.	0 (0, 1)

**0 : Always Detected**

**1 : Detected during RUN Only**

### ■ F6-03: Comm External Fault (EF0) Select

No. (Hex.)	Name	Description	Default (Range)
F6-03 (03A4)	Comm External Fault (EF0) Select	<input checked="" type="checkbox"/> V/f <input checked="" type="checkbox"/> OLV/PM <input checked="" type="checkbox"/> EZOLV Sets the method to stop the motor or let the motor continue operating when the drive detects an <i>EF0</i> [Option Card External Fault].	1 (0 - 3)

**0 : Ramp to Stop**

The drive ramps the motor to stop in the deceleration time. Fault relay output terminal MA-MC turns ON, and MB-MC turns OFF.

**1 : Coast to Stop**

The output turns off and the motor coasts to stop. Fault relay output terminal MA-MC turns ON, and MB-MC turns OFF.

**2 : Fast Stop (Use C1-09)**

The drive stops the motor in the deceleration time set in *C1-09* [Fast Stop Time]. Fault relay output terminal MA-MC turns ON, and MB-MC turns OFF.

**3 : Alarm Only**

The keypad shows *EF0* and the drive continues operation.

**Note:**

Separately prepare safety protection equipment and systems, for example fast stop switches.

The output terminal set for *Alarm* [H2-01 to H2-03 = 10] activates.

### ■ F6-04: bUS Error Detection Time

No. (Hex.)	Name	Description	Default (Range)
F6-04 (03A5)	bUS Error Detection Time	<input checked="" type="checkbox"/> V/f <input checked="" type="checkbox"/> OLV/PM <input checked="" type="checkbox"/> EZOLV Sets the delay time for the drive to detect <i>bUS</i> [Option Communication Error].	2.0 s (0.0 - 5.0 s)

**Note:**

When you install an option card in the drive, the parameter value changes to 0.0 s.

### ■ F6-06: Torque Reference/Limit by Comm

No. (Hex.)	Name	Description	Default (Range)
F6-06 (03A7)	Torque Reference/Limit by Comm	<input type="checkbox"/> V/f <input checked="" type="checkbox"/> OLV/PM <input checked="" type="checkbox"/> EZOLV Sets the function that enables and disables the torque reference and torque limit received from the communication option.	0 (0, 1)

**0 : Disabled**

**1 : Enabled**

### ■ F6-07: Multi-Step Ref @ NetRef/ComRef

No. (Hex.)	Name	Description	Default (Range)
F6-07 (03A8)	Multi-Step Ref @ NetRef/ComRef	<div style="display: flex; gap: 5px;"> <span style="background-color: black; color: white; padding: 2px;">V/f</span> <span style="background-color: black; color: white; padding: 2px;">OLV/PM</span> <span style="background-color: black; color: white; padding: 2px;">EZOLV</span> </div> Sets the function that enables and disables the multi-step speed reference when the frequency reference source is NetRef or ComRef (communication option card or MEMOBUS/Modbus communications).	0 (0, 1)

#### 0 : Disable Multi-Step References

When NetRef or ComRef are the frequency reference source, the multi-step speed reference (2-step speed to 16-step speed references) and the Jog Frequency Reference (JOG command) are disabled.

#### 1 : Enable Multi-Step References

When NetRef or ComRef are the frequency reference source, the multi-step speed reference (2-step speed through 16-step speed references) and the Jog Frequency Reference (JOG command) are enabled, and you can change the frequency reference.

### ■ F6-08: Comm Parameter Reset @Initialize

No. (Hex.)	Name	Description	Default (Range)
F6-08 (036A)	Comm Parameter Reset @Initialize	<div style="display: flex; gap: 5px;"> <span style="background-color: black; color: white; padding: 2px;">V/f</span> <span style="background-color: black; color: white; padding: 2px;">OLV/PM</span> <span style="background-color: black; color: white; padding: 2px;">EZOLV</span> </div> Sets the function to initialize <i>F6-xx</i> and <i>F7-xx</i> parameters when the drive is initialized with <i>A1-03</i> [Initialize Parameters].	0 (0, 1)

#### 0 : No Reset - Parameters Retained

#### 1 : Reset Back to Factory Default

##### Note:

When you use *A1-03* to initialize the drive, this setting will not change.

### ■ F6-14: BUS Error Auto Reset

No. (Hex.)	Name	Description	Default (Range)
F6-14 (03BB)	BUS Error Auto Reset	<div style="display: flex; gap: 5px;"> <span style="background-color: black; color: white; padding: 2px;">V/f</span> <span style="background-color: black; color: white; padding: 2px;">OLV/PM</span> <span style="background-color: black; color: white; padding: 2px;">EZOLV</span> </div> Sets the automatic reset function for <i>bUS</i> [Option Communication Errors].	0 (0, 1)

#### 0 : Disable

#### 1 : Enabled

### ■ F6-15: Comm. Option Parameters Reload

No. (Hex.)	Name	Description	Default (Range)
F6-15 (0B5B)	Comm. Option Parameters Reload	<div style="display: flex; gap: 5px;"> <span style="background-color: black; color: white; padding: 2px;">V/f</span> <span style="background-color: black; color: white; padding: 2px;">OLV/PM</span> <span style="background-color: black; color: white; padding: 2px;">EZOLV</span> </div> Sets the update method when you change <i>F6-xx</i> , <i>F7-xx</i> [Communication Options].	0 (0 - 2)

##### Note:

- Set *F6-15* = 0, 1 to reload *F6-xx*, *F7-xx*.
- Set *F6-15* = 0, 1 to reset the display on the keypad to 0.

#### 0 : Reload at Next Power Cycle

Restart the drive to update parameters.

#### 1 : Reload Now

The changed parameters are updated without restarting the drive.

#### 2 : Cancel Reload Request

Cancels *CyPo* [Cycle Power to Accept Changes].

## ■ F6-16: Gateway Mode

No. (Hex.)	Name	Description	Default (Range)
F6-16 (0B8A)	Gateway Mode	<input type="checkbox"/> V/f <input type="checkbox"/> OLV/PM <input type="checkbox"/> EZOLV Sets the gateway mode operation and the number of connected slave drives.	0 (0 to 4)

**0 : Disabled**

**1 : Enabled: 1 Slave Drives**

**2 : Enabled: 2 Slave Drives**

**3 : Enabled: 3 Slave Drives**

**4 : Enabled: 4 Slave Drives**

## ■ F6-48: BACnet Device Object Identifier0

No. (Hex.)	Name	Description	Default (Range)
F6-48 (02FE)	BACnet Device Object Identifier0	<input type="checkbox"/> V/f <input type="checkbox"/> OLV/PM <input type="checkbox"/> EZOLV Sets the last word of BACnet communication addresses.	0 (0 - FFFF)

## ■ F6-49: BACnet Device Object Identifier1

No. (Hex.)	Name	Description	Default (Range)
F6-49 (02FF)	BACnet Device Object Identifier1	<input type="checkbox"/> V/f <input type="checkbox"/> OLV/PM <input type="checkbox"/> EZOLV Sets the last word of BACnet communication addresses.	0 (0 - 3F)

## ■ F7-01: IP Address 1

No. (Hex.)	Name	Description	Default (Range)
F7-01 (03E5)	IP Address 1	<input type="checkbox"/> V/f <input type="checkbox"/> OLV/PM <input type="checkbox"/> EZOLV Sets the first octet of the IP Address for the device that is connecting to the network. Restart the drive after you change this parameter.	192 (0 - 255)

**Note:**

When  $F7-13 = 0$  [Address Mode at Startup = Static]:

- Use parameters  $F7-01$  to  $F7-04$  [IP Address 1 to 4] to set the IP Address. Be sure to set a different IP address for each drive on the network.
- Also set parameters  $F7-05$  to  $F7-12$  [Subnet Mask 1 to 4, Gateway Address 1 to 4].

## ■ F7-02: IP Address 2

No. (Hex.)	Name	Description	Default (Range)
F7-02 (03E6)	IP Address 2	<input type="checkbox"/> V/f <input type="checkbox"/> OLV/PM <input type="checkbox"/> EZOLV Sets the second octet of the IP Address for the device that is connecting to the network. Restart the drive after you change this parameter.	168 (0 - 255)

**Note:**

When  $F7-13 = 0$  [Address Mode at Startup = Static]:

- Use parameters  $F7-01$  to  $F7-04$  [IP Address 1 to 4] to set the IP Address. Be sure to set a different IP address for each drive on the network.
- Also set parameters  $F7-05$  to  $F7-12$  [Subnet Mask 1 to 4, Gateway Address 1 to 4].

## ■ F7-03: IP Address 3

No. (Hex.)	Name	Description	Default (Range)
F7-03 (03E7)	IP Address 3	<input type="checkbox"/> V/f <input type="checkbox"/> OLV/PM <input type="checkbox"/> EZOLV Sets the third octet of the IP Address for the device that is connecting to the network. Restart the drive after you change this parameter.	1 (0 - 255)

**Note:**

When  $F7-13 = 0$  [Address Mode at Startup = Static]:

- Use parameters  $F7-01$  to  $F7-04$  [IP Address 1 to 4] to set the IP Address. Be sure to set a different IP address for each drive on the network.
- Also set parameters  $F7-05$  to  $F7-12$  [Subnet Mask 1 to 4, Gateway Address 1 to 4].

■ **F7-04: IP Address 4**

No. (Hex.)	Name	Description	Default (Range)
F7-04 (03E8)	IP Address 4	<div style="display: flex; gap: 5px;"> <span>V/f</span> <span>OLV/PM</span> <span>EZOLV</span> </div> Sets the fourth octet of the IP Address for the device that is connecting to the network. Restart the drive after you change this parameter.	20 (0 - 255)

**Note:**

When  $F7-13 = 0$  [Address Mode at Startup = Static]:

- Use parameters  $F7-01$  to  $F7-04$  [IP Address 1 to 4] to set the IP Address. Be sure to set a different IP address for each drive on the network.
- Also set parameters  $F7-05$  to  $F7-12$  [Subnet Mask 1 to 4, Gateway Address 1 to 4].

■ **F7-05: Subnet Mask 1**

No. (Hex.)	Name	Description	Default (Range)
F7-05 (03E9)	Subnet Mask 1	<div style="display: flex; gap: 5px;"> <span>V/f</span> <span>OLV/PM</span> <span>EZOLV</span> </div> Sets the first octet of the subnet mask of the connected network.	255 (0 - 255)

**Note:**

Set this parameter when  $F7-13 = 0$  [Address Mode at Startup = Static].

■ **F7-06: Subnet Mask 2**

No. (Hex.)	Name	Description	Default (Range)
F7-06 (03EA)	Subnet Mask 2	<div style="display: flex; gap: 5px;"> <span>V/f</span> <span>OLV/PM</span> <span>EZOLV</span> </div> Sets the second octet of the subnet mask of the connected network.	255 (0 - 255)

**Note:**

Set this parameter when  $F7-13 = 0$  [Address Mode at Startup = Static].

■ **F7-07: Subnet Mask 3**

No. (Hex.)	Name	Description	Default (Range)
F7-07 (03EB)	Subnet Mask 3	<div style="display: flex; gap: 5px;"> <span>V/f</span> <span>OLV/PM</span> <span>EZOLV</span> </div> Sets the third octet of the subnet mask of the connected network.	255 (0 - 255)

**Note:**

Set this parameter when  $F7-13 = 0$  [Address Mode at Startup = Static].

■ **F7-08: Subnet Mask 4**

No. (Hex.)	Name	Description	Default (Range)
F7-08 (03EC)	Subnet Mask 4	<div style="display: flex; gap: 5px;"> <span>V/f</span> <span>OLV/PM</span> <span>EZOLV</span> </div> Sets the fourth octet of the subnet mask of the connected network.	0 (0 - 255)

**Note:**

Set this parameter when  $F7-13 = 0$  [Address Mode at Startup = Static].

■ **F7-09: Gateway Address 1**

No. (Hex.)	Name	Description	Default (Range)
F7-09 (03ED)	Gateway Address 1	<div style="display: flex; gap: 5px;"> <span>V/f</span> <span>OLV/PM</span> <span>EZOLV</span> </div> Sets the first octet of the gateway address of the connected network.	192 (0 - 255)



**Note:**

Set this parameter when  $F7-13 = 0$  [Address Mode at Startup = Static].

**■ F7-10: Gateway Address 2**

No. (Hex.)	Name	Description	Default (Range)
F7-10 (03EE)	Gateway Address 2	<b>V/f</b> <b>OLV/PM</b> <b>EZOLV</b> Sets the second octet of the gateway address of the connected network.	168 (0 - 255)

**Note:**

Set this parameter when  $F7-13 = 0$  [Address Mode at Startup = Static].

**■ F7-11: Gateway Address 3**

No. (Hex.)	Name	Description	Default (Range)
F7-11 (03EF)	Gateway Address 3	<b>V/f</b> <b>OLV/PM</b> <b>EZOLV</b> Sets the third octet of the gateway address of the connected network.	1 (0 - 255)

**Note:**

Set this parameter when  $F7-13 = 0$  [Address Mode at Startup = Static].

**■ F7-12: Gateway Address 4**

No. (Hex.)	Name	Description	Default (Range)
F7-12 (03F0)	Gateway Address 4	<b>V/f</b> <b>OLV/PM</b> <b>EZOLV</b> Sets the fourth octet of the gateway address of the connected network.	1 (0 - 255)

**Note:**

Set this parameter when  $F7-13 = 0$  [Address Mode at Startup = Static].

**■ F7-13: Address Mode at Startup**

No. (Hex.)	Name	Description	Default (Range)
F7-13 (03F1)	Address Mode at Startup	<b>V/f</b> <b>OLV/PM</b> <b>EZOLV</b> Sets the method to set option card IP addresses.	2 (0 - 2)

**0 : Static****1 : BOOTP****2 : DHCP****Note:**

- The following setting values are available when using the PROFINET communication option card (SI-EP3).
  - 0: Static
  - 2: DCP
- When  $F7-13 = 0$ , set parameters  $F7-01$  to  $F7-12$  [IP Address 1 to Gateway Address 4] to set the IP Address. Be sure to set a different IP address for each drive on the network.

**■ F7-14: Duplex Mode Selection**

No. (Hex.)	Name	Description	Default (Range)
F7-14 (03F2)	Duplex Mode Selection	<b>V/f</b> <b>OLV/PM</b> <b>EZOLV</b> Sets the duplex mode setting method.	1 (0 - 8)

**0 : Half/Half****1 : Auto/Auto****2 : Full/Full****3 : Half/Auto**

Port 1 is set to “Half” and port 2 is set to “Auto”.

**4 : Half/Full**

Port 1 is set to “Half” and port 2 is set to “Full”.

**5 : Auto/Half**

Port 1 is set to “Auto” and port 2 is set to “Half”.

**6 : Auto/Full**

Port 1 is set to “Auto” and port 2 is set to “Full”.

**7 : Full/Half**

Port 1 is set to “Full” and port 2 is set to “Half”.

**8 : Full/Auto**

Port 1 is set to “Full” and port 2 is set to “Auto”.

**■ F7-15: Communication Speed Selection**

No. (Hex.)	Name	Description	Default (Range)
F7-15 (03F3)	Communication Speed Selection	<input type="radio"/> V/f <input type="radio"/> OLV/IPM <input type="radio"/> EZOLV Sets the communications speed.	10 (10, 100 - 102)

**10 : 10/10 Mbps**

**100 : 100/100 Mbps**

**101 : 10/100 Mbps**

**102 : 100/10 Mbps**

**Note:**

Set this parameter when  $F7-14 = 0$  or  $2$  [*Duplex Mode Selection = Half/Half or Full/Full*].

**■ F7-16: Timeout Value**

No. (Hex.)	Name	Description	Default (Range)
F7-16 (03F4)	Timeout Value	<input type="radio"/> V/f <input type="radio"/> OLV/IPM <input type="radio"/> EZOLV Sets the detection time for a communications timeout.	0.0 s (0.0 - 30.0 s)

**Note:**

Set this parameter to 0.0 to disable the connection timeout function.

**■ F7-17: EtherNet/IP Speed Scaling Factor**

No. (Hex.)	Name	Description	Default (Range)
F7-17 (03F5)	EtherNet/IP Speed Scaling Factor	<input type="radio"/> V/f <input type="radio"/> OLV/IPM <input type="radio"/> EZOLV Sets the scaling factor for the speed monitor in the EtherNet/IP Class ID 2AH Object.	0 (-15 - +15)

**■ F7-18: EtherNet/IP Current Scale Factor**

No. (Hex.)	Name	Description	Default (Range)
F7-18 (03F6)	EtherNet/IP Current Scale Factor	<input type="radio"/> V/f <input type="radio"/> OLV/IPM <input type="radio"/> EZOLV Sets the scaling factor for the output current monitor in the EtherNet/IP Class ID 2AH Object.	0 (-15 - +15)

**■ F7-19: EtherNet/IP Torque Scale Factor**

No. (Hex.)	Name	Description	Default (Range)
F7-19 (03F7)	EtherNet/IP Torque Scale Factor	<input type="radio"/> V/f <input type="radio"/> OLV/IPM <input type="radio"/> EZOLV Sets the scaling factor for the torque monitor in the EtherNet/IP Class ID 2AH Object.	0 (-15 - +15)

### ■ F7-20: EtherNet/IP Power Scaling Factor

No. (Hex.)	Name	Description	Default (Range)
F7-20 (03F8)	EtherNet/IP Power Scaling Factor	<b>V/f</b> <b>OLV/PM</b> <b>EZOLV</b> Sets the scaling factor for the power monitor in the EtherNet/IP Class ID 2AH Object.	0 (-15 - +15)

### ■ F7-21: EtherNet/IP Voltage Scale Factor

No. (Hex.)	Name	Description	Default (Range)
F7-21 (03F9)	EtherNet/IP Voltage Scale Factor	<b>V/f</b> <b>OLV/PM</b> <b>EZOLV</b> Sets the scaling factor for the voltage monitor in the EtherNet/IP Class ID 2AH Object.	0 (-15 - +15)

### ■ F7-22: EtherNet/IP Time Scaling

No. (Hex.)	Name	Description	Default (Range)
F7-22 (03FA)	EtherNet/IP Time Scaling	<b>V/f</b> <b>OLV/PM</b> <b>EZOLV</b> Sets the scaling factor for the time monitor in the EtherNet/IP Class ID 2AH Object.	0 (-15 - +15)

### ■ F7-23 to F7-32: Dynamic Out Param 1 to 10 for CommCard

No. (Hex.)	Name	Description	Default (Range)
F7-23 to F7-27 (03FB - 03FF) F7-28 to F7-32 (0370 - 0374)	Dynamic Out Param 1 to 10 for CommCard	<b>V/f</b> <b>OLV/PM</b> <b>EZOLV</b> When you use an Ethernet/IP option, sets Output Assembly 116. The drive writes the values from Output Assembly 116 to the MEMOBUS/Modbus address register that is stored for each parameter. The drive will not write the values from Output Assembly 116 to the registers when the MEMOBUS/Modbus address is 0. When you use a ProfiNet option, set <i>F7-23</i> to <i>F7-27</i> to configurable Output 1-5.	0

### ■ F7-33 to F7-42: Dynamic In Param 1 to 10 for CommCard

No. (Hex.)	Name	Description	Default (Range)
F7-33 to F7-42 (0375 - 037E)	Dynamic In Param 1 to 10 for CommCard	<b>V/f</b> <b>OLV/PM</b> <b>EZOLV</b> When you use an Ethernet/IP option, sets Input Assembly 166. The drive sends the values from the MEMOBUS/Modbus address registers stored for each parameter to Input Assembly 166. The drive returns the default register value for the option card when the MEMOBUS/Modbus address is 0 and the value sent to Input Assembly 166 is not defined. When you use a ProfiNet option, set <i>F7-33</i> to <i>F7-37</i> to configurable inputs 1-5.	0

### ■ F7-50: BACnet/IP Port #

No. (Hex.)	Name	Description	Default (Range)
F7-50 (1BC1)	BACnet/IP Port #	<b>V/f</b> <b>OLV/PM</b> <b>EZOLV</b> Sets the UDP port on which the drive will receive incoming BACnet messages.	47808 (1024 - 65535)

### ■ F7-51: BBMD Foreign Register Addr 1

No. (Hex.)	Name	Description	Default (Range)
F7-51 (1BE9)	BBMD Foreign Register Addr 1	<b>V/f</b> <b>OLV/PM</b> <b>EZOLV</b> Sets the first octet of the IP Address of the BBMD device to which this unit will register as a foreign device.	0 (0 - 255)

### ■ F7-52: BBMD Foreign Register Addr 2

No. (Hex.)	Name	Description	Default (Range)
F7-52 (1BEA)	BBMD Foreign Register Addr 2	<b>V/f</b> <b>OLV/PM</b> <b>EZOLV</b> Sets the second octet of the IP Address of the BBMD device to which this unit will register as a foreign device.	0 (0 - 255)

### ■ F7-53: BBMD Foreign Register Addr 3

No. (Hex.)	Name	Description	Default (Range)
F7-53 (1BEB)	BBMD Foreign Register Addr 3	<input type="checkbox"/> V/f <input type="checkbox"/> OLV/IPM <input type="checkbox"/> EZOLV Sets the third octet of the IP Address of the BBMD device to which this unit will register as a foreign device.	0 (0 - 255)

### ■ F7-54: BBMD Foreign Register Addr 4

No. (Hex.)	Name	Description	Default (Range)
F7-54 (1BEC)	BBMD Foreign Register Addr 4	<input type="checkbox"/> V/f <input type="checkbox"/> OLV/IPM <input type="checkbox"/> EZOLV Sets the fourth octet of the IP Address of the BBMD device to which this unit will register as a foreign device.	0 (0 - 255)

### ■ F7-55: BBMD Foreign Register Port #

No. (Hex.)	Name	Description	Default (Range)
F7-55 (1BED)	BBMD Foreign Register Port #	<input type="checkbox"/> V/f <input type="checkbox"/> OLV/IPM <input type="checkbox"/> EZOLV Sets the UDP port of the BBMD device to which this unit will register.	47808 (1024 - 65535)

### ■ F7-56: BBMD Foreign Register Time

No. (Hex.)	Name	Description	Default (Range)
F7-56 (1BEE)	BBMD Foreign Register Time	<input type="checkbox"/> V/f <input type="checkbox"/> OLV/IPM <input type="checkbox"/> EZOLV Sets the time interval in which this unit will repeat BBMD foreign registration.	3600 s (0 - 65535 s)

### ■ F7-57: BACnet/IP bUS Timeout Value

No. (Hex.)	Name	Description	Default (Range)
F7-57 (1BEF)	BACnet/IP bUS Timeout Value	<input type="checkbox"/> V/f <input type="checkbox"/> OLV/IPM <input type="checkbox"/> EZOLV Sets the length of time that this unit will wait after it receives a Run command or frequency reference command before it detects a <i>bUS</i> fault.	3600 s (0 - 65535 s)

## 12.8 H: Terminal Functions

*H* parameters are used to assign functions to external input and output terminals.

### ◆ H1: Digital Inputs

*H1* Parameters set the MFDI terminal functions.

#### ■ H1-01 to H1-07 Terminal S1 to S7 Function Selection

The drive has 7 MFDI terminals. Refer to [Table 12.46](#) for drive default settings and functions.

**Table 12.46 MFDI Default Settings and Functions**

No.	Name	Default	Function
H1-01	Terminal S1 Function Selection	40 (F) <i>*1</i>	Forward RUN (2-Wire)
H1-02	Terminal S2 Function Selection	F <i>*1</i>	Not Used
H1-03	Terminal S3 Function Selection	24	External Fault (NO-Always-Coast)
H1-04	Terminal S4 Function Selection	14	Fault Reset
H1-05	Terminal S5 Function Selection	3 (0) <i>*1</i>	Multi-Step Speed Reference 1
H1-06	Terminal S6 Function Selection	4 (3) <i>*1</i>	Multi-Step Speed Reference 2
H1-07	Terminal S7 Function Selection	6 (4) <i>*1</i>	Jog Reference Selection

\*1 The value in parentheses identifies the default setting when you set *A1-03* = 3330 [*Initialize Parameters* = 3-Wire Initialization]. Refer to [Table 12.47](#) and use *H1-xx* [*MFDI Function Select*] to set the function.

**Table 12.47 MFDI Setting Values**

Setting Value	Function	Reference	Setting Value	Function	Reference
0	3-Wire Sequence	732	19	PID Disable	740
3	Multi-Step Speed Reference 1	733	1B	Programming Lockout	740
4	Multi-Step Speed Reference 2	733	1E	Reference Sample Hold	740
5	Multi-Step Speed Reference 3	734	20 to 2F	External Fault	741
6	Jog Reference Selection	734	30	PID Integrator Reset	742
7	Accel/Decel Time Selection 1	734	31	PID Integrator Hold	742
8	Baseblock Command (N.O.)	734	34	PID Soft Starter Disable	742
9	Baseblock Command (N.C.)	734	35	PID Input (Error) Invert	742
A	Accel/Decel Ramp Hold	735	3E	PID Setpoint Selection 1	743
B	Overheat Alarm (oH2)	735	3F	PID Setpoint Selections 2	743
C	Analog Terminal Enable Selection	735	40	Forward RUN (2-Wire)	743
E	ASR Integral Reset	735	41	Reverse RUN (2-Wire)	743
F	Not Used	735	42	Run Command (2-Wire Sequence 2)	744
10	Up Command	735	43	FWD/REV (2-Wire Sequence 2)	744
11	Down Command	737	44	Add Offset Frequency 1 (d7-01)	744
12	Forward Jog	738	45	Add Offset Frequency 2 (d7-02)	744
13	Reverse Jog	738	46	Add Offset Frequency 3 (d7-03)	744
14	Fault Reset Procedure	738	50	Motor Pre-heat 2	745
15	Fast Stop (N.O.)	738	51	Sequence Timer Disable	745
16	Motor 2 Selection	739	52	Sequence Timer Cancel	745
17	Fast Stop (N.C.)	739	60	DC Injection Braking Command	745
18	Timer Function	740	61	Speed Search from Fmax	745

## 12.8 H: Terminal Functions

Setting Value	Function	Reference
62	Speed Search from Fref	746
63	Field Weakening	746
65	KEB Ride-Thru 1 Activate (N.C.)	746
66	KEB Ride-Thru 1 Activate (N.O.)	746
67	Communications Test Mode	747
68	High Slip Braking (HSB) Activate	747
69	Jog Run 2	747
6A	Drive Enable	747
6D	AUTO Command	747
6E	HAND Command	748
70	Drive Enable 2	748
77	ASR Gain (C5-03) Select	748
7A	KEB Ride-Thru 2 Activate (N.C.)	748
7B	KEB Ride-Thru 2 Activate (N.O.)	749
7C	Short Circuit Braking (N.O.)	749
7D	Short Circuit Braking (N.C.)	749
82	PI Switch to Aux	749
83	Dedicated Multi-Setpoint YA-02	749
84	Dedicated Multi-Setpoint YA-03	750

Setting Value	Function	Reference
85	Dedicated Multi-Setpoint YA-04	750
88	Thermostat Fault	750
90 to 96	DWEZ Digital Inputs 1 to 7	750
9F	DWEZ Disable	750
A8	PI2 Control Disable	751
AA	PI2 Control Inverse Operation	751
AB	PI2 Control Integral Reset	751
AC	PI2 Control Integral Hold	751
AD	Select PI2 Control PI Parameters	751
AF	Emergency Override FWD	751
B0	Emergency Override REV	751
B1	Customer Safeties	751
B2	BAS Interlock	752
B8	Low City Pressure	752
B9	Disable Pre-charge	752
188 to 1B8	Inverse Inputs of 88, A8, and B8 Sets the function of the selected MFDI to operate inversely. To select the function for inverse input, enter two digits of 88, A8, or B8 for the "xx" in "1xx".	752

### ■ H1-01: Terminal S1 Function Selection

No. (Hex.)	Name	Description	Default (Range)
H1-01 (0438)	Terminal S1 Function Selection	<input type="checkbox"/> V/f <input type="checkbox"/> OLV/IPM <input type="checkbox"/> EZOLV Sets the function for MFDI terminal S1.	40 (1 - 1FF)

**Note:**

The default setting is *F* when you initialize the drive for *3-Wire Initialization* [*A1-03* = 3330].

### ■ H1-02: Terminal S2 Function Selection

No. (Hex.)	Name	Description	Default (Range)
H1-02 (0439)	Terminal S2 Function Selection	<input type="checkbox"/> V/f <input type="checkbox"/> OLV/IPM <input type="checkbox"/> EZOLV Sets the function for MFDI terminal S2.	<i>F</i> (1 - 1FF)

**Note:**

The default setting is *F* when you initialize the drive for *3-Wire Initialization* [*A1-03* = 3330].

### ■ H1-03: Terminal S3 Function Selection

No. (Hex.)	Name	Description	Default (Range)
H1-03 (0400)	Terminal S3 Function Selection	<input type="checkbox"/> V/f <input type="checkbox"/> OLV/IPM <input type="checkbox"/> EZOLV Sets the function for MFDI terminal S3.	24 (0 - 1FF)

### ■ H1-04: Terminal S4 Function Selection

No. (Hex.)	Name	Description	Default (Range)
H1-04 (0401)	Terminal S4 Function Selection	<input type="checkbox"/> V/f <input type="checkbox"/> OLV/IPM <input type="checkbox"/> EZOLV Sets the function for MFDI terminal S4.	14 (0 - 1FF)

### ■ H1-05: Terminal S5 Function Selection

No. (Hex.)	Name	Description	Default (Range)
H1-05 (0402)	Terminal S5 Function Selection	<b>V/f</b> <b>OLV/PM</b> <b>EZOLV</b> Sets the function for MFDI terminal S5.	3 (0 - 1FF)

**Note:**

The default setting is 0 when the drive is initialized for 3-Wire Initialization [A1-03 = 3330].

### ■ H1-06: Terminal S6 Function Selection

No. (Hex.)	Name	Description	Default (Range)
H1-06 (0403)	Terminal S6 Function Selection	<b>V/f</b> <b>OLV/PM</b> <b>EZOLV</b> Sets the function for MFDI terminal S6.	4 (0 - 1FF)

**Note:**

The default setting is 3 when the drive is initialized for 3-Wire Initialization [A1-03 = 3330].

### ■ H1-07: Terminal S7 Function Selection

No. (Hex.)	Name	Description	Default (Range)
H1-07 (0404)	Terminal S7 Function Selection	<b>V/f</b> <b>OLV/PM</b> <b>EZOLV</b> Sets the function for MFDI terminal S7.	6 (0 - 1FF)

**Note:**

The default setting is 4 when the drive is initialized for 3-Wire Initialization [A1-03 = 3330].

### ■ MEMOBUS/Modbus MFDI 1 to MFDI3 Function Selection

You can set the function for the MFDI to MEMOBUS register *bit 0 to 2 of [15C0(Hex.)]*. Use H1-40 to H1-42 [Mbus Reg 15C0h bit0 to bit 2 Input Func] to select the function.

**Note:**

- Refer to H1-xx “MFDI setting values” for the setting values of the MFDI.
- You cannot set 0 [3-Wire Sequence] or 20 to 2F [External Fault] in H1-40 to H1-42.
- When you will not use H1-40 to H1-42, set them to F [Not Used].

### ■ H1-40: Mbus Reg 15C0h bit0 Input Func

No. (Hex.)	Name	Description	Default (Range)
H1-40 (0B54)	Mbus Reg 15C0h bit0 Input Func	<b>V/f</b> <b>OLV/PM</b> <b>EZOLV</b> Sets the MFDI function assigned to <i>bit 0</i> of the MEMOBUS register 15C0 (Hex.).	F (1 - 1FF)

### ■ H1-41: Mbus Reg 15C0h bit1 Input Func

No. (Hex.)	Name	Description	Default (Range)
H1-41 (0B55)	Mbus Reg 15C0h bit1 Input Func	<b>V/f</b> <b>OLV/PM</b> <b>EZOLV</b> Sets the MFDI function assigned to <i>bit 1</i> of the MEMOBUS register 15C0 (Hex.).	F (1 - 1FF)

### ■ H1-42: Mbus Reg 15C0h bit2 Input Func

No. (Hex.)	Name	Description	Default (Range)
H1-42 (0B56)	Mbus Reg 15C0h bit2 Input Func	<b>V/f</b> <b>OLV/PM</b> <b>EZOLV</b> Sets the MFDI function assigned to <i>bit 2</i> of the MEMOBUS register 15C0 (Hex.).	F (1 - 1FF)

### ■ MFDI ON/OFF Time Delay

This function supplies an ON/OFF Delay to all MFDIs. To use this function, set parameters *H1-61 to H1-67* [Terminal Sx On-Delay Time] and *H1-71 to H1-77* [Terminal Sx Off-Delay Time].

**WARNING! Crush Hazard.** Make sure that the settings for *H1-61 to H1-67* [Terminal Sx On-Delay Time] and *H1-71 to H1-77* [Terminal Sx Off-Delay Time] are correct when you interface the drive with a safety process. The drive also applies the time delay settings to the safety functions, for example, Emergency Override and Baseblock. Incorrect time delay settings can cause serious injury or death from malfunction of the safety functions.

When the terminal is ON, the function set to that terminal activates after the ON-delay timer for the terminal is expired. The terminal will reset the ON-delay timer when the terminal is OFF.

When the terminal is OFF and the function is active, the function will run until the OFF-delay timer is expired. The terminal will reset the OFF-delay timer when the terminal is ON again.

The ON-delay and OFF-delay timers also have an effect on *UI-10* [Input Terminal Status]. When the ON-delay is expired and the function is active, the drive sets the applicable bits. When the OFF-delay is expired and the function deactivates, the drive resets the bits.

**Note:**

The ON-delay timer does not apply when the inputs are ON at power-up.

Figure 12.48 shows drive operation when you apply ON/OFF-Delay Timers to the MFDI set for *H1-xx = 6E* [HAND Command] in these conditions:

- *S5-02 = 1* [HAND/AUTO Switchover During Run = Enabled]
- *S5-04 ≠ 0* [HAND-OFF-AUTO Behavior ≠ Legacy]

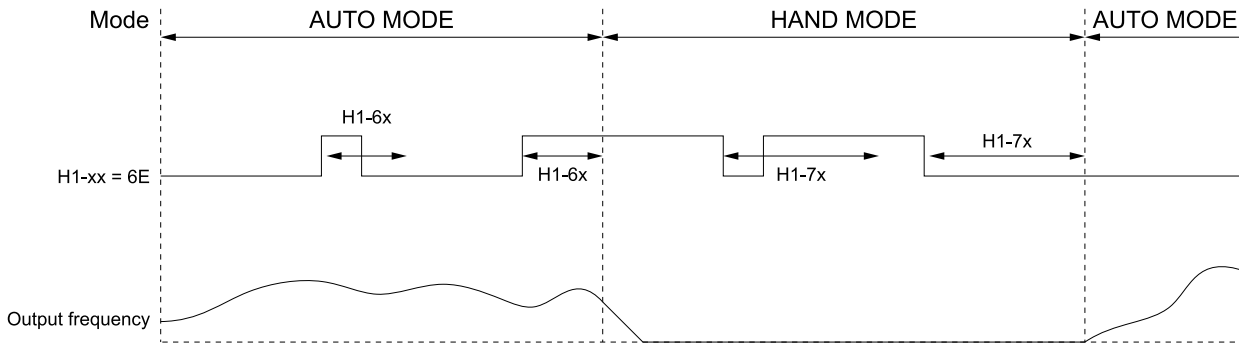

Figure 12.48 Example of ON-Delay and OFF-Delay Timers

### Inverse Multi-Function Digital Inputs

For inverse MFDIs (*H1-xx > 100*), the delay timers use the inverse condition of the digital input.

When a terminal is OFF, the function set to that terminal activates after the ON-delay timer for the terminal is expired. The terminal will reset the ON-delay timer when the terminal is ON.

When the terminal is ON and the function is active, the function will run until the OFF-delay timer is expired. The terminal will reset the OFF-delay timer when the terminal is OFF again.

**Note:**

If you change a terminal function selection between an inverse and a non-inverse digital input selection while an ON-delay or OFF-delay timer is active, the new delay timer will not go into effect until the current ON-delay or OFF-delay timer is expired, and the digital input changes to ON or OFF.

### ■ H1-61: Terminal S1 On-Delay Time

No. (Hex.)	Name	Description	Default (Range)
H1-61 (39E1) RUN	Terminal S1 On-Delay Time	<span style="background-color: black; color: white; padding: 2px;">V/f</span> <span style="background-color: black; color: white; padding: 2px;">OLV/PM</span> <span style="background-color: black; color: white; padding: 2px;">EZOLV</span> Sets the length of time necessary for Terminal S1 to be closed before the drive does the programmed function.	0.00 s (0.00 - 300.00 s)



### ■ H1-62: Terminal S2 On-Delay Time

No. (Hex.)	Name	Description	Default (Range)
H1-62 (39E2) RUN	Terminal S2 On-Delay Time	<b>V/f</b> <b>OLV/PM</b> <b>EZOLV</b> Sets the length of time necessary for Terminal S2 to be closed before the drive does the programmed function.	0.00 s (0.00 - 300.00 s)

### ■ H1-63: Terminal S3 On-Delay Time

No. (Hex.)	Name	Description	Default (Range)
H1-63 (39E3) RUN	Terminal S3 On-Delay Time	<b>V/f</b> <b>OLV/PM</b> <b>EZOLV</b> Sets the length of time necessary for Terminal S3 to be closed before the drive does the programmed function.	0.00 s (0.00 - 300.00 s)

### ■ H1-64: Terminal S4 On-Delay Time

No. (Hex.)	Name	Description	Default (Range)
H1-64 (39E4) RUN	Terminal S4 On-Delay Time	<b>V/f</b> <b>OLV/PM</b> <b>EZOLV</b> Sets the length of time necessary for Terminal S4 to be closed before the drive does the programmed function.	0.00 s (0.00 - 300.00 s)

### ■ H1-65: Terminal S5 On-Delay Time

No. (Hex.)	Name	Description	Default (Range)
H1-65 (39E5) RUN	Terminal S5 On-Delay Time	<b>V/f</b> <b>OLV/PM</b> <b>EZOLV</b> Sets the length of time necessary for Terminal S5 to be closed before the drive does the programmed function.	0.00 s (0.00 - 300.00 s)

### ■ H1-66: Terminal S6 On-Delay Time

No. (Hex.)	Name	Description	Default (Range)
H1-66 (39E6) RUN	Terminal S6 On-Delay Time	<b>V/f</b> <b>OLV/PM</b> <b>EZOLV</b> Sets the length of time necessary for Terminal S6 to be closed before the drive does the programmed function.	0.00 s (0.00 - 300.00 s)

### ■ H1-67: Terminal S7 On-Delay Time

No. (Hex.)	Name	Description	Default (Range)
H1-67 (39E7) RUN	Terminal S7 On-Delay Time	<b>V/f</b> <b>OLV/PM</b> <b>EZOLV</b> Sets the length of time necessary for Terminal S7 to be closed before the drive does the programmed function.	0.00 s (0.00 - 300.00 s)

### ■ H1-71: Terminal S1 Off-Delay Time

No. (Hex.)	Name	Description	Default (Range)
H1-71 (39E8) RUN	Terminal S1 Off-Delay Time	<b>V/f</b> <b>OLV/PM</b> <b>EZOLV</b> Sets the length of time necessary for Terminal S1 to be open before the drive removes the programmed function.	0.00 s (0.00 - 300.00 s)

### ■ H1-72: Terminal S2 Off-Delay Time

No. (Hex.)	Name	Description	Default (Range)
H1-72 (39EC) RUN	Terminal S2 Off-Delay Time	<b>V/f</b> <b>OLV/PM</b> <b>EZOLV</b> Sets the length of time necessary for Terminal S2 to be open before the drive removes the programmed function.	0.00 s (0.00 - 300.00 s)

### ■ H1-73: Terminal S3 Off-Delay Time

No. (Hex.)	Name	Description	Default (Range)
H1-73 (39ED) RUN	Terminal S3 Off-Delay Time	<b>V/f</b> <b>OLV/PM</b> <b>EZOLV</b> Sets the length of time necessary for Terminal S3 to be open before the drive removes the programmed function.	0.00 s (0.00 - 300.00 s)

### ■ H1-74: Terminal S4 Off-Delay Time

No. (Hex.)	Name	Description	Default (Range)
H1-74 (39EE) RUN	Terminal S4 Off-Delay Time	<b>V/f</b> <b>OLV/PM</b> <b>EZOLV</b> Sets the length of time necessary for Terminal S4 to be open before the drive removes the programmed function.	0.00 s (0.00 - 300.00 s)

### ■ H1-75: Terminal S5 Off-Delay Time

No. (Hex.)	Name	Description	Default (Range)
H1-75 (39EF) RUN	Terminal S5 Off-Delay Time	<b>V/f</b> <b>OLV/PM</b> <b>EZOLV</b> Sets the length of time necessary for Terminal S5 to be open before the drive removes the programmed function.	0.00 s (0.00 - 300.00 s)

### ■ H1-76: Terminal S6 Off-Delay Time

No. (Hex.)	Name	Description	Default (Range)
H1-76 (39F0) RUN	Terminal S6 Off-Delay Time	<b>V/f</b> <b>OLV/PM</b> <b>EZOLV</b> Sets the length of time necessary for Terminal S6 to be open before the drive removes the programmed function.	0.00 s (0.00 - 300.00 s)

### ■ H1-77: Terminal S7 Off-Delay Time

No. (Hex.)	Name	Description	Default (Range)
H1-77 (39F1) RUN	Terminal S7 Off-Delay Time	<b>V/f</b> <b>OLV/PM</b> <b>EZOLV</b> Sets the length of time necessary for Terminal S7 to be open before the drive removes the programmed function.	0.00 s (0.00 - 300.00 s)

## ◆ MFDI Setting Value

Selects a function set with *H1-01 to H1-07*.

### ■ 0: 3-Wire Sequence

Setting Value	Function	Description
0	3-Wire Sequence	<b>V/f</b> <b>OLV/PM</b> <b>EZOLV</b> Sets the direction of motor rotation for 3-wire sequence.

If the 3-wire sequence is set to a terminal that is not MFDI terminals S1 and S2, these terminals will be the input terminals for Forward run/Reverse run command. The drive will automatically set terminal S1 to Run command (RUN) and terminal S2 to Stop command (STOP).

When terminal S1 (Run command) activates for 1 ms minimum, the drive rotates the motor. When terminal S2 (Stop command) deactivates, the drive stops. When terminal Sx that is set in 3-wire sequence deactivates, the drive operates in the forward direction, and when it activates, the drive operates in the reverse direction.

**WARNING! Sudden Movement Hazard.** Set the MFDI parameters before you close control circuit switches. Incorrect Run/Stop circuit sequence settings can cause serious injury or death from moving equipment.

**WARNING! Sudden Movement Hazard.** When you use a 3-Wire sequence, set A1-03 = 3330 [Initialize Parameters = 3-Wire Initialization] and make sure that b1-17 = 0 [Run Command at Power Up = Disregard Existing RUN Command] (default). If you do not correctly set the drive parameters for 3-Wire operation before you energize the drive, the motor can suddenly rotate when you energize the drive.

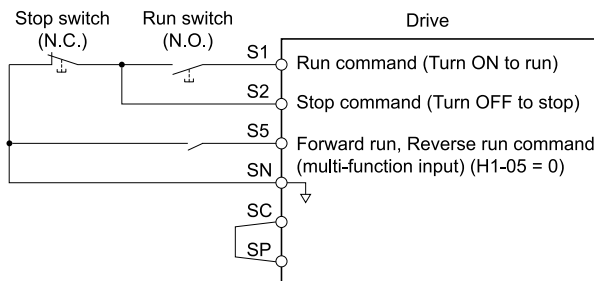

Figure 12.49 3-Wire Sequence Wiring Example

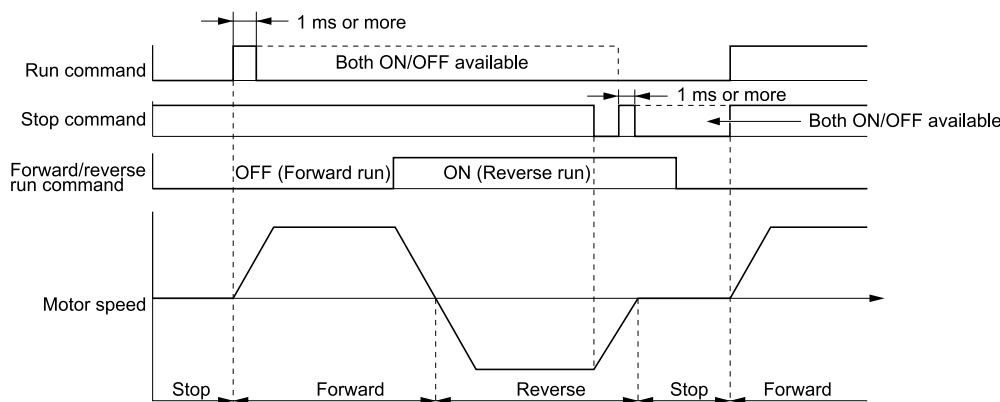





Figure 12.50 3-Wire Sequence Time Chart

**Note:**

- To input the Run command, activate the terminal for 1 ms minimum.
- The default setting for b1-17 [Run Command at Power Up] is 0 [Disregard Existing RUN command]. If you enable the Run command when the drive is energized, the protective function activates and the  flashes quickly. When the application allows Run, set b1-17 = 1 [Accept Existing RUN Command].



**3: Multi-Step Speed Reference 1**

Setting Value	Function	Description
3	Multi-Step Speed Reference 1	   Uses speed references d1-01 to d1-08 to set a multi-step speed reference.

**Note:**

Refer to “Setting Procedures for Multi-step Speed Operation” in “d: Reference Settings” for more information.

**4: Multi-Step Speed Reference 2**

Setting Value	Function	Description
4	Multi-Step Speed Reference 2	   Uses speed references d1-01 to d1-08 to set a multi-step speed reference.

**Note:**

Refer to “Setting Procedures for Multi-step Speed Operation” in “d: Reference Settings” for more information.

### 5: Multi-Step Speed Reference 3

Setting Value	Function	Description
5	Multi-Step Speed Reference 3	<b>V/f</b> <b>OLV/IPM</b> <b>EZOLV</b> Uses speed references <i>d1-01</i> to <i>d1-08</i> to set a multi-step speed reference.

**Note:**

Refer to “Setting Procedures for Multi-step Speed Operation” in “d: Reference Settings” for more information.

### 6: Jog Reference Selection

Setting Value	Function	Description
6	Jog Reference Selection	<b>V/f</b> <b>OLV/IPM</b> <b>EZOLV</b> Sets the drive to use the JOG Frequency Reference (JOG command) set in <i>d1-17</i> [ <i>Jog Reference</i> ]. The JOG Frequency Reference (JOG command) overrides the <i>d1-01</i> to <i>d1-08</i> [ <i>References 1 to 8</i> ] settings.

### 7: Accel/Decel Time Selection 1

Setting Value	Function	Description
7	Accel/Decel Time Selection 1	<b>V/f</b> <b>OLV/IPM</b> <b>EZOLV</b> Sets the drive to use <i>Acceleration/Deceleration Time 1</i> [ <i>C1-01, C1-02</i> ] or <i>Acceleration/Deceleration Time 2</i> [ <i>C1-03, C1-04</i> ].

**Note:**

Refer to [C1: Accel & Decel Time on page 671](#) for more information.

### 8: Baseblock Command (N.O.)

Setting Value	Function	Description
8	Baseblock Command (N.O.)	<b>V/f</b> <b>OLV/IPM</b> <b>EZOLV</b> Sets the command that stops drive output and coasts the motor to stop when the input is ON.

**WARNING! Incorrect Operation.** Yaskawa recommends that you use *H1-xx = 9* [*Baseblock Command (N.C.)*]. If a circuit error occurs in the MFDI, the drive cannot stop the output when the terminal set to *H1-xx = 8* [*Baseblock Command (N.O.)*] turns ON.

The keypad flashes *bb* [*Baseblock*]. If you cancel the baseblock command when the Run command is active, the drive will restart the motor and use the speed search function.

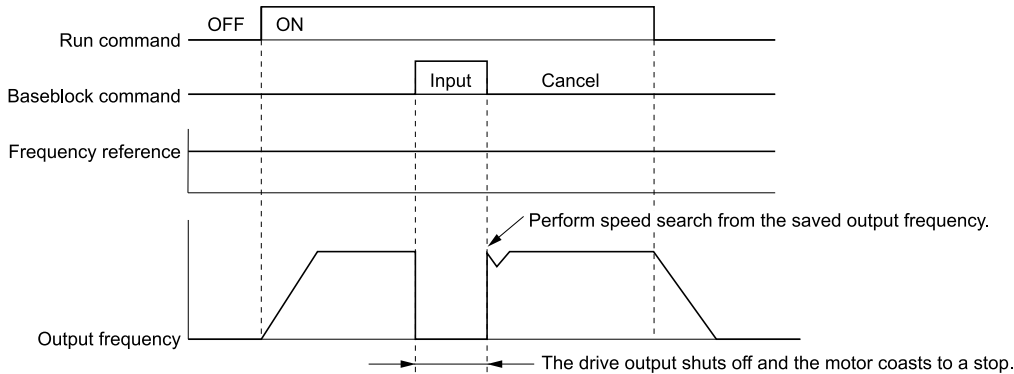

Figure 12.51 Baseblock Command Time Chart

**ON** : Baseblock (drive output stop)

**OFF** : Normal operation

### 9: Baseblock Command (N.C.)

Setting Value	Function	Description
9	Baseblock Command (N.C.)	<b>V/f</b> <b>OLV/IPM</b> <b>EZOLV</b> Sets the command that stops drive output and coasts the motor to stop when the input terminal is OFF.

The keypad flashes *bb* [*Baseblock*]. If you cancel the baseblock command when the Run command is active, the drive will restart the motor and use the speed search function.

**ON** : Normal operation

**OFF : Baseblock (drive output stop)****■ A: Accel/Decel Ramp Hold**

Setting Value	Function	Description
A	Accel/Decel Ramp Hold	<div style="display: flex; justify-content: space-between; align-items: center;"> <span>V/f</span> <span>OLV/PM</span> <span>EZOLV</span> </div> <p>Momentarily pauses motor acceleration and deceleration when the terminal is turned ON, retains the output frequency that was stored in the drive at the time of the pause, and restarts motor operation.</p>

If the terminal is deactivated, the drive restarts acceleration and deceleration.

When the acceleration/deceleration ramp hold terminal is activated and  $d4-01 = 1$  [*Freq Reference Retention Select = Enabled*], the drive will store the output frequency in memory. While the acceleration/deceleration ramp hold command is activated, the drive will always restart the motor at this output frequency.

**Note:**

Refer to *d4-01: Freq Reference Hold Selection on page 691* for more information.

**■ B: Overheat Alarm (oH2)**

Setting Value	Function	Description
B	Overheat Alarm (oH2)	<div style="display: flex; justify-content: space-between; align-items: center;"> <span>V/f</span> <span>OLV/PM</span> <span>EZOLV</span> </div> <p>Sets the drive to show an oH2 [<i>External Overheat (H1-XX=B)</i>] alarm when the input terminal is ON. The alarm does not have an effect on drive operation.</p>

**■ C: Analog Terminal Enable Selection**

Setting Value	Function	Description
C	Analog Terminal Enable Selection	<div style="display: flex; justify-content: space-between; align-items: center;"> <span>V/f</span> <span>OLV/PM</span> <span>EZOLV</span> </div> <p>Sets the command that enables or disables the terminals selected in <i>H3-14 [Analog Input Terminal Enable Sel]</i>.</p>

**ON : Terminal selected with *H3-14* is enabled**

**OFF : Terminal selected with *H3-14* is disabled**

**■ E: ASR Integral Reset**

Setting Value	Function	Description
E	ASR Integral Reset	<div style="display: flex; justify-content: space-between; align-items: center;"> <span>V/f</span> <span>OLV/PM</span> <span>EZOLV</span> </div> <p>Sets the command to reset the integral value and use PI control or P control for the speed control loop.</p>

**ON : P control**

**OFF : PI control**

**■ F: Not Used**

Setting Value	Function	Description
F	Not Used	<div style="display: flex; justify-content: space-between; align-items: center;"> <span>V/f</span> <span>OLV/PM</span> <span>EZOLV</span> </div> <p>Use this setting for unused terminals or to use terminals in through mode.</p>

Through Mode uses the signal input to the terminal as a digital input for the upper sequence through a communication option or MEMOBUS/Modbus communications. This input signal does not have an effect on drive operation.

**■ 10: Up Command**

Setting Value	Function	Description
10	Up Command	<div style="display: flex; justify-content: space-between; align-items: center;"> <span>V/f</span> <span>OLV/PM</span> <span>EZOLV</span> </div> <p>Sets the command to use a push button switch to increase the drive frequency reference. You must also set <i>Setting 11 [Down Command]</i>.</p>

**ON : Increases the frequency reference.**

**OFF : Holds the current frequency reference.**

**Note:**

- If you set only the Up command or only the Down command, the drive will detect *oPE03 [Multi-Function Input Setting Err]*.
- If you set two or more of these functions at the same time, the drive will detect *oPE03*:
  - Up/Down command
  - Accel/Decel Ramp Hold
  - Reference Sample Hold
  - Offset Frequency 1, 2, 3 addition
- The Up/Down command does not function in these conditions:
  - b1-01 = 2, 3 [Frequency Reference Selection 1 = Serial Communications, Option PCB]*
  - b1-02 ≠ 1 [Run Command Selection 1 ≠ Digital Input]*
  - Drive is in HAND mode

When you enter the Up command, the frequency reference increases. When you enter the Down command, the frequency reference decreases.

The Up and Down commands have priority over all other frequency references. When you enable the Up/Down command, the drive will ignore these frequency references:

- Frequency reference from Keypad [*b1-01 = 0*]
- Frequency reference from Analog Input [*b1-01 = 1*]

Table 12.48 shows the Up and Down commands with their operation.

**Table 12.48 Up Command and Down Command**

Command Status		Drive Operation
Up Command (10)	Down Command (11)	
OFF	OFF	Keeps the current frequency reference.
ON	OFF	Increases the frequency reference.
OFF	ON	Decreases the frequency reference.
ON	ON	Keeps the current frequency reference.

**Combine Frequency Reference Hold Functions and Up/Down Commands**

- When you clear the Run command or when *d4-01 = 0 [Freq Reference Hold Selection = Disabled]*, and you restart the drive, the Up/Down command resets to 0.
- When *d4-01 = 1 [Enabled]*, the drive saves the frequency reference set during the Up/Down command. When you cycle the Run command or restart the drive, the drive saves the frequency reference value and restarts the motor at this frequency value. After you clear the Run command, activate the terminal set for the Up command or Down command to set the saved reference value to 0.

**Note:**

Refer to “d4-01: Freq Reference Hold Selection” for more information.

**Combine Upper/Lower Limits of the Frequency Reference and the Up/Down Commands**

Set the upper limit value of the frequency reference to *d2-01 [Frequency Reference Upper Limit]*.

Use an analog input or *d2-02 [Frequency Reference Lower Limit]* to set the lower limit value of the frequency reference. The configurable values change when the setting for *d4-10 [Up/Down Freq Lower Limit Select]* changes. When you input a Run command, these are the lower limits of the frequency reference:

- When the lower limit of the frequency reference is set only for *d2-02*, the drive accelerates the motor to the lower limit value of the frequency reference when you input the Run command.
- When the lower limit of the frequency reference is set only for analog input, the drive accelerates the motor to the lower limit value of the frequency reference when the Run command, and Up command or Down command for the drive is enabled. When only the Run command is enabled, the motor does not start.
- When these conditions occur, the drive accelerates the motor to the *d2-02* setting value when the Run command is input. When the motor accelerates to the setting value of *d2-02*, the motor accelerates to the lower limit value of the analog input when you enable the Up/Down command.
  - The lower limit value of the frequency reference is set for the analog input and *d2-02*
  - The lower limit value of the analog input is higher than the setting value of *d2-02*

**Note:**

Refer to “d4-10: Up/Down Freq Lower Limit Select” for more information.

Figure 12.52 shows an example of how Up/Down command operates. In this example, the lower limit value of the frequency reference is set in d2-02. Figure 12.52 shows the time chart when Frequency Reference Hold Function [d4-01] is enabled and disabled.

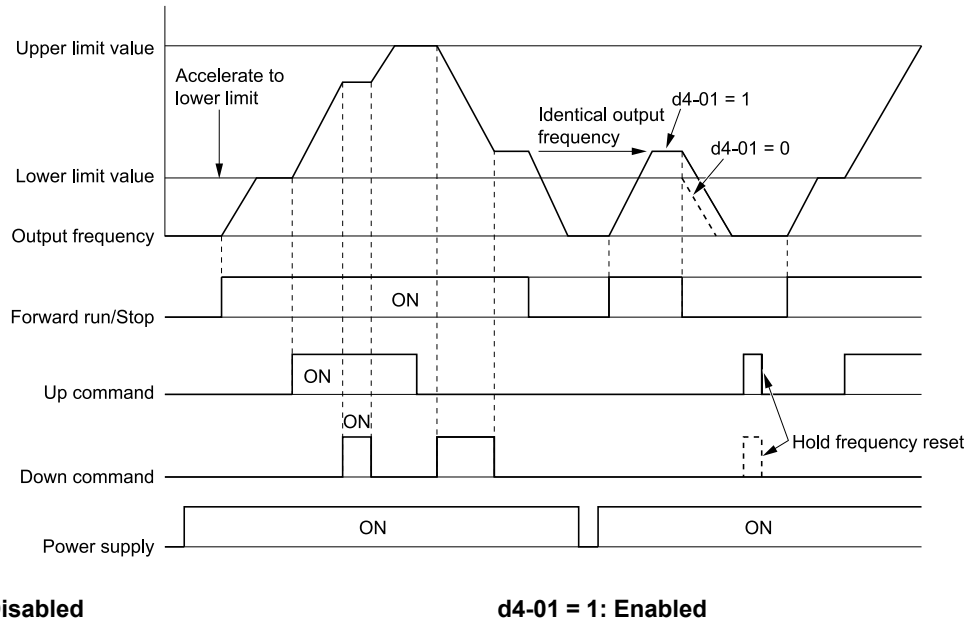

Figure 12.52 Up/Down Command Time Chart

## 11: Down Command

Setting Value	Function	Description
11	Down Command	<div style="display: flex; align-items: center; gap: 5px;"> <span style="background-color: black; color: white; padding: 2px;">V/f</span> <span style="background-color: black; color: white; padding: 2px;">OLV/PM</span> <span style="background-color: black; color: white; padding: 2px;">EZOLV</span> </div> Sets the command to use a push button switch to decrease the drive frequency reference. You must also set Setting 10 [Up Command].

**ON : Decreases the frequency reference.**

**OFF : Holds the current frequency reference.**

**Note:**

- If you set only the Up command or only the Down command, the drive will detect *oPE03* [Multi-Function Input Setting Err].
- If you set two or more of these functions at the same time, the drive will detect *oPE03*:
  - Up/Down command
  - Accel/Decel Ramp Hold
  - Reference Sample Hold
  - Offset Frequency 1, 2, 3 addition
- The Up/Down command does not function in these conditions:
  - b1-01* = 2, 3 [Frequency Reference Selection 1 = Serial Communications, Option PCB]
  - b1-02* ≠ 1 [Run Command Selection 1 ≠ Digital Input]
  - Drive is in HAND mode

When you enter the Up command, the frequency reference increases. When you enter the Down command, the frequency reference decreases.

The Up and Down commands have priority over all other frequency references. When you enable the Up/Down command, the drive will ignore these frequency references:

- Frequency reference from Keypad [*b1-01* = 0]
- Frequency reference from Analog Input [*b1-01* = 1]

## ■ 12: Forward Jog

Setting Value	Function	Description
12	Forward Jog	 Sets the command to operate the motor in the forward direction at the Jog Frequency set in <i>d1-17</i> [Jog Reference].

### Note:

- It is not necessary to input the Run command.
- The Forward JOG command has priority over all other frequency references.
- When the Forward JOG and Reverse JOG commands are activated at the same time for 500 ms or longer, the drive will ramp to stop.

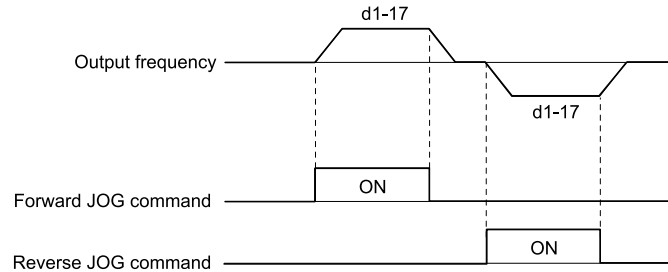



Figure 12.53 JOG Operation Pattern

## ■ 13: Reverse Jog

Setting Value	Function	Description
13	Reverse Jog	 Sets the command to operate the motor in the reverse direction at the Jog Frequency set in <i>d1-17</i> [Jog Reference].

### Note:

- It is not necessary to input the Run command.
- The Reverse JOG command has priority over all other frequency references.
- When the Forward JOG and Reverse JOG commands are activated at the same time for 500 ms or longer, the drive will ramp to stop.

## ■ 14: Fault Reset

Setting Value	Function	Description
14	Fault Reset	 Sets the command to reset the current fault when the Run command is inactive.

If the drive detects a fault, the drive will activate the fault relay output, turn off the output, and the motor will coast to stop.

If the drive detects a fault for which you can set the stopping method, apply the appropriate Stopping Method. Then push  (RESET) on the keypad to turn the Run command OFF, or activate the fault reset terminal to reset the fault.

### Note:

The drive ignores the fault reset command when the Run command is active. Remove the Run command before trying to reset a fault.

## ■ 15: Fast Stop (N.O.)

Setting Value	Function	Description
15	Fast Stop (N.O.)	 Sets the command to ramp to stop in the deceleration time set in <i>C1-09</i> [Fast Stop Time] when the input terminal is activated while the drive is operating.

**WARNING! Incorrect Operation.** Yaskawa recommends that you use *H1-xx = 17* [Fast Stop (N.C.)]. If a circuit error occurs in the MFDI, the drive cannot stop the output when the terminal set to *H1-xx = 15* [Fast Stop (N.O.)] turns ON.

If you cancel the fast stop input, the drive will not restart the motor until you meet these conditions:

- Fully stop the motor
- Cancel the Run command
- Cancel the fast stop command



**Note:**

- To use the N.C. switch to input the fast stop command, set  $H1-xx = 17$  [Fast Stop (N.C.)].
- Refer to *C1-09: Fast Stop Time on page 673* for more information.
- Set *C1-09 [Fast Stop Time]* to a correct deceleration time. If the deceleration time is too short, it can cause an overvoltage fault and failure to stop the motor from coasting.

■ **16: Motor 2 Selection**

Setting Value	Function	Description
16	Motor 2 Selection	<div style="display: flex; gap: 5px;"> <span style="border: 1px solid black; padding: 2px;">V/f</span> <span style="border: 1px solid black; padding: 2px;">OLV/PM</span> <span style="border: 1px solid black; padding: 2px;">EZOLV</span> </div> Sets the command for the drive to operate motor 1 or motor 2. Stop the motors before switching.

You can use an external input to switch operation between two induction motors. The drive will save the control methods, V/f patterns, and motor parameters for the two motors.

**ON : Selects motor 2.**

**OFF : Selects motor 1.**

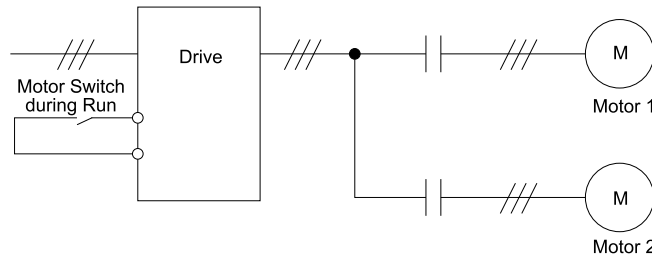

When you select motor 2, the drive will switch to motor 2 parameters.

**Table 12.49 Parameters that Switch between Motor 1 and Motor 2**

Parameter	Motor 2 Selection	
	OFF (Motor 1)	ON (Motor 2)
C1-xx [Accel & Decel Time]	C1-01 to C1-04	C1-05 to C1-08
C3-xx [Slip Compensation]	C3-01, C3-02	C3-21 to C3-24
C4-xx [Torque Compensation]	C4-01	C4-07
C5-xx [Automatic Speed Regulator (ASR)]	C5-01 to C5-08	C5-01 to C5-08
E1-xx, E3-xx [V/f Patterns] E2-xx, E4-xx [Motor Parameters]	E1-xx, E2-xx	E3-xx, E4-xx

**Note:**

- When you use 2 motors, the drive applies the protective function set in  $L1-01$  [Motor Overload (oL1) Protection] to motor 1 and motor 2.
- You cannot switch between motors 1 and 2 during run. If you try to switch motors when they are running, it will cause a  $rUn$  [Motor Switch during Run] alarm.
- You must wait 200 ms minimum to input a Run command.
- If you set  $H1-xx = 16$  [Motor 2 Selection] and set different control methods in maximum output frequency to motors 1 and 2, the drive will apply the lower of the two maximum to the two motors. The upper limit of  $d1-xx$  [Frequency Reference] will change. For example, the upper limit of  $d1-xx$  will be 400 when you set these parameters to these values:
  - $A1-02 = 5$  [Control Method Selection = OLV/PM]
  - $E1-04 = 590$  [Maximum Output Frequency = 590 Hz]
  - $E3-01 = 0$  [Motor 2 Control Mode Selection = V/f Control]
  - $E3-04 = 400$  [Motor 2 Maximum Output Frequency = 400 Hz]
- For software version PRG: 01011, when Motor 2 Selection is ON, the drive sets acceleration and deceleration times to 10.0 s.

■ **17: Fast Stop (N.C.)**

Setting Value	Function	Description
17	Fast Stop (N.C.)	<div style="display: flex; gap: 5px;"> <span style="border: 1px solid black; padding: 2px;">V/f</span> <span style="border: 1px solid black; padding: 2px;">OLV/PM</span> <span style="border: 1px solid black; padding: 2px;">EZOLV</span> </div> Sets the command to ramp to stop in the deceleration time set in <i>C1-09 [Fast Stop Time]</i> when the input terminal is activated while the drive is operating.

If you cancel the fast stop input, the drive will not restart the motor until you meet these conditions:

- Fully stop the motor
- Cancel the Run command
- Cancel the fast stop command

**Note:**

- To use the N.O. switch to input the fast stop command, set  $H1-xx = 15$  [Fast Stop (N.O.)].
- Refer to [C1-09: Fast Stop Time on page 673](#) for more information.
- Set  $C1-09$  [Fast Stop Time] to a correct deceleration time. If the deceleration time is too short, it can cause an overvoltage fault and failure to stop the motor from coasting.

Figure 12.54 shows an example of how fast stop operates.

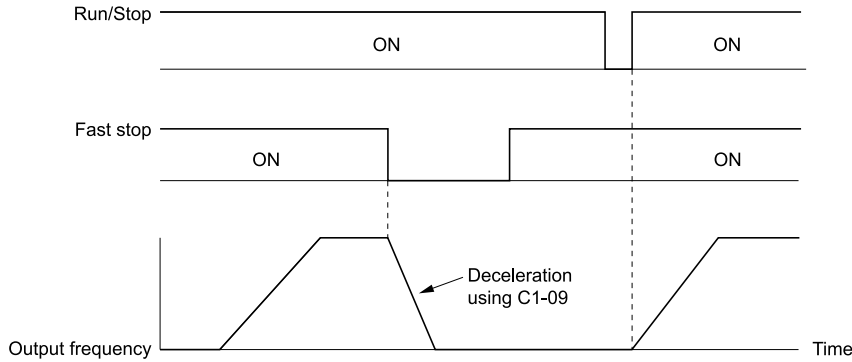

**C1-09: Fast Stop Time**

**Figure 12.54 Fast Stop Time Chart**

**18: Timer Function**

Setting Value	Function	Description
18	Timer Function	<input type="checkbox"/> V/f <input type="checkbox"/> OLV/IPM <input type="checkbox"/> EZOLV Sets the command to start the timer function. Use this setting with <i>Timer Output</i> [H2-xx = 12].

**Note:**

Refer to “b4: Timer Function” for more information.

**19: PID Disable**

Setting Value	Function	Description
19	PID Disable	<input type="checkbox"/> V/f <input type="checkbox"/> OLV/IPM <input type="checkbox"/> EZOLV Sets the command to disable PID control when $b5-01 = 1$ or $3$ [PID Mode Setting = Standard or Fref + PID Trim].

**ON : PID control disabled**

**OFF : PID control enabled**

**1B: Programming Lockout**

Setting Value	Function	Description
1B	Programming Lockout	<input type="checkbox"/> V/f <input type="checkbox"/> OLV/IPM <input type="checkbox"/> EZOLV Sets the command to prevent parameter changes when the terminal is OFF.

You can continue to view parameter setting values when the terminal is *OFF* [Parameter Write Prohibit].

**ON : Programming Lockout**

**OFF : Parameter Write Prohibit**

**1E: Reference Sample Hold**

Setting Value	Function	Description
1E	Reference Sample Hold	<input type="checkbox"/> V/f <input type="checkbox"/> OLV/IPM <input type="checkbox"/> EZOLV Sets the command to sample the frequency reference at terminals A1 or A2 and hold the frequency reference at that frequency.

When the terminal is active for 100 ms, this function reads a sample of the analog frequency reference and holds that sample. When you input the sample/hold command again, the function reads a sample of the analog frequency reference again and holds that sample. When you turn off the power, the drive erases the saved analog frequency and resets the frequency reference to 0.

Figure 12.55 shows an example of how the function operates.

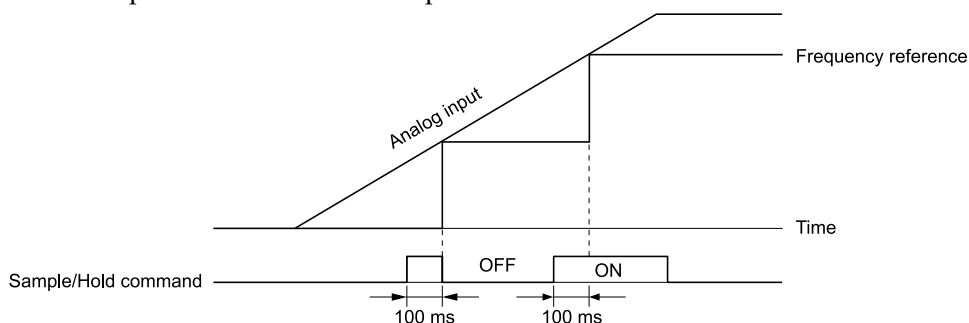

Figure 12.55 Reference Sample Hold

You cannot set the Reference Sample Hold function at the same time as these functions:

- $H1-xx = A$  [Accel/Decel Ramp Hold]
- $H1-xx = 10, 11$  [Up Command, Down Command]
- $H1-xx = 44$  to  $46$  [Offset Frequency 1 to 3]

If you set them at the same time, the drive will detect  $oPE03$  [Multi-Function Input Setting Err].

## 20 to 2F: External Fault

Setting Value	Function	Description
20 to 2F	External Fault	<div style="display: flex; align-items: center; gap: 5px;"> <span style="background-color: black; color: white; padding: 2px;">V/f</span> <span style="background-color: black; color: white; padding: 2px;">OLV/PM</span> <span style="background-color: black; color: white; padding: 2px;">EZOLV</span> </div> Sets a command to stop the drive when a failure or fault occurs on an external device.

**WARNING! Incorrect Operation.** Yaskawa recommends that you use  $H1-xx = 21, 23, 25, 27, 29, 2B, 2D, 2F$  [External Fault (N.C.)]. If a circuit error occurs in the MFDI, the drive cannot stop the output when the terminal set to  $H1-xx = 20, 22, 24, 26, 28, 2A, 2C, 2E$  [External Fault (N.O.)] turns ON.

If an external fault is input to the drive, the keypad will show  $EFx$  [External Fault (Terminal  $Sx$ )], where  $x$  is the number of the terminal (terminal  $Sx$ ) to which the external fault signal is assigned. For example, when an external fault signal is input to terminal  $S3$ , the keypad will show  $EF3$  [External Fault (Terminal  $S3$ )].

Use these conditions to select the value to set in  $H1-xx$ :

- Signal input method from peripheral devices
- External fault detection method
- Motor stopping method (operation after external fault detection)

Table 12.50 shows the relation between the conditions and the value set to  $H1-xx$ .

Table 12.50 Stopping Methods for External Fault

Setting	Signal Input Method from Peripheral Devices <sup>*1</sup>		External Fault Detection Method <sup>*2</sup>		Stopping Method			
	N.O.	N.C.	Always Detected	Detected during RUN Only	Ramp to Stop (Fault)	Coast to Stop (Fault)	Fast Stop (Fault)	Continuous Operation (Alarm Only)
20	x	-	x	-	x	-	-	-
21	-	x	x	-	x	-	-	-
22	x	-	-	x	x	-	-	-
23	-	x	-	x	x	-	-	-
24	x	-	x	-	-	x	-	-
25	-	x	x	-	-	x	-	-
26	x	-	-	x	-	x	-	-
27	-	x	-	x	-	x	-	-

Setting	Signal Input Method from Peripheral Devices *1		External Fault Detection Method *2		Stopping Method			
	N.O.	N.C.	Always Detected	Detected during RUN Only	Ramp to Stop (Fault)	Coast to Stop (Fault)	Fast Stop (Fault)	Continuous Operation (Alarm Only)
28	x	-	x	-	-	-	x	-
29	-	x	x	-	-	-	x	-
2A	x	-	-	x	-	-	x	-
2B	-	x	-	x	-	-	x	-
2C	x	-	x	-	-	-	-	x
2D	-	x	x	-	-	-	-	x
2E	x	-	-	x	-	-	-	x
2F	-	x	-	x	-	-	-	x

\*1 Set the terminal to N.O. (detects external fault when switched ON) or N.C. (detects external fault when switched OFF).

\*2 Set the drive to always detect each fault or to detect only during run.

### ■ 30: PID Integrator Reset

Setting Value	Function	Description
30	PID Integrator Reset	<div style="display: flex; gap: 5px;"> <span>V/f</span> <span>OLV/IPM</span> <span>EZOLV</span> </div> <p>Sets the command to reset and hold the PID control integral to 0 when the terminal is ON.</p>

**Note:**

Refer to “PID control block diagram” for more information.

### ■ 31: PID Integrator Hold

Setting Value	Function	Description
31	PID Integrator Hold	<div style="display: flex; gap: 5px;"> <span>V/f</span> <span>OLV/IPM</span> <span>EZOLV</span> </div> <p>Sets the command to hold the integral value of the PID control while the terminal is activated.</p>

When you turn off the input terminal, PID control restarts the integral.

**Note:**

Refer to “PID control block diagram” for more information.

### ■ 34: PID Soft Starter Disable

Setting Value	Function	Description
34	PID Soft Starter Disable	<div style="display: flex; gap: 5px;"> <span>V/f</span> <span>OLV/IPM</span> <span>EZOLV</span> </div> <p>Sets the PID soft starter function.</p>

**ON : Disabled**

Disables *b5-17 [PID Accel/Decel Time]*.

**OFF : Enabled**

Enables *b5-17 [PID Accel/Decel Time]*.

**Note:**

Refer to “PID control block diagram” for more information.

### ■ 35: PID Input (Error) Invert

Setting Value	Function	Description
35	PID Input (Error) Invert	<div style="display: flex; gap: 5px;"> <span>V/f</span> <span>OLV/IPM</span> <span>EZOLV</span> </div> <p>Sets the command to turn the terminal ON and OFF to switch the PID input level (polarity).</p>

**Note:**

Refer to “PID control block diagram” for more information.

### ■ 3E: PID Setpoint Selection 1

Setting Value	Function	Description
3E	PID Setpoint Selection 1	<b>V/f</b> <b>OLV/PM</b> <b>EZOLV</b> Sets the function to switch the PID setpoint to YA-02 [Setpoint 2] or YA-04 [Setpoint 4]. Set this function and H1-xx = 3F [PID Setpoint Selection 2] at the same time.

**Note:**

If you use this function and one of H1-xx = 83 to 85 [Dedicated Multi-Setpoint YA-02 to YA-04] at the same time, the drive will detect an oPE03 [Multi-Function Input Setting Err].

**ON : YA-02 or YA-04 is PID setpoint.**

**OFF : The frequency reference, YA-01 [Setpoint 1], or YA-03 [Setpoint 3] is PID setpoint.**

### ■ 3F: PID Setpoint Selection 2

Setting Value	Function	Description
3F	PID Setpoint Selection 2	<b>V/f</b> <b>OLV/PM</b> <b>EZOLV</b> Sets the function to switch the PID setpoint to YA-03 [Setpoint 3] or YA-04 [Setpoint 4]. Set this function and H1-xx = 3E [PID Setpoint Selection 1] at the same time.

**Note:**

If you use this function and one of H1-xx = 83 to 85 [Dedicated Multi-Setpoint YA-02 to YA-04] at the same time, the drive will detect an oPE03 [Multi-Function Input Setting Err].

**ON : YA-03 or YA-04 is PID setpoint.**

**OFF : The frequency reference, YA-01 [Setpoint 1], or YA-02 [Setpoint 2] is PID setpoint.**

### ■ 40: Forward RUN (2-Wire)

Setting Value	Function	Description
40	Forward RUN (2-Wire)	<b>V/f</b> <b>OLV/PM</b> <b>EZOLV</b> Sets the Forward Run command for 2-wire sequence 1. Set this function and H1-xx = 41 [Reverse RUN (2-Wire)] together.

**ON : Forward Run**

**OFF : Stop**

**Note:**

- If you turn ON the Forward Run command terminal and the Reverse Run command terminal, it will cause an EF [FWD/REV Run Command Input Error] alarm and the motor will ramp to stop.
- Initialize the drive with a 2-wire sequence to set the Forward Run command to terminal S1.
- This function will not operate at the same time as H1-xx = 42, 43 [Run Command (2-Wire Sequence 2), FWD/REV (2-Wire Sequence 2)].

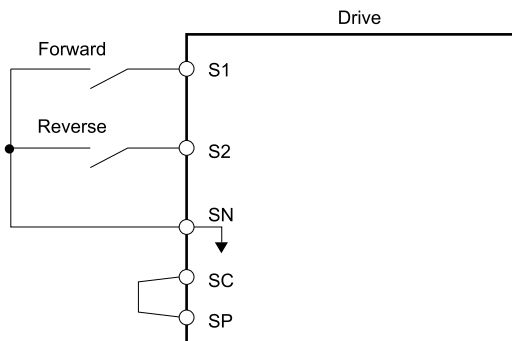

Figure 12.56 2-Wire Sequence Wiring Example

### ■ 41: Reverse RUN (2-Wire)

Setting Value	Function	Description
41	Reverse RUN (2-Wire)	<b>V/f</b> <b>OLV/PM</b> <b>EZOLV</b> Sets the Forward Run command for 2-wire sequence 1. Set this function and H1-xx = 40 [Forward RUN (2-Wire)] together.

**ON : Reverse Run**

**OFF : Stop**

**Note:**

- If you turn ON the Forward Run command terminal and the Reverse Run command terminal, it will cause an *EF [FWD/REV Run Command Input Error]* alarm and the motor will ramp to stop.
- Initialize the drive with a 2-wire sequence to set the Reverse Run command to terminal S2.
- This function will not operate at the same time as *H1-xx = 42, 43 [Run Command (2-Wire Sequence 2), FWD/REV (2-Wire Sequence 2)]*.

**■ 42: Run Command (2-Wire Sequence 2)**

Setting Value	Function	Description
42	Run Command (2-Wire Sequence 2)	<b>V/f</b> <b>OLV/IPM</b> <b>EZOLV</b> Sets the Run command for 2-wire sequence 2. Set this function and <i>H1-xx = 43 [FWD/REV (2-Wire Sequence 2)]</i> together.

**ON : Run**

**OFF : Stop**

**Note:**

This function will not operate at the same time as *H1-xx = 40, 41 [Forward RUN (2-Wire), Reverse RUN (2-Wire)]*.

**■ 43: FWD/REV (2-Wire Sequence 2)**

Setting Value	Function	Description
43	FWD/REV (2-Wire Sequence 2)	<b>V/f</b> <b>OLV/IPM</b> <b>EZOLV</b> Sets the direction of motor rotation for 2-wire sequence 2. Set this function and <i>H1-xx = 42 [Run Command (2-Wire Sequence 2)]</i> together.

**ON : Reverse Run**

**OFF : Forward Run**

**Note:**

- You must input the Run command to rotate the motor.
- This function will not operate at the same time as *H1-xx = 40, 41 [Forward RUN (2-Wire), Reverse RUN (2-Wire)]*.

**■ 44: Add Offset Frequency 1 (d7-01)**

Setting Value	Function	Description
44	Add Offset Frequency 1 (d7-01)	<b>V/f</b> <b>OLV/IPM</b> <b>EZOLV</b> Sets the function to add the offset frequency set in <i>d7-01 [Offset Frequency 1]</i> to the frequency reference when the terminal activates.

**Note:**

Refer to *d7: Offset Frequency on page 692* for more information.

**■ 45: Add Offset Frequency 2 (d7-02)**

Setting Value	Function	Description
45	Add Offset Frequency 2 (d7-02)	<b>V/f</b> <b>OLV/IPM</b> <b>EZOLV</b> Sets the function to add the offset frequency set in <i>d7-02 [Offset Frequency 2]</i> to the frequency reference when the terminal activates.

**Note:**

Refer to *d7: Offset Frequency on page 692* for more information.

**■ 46: Add Offset Frequency 3 (d7-03)**

Setting Value	Function	Description
46	Add Offset Frequency 3 (d7-03)	<b>V/f</b> <b>OLV/IPM</b> <b>EZOLV</b> Sets the function to add the offset frequency set in <i>d7-03 [Offset Frequency 3]</i> to the frequency reference when the terminal activates.

**Note:**

Refer to *d7: Offset Frequency on page 692* for more information.

## ■ 50: Motor Pre-heat 2

Setting Value	Function	Description
50	Motor Pre-heat 2	<b>V/f</b> <b>OLV/PM</b> <b>EZOLV</b> Sets the command to apply the motor pre-heat current set in <i>b2-09</i> [Pre-heat Current 2].

## ■ 51: Sequence Timer Disable

Setting Value	Function	Description
51	Sequence Timer Disable	<b>V/f</b> <b>OLV/PM</b> <b>EZOLV</b> Sets the command to disable Sequence Timers.

### ON : Sequence Timer is Disabled

The drive ignores Sequence Timers and operates as usual as specified by *b1-02* [Run Command Selection 1].

## ■ 52: Sequence Timer Cancel

Setting Value	Function	Description
52	Sequence Timer Cancel	<b>V/f</b> <b>OLV/PM</b> <b>EZOLV</b> Sets the command to cancel the currently active Sequence Timer.

### ON : Cancel Active Sequence Timer

Operation will continue with the next scheduled sequence timer. When you cancel the sequence timer before you cycle the Run command, it will enable the sequence timer again.

## ■ 60: DC Injection Braking Command

Setting Value	Function	Description
60	DC Injection Braking Command	<b>V/f</b> <b>OLV/PM</b> <b>EZOLV</b> Sets the command to use DC Injection Braking to stop the motor.

If you input the Run command or JOG command, it will cancel DC Injection Braking.

Figure 12.57 shows the time chart of the DC Injection Braking function.

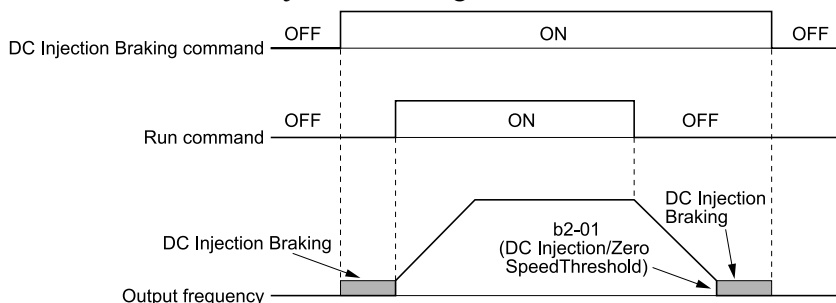

Figure 12.57 DC Injection Braking Time Chart

#### Note:

- When *A1-02* = 8 [Control Method Selection = EZOLV], this function is available with a PM motor.
- Refer to *b2: DC Injection Braking and Short Circuit Braking on page 635* for more information.

## ■ 61: Speed Search from Fmax

Setting Value	Function	Description
61	Speed Search from Fmax	<b>V/f</b> <b>OLV/PM</b> <b>EZOLV</b> Sets the function to use an external reference to start speed search although <i>b3-01</i> = 0 [Speed Search Selection at Start = Disabled] to not allow speed search at start.

When the terminal is activated for *b3-24* = 2 [Speed Search Method Selection = Current Detection 2], the drive starts speed search from the maximum output frequency.

**Note:**

- The drive will detect *oPE03 [Multi-Function Input Setting Err]* if you set *H1-xx = 61 and 62* at the same time.
- Refer to “b3: Speed Search” for more information.

■ **62: Speed Search from Fref**

Setting Value	Function	Description
62	Speed Search from Fref	<div style="display: flex; align-items: center;"> <span style="background-color: black; color: white; padding: 2px 5px; margin-right: 5px;">V/f</span> <span style="background-color: #ccc; padding: 2px 5px; margin-right: 5px;">OLV/IPM</span> <span style="background-color: #ccc; padding: 2px 5px;">EZOLV</span> </div> Sets the function to use an external reference to start speed search although <i>b3-01 = 0 [Speed Search Selection at Start = Disabled]</i> to not allow speed search at start.

When the terminal is activated for *b3-24 = 2 [Speed Search Method Selection = Current Detection 2]*, the drive starts speed search from the frequency reference.

**Note:**

- The drive will detect *oPE03 [Multi-Function Input Setting Err]* if you set *H1-xx = 61 and 62* at the same time.
- Refer to “b3: Speed Search” for more information.

■ **63: Field Weakening**

Setting Value	Function	Description
63	Field Weakening	<div style="display: flex; align-items: center;"> <span style="background-color: black; color: white; padding: 2px 5px; margin-right: 5px;">V/f</span> <span style="background-color: #ccc; padding: 2px 5px; margin-right: 5px;">OLV/IPM</span> <span style="background-color: #ccc; padding: 2px 5px;">EZOLV</span> </div> Sets the function to send the Field Weakening Level and Field Weakening Frequency Limit commands set in <i>d6-01 [Field Weakening Level]</i> and <i>d6-02 [Field Weakening Frequency Limit]</i> when the input terminal is activated.

**Note:**

Refer to [d6: Field Weakening on page 692](#) for more information.

■ **65: KEB Ride-Thru 1 Activate (N.C.)**

Setting Value	Function	Description
65	KEB Ride-Thru 1 Activate (N.C.)	<div style="display: flex; align-items: center;"> <span style="background-color: black; color: white; padding: 2px 5px; margin-right: 5px;">V/f</span> <span style="background-color: #ccc; padding: 2px 5px; margin-right: 5px;">OLV/IPM</span> <span style="background-color: #ccc; padding: 2px 5px;">EZOLV</span> </div> Sets operation of the KEB1 function through the KEB Ride-Thru 1 (N.C.).

**ON : Normal operation**

**OFF : Deceleration during momentary power loss**

When you enable KEB Ride-Thru 1, set *L2-29 [Kinetic Energy Backup Method]*. The drive operates with the selected KEB method.

**Note:**

- If you set *KEB Ride-Thru 1 [H1-xx = 65, 66]* and *KEB Ride-Thru 2 [H1-xx = 7A, 7B]* at the same time, the drive will detect *oPE03 [Multi-Function Input Setting Err]*.
- Refer to [KEB Ride-Thru Function on page 805](#) for more information.

■ **66: KEB Ride-Thru 1 Activate (N.O.)**

Setting Value	Function	Description
66	KEB Ride-Thru 1 Activate (N.O.)	<div style="display: flex; align-items: center;"> <span style="background-color: black; color: white; padding: 2px 5px; margin-right: 5px;">V/f</span> <span style="background-color: #ccc; padding: 2px 5px; margin-right: 5px;">OLV/IPM</span> <span style="background-color: #ccc; padding: 2px 5px;">EZOLV</span> </div> Sets operation of the KEB1 function through the KEB Ride-Thru 1 (N.O.).

**ON : Deceleration during momentary power loss**

**OFF : Normal operation**

When you enable KEB Ride-Thru 1, set *L2-29 [Kinetic Energy Backup Method]*. The drive operates with the selected KEB method.

**Note:**

- If you set *KEB Ride-Thru 1 [H1-xx = 65, 66]* and *KEB Ride-Thru 2 [H1-xx = 7A, 7B]* at the same time, the drive will detect *oPE03 [Multi-Function Input Setting Err]*.
- Refer to [KEB Ride-Thru Function on page 805](#) for more information.



## ■ 67: Communications Test Mode

Setting Value	Function	Description
67	Communications Test Mode	<div style="display: flex; gap: 5px;"> <span style="border: 1px solid black; border-radius: 3px; padding: 2px;">V/f</span> <span style="border: 1px solid black; border-radius: 3px; padding: 2px;">OLV/PM</span> <span style="border: 1px solid black; border-radius: 3px; padding: 2px;">EZOLV</span> </div> Set the function for the drive to self-test RS-485 serial communications operation.

The Self-Diagnostics function connects the transmission terminal of the control terminal block to the reception terminal. The function transmits the data that the drive sent to make sure that the drive can communicate correctly.

### Note:

Refer to MEMOBUS/Modbus communications “Self-Diagnostics” for the self-diagnostics procedure.

## ■ 68: High Slip Braking (HSB) Activate

Setting Value	Function	Description
68	High Slip Braking (HSB) Activate	<div style="display: flex; gap: 5px;"> <span style="border: 1px solid black; border-radius: 3px; padding: 2px;">V/f</span> <span style="border: 1px solid black; border-radius: 3px; padding: 2px;">OLV/PM</span> <span style="border: 1px solid black; border-radius: 3px; padding: 2px;">EZOLV</span> </div> Sets the command to use high-slip braking to stop the motor.

### Note:

- When you restart the drive after you use high-slip braking, make sure that the drive fully stops the motor then clear the high-slip braking input.
- Refer to “n3: High Slip/Overex Braking” for more information.

## ■ 69: Jog Run 2

Setting Value	Function	Description
69	Jog Run 2	<div style="display: flex; gap: 5px;"> <span style="border: 1px solid black; border-radius: 3px; padding: 2px;">V/f</span> <span style="border: 1px solid black; border-radius: 3px; padding: 2px;">OLV/PM</span> <span style="border: 1px solid black; border-radius: 3px; padding: 2px;">EZOLV</span> </div> Causes the drive to ramp to the <i>d1-17 [Jog Reference]</i> frequency. The forward/reverse command from the 3-wire or 2-wire 2 sequence sets the direction.

## ■ 6A: Drive Enable

Setting Value	Function	Description
6A	Drive Enable	<div style="display: flex; gap: 5px;"> <span style="border: 1px solid black; border-radius: 3px; padding: 2px;">V/f</span> <span style="border: 1px solid black; border-radius: 3px; padding: 2px;">OLV/PM</span> <span style="border: 1px solid black; border-radius: 3px; padding: 2px;">EZOLV</span> </div> Sets the function to show <i>dnE [Drive Disabled]</i> on the keypad and ignore Run commands when the terminal is OFF.

If you input the Run command before you turn ON the Drive Enable terminal, you must input the Run command again to operate the drive. When you deactivate the terminal set for Drive Enable while the drive is operating, the drive will use the stopping method set in *b1-03 [Stopping Method Selection]* to stop the motor.

**ON : Run command is accepted.**

**OFF : Run command 2 is disabled. When the drive is running, it stops according to *b1-03* setting.**

## ■ 6D: AUTO Command

Setting Value	Function	Description
6D	AUTO Command	<div style="display: flex; gap: 5px;"> <span style="border: 1px solid black; border-radius: 3px; padding: 2px;">V/f</span> <span style="border: 1px solid black; border-radius: 3px; padding: 2px;">OLV/PM</span> <span style="border: 1px solid black; border-radius: 3px; padding: 2px;">EZOLV</span> </div> Sets the command to operate the drive in AUTO Mode.

### ON : AUTO Mode

- *S5-04 = 0 [HAND-OFF-AUTO Behavior = Legacy]*:  
The drive selects AUTO reference as specified by *b1-01 [Frequency Reference Selection 1]*.
- *S5-04 = 1 [Normal]*:  
The drive is in AUTO Mode when HAND Mode select input is not active.

### OFF : OFF Mode or HAND Mode

- *S5-04 = 0*:  
The drive selects HAND reference as specified by *S5-01 [HAND Frequency Reference Source]*.
- *S5-04 = 1*:  
The drive is in OFF or HAND Mode.

## ■ 6E: HAND Command

Setting Value	Function	Description
6E	HAND Command	<div style="display: flex; justify-content: space-between; align-items: center;"> <span>V/f</span> <span>OLV/PM</span> <span>EZOLV</span> </div> Sets the command to operate the drive in HAND Mode.

### ON : HAND Mode

- $S5-04 = 0$  [*HAND-OFF-AUTO Behavior = Legacy*]:  
The drive selects HAND reference as specified by  $S5-01$  [*HAND Frequency Reference Source*].
- $S5-04 = 1$  [*Normal*]:  
The drive is in HAND Mode when AUTO Mode select input is not active.

### OFF : OFF Mode or AUTO Mode

- $S5-04 = 0$ :  
The drive selects AUTO reference as specified by  $b1-01$  [*Frequency Reference Selection 1*].
- $S5-04 = 1$ :  
The drive is in OFF or AUTO Mode.

## ■ 70: Drive Enable 2

Setting Value	Function	Description
70	Drive Enable 2	<div style="display: flex; justify-content: space-between; align-items: center;"> <span>V/f</span> <span>OLV/PM</span> <span>EZOLV</span> </div> Sets the function to show $dnE$ [ <i>Drive Enabled</i> ] on the keypad and ignore Run commands when the terminal is OFF.

When you input the Run command before you turn ON the Drive Enable 2 terminal, it is not necessary to remove and apply the Run command again. The drive will start to operate when the Run command and Drive Enable 2 are both ON. If you turn OFF the terminal set for Drive Enable while the drive is operating, the drive will use the stopping method set in  $b1-03$  [*Stopping Method Selection*] to stop the motor.

**ON : Run command is accepted.**

**OFF : Run command is disabled. When the drive is running, it stops according to  $b1-03$  setting.**

## ■ 77: ASR Gain (C5-03) Select

Setting Value	Function	Description
77	ASR Gain (C5-03) Select	<div style="display: flex; justify-content: space-between; align-items: center;"> <span>V/f</span> <span>OLV/PM</span> <span>EZOLV</span> </div> Sets the function to switch the ASR proportional gain to $C5-01$ [ <i>ASR Proportional Gain 1</i> ] or $C5-03$ [ <i>ASR Proportional Gain 2</i> ].

### ON : C5-03

Switches the proportional gain to  $C5-03$  [*ASR Proportional Gain 2*].

### OFF : C5-01

Switches the proportional gain to  $C5-01$  [*ASR Proportional Gain 1*].

**Note:**

Refer to “C5: Automatic Speed Regulator (ASR)” for more information.

## ■ 7A: KEB Ride-Thru 2 Activate (N.C.)

Setting Value	Function	Description
7A	KEB Ride-Thru 2 Activate (N.C.)	<div style="display: flex; justify-content: space-between; align-items: center;"> <span>V/f</span> <span>OLV/PM</span> <span>EZOLV</span> </div> Sets operation of the KEB2 function through the KEB Ride-Thru 2 (N.C.).

### ON : Normal operation

### OFF : Deceleration during momentary power loss

When KEB Ride-Thru 2 is input, the drive will use Single Drive KEB Ride-Thru 2 for KEB operation. The  $L2-29$  [*Kinetic Energy Backup Method*] setting will not have an effect.

**Note:**

- If you set *KEB Ride-Thru 1* [ $H1-xx = 65, 66$ ] and *KEB Ride-Thru 2* [ $H1-xx = 7A, 7B$ ] at the same time, the drive will detect  $oPE03$  [*Multi-Function Input Setting Err*].
- Refer to [KEB Ride-Thru Function on page 805](#) for more information.

### ■ 7B: KEB Ride-Thru 2 Activate (N.O.)

Setting Value	Function	Description
7B	KEB Ride-Thru 2 Activate (N.O.)	<input type="checkbox"/> V/f <input checked="" type="checkbox"/> OLV/PM <input checked="" type="checkbox"/> EZOLV Sets operation of the KEB2 function through the KEB Ride-Thru 2 (N.O.).

**ON : Deceleration during momentary power loss**

**OFF : Normal operation**

When KEB Ride-Thru 2 is input, the drive will use Single Drive KEB Ride-Thru 2 for KEB operation. The *L2-29 [Kinetic Energy Backup Method]* setting will not have an effect.

**Note:**

- If you set *KEB Ride-Thru 1 [H1-xx = 65, 66]* and *KEB Ride-Thru 2 [H1-xx = 7A, 7B]* at the same time, the drive will detect *oPE03 [Multi-Function Input Setting Err]*.
- Refer to *KEB Ride-Thru Function on page 805* for more information.

### ■ 7C: Short Circuit Braking (N.O.)

Setting Value	Function	Description
7C	Short Circuit Braking (N.O.)	<input type="checkbox"/> V/f <input checked="" type="checkbox"/> OLV/PM <input checked="" type="checkbox"/> EZOLV Sets operation of Short Circuit Braking (N.O.).

**WARNING! Incorrect Operation.** Yaskawa recommends that you use *H1-xx = 7D [Short Circuit Braking (N.C.)]*. If a circuit error occurs in the MFDI, the motor can take longer than expected to stop when the terminal set to *H1-xx = 7C [Short Circuit Braking (N.O.)]* turns ON.

The drive will short circuit the three phases of a PM motor to cause braking torque in the spinning motor.

**Note:**

- When *A1-02 = 8 [Control Method Selection = EZOLV]*, this function is available only when you use a PM motor.
- Refer to *b2: DC Injection Braking and Short Circuit Braking on page 635* for more information.

**ON : Short Circuit Braking is enabled.**

**OFF : Normal operation**

### ■ 7D: Short Circuit Braking (N.C.)

Setting Value	Function	Description
7D	Short Circuit Braking (N.C.)	<input type="checkbox"/> V/f <input checked="" type="checkbox"/> OLV/PM <input checked="" type="checkbox"/> EZOLV Sets operation of Short Circuit Braking (N.C.).

The drive will short circuit the three phases of a PM motor to cause braking torque in the spinning motor.

**Note:**

- When *A1-02 = 8 [Control Method Selection = EZOLV]*, this function is available only when you use a PM motor.
- Refer to *b2: DC Injection Braking and Short Circuit Braking on page 635* for more information.

**ON : Normal operation**

**OFF : Short Circuit Braking is enabled.**

### ■ 82: PI Switch to Aux

Setting Value	Function	Description
82	PI Switch to Aux	<input type="checkbox"/> V/f <input checked="" type="checkbox"/> OLV/PM <input checked="" type="checkbox"/> EZOLV Sets <i>YF-xx [PI Auxiliary Control]</i> parameters as primary PI loop parameters and disables <i>b5-xx [PID Control]</i> .

**Note:**

When this input is active, *YF-xx [PI Auxiliary Control]* parameters will always be the primary PI loop parameters. Parameter *YF-20 [PI Aux Main PI Speed Control]* does not have an effect.

### ■ 83: Dedicated Multi-Setpoint YA-02

Setting Value	Function	Description
83	Dedicated Multi-Setpoint YA-02	<input type="checkbox"/> V/f <input checked="" type="checkbox"/> OLV/PM <input checked="" type="checkbox"/> EZOLV Sets the function to set the PID setpoint to <i>YA-02 [Setpoint 2]</i> .

**Note:**

If you use this function and one of  $H1-xx = 3E$  or  $3F$  [PID Setpoint Selection 1 or 2] at the same time, the drive will detect an *oPE03* [Multi-Function Input Setting Err].

**ON : YA-02 is PID setpoint.**

**OFF : YA-01 [Setpoint 1], YA-03 [Setpoint 3], or YA-04 [Setpoint 4] is PID setpoint.**

■ **84: Dedicated Multi-Setpoint YA-03**

Setting Value	Function	Description
84	Dedicated Multi-Setpoint YA-03	<b>V/f</b> <b>OLV/PM</b> <b>EZOLV</b> Sets the function to set the PID setpoint to YA-03 [Setpoint 3]. Set this function and $H1-xx = 83$ [Dedicated Multi-Setpoint YA-02] at the same time.

**Note:**

If you use this function and one of  $H1-xx = 3E$  or  $3F$  [PID Setpoint Selection 1 or 2] at the same time, the drive will detect an *oPE03* [Multi-Function Input Setting Err].

**ON : YA-03 is PID setpoint.**

**OFF : YA-01 [Setpoint 1], YA-02 [Setpoint 2], or YA-04 [Setpoint 4] is PID setpoint.**

■ **85: Dedicated Multi-Setpoint YA-04**

Setting Value	Function	Description
85	Dedicated Multi-Setpoint YA-04	<b>V/f</b> <b>OLV/PM</b> <b>EZOLV</b> Sets the function to set the PID setpoint to YA-04 [Setpoint 4]. Set this function, $H1-xx = 83$ [Dedicated Multi-Setpoint YA-02], and $H1-xx = 84$ [Dedicated Multi-Setpoint YA-03] at the same time.

**Note:**

If you use this function and one of  $H1-xx = 3E$  or  $3F$  [PID Setpoint Selection 1 or 2] at the same time, the drive will detect an *oPE03* [Multi-Function Input Setting Err].

**ON : YA-04 is PID setpoint.**

**OFF : YA-01 [Setpoint 1], YA-02 [Setpoint 2], or YA-03 [Setpoint 3] is PID setpoint.**

■ **88: Thermostat Fault**

Setting Value	Function	Description
88	Thermostat Fault	<b>V/f</b> <b>OLV/PM</b> <b>EZOLV</b> Sets the drive to show the <i>VLTS</i> [Thermostat Fault] when the input terminal is ON.

**Note:**

This function is active when the drive is running.

If the drive is running in AUTO Mode or HAND Mode and if the terminal set for  $H1-xx = 88$  [MFDI Function Selection = Thermostat Fault] is ON or if the terminal set for  $H1-xx = 188$  [!Thermostat Fault] is OFF, the drive will detect *VLTS*.

■ **90 to 96: DriveWorksEZ Digital Inputs 1 to 7**

Setting Value	Function	Description
90 - 96	DWEZ Digital Inputs 1 to 7	<b>V/f</b> <b>OLV/PM</b> <b>EZOLV</b> Set DriveWorksEZ digital inputs. Refer to the DriveWorksEZ online manual for more information.

**Note:**

You cannot set values 90 to 96 for inverse output.

■ **9F: DWEZ Disable**

Setting Value	Function	Description
9F	DWEZ Disable	<b>V/f</b> <b>OLV/PM</b> <b>EZOLV</b> Sets operation of the DriveWorksEZ program saved in the drive.

**Note:**

Set  $A1-07 = 2$  [DriveWorksEZ Function Selection = Enabled/Disabled wDigital Input] to use this function.

ON : Disabled

OFF : Enabled

### ■ A8: PI2 Control Disable

Setting Value	Function	Description
A8	PI2 Control Disable	<div style="display: flex; justify-content: space-between; align-items: center;"> <span>V/f</span> <span>OLV/PM</span> <span>EZOLV</span> </div> <p>Sets the command to disable the PI2 Control function. Parameter S3-12 [PI2 Control Disable Mode Sel] sets the output performance.</p>

ON : Enabled

OFF : Disabled

### ■ AA: PI2 Control Inverse Operation

Setting Value	Function	Description
AA	PI2 Control Inverse Operation	<div style="display: flex; justify-content: space-between; align-items: center;"> <span>V/f</span> <span>OLV/PM</span> <span>EZOLV</span> </div> <p>Sets the command to change the sign of the PI2 Control input.</p>

### ■ AB: PI2 Control Integral Reset

Setting Value	Function	Description
AB	PI2 Control Integral Reset	<div style="display: flex; justify-content: space-between; align-items: center;"> <span>V/f</span> <span>OLV/PM</span> <span>EZOLV</span> </div> <p>Sets the command to reset the PI2 Control integral value.</p>

### ■ AC: PI2 Control Integral Hold

Setting Value	Function	Description
AC	PI2 Control Integral Hold	<div style="display: flex; justify-content: space-between; align-items: center;"> <span>V/f</span> <span>OLV/PM</span> <span>EZOLV</span> </div> <p>Sets the command to lock the PI2 Control integral value.</p>

### ■ AD: Select PI2 Control PI Parameters

Setting Value	Function	Description
AD	Select PI2 Control PI Parameters	<div style="display: flex; justify-content: space-between; align-items: center;"> <span>V/f</span> <span>OLV/PM</span> <span>EZOLV</span> </div> <p>Sets the command to use the S3-06 [PI2 Control Proportional Gain] and S3-07 [PI2 Control Integral Time] values instead of the b5-02 [Proportional Gain (P)] and b5-03 [Integral Time (I)] values. Set S3-01 = 0 [PI2 Control Enable Selection = Disabled] to enable this function.</p>

### ■ AF: Emergency Override FWD

Setting Value	Function	Description
AF	Emergency Override FWD	<div style="display: flex; justify-content: space-between; align-items: center;"> <span>V/f</span> <span>OLV/PM</span> <span>EZOLV</span> </div> <p>Sets the command to use the speed set in S6-02 [Emergency Override Ref Selection] to run the drive in the forward direction.</p>

### ■ B0: Emergency Override REV

Setting Value	Function	Description
B0	Emergency Override REV	<div style="display: flex; justify-content: space-between; align-items: center;"> <span>V/f</span> <span>OLV/PM</span> <span>EZOLV</span> </div> <p>Sets the command to use the speed set in S6-02 [Emergency Override Ref Selection] to run the drive in the reverse direction.</p>

### ■ B1: Customer Safeties

Setting Value	Function	Description
B1	Customer Safeties	<div style="display: flex; justify-content: space-between; align-items: center;"> <span>V/f</span> <span>OLV/PM</span> <span>EZOLV</span> </div> <p>Sets the command to show that customer safeties are in place.</p>

This function is the same as  $HI-xx = 70$  [MFDI Function Selection = Drive Enable 2], with these differences:

- When you deactivate the input, the stopping method is Coast to Stop.
- If you deactivate the input when there is a Run command, the drive will show a SAFE [Customer Safeties] alarm. The drive will not show dnE [Drive Disabled].

## ■ B2: BAS Interlock

Setting Value	Function	Description
B2	BAS Interlock	<b>V/f</b> <b>OLV/IPM</b> <b>EZOLV</b> Sets the command to show that the dampers are open.

- If the input deactivates, the drive will show an *INTLK [BAS Interlock]*.
- When you deactivate the input, the stopping method is Coast to Stop.

## ■ B8: Low City Pressure

Setting Value	Function	Description
B8	Low City Pressure	<b>V/f</b> <b>OLV/IPM</b> <b>EZOLV</b> Sets the command to show that there is not sufficient pressure at the inlet to the pump.

### Note:

When  $Y1-01 = 3$  [*Multiplex Mode = Memobus Network*], this function will activate on any drive in the network. An alarm condition will cause other drives in the network to stop the operation and show a "Network Drive Error" "Check Faulted Drive" message.

### OFF : Insufficient pressure is present on the inlet to the pump

## ■ B9: Disable Pre-charge

Setting Value	Function	Description
B9	Disable Pre-charge	<b>V/f</b> <b>OLV/IPM</b> <b>EZOLV</b> Sets the command to disable the Pre-charge function.

### ON : Pre-charge function is disabled

## ■ 188 to 1B8: Inverse Inputs of 88 to B8

Setting Value	Function	Description
188 to 1B8	Inverse Inputs of 88 to B8	Sets the function of the selected MFDI to operate inversely. To select the function for inverse input, enter two digits of 88, A8, or B8 for the "xx" in "1xx".

For example, to use the inverse input of 88 [*Thermostat Fault*], set  $H1-xx = 188$ .

## ◆ H2: Digital Outputs

*H2 parameters* set the MFDO terminal functions.

### ■ H2-01 to H2-03 Terminal M1-M2, M3-M4, M5-M6 Function Selection

The drive has three MFDO terminals. [Table 12.51](#) shows the default function settings for the terminals.

**Table 12.51 MFDO Terminals Default Function Settings**

No.	Name	Default	Function
H2-01	Term M1-M2 Function Selection	0	During Run
H2-02	Term M3-M4 Function Selection	1	Zero Speed
H2-03	Term M5-M6 Function Selection	2	Speed Agree 1

Refer to [Table 12.52](#) to set  $H2-xx$  [*MFDO Function Selection*].

**Table 12.52 MFDO Setting Value**

Setting Value	Function	Reference	Setting Value	Function	Reference
0	During Run	<a href="#">758</a>	5	Frequency Detection 2	<a href="#">760</a>
1	Zero Speed	<a href="#">758</a>	6	Drive ready	<a href="#">761</a>
2	Speed Agree 1	<a href="#">759</a>	7	DC Bus Undervoltage	<a href="#">761</a>
3	User-Set Speed Agree 1	<a href="#">759</a>	8	During Baseblock (N.O.)	<a href="#">761</a>
4	Frequency Detection 1	<a href="#">760</a>	9	Frequency Reference from Keypad	<a href="#">761</a>

Setting Value	Function	Reference	Setting Value	Function	Reference
B	Torque Detection 1 (N.O.)	762	58	UL6 Underload Detected	770
C	Frequency Reference Loss	762	60	Internal Cooling Fan Failure	770
E	Fault	762	61	Pole Position Detection Complete	770
F *1	Not Used	762	62	Modbus Reg 1 Status Satisfied	770
10	Alarm	762	63	Modbus Reg 2 Status Satisfied	770
11	Fault Reset Command Active	762	69	External Power 24V Supply	770
12	Timer Output	762	6A	Data Logger Error	770
13	Speed Agree 2	763	71	Low PI2 Control Feedback Level	770
14	User-Set Speed Agree 2	763	72	High PI2 Control Feedback Level	771
15	Frequency Detection 3	764	89	Output Current Lim	771
16	Frequency Detection 4	764	90 to 92	DWEZ Digital Outputs 1 to 3	771
17	Torque Detection 1 (N.C.)	765	94	Loss of Prime	771
18	Torque Detection 2 (N.O.)	765	95	Thermostat Fault	771
19	Torque Detection 2 (N.C.)	765	96	High Feedback	771
1A	During reverse	766	97	Low Feedback	771
1B	During Baseblock (N.C.)	766	9E	Low PI Auxiliary Control Level	771
1C	Motor 2 Selected	766	9F	High PI Auxiliary Control Level	771
1E	Executing Auto-Restart	766	A9	RELAY Operator Control	772
1F	Motor Overload Alarm (oL1)	766	AA	Utility Delay	772
20	Drive Overheat Pre-Alarm (oH)	767	AB	Thrust Mode	772
21	Safe Torque OFF	767	AC	Setpoint Not Maintained	772
2F	Maintenance Notification	767	B2	BAS Interlock	772
30	During Torque Limit	767	B8	Pump Fault	772
37	During Frequency Output	767	B9	Transducer Loss	772
38	Drive Enabled	768	BA	PI Auxiliary Control Active	772
39	Watt Hour Pulse Output	768	BB	Differential Feedback Exceeded	772
3A	Drive Overheat Alarm	768	BC	Sleep Active	773
3D	During Speed Search	768	BD	Start Delay	773
42	Pressure Reached	768	BE	Pre-Charge	773
4A	During KEB Ride-Thru	769	C0	HAND Mode	773
4B	During Short Circuit Braking	769	C1	AUTO Mode	773
4C	During Fast Stop	769	C2	OFF Mode	773
4D	oH Pre-Alarm Reduction Limit	769	C3	Main Feedback Lost	773
51	Sequence Timer 1	769	C4	Backup Feedback Lost	773
52	Sequence Timer 2	769	100 to 1C4	Inverse Outputs of 0 to C4 Sets an inverse output of the function for the MFDO. Put a 1 at the front of the function setting to set inverse output. For example, set 138 for inverse output of 38 [Drive Enabled].	774
53	Sequence Timer 3	769			
54	Sequence Timer 4	770			

\*1 Inverse output is not available.

\*2 You cannot set this parameter on models 2169 to 2273 and 4065 to 4302.

### ■ Extended MFDO1 to MFDO3 Function Selection

You can set MFDO functions to *bit 0 to bit 2* [MEMOBUS MFDO1 to 3] of MEMOBUS register 15E0 (Hex.). Use H2-40 to H2-42 [Mbus Reg 15E0h bit0 to bit2 Output Func] to select the function.



Figure 12.58 Functional Block Diagram of MEMOBUS Multi-function Output

Table 12.53 MEMOBUS MFDO Registers

Register number (Hex.)	Name	
15E0	bit0	MEMOBUS MFDO 1
	bit1	MEMOBUS MFDO 2
	bit2	MEMOBUS MFDO 3

**Note:**

- Refer to *MFDO Setting Values on page 758* for more information about MFDO setting values.
- When you do not set functions to H2-40 to H2-42, set them to F.

■ **Output of Logical Operation Results of MFDO**

This enables the logical operation results of two MFDOs to be output to one MFDO terminal.

Use H2-60, H2-63, and H2-66 [Term M1-M2 Secondary Function to Term M5-M6 Secondary Function] to set the function of the output signal for which logical operations are performed.

Use H2-61, H2-64, H2-67 [Term M1-M2 Logical Operation to Term M5-M6 Logical Operation] to set the logical operation.

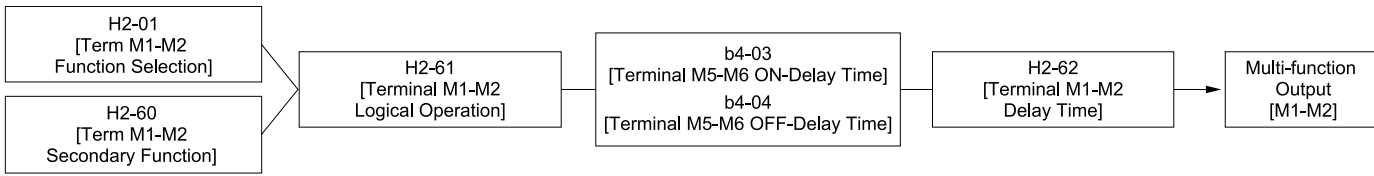

Figure 12.59 Functional Block Diagram of Logical Operation Output for MFDO 1

Table 12.54 MFDO Logical Operation Table

Logical Operation Selection	Logical Operation Expression	Logical Operation Notation
H2-61, H2-64, H2-67		
0	$A=B=1$	
1	$A=1 \text{ or } B=1$	
2	$A=0 \text{ or } B=0$	
3	$A=B=0$	
4	$A=B$	$A=B$
5	$A \neq B$	
6	$AND(A, \bar{B})$	
7	$OR(A, \bar{B})$	
8	-	On



**Note:**

- When you use the function to output logical calculation results, you cannot set  $H2-01$  to  $H2-03 = 1xx$  [Inverse Output of  $xx$ ]. If you do, the drive will detect *oPE33* [Digital Output Selection Error].
- When you do not use  $H2-60$ ,  $H2-63$ , and  $H2-66$ , set them to  $F$ . The through mode function is not supported.

## ◆ H2 MFDO Parameters

### ■ H2-01: Term M1-M2 Function Selection

No. (Hex.)	Name	Description	Default (Range)
H2-01 (040B)	Term M1-M2 Function Selection	<div style="display: flex; gap: 5px;"> <span>V/f</span> <span>OLV/PM</span> <span>EZOLV</span> </div> Sets the function for MFDO terminal M1-M2.	0 (0 - 1FF)

**Note:**

When you do not use the terminal or when you use the terminal in through mode, set this parameter to  $F$ .

### ■ H2-02: Term M3-M4 Function Selection

No. (Hex.)	Name	Description	Default (Range)
H2-02 (040C)	Term M3-M4 Function Selection	<div style="display: flex; gap: 5px;"> <span>V/f</span> <span>OLV/PM</span> <span>EZOLV</span> </div> Sets the function for MFDO terminal M3-M4.	1 (0 - 1FF)

**Note:**

When you do not use the terminal or when you use the terminal in through mode, set this parameter to  $F$ .

### ■ H2-03: Term M5-M6 Function Selection

No. (Hex.)	Name	Description	Default (Range)
H2-03 (040D)	Term M5-M6 Function Selection	<div style="display: flex; gap: 5px;"> <span>V/f</span> <span>OLV/PM</span> <span>EZOLV</span> </div> Sets the function for MFDO terminal M5-M6.	2 (0 - 1FF)

**Note:**

When you do not use this terminal, or when you will use the terminal in through mode, set this parameter to  $F$ .

### ■ H2-06: Watt Hour Output Unit Selection

No. (Hex.)	Name	Description	Default (Range)
H2-06 (0437)	Watt Hour Output Unit Selection	<div style="display: flex; gap: 5px;"> <span>V/f</span> <span>OLV/PM</span> <span>EZOLV</span> </div> Sets the unit for the output signal when $H2-01$ to $H2-03 = 39$ [MFDO Function Selection = Watt Hour Pulse Output].	0 (0 - 4)

This output is input to the Watt hour meter or PLC through a 200 ms pulse signal. This parameter sets the kWh unit for each pulse output.

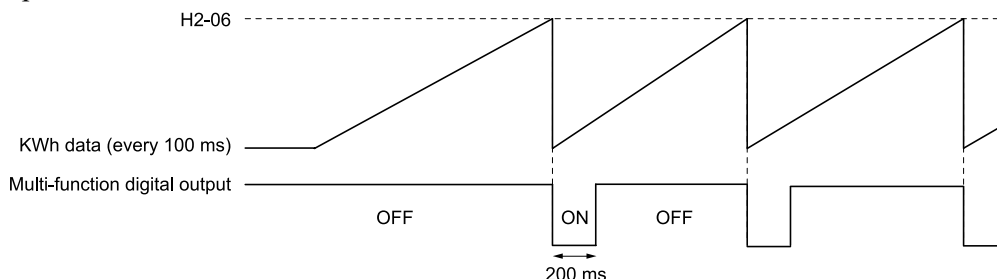

Figure 12.60 Example MFDO when Configured for Watt Hours

**Note:**

- When the power value is a negative value (regenerative state), the drive does not count Watt hours.
- When the control power supply to the drive is operating, the drive will keep the Watt hours. If a momentary power loss causes the drive to lose control power, the Watt hour count will reset.

0 : 0.1 kWh units

1 : 1 kWh units

2 : 10 kWh units

3 : 100 kWh units

4 : 1000 kWh units

### ■ H2-07: Modbus Register 1 Address Select

No. (Hex.)	Name	Description	Default (Range)
H2-07 (0B3A)	Modbus Register 1 Address Select	<input type="checkbox"/> V/f <input type="checkbox"/> OLV/IPM <input type="checkbox"/> EZOLV Sets the address of the MEMOBUS/Modbus register output to the MFDO terminal.	0001 (0001 - 1FFF)

Sets the address of the register that is output to *Modbus Reg 1 Status Satisfied* [H2-01 to H2-03 = 62] and uses the bit in H2-08 [Modbus Register 1 Bit Select].

### ■ H2-08: Modbus Register 1 Bit Select

No. (Hex.)	Name	Description	Default (Range)
H2-08 (0B3B)	Modbus Register 1 Bit Select	<input type="checkbox"/> V/f <input type="checkbox"/> OLV/IPM <input type="checkbox"/> EZOLV Sets the bit of the MEMOBUS/Modbus register output to the MFDO terminal.	0000 (0000 - FFFF)

Sets the bit of the register that is output to *Modbus Reg 1 Status Satisfied* [H2-01 to H2-03 = 62] and uses the address in H2-07 [Modbus Register 1 Address Select].

### ■ H2-09: Modbus Register 2 Address Select

No. (Hex.)	Name	Description	Default (Range)
H2-09 (0B3C)	Modbus Register 2 Address Select	<input type="checkbox"/> V/f <input type="checkbox"/> OLV/IPM <input type="checkbox"/> EZOLV Sets the address of the MEMOBUS/Modbus register output to the MFDO terminal.	0001 (0001 - 1FFF)

Sets H2-09 with the address of the register that is output to *Modbus Reg 2 Status Satisfied* [H2-01 to H2-03 = 63] and uses the bit in H2-10 [Modbus Register 2 Bit Select].

### ■ H2-10: Modbus Register 2 Bit Select

No. (Hex.)	Name	Description	Default (Range)
H2-10 (0B3D)	Modbus Register 2 Bit Select	<input type="checkbox"/> V/f <input type="checkbox"/> OLV/IPM <input type="checkbox"/> EZOLV Sets the bit of the MEMOBUS/Modbus register output to the MFDO terminal.	0000 (0000 - FFFF)

Sets the bit of the register that is output to *Modbus Reg 2 Status Satisfied* [H2-01 to H2-03 = 63] and uses the address in H2-09.

### ■ H2-40: Mbus Reg 15E0h bit0 Output Func

No. (Hex.)	Name	Description	Default (Range)
H2-40 (0B58)	Mbus Reg 15E0h bit0 Output Func	<input type="checkbox"/> V/f <input type="checkbox"/> OLV/IPM <input type="checkbox"/> EZOLV Sets the MFDO for bit 0 of MEMOBUS register 15E0 (Hex.).	F (0 - 1FF)

### ■ H2-41: Mbus Reg 15E0h bit1 Output Func

No. (Hex.)	Name	Description	Default (Range)
H2-41 (0B59)	Mbus Reg 15E0h bit1 Output Func	<input type="checkbox"/> V/f <input type="checkbox"/> OLV/IPM <input type="checkbox"/> EZOLV Sets the MFDO for bit 1 of MEMOBUS register 15E0 (Hex.).	F (0 - 1FF)

### ■ H2-42: Mbus Reg 15E0h bit2 Output Func

No. (Hex.)	Name	Description	Default (Range)
H2-42 (0B5A)	Mbus Reg 15E0h bit2 Output Func	<b>V/f</b> <b>OLV/PM</b> <b>EZOLV</b> Sets the MFDO for bit 2 of MEMOBUS register 15E0 (Hex.).	F (0 - 1FF)

### ■ H2-60: Term M1-M2 Secondary Function

No. (Hex.)	Name	Description	Default (Range)
H2-60 (1B46) Expert	Term M1-M2 Secondary Function	<b>V/f</b> <b>OLV/PM</b> <b>EZOLV</b> Sets the second function for terminal M1-M2. Outputs the logical calculation results of the terminals assigned to functions by H2-01 [Term M1-M2 Function Selection].	F (0 - FF)

### ■ H2-61: Terminal M1-M2 Logical Operation

No. (Hex.)	Name	Description	Default (Range)
H2-61 (1B47) Expert	Terminal M1-M2 Logical Operation	<b>V/f</b> <b>OLV/PM</b> <b>EZOLV</b> Sets the logical operation for the functions set in H2-01 [Term M1-M2 Function Selection] and H2-60 [Term M1-M2 Secondary Function].	0 (0 - 8)

**Note:**

Refer to [Output of Logical Operation Results of MFDO on page 754](#) for more information about the relation between parameter settings and logical operations.

### ■ H2-62: Terminal M1-M2 Delay Time

No. (Hex.)	Name	Description	Default (Range)
H2-62 (1B48) Expert	Terminal M1-M2 Delay Time	<b>V/f</b> <b>OLV/PM</b> <b>EZOLV</b> Sets the minimum on time used to output the logical calculation results from terminal M1-M2.	0.1 s (0.0 - 25.0 s)

### ■ H2-63: Term M3-M4 Secondary Function

No. (Hex.)	Name	Description	Default (Range)
H2-63 (1B49) Expert	Term M3-M4 Secondary Function	<b>V/f</b> <b>OLV/PM</b> <b>EZOLV</b> Sets the second function for terminal M3-M4. Outputs the logical calculation results of the terminals assigned to functions by H2-02 [Term M3-M4 Function Selection].	F (0 - FF)

### ■ H2-64: Terminal M3-M4 Logical Operation

No. (Hex.)	Name	Description	Default (Range)
H2-64 (1B4A) Expert	Terminal M3-M4 Logical Operation	<b>V/f</b> <b>OLV/PM</b> <b>EZOLV</b> Sets the logical operation for the functions set in H2-02 [Term M3-M4 Function Selection] and H2-63 [Term M3-M4 Secondary Function].	0 (0 - 8)

**Note:**

Refer to [Output of Logical Operation Results of MFDO on page 754](#) for more information about the relation between parameter settings and logical operations.

### ■ H2-65: Terminal M3-M4 Delay Time

No. (Hex.)	Name	Description	Default (Range)
H2-65 (1B4B) Expert	Terminal M3-M4 Delay Time	<b>V/f</b> <b>OLV/PM</b> <b>EZOLV</b> Sets the minimum on time used to output the logical calculation results from terminal M3-M4.	0.1 s (0.0 - 25.0 s)

■ **H2-66: Term M5-M6 Secondary Function**

No. (Hex.)	Name	Description	Default (Range)
H2-66 (1B4C) Expert	Term M5-M6 Secondary Function	<b>V/f</b> <b>OLV/PM</b> <b>EZOLV</b> Sets the second function for terminal M5-M6. Outputs the logical calculation results of the terminals assigned to functions by H2-03 [Terminal M5-M6 Function Selection].	F (0 - FF)

■ **H2-67: Terminal M5-M6 Logical Operation**

No. (Hex.)	Name	Description	Default (Range)
H2-67 (1B4D) Expert	Terminal M5-M6 Logical Operation	<b>V/f</b> <b>OLV/PM</b> <b>EZOLV</b> Sets the logical operation for the functions set in H2-03 [Term M5-M6 Function Selection] and H2-66 [Term M5-M6 Secondary Function].	0 (0 - 8)

**Note:**

Refer to *Output of Logical Operation Results of MFDO on page 754* for more information about the relation between parameter settings and logical operations.

■ **H2-68: Terminal M5-M6 Delay Time**

No. (Hex.)	Name	Description	Default (Range)
H2-68 (1B4E) Expert	Terminal M5-M6 Delay Time	<b>V/f</b> <b>OLV/PM</b> <b>EZOLV</b> Sets the minimum on time used to output the logical calculation results from terminal M5-M6.	0.1 s (0.0 - 25.0 s)

◆ **MFDO Setting Values**

Selects the function configured to MFDO.

■ **0: During Run**

Setting Value	Function	Description
0	During Run	<b>V/f</b> <b>OLV/PM</b> <b>EZOLV</b> The terminal activates when you input a Run command and when the drive is outputting voltage.

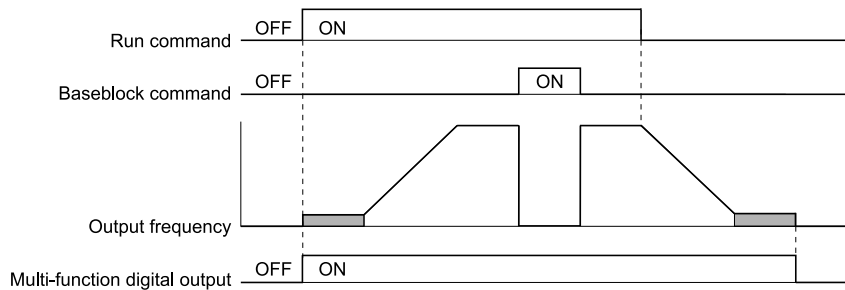

Figure 12.61 Drive Running Time Chart

**ON : Drive is running**

The drive is receiving a Run command or outputting voltage.

**OFF : Drive is stopping**

■ **1: Zero Speed**

Setting Value	Function	Description
1	Zero Speed	<b>V/f</b> <b>OLV/PM</b> <b>EZOLV</b> The terminal activates when the output frequency < E1-09 [Minimum Output Frequency].

**Note:**

Parameter E1-09 is the reference in all control methods.

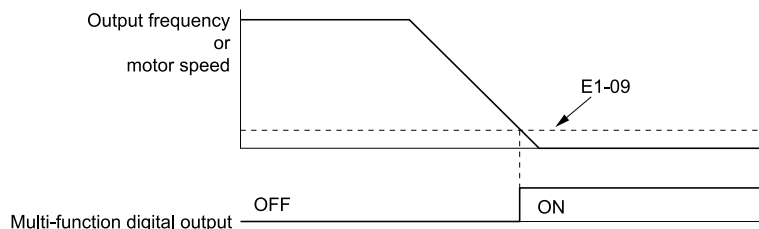

E1-09: Minimum Output Frequency

Figure 12.62 Zero Speed Time Chart

**ON :** Output frequency < *E1-09*.  
**OFF :** Output frequency ≥ *E1-09*.

■ 2: Speed Agree 1

Setting Value	Function	Description
2	Speed Agree 1	<div style="display: flex; gap: 5px;"> <span style="border: 1px solid black; border-radius: 3px; padding: 2px;">V/f</span> <span style="border: 1px solid black; border-radius: 3px; padding: 2px;">OLV/PM</span> <span style="border: 1px solid black; border-radius: 3px; padding: 2px;">EZOLV</span> </div> The terminal activates when the output frequency is in the range of the frequency reference ± <i>L4-02</i> [Speed Agree Detection Width].

**Note:**

The detection function operates in the two motor rotation directions.

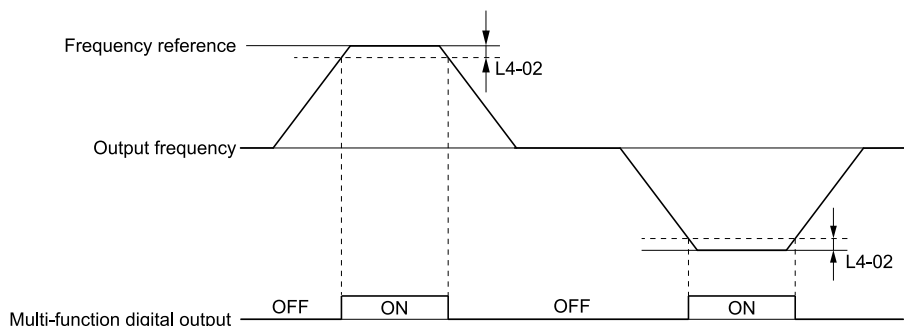

L4-02: Speed Agree Detection Width

Figure 12.63 Speed Agree 1 Time Chart

**ON :** The output frequency is in the range of “frequency reference ± *L4-02*”.  
**OFF :** The output frequency does not align with the frequency reference although the drive is running.

■ 3: User-Set Speed Agree 1

Setting Value	Function	Description
3	User-Set Speed Agree 1	<div style="display: flex; gap: 5px;"> <span style="border: 1px solid black; border-radius: 3px; padding: 2px;">V/f</span> <span style="border: 1px solid black; border-radius: 3px; padding: 2px;">OLV/PM</span> <span style="border: 1px solid black; border-radius: 3px; padding: 2px;">EZOLV</span> </div> The terminal activates when the output frequency is in the range of <i>L4-01</i> [Speed Agree Detection Level] ± <i>L4-02</i> [Speed Agree Detection Width] and in the range of the frequency reference ± <i>L4-02</i> .

**Note:**

The detection function operates in the two motor rotation directions. The drive uses the *L4-01* value as the forward/reverse detection level.

**ON :** The output frequency is in the range of “*L4-01* ± *L4-02*” and the range of frequency reference ± *L4-02*.”

**OFF :** The output frequency is not in the range of “*L4-01* ± *L4-02*” or the range of frequency reference ± *L4-02*.”

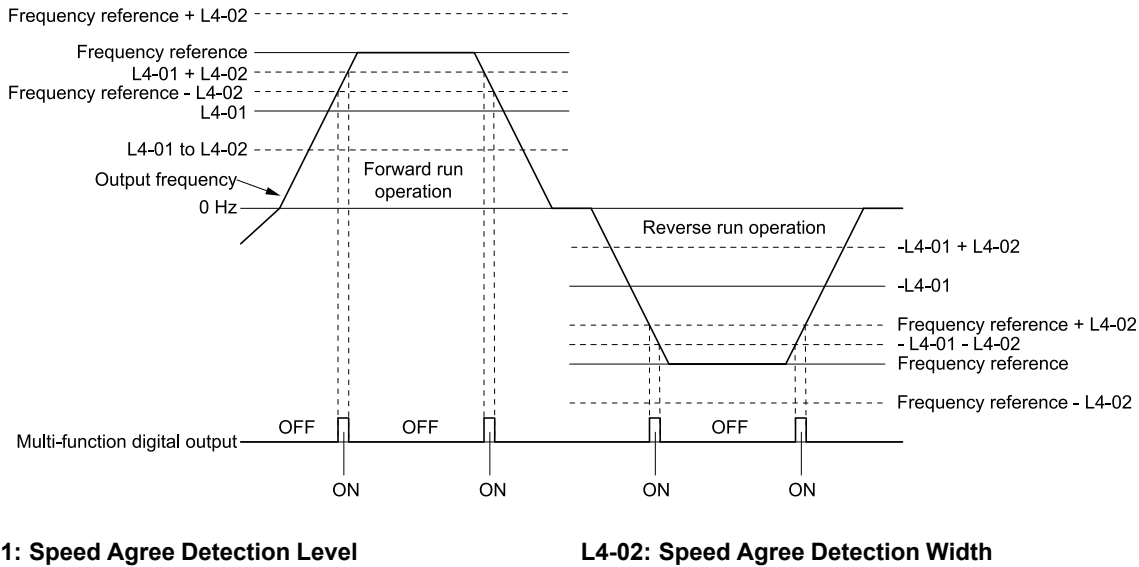

Figure 12.64 User-Defined Speed Agree 1 Time Chart

■ 4: Frequency Detection 1

Setting Value	Function	Description
4	Frequency Detection 1	<p><b>V/f</b> <b>OLV/PM</b> <b>EZOLV</b></p> <p>The terminal deactivates when the output frequency &gt; “L4-01 [Speed Agree Detection Level] + L4-02 [Speed Agree Detection Width]”. After the terminal deactivates, the terminal stays deactivated until the output frequency is at the value of L4-01.</p>

**Note:**

The detection function operates in the two motor rotation directions. The drive uses the L4-01 value as the forward/reverse detection level.

**ON** : The output frequency < L4-01, or the output frequency ≤ “L4-01 + L4-02”

**OFF** : The output frequency > “L4-01 + L4-02”

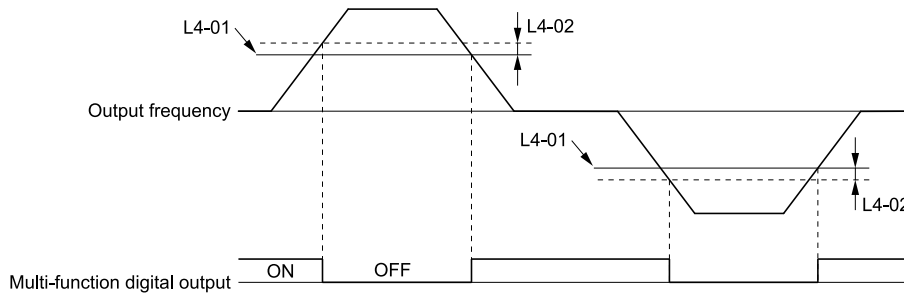

L4-01: Speed Agree Detection Level      L4-02: Speed Agree Detection Width

Figure 12.65 Frequency Detection 1 Time Chart

**Note:**

Figure 12.65 shows the result of the configuration when L4-07 = 1 [Speed Agree Detection Selection = Detection Always Enabled]. The default setting of L4-07 is 0 [No Detection during Baseblock]. When the speed agreement detection selection is “No Detection during Baseblock”, the terminal is deactivated when the drive output stops.

■ 5: Frequency Detection 2

Setting Value	Function	Description
5	Frequency Detection 2	<p><b>V/f</b> <b>OLV/PM</b> <b>EZOLV</b></p> <p>The terminal activates when the output frequency &gt; L4-01 [Speed Agree Detection Level]. After the terminal activates, the terminal stays activated until the output frequency is at the value of “L4-01 - L4-02 [Speed Agree Detection Width]”.</p>

**Note:**

The detection function operates in the two motor rotation directions. The drive uses the L4-01 value as the forward/reverse detection level.

**ON** : The output frequency > L4-01

**OFF :** The output frequency < “L4-01 - L4-02”, or the output frequency  $\leq$  L4-01

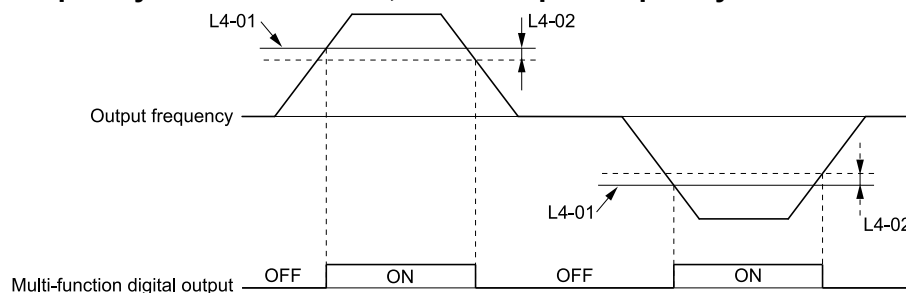

**L4-01: Speed Agree Detection Level**

**L4-02: Speed Agree Detection Width**

**Figure 12.66 Frequency Detection 2 Time Chart**

## ■ 6: Drive Ready

Setting Value	Function	Description
6	Drive Ready	<p><b>V/f</b> <b>OLV/PM</b> <b>EZOLV</b></p> <p>The terminal activates when the drive is ready and running.</p>

The terminal deactivates in these conditions:

- When the power supply is OFF
- During a fault
- When there is problem with the control power supply
- When there is a parameter setting error and the drive cannot operate although there is a Run command
- When you enter a Run command and it immediately triggers an overvoltage or undervoltage fault because the drive has an overvoltage or undervoltage fault during stop
- When the drive is in Programming Mode and will not accept a Run command
- When the Safe Disable function is active

## ■ 7: DC Bus Undervoltage

Setting Value	Function	Description
7	DC Bus Undervoltage	<p><b>V/f</b> <b>OLV/PM</b> <b>EZOLV</b></p> <p>The terminal activates when the DC bus voltage or control circuit power supply is at the voltage set in L2-05 [Undervoltage Detection Lvl (Uv1)] or less. The terminal also activates when there is a fault with the DC bus voltage.</p>

**ON :** The DC bus voltage  $\leq$  L2-05

**OFF :** The DC bus voltage > L2-05

## ■ 8: During Baseblock (N.O.)

Setting Value	Function	Description
8	During Baseblock (N.O.)	<p><b>V/f</b> <b>OLV/PM</b> <b>EZOLV</b></p> <p>The terminal activates during baseblock. When the drive is in baseblock, the drive output transistor stops switching and does not make DC bus voltage.</p>

**ON :** During baseblock

**OFF :** The drive is not in baseblock.

## ■ 9: Frequency Reference from Keypad

Setting Value	Function	Description
9	Frequency Reference from Keypad	<p><b>V/f</b> <b>OLV/PM</b> <b>EZOLV</b></p> <p>Shows the selected frequency reference source.</p>

**ON :** The keypad is the frequency reference source.

**OFF :** Parameter b1-01 [Frequency Reference Selection 1] is the frequency reference source.

■ **B: Torque Detection 1 (N.O.)**

Setting Value	Function	Description
B	Torque Detection 1 (N.O.)	<b>V/f</b> <b>OLV/IPM</b> <b>EZOLV</b> The terminal activates when the drive detects overtorque or undertorque.

**ON** : The output current/torque > L6-02 [Torque Detection Level 1], or the output current/torque < L6-02 for longer than the time set in L6-03 [Torque Detection Time 1].

**Note:**

- When L6-01 ≥ 5, the drive will detect when the output current/torque is less than L6-02 for longer than L6-03.
- Refer to [L6: Torque Detection on page 826](#) for more information.

■ **C: Frequency Reference Loss**

Setting Value	Function	Description
C	Frequency Reference Loss	<b>V/f</b> <b>OLV/IPM</b> <b>EZOLV</b> The terminal activates when the drive detects a loss of frequency reference.

**Note:**

Refer to “L4-05: Fref Loss Detection Selection” for more information.

■ **E: Fault**

Setting Value	Function	Description
E	Fault	<b>V/f</b> <b>OLV/IPM</b> <b>EZOLV</b> The terminal activates when the drive detects a fault.

**Note:**

The terminal will not activate for CPF00 and CPF01 [Control Circuit Error] faults.

■ **F: Not Used**

Setting Value	Function	Description
F	Not Used	<b>V/f</b> <b>OLV/IPM</b> <b>EZOLV</b> Use this setting for unused terminals or to use terminals in through mode. Also use this setting as the PLC contact output via MEMOBUS/Modbus or the communication option. This signal does not function if you do not configure signals from the PLC.

■ **10: Alarm**

Setting Value	Function	Description
10	Alarm	<b>V/f</b> <b>OLV/IPM</b> <b>EZOLV</b> The terminal activates when the drive detects a minor fault.

■ **11: Fault Reset Command Active**

Setting Value	Function	Description
11	Fault Reset Command Active	<b>V/f</b> <b>OLV/IPM</b> <b>EZOLV</b> The terminal activates when the drive receives the Reset command from the control circuit terminal, serial communications, or the communication option.

■ **12: Timer Output**

Setting Value	Function	Description
12	Timer Output	<b>V/f</b> <b>OLV/IPM</b> <b>EZOLV</b> Sets the terminal as the timer output. Use this setting with the timer input set in H1-xx = 18 [MFDI Function Selection = Timer Function].

**Note:**

Refer to [Timer Function Operation on page 647](#) for more information.



### 13: Speed Agree 2

Setting Value	Function	Description
13	Speed Agree 2	<div style="display: flex; justify-content: space-between; align-items: center;"> <span>V/f</span> <span>OLV/PM</span> <span>EZOLV</span> </div> <p>The terminal activates when the output frequency is in the range of the frequency reference <math>\pm L4-04</math> [Speed Agree Detection Width (+/-)].</p>

**Note:**

The detection function operates in the two motor rotation directions.

**ON :** The output frequency is in the range of “frequency reference  $\pm L4-04$ ”.

**OFF :** The output frequency is not in the range of “frequency reference  $\pm L4-04$ ”.

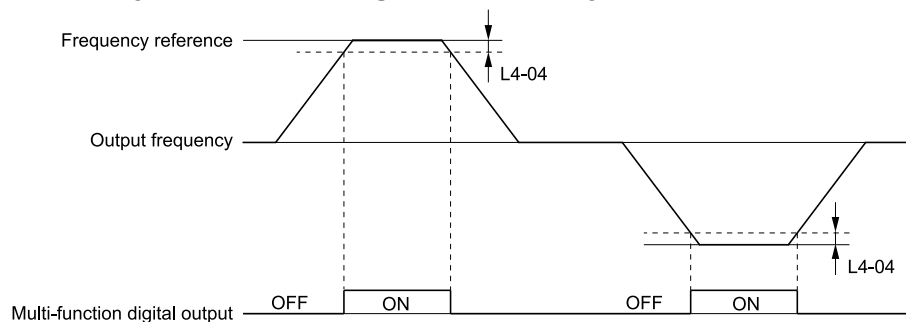

**L4-04: Speed Agree Detection Width(+/-)**

Figure 12.67 Speed Agree 2 Time Chart

### 14: User-Set Speed Agree 2

Setting Value	Function	Description
14	User-Set Speed Agree 2	<div style="display: flex; justify-content: space-between; align-items: center;"> <span>V/f</span> <span>OLV/PM</span> <span>EZOLV</span> </div> <p>The terminal activates when the output frequency is in the range of <math>L4-03</math> [Speed Agree Detection Level (+/-)] <math>\pm L4-04</math> [Speed Agree Detection Width (+/-)] and in the range of the frequency reference <math>\pm L4-04</math>.</p>

**Note:**

The detection level set in  $L4-03$  is a signed value. The drive will only detect in one direction.

**ON :** The output frequency is in the range of “ $L4-03 \pm L4-04$ ” and the range of frequency reference  $\pm L4-04$ .

**OFF :** The output frequency is not in the range of “ $L4-03 \pm L4-04$ ” or the range of frequency reference  $\pm L4-04$ .

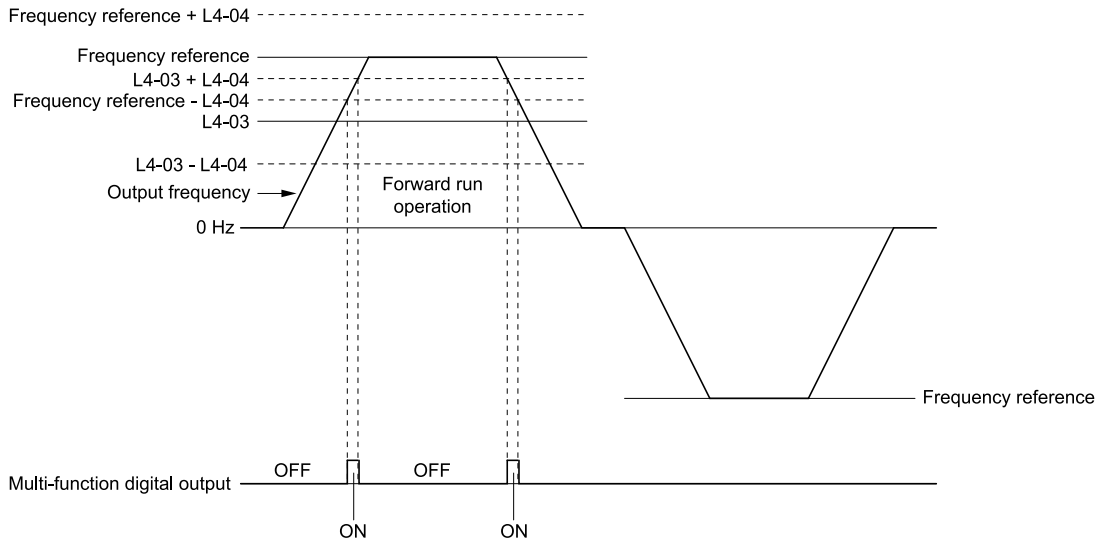

L4-03: Speed Agree Detection Level(+/-)

L4-04: Speed Agree Detection Width(+/-)

Figure 12.68 Example of User-set Speed Agree 2 (L4-03 Is Positive)

### 15: Frequency Detection 3

Setting Value	Function	Description
15	Frequency Detection 3	<div style="display: flex; align-items: center;"> <span style="background-color: black; color: white; padding: 2px 5px; margin-right: 5px;">V/f</span> <span style="background-color: black; color: white; padding: 2px 5px; margin-right: 5px;">OLV/PM</span> <span style="background-color: black; color: white; padding: 2px 5px; margin-right: 5px;">EZOLV</span> </div> <p>The terminal deactivates when the output frequency &gt; “L4-03 [Speed Agree Detection Level (+/-)] + L4-04 [Speed Agree Detection Width (+/-)]”. After the terminal deactivates, the terminal stays deactivated until the output frequency is at the value of L4-03.</p>

**Note:**

The detection level set in L4-03 is a signed value. The drive will only detect in one direction.

**ON :** The output frequency < L4-03, or the output frequency ≤ L4-03 + L4-04.

**OFF :** The output frequency > “L4-03 + L4-04”.

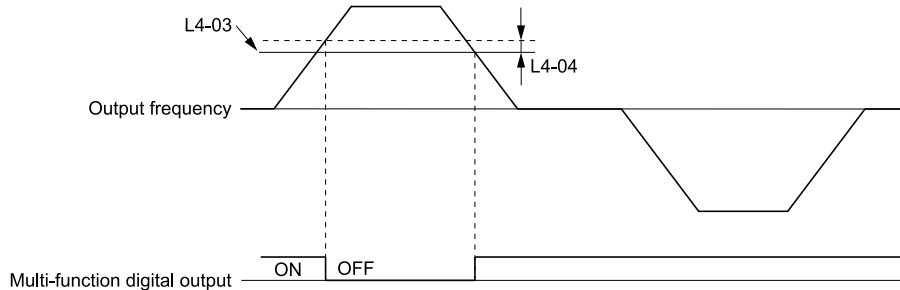

L4-03: Speed Agree Detection Level(+/-)

L4-04: Speed Agree Detection Width(+/-)

Figure 12.69 Example of Frequency Detection 3 (Value of L4-03 is Positive)

**Note:**

Figure 12.69 shows the time chart when L4-07 = 1 [Speed Agree Detection Selection = Detection Always Enabled]. The default setting of L4-07 is 0 [No Detection during Baseblock]. When the speed agreement detection selection is “No Detection during Baseblock”, the terminal deactivates when the drive output stops.

### 16: Frequency Detection 4

Setting Value	Function	Description
16	Frequency Detection 4	<div style="display: flex; align-items: center;"> <span style="background-color: black; color: white; padding: 2px 5px; margin-right: 5px;">V/f</span> <span style="background-color: black; color: white; padding: 2px 5px; margin-right: 5px;">OLV/PM</span> <span style="background-color: black; color: white; padding: 2px 5px; margin-right: 5px;">EZOLV</span> </div> <p>The terminal activates when the output frequency &gt; L4-03 [Speed Agree Detection Level (+/-)]. After the terminal activates, the terminal stays activated until the output frequency is at the value of “L4-03 - L4-04”.</p>

**Note:**

The detection level set in L4-03 is a signed value. The drive will only detect in one direction.

**ON** : The output frequency > L4-03.

**OFF** : The output frequency < “L4-03 - L4-04”, or the output frequency ≤ L4-03.

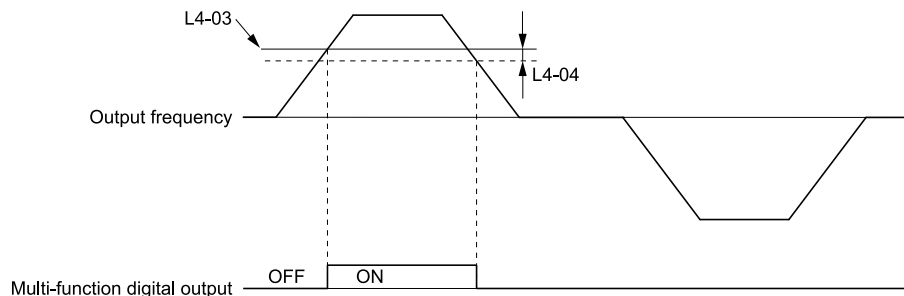

**L4-03: Speed Agree Detection Level(+/-)**

**L4-04: Speed Agree Detection Width(+/-)**

Figure 12.70 Example of Frequency Detection 4 (Value of L4-03 is Positive)

### ■ 17: Torque Detection 1 (N.C.)

Setting Value	Function	Description
17	Torque Detection 1 (N.C.)	<input type="checkbox"/> V/f <input type="checkbox"/> OLVP/M <input type="checkbox"/> EZOLV The terminal deactivates when the drive detects overtorque or undertorque.

Use the L6 [Torque Detection] parameters to set torque detection.

**OFF** : The output current/torque > L6-02 [Torque Detection Level 1], or the output current/torque < L6-02 for longer than the time set in L6-03 [Torque Detection Time 1].

**Note:**

- When L6-01 ≥ 5, the drive will detect when the output current/torque is less than L6-02 for longer than L6-03.
- Refer to [L6: Torque Detection on page 826](#) for more information.

### ■ 18: Torque Detection 2 (N.O.)

Setting Value	Function	Description
18	Torque Detection 2 (N.O.)	<input type="checkbox"/> V/f <input type="checkbox"/> OLVP/M <input type="checkbox"/> EZOLV The terminal activates when the drive detects overtorque or undertorque.

Use the L6 [Torque Detection] parameters to set torque detection.

**ON** : The output current/torque > L6-05 [Torque Detection Level 2], or the output current/torque < L6-05 for longer than the time set in L6-06 [Torque Detection Time 2].

**Note:**

- When L6-04 ≥ 5, the drive will detect when the output current/torque is less than L6-05 for longer than L6-06.
- Refer to [L6: Torque Detection on page 826](#) for more information.

### ■ 19: Torque Detection 2 (N.C.)

Setting Value	Function	Description
19	Torque Detection 2 (N.C.)	<input type="checkbox"/> V/f <input type="checkbox"/> OLVP/M <input type="checkbox"/> EZOLV The terminal deactivates when the drive detects overtorque or undertorque.

Use the L6 [Torque Detection] parameters to set torque detection.

**OFF** : The output current/torque > L6-05 [Torque Detection Level 2], or the output current/torque < L6-05 for longer than the time set in L6-06 [Torque Detection Time 2].

**Note:**

- When L6-04 ≥ 5, the drive will detect when the output current/torque is less than L6-05 for longer than L6-06.
- Refer to [L6: Torque Detection on page 826](#) for more information.

■ 1A: During Reverse

Setting Value	Function	Description
1A	During Reverse	<div style="display: flex; justify-content: space-between; align-items: center;"> <span>V/f</span> <span>OLV/IPM</span> <span>EZOLV</span> </div> <p>The terminal activates when the motor operates in the reverse direction.</p>

**ON** : The motor is operating in the reverse direction.

**OFF** : The motor is operating in the forward direction or the motor stopped.

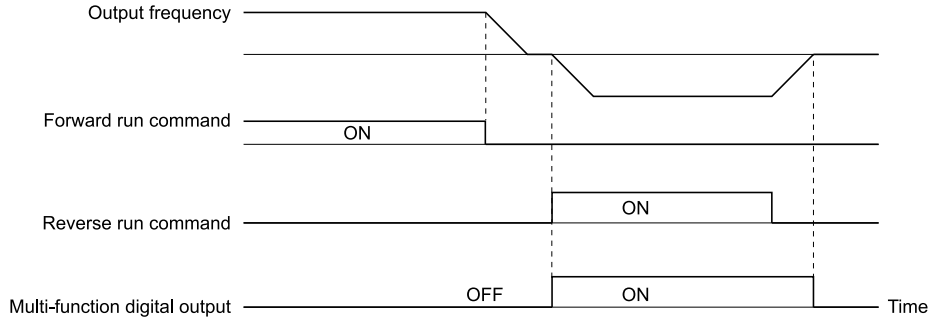

Figure 12.71 Reverse Operation Output Time Chart

■ 1B: During Baseblock (N.C.)

Setting Value	Function	Description
1B	During Baseblock (N.C.)	<div style="display: flex; justify-content: space-between; align-items: center;"> <span>V/f</span> <span>OLV/IPM</span> <span>EZOLV</span> </div> <p>The terminal deactivates during baseblock. When the drive is in baseblock, the drive output transistor stops switching and does not make DC bus voltage.</p>

**ON** : The drive is not in baseblock.

**OFF** : During baseblock

■ 1C: Motor 2 Selected

Setting Value	Function	Description
1C	Motor 2 Selected	<div style="display: flex; justify-content: space-between; align-items: center;"> <span>V/f</span> <span>OLV/IPM</span> <span>EZOLV</span> </div> <p>The terminal activates when you select motor 2.</p>

**ON** : Motor 2 Selected

**OFF** : Motor 1 Selected

■ 1E: Executing Auto-Restart

Setting Value	Function	Description
1E	Executing Auto-Restart	<div style="display: flex; justify-content: space-between; align-items: center;"> <span>V/f</span> <span>OLV/IPM</span> <span>EZOLV</span> </div> <p>The terminal activates when the Auto Restart function is trying to restart after a fault.</p>

The terminal deactivates when the Auto Restart function automatically resets a fault. The terminal deactivates when the Auto Restart function detects the fault again because there were too many restart attempts as specified by L5-01 [Number of Auto Restart Attempts].

**Note:**

Refer to L5: Fault Restart on page 820 for more information.

■ 1F: Motor Overload Alarm (oL1)

Setting Value	Function	Description
1F	Motor Overload Alarm (oL1)	<div style="display: flex; justify-content: space-between; align-items: center;"> <span>V/f</span> <span>OLV/IPM</span> <span>EZOLV</span> </div> <p>The terminal activates when the electronic thermal protection value of the motor overload protective function is a minimum of 90% of the detection level.</p>

**Note:**

Refer to “L1-01: Motor Overload (oL1) Protection” for more information.

## ■ 20: Drive Overheat Pre-Alarm (oH)

Setting Value	Function	Description
20	Drive Overheat Pre-Alarm (oH)	<b>V/f</b> <b>OLV/PM</b> <b>EZOLV</b> The terminal activates when the drive heatsink temperature is at the level set with L8-02 [Overheat Alarm Level].

**Note:**

Refer to “L8-02: Overheat Alarm Level” for more information.

## ■ 21: Safe Torque OFF

Setting Value	Function	Description
21	Safe Torque OFF	<b>V/f</b> <b>OLV/PM</b> <b>EZOLV</b> The terminal activates (safety stop state) when the safety circuit and safety diagnosis circuit are operating correctly and when terminals H1-HC and H2-HC are OFF (Open).

**Note:**

EDM = External Device Monitor

### ON : Safety stop state

Terminals H1-HC and H2-HC are OFF (Open) (safety stop state).

### OFF : Safety circuit fault or RUN/READY

Terminal H1-HC or terminal H2-HC is OFF (Open) (safety circuit fault), or the two terminals are ON or have short circuited (RUN/READY).

## ■ 2F: Maintenance Notification

Setting Value	Function	Description
2F	Maintenance Notification	<b>V/f</b> <b>OLV/PM</b> <b>EZOLV</b> The terminal activates when drive components are at their estimated maintenance period.

Tells the user about the maintenance period for these items:

- IGBT
- Cooling fan
- Capacitor
- Soft charge bypass relay

**Note:**

Refer to “Alarm Outputs for Maintenance Monitors” for more information.

## ■ 30: During Torque Limit

Setting Value	Function	Description
30	During Torque Limit	<b>V/f</b> <b>OLV/PM</b> <b>EZOLV</b> The terminal activates when the torque reference is the torque limit set with L7 parameters, H3-02 or H3-10 [MFAI Function Selection].

**Note:**

Refer to “L7: Torque Limit” for more information.

## ■ 37: During Frequency Output

Setting Value	Function	Description
37	During Frequency Output	<b>V/f</b> <b>OLV/PM</b> <b>EZOLV</b> The terminal activates when the drive outputs frequency.

**ON : The drive is outputting frequency.**

**OFF : The drive is not outputting frequency.**

**Note:**

The terminal deactivates in these conditions:

- During Stop
- During Baseblock
- During DC Injection Braking (initial excitation)
- During Short Circuit Braking
- During Initial Pole Detection

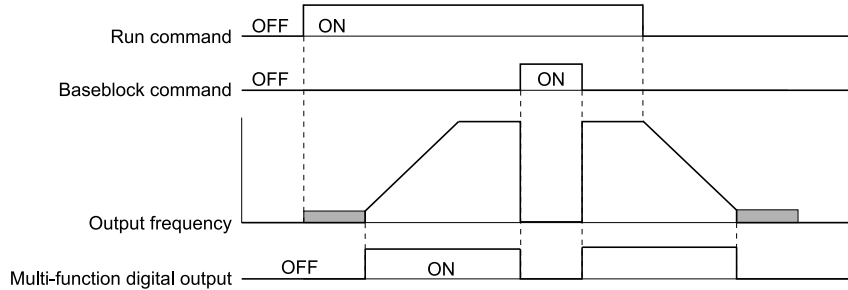

**Figure 12.72 Active Frequency Output Time Chart**

■ **38: Drive Enabled**

Setting Value	Function	Description
38	Drive Enabled	<b>V/f</b> <b>OLV/IPM</b> <b>EZOLV</b> This terminal activates when the <i>H1-xx = 6A [Drive Enable]</i> terminal activates.

■ **39: Watt Hour Pulse Output**

Setting Value	Function	Description
39	Watt Hour Pulse Output	<b>V/f</b> <b>OLV/IPM</b> <b>EZOLV</b> Outputs the pulse that shows the watt hours.

**Note:**

Refer to “H2-06: Watt Hour Output Unit Selection” for more information.

■ **3A: Drive Overheat Alarm**

Setting Value	Function	Description
3A	Drive Overheat Alarm	<b>V/f</b> <b>OLV/IPM</b> <b>EZOLV</b> The terminal activates when the drive heatsink temperature is at the <i>L8-02 [Overheat Alarm Level]</i> setting while <i>L8-03 = 4 [Overheat Pre-Alarm Selection = Operate at Reduced Speed (L8-19)]</i> and the drive is running.

The drive will decrease the frequency reference as specified by *L8-19 [Freq Reduction @ oH Pre-Alarm]*. Carrier frequency reduction is active when *L8-97 = 1 [Carrier Freq Reduce during OH = Enabled]*.

■ **3D: During Speed Search**

Setting Value	Function	Description
3D	During Speed Search	<b>V/f</b> <b>OLV/IPM</b> <b>EZOLV</b> The terminal activates when the drive is doing speed search.

**Note:**

Refer to “b3: Speed Search” for more information.

■ **42: Pressure Reached**

Setting Value	Function	Description
42	Pressure Reached	<b>V/f</b> <b>OLV/IPM</b> <b>EZOLV</b> The terminal activates when the pressure feedback is at the Pressure Setpoint.

The drive uses the Pressure Feedback and *Y4-36 [Pressure Reached Exit Conditions]* to *Y4-40 [Pressure Reached Detection Sel]* for the activation and deactivation conditions.

When the *b5-09 [PID Output Level Selection]* setting changes, the MFDO terminal operation also changes.

- When *b5-09 = 0 [Normal Output (Direct Acting)]*  
The function activates when the feedback is at or above the setpoint for the time set in *Y4-38 [Pressure Reached On Delay Time]*.
- When *b5-09 = 1 [Reverse Output (Reverse Acting)]*  
The function activates when the feedback is at or below the setpoint for the time set in *Y4-38*.

When this function activates, it will use *Y4-36, Y4-37 [Pressure Reached Hysteresis Lvl]*, and *Y4-39 [Pressure Reached Off Delay Time]* to deactivate.

#### ■ 4A: During KEB Ride-Thru

Setting Value	Function	Description
4A	During KEB Ride-Thru	<div style="display: flex; gap: 5px;"> <span>V/f</span> <span>OLV/PM</span> <span>EZOLV</span> </div> The terminal activates during KEB Ride-Thru.

**Note:**

Refer to [KEB Ride-Thru Function on page 805](#) for more information.

#### ■ 4B: During Short Circuit Braking

Setting Value	Function	Description
4B	During Short Circuit Braking	<div style="display: flex; gap: 5px;"> <span>V/f</span> <span>OLV/PM</span> <span>EZOLV</span> </div> The terminal activates during Short Circuit Braking.

**Note:**

- When *A1-02 = 8 [Control Method Selection = EZOLV]*, this function is available only when you use a PM motor.
- Refer to [b2: DC Injection Braking and Short Circuit Braking on page 635](#) for more information.

#### ■ 4C: During Fast Stop

Setting Value	Function	Description
4C	During Fast Stop	<div style="display: flex; gap: 5px;"> <span>V/f</span> <span>OLV/PM</span> <span>EZOLV</span> </div> The terminal activates when the fast stop is in operation.

#### ■ 4D: oH Pre-Alarm Reduction Limit

Setting Value	Function	Description
4D	oH Pre-Alarm Reduction Limit	<div style="display: flex; gap: 5px;"> <span>V/f</span> <span>OLV/PM</span> <span>EZOLV</span> </div> The terminal activates when <i>L8-03 = 4 [Overheat Pre-Alarm Selection = Operate at Reduced Speed (L8-19)]</i> and <i>oH [Heatsink Overheat]</i> does not clear after the drive decreases the frequency for 10 cycles.

**Note:**

Refer to “L8-03: Overheat Pre-Alarm Selection” for more information.

#### ■ 51: Sequence Timer 1

Setting Value	Function	Description
51	Sequence Timer 1	<div style="display: flex; gap: 5px;"> <span>V/f</span> <span>OLV/PM</span> <span>EZOLV</span> </div> The terminal activates when Sequence Timer 1 is active.

#### ■ 52: Sequence Timer 2

Setting Value	Function	Description
52	Sequence Timer 2	<div style="display: flex; gap: 5px;"> <span>V/f</span> <span>OLV/PM</span> <span>EZOLV</span> </div> The terminal activates when Sequence Timer 2 is active.

#### ■ 53: Sequence Timer 3

Setting Value	Function	Description
53	Sequence Timer 3	<div style="display: flex; gap: 5px;"> <span>V/f</span> <span>OLV/PM</span> <span>EZOLV</span> </div> The terminal activates when Sequence Timer 3 is active.

### ■ 54: Sequence Timer 4

Setting Value	Function	Description
54	Sequence Timer 4	<div style="display: flex; gap: 5px;"> <span style="border: 1px solid black; border-radius: 3px; padding: 2px;">V/f</span> <span style="border: 1px solid black; border-radius: 3px; padding: 2px;">OLV/IPM</span> <span style="border: 1px solid black; border-radius: 3px; padding: 2px;">EZOLV</span> </div> <p>The terminal activates when Sequence Timer 4 is active.</p>

### ■ 58: UL6 Underload Detected

Setting Value	Function	Description
58	UL6 Underload Detected	<div style="display: flex; gap: 5px;"> <span style="border: 1px solid black; border-radius: 3px; padding: 2px;">V/f</span> <span style="border: 1px solid black; border-radius: 3px; padding: 2px;">OLV/IPM</span> <span style="border: 1px solid black; border-radius: 3px; padding: 2px;">EZOLV</span> </div> <p>The terminal activates when the drive detected <i>UL6</i> [Underload or Belt Break Detected].</p>

### ■ 60: Internal Cooling Fan Failure

Setting Value	Function	Description
60	Internal Cooling Fan Failure	<div style="display: flex; gap: 5px;"> <span style="border: 1px solid black; border-radius: 3px; padding: 2px;">V/f</span> <span style="border: 1px solid black; border-radius: 3px; padding: 2px;">OLV/IPM</span> <span style="border: 1px solid black; border-radius: 3px; padding: 2px;">EZOLV</span> </div> <p>The terminal activates when the drive detects a cooling fan failure in the drive.</p>

### ■ 61: Pole Position Detection Complete

Setting Value	Function	Description
61	Pole Position Detection Complete	<div style="display: flex; gap: 5px;"> <span style="border: 1px solid black; border-radius: 3px; padding: 2px;">V/f</span> <span style="border: 1px solid black; border-radius: 3px; padding: 2px;">OLV/IPM</span> <span style="border: 1px solid black; border-radius: 3px; padding: 2px;">EZOLV</span> </div> <p>The terminal activates when drive receives a Run command and the drive detects the motor magnetic pole position of the PM motor.</p>

### ■ 62: Modbus Reg 1 Status Satisfied

Setting Value	Function	Description
62	Modbus Reg 1 Status Satisfied	<div style="display: flex; gap: 5px;"> <span style="border: 1px solid black; border-radius: 3px; padding: 2px;">V/f</span> <span style="border: 1px solid black; border-radius: 3px; padding: 2px;">OLV/IPM</span> <span style="border: 1px solid black; border-radius: 3px; padding: 2px;">EZOLV</span> </div> <p>The terminal activates when the bit specified by <i>H2-08</i> [Modbus Register 1 Bit Select] for the MEMOBUS register address set with <i>H2-07</i> [Modbus Register 1 Address Select] activates.</p>

### ■ 63: Modbus Reg 2 Status Satisfied

Setting Value	Function	Description
63	Modbus Reg 2 Status Satisfied	<div style="display: flex; gap: 5px;"> <span style="border: 1px solid black; border-radius: 3px; padding: 2px;">V/f</span> <span style="border: 1px solid black; border-radius: 3px; padding: 2px;">OLV/IPM</span> <span style="border: 1px solid black; border-radius: 3px; padding: 2px;">EZOLV</span> </div> <p>The terminal activates when the bit specified by <i>H2-10</i> [Modbus Register 2 Bit Select] for the MEMOBUS register address set with <i>H2-09</i> [Modbus Register 2 Address Select] activates.</p>

### ■ 69: External Power 24V Supply

Setting Value	Function	Description
69	External Power 24V Supply	<div style="display: flex; gap: 5px;"> <span style="border: 1px solid black; border-radius: 3px; padding: 2px;">V/f</span> <span style="border: 1px solid black; border-radius: 3px; padding: 2px;">OLV/IPM</span> <span style="border: 1px solid black; border-radius: 3px; padding: 2px;">EZOLV</span> </div> <p>The terminal activates when there is an external 24V power supply between terminals PS-AC.</p>

**ON** : The external 24V power supply is supplying power.

**OFF** : The external 24V power supply is not supplying power.

### ■ 6A: Data Logger Error

Setting Value	Function	Description
6A	Data Logger Error	<div style="display: flex; gap: 5px;"> <span style="border: 1px solid black; border-radius: 3px; padding: 2px;">V/f</span> <span style="border: 1px solid black; border-radius: 3px; padding: 2px;">OLV/IPM</span> <span style="border: 1px solid black; border-radius: 3px; padding: 2px;">EZOLV</span> </div> <p>The terminal activates when the drive detects a <i>LoG</i> [Com Error / Abnormal SD card].</p>

### ■ 71: Low PI2 Control Feedback Level

Setting Value	Function	Description
71	Low PI2 Control Feedback Level	<div style="display: flex; gap: 5px;"> <span style="border: 1px solid black; border-radius: 3px; padding: 2px;">V/f</span> <span style="border: 1px solid black; border-radius: 3px; padding: 2px;">OLV/IPM</span> <span style="border: 1px solid black; border-radius: 3px; padding: 2px;">EZOLV</span> </div> <p>The terminal activates when the PI2 Control Feedback Level is less than <i>S3-13</i> [PI2 Control Low Feedback Lvl].</p>



## 72: High PI2 Control Feedback Level

Setting Value	Function	Description
72	High PI2 Control Feedback Level	<b>V/f</b> <b>OLV/PM</b> <b>EZOLV</b> The terminal activates when the PI2 Control Feedback Level is more than S3-15 [PI2 Control High Feedback Lvl].

## 89: Output Current Lim

Setting Value	Function	Description
89	Output Current Lim	<b>V/f</b> <b>OLV/PM</b> <b>EZOLV</b> The terminal activates when the output current limit is limiting the drive output speed.

## 90 to 92: DWEZ Digital Outputs 1 to 3

Setting Value	Function	Description
90 to 92	DWEZ Digital Outputs 1 to 3	<b>V/f</b> <b>OLV/PM</b> <b>EZOLV</b> Sets the DriveWorksEZ digital output. Refer to the DriveWorksEZ online manual for more information.

## 94: Loss of Prime

Setting Value	Function	Description
94	Loss of Prime	<b>V/f</b> <b>OLV/PM</b> <b>EZOLV</b> The terminal activates when the drive is in an LOP [Loss of Prime] condition.

## 95: Thermostat Fault

Setting Value	Function	Description
95	Thermostat Fault	<b>V/f</b> <b>OLV/PM</b> <b>EZOLV</b> The terminal activates when the terminal set for H1-xx = 88 [MFDI Function Selection = Thermostat Fault] is active.

## 96: High Feedback

Setting Value	Function	Description
96	High Feedback	<b>V/f</b> <b>OLV/PM</b> <b>EZOLV</b> The terminal activates when the drive is in a High Feedback Condition as specified by Y1-11 [High Feedback Level] and Y1-12 [High Feedback Lvl Fault Dly Time] and when the drive detects an HFB [High Feedback Sensed] fault or an HIFB [High Feedback Sensed] alarm.

## 97: Low Feedback

Setting Value	Function	Description
97	Low Feedback	<b>V/f</b> <b>OLV/PM</b> <b>EZOLV</b> The terminal activates when the drive is in a Low Feedback Condition as specified by Y1-08 [Low Feedback Level] and Y1-09 [Low Feedback Lvl Fault Dly Time] and when the drive detects an LFB [Low Feedback Sensed] fault or an LOFB [High Feedback Sensed] alarm.

## 9E: Low PI Auxiliary Control Level

Setting Value	Function	Description
9E	Low PI Auxiliary Control Level	<b>V/f</b> <b>OLV/PM</b> <b>EZOLV</b> The terminal activates when the PI Aux Feedback Level is less than YF-09 [PI Aux Control Low Level Detect] or if the drive detects an LOAUX [Low PI Aux Feedback Level] fault.

## 9F: High PI Auxiliary Control Level

Setting Value	Function	Description
9F	High PI Auxiliary Control Level	<b>V/f</b> <b>OLV/PM</b> <b>EZOLV</b> The terminal activates when the PI Aux Feedback Level is more than YF-12 [PI Aux Control High Level Detect] or if the drive detects an HIAUX [High PI Aux Feedback Level] fault.

### ■ A9: RELAY Operator Control

Setting Value	Function	Description
A9	RELAY Operator Control	<p><b>V/f</b> <b>OLV/IPM</b> <b>EZOLV</b></p> <p>The terminal changes to OFF or ON when you push the RELAY ( <b>F3</b> ) button. When the terminal is ON, push <b>F3</b> to turn it OFF. When the terminal is OFF, push <b>F3</b> to turn in ON.</p>

### ■ AA: Utility Delay

Setting Value	Function	Description
AA	Utility Delay	<p><b>V/f</b> <b>OLV/IPM</b> <b>EZOLV</b></p> <p>The terminal activates when the drive is stopped and is waiting for the timer set in <i>Y4-17 [Utility Start Delay]</i> to expire.</p>

### ■ AB: Thrust Mode

Setting Value	Function	Description
AB	Thrust Mode	<p><b>V/f</b> <b>OLV/IPM</b> <b>EZOLV</b></p> <p>The terminal activates when the output frequency is between 0.0 Hz and the value set in <i>Y4-12 [Thrust Frequency]</i> and the Thrust Bearing function is active.</p>

### ■ AC: Setpoint Not Maintained

Setting Value	Function	Description
AC	Setpoint Not Maintained	<p><b>V/f</b> <b>OLV/IPM</b> <b>EZOLV</b></p> <p>The terminal activates when the drive detects <i>NMS [Setpoint Not Met]</i> condition.</p>

### ■ B2: BAS Interlock

Setting Value	Function	Description
B2	BAS Interlock	<p><b>V/f</b> <b>OLV/IPM</b> <b>EZOLV</b></p> <p>The terminal activates when the Run command is active or the drive is outputting the voltage. The drive will use this as an actuation signal for an external damper.</p>

### ■ B8: Pump Fault

Setting Value	Function	Description
B8	Pump Fault	<p><b>V/f</b> <b>OLV/IPM</b> <b>EZOLV</b></p> <p>The terminal activates when one of these faults is active: <i>LFB [Low Feedback Sensed]</i>, <i>HFB [High Feedback Sensed]</i>, <i>NMS [Setpoint Not Met]</i>, or <i>EFx [External Fault (Terminal Sx)]</i>.</p>

### ■ B9: Transducer Loss

Setting Value	Function	Description
B9	Transducer Loss	<p><b>V/f</b> <b>OLV/IPM</b> <b>EZOLV</b></p> <p>The terminal activates when the current into the analog input associated with PID feedback is more than 21 mA or less than 3 mA, or an <i>FDBKL [WIRE Break]</i> Fault or an <i>FDBKL [Feedback Loss Wire Break]</i> Alarm is active.</p>

### ■ BA: PI Auxiliary Control Active

Setting Value	Function	Description
BA	PI Auxiliary Control Active	<p><b>V/f</b> <b>OLV/IPM</b> <b>EZOLV</b></p> <p>The terminal activates when the PI Auxiliary Controller has an effect on the output speed.</p>

### ■ BB: Differential Feedback Exceeded

Setting Value	Function	Description
BB	Differential Feedback Exceeded	<p><b>V/f</b> <b>OLV/IPM</b> <b>EZOLV</b></p> <p>The terminal activates when the difference between the PID Feedback and the value from the terminal set for <i>H3-xx = 2D [Differential Feedback]</i> is more than <i>Y4-18 [Differential Level]</i> for the time set in <i>Y4-19 [Differential Lvl Detection Time]</i>.</p>

### ■ BC: Sleep Active

Setting Value	Function	Description
BC	Sleep Active	<b>V/f</b> <b>OLV/PM</b> <b>EZOLV</b> The terminal activates when the Sleep function is active and the drive is not operating.

**Note:**

The terminal will not activate for Sleep Boost function.

### ■ BD: Start Delay

Setting Value	Function	Description
BD	Start Delay	<b>V/f</b> <b>OLV/PM</b> <b>EZOLV</b> The terminal activates when the Feedback is more than the start level or the Feedback is less than the Inverse PID and the start timer is timing.

**Note:**

You must set *Y1-04 [Sleep Wake-up Level] ≠ 0* and *Y1-05 [Sleep Wake-up Level Delay Time] ≠ 0* to use this function.

The terminal also activates when *b1-11 [Run Delay @ Stop] ≠ 0.0 s* and *b1-03 [Stopping Method Selection = Coast to Stop with Timer]* delayed the start of the drive.

### ■ BE: Pre-Charge

Setting Value	Function	Description
BE	Pre-Charge	<b>V/f</b> <b>OLV/PM</b> <b>EZOLV</b> The terminal activates when the drive is in Pre-Charge Mode.

### ■ C0: HAND Mode

Setting Value	Function	Description
C0	HAND Mode	<b>V/f</b> <b>OLV/PM</b> <b>EZOLV</b> The terminal activates when the drive is in HAND Mode operation.

### ■ C1: AUTO Mode

Setting Value	Function	Description
C1	AUTO Mode	<b>V/f</b> <b>OLV/PM</b> <b>EZOLV</b> The terminal activates when the drive is in AUTO Mode operation.

### ■ C2: OFF Mode

Setting Value	Function	Description
C2	OFF Mode	<b>V/f</b> <b>OLV/PM</b> <b>EZOLV</b> The terminal activates when the drive is in OFF Mode operation.

### ■ C3: Main Feedback Lost

Setting Value	Function	Description
C3	Main Feedback Lost	<b>V/f</b> <b>OLV/PM</b> <b>EZOLV</b> The terminal activates when the drive loses the main PID feedback.

### ■ C4: Backup Feedback Lost

Setting Value	Function	Description
C4	Backup Feedback Lost	<b>V/f</b> <b>OLV/PM</b> <b>EZOLV</b> The terminal activates when the drive loses the backup PID feedback.

### ■ 100 to 1C4: Inverse Outputs of 0 to C4

Setting Value	Function	Description
100 to 1C4	Inverse Outputs of 0 to C4	<div style="display: flex; gap: 5px;"> <span style="border: 1px solid black; padding: 2px;">V/f</span> <span style="border: 1px solid black; padding: 2px;">OLV/PM</span> <span style="border: 1px solid black; padding: 2px;">EZOLV</span> </div> Causes inverse output of the function for the selected MFDO. Uses the last two digits of 1xx to select which function to inversely output.

For example, set  $H2-xx = 10E$  for the inverse output of  $E$  [Fault].

### ◆ H3: Analog Inputs

**WARNING! Sudden Movement Hazard.** Do test runs and examine the drive to make sure that the command references are correct. If you set the command reference incorrectly, it can cause damage to the drive or serious injury or death.

Drives have two analog input terminals, terminals A1 and A2. *H3 parameters* select the functions set to these analog input terminals and adjust signal levels.

Table 12.55 shows the functions that you can set to analog input terminals. Use *H3-02* and *H3-10* [MFAI Function Selection] to set functions.

Table 12.55 MFAI Setting Values

Setting Value	Function	Ref.	Setting Value	Function	Ref.
0	Frequency Reference	779	11	Reverse Torque Limit	784
1	Frequency Gain	780	12	Regenerative Torque Limit	784
2	Auxiliary Frequency Reference 1	780	15	General Torque Limit	784
3	Auxiliary Frequency Reference 2	780	16	Differential PID Feedback	784
4	Output Voltage Bias	780	1F	Not Used	784
5	Accel/Decel Time Gain	780	24	PID Feedback Backup	785
6	DC Injection Braking Current	781	25	PI2 Control Setpoint	785
7	Torque Detection Level	781	26	PI2 Control Feedback	785
8	Stall Prevent Level During Run	781	27	PI Auxiliary Control Feedback	785
9	Output Frequency Lower Limit	782	2B	Emergency Override PID Feedback	785
B	PID Feedback	782	2C	Emergency Override PID Setpoint	785
C	PID Setpoint	782	2D	Differential Level Source	785
D	Frequency Bias	782	2E	Hand Frequency Ref or Setpoint	785
E	Motor Temperature (PTC Input)	782	30	DWEZ Analog Input 1	786
F	Not Used	783	31	DWEZ Analog Input 2	786
10	Forward Torque Limit	783			

**Note:**

All analog input scaling uses gain and bias for adjustment. Set the gain and bias values correctly.

Example Analog Input Settings	Setting of Terminal A1	Frequency Reference
Frequency reference with the gain setting adjusted	<ul style="list-style-type: none"> <li>H3-02 = 0 [Terminal A1 Function Selection = Frequency Reference]</li> <li>H3-03: 200.0 [Terminal A1 Gain Setting = 200%]</li> <li>H3-04 = 0.0 [Terminal A1 Bias Setting = 0.0%]</li> </ul>	<ul style="list-style-type: none"> <li>When you input a 10 V signal, the frequency reference will be 200%.</li> <li>When you input a 5 V signal, the frequency reference will be 100%.</li> </ul> <p>When you input a 5 V or more signal, E1-04 [Maximum Output Frequency] will limit the drive output and the frequency reference will be 100%.</p>
Frequency reference with the negative number bias set	<ul style="list-style-type: none"> <li>H3-02 = 0 [Frequency Reference]</li> <li>H3-03 = 100.0 [100.0%]</li> <li>H3-04 = -25.0 [-25.0%]</li> </ul>	<ul style="list-style-type: none"> <li>When you input a 0 V signal, the frequency reference will be -25%.</li> <li>When you input a 0 V to 2 V signal, the frequency reference will be 0%.</li> <li>When you input a 2 V to 10 V signal, the frequency reference will be 0% to 100%.</li> </ul>

**MEMOBUS/Modbus MFAI 1 to MFAI 3 Function Selection**

Set the MFAI function to MEMOBUS/Modbus register 15C1 to 15C3 (Hex.) [MEMOBUS MFAI 1 to MFAI 3 Command]. Use H3-40 to H3-42 [Mbus Reg 15C1h to 15C3h Input Function] to set the function and use H3-43 [Mbus Reg Inputs FilterTime Const] to set the input filter.

**Table 12.56 MEMOBUS Multi-Function AI Command Register**

Register No. (Hex.)	Name	Range *1	Parameter
15C1	MEMOBUS MFAI 1 Command	-32767 to 32767	H3-40
15C2	MEMOBUS MFAI 2 Command	-32767 to 32767	H3-41
15C3	MEMOBUS MFAI 3 Command	-32767 to 32767	H3-42

\*1 Set as 100% = 4096.

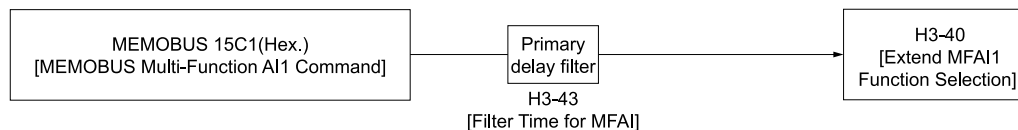

**Figure 12.73 Functional Block Diagram for MEMOBUS MFAI Command 1**

**Note:**

- Refer to H3-xx “MFAI Setting Values” for the analog input setting values.
- When you will not use the terminal, set H3-40 to H3-42 = F. The through mode function is not supported.
- You cannot use H3-40 to H3-42 to set these MFAI terminals:

H3-xx Setting Value	Function
0	Frequency Reference
1	Frequency Gain
2	Auxiliary Frequency Reference 1
3	Auxiliary Frequency Reference 2
30	DWEZ Analog Input 1
31	DWEZ Analog Input 2

◆ **H3: MFAI Parameters**

■ **H3-01: Terminal A1 Signal Level Select**

No. (Hex.)	Name	Description	Default (Range)
H3-01 (0410)	Terminal A1 Signal Level Select	<input type="radio"/> V/f <input type="radio"/> OLV/IPM <input type="radio"/> EZOLV Sets the input signal level for MFAI terminal A1.	0 (0 - 3)

**0 : 0 to 10V (Lower Limit at 0)**

The voltage signal is 0 Vdc to 10 Vdc. The minimum input level limit is 0%. The drive will read a negative input signal caused by gain and bias settings as 0%.

**2 : 4 to 20 mA**

The current signal is 4 mA to 20 mA. The minimum input level limit is 0%. The drive will read a negative input signal caused by gain and bias settings as 0%.

**3 : 0 to 20 mA**

The current signal is 0 mA to 20 mA. The minimum input level limit is 0%. The drive will read a negative input signal caused by gain and bias settings as 0%.

**Note:**

When H3-01 = 0, set Jumper switch S1 to the V side (voltage). When H3-01 = 2, 3, set Jumper switch S1 to the I side (current). The default setting is the V side (voltage).

■ **H3-02: Terminal A1 Function Selection**

No. (Hex.)	Name	Description	Default (Range)
H3-02 (0434)	Terminal A1 Function Selection	<input type="radio"/> V/f <input type="radio"/> OLV/IPM <input type="radio"/> EZOLV Sets the function for MFAI terminal A1.	0 (0 - 31)

■ **H3-03: Terminal A1 Gain Setting**

No. (Hex.)	Name	Description	Default (Range)
H3-03 (0411) RUN	Terminal A1 Gain Setting	<input type="radio"/> V/f <input type="radio"/> OLV/IPM <input type="radio"/> EZOLV Sets the gain of the analog signal input to MFAI terminal A1.	100.0% (-999.9 - +999.9%)

This parameter sets the quantity of reference for the function set for terminal A1 as a percentage when 10 V (or 20 mA) is input.

Use this parameter and H3-04 [Terminal A1 Bias Setting] to adjust the characteristics of the analog input signal to terminal A1.

### ■ H3-04: Terminal A1 Bias Setting

No. (Hex.)	Name	Description	Default (Range)
H3-04 (0412) RUN	Terminal A1 Bias Setting	<b>V/f</b> <b>OLV/PM</b> <b>EZOLV</b> Sets the bias of the analog signal input to MFAI terminal A1.	0.0% (-999.9 - +999.9%)

This parameter sets the bias for the function set for terminal A1 as a percentage when 0 V (4 mA or 0 mA) is input. Use this parameter and *H3-03 [Terminal A1 Gain Setting]* to adjust the characteristics of the analog input signal to terminal A1.

### ■ H3-09: Terminal A2 Signal Level Select

No. (Hex.)	Name	Description	Default (Range)
H3-09 (0417)	Terminal A2 Signal Level Select	<b>V/f</b> <b>OLV/PM</b> <b>EZOLV</b> Sets the input signal level for MFAI terminal A2.	2 (0 - 3)

#### 0 : 0-10V (LowLim=0)

The voltage signal is 0 Vdc to 10 Vdc. The minimum input level is limited to 0%, so that a negative input signal due to gain and bias settings will be read as 0%.

#### 2 : 4 to 20 mA

The current signal is 4 mA to 20 mA. The minimum input level is limited to 0%, so that a negative input signal due to gain and bias settings will be read as 0%.

#### 3 : 0 to 20 mA

The current signal is 0 mA to 20 mA. The minimum input level is limited to 0%, so that a negative input signal due to gain and bias settings will be read as 0%.

#### Note:

When *H3-09* = 0, set Jumper switch S1 to the V side (voltage). When *H3-09* = 2, 3, set Jumper switch S1 to the I side (current). The default setting is the I side (current).

### ■ H3-10: Terminal A2 Function Selection

No. (Hex.)	Name	Description	Default (Range)
H3-10 (0418)	Terminal A2 Function Selection	<b>V/f</b> <b>OLV/PM</b> <b>EZOLV</b> Sets the function for MFAI terminal A2.	Determined by b5-01 (0 - 31)

#### Note:

The default setting for *H3-10* changes when *b5-01 [PID Mode Setting]* changes:

- *b5-01* = 0 [Disabled]: 0
- *b5-01* ≠ 0: B

### ■ H3-11: Terminal A2 Gain Setting

No. (Hex.)	Name	Description	Default (Range)
H3-11 (0419) RUN	Terminal A2 Gain Setting	<b>V/f</b> <b>OLV/PM</b> <b>EZOLV</b> Sets the gain of the analog signal input to MFAI terminal A2.	100.0% (-999.9 - +999.9%)

When 10 V (or 20 mA) is input, this parameter sets the reference quantity for the function set for terminal A2 as a percentage.

Use this parameter and *H3-12 [Terminal A2 Bias Setting]* to adjust the characteristics of the analog input signal to terminal A2.

### ■ H3-12: Terminal A2 Bias Setting

No. (Hex.)	Name	Description	Default (Range)
H3-12 (041A) RUN	Terminal A2 Bias Setting	<b>V/f</b> <b>OLV/PM</b> <b>EZOLV</b> Sets the bias of the analog signal input to MFAI terminal A2.	0.0% (-999.9 - +999.9%)

When 0 V (4 mA or 0 mA) is input, this parameter sets the bias for the function set for terminal A2 as a percentage. Use this parameter and *H3-11 [Terminal A2 Gain Setting]* to adjust the characteristics of the analog input signal to terminal A2.

### ■ H3-13: Analog Input FilterTime Constant

No. (Hex.)	Name	Description	Default (Range)
H3-13 (041B)	Analog Input FilterTime Constant	<b>V/f</b> <b>OLV/PM</b> <b>EZOLV</b> Sets the time constant for primary delay filters on MFAI terminals.	0.03 s (0.00 - 2.00 s)

Apply the primary delay filter to the analog input to enable an analog input signal without the use of high-frequency noise components. An analog input filter prevents irregular drive control. Drive operation becomes more stable as the programmed time becomes longer, but it also becomes less responsive to quickly changing analog signals.

### ■ H3-14: Analog Input Terminal Enable Sel

No. (Hex.)	Name	Description	Default (Range)
H3-14 (041C)	Analog Input Terminal Enable Sel	<b>V/f</b> <b>OLV/PM</b> <b>EZOLV</b> Sets which terminal or terminals to enable when $H1-xx = C$ [ <i>MFDI Function Selection = Analog Terminal Enable Selection</i> ] is activated.	2 (1 - 3)

Input signals do not have an effect on terminals not set as targets.

**1 : Terminal A1 only**

**2 : Terminal A2 only**

**3 : Terminals A1 and A2**

**Note:**

- The ON/OFF operation of terminal Sx set in *Analog Terminal Input Selection* [ $H1-xx = C$ ] has an effect on only the analog input terminal selected with *H3-14*.
- When  $H1-xx \neq C$ , the functions set to terminals A1 and A2 are always enabled.

### ■ H3-16: Terminal A1 Offset

No. (Hex.)	Name	Description	Default (Range)
H3-16 (02F0)	Terminal A1 Offset	<b>V/f</b> <b>OLV/PM</b> <b>EZOLV</b> Sets the offset level for analog signals input to terminal A1. Usually it is not necessary to change this setting.	0 (-500 - +500)

Adds the offset value for the analog input value. For voltage input, this parameter will set the offset when a signal of 0 V is input. For current input, this parameter will set the offset when a signal of 4 mA [ $H3-01 = 2$ ] or 0 mA [ $H3-01 = 3$ ] is input.

### ■ H3-17: Terminal A2 Offset

No. (Hex.)	Name	Description	Default (Range)
H3-17 (02F1)	Terminal A2 Offset	<b>V/f</b> <b>OLV/PM</b> <b>EZOLV</b> Sets the offset level for analog signals input to terminal A2. Usually it is not necessary to change this setting.	0 (-500 - +500)



Adds the offset value for the analog input value. For voltage input, this parameter will set the offset when a signal of 0 V is input. For current input, this parameter will set the offset when a signal of 4 mA [H3-09 = 2] or 0 mA [H3-09 = 3] is input.

### ■ H3-40: Mbus Reg 15C1h Input Function

No. (Hex.)	Name	Description	Default (Range)
H3-40 (0B5C)	Mbus Reg 15C1h Input Function	<input type="checkbox"/> V/f <input type="checkbox"/> OL/PM <input type="checkbox"/> EZOLV Sets the MEMOBUS AI1 function.	F (4 - 2E)

Uses the MFAI function from MEMOBUS/Modbus communications to set the input for the function in MEMOBUS/Modbus register 15C1.

Refer to H3-xx "MFAI Setting Values" for the setting values.

### ■ H3-41: Mbus Reg 15C2h Input Function

No. (Hex.)	Name	Description	Default (Range)
H3-41 (0B5F)	Mbus Reg 15C2h Input Function	<input type="checkbox"/> V/f <input type="checkbox"/> OL/PM <input type="checkbox"/> EZOLV Sets the MEMOBUS AI2 function.	F (4 - 2E)

Uses the MFAI function from MEMOBUS/Modbus communications to set the input for the function in MEMOBUS/Modbus register 15C2.

Refer to H3-xx "MFAI Setting Values" for the setting values.

### ■ H3-42: Mbus Reg 15C3h Input Function

No. (Hex.)	Name	Description	Default (Range)
H3-42 (0B62)	Mbus Reg 15C3h Input Function	<input type="checkbox"/> V/f <input type="checkbox"/> OL/PM <input type="checkbox"/> EZOLV Sets the MEMOBUS AI3 function.	F (4 - 2E)

Uses the MFAI function from MEMOBUS/Modbus communications to set the input for the function in MEMOBUS/Modbus register 15C3.

Refer to H3-xx "MFAI Setting Values" for the setting values.

### ■ H3-43: Mbus Reg Inputs FilterTime Const

No. (Hex.)	Name	Description	Default (Range)
H3-43 (117F)	Mbus Reg Inputs FilterTime Const	<input type="checkbox"/> V/f <input type="checkbox"/> OL/PM <input type="checkbox"/> EZOLV Sets the time constant to apply a primary delay filter to the MEMOBUS analog input register values.	0.00 s (0.00 - 2.00 s)

## ◆ MFAI Setting Value

This section gives information about the functions set with H3-02 and H3-10.

### ■ 0: Frequency Reference

Setting Value	Function	Description
0	Frequency Reference	<input type="checkbox"/> V/f <input type="checkbox"/> OL/PM <input type="checkbox"/> EZOLV The input value from the MFAI terminal set with this function becomes the master frequency reference.

- You can copy the configuration to more than one of the analog input terminals A1 and A2. When you set more than one analog input terminal with the master frequency reference, the sum value becomes the frequency bias.
- If you use this function to set the analog input value as the master frequency reference, set  $b1-01 = 1$  [Frequency Reference Selection 1 = Analog Input]. This setting value is the default value for terminals A1 and A2.
- The frequency reference is the sum of the input values for terminals A1 and A2 when you use them at the same time. For example, when you input a 20% bias to terminal A2 and input a frequency reference of 50% from terminal A1, the calculated frequency reference will be 70% of the maximum output frequency.

### 1: Frequency Gain

Setting Value	Function	Description
1	Frequency Gain	<b>V/f</b> <b>OLV/IPM</b> <b>EZOLV</b> The drive multiplies the analog frequency reference with the input value from the MFAI set with this function.

Example: When you set frequency gain for terminal A2

- $H3-10 = 1$  [Terminal A2 Function Selection = Frequency Gain]
- A 50% frequency gain is input to terminal A2
- A frequency reference of 80% is input from terminal A1

The calculated frequency reference is 40% of the maximum output frequency.

### 2: Auxiliary Frequency Reference 1

Setting Value	Function	Description
2	Auxiliary Frequency Reference 1	<b>V/f</b> <b>OLV/IPM</b> <b>EZOLV</b> Sets Reference 2 through multi-step speed reference to enable the command reference (Auxiliary Frequency Reference 1) from the analog input terminal set here. This value is a percentage where the Maximum Output Frequency setting is a setting value of 100%.

### 3: Auxiliary Frequency Reference 2

Setting Value	Function	Description
3	Auxiliary Frequency Reference 2	<b>V/f</b> <b>OLV/IPM</b> <b>EZOLV</b> Sets Reference 3 through multi-step speed reference to enable the command reference (Auxiliary Frequency Reference 2) from the analog input terminal set here. This value is a percentage where the Maximum Output Frequency setting is a setting value of 100%.

### 4: Output Voltage Bias

Setting Value	Function	Description
4	Output Voltage Bias	<b>V/f</b> <b>OLV/IPM</b> <b>EZOLV</b> Set this parameter to input a bias signal and amplify the output voltage.

The gain (%) for the MFAI terminals A1 and A2 is 100% of the voltage class standard, which is 208 V for 208 V class drives and 480 V for 480 V class drives. The bias (%) for MFAI terminals A1 and A2 is 100% of the voltage configured for  $E1-05$  [Maximum Output Voltage].

**Note:**

Parameters  $H3-03$  [Terminal A1 Gain Setting] and  $H3-11$  [Terminal A2 Gain Setting] independently set the gain for each terminal A1 and A2. Parameters  $H3-04$  [Terminal A1 Bias Setting] and  $H3-12$  [Terminal A2 Bias Setting] independently set the bias for each terminal A1 and A2.

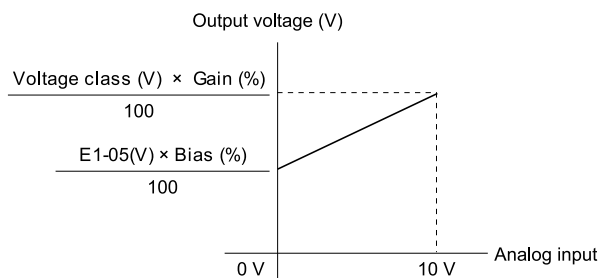

Figure 12.74 Output Voltage Bias through Analog Input

### 5: Accel/Decel Time Gain

Setting Value	Function	Description
5	Accel/Decel Time Gain	<b>V/f</b> <b>OLV/IPM</b> <b>EZOLV</b> Enters a signal to adjust the gain used for $C1-01$ to $C1-04$ [Acceleration/Deceleration Times 1 and 2] and $C1-09$ [Fast Stop Time] when the full scale analog signal (10 V or 20 mA) is 100%.

When you enable  $C1-01$  [Acceleration Time 1], the acceleration time is:

$$\text{Acceleration Time 1} = \text{Setting value of } C1-01 \times \text{acceleration and deceleration time gain} / 100$$

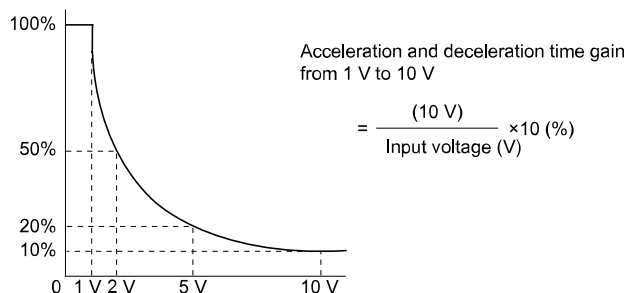

Figure 12.75 Acceleration/Deceleration Time Gain through Analog Input

## 6: DC Injection Braking Current

Setting Value	Function	Description
6	DC Injection Braking Current	<input type="radio"/> V/f <input type="radio"/> OLV/PM <input type="radio"/> EZOLV Enters a signal to adjust the current level used for DC Injection Braking when the drive rated output current is 100%.

### Note:

When you set this function, it will disable the setting value of b2-02 [DC Injection Braking Current].

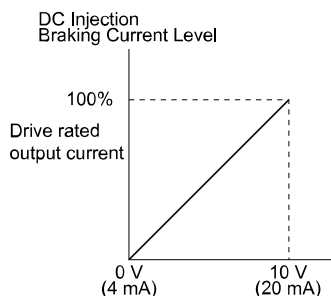

Figure 12.76 DC Injection Braking Current through Analog Input

## 7: Torque Detection Level

Setting Value	Function	Description
7	Torque Detection Level	<input type="radio"/> V/f <input type="radio"/> OLV/PM <input type="radio"/> EZOLV Enters a signal to adjust the overtorque/undertorque detection level.

When A1-02 = 0, 5 [Control Method Selection = V/f, OLV/PM], the drive rated current is 100%. When A1-02 = 8 [EZOLV], the motor rated torque is 100%.

### Note:

Use this function with L6-01 [Torque Detection Selection 1]. This parameter functions as an alternative to L6-02 [Torque Detection Level 1].

## 8: Stall Prevent Level During Run

Setting Value	Function	Description
8	Stall Prevent Level During Run	<input type="radio"/> V/f <input type="radio"/> OLV/PM <input type="radio"/> EZOLV Enters a signal to adjust the stall prevention level during run if the drive rated current is 100%.

### Note:

The Stall Prevent Level During Run is based on the smaller of these two values:

- Analog input value of MFAI terminal
- L3-06 [Stall Prevent Level during Run]

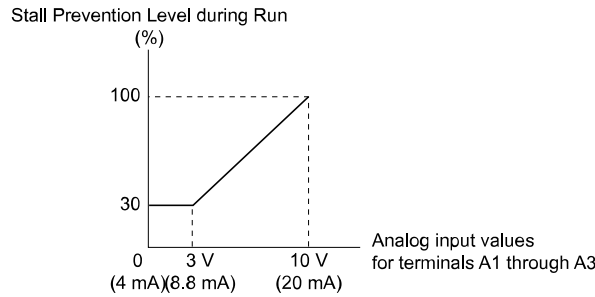

Figure 12.77 Stall Prevention Level during Run with Analog Input

### ■ 9: Output Frequency Lower Limit

Setting Value	Function	Description
9	Output Frequency Lower Limit	<b>V/f</b> <b>OLV/PM</b> <b>EZOLV</b> Enters a signal to adjust the output frequency lower limit level as a percentage of the maximum output frequency.

### ■ B: PID Feedback

Setting Value	Function	Description
B	PID Feedback	<b>V/f</b> <b>OLV/PM</b> <b>EZOLV</b> Enter the PID feedback value as a percentage of the maximum output frequency.

When you use this function, set  $b5-01 \neq 0$  [PID Mode Setting  $\neq$  Disabled].

### ■ C: PID Setpoint

Setting Value	Function	Description
C	PID Setpoint	<b>V/f</b> <b>OLV/PM</b> <b>EZOLV</b> Enters the PID setpoint as a percentage of the maximum output frequency.

When you use this function, set  $b5-01 \neq 0$  [PID Mode Setting  $\neq$  Disabled].

**Note:**

Configuring this function disables the frequency reference set with  $b1-01$  [Frequency Reference Selection 1].

### ■ D: Frequency Bias

Setting Value	Function	Description
D	Frequency Bias	<b>V/f</b> <b>OLV/PM</b> <b>EZOLV</b> Enters the bias value added to the frequency reference as a percentage of the maximum output frequency.

The drive adds the input value from the MFAI terminal set with this function to the frequency reference as the bias value.

**Note:**

When you select  $d1-01$  to  $d1-08$  or  $d1-17$  [Reference 1 to 8 or Jog Reference] as the frequency reference, it will disable this function.

### ■ E: Motor Temperature (PTC Input)

Setting Value	Function	Description
E	Motor Temperature (PTC Input)	<b>V/f</b> <b>OLV/PM</b> <b>EZOLV</b> Uses the motor Positive Temperature Coefficient (PTC) thermistor to prevent heat damage to the motor as a percentage of the current value when the 10 V analog signal is input.

- You can use the Positive Temperature Coefficient (PTC) thermistor as an auxiliary or alternative detection function for  $oL1$  [Motor Overload] problems to help prevent heat damage to motors. If the PTC input signal is more than the overload alarm level,  $oH3$  [Motor Overheat (PTC Input)] will flash on the keypad.
- When the drive detects  $oH3$ , the motor stops with the setting in  $L1-03$ . When the drive detects  $oH4$ , the motor stops with the setting in  $L1-04$ . When the drive incorrectly detects motor overheating problems, set  $L1-05$ .

## ■ F: Not Used

Setting Value	Function	Description
F	Not Used	<div style="display: flex; justify-content: space-between; align-items: center;"> <span>V/f</span> <span>OLV/PM</span> <span>EZOLV</span> </div> Use this setting for unused terminals or to use terminals in through mode.

When you set a terminal that is not in use to F, you can use the signal input to the terminal as PLC analog signal input through MEMOBUS/Modbus communications or the communication option. This input signal does not have an effect on drive operation. This functions the same as setting 1F (Through Mode).

## ■ 10: Forward Torque Limit

Setting Value	Function	Description
10	Forward Torque Limit	<div style="display: flex; justify-content: space-between; align-items: center;"> <span>V/f</span> <span>OLV/PM</span> <span>EZOLV</span> </div> Enters the forward torque limit when the motor rated torque is 100%.

**WARNING! Sudden Movement Hazard.** Set correct torque limits for applications, for example elevator applications. If you set torque limits incorrectly, motor torque that is not sufficient can cause damage to equipment and cause serious injury or death.

### Torque Limit Configuration Method

Use one of these methods to set torque limits:

- Use L7-01 to L7-04 [Torque Limit] to set the four torque limit quadrants individually.
- Use MFAI to set the four torque limit quadrants individually. Set H3-02, H3-10 = 10, 11, 12 [MFAI Function Select = Forward/Reverse/Regenerative Torque Limit].
- Use MFAI to set all four torque limit quadrants together. Set H3-02, H3-10 = 15 [General Torque Limit].
- Use a communication option to set all four torque limit quadrants together.

Figure 12.78 shows the configuration method for each quadrant.

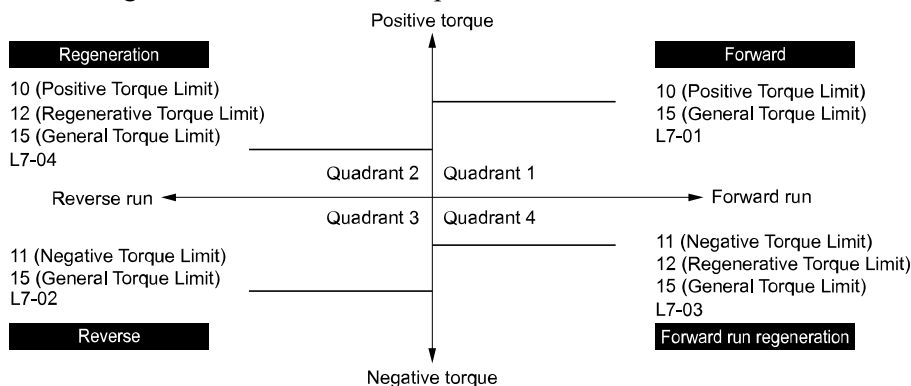

Figure 12.78 Torque Limits and Analog Input Setting Parameters

#### Note:

- When L7-01 to L7-04 and analog inputs or communication option torque limits set torque limits for the same quadrant, the lower value is enabled. In this example of parameter settings, the torque limit for quadrant 1 is 130% and the torque limit for quadrants 2, 3, and 4 is 150%. Settings: L7-01 = 130%, L7-02 to L7-04 = 200%, and MFAI torque limit = 150%
- The drive output current limits maximum output torque to 120% of the rated output current. The actual output torque is not more than the limits of the drive rated output current when you set the torque limit to a high value.

If you use drives in applications where the vertical axis can fall, make sure that you obey these precautions:

- Correctly configure drives and motors.
- Correctly set parameters.
- You can change parameter values after you do Auto-Tuning.
- Use a system that will not let the vertical axis fall if the drive fails.

Figure 12.79 shows the relation between torque limits from parameters and torque limits from analog input.

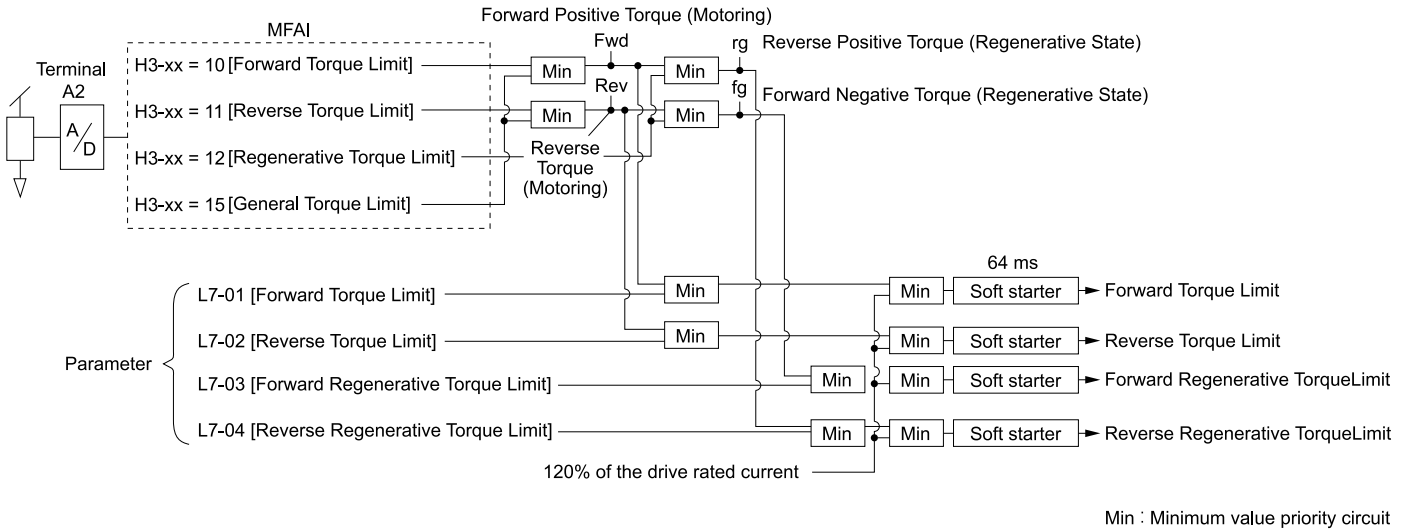

Figure 12.79 Torque Limits from Parameters and Analog Inputs

■ 11: Reverse Torque Limit

Setting Value	Function	Description
11	Reverse Torque Limit	<input type="checkbox"/> V/f <input type="checkbox"/> OLVP/PM <input checked="" type="checkbox"/> EZOLV Enters the load torque limit if the motor rated torque is 100%.

Note:

When you use L7-01 to L7-04 and analog inputs to set torque limits for the same quadrant, it will enable the lower torque limit.

■ 12: Regenerative Torque Limit

Setting Value	Function	Description
12	Regenerative Torque Limit	<input type="checkbox"/> V/f <input type="checkbox"/> OLVP/PM <input checked="" type="checkbox"/> EZOLV Enters the regenerative torque limit if the motor rated torque is 100%.

Note:

When you use L7-01 to L7-04 and analog inputs to set torque limits for the same quadrant, it will enable the lower torque limit.

■ 15: General Torque Limit

Setting Value	Function	Description
15	General Torque Limit	<input type="checkbox"/> V/f <input type="checkbox"/> OLVP/PM <input checked="" type="checkbox"/> EZOLV Enters the torque limit that is the same for all quadrants for forward, reverse, and regenerative operation if the motor rated torque is 100%.

■ 16: Differential PID Feedback

Setting Value	Function	Description
16	Differential PID Feedback	<input checked="" type="checkbox"/> V/f <input type="checkbox"/> OLVP/PM <input type="checkbox"/> EZOLV Enters the PID differential feedback value if the full scale analog signal (10 V or 20 mA) is 100%.

The drive uses the deviation between the PID feedback and the differential feedback value signals to calculate the PID input.

■ 1F: Not Used

Setting Value	Function	Description
1F	Not Used	<input checked="" type="checkbox"/> V/f <input type="checkbox"/> OLVP/PM <input type="checkbox"/> EZOLV Use this setting for unused terminals or to use terminals in through mode.

When you set a terminal that you do not use to 1F, you can use the signal that is input to that terminal as the PLC analog signal input from MEMOBUS/Modbus communications or the communication option. This input signal does not have an effect on drive operation. This signal functions the same as F (Through Mode).

### ■ 24: PID Feedback Backup

Setting Value	Function	Description
24	PID Feedback Backup	<b>V/f</b> <b>OLV/PM</b> <b>EZOLV</b> Enters the PID Feedback Backup signal for the drive to use when it loses the primary PID feedback set for $H3-xx = B$ [PID Feedback].

### ■ 25: PI2 Control Setpoint

Setting Value	Function	Description
25	PI2 Control Setpoint	<b>V/f</b> <b>OLV/PM</b> <b>EZOLV</b> Enters the PI2 Control setpoint level as a percentage of the $S3-02$ [PI2 Control Transducer Scale] value.

### ■ 26: PI2 Control Feedback

Setting Value	Function	Description
26	PI2 Control Feedback	<b>V/f</b> <b>OLV/PM</b> <b>EZOLV</b> Enters the PI2 Control feedback level as a percentage of the $S3-02$ [PI2 Control Transducer Scale] value.

### ■ 27: PI Auxiliary Control Feedback

Setting Value	Function	Description
27	PI Auxiliary Control Feedback	<b>V/f</b> <b>OLV/PM</b> <b>EZOLV</b> Enters the PI Auxiliary Control feedback value when $YF-01 = 1$ [PI Aux Control Selection = Enabled].

### ■ 2B: Emergency Override PID Feedback

Setting Value	Function	Description
2B	Emergency Override PID Feedback	<b>V/f</b> <b>OLV/PM</b> <b>EZOLV</b> This input is the PID Feedback source when Emergency Override is running in PID mode ( $S6-02 = 2$ or $3$ [Emergency Override Ref Selection = System PID Mode or Independent PID Mode]).

### ■ 2C: Emergency Override PID Setpoint

Setting Value	Function	Description
2C	Emergency Override PID Setpoint	<b>V/f</b> <b>OLV/PM</b> <b>EZOLV</b> This input is the PID Setpoint source when Emergency Override is running in PID mode ( $S6-02 = 2$ or $3$ [Emergency Override Ref Selection = System PID Mode or Independent PID Mode]).

### ■ 2D: Differential Level Source

Setting Value	Function	Description
2D	Differential Level Source	<b>V/f</b> <b>OLV/PM</b> <b>EZOLV</b> Enters a feedback value to calculate the Differential Level between the <i>Differential Level Source</i> feedback and the primary PID Feedback [ $H3-xx = B$ ].

### ■ 2E: HAND Frequency Ref or Setpoint

Setting Value	Function	Description
2E	HAND Frequency Ref or Setpoint	<b>V/f</b> <b>OLV/PM</b> <b>EZOLV</b> Enters the $S5-05$ [HAND Frequency Reference] value or the $S5-06$ [HAND Setpoint] value. When $S5-01 = 0$ [HAND Frequency Reference Source = HAND Analog Input] and $S5-03 = 0$ [HAND Mode PI Selection = Disabled], the drive enters HAND Frequency Reference. When $b5-01 \neq 0$ , $S5-01 = 0$ , and $S5-03 = 1$ [Enabled], the drive enters HAND Setpoint.

■ 30: DWEZ Analog Input 1

Setting Value	Function	Description
30	DWEZ Analog Input 1	<b>V/f</b> <b>OLV/IPM</b> <b>EZOLV</b> Use with DriveWorksEZ. Refer to the DriveWorksEZ online manual for more information.

■ 31: DWEZ Analog Input 2

Setting Value	Function	Description
31	DWEZ Analog Input 2	<b>V/f</b> <b>OLV/IPM</b> <b>EZOLV</b> Use with DriveWorksEZ. Refer to the DriveWorksEZ online manual for more information.

◆ H4: Analog Outputs

H4 parameters set the drive analog monitors. These parameters select monitor parameters, adjust gain and bias, and select output signal levels.

■ Calibrate Meters Connected to MFAO Terminals FM and AM

To calibrate the meters connected to terminals FM and AM, use these parameters:

- H4-02 [Terminal FM Analog Output Gain]
- H4-03 [Terminal FM Analog Output Bias]
- H4-05 [Terminal AM Analog Output Gain]
- H4-06 [Terminal AM Analog Output Bias]

Set these parameters where the output voltage of 10 V and output current of 20 mA are 100% of the signal level. Use jumper switch S5 and H4-07 [Terminal FM Signal Level Select] or H4-08 [Terminal AM Signal Level Select] to select the voltage output and current output.

No.	Name	Range	Default
H4-02	Terminal FM Analog Output Gain	-999.9 - +999.9%	100.0%
H4-03	Terminal FM Analog Output Bias	-999.9 - +999.9%	0.0%
H4-05	Terminal AM Analog Output Gain	-999.9 - +999.9%	50.0%
H4-06	Terminal AM Analog Output Bias	-999.9 - +999.9%	0.0%
H4-07	Terminal FM Signal Level Select	0: 0 to 10 Vdc 2: 4 to 20 mA	0
H4-08	Terminal AM Signal Level Select	0: 0 to 10 Vdc 2: 4 to 20 mA	0

Figure 12.80 and Figure 12.81 show the gain and bias when H4-07 = 0 [0 to 10 Vdc] and H4-08 = 0 [0 to 10 Vdc].

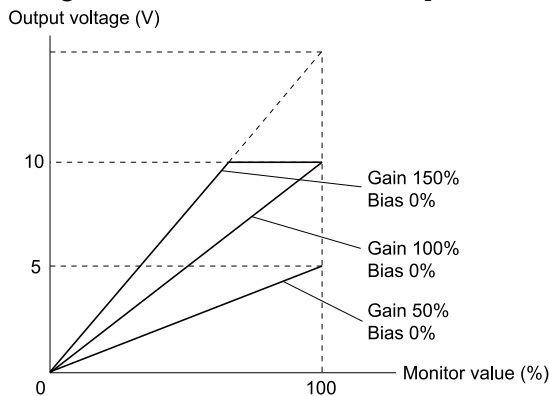

Figure 12.80 Analog Output Gain/Bias Configuration Example 1

For example, when the parameter value set to analog output is 0, and a 3 V signal is output to terminal FM, H4-03 [Terminal FM Analog Output Bias] is set to 30%.



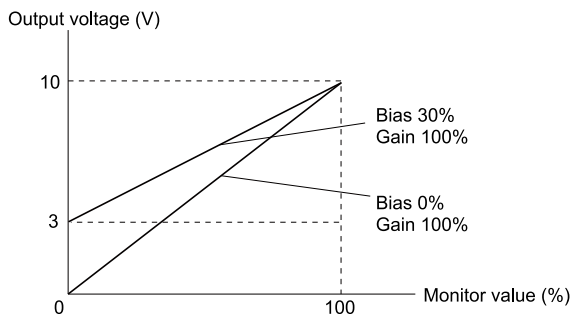

Figure 12.81 Analog Output Gain/Bias Configuration Example 2

### Calibrate Terminal FM

Stop the drive to calibrate meters. Use this procedure to calibrate:

1. Show *H4-02 [Terminal FM Analog Output Gain]* on the keypad.  
Terminal FM outputs the analog signal when the monitor item that you set in *H4-01 [Terminal FM Analog Output Select]* is 100%.
2. Adjust *H4-02* while referencing the meter scale connected to terminal FM.
3. Show *H4-03 [Terminal FM Analog Output Bias]* on the keypad.  
Terminal FM outputs the analog signal when the monitor item that you set in *H4-01* is 0%.
4. Adjust *H4-03* while referencing the meter scale connected to terminal FM.

### Calibrate Terminal AM

Stop the drive to calibrate meters. Use this procedure to calibrate:

1. Show *H4-05 [Terminal AM Analog Output Gain]* on the keypad.  
Terminal AM outputs the analog signal when the monitor item that you set in *H4-04 [Terminal AM Analog Output Select]* is 100%.
2. Adjust *H4-05* while referencing the meter scale connected to terminal AM.
3. Show *H4-06 [Terminal AM Analog Output Bias]* on the keypad.  
Terminal AM outputs the analog signal when the monitor item that you set in *H4-04* is 0%.
4. Adjust *H4-06* while referencing the meter scale connected to terminal AM.

## ■ H4-01: Terminal FM Analog Output Select

No. (Hex.)	Name	Description	Default (Range)
H4-01 (041D)	Terminal FM Analog Output Select	<input type="checkbox"/> V/f <input type="checkbox"/> OLVP/M <input type="checkbox"/> EZOLV Sets the monitor number to send from MFAO terminal FM.	102 (000 - 999)

Set the *x-xx* part of the *Ux-xx [Monitor]*. For example, set *H4-01 = 102* to monitor *U1-02 [Output Frequency]*.

#### Note:

- You cannot use all of the monitors in all of the control methods.
- When you use the terminal in through mode, set this parameter to *000* or *031*. You can set the terminal FM output level from the PLC through MEMOBUS/Modbus communications or the communication option.

## ■ H4-02: Terminal FM Analog Output Gain

No. (Hex.)	Name	Description	Default (Range)
H4-02 (041E) RUN	Terminal FM Analog Output Gain	<input type="checkbox"/> V/f <input type="checkbox"/> OLVP/M <input type="checkbox"/> EZOLV Sets the gain of the monitor signal that is sent from MFAO terminal FM.	100.0% (-999.9 - +999.9%)

The analog signal output from the FM terminal is a maximum of  $\pm 10$  V (or 20 mA). Select the signal level with *H4-07 [Terminal FM Signal Level Select]*.

### ■ H4-03: Terminal FM Analog Output Bias

No. (Hex.)	Name	Description	Default (Range)
H4-03 (041F) RUN	Terminal FM Analog Output Bias	<input type="radio"/> V/f <input type="radio"/> OLV/PM <input type="radio"/> EZOLV Sets the bias of the monitor signal that is sent from MFAO terminal FM.	0.0% (-999.9 - +999.9%)

The analog signal output from the FM terminal is a maximum of  $\pm 10$  V (or 20 mA). Select the signal level with *H4-07 [Terminal FM Signal Level Select]*.

### ■ H4-04: Terminal AM Analog Output Select

No. (Hex.)	Name	Description	Default (Range)
H4-04 (0420)	Terminal AM Analog Output Select	<input type="radio"/> V/f <input type="radio"/> OLV/PM <input type="radio"/> EZOLV Sets the monitoring number to be output from the MFAO terminal AM.	103 (000 - 999)

Set the *x-xx* part of the *Ux-xx [Monitor]*. For example, set *H4-04 = 103* to monitor *U1-03 [Output Current]*.

#### Note:

- You cannot use all of the monitors in all of the control methods.
- When you use the terminal in through mode, set this parameter to *000* or *031*. You can set the terminal AM output level from the PLC through MEMOBUS/Modbus communications or the communication option.

### ■ H4-05: Terminal AM Analog Output Gain

No. (Hex.)	Name	Description	Default (Range)
H4-05 (0421) RUN	Terminal AM Analog Output Gain	<input type="radio"/> V/f <input type="radio"/> OLV/PM <input type="radio"/> EZOLV Sets the gain of the monitor signal that is sent from MFAO terminal AM.	50.0% (-999.9 - +999.9%)

The analog signal output from the AM terminal is a maximum of  $\pm 10$  V (or 20 mA). Select the signal level with *H4-08 [Terminal AM Signal Level Select]*.

Example settings:

When the output current of a monitoring item is 100% (drive rated current) in these examples, the voltage of AM terminal outputs at 5 V (50% of 10 V). Subsequently, the output current at the time the AM terminal outputs a maximum voltage of 10 V will be 200% of the drive rated current.

- *H4-04 = 103 [Terminal AM Analog Output Select = Output Current]*
- *H4-05 = 50.0%*
- *H4-06 = 0.0% [Terminal AM Analog Output Bias = 0.0%]*
- *H4-08 = 0 [0 to 10 V]*

### ■ H4-06: Terminal AM Analog Output Bias

No. (Hex.)	Name	Description	Default (Range)
H4-06 (0422) RUN	Terminal AM Analog Output Bias	<input type="radio"/> V/f <input type="radio"/> OLV/PM <input type="radio"/> EZOLV Sets the bias of the monitor signal that is sent from MFAO terminal AM.	0.0% (-999.9 - +999.9%)

The analog signal output from the AM terminal is a maximum of  $\pm 10$  V (or 20 mA). Select the signal level with *H4-08 [Terminal AM Signal Level Select]*.

### ■ H4-07: Terminal FM Signal Level Select

No. (Hex.)	Name	Description	Default (Range)
H4-07 (0423)	Terminal FM Signal Level Select	<input type="radio"/> V/f <input type="radio"/> OLV/PM <input type="radio"/> EZOLV Sets the MFAO terminal FM output signal level.	0 (0, 2)

**Note:**

Make sure that you also set jumper S5 on the control circuit terminal block when you change this parameter.

**0 : 0 to 10 Vdc**

**2 : 4 to 20 mA**

### ■ H4-08: Terminal AM Signal Level Select

No. (Hex.)	Name	Description	Default (Range)
H4-08 (0424)	Terminal AM Signal Level Select	<input type="radio"/> V/f <input type="radio"/> OLV/PM <input type="radio"/> EZOLV Sets the MFAO terminal AM output signal level.	0 (0, 2)

**Note:**

Make sure that you also set jumper S5 on the control circuit terminal block when you change this parameter.

**0 : 0 to 10 Vdc**

**2 : 4 to 20 mA**

### ■ H4-20: Analog Power Monitor 100% Level

No. (Hex.)	Name	Description	Default (Range)
H4-20 (0B53)	Analog Power Monitor 100% Level	<input type="radio"/> V/f <input type="radio"/> OLV/PM <input type="radio"/> EZOLV Sets the level at 10 V when you set U1-08 [Output Power] for analog output.	0.00 kW (0.00 - 650.00 kW)

**Note:**

• When H4-20 = 0.00 kW, the output power monitor 10 V level = motor rated power. The setting changes when the A1-02 [Control Method Selection] value changes:

– A1-02 = 0 [V/f]: E2-11 [Motor Rated Power]

– A1-02 = 5 [OLV/PM]: E5-02 [PM Motor Rated Power]

– A1-02 = 8 [EZOLV]: E9-07 [Motor Rated Power]

## ◆ H5: Memobus/Modbus Communication

H5 parameters configure the drive to use MEMOBUS/Modbus communications.

You can use the MEMOBUS/Modbus protocol over the RS-485 port (terminals D+ and D-) in the drive to use serial communication with programmable controllers (PLC).

### ■ H5-01: Drive Node Address

No. (Hex.)	Name	Description	Default (Range)
H5-01 (0425)	Drive Node Address	<input type="radio"/> V/f <input type="radio"/> OLV/PM <input type="radio"/> EZOLV Sets the communication slave address for drives.	1FH (0 - FFH)

**Note:**

• Restart the drive after you change the parameter setting.

• Setting 0 will not let the drive respond to MEMOBUS/Modbus communications.

• When Y1-01 = 3 [Multiplex Mode = Memobus Network], the setting range changes when the Y9-25 [Highest Node Address] setting changes.

To enable the drive to communicate with the controller (master) over MEMOBUS/Modbus communications, you must set the drive with a slave address. Set H5-01 ≠ 0.

Set a slave address that is different from other slave devices.

### ■ H5-02: Communication Speed Selection

No. (Hex.)	Name	Description	Default (Range)
H5-02 (0426)	Communication Speed Selection	<input type="radio"/> V/f <input type="radio"/> OLV/PM <input type="radio"/> EZOLV Sets the communications speed for MEMOBUS/Modbus communications.	3 (0 - 8)

**Note:**

Re-energize the drive or set  $H5-20 = 1$  [*Communication Parameters Reload = Reload Now*] after you change the parameter setting.

- 0 : 1200 bps**
- 1 : 2400 bps**
- 2 : 4800 bps**
- 3 : 9600 bps**
- 4 : 19.2 kbps**
- 5 : 38.4 kbps**
- 6 : 57.6 kbps**
- 7 : 76.8 kbps**
- 8 : 115.2 kbps**

**■ H5-03: Communication Parity Selection**

No. (Hex.)	Name	Description	Default (Range)
H5-03 (0427)	Communication Parity Selection	<div style="display: flex; gap: 5px;"> <span style="border: 1px solid black; padding: 2px;">V/f</span> <span style="border: 1px solid black; padding: 2px;">OLV/PM</span> <span style="border: 1px solid black; padding: 2px;">EZOLV</span> </div> Sets the communications parity used for MEMOBUS/Modbus communications.	0 (0 - 2)

**Note:**

Re-energize the drive or set  $H5-20 = 1$  [*Communication Parameters Reload = Reload Now*] after you change the parameter setting.

- 0 : No parity**
- 1 : Even parity**
- 2 : Odd parity**

**■ H5-04: Communication Error Stop Method**

No. (Hex.)	Name	Description	Default (Range)
H5-04 (0428)	Communication Error Stop Method	<div style="display: flex; gap: 5px;"> <span style="border: 1px solid black; padding: 2px;">V/f</span> <span style="border: 1px solid black; padding: 2px;">OLV/PM</span> <span style="border: 1px solid black; padding: 2px;">EZOLV</span> </div> Sets the motor Stopping Method when the drive detects a Modbus Communication Error condition.	3 (0 - 4)

**0 : Ramp to Stop**

The drive ramps the motor to stop in the deceleration time. Fault relay output terminal MA-MC activates and MB-MC deactivates.

**1 : Coast to Stop**

The output turns off and the motor coasts to stop. Fault relay output terminal MA-MC turns activates and MB-MC deactivates.

**2 : Fast Stop (Use C1-09)**

The drive stops the motor in the deceleration time set in  $C1-09$  [*Fast Stop Time*]. Fault relay output terminal MA-MC activates and MB-MC deactivates.

**3 : Alarm Only**

The keypad shows a  $CE$  [*Modbus Communication Error*] alarm and the drive continues operation. The output terminal set for *Alarm* [ $H2-01$  to  $H2-03 = 10$ ] activates.

**4 : Run at H5-34 (CE Go-To-Freq)**

The keypad shows a  $CE$  [*Run at H5-34 (CE Go-To-Freq)*] alarm and the drive will operate at the speed set in  $H5-34$  [*Comm Error (CE) Go-To-Frequency*] when a Communication Error condition occurs.

When  $H5-35$  [*Comm Error (CE) Go-To-Timeout*] > 0 and if the Communication Error condition continues for longer than the time set in  $H5-35$ , the drive will coast to stop and detect a  $CE$  [*Modbus Communication Error*] fault.

[Figure 12.82](#) shows the time chart for the conditions when the drive will detect a  $CE$  alarm or a  $CE$  fault.



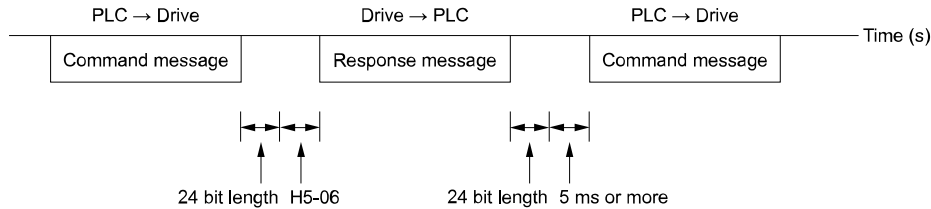

Figure 12.83 Drive Transmit Wait Time

■ H5-08: Communication Protocol Selection

No. (Hex.)	Name	Description	Default (Range)
H5-08 (062D)	Communication Protocol Selection	<input type="checkbox"/> V/f <input type="checkbox"/> OLV/PM <input type="checkbox"/> EZOLV Selects the communication protocol.	0 (0 - 3)

0 : Modbus/MEMOBUS

1 : Metasys/N2

2 : Apogee/P1

3 : BACnet

■ H5-09: CE Detection Time

No. (Hex.)	Name	Description	Default (Range)
H5-09 (0435)	CE Detection Time	<input type="checkbox"/> V/f <input type="checkbox"/> OLV/PM <input type="checkbox"/> EZOLV Sets the detection time for CE [Modbus Communication Error] issues when communication stops.	2.0 s (0.0 - 10.0 s)

■ H5-10: Modbus Register 0025H Unit Sel

No. (Hex.)	Name	Description	Default (Range)
H5-10 (0436)	Modbus Register 0025H Unit Sel	<input type="checkbox"/> V/f <input type="checkbox"/> OLV/PM <input type="checkbox"/> EZOLV Sets the unit of measure used for the MEMOBUS/Modbus communications monitor register 0025H (output voltage reference monitor).	0 (0, 1)

0 : 0.1 V units

1 : 1 V units

■ H5-11: Comm ENTER Command Mode

No. (Hex.)	Name	Description	Default (Range)
H5-11 (043C)	Comm ENTER Command Mode	<input type="checkbox"/> V/f <input type="checkbox"/> OLV/PM <input type="checkbox"/> EZOLV Sets the function to make the Enter command necessary to change parameters through MEMOBUS/Modbus communications.	0 (0, 1)

0 : ENTER Command Required

You must use the Enter command to enable changes to parameters. Make all parameter changes then input the Enter command.

1 : ENTER Command Not Required

It is not necessary to input the Enter command to change parameters.

■ H5-12: Run Command Method Selection

No. (Hex.)	Name	Description	Default (Range)
H5-12 (043D)	Run Command Method Selection	<input type="checkbox"/> V/f <input type="checkbox"/> OLV/PM <input type="checkbox"/> EZOLV Sets the input method for the Run command when b1-02 = 2 [Run Command Selection 1 = Serial Communications].	0 (0, 1)

**0 : FWD/Stop, REV/Stop**

The drive uses bit 0 in command data 0001H of the MEMOBUS register in the motor forward Run command (bit 0 = 1) and the stop command (bit 0 = 0). The drive uses bit 1 in the motor reverse Run command (bit 1 = 1) and the stop command (bit 1 = 0).

**1 : Run/Stop, FWD/REV**

The drive uses bit 0 in command data 0001H of the MEMOBUS register in the motor Run command (bit 0 = 1) and the stop command (bit 0 = 0). The drive uses bit 1 in the direction of motor rotation command (Forward run (bit 1 = 0) or Reverse run (bit 1 = 1)).

**■ H5-14: BACnet Device Obj ID LOW BITS**

No. (Hex.)	Name	Description	Default (Range)
H5-14 (310D)	BACnet Device Obj ID LOW BITS	<input type="checkbox"/> V/f <input type="checkbox"/> OLVP/PM <input type="checkbox"/> EZOLV Sets the lower bits of the BACnet device object ID as a 4-digit hexadecimal number.	0001 (0000 - FFFF)

This parameter and *H5-15 [BACnet Device Obj ID HIGH BITS]* set the Instance Identifier of the BACnet Device Object. The *H5-14* value is the least significant word and the *H5-15* value is the most significant word. Refer to these examples to set *H5-14* and *H5-15* correctly:

- Example 1: Set Device Object Instance Identifier of “1234”  
The number of 1234 (decimal) is equal to 4D2 (hexadecimal). Set *H5-14* = 04D2 and *H5-15* = 0000.
- Example 2: Set Device Object Instance Identifier of “1234567”  
The number of 1234567 (decimal) is equal to 12D687 (hexadecimal). Set *H5-14* = D687 and *H5-15* = 0012.

**■ H5-15: BACnet Device Obj ID HIGH BITS**

No. (Hex.)	Name	Description	Default (Range)
H5-15 (310E)	BACnet Device Obj ID HIGH BITS	<input type="checkbox"/> V/f <input type="checkbox"/> OLVP/PM <input type="checkbox"/> EZOLV Sets the upper bits of the BACnet device object ID as a 4-digit hexadecimal number.	0000 (0000 - 003F)

Parameter *H5-14 [BACnet Device Obj ID LOW BITS]* and this parameter set the Instance Identifier of the BACnet Device Object. The *H5-14* value is the least significant word and the *H5-15* value is the most significant word. Refer to these examples to set *H5-14* and *H5-15* correctly:

- Example 1: Set Device Object Instance Identifier of “1234”  
The number of 1234 (decimal) is equal to 4D2 (hexadecimal). Set *H5-14* = 04D2 and *H5-15* = 0000.
- Example 2: Set Device Object Instance Identifier of “1234567”  
The number of 1234567 (decimal) is equal to 12D687 (hexadecimal). Set *H5-14* = D687 and *H5-15* = 0012.

**■ H5-18: Motor Speed Filter over Comms**

No. (Hex.)	Name	Description	Default (Range)
H5-18 (11A2)	Motor Speed Filter over Comms	<input type="checkbox"/> V/f <input type="checkbox"/> OLVP/PM <input type="checkbox"/> EZOLV Sets the filter time constant used when monitoring motor speed during MEMOBUS/Modbus communications or with a communication option.	0 ms (0 - 100 ms)

Sets the filter time constant when you monitor the output frequency or motor speed during MEMOBUS/Modbus communications or use of the communication option.

These are the MEMOBUS registers:

- 003EH (Output Frequency)
- 003FH (Output Frequency)
- 0044H (*UI-05*: Motor Speed)
- 00ACH (*UI-05*: Motor Speed)
- 00ADH (*UI-05*: Motor Speed)

## ■ H5-20: Communication Parameters Reload

No. (Hex.)	Name	Description	Default (Range)
H5-20 (0B57)	Communication Parameters Reload	<input type="checkbox"/> V/f <input type="checkbox"/> OLV/IPM <input type="checkbox"/> EZOLV Sets the function to immediately enable updated MEMOBUS/Modbus communications parameters.	0 (0, 1)

### 0 : Reload at Next Power Cycle

### 1 : Reload Now

#### Note:

- The setting value automatically returns to  $H5-20 = 0$  after you enable MEMOBUS/Modbus communications parameter changes.
- The setting values of these parameters are enabled:
  - H5-01 [Drive Node Address]
  - H5-02 [Communication Speed Selection]
  - H5-03 [Communication Parity Selection]
  - H5-06 [Drive Transmit Wait Time]

## ■ H5-22: Speed Search from MODBUS

No. (Hex.)	Name	Description	Default (Range)
H5-22 (11CF)	Speed Search from MODBUS	<input type="checkbox"/> V/f <input type="checkbox"/> OLV/IPM <input type="checkbox"/> EZOLV Enables the MEMOBUS/Modbus communication register Speed Search function (bit0 of 15DFH).	0 (0, 1)

### 0 : Disabled

### 1 : Enabled

If you set  $H5-22 = 1$  and  $H1-xx = 62$  [Speed Search from Fref] at the same time, the drive will detect  $oPE03$  [Multi-Function Input Setting Err].

## ■ H5-23: BACnet Max Master

No. (Hex.)	Name	Description	Default (Range)
H5-23 (158D)	BACnet Max Master	<input type="checkbox"/> V/f <input type="checkbox"/> OLV/IPM <input type="checkbox"/> EZOLV Sets the maximum number of master MAC ID to scan to when the drive polls for the next node (Poll for Master).	7F (1 - 7F)

## ■ H5-24: BACnet Max Info Frames

No. (Hex.)	Name	Description	Default (Range)
H5-24 (3DA0)	BACnet Max Info Frames	<input type="checkbox"/> V/f <input type="checkbox"/> OLV/IPM <input type="checkbox"/> EZOLV Sets the maximum number of information frames for BACnet.	3 (1 - 255)

## ■ H5-25: Function 5A Register 1 Selection

No. (Hex.)	Name	Description	Default (Range)
H5-25 (1589) RUN	Function 5A Register 1 Selection	<input type="checkbox"/> V/f <input type="checkbox"/> OLV/IPM <input type="checkbox"/> EZOLV Returns the contents of the specified MEMOBUS/Modbus communications register when responding to the master device.	0044H (U1-05) (0000H - FFFFH)

## ■ H5-26: Function 5A Register 2 Selection

No. (Hex.)	Name	Description	Default (Range)
H5-26 (158A) RUN	Function 5A Register 2 Selection	<input type="checkbox"/> V/f <input type="checkbox"/> OLV/IPM <input type="checkbox"/> EZOLV Returns the contents of the specified MEMOBUS/Modbus communications register when responding to the master device.	0045H (U1-06) (0000H - FFFFH)



### ■ H5-27: Function 5A Register 3 Selection

No. (Hex.)	Name	Description	Default (Range)
H5-27 (158B) RUN	Function 5A Register 3 Selection	<b>V/f</b> <b>OLV/PM</b> <b>EZOLV</b> Returns the contents of the specified MEMOBUS/Modbus communications register when responding to the master device.	0042H (U1-03) (0000H - FFFFH)

### ■ H5-28: Function 5A Register 4 Selection

No. (Hex.)	Name	Description	Default (Range)
H5-28 (158C) RUN	Function 5A Register 4 Selection	<b>V/f</b> <b>OLV/PM</b> <b>EZOLV</b> Returns the contents of the specified MEMOBUS/Modbus communications register when responding to the master device.	0049H (U1-10) (0000H - FFFFH)

### ■ H5-33: Power-up CALL Alarm

No. (Hex.)	Name	Description	Default (Range)
H5-33 (3FB3)	Power-up CALL Alarm	<b>V/f</b> <b>OLV/PM</b> <b>EZOLV</b> Enables and disables <i>CALL [Serial Comm Transmission Error]</i> alarm detection.	1 (0, 1)

**0** : Disabled

**1** : Enabled

### ■ H5-34: Comm Error (CE) Go-To-Frequency

No. (Hex.)	Name	Description	Default (Range)
H5-34 (3FB4) RUN	Comm Error (CE) Go-To-Frequency	<b>V/f</b> <b>OLV/PM</b> <b>EZOLV</b> Sets the speed at which the drive will run when <i>H5-04 = 4 [Communication Error Stop Method = Run at H5-34]</i> and there is a <i>CE</i> .	0.0 Hz (0.0 - 400.0 Hz)

### ■ H5-35: Comm Error (CE) Go-To-Timeout

No. (Hex.)	Name	Description	Default (Range)
H5-35 (3FB5) RUN	Comm Error (CE) Go-To-Timeout	<b>V/f</b> <b>OLV/PM</b> <b>EZOLV</b> When <i>H5-04 = 4 [Communication Error Stop Method = Run at H5-34]</i> and a <i>CE</i> is present, the drive will run at the <i>H5-34 [Comm Error (CE) Go-To-Frequency]</i> speed for this length of time before it triggers a <i>CE</i> fault.	0 s (0 - 6000 s)

**Note:**

Set this parameter to 0 s to disable the time-out.

### ■ H5-36: CE Fault Restart Select

No. (Hex.)	Name	Description	Default (Range)
H5-36 (3FB6)	CE Fault Restart Select	<b>V/f</b> <b>OLV/PM</b> <b>EZOLV</b> Sets the drive to restart ( <i>L5-01 [Number of Auto-Restart Attempts]</i> ) after a <i>CE</i> fault.	0 (0, 1)

**0** : No Retry

**1** : Retry

The drive will restart after the *L5-04 [Interval Method Restart Time]* timer is expired.

## ◆ H7: Virtual Inputs / Outputs

Use the virtual I/O function for these applications:

- Input the result of the output from the MFDO terminal to the MFDI terminal without external wiring.
- Input the result of the output from the MFAO terminal to the MFAI terminal without external wiring.

**WARNING! Sudden Movement Hazard.** Before you do a test run, make sure that the setting values for virtual input and output function parameters are correct. Virtual input and output functions can have different default settings and operation than wired input and output functions. Incorrect function settings can cause serious injury or death.

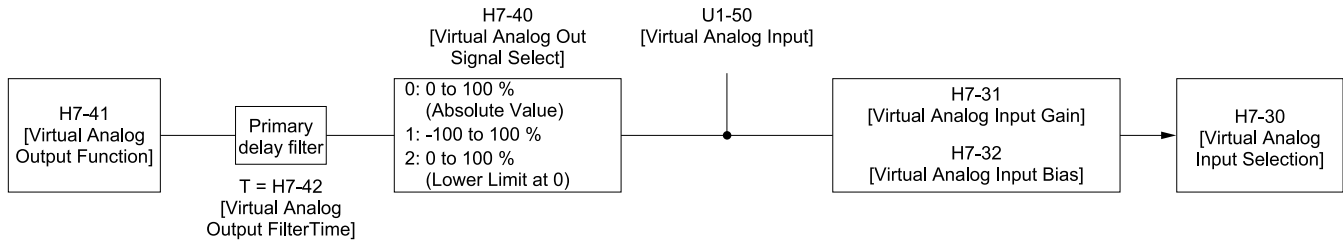

Figure 12.84 Virtual Analog I/O Functional Block Diagram

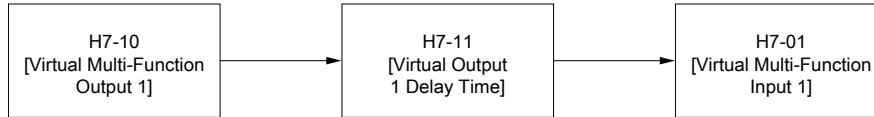

Figure 12.85 Virtual Digital I/O Functional Block Diagram

**Note:**

- Refer to H1-xx “MFDI Setting Values” for more information on the virtual digital input setting values.
- Refer to H2-xx “MFDO Setting Values” for more information on the virtual digital output setting values.
- Refer to H3-xx “MFAI Setting Values” for more information on the virtual analog input setting values.
- Refer to H4-xx “MFAO Setting Values” for more information on the virtual analog output setting values.
- You cannot set 0 [3-Wire Sequence] and 20 or 2F [External Fault] to H7-01 to H7-04 [Virtual Multi-Function Input 1 to 4].
- If you will not use the terminal, set H7-01 to H7-04 = F. This function does not support the through mode function.

■ **H7-00: Virtual MFIO selection**

No. (Hex.)	Name	Description	Default (Range)
H7-00 (116F) Expert	Virtual MFIO selection	<b>V/f</b> <b>OLV/PM</b> <b>EZOLV</b> Sets the function to enable and disable the virtual I/O function. Set this parameter to 1 to operate the virtual I/O function.	0 (0, 1)

**0 : Disabled**

**1 : Enabled**

■ **H7-01: Virtual Multi-Function Input 1**

No. (Hex.)	Name	Description	Default (Range)
H7-01 (1185) Expert	Virtual Multi-Function Input 1	<b>V/f</b> <b>OLV/PM</b> <b>EZOLV</b> Sets the function that enters the virtual input set in H7-10 [Virtual Multi-Function Output 1].	F (1 - 1FF)

**Note:**

Settings 1B [Programming Lockout] and 11B [!Programming Lockout] are not available.

■ **H7-02: Virtual Multi-Function Input 2**

No. (Hex.)	Name	Description	Default (Range)
H7-02 (1186) Expert	Virtual Multi-Function Input 2	<b>V/f</b> <b>OLV/PM</b> <b>EZOLV</b> Sets the function that enters the virtual input set in H7-12 [Virtual Multi-Function Output 2].	F (1 - 1FF)

**Note:**

Settings 1B [Programming Lockout] and 11B [!Programming Lockout] are not available.

### ■ H7-03: Virtual Multi-Function Input 3

No. (Hex.)	Name	Description	Default (Range)
H7-03 (1187) Expert	Virtual Multi-Function Input 3	<b>V/f</b> <b>OLV/PM</b> <b>EZOLV</b> Sets the function that enters the virtual input set in H7-14 [Virtual Multi-Function Output 3].	F (1 - 1FF)

**Note:**

Settings 1B [Programming Lockout] and 11B [!Programming Lockout] are not available.

### ■ H7-04: Virtual Multi-Function Input 4

No. (Hex.)	Name	Description	Default (Range)
H7-04 (1188) Expert	Virtual Multi-Function Input 4	<b>V/f</b> <b>OLV/PM</b> <b>EZOLV</b> Sets the function that enters the virtual input set in H7-16 [Virtual Multi-Function Output 4].	F (1 - 1FF)

**Note:**

Settings 1B [Programming Lockout] and 11B [!Programming Lockout] are not available.

### ■ H7-10: Virtual Multi-Function Output 1

No. (Hex.)	Name	Description	Default (Range)
H7-10 (11A4) Expert	Virtual Multi-Function Output 1	<b>V/f</b> <b>OLV/PM</b> <b>EZOLV</b> Sets the function for virtual digital output 1.	F (0 - 1FF)

### ■ H7-11: Virtual Output 1 Delay Time

No. (Hex.)	Name	Description	Default (Range)
H7-11 (11A5) Expert	Virtual Output 1 Delay Time	<b>V/f</b> <b>OLV/PM</b> <b>EZOLV</b> Sets the minimum ON time for virtual digital output 1.	0.1 s (0.0 - 25.0 s)

### ■ H7-12: Virtual Multi-Function Output 2

No. (Hex.)	Name	Description	Default (Range)
H7-12 (11A6) Expert	Virtual Multi-Function Output 2	<b>V/f</b> <b>OLV/PM</b> <b>EZOLV</b> Sets the function for virtual digital output 2.	F (0 - 1FF)

### ■ H7-13: Virtual Output 2 Delay Time

No. (Hex.)	Name	Description	Default (Range)
H7-13 (11A7) Expert	Virtual Output 2 Delay Time	<b>V/f</b> <b>OLV/PM</b> <b>EZOLV</b> Sets the minimum ON time for virtual digital output 2.	0.1 s (0.0 - 25.0 s)

### ■ H7-14: Virtual Multi-Function Output 3

No. (Hex.)	Name	Description	Default (Range)
H7-14 (11A8) Expert	Virtual Multi-Function Output 3	<b>V/f</b> <b>OLV/PM</b> <b>EZOLV</b> Sets the function for virtual digital output 3.	F (0 - 1FF)

### ■ H7-15: Virtual Output 3 Delay Time

No. (Hex.)	Name	Description	Default (Range)
H7-15 (11A9) Expert	Virtual Output 3 Delay Time	<b>V/f</b> <b>OLV/PM</b> <b>EZOLV</b> Sets the minimum ON time for virtual digital output 3.	0.1 s (0.0 - 25.0 s)

### ■ H7-16: Virtual Multi-Function Output 4

No. (Hex.)	Name	Description	Default (Range)
H7-16 (11AA) Expert	Virtual Multi-Function Output 4	<b>V/f</b> <b>OLV/PM</b> <b>EZOLV</b> Sets the function for virtual digital output 4.	F (0 - 1FF)

### ■ H7-17: Virtual Output 4 Delay Time

No. (Hex.)	Name	Description	Default (Range)
H7-17 (11AB) Expert	Virtual Output 4 Delay Time	<b>V/f</b> <b>OLV/PM</b> <b>EZOLV</b> Sets the minimum ON time for virtual digital output 4.	0.1 s (0.0 - 25.0 s)

### ■ H7-30: Virtual Analog Input Selection

No. (Hex.)	Name	Description	Default (Range)
H7-30 (1177) Expert	Virtual Analog Input Selection	<b>V/f</b> <b>OLV/PM</b> <b>EZOLV</b> Sets the virtual analog input function.	F (0 - 31)

### ■ H7-31: Virtual Analog Input Gain

No. (Hex.)	Name	Description	Default (Range)
H7-31 (1178) RUN Expert	Virtual Analog Input Gain	<b>V/f</b> <b>OLV/PM</b> <b>EZOLV</b> Sets the virtual analog input gain.	100.0% (-999.9 - 999.9%)

### ■ H7-32: Virtual Analog Input Bias

No. (Hex.)	Name	Description	Default (Range)
H7-32 (1179) RUN Expert	Virtual Analog Input Bias	<b>V/f</b> <b>OLV/PM</b> <b>EZOLV</b> Sets the virtual analog input bias.	0.0% (-999.9 - 999.9%)

### ■ H7-40: Virtual Analog Out Signal Select

No. (Hex.)	Name	Description	Default (Range)
H7-40 (1163)	Virtual Analog Out Signal Select	<b>V/f</b> <b>OLV/PM</b> <b>EZOLV</b> Sets the signal level of the virtual analog output.	0 (0 - 2)

0 : 0 to 100% (Absolute Value)

1 : -100 to 100%

2 : 0 to 100% (Lower Limit at 0)

### ■ H7-41: Virtual Analog Output Function

No. (Hex.)	Name	Description	Default (Range)
H7-41 (1164)	Virtual Analog Output Function	<b>V/f</b> <b>OLV/PM</b> <b>EZOLV</b> Sets the monitor to be output from the virtual analog output.	102 (0 - 999)

Set the  $x-xx$  part of the  $Ux-xx$  [Monitor]. For example, set  $H7-41 = 102$  to monitor  $U1-02$  [Output Frequency].

### ■ H7-42: Virtual Analog Output FilterTime

No. (Hex.)	Name	Description	Default (Range)
H7-42 (1165)	Virtual Analog Output FilterTime	<b>V/f</b> <b>OLV/PM</b> <b>EZOLV</b> Sets the time constant for a primary filter of the virtual analog output.	0.00 s (0.00 - 2.00 s)

## 12.9 L: Protection Functions

*L* parameters set the following functions.

- Motor Overload Protection
- Operation During Momentary Power Loss
- Stall Prevention
- Speed Detection
- Auto Restart
- Detection of Overtorque/Undertorque
- Torque Limit
- Hardware Protection

### ◆ L1: Motor Protection

*L1* parameters set the motor overload protection function.

#### ■ L1-01: Motor Overload (oL1) Protection

No. (Hex.)	Name	Description	Default (Range)
L1-01 (0480)	Motor Overload (oL1) Protection	<div style="display: flex; gap: 5px;"> <span style="background-color: black; color: white; padding: 2px;">V/f</span> <span style="background-color: black; color: white; padding: 2px;">OLV/PM</span> <span style="background-color: black; color: white; padding: 2px;">EZOLV</span> </div> Sets the motor overload protection with electronic thermal protectors.	Determined by A1-02 (0 - 4)

This parameter enables and disables the motor overload protection with electronic thermal protectors.

The cooling capability of the motor changes when the speed control range of the motor changes. Use an electronic thermal protector that aligns with the permitted load characteristics of the motor to select motor protection.

The electronic thermal protector of the drive uses these items to calculate motor overload tolerance and supply overload protection for the motor:

- Output Current
- Output Frequency
- Motor thermal characteristics
- Time characteristics

If the drive detects motor overload, the drive will trigger an *oL1* [*Motor Overload*] and stop the drive output.

Set *H2-01 = 1F* [*Term M1-M2 Function Selection = Motor Overload Alarm (oL1)*] to set a motor overload alarm. If the motor overload level is more than 90% of the *oL1* detection level, the output terminal turns ON and triggers an overload alarm.

#### 0 : Disabled

Disable motor protection when motor overload protection is not necessary or when the drive is operating more than one motor.

Refer to [Figure 12.86](#) for an example of the circuit configuration to connect more than one motor to one drive.

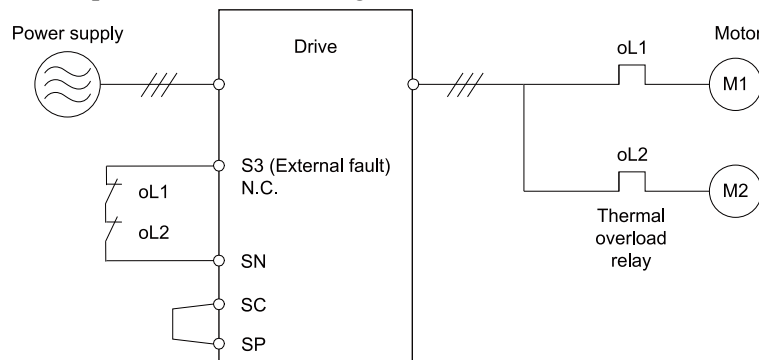

Figure 12.86 Protection Circuit Configuration to Connect More than One Motor to One Drive

**NOTICE:** When you connect more than one motor to one drive or when the motor amp rating is higher than the drive amp rating, set L1-01 = 0 [Motor Overload (oL1) Protection = Disabled] and install thermal overload relays for each motor. The electronic thermal protection of the drive will not function and it can cause damage to the motor.

### 1 : Variable Torque

Use this setting for general-purpose motors with a 60 Hz base frequency.

The overload tolerance decreases as motor speed decreases because the cooling fan speed decreases and the ability of the motor to cool decreases in the low speed range.

The overload tolerance characteristics of the motor change the trigger point for the electronic thermal protector. This provides motor overheat protection from low speed to high speed across the full speed range.

Load Tolerance	Cooling Capability	Overload Characteristics (at 100% motor load)
	<p>This motor is designed to operate with commercial line power. Operate at a 60 Hz base frequency to maximize the motor cooling ability.</p>	<p>If the motor operates at frequencies less than 60 Hz, the drive will detect oL1. The drive triggers a fault relay output and the motor coasts to stop.</p>

### 4 : PM Variable Torque

Use this setting for PM motors with derated torque characteristics.

The overload tolerance decreases as motor speed decreases because the cooling fan speed decreases and the ability of the motor to cool decreases in the low speed range.

The overload tolerance characteristics of the motor change the trigger point for the electronic thermal protector. This provides motor overheat protection from low speed to high speed across the full speed range.

Load Tolerance	Cooling Capability	Overload Characteristics (at 100% motor load)
	<p>This motor is designed to withstand increased temperatures during continuous operation at rated speed and rated torque.</p>	<p>If the motor operates continuously at lower speed than rated rotation speed at more than 100% torque, the drive will detect oL1. The drive triggers a fault relay output and the motor coasts to stop.</p>

### ■ L1-02: Motor Overload Protection Time

No. (Hex.)	Name	Description	Default (Range)
L1-02 (0481)	Motor Overload Protection Time	<p><input type="checkbox"/> V/f <input checked="" type="checkbox"/> OL/PM <input type="checkbox"/> EZOLV</p> <p>Sets the operation time for the electronic thermal protector of the drive to prevent damage to the motor. Usually it is not necessary to change this setting.</p>	1.0 min (0.1 - 5.0 min)

Set the overload tolerance time to the length of time that the motor can operate at 150% load from continuous operation at 100% load.

When the motor operates at 150% load continuously for 1 minute after continuous operation at 100% load (hot start), the default setting triggers the electronic thermal protector.

Figure 12.87 shows an example of the electronic thermal protector operation time. Motor overload protection operates in the range between a cold start and a hot start.

This example shows a general-purpose motor operating at the base frequency with *L1-02* set to 1.0 min.

- Cold start  
Shows the motor protection operation time characteristics when the overload occurs immediately after starting operation from a complete stop.
- Hot start  
Shows the motor protection operation time characteristics when overload occurs from continuous operation below the motor rated current.

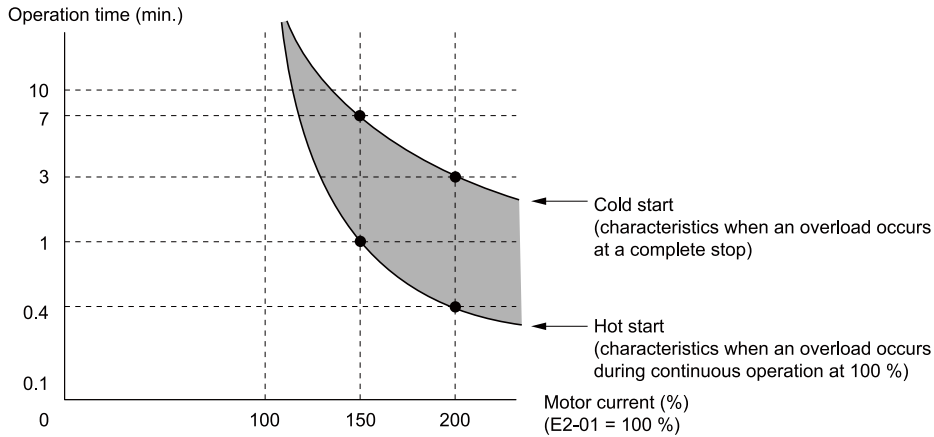

Figure 12.87 Protection Operation Time for a General-purpose Motor at Rated Output Frequency

### ■ Use a Positive Temperature Coefficient (PTC) Thermistor for Motor Protection

Connect a motor PTC can to an analog input of the drive for motor overheating protection.

The motor overheating alarm level triggers an *oH3 [Motor Overheat (PTC Input)]* alarm and the drive continues the operation selected in *L1-03 [Motor Thermistor oH Alarm Select]*. The overheating fault level triggers an *oH4 [Motor Overheat Fault (PTC Input)]* fault, outputs a fault signal, and the drive uses the stopping method *L1-04 [Motor Thermistor oH Fault Select]* to stop the motor. Connect the PTC between terminals AC and A2 and install a 12 kΩ resistor between terminals +V and A2 as shown in Figure 12.88. Set *H3-09 = 0 [Terminal A2 Signal Level Select = 0-10V (Lower Limit at 0)]* and *H3-10 = E [Terminal A2 Function Selection = Motor Temperature (PTC Input)]*. When you use terminal A2, make sure that you set Jumper Switch S1 on the control board to “V”.

**Note:**

To use PTC, it is necessary to connect a 12 kΩ resistor between +V and one of the terminals A1 or A2.

**NOTICE: Damage to Equipment.** Connect the 12 kΩ resistor to the same terminal as the PTC input. If you connect terminal +V to AC, it can cause damage to the drive.

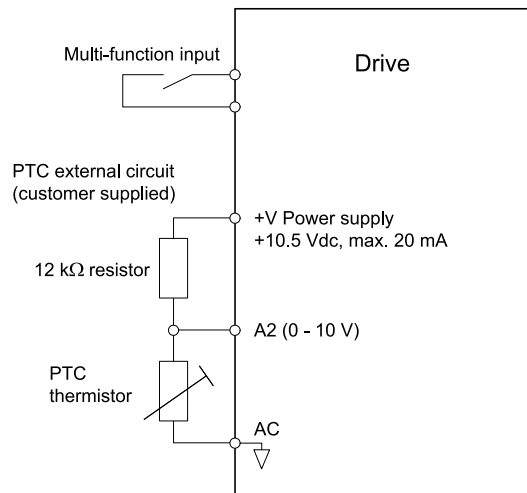

Figure 12.88 Connection of a Motor PTC



The PTC must have the characteristics shown in Figure 12.89 in one motor phase. The motor overload protection of the drive expects 3 of these PTCs connected in a series.

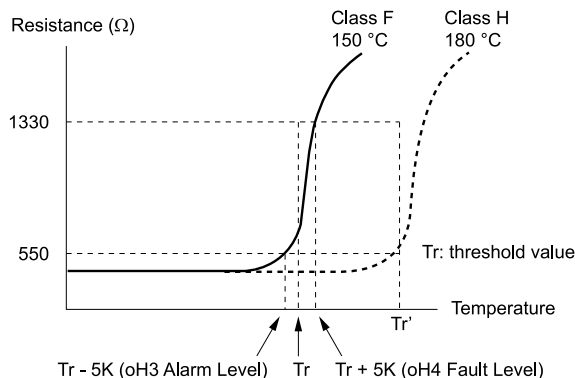

Figure 12.89 Motor PTC Characteristics

Use parameters *L1-03*, *L1-04*, and *L1-05* [*Motor Thermistor Filter Time*] to set up a PTC to detect overheat.

### ■ L1-03: Motor Thermistor oH Alarm Select

No. (Hex.)	Name	Description	Default (Range)
L1-03 (0482)	Motor Thermistor oH Alarm Select	<input type="checkbox"/> V/f <input checked="" type="checkbox"/> OLVP/M <input checked="" type="checkbox"/> EZOLV Sets drive operation when the PTC input signal entered into the drive is at the oH3 [ <i>Motor Overheat (PTC Input)</i> ] detection level.	3 (0 - 3)

#### 0 : Ramp to Stop

The drive ramps the motor to stop in the deceleration time. Fault relay output terminal MA-MC turns ON and MB-MC turns OFF.

#### 1 : Coast to Stop

The output turns OFF and the motor coasts to stop. Fault relay output terminal MA-MC turns ON, and MB-MC turns OFF.

#### 2 : Fast Stop (Use C1-09)

The drive stops the motor in the deceleration time set in *C1-09* [*Fast Stop Time*]. Fault relay output terminal MA-MC turns ON, and MB-MC turns OFF.

#### 3 : Alarm Only

The keypad shows *oH3*, and operation continues. The output terminal set for *Alarm* [*H2-01 to H2-03 = 10*] turns ON.

### ■ L1-04: Motor Thermistor oH Fault Select

No. (Hex.)	Name	Description	Default (Range)
L1-04 (0483)	Motor Thermistor oH Fault Select	<input type="checkbox"/> V/f <input checked="" type="checkbox"/> OLVP/M <input checked="" type="checkbox"/> EZOLV Sets the drive operation when the PTC input signal to the drive is at the oH4 [ <i>Motor Overheat Fault (PTC Input)</i> ] detection level.	1 (0 - 2)

#### 0 : Ramp to Stop

The drive ramps the motor to stop in the deceleration time. Fault relay output terminal MA-MC turns ON, and MB-MC turns OFF.

#### 1 : Coast to Stop

The output turns OFF and the motor coasts to stop. Fault relay output terminal MA-MC turns ON, and MB-MC turns OFF.

#### 2 : Fast Stop (Use C1-09)

The drive stops the motor in the deceleration time set in *C1-09* [*Fast Stop Time*]. Fault relay output terminal MA-MC turns ON, and MB-MC turns OFF.

### ■ L1-05: Motor Thermistor Filter Time

No. (Hex.)	Name	Description	Default (Range)
L1-05 (0484)	Motor Thermistor Filter Time	<div style="display: flex; gap: 5px;"> <span style="border: 1px solid black; padding: 2px;">V/f</span> <span style="border: 1px solid black; padding: 2px;">OLV/PM</span> <span style="border: 1px solid black; padding: 2px;">EZOLV</span> </div> Sets the primary delay time constant for the PTC input signal entered to the drive. This parameter prevents accidental motor overheating faults.	0.20 s (0.00 - 10.00 s)

### ■ L1-08: oL1 Current Level

No. (Hex.)	Name	Description	Default (Range)
L1-08 (1103)	oL1 Current Level	<div style="display: flex; gap: 5px;"> <span style="border: 1px solid black; padding: 2px;">V/f</span> <span style="border: 1px solid black; padding: 2px;">OLV/PM</span> <span style="border: 1px solid black; padding: 2px;">EZOLV</span> </div> Sets the reference current for the motor 1 thermal overload detection. When the current level > 0.0 A, you cannot set this value < 10% of drive rated current.	0.0 A (0.0 A or 10% to 150% of the drive rated current)

When  $L1-08 = 0.0 A$ , the drive uses  $E2-01$  [Motor Rated Current (FLA)] to detect the motor overload protection. In PM control methods, the drive uses  $E5-03$  [PM Motor Rated Current (FLA)] to detect the motor overload protection. When  $L1-08 \neq 0.0 A$ , the set value is the reference for motor overload protection.

**Note:**

- Display is in these units:  
 -0.01 A: 2011 to 2046, 4005 to 4014  
 -0.1 A: 2059 to 2273, 4021 to 4302
- When the current level > 0.0 A, you cannot set this value < 10% of drive rated current.

### ■ L1-09: oL1 Current Level for Motor 2

No. (Hex.)	Name	Description	Default (Range)
L1-09 (1104)	oL1 Current Level for Motor 2	<div style="display: flex; gap: 5px;"> <span style="border: 1px solid black; padding: 2px;">V/f</span> <span style="border: 1px solid black; padding: 2px;">OLV/PM</span> <span style="border: 1px solid black; padding: 2px;">EZOLV</span> </div> Sets the reference current for the motor 2 thermal overload detection. When the current level > 0.0 A, you cannot set this value < 10% of drive rated current.	0.0 A (0.0 A or 10 to 150% of the drive rated current)

When  $L1-09 = 0.0 A$ , the drive uses  $E4-01$  [Motor 2 Rated Current] to detect the motor overload protection. When  $L1-09 \neq 0.0 A$ , the set value is the reference for motor overload protection.

**Note:**

- Display is in these units:  
 -0.01 A: 2011 to 2046, 4005 to 4014  
 -0.1 A: 2059 to 2273, 4021 to 4302
- When the current level > 0.0 A, you cannot set this value < 10% of drive rated current.

### ■ L1-13: Motor Overload Memory Selection

No. (Hex.)	Name	Description	Default (Range)
L1-13 (046D)	Motor Overload Memory Selection	<div style="display: flex; gap: 5px;"> <span style="border: 1px solid black; padding: 2px;">V/f</span> <span style="border: 1px solid black; padding: 2px;">OLV/PM</span> <span style="border: 1px solid black; padding: 2px;">EZOLV</span> </div> Sets the function that keeps the current electronic thermal protector value after power loss.	2 (0 - 2)

**0 : Disabled**

**1 : Enabled**

**2 : Enabled, using RTC**

- The drive keeps the value of electronic thermal protector and integrates (resets) down the overload value based on real time.
- The drive saves the date and time on the EEPROM at power loss. When you set  $L1-13 = 2$  and re-apply the power, the drive will calculate the length of time that it did not have power, read the value of the  $oL1$  [Motor Overload] counter it saved before the power loss, and re-calculate the current  $oL1$  counter value.

**Note:**

The drive saves  $oL$  status, time and date when there is a power loss. The drive uses this information and time of power up to calculate  $oL$ .

## ■ L1-22: Leakage Current Filter Time1

No. (Hex.)	Name	Description	Default (Range)
L1-22 (0768) RUN	Leakage Current Filter Time1	<b>V/f</b> <b>OLV/PM</b> <b>EZOLV</b> Sets the leakage current detection reduction filter time constant during constant speed run.	Determined by C6-02 (0.0 - 60.0 s)

### Note:

You can set this parameter when  $C6-02 = B$  [Carrier Frequency Selection = Leakage Current Detection Reduction Rate PWM].

If incorrect detection of alarms, for example *oL1* [Motor Overload], occur or errors occur in the values on the current monitor because of a leakage current, increase the setting value.

## ■ L1-23: Leakage Current Filter Time2

No. (Hex.)	Name	Description	Default (Range)
L1-23 (0769) RUN	Leakage Current Filter Time2	<b>V/f</b> <b>OLV/PM</b> <b>EZOLV</b> Sets the leakage current detection reduction filter time constant during acceleration/deceleration.	Determined by C6-02 (0.0 - 60.0 s)

### Note:

• You can set this parameter when  $C6-02 = B$  [Carrier Frequency Selection = Leakage Current Detection Reduction Rate PWM].

• When the setting value increases, the current monitor will start up slowly. Examine the relevant sequence for problems.

If errors occur in the values on the current monitor during acceleration/deceleration, increase the setting value.

## ◆ L2: Power Loss Ride Through

*L2 parameters* set the drive operation during momentary power loss and the KEB Ride-Through function method of operation.

### ■ KEB Ride-Through Function

KEB is an acronym for Kinetic Energy Backup. If the drive detects a power loss or momentary power loss, it will quickly decelerate the motor. The drive uses regenerative energy from the motor to keep the main circuit operating. When you return power during motor deceleration, the drive returns operation to the status before the power loss. The KEB Ride-Through function is different than other functions for continuous operation. If the drive detects momentary power loss, the motor will ramp to stop. It will not coast to stop. This function is applicable for applications in which it is necessary to prevent materials from running out, for example control for film and fiber lines.

The KEB Ride-Through function has 2 methods of operation. Parameter *L2-29* [Kinetic Energy Backup Method] sets the method.

When you use the KEB Ride-Through function with one drive, set  $L2-29 = 0, 1$  [Single Drive KEB Ride-Through 1, Single Drive KEB Ride-Through 2].

Table 12.57 KEB Ride-Through Function Operation Method

L2-29	Kinetic Energy Backup Method	Operation	Configuration Precautions
0	Single Drive KEB Ride-Through 1	The drive uses regenerative energy from the motor to keep the DC bus voltage at the level set in <i>L2-11</i> [KEB DC Bus Voltage Setpoint] while it adjusts the rate of deceleration. The KEB operation continues while the drive adjusts the deceleration rate with the setting of <i>C1-09</i> [Fast Stop Time].	<ul style="list-style-type: none"> <li>Set <i>C1-09</i> correctly to prevent <i>Uv1</i> [DC Bus Undervoltage] and <i>ov</i> [Overvoltage].</li> <li>If the drive detects <i>Uv1</i> during the KEB operation, decrease the value set in <i>C1-09</i>.</li> <li>If the drive detects <i>ov</i> during the KEB operation, increase the value set in <i>C1-09</i>.</li> </ul>
1	Single Drive KEB Ride-Through 2	The drive uses information about the inertia of the connected machinery to find the deceleration rate necessary to keep the DC bus voltage at the level set in parameter <i>L2-11</i> . The drive uses system inertia to calculate the deceleration time. You cannot adjust this value.	<ul style="list-style-type: none"> <li>If the drive detects <i>Uv1</i> during the KEB operation, increase the setting value of <i>L3-20</i> [DC Bus Voltage Adjustment Gain] and <i>L3-21</i> [OVSuppression Accel/Decel P Gain].</li> <li>If the drive detects <i>ov</i> during the KEB operation, decrease the setting values of <i>L3-20</i> and <i>L3-21</i>.</li> </ul>

### ■ KEB Operation Wiring Example

Figure 12.90 shows an example that uses an undervoltage relay to trigger the KEB Ride-Thru at power loss. When a power loss occurs, the undervoltage relay triggers *KEB Ride-Thru* [ $H1-06 = 65, 66, 7A, 7B$ ] at terminal S6.

**Note:**

Configure the drive to turn ON the Run command while the KEB function is operating. If you turn off the Run command, the drive will not accelerate back to speed when you return power.

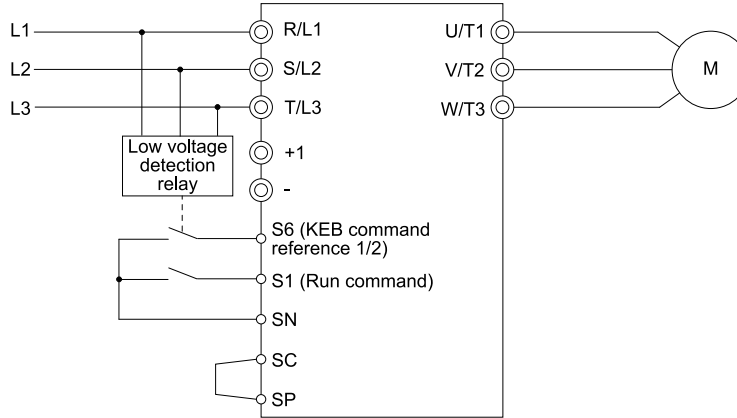

Figure 12.90 KEB Function Wiring Example

### ■ Parameters for KEB Ride-Thru

Table 12.58 shows the parameters that adjust the KEB Ride-Thru function. Parameter settings are different for the different KEB methods set in L2-29 [*Kinetic Energy Backup Method*].

Table 12.58 Parameters for KEB Ride-Thru

No.	Name	Settings	L2-29 [Kinetic Energy Backup Method]	
			0	1
C1-09	Fast Stop Time	<ul style="list-style-type: none"> <li>If <i>ov</i> [Overvoltage] occurs during KEB deceleration, increase the setting value.</li> <li>If <i>Uv1</i> [DC Bus Undervoltage] occurs during KEB deceleration, decrease the setting value.</li> </ul>	x	-
C2-03	S-Curve Time @ Start of Decel	<ul style="list-style-type: none"> <li>If <i>ov</i> occurs immediately after you start KEB deceleration, increase the setting value.</li> <li>If <i>Uv1</i> occurs immediately after you start KEB deceleration, decrease the setting value.</li> </ul>	x	-
L2-05	Undervoltage Detection Lvl (Uv1)	If <i>Uv1</i> occurs immediately after you start KEB deceleration, increase the setting value to detect power loss more quickly.	x	x
L2-06	Kinetic Energy Backup Decel Time	<ul style="list-style-type: none"> <li>If <i>ov</i> occurs during KEB deceleration, increase the setting value</li> <li>If <i>Uv1</i> occurs during KEB deceleration, decrease the setting value.</li> </ul>	-	-
L2-07	Kinetic Energy Backup Accel Time	Sets the acceleration time to return to the frequency reference value before a power loss, after you cancel the KEB operation. When $L2-07 = 0$ , the drive uses the standard acceleration times set in C1-01 and C1-03.	x	x
L2-08	Frequency Gain at KEB Start	<ul style="list-style-type: none"> <li>If <i>ov</i> occurs immediately after you start operation, decrease the setting value.</li> <li>If <i>Uv1</i> occurs immediately after you start operation, increase the setting value.</li> </ul>	x	-
L2-10	Minimum KEB Time	<ul style="list-style-type: none"> <li>With KEB Ride-Thru There is <i>Uv1</i> because you set a digital input for KEB Ride-Thru and the device that controls the input operated too slowly after power loss.</li> <li>Without KEB Ride-Thru If the DC bus voltage overshoots immediately after KEB Ride-Thru starts, increase L2-10 to longer than the overshoot.</li> </ul>	x	x
L2-11	KEB DC Bus Voltage Setpoint	<ul style="list-style-type: none"> <li>Single Drive KEB Ride-Thru 2 Set to approximately <math>1.22 \times</math> input voltage.</li> <li>Single Drive KEB Ride-Thru 1 Set to approximately <math>1.4 \times</math> input voltage.</li> </ul>	x	x
L3-20	DC Bus Voltage Adjustment Gain	<ul style="list-style-type: none"> <li>If <i>ov</i> or <i>Uv1</i> occurs at the start of deceleration when you use KEB operation, increase this value in 0.1-unit increments.</li> <li>If there is torque ripple during deceleration when you use KEB Ride-Thru, decrease the value.</li> </ul>	-	x
L3-21	OVSUPPRESSION ACCEL/DECCEL P GAIN	If there is large speed or current ripple, decrease the value in 0.05 unit increments.  <b>Note:</b> If the setting value is too low, then the drive will have unsatisfactory DC bus voltage control response. The drive can detect <i>ov</i> or <i>Uv1</i> .	-	x

No.	Name	Settings	L2-29 [Kinetic Energy Backup Method]	
			0	1
L3-24	Motor Accel Time @ Rated Torque	Set the motor acceleration time to the maximum frequency at the motor rated torque.	-	x
L3-25	Load Inertia Ratio	Sets the ratio between motor inertia and machine inertia.	-	x

## ■ L2-01: Power Loss Ride Through Select

No. (Hex.)	Name	Description	Default (Range)
L2-01 (0485)	Power Loss Ride Through Select	<input type="checkbox"/> V/f <input type="checkbox"/> OL/PM <input type="checkbox"/> EZOLV Sets the drive operation after a momentary power loss.	2 (0 - 2)

The drive detects momentary power loss when the drive DC bus voltage is less than the value set in *L2-05* [*Undervoltage Detection Lvl (Uv1)*].

### 0 : Disabled

The drive detects *Uv1* [*DC Bus Undervoltage*] when there is a momentary power loss.

If you do not return power in 15 ms, it triggers *Uv1* and the drive shuts off the output. The motor coasts to stop.

### 1 : Enabled for L2-02 Time

When power returns in the time set in *L2-02* [*Power Loss Ride Through Time*], the drive will restart. If power does not return in the time set in *L2-02*, the drive will detect *Uv1*.

The drive momentarily turns OFF its output after a power loss. If the power returns in the time set to *L2-02*, the drive will do Speed Search and try to continue operation.

If the DC bus voltage is less than or equal to the *Uv1* detection level for the time set in *L2-02*, the drive will detect *Uv1* and output a fault signal.

#### Note:

- The necessary time for the drive to restart after power returns is different for different drive capacities.
- The upper limit of the possible momentary power loss Ride-Thru time is different for different drive models.

### 2 : Enabled while CPU Power Active

When power returns and the drive control circuit has power, the drive will restart. This will not trigger *Uv1*.

When there is a momentary power loss, the drive output will turn OFF. If the power returns and the drive control circuit has power, the drive will do Speed Search and try to continue operation. This will not trigger a *Uv1*. This function enables longer support for power loss than when *L2-01 = 1*.

#### Note:

When you set *L2-01*, make sure that you know these items:

- You can use a Momentary Power Loss Unit on models 2011 to 2059 and 4005 to 4021 for a longer momentary power loss ride through time. A Momentary Power Loss Unit makes it possible to continue operation of the drive after a maximum of 2 seconds of power loss.
- When you set *L2-01 = 1* or *2*, keep the magnetic contactor on the drive input side closed and keep the control signal while the drive does KEB operation.
- When *L2-01 = 1* or *2*, *Uv* [*Undervoltage*] will flash on the keypad while the drive is attempting to recover from a momentary power loss. The drive will not output a fault signal at this time.
- When you use a magnetic contactor between the motor and the drive, keep the magnetic contactor closed while the drive does KEB operation or tries to restart with Speed Search.
- Keep the Run command active during KEB operation. The drive cannot accelerate back to the frequency reference when the power returns.
- When the CPU is inactive, *b1-17* [*Run Command at Power Up*] sets operation at power up.

## ■ L2-02: Power Loss Ride Through Time

No. (Hex.)	Name	Description	Default (Range)
L2-02 (0486)	Power Loss Ride Through Time	<input type="checkbox"/> V/f <input type="checkbox"/> OL/PM <input type="checkbox"/> EZOLV Sets the maximum time that the drive will wait until it tries to restart after power loss.	Determined by o2-04 (0.0 - 25.5 s)

This function is applicable when *L2-01 = 1* [*Power Loss Ride Through Select = Enabled for L2-02 Time*]. If power loss operation is longer than the time set in this parameter, the drive will detect *Uv1* [*DC Bus Undervoltage*], turn OFF output, and the motor will coast to stop.

**Note:**

- The length of time that the drive can recover after a power loss changes when drive capacity changes.
- The upper limit of the possible momentary power loss Ride-Through time changes when drive capacity changes.

■ **L2-03: Minimum Baseblock Time**

No. (Hex.)	Name	Description	Default (Range)
L2-03 (0487)	Minimum Baseblock Time	<input type="checkbox"/> V/f <input type="checkbox"/> OL/PM <input type="checkbox"/> EZOLV Sets the minimum time to continue the drive output block (baseblock) after a baseblock.	Determined by o2-04 (0.1 - 5.0 s)

Sets the length of time that the drive will wait for the residual voltage in the motor to dissipate in estimation to the secondary circuit time constant of the motor. If *oC* [Overcurrent] or *ov* [DC Bus Overvoltage] occur at the start of Speed Search, after power returns, or during DC Injection Braking, increase this setting.

■ **L2-04: Powerloss V/f Recovery Ramp Time**

No. (Hex.)	Name	Description	Default (Range)
L2-04 (0488)	Powerloss V/f Recovery Ramp Time	<input type="checkbox"/> V/f <input type="checkbox"/> OL/PM <input type="checkbox"/> EZOLV Sets the time for the drive output voltage to go back to the correct voltage after it completes speed searches.	Determined by o2-04 (0.0 - 5.0 s)

Sets the time for voltage to recover from 0 V to the value set in *E1-05* [Maximum Output Voltage].

■ **L2-05: Undervoltage Detection Lvl (Uv1)**

No. (Hex.)	Name	Description	Default (Range)
L2-05 (0489)	Undervoltage Detection Lvl (Uv1)	<input type="checkbox"/> V/f <input type="checkbox"/> OL/PM <input type="checkbox"/> EZOLV Sets the voltage at which the drive triggers a <i>Uv1</i> [DC Bus Undervoltage] fault or at which it activates the KEB function. Usually it is not necessary to change this setting.	Determined by o2-04 and E1-01 (208 V Class: 150 - 220 V, 480 V Class: 300 - 440 V)

**NOTICE: Damage to Equipment.** When you set this parameter to a value lower than the default, you must install an AC reactor on the input side of the power supply. If you do not install an AC reactor, it will cause damage to the drive circuitry.

**Note:**

If the low voltage detection level is near the lower limit value of *L2-05*, the drive will detect *Uv1* during KEB Ride-Through operation. Do not set the value too low when you use the KEB Ride-Through function.

■ **L2-06: Kinetic Energy Backup Decel Time**

No. (Hex.)	Name	Description	Default (Range)
L2-06 (048A) Expert	Kinetic Energy Backup Decel Time	<input type="checkbox"/> V/f <input type="checkbox"/> OL/PM <input type="checkbox"/> EZOLV Sets the deceleration time during KEB operation to decrease the maximum output frequency to 0.	0.0 s (0.0 - 6000.0 s)

This parameter sets the deceleration time necessary to decelerate from the frequency reference to 0 Hz when the drive detects a momentary power loss. If a *Uv1* [DC Bus Undervoltage] fault occurs during KEB operation, decrease the deceleration time. If an *ov* [Overvoltage] fault occurs, increase the deceleration time.

- $L2-06 = 0$

The drive automatically decreases *C1-09* [Fast Stop Time] to the base value to keep the DC bus voltage above the low voltage detection level. The drive ignores *L2-02* [Power Loss Ride Through Time] in this condition.

- $L2-06 \neq 0$

As shown in [Figure 12.91](#), the frequency reference decelerates to the KEB frequency level as specified by the deceleration rate set in *L2-06* and then returns to the initial frequency reference as specified by *C1-01* [Acceleration Time 1]. The drive uses the setting value of the KEB frequency rate as shown in this formula to set the KEB frequency level:

$$\text{KEB frequency level} = \text{Output frequency before power loss} \times (1 - (L2-02) / (L2-06))$$

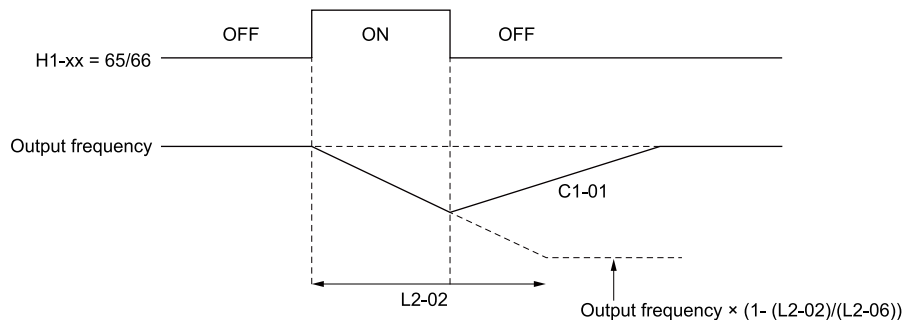

**C1-01: Acceleration Time 1**  
**H1-xx = 65: KEB Ride-Thru 1 Activate (N.C.)**  
**H1-xx = 66: KEB Ride-Thru 1 Activate (N.O.)**

**L2-02: Power Loss Ride Through Time**  
**L2-06: Kinetic Energy Backup Decel Time**

Figure 12.91 Kinetic Energy Backup Decel Time

■ **L2-07: Kinetic Energy Backup Accel Time**

No. (Hex.)	Name	Description	Default (Range)
L2-07 (048B) Expert	Kinetic Energy Backup Accel Time	<input checked="" type="checkbox"/> V/f <input type="checkbox"/> OLV/PM <input type="checkbox"/> EZOLV Sets the acceleration time to return the frequency to the frequency reference before a power loss after canceling KEB operation.	0.0 s (0.0 - 6000.0 s)

Set this parameter to 0.0 to disable the function. The drive uses the acceleration times in *C1-01* and *C1-03* to accelerate again after KEB operation completes.

■ **L2-08: Frequency Gain at KEB Start**

No. (Hex.)	Name	Description	Default (Range)
L2-08 (048C) Expert	Frequency Gain at KEB Start	<input checked="" type="checkbox"/> V/f <input type="checkbox"/> OLV/PM <input type="checkbox"/> EZOLV Sets the quantity of output frequency reduction used when KEB operation starts as a percentage of the motor rated slip before starting KEB operation.	100% (0 - 300%)

Decreases the output frequency in steps to quickly set the motor to a regenerative condition. Use this formula to calculate the value:

$$\text{Output frequency reduction} = \text{Motor rated slip before KEB operation} \times (L2-08/100) \times 2$$

■ **L2-09: KEB Minimum Frequency Level**

No. (Hex.)	Name	Description	Default (Range)
L2-09 (048D) Expert	KEB Minimum Frequency Level	<input checked="" type="checkbox"/> V/f <input type="checkbox"/> OLV/PM <input type="checkbox"/> EZOLV Sets the quantity of output frequency reduction used as a percentage of <i>E2-02</i> [Motor Rated Slip] when KEB operation starts.	20% (0 - 100%)

These conditions set the quantity of decrease:

- Motor rated slip  $\times (L2-09/100)$
- The larger value between the value calculated with *L2-08* and the value calculated with *L2-09*

■ **L2-10: Minimum KEB Time**

No. (Hex.)	Name	Description	Default (Range)
L2-10 (048E) Expert	Minimum KEB Time	<input checked="" type="checkbox"/> V/f <input type="checkbox"/> OLV/PM <input type="checkbox"/> EZOLV Sets the minimum length of time to operate the KEB after the drive detects a momentary power loss.	50 ms (0 - 25500 ms)

When you return power while KEB is operating, the drive continues KEB operation until the time set in *L2-10* is expired. When you input *KEB Ride-Thru 1/2 [H1-xx = 65, 66, 7A, or 7B]* into the drive and the DC bus voltage is less than *L2-05 [Undervoltage Detect Level (Uv1)]*, KEB operation continues until the time set in *L2-10* is expired.

When you input KEB Ride-Thru, KEB operation continues after the time set in *L2-10* is expired. When you cancel KEB Ride-Thru, the motor accelerates again. When you do not input KEB Ride-Thru during the time set in *L2-10*, the drive accelerates to the frequency reference that the drive had before power loss in the applicable acceleration time.

**Note:**

- When *L2-01 = 0, 1, or 2 [Disabled, Enabled, or Enabled when CPU is Running]*, increase the value of *L2-10*. Set *L2-10* to cancel KEB operation if the KEB Ride-Thru is not input
- Set this parameter to 0 to disable the function.

■ **L2-11: KEB DC Bus Voltage Setpoint**

No. (Hex.)	Name	Description	Default (Range)
L2-11 (0461) Expert	KEB DC Bus Voltage Setpoint	<input type="checkbox"/> V/f <input type="checkbox"/> OLV/IPM <input type="checkbox"/> EZOLV Sets the target value that controls the DC bus voltage to a constant level in Single Drive KEB Ride-Thru 2. Sets the DC bus voltage level that completes the KEB operation for all other KEB methods.	Determined by E1-01 (Determined by E1-01)

■ **L2-29: Kinetic Energy Backup Method**

No. (Hex.)	Name	Description	Default (Range)
L2-29 (0475) Expert	Kinetic Energy Backup Method	<input type="checkbox"/> V/f <input type="checkbox"/> OLV/IPM <input type="checkbox"/> EZOLV Sets the KEB function operation mode.	0 (0 - 1)

**0 : Single Drive KEB Ride-Thru 1**

The drive monitors the DC bus voltage and uses regenerative energy from the motor to hold the DC bus voltage at the level set in *L2-11 [KEB DC Bus Voltage Setpoint]*.

The KEB operation continues and the deceleration rate changes as specified by *C1-09 [Fast Stop Time]*.

**Note:**

- If the drive detects *Uv1 [DC Bus Undervoltage]* during KEB operation, decrease the value of *C1-09*.
- If the drive detects *ov [Overvoltage]* during KEB operation, increase the value of *C1-09*.

**1 : Single Drive KEB Ride-Thru 2**

The drive does KEB operation and automatically calculates the deceleration rate to make sure that the main circuit electrical energy and main current voltage from motor regenerative energy is equal to *L2-11*.

■ **L2-30: KEB Zero Speed Operation**

No. (Hex.)	Name	Description	Default (Range)
L2-30 (045E) Expert	KEB Zero Speed Operation	<input type="checkbox"/> V/f <input type="checkbox"/> OLV/IPM <input type="checkbox"/> EZOLV Sets the operation when the output frequency decreases below the zero level (DC braking injection starting frequency) during KEB deceleration.	0 (0, 1)

**0 : Baseblock**

**1 : DC/SC Braking**

Does DC injection braking and short circuit braking as specified by *b2-04 [DC Inject Braking Time at Stop]* and *b2-13 [Short Circuit Brake Time @ Stop]*.

■ **L2-31: KEB Start Voltage Offset Level**

No. (Hex.)	Name	Description	Default (Range)
L2-31 (045D) Expert	KEB Start Voltage Offset Level	<input type="checkbox"/> V/f <input type="checkbox"/> OLV/IPM <input type="checkbox"/> EZOLV Sets the KEB start voltage offset.	Determined by A1-02 (208 V Class: 0 - 100 V, 480 V Class: 0 - 200 V)



The drive uses this formula to calculate the KEB start voltage:

$$\text{KEB start voltage} = L2-05 [\text{Undervoltage Detect Level (Uv1)}] + L2-31$$

### ◆ L3: Stall Prevention

*L3 parameters* set the Stall Prevention function and overvoltage suppression function.

#### ■ Stall Prevention

If the load is too heavy or the acceleration and deceleration times are too short, the motor can slip too much because it cannot work at the same rate as the frequency reference. If the motor stalls during acceleration, current increases as the slip increases to cause an *oC* [Overcurrent], *oL2* [Drive Overload], or *oL1* [Motor Overload] and the drive will stop. If the motor stalls during deceleration, too much regenerative power will flow back into the DC bus capacitors and cause the drive to fault out from *ov* [Overvoltage] and stop the drive.

The stall prevention function will let the motor get to the set speed without stalling and it is not necessary for you to change the acceleration or deceleration time settings. You can set a separate stall prevention functions for acceleration, operating at constant speeds, and deceleration.

#### ■ Overvoltage Suppression Function

This function decreases the regenerative torque limit and increases the output frequency when the DC bus voltage increases to prevent *ov*. This function can drive loads with cyclic regenerative operation, for example punch presses or other applications with repeated crank movements. When you use this function, set *L3-11* = 1 [Overvoltage Suppression Select = Enabled].

The drive adjusts the regenerative torque limit and the output frequency during overvoltage suppression to make sure that the DC bus voltage is not more than the level set in *L3-17* [DC Bus Regulation Level].

Set these parameters as necessary when you use the overvoltage suppression function:

- *L3-20* [DC Bus Voltage Adjustment Gain]
- *L3-21* [OVSuppression Accel/Decel P Gain]
- *L3-24* [Motor Accel Time @ Rated Torque]
- *L3-25* [Load Inertia Ratio]

##### Note:

- When overvoltage suppression is triggered, the motor speed is more than the frequency reference. Do not use overvoltage suppression for applications where the frequency reference and the motor speed must align.
- The overvoltage suppression function is enabled only when you operate immediately below the maximum frequency. Overvoltage suppression does not increase the output frequency to more than the maximum frequency. Make sure that the motor and machine specifications are correct for the application, then increase the maximum frequency.
- If there is a sudden increase to a regenerative load, *ov* can occur.

#### ■ L3-01: Stall Prevention during Accel

No. (Hex.)	Name	Description	Default (Range)
L3-01 (048F)	Stall Prevention during Accel	<input type="checkbox"/> V/f <input type="checkbox"/> OLV/PM <input type="checkbox"/> EZOLV Sets the method of Stall Prevention During Acceleration.	1 (0 - 2)

##### Note:

When *A1-02* = 5 [Control Method Selection = OLV/PM], the setting range is 0 and 1.

Stall prevention during acceleration prevents the stalling and stopping of motors when the drive detects *oC* [Overcurrent], *oL2* [Drive Overload], or *oL1* [Motor Overload] when there is a significant load applied during acceleration or when there are sudden acceleration times with respect to load inertia.

##### 0 : Disabled

The Stall Prevention function does not operate during acceleration, and acceleration occurs for the set acceleration time. If the acceleration time is too short, the motor will not fully accelerate during the set time, which causes the drive to detect *oL1* or *oL2* and the motor to stop.

##### 1 : Enabled

Enables the Stall Prevention During Acceleration function. Operation is different for different control methods.

• **V/f Control or EZ Open Loop Vector Control**

The drive stops acceleration if the output current is more than *L3-02* [Stall Prevent Level during Accel]. If the output current is less than *L3-02* - 15%, the drive stops deceleration. The Stall Prevention function level automatically decreases for constant output ranges.

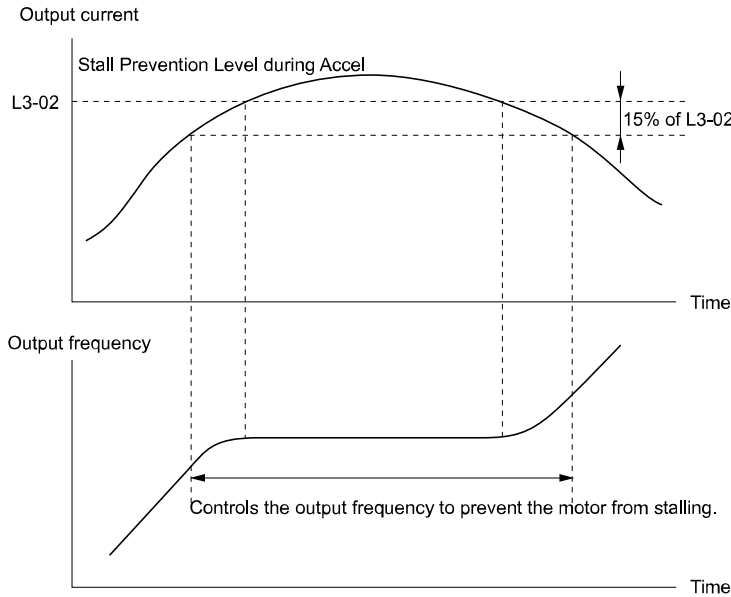

**L3-02: Stall Prevent Level during Accel**

**Figure 12.92 Stall Prevention During Acceleration when Using Induction Motors**

• **Open Loop Vector Control for PM**

When the output current is more than the value set in *L3-02*, the drive stops acceleration. When the time set in *L3-27* [Stall Prevention Detection Time] is expired and the output current is larger than in *L3-02*, the drive will start deceleration in as specified by *L3-22* [PM Stall Prevention Decel Time]. The drive starts acceleration again when the output current is less than *L3-02* - 15%. When the time set in *L3-27* is expired, the drive starts acceleration again.

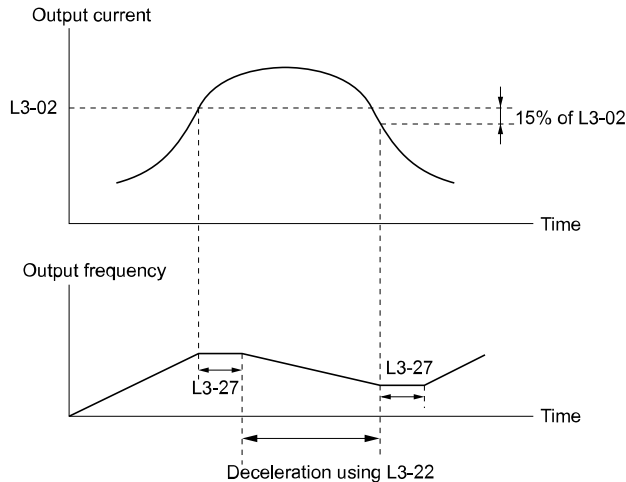

**L3-02: Stall Prevent Level during Accel**  
**L3-22: PM Stall Prevention Decel Time**

**L3-27: Stall Prevention Detection Time**

**Figure 12.93 Stall Prevention During Acceleration Function in OLV/PM**

**2 : Intelligent (Ignore Accel Ramp)**

The drive ignores the acceleration time setting and the drive starts to accelerate in the minimum length of time. The drive automatically adjusts the acceleration rate to make sure that the output current is not more than *L3-02*.

### ■ L3-02: Stall Prevent Level during Accel

No. (Hex.)	Name	Description	Default (Range)
L3-02 (0490)	Stall Prevent Level during Accel	<input type="checkbox"/> V/f <input type="checkbox"/> OLVP/M <input type="checkbox"/> EZOLV Sets the output current level to activate the Stall Prevention function during acceleration as a percentage of the drive rated output current.	Determined by L8-38 (0 - 120%)

**Note:**

- If you use a motor that is small compared to the drive and the motor stalls, decrease the setting value.
- When you operate the motor in the constant power range, set L3-03 [Stall Prevent Limit during Accel].

### ■ L3-03: Stall Prevent Limit during Accel

No. (Hex.)	Name	Description	Default (Range)
L3-03 (0491)	Stall Prevent Limit during Accel	<input type="checkbox"/> V/f <input type="checkbox"/> OLVP/M <input type="checkbox"/> EZOLV Sets the lower limit for the stall prevention level used in the constant output range as a percentage of the drive rated output current.	50% (0 - 100%)

The stall prevention level set in L3-02 [Stall Prevent Level during Accel] is automatically reduced when the motor is running within the constant output range. Parameter L3-03 is the limit value used to prevent the stall prevention level during constant output ranges to fall below the minimum required level.

**Note:**

The function to automatically reduce the stall prevention level does not operate when L3-01 = 3 [Stall Prevention during Accel = Current Limit Method].

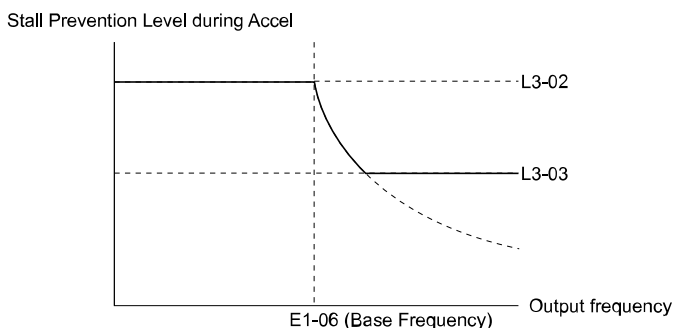

Figure 12.94 Stall Prevent Level during Accel/Limit

### ■ L3-04: Stall Prevention during Decel

No. (Hex.)	Name	Description	Default (Range)
L3-04 (0492)	Stall Prevention during Decel	<input type="checkbox"/> V/f <input type="checkbox"/> OLVP/M <input type="checkbox"/> EZOLV Sets the method that the drive will use to prevent overvoltage faults when decelerating.	1 (Determined by A1-02)

**Note:**

The setting range changes when the A1-02 [Control Method Selection] value changes:

- When A1-02 = 5 [OLVP/M], the setting range is 0 to 2.
- When A1-02 = 8 [EZOLV], the setting range is 0, 1.

Stall Prevention during deceleration controls the deceleration as specified by the DC bus voltage and does not let high inertia or fast deceleration cause *ov* [Overvoltage] faults.

#### 0 : Disabled

The drive decelerates as specified by the deceleration time. If the deceleration time is too short, the drive can detect an *ov* fault.

#### 1 : General Purpose

The drive decelerates as specified by the deceleration time. When the DC bus voltage is more than the Stall Prevention level, the drive stops deceleration until the DC bus voltage is less than the Stall Prevention Level. The

drive then starts to decelerate at the set deceleration time. Frequent use of Stall Prevention will help prevent *ov* faults when the deceleration time is shorter than the drive can usually accept.

**Note:**

The Decel Stall Prevention function will increase the deceleration time to stop and the deceleration time will be longer than the setting. The input voltage setting of *E1-01 [Input AC Supply Voltage]* sets the DC bus voltage level for Stall Prevention.

**Table 12.59 Stall Prevention Level during Deceleration**

Drive Input Voltage	Stall Prevention Level during Deceleration
208 V class	377 V
480 V class	754 V

Figure 12.95 shows the Stall Prevention during deceleration function.

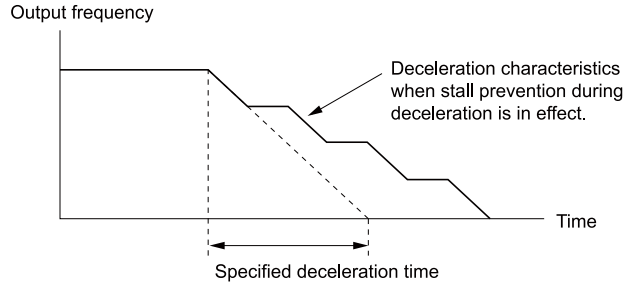

**Figure 12.95 Stall Prevention Operation during Deceleration**

**2 : Intelligent (Ignore Decel Ramp)**

The drive adjusts the deceleration rate to keep the DC bus voltage at the *L3-17 [DC Bus Regulation Level]* level. This makes the shortest possible deceleration time and will not let the motor stall. The drive ignores the selected deceleration time and the possible deceleration time cannot be less than 1/10 of the set deceleration time.

This function uses these parameters to adjust the deceleration rate:

- *L3-20 [DC Bus Voltage Adjustment Gain]*
- *L3-21 [OVSuppression Accel/Decel P Gain]*
- *L3-24 [Motor Accel Time @ Rated Torque]*
- *L3-25 [Load Inertia Ratio]*

**4 : Overexcitation/High Flux**

The drive enables Overexcitation/High Flux and enables a shorter deceleration time than when *L3-04 = 0*.

**Note:**

- If the overexcitation time is long and you decelerate frequently, the drive can detect *oL1 [Motor Overload]* faults. If the drive detects *oL1*, decrease the deceleration time.
- The deceleration time during Overexcitation Deceleration changes when the motor characteristics and machine inertia change. Adjust the *n3-13 [OverexcitationBraking (OEB) Gain]* and *n3-23 [Overexcitation Braking Operation]* levels. Refer to “n3: HighSlip/OverexciteBraking” for more information about the overexcitation function.

**■ L3-05: Stall Prevention during RUN**

No. (Hex.)	Name	Description	Default (Range)
L3-05 (0493)	Stall Prevention during RUN	<input type="checkbox"/> V/f <input type="checkbox"/> OLV/IPM <input type="checkbox"/> EZOLV Sets the function to enable and disable Stall Prevention During Run.	Determined by A1-02 (0 - 3)

Stall Prevention function during run automatically decreases the speed when an *oL1 [Motor Overload]* occurs while the motor is running at constant speed to prevent the motor from stalling.

**Note:**

- An output frequency lower than 6 Hz will disable Stall Prevention during Run. The *L3-05* and *L3-06 [Stall Prevent Level during Run]* settings do not have an effect.
- The default setting changes when the *A1-02 [Control Method Selection]* value changes:
  - *A1-02 = 0, 5 [V/f, OLV/IPM]: 2*
  - *A1-02 = 8 [EZOLV]: 3*

**0 : Disabled**

The drive runs at the set frequency reference. A heavy load can cause the drive to detect *oC* [Overcurrent] or *oLI* and stall the motor.

**1 : Deceleration Time 1 (C1-02)**

The drive will decelerate for the time set in *C1-02* [Deceleration Time 1] when the current is more than the Stall Prevention level set in *L3-06*. When the current level is less than the “*L3-06* setting value - 2%” for 100 ms, the drive accelerates again for the acceleration time applicable at that time until it reaches the set frequency.

**2 : Deceleration Time 2 (C1-04)**

This setting functions the same as *Setting 1* [Deceleration Time 1 (*C1-02*)]. When the Stall Prevention function is enabled, the drive decelerates with the value set in *C1-04* [Deceleration Time 2].

**3 : Intelligent**

Available when *A1-02* = 8 [EZOLV]. The drive operates with the largest possible output and prevents motor stalling.

**■ L3-06: Stall Prevent Level during Run**

No. (Hex.)	Name	Description	Default (Range)
L3-06 (0494)	Stall Prevent Level during Run	<b>V/f</b> <b>OLV/PM</b> <b>EZOLV</b> Sets the output current level to enable the Stall Prevention function during operation as a percentage of the drive rated output current.	Determined by L8-38 (5 - 120%)

**Note:**

- This parameter is applicable when *L3-05* = 1, 2 [Stall Prevention during RUN = Deceleration Time 1 (*C1-02*), Deceleration Time 2 (*C1-04*)].
- When *L3-23* = 1 [Stall P Reduction at Constant HP = Automatic Reduction @ CHP Region], the drive will automatically decrease the level in the constant output range.

**Use an Analog Input to Change the Stall Prevent Level during Run**

When *H3-xx* = 8 [MFAI Function Selection = Stall Prevent Level During Run], you can change the stall prevention level during run through the input gain and bias settings for terminals A1 and A2.

If you set the input level for terminals A1 and A2 and *L3-06*, the drive will use the smaller value for Stall Prevent Level during Run.

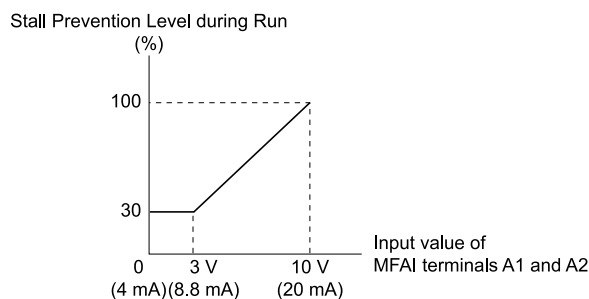

Figure 12.96 Stall Prevention Level during Run with Analog Input

**■ L3-11: Overvoltage Suppression Select**

No. (Hex.)	Name	Description	Default (Range)
L3-11 (04C7)	Overvoltage Suppression Select	<b>V/f</b> <b>OLV/PM</b> <b>EZOLV</b> Sets the overvoltage suppression function.	0 (0, 1)

**0 : Disabled**

The drive does not adjust the regenerative torque limit or the output frequency. If you apply a regenerative load, the drive can detect an *ov* [Overvoltage] fault.

**1 : Enabled**

When a regenerative load increases the DC bus voltage, the drive decreases the regenerative torque limit and increases the output frequency to prevent *ov*.

### ■ L3-17: DC Bus Regulation Level

No. (Hex.)	Name	Description	Default (Range)
L3-17 (0462)	DC Bus Regulation Level	<div style="display: flex; justify-content: space-between; align-items: center;"> <span style="background-color: #ccc; padding: 2px;">V/f</span> <span style="background-color: #ccc; padding: 2px;">OLV/PM</span> <span style="background-color: #ccc; padding: 2px;">EZOLV</span> </div> Sets the target value for the DC bus voltage when the overvoltage suppression function and the Decel Stall Prevention function (Intelligent Stall Prevention) are active.	208 V Class: 375 V, 480 V Class: 750 V (208 V Class: 150 - 400 V, 480 V Class: 300 - 800 V)

**Note:**

This value is initialized when *E1-01 [Input AC Supply Voltage]* is changed.

Sets this parameter for any of the following circumstances.

- *L3-11 = 1 [Overvoltage Suppression Select = Enabled]*.
- *L3-04 = 2 [Stall Prevention during Decel = Intelligent (Ignore Decel Ramp)]*.

### ■ L3-20: DC Bus Voltage Adjustment Gain

No. (Hex.)	Name	Description	Default (Range)
L3-20 (0465) Expert	DC Bus Voltage Adjustment Gain	<div style="display: flex; justify-content: space-between; align-items: center;"> <span style="background-color: #ccc; padding: 2px;">V/f</span> <span style="background-color: #ccc; padding: 2px;">OLV/PM</span> <span style="background-color: #ccc; padding: 2px;">EZOLV</span> </div> Sets the proportional gain used to control the DC bus voltage.	Determined by A1-02 (0.00 - 5.00)

Set one of these parameters to enable L3-20:

- *L2-29 = 1 [Kinetic Energy Backup Method = Single Drive KEB Ride-Thru 2]*
- *L3-04 = 2 [Stall Prevention during Decel = Intelligent (Ignore Decel Ramp)]*
- *L3-11 = 1 [Overvoltage Suppression Select = Enabled]*
- *H1-xx = 7A or 7B [MFDI Function Selection = KEB Ride-Thru 2 Activate (N.O./N.C.)]*

**Note:**

- If stall prevention during deceleration function causes *ov [Overvoltage]* and *Uv1 [DC Bus Undervoltage]* faults when you start deceleration and *L2-29 = 1*, *H1-xx = 7A or 7B*, or *L3-04 = 2*, gradually increase this parameter in 0.1-unit increments. If the setting value is too high, it can cause large speed or current ripples.
- If sudden increases in the regenerative load cause *ov* faults and *L3-11 = 1*, gradually increase this parameter in 0.1-unit increments. If the setting value is too high, it can cause large speed or current ripples.

### ■ L3-21: OVSsuppression Accel/Decel P Gain

No. (Hex.)	Name	Description	Default (Range)
L3-21 (0466) Expert	OVSsuppression Accel/Decel P Gain	<div style="display: flex; justify-content: space-between; align-items: center;"> <span style="background-color: #ccc; padding: 2px;">V/f</span> <span style="background-color: #ccc; padding: 2px;">OLV/PM</span> <span style="background-color: #ccc; padding: 2px;">EZOLV</span> </div> Sets the proportional gain to calculate acceleration and deceleration rates.	1.00 (0.10 - 10.00)

Set one of these parameters to enable this parameter:

- *L2-29 = 1 [Kinetic Energy Backup Method = Single Drive KEB Ride-Thru 2]*
- *L3-04 = 2 [Stall Prevention during Decel = Intelligent (Ignore Decel Ramp)]*
- *L3-11 = 1 [Overvoltage Suppression Select = Enabled]*
- *H1-xx = 7A or 7B [MFDI Function Selection = KEB Ride-Thru 2 Activate (N.O./N.C.)]*

**Note:**

- If stall prevention during deceleration function causes large speed or current ripples and *L2-29 = 1*, *H1-xx = 7A or 7B*, or *L3-04 = 2*, gradually decrease this parameter in 0.05-unit increments. If the drive detects *ov [Overvoltage]* or *oC [Overcurrent]*, decrease this parameter. If you decrease the gain too much, it can cause a delay in control in the DC bus voltage or the deceleration time could be longer than the best deceleration time.
- If sudden increases in the regenerative load cause *ov* faults and *L3-11 = 1*, gradually increase this parameter in 0.1-unit increments. If there are large speed ripples, gradually decrease this parameter in 0.05-unit increments.

### ■ L3-22: PM Stall Prevention Decel Time

No. (Hex.)	Name	Description	Default (Range)
L3-22 (04F9)	PM Stall Prevention Decel Time	<div style="display: flex; justify-content: space-between; align-items: center;"> <span>V/f</span> <span>OLV/PM</span> <span>EZOLV</span> </div> <p>Sets the momentary deceleration time that the drive will use when it tries to accelerate a PM motor and detected motor stalls. This function is applicable when L3-01 = 1 [Stall Prevention during Accel = Enabled].</p>	0.0 s (0.0 - 6000.0 s)

Set this parameter to 0.0 s to disable this function. The drive will decelerates in the deceleration time applicable at the time when a motor stall occurs.

### ■ L3-23: Stall P Reduction at Constant HP

No. (Hex.)	Name	Description	Default (Range)
L3-23 (04FD)	Stall P Reduction at Constant HP	<div style="display: flex; justify-content: space-between; align-items: center;"> <span>V/f</span> <span>OLV/PM</span> <span>EZOLV</span> </div> <p>Sets the function to automatically decrease the Stall Prevention Level during Run for Constant Horse Power (CHP) part of the speed range.</p>	0 (0, 1)

#### 0 : Use L3-06 for Entire Speed Range

The drive uses the level set in L3-06 [Stall Prevent Level during Run] through the full speed range.

#### 1 : Automatic Reduction @ CHP Region

The drive decreases the Stall Prevention level during run in the constant power range. The lower limit is 40% of the L3-06 value.

### ■ L3-24: Motor Accel Time @ Rated Torque

No. (Hex.)	Name	Description	Default (Range)
L3-24 (046E) Expert	Motor Accel Time @ Rated Torque	<div style="display: flex; justify-content: space-between; align-items: center;"> <span>V/f</span> <span>OLV/PM</span> <span>EZOLV</span> </div> <p>Sets the motor acceleration time to reach the maximum frequency at the motor rated torque for stopped single-drive motors.</p>	Determined by o2-04, E2-11, and E5-01 (0.001 - 10.000 s)

Set one of these parameters to enable L3-24:

- L2-29 = 1 [Kinetic Energy Backup Method = Single Drive KEB Ride-Thru 2]
- L3-04 = 2 [Stall Prevention during Decel = Intelligent (Ignore Decel Ramp)]
- L3-11 = 1 [Overvoltage Suppression Select = Enabled]
- H1-xx = 7A or 7B [MFDDI Function Selection = KEB Ride-Thru 2 Activate (N.O./N.C.)]

#### Note:

When Auto-Tuning changes the value of E2-11 [Motor Rated Power], the drive will automatically set L3-24 to the value for a Yaskawa standard motor (4 poles). When you use a PM motor, the drive uses the value in E5-01 [PM Motor Code Selection] to change L3-24.

#### Manually Adjust Parameters

Use this formula to find the motor acceleration time:

$$L3-24 = \frac{2\pi \cdot J_{\text{Motor}} \cdot n_{\text{rated}}}{60 \cdot T_{\text{rated}}}$$

- $J_{\text{Motor}}$  = Moment of inertia of motor (kg m<sup>2</sup>)
- $n_{\text{rated}}$  = Motor rated speed (min<sup>-1</sup>, r/min)
- $T_{\text{rated}}$  = Motor rated torque (N·m)

The rated torque is calculated using the following expression.

$$T_{\text{rated}} = \frac{60 \cdot P_{\text{Motor}} \cdot 10^3}{2\pi \cdot n_{\text{rated}}}$$

$P_{\text{Motor}}$  = Motor Rated Power (kW)

### ■ L3-25: Load Inertia Ratio

No. (Hex.)	Name	Description	Default (Range)
L3-25 (046F) Expert	Load Inertia Ratio	<div style="display: flex; gap: 5px;"> <span>V/f</span> <span>OLV/IPM</span> <span>EZOLV</span> </div> Sets the ratio between motor inertia and machine inertia.	1.0 (0.1 - 1000.0)

Set one of these parameters to enable L3-25:

- L2-29 = 1 [*Kinetic Energy Backup Method = Single Drive KEB Ride-Thru 2*]
- L3-04 = 2 [*Stall Prevention during Decel = Intelligent (Ignore Decel Ramp)*]
- L3-11 = 1 [*Overvoltage Suppression Select = Enabled*]
- H1-xx = 7A or 7B [*MFDDI Function Selection = KEB Ride-Thru 2 Activate (N.O./N.C.)*]

**Note:**

If you set this value incorrectly when L2-29 = 1, H1-xx = 7A or 7B, or L3-11 = 1, it can cause large current ripples and ov [Overvoltage], Uv1 [DC Bus Undervoltage], or oC [Overcurrent] faults.

### Manually Adjust Parameters

Use this formula to find the load inertia ratio:

$$\text{Load inertia ratio} = \frac{\text{Machine inertia (Motor shaft conversion value)}}{\text{Motor inertia}}$$

### ■ L3-26: Additional DC Bus Capacitors

No. (Hex.)	Name	Description	Default (Range)
L3-26 (0455) Expert	Additional DC Bus Capacitors	<div style="display: flex; gap: 5px;"> <span>V/f</span> <span>OLV/IPM</span> <span>EZOLV</span> </div> Sets the capacity for external main circuit capacitors. Usually it is not necessary to change this setting. Sets this parameter when you use the KEB Ride-Thru function.	0 μF (0 to 65000 μF)

### ■ L3-27: Stall Prevention Detection Time

No. (Hex.)	Name	Description	Default (Range)
L3-27 (0456)	Stall Prevention Detection Time	<div style="display: flex; gap: 5px;"> <span>V/f</span> <span>OLV/IPM</span> <span>EZOLV</span> </div> Sets a delay time between reaching the Stall Prevention level and starting the Stall Prevention function.	50 ms (0 - 5000 ms)

### ■ L3-35: Speed Agree Width for Auto Decel

No. (Hex.)	Name	Description	Default (Range)
L3-35 (0747) Expert	Speed Agree Width for Auto Decel	<div style="display: flex; gap: 5px;"> <span>V/f</span> <span>OLV/IPM</span> <span>EZOLV</span> </div> Sets the width for speed agreement when L3-04 = 2 [ <i>Stall Prevention during Decel = Intelligent (Ignore Decel Ramp)</i> ]. Usually it is not necessary to change this setting.	0.00 Hz (0.00 - 1.00 Hz)

Set this parameter when hunting occurs while you use a frequency reference through an analog input.

## ◆ L4: Speed Detection

L4 parameters set the output of signals to the MFDO terminals, for example frequency agree and frequency detection.

### ■ L4-01: Speed Agree Detection Level

No. (Hex.)	Name	Description	Default (Range)
L4-01 (0499)	Speed Agree Detection Level	<div style="display: flex; gap: 5px;"> <span>V/f</span> <span>OLV/IPM</span> <span>EZOLV</span> </div> Sets the level to detect speed agree or motor speed when H2-01 to H2-03 = 2, 3, 4, 5 [ <i>MFDDO Function Selection = Speed Agree 1, User-Set Speed Agree 1, Frequency Detection 1, Frequency Detection 2</i> ].	0.0 Hz (0.0 - 400.0 Hz)



### ■ L4-02: Speed Agree Detection Width

No. (Hex.)	Name	Description	Default (Range)
L4-02 (049A)	Speed Agree Detection Width	<b>V/f</b> <b>OLV/PM</b> <b>EZOLV</b> Sets the width to detect speed agree or motor speed when H2-01 to H2-03 = 2, 3, 4, 5 [MFDO Function Selection = Speed Agree 1, User-Set Speed Agree 1, Frequency Detection 1, Frequency Detection 2].	2.0 Hz (0.0 - 20.0 Hz)

### ■ L4-03: Speed Agree Detection Level (+/-)

No. (Hex.)	Name	Description	Default (Range)
L4-03 (049B)	Speed Agree Detection Level (+/-)	<b>V/f</b> <b>OLV/PM</b> <b>EZOLV</b> Sets the speed agree detection level or motor speed detection level when H2-01 to H2-03 = 13, 14, 15, 16 [MFDO Function Selection = Speed Agree 2, User-Set Speed Agree 2, Frequency Detection 3, Frequency Detection 4].	0.0 Hz (-400.0 - +400.0 Hz)

### ■ L4-04: Speed Agree Detection Width (+/-)

No. (Hex.)	Name	Description	Default (Range)
L4-04 (049C)	Speed Agree Detection Width (+/-)	<b>V/f</b> <b>OLV/PM</b> <b>EZOLV</b> Sets the width to detect speed agree or motor speed when H2-01 to H2-03 = 13, 14, 15, 16 [MFDO Function Selection = Speed Agree 2, User-Set Speed Agree 2, Frequency Detection 3, Frequency Detection 4].	2.0 Hz (0.0 - 20.0 Hz)

### ■ L4-05: Fref Loss Detection Selection

No. (Hex.)	Name	Description	Default (Range)
L4-05 (049D)	Fref Loss Detection Selection	<b>V/f</b> <b>OLV/PM</b> <b>EZOLV</b> Sets the operation when the drive detects a loss of frequency reference.	1 (0, 1)

Enables the detection of a loss of an analog frequency reference when MFAI terminals (A1 and A2) input the frequency reference. Set H2-01 to H2-03 = C [MFDO Function Selection = Frequency Reference Loss] to enable this function.

If the frequency reference is less than 10% in 400 ms, the drive detects frequency reference loss.

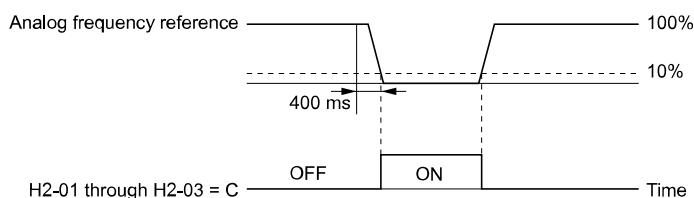

Figure 12.97 Detection of Frequency Reference Loss

#### 0 : Stop

The drive follows the frequency reference and stops the motor.

#### 1 : Run at (L4-06 x Last Reference)

The drive continues to operate at the frequency reference value set in L4-06 [Frequency Reference @Loss of Ref]. When you return the external frequency reference value, the drive continues to operate with the frequency reference.

### ■ L4-06: Frequency Reference @Loss of Ref

No. (Hex.)	Name	Description	Default (Range)
L4-06 (04C2)	Frequency Reference @Loss of Ref	<b>V/f</b> <b>OLV/PM</b> <b>EZOLV</b> Sets the frequency reference as a percentage to continue drive operation after it detects a frequency reference loss. The value is a percentage of the frequency reference before the drive detected the loss.	80.0% (0.0 - 100.0%)

Set L4-05 = 1 [Fref Loss Detection Selection = Run at (L4-06 x Last Reference)] to enable this parameter.

■ **L4-07: Speed Agree Detection Selection**

No. (Hex.)	Name	Description	Default (Range)
L4-07 (0470)	Speed Agree Detection Selection	<div style="display: flex; gap: 5px;"> <span style="border: 1px solid black; padding: 2px;">V/f</span> <span style="border: 1px solid black; padding: 2px;">OLV/PM</span> <span style="border: 1px solid black; padding: 2px;">EZOLV</span> </div> Sets the condition that activates speed detection.	0 (0, 1)

**0 : No Detection during Baseblock**

Detects the frequency while the drive is operating. When the drive turns off its output, it will not detect frequency.

**1 : Detection Always Enabled**

◆ **L5: Fault Restart**

The Auto Restart function tries to keep machines operating when the drive detects a transient fault.

The drive can do a self-diagnostic check and continue the operation after a fault. If the cause of the fault goes away, the drive does speed search and restarts. It will not stop and the drive will not record a fault history. Use L5-02 [Fault Contact at Restart Select] to select the operation of fault relay signals during Auto Restart operation.

The Auto Restart function sets the drive to try to automatically restart the drive a set number of times in a set time. If the number of Auto Restart tries is more than the set value during the set time, drive output shuts off and operation stops. If this happens, remove the cause of the fault and manually restart the drive.

The drive can do Auto Restart when it detects these faults:

**Note:**

You can disable Auto Restart for faults if you must not restart the machine after the fault.

**Table 12.60 List of Faults during which Auto Restart is Available**

Fault	Name	Parameters to Disable Auto Restart	Fault	Name	Parameters to Disable Auto Restart
CE	Modbus Communication Error	H5-36	oL1	Motor Overload	L5-07
FDBKL	WIRE Break	L5-42	oL2	Drive Overload	L5-07
GF	Ground Fault	L5-08	oL3	Overtorque Detection 1	L5-07
HFB	High Feedback Sensed	L5-41	oL4	Overtorque Detection 2	L5-07
LF	Output Phase Loss	-	ov	Overvoltage	L5-08
LFB	Low Feedback Sensed	L5-40	PF	Input Phase Loss	-
LOP	Loss of Prime	L5-51	STPo	Motor Step-Out Detected	-
NMS	Setpoint Not Met	L5-50	Uv1	DC Bus Undervoltage <sup>*1</sup>	L5-08
oC	Overcurrent	-	VLTS	Thermostat Fault	L5-53
oH1	Heatsink Overheat	L5-08			

\*1 Uv1 is the target for the auto restart process when L2-01 = 1 or 2 [Power Loss Ride Through Select = Enabled for L2-02 Time or Enabled while CPU Power Active].

**Note:**

- The Fault Restart method is limited to the interval time that the drive will use L5-04 [Interval Method Restart Time].
- When L5-49 = 1 [Fault Retry Speed Search Select = Enabled], the drive will do a speed search when it resets and restarts after a fault.
- The drive will force the output frequency to zero during the auto-restart interval time.
- If you remove the Run (or HAND) command during the auto-restart interval time, the drive will immediately detect a fault and reset the fault.
- The LOP [Loss of Prime] fault uses Y1-23 [Prime Loss Max Restart Time] for Auto Restart time. The other faults use L5-04 for Auto Restart time.
- When you enable Thrust or Pre-Charge Modes, the drive will operate them correctly

## ■ L5-01: Number of Auto-Restart Attempts

No. (Hex.)	Name	Description	Default (Range)
L5-01 (049E)	Number of Auto-Restart Attempts	<b>V/f</b> <b>OLV/PM</b> <b>EZOLV</b> Sets the number of times that the drive will try to restart.	0 (0 - 10 times)

The drive resets the number of Auto Restart attempts to 0 in these conditions:

- The drive operates correctly for 10 minutes after a fault restart.
- When you manually clear a fault after the drive triggers protective functions.
- When you re-energize the drive.

## ■ L5-02: Fault Contact at Restart Select

No. (Hex.)	Name	Description	Default (Range)
L5-02 (049F)	Fault Contact at Restart Select	<b>V/f</b> <b>OLV/PM</b> <b>EZOLV</b> Sets the function that sends signals to the MFDO terminal set for <i>Fault [H2-xx = E]</i> while the drive is automatically restarting.	0 (0, 1)

### 0 : Active Only when Not Restarting

The drive will only activate fault output when the drive cancels the Auto Restart function.

When you remove the Run command during the time set in *L5-04 [Interval Method Restart Time]*, the drive will cancel the Auto Restart function. At the same time, the drive will activate the fault output. Refer to [Figure 12.98](#) for more information.

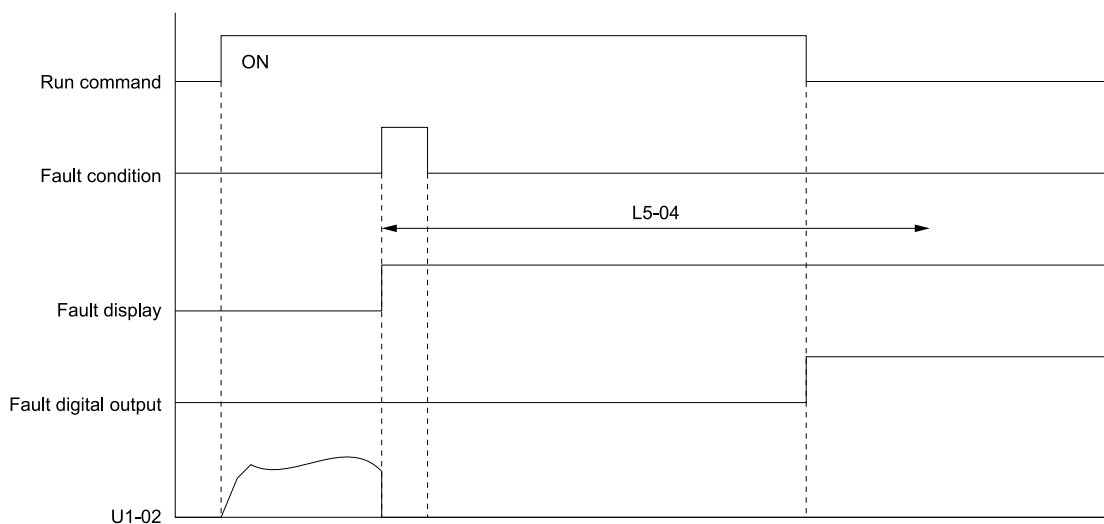

L5-04: Interval Method Restart Time

U1-02: Output Frequency

Figure 12.98 Time Chart for Early Cancellation of Auto-Restart Function

### 1 : Always Active

The drive always activates fault output.

## ■ L5-04: Interval Method Restart Time

No. (Hex.)	Name	Description	Default (Range)
L5-04 (046C)	Interval Method Restart Time	<b>V/f</b> <b>OLV/PM</b> <b>EZOLV</b> Sets the time interval between each Auto Restart attempt.	10.0 s (0.5 - 3600.0 s)

■ L5-07: Fault Reset Enable Select Grp1

No. (Hex.)	Name	Description	Default (Range)
L5-07 (0B2A)	Fault Reset Enable Select Grp1	<div style="display: flex; justify-content: space-between; align-items: center;"> <span style="background-color: black; color: white; padding: 2px;">V/f</span> <span style="background-color: black; color: white; padding: 2px;">OLV/PM</span> <span style="background-color: black; color: white; padding: 2px;">EZOLV</span> </div> Use these 4 digits to set the Auto Restart function for <i>oL1</i> to <i>oL4</i> . From left to right, the digits set <i>oL1</i> , <i>oL2</i> , <i>oL3</i> , and <i>oL4</i> , in order.	1111 (0000 - 1111)

0000 : Disabled

0001 : Enabled (—/—/—/oL4)

0010 : Enabled (—/—/oL3/—)

0011 : Enabled (—/—/oL3/oL4)

0100 : Enabled (—/oL2/—/—)

0101 : Enabled (—/oL2/—/oL4)

0110 : Enabled (—/oL2/oL3/—)

0111 : Enabled (—/oL2/oL3/oL4)

1000 : Enabled (oL1/—/—/—)

1001 : Enabled (oL1/—/—/oL4)

1010 : Enabled (oL1/—/oL3/—)

1011 : Enabled (oL1/—/oL3/oL4)

1100 : Enabled (oL1/oL2/—/—)

1101 : Enabled (oL1/oL2/—/oL4)

1110 : Enabled (oL1/oL2/oL3/—)

1111 : Enabled (oL1/oL2/oL3/oL4)

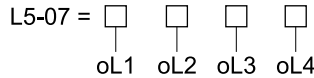

Figure 12.99 Setting Digits and Fault Code

■ L5-08: Fault Reset Enable Select Grp2

No. (Hex.)	Name	Description	Default (Range)
L5-08 (0B2B)	Fault Reset Enable Select Grp2	<div style="display: flex; justify-content: space-between; align-items: center;"> <span style="background-color: black; color: white; padding: 2px;">V/f</span> <span style="background-color: black; color: white; padding: 2px;">OLV/PM</span> <span style="background-color: black; color: white; padding: 2px;">EZOLV</span> </div> Use these 4 digits to set the Auto Restart function for <i>Uv1</i> , <i>ov</i> , <i>oH1</i> , and <i>GF</i> . From left to right, the digits set <i>Uv1</i> , <i>ov</i> , <i>oH1</i> , and <i>GF</i> , in order.	1111 (0000 - 1111)

0000 : Disabled

0001 : Enabled (—/—/—/GF)

0010 : Enabled (—/—/oH1/—)

0011 : Enabled (—/—/oH1/GF)

0100 : Enabled (—/ov/—/—)

0101 : Enabled (—/ov/—/GF)

0110 : Enabled (—/ov/oH1/—)

0111 : Enabled (—/ov/oH1/GF)

1000 : Enabled (Uv1/—/—/—)

1001 : Enabled (Uv1/—/—/GF)

1010 : Enabled (Uv1/—/oH1/—)

1011 : Enabled (Uv1/—/oH1/GF)

1100 : Enabled (Uv1/ov/—/—)

1101 : Enabled (Uv1/ov/—/GF)

1110 : Enabled (Uv1/ov/oH1/—)

1111 : Enabled (Uv1/ov/oH1/GF)

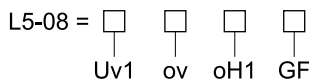

Figure 12.100 Setting Digits and Fault Code

■ L5-40: Low Feedback Flt Retry Selection

No. (Hex.)	Name	Description	Default (Range)
L5-40 (3670)	Low Feedback Flt Retry Selection	<input checked="" type="checkbox"/> V/f <input checked="" type="checkbox"/> OL/VP/PM <input checked="" type="checkbox"/> EZOLV Sets the drive to do an Auto Restart when the drive detects an LFB [Low Feedback Sensed] fault.	0 (0, 1)

0 : No Retry

1 : Retry

- When L5-40 = 1 and b5-09 = 1 [PID Output Level Selection = Reverse Output (Reverse Acting)], the auto-restart timer will not start timing until after the feedback level increases to more than Y1-08 [Low Feedback Level] (+ Y1-14 [High Feedback Hysteresis Level]).
- The drive will set the output frequency to zero during the auto-restart interval time.
- If you remove the Run (or HAND) Command during the auto-restart interval time, the drive will immediately detect and reset the fault.
- When L5-49 = 1 [Fault Retry Speed Search Select = Enabled], the drive will do a speed search when it resets and restarts after a fault.
- When you enable Thrust or Pre-Charge Modes, the drive will operate them correctly.

When L5-40 = 1, the drive operation will change when b5-09 [PID Output Level Selection] changes:

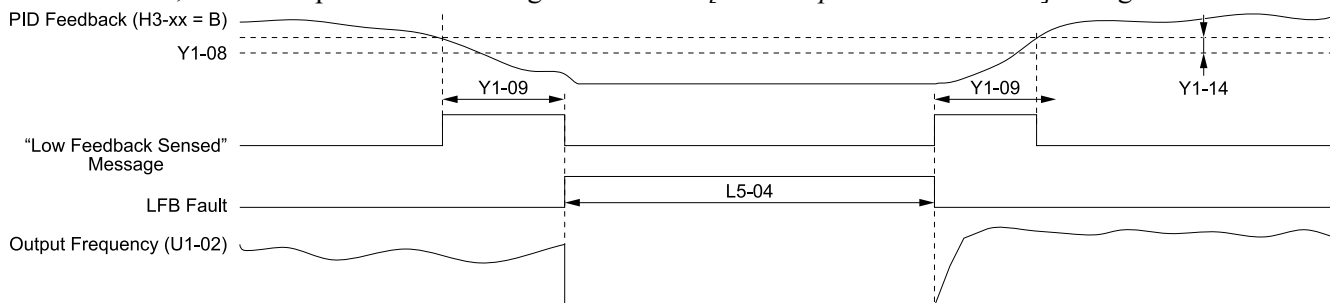

H3-xx = B: PID Feedback  
 L5-04: Interval Method Restart Time  
 Y1-08: Low Feedback Level

Y1-09: Low Feedback Lvl Fault Dly Time  
 Y1-14: Feedback Hysteresis Level  
 LFB Fault: Low Feedback Sensed

Figure 12.101 Auto Restart for Low Feedback Detection when b5-09 = 0 [Normal Output (Direct Acting)]

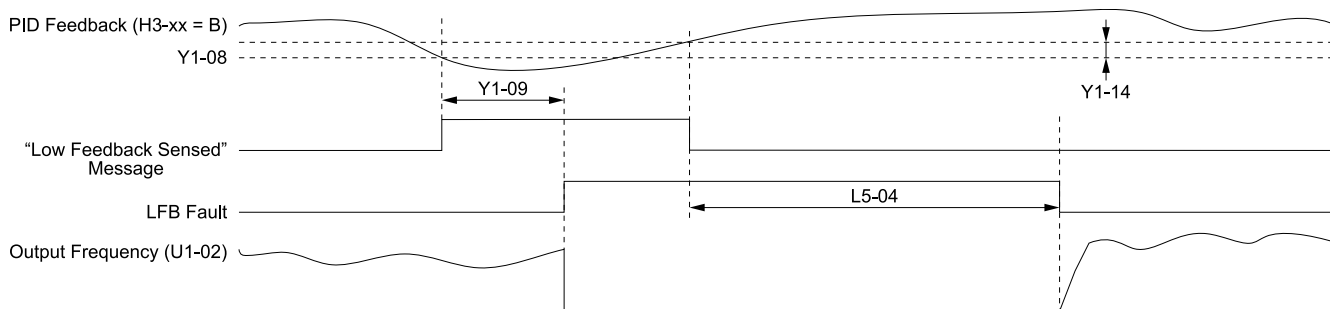

H3-xx = B: PID Feedback  
 L5-04: Interval Method Restart Time  
 Y1-08: Low Feedback Level

Y1-09: Low Feedback Lvl Fault Dly Time  
 Y1-14: Feedback Hysteresis Level  
 LFB Fault: Low Feedback Sensed

Figure 12.102 Auto Restart for Low Feedback Detection when b5-09 = 1

■ L5-41: Hi Feedback Flt Retry Selection

No. (Hex.)	Name	Description	Default (Range)
L5-41 (3671)	Hi Feedback Flt Retry Selection	<b>V/f</b> <b>OLV/PM</b> <b>EZOLV</b> Sets the drive to do an Auto Restart when the drive detects an <i>HFB</i> [High Feedback Sensed] fault.	0 (0, 1)

0 : No Retry

1 : Retry

- When  $L5-41 = 1$  and  $b5-09 = 0$  [*PID Output Level Selection = Normal Output (Direct Acting)*], the auto-restart timer will not start timing until after the feedback level decreases to less than  $Y1-11$  [*High Feedback Level*] ( $- Y1-14$  [*High Feedback Hysteresis Level*]).
- The drive will set the output frequency to zero during the auto-restart interval time.
- If you remove the Run (or HAND) Command during the auto-restart interval time, the drive will immediately detect and reset the fault.
- When  $L5-49 = 1$  [*Fault Retry Speed Search Select = Enabled*], the drive will do a speed search when it resets and restarts after a fault.
- When you enable Thrust or Pre-Charge Modes, the drive will operate them correctly.

When  $L5-41 = 1$ , the drive operation will change when  $b5-09$  [*PID Output Level Selection*] changes:

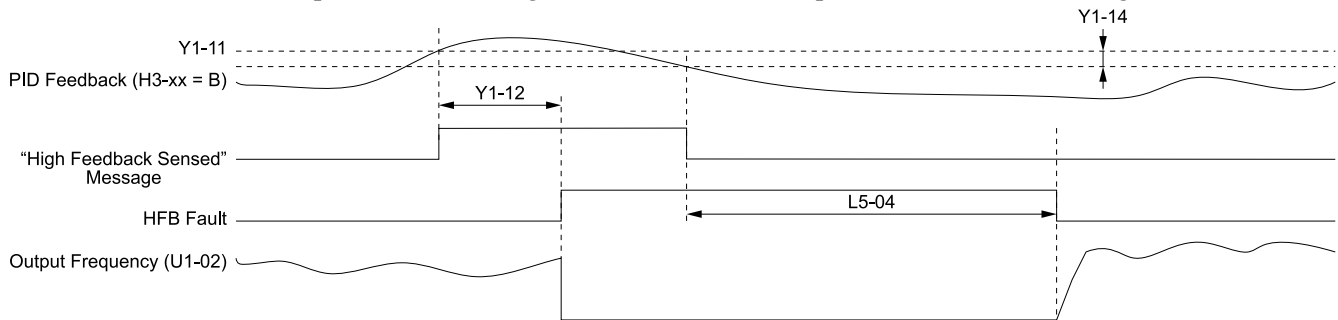

H3-xx = B: PID Feedback

L5-04: Interval Method Restart Time

Y1-11: High Feedback Level

Y1-12: High Feedback Lvl Fault Dly Time

Y1-14: Feedback Hysteresis Level

HFB Fault: High Feedback Sensed

Figure 12.103 Auto Restart for High Feedback Detection when  $b5-09 = 0$  [Normal Output (Direct Acting)]

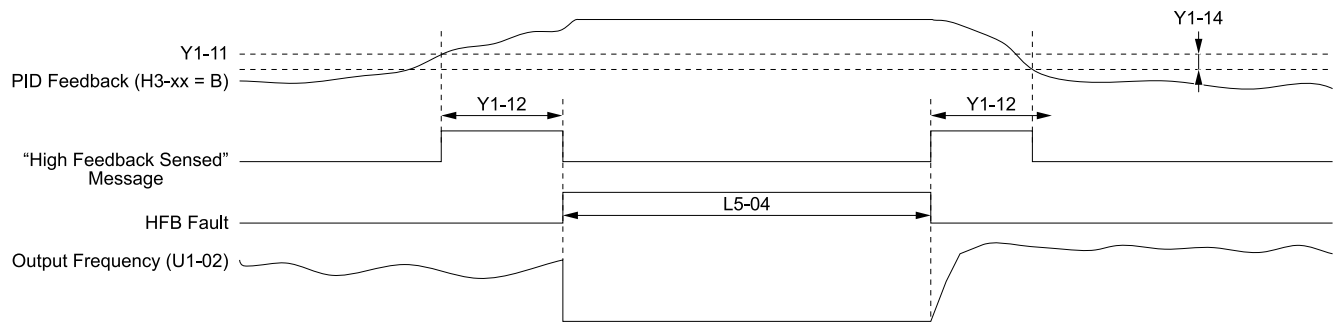

H3-xx = B: PID Feedback

L5-04: Interval Method Restart Time

Y1-11: High Feedback Level

Y1-12: High Feedback Lvl Fault Dly Time

Y1-14: Feedback Hysteresis Level

HFB Fault: High Feedback Sensed

Figure 12.104 Auto Restart for High Feedback Detection when  $b5-09 = 1$

### ■ L5-42: Feedback Loss Fault Retry Select

No. (Hex.)	Name	Description	Default (Range)
L5-42 (3672)	Feedback Loss Fault Retry Select	<b>V/f</b> <b>OLV/PM</b> <b>EZOLV</b> Sets the drive to try an Auto Restart when the drive detects an <i>FDBKL [WIRE Break]</i> fault.	0 (0, 1)

**0 : No Retry**

**1 : Retry**

### ■ L5-49: Fault Retry Speed Search Select

No. (Hex.)	Name	Description	Default (Range)
L5-49 (3679)	Fault Retry Speed Search Select	<b>V/f</b> <b>OLV/PM</b> <b>EZOLV</b> Sets the drive to do a speed search at the start of a Fault Retry.	1 (0, 1)

**0 : Disabled**

**1 : Enabled**

### ■ L5-50: Setpoint Not Met Fault Retry Sel

No. (Hex.)	Name	Description	Default (Range)
L5-50 (367A)	Setpoint Not Met Fault Retry Sel	<b>V/f</b> <b>OLV/PM</b> <b>EZOLV</b> Sets the drive to try an Auto Restart when it detects an <i>NMS [SetPoint Not Met]</i> fault.	0 (0, 1)

**0 : No Retry**

**1 : Retry**

### ■ L5-51: Loss of Prime Fault Retry Select

No. (Hex.)	Name	Description	Default (Range)
L5-51 (367B)	Loss of Prime Fault Retry Select	<b>V/f</b> <b>OLV/PM</b> <b>EZOLV</b> Sets the drive to try an Auto Restart if it detects an <i>LOP [Loss Of Prime]</i> fault.	0 (0, 1)

**0 : No Retry**

**1 : Retry**

### ■ L5-53: Thermostat Fault Retry Selection

No. (Hex.)	Name	Description	Default (Range)
L5-53 (3251)	Thermostat Fault Retry Selection	<b>V/f</b> <b>OLV/PM</b> <b>EZOLV</b> Sets the drive to try an Auto Restart if it detects a <i>VLTS [Thermostat Fault]</i> fault.	0 (0, 1)

**Note:**

- To use this function, set *S5-01*  $\neq$  0 [*HAND Frequency Reference Source*  $\neq$  *HAND Analog Input*]
- The drive will only restart after the Thermostat digital input deactivates and the *L5-04 [Interval Method Restart Time]* timer is expired.

**0 : No Retry**

**1 : Retry**

Figure 12.105 shows the drive operation for *VLTS* when *L5-53* = 1 and *L5-01 [Number of Auto-Restart Attempts]* > 0 times. The drive will wait for the Thermostat digital input to deactivate + the *L5-04* time before it will restart.

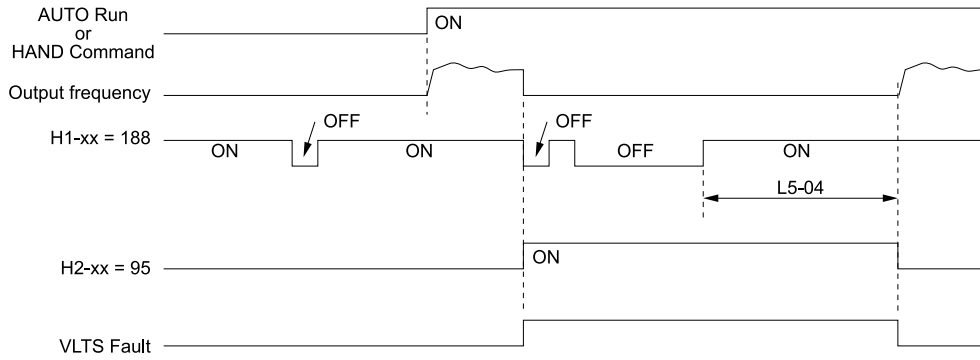

H1-xx = 188: !Thermostat Fault  
 H2-xx = 95: Thermostat Fault

L5-04: Interval Method Restart Time  
 VLTS Fault: Thermostat Fault

Figure 12.105 Thermostat Fault Behavior

### ◆ L6: Torque Detection

The overtorque/undertorque/underload detection function prevents damage to machinery and loads.

Overtorque is when there is too much load on the machine. If the motor current or output torque is at the overtorque detection level for the overtorque detection time, the drive will output an alarm and turn off the output.

Undertorque and underload are when a load suddenly decreases. When the motor current or output torque is at the undertorque/underload detection level for the undertorque detection time, the drive will output an alarm and turn off the output.

You can use the undertorque/underload detection function to detect these conditions, for example:

- Machine belt breaks
- Unusual operation of the electromagnetic contactor on the drive output side
- Clogged output side air filters in fans and blowers

**Note:**

If there is *oC* [Overcurrent] or *oLI* [Motor Overload], the drive can stop during overtorque conditions. Use torque detection to identify overload conditions before the drive detects *oC* or *oLI* and stops. Use this function to detect problems in the application.

### ■ Parameter Setting

You can individually set the two overtorque/undertorque detection functions with the drive. Use the information in [Table 12.61](#) to set the parameters.

Table 12.61 Overtorque/Undertorque Detection Parameters

Configuration Parameter	Overtorque/Undertorque Detection 1	Overtorque/Undertorque Detection 2
MFDO Function Select • Terminals M1-M2 • Terminals M3-M4 • Terminals M5-M6	H2-01, H2-02, and H2-03 = B *1 N.O.: Activated when detected	H2-01, H2-02, and H2-03 = 18 N.O.: Activated when detected
	H2-01, H2-02, and H2-03 = 17 N.C.: Deactivated when detected	H2-01, H2-02, and H2-03 = 19 N.C.: Deactivated when detected
Detection conditions and selection of operation after detection	L6-01	L6-04
Detection Level	L6-02 *2 Analog Input Terminal *3 H3-xx = 7	L6-05 -
Detection Time	L6-03	L6-06

\*1 For *UL6* [Underload or Belt Break Detected] detection, use the MFDO terminal set for H2-xx = 58 [UL6 Underload Detected].

\*2 For *UL6* detection, these parameters set the detection level:

- L6-02
- L6-13 [Motor Underload Curve Select]
- L6-14 [Motor Underload Level @ Min Freq]



- \*3 You can also use an analog input terminal to supply the torque detection level. To enable this function, set  $H3-xx = 7$  [MFAI Function Selection = Torque Detection Level]. When you set  $L6-02$  and  $H3-xx = 7$ , the analog input has priority and  $L6-02$  is disabled.

You cannot use Overtorque/Undertorque Detection 2 to set the detection level for the analog input terminals.

**Note:**

The drive uses these values to set the overtorque/undertorque detection level:

- In V/f, OLV/PM: The current level (100% of the drive rated output current)
- In EZOLV: The motor torque (100% of the motor rated torque)

## Time Chart for Detection of Overtorque/Undertorque/Underload

### Overtorque Detection Time Chart

When you use Overtorque/Undertorque Detection 1, the drive detects overtorque if the motor current or motor torque is at the detection level set in  $L6-02$  [Torque Detection Level 1] for the time set in  $L6-03$  [Torque Detection Time 1]. Parameter  $L6-01$  [Torque Detection Selection 1] sets the operation after detection.

When you use Overtorque/Undertorque Detection 2, set  $L6-04$  [Torque Detection Selection 2],  $L6-05$  [Torque Detection Level 2], and  $L6-06$  [Torque Detection Time 2].

Use  $H2-01$  to  $H2-03$  [MFDO Function Selection] to set the terminal that outputs the alarm.

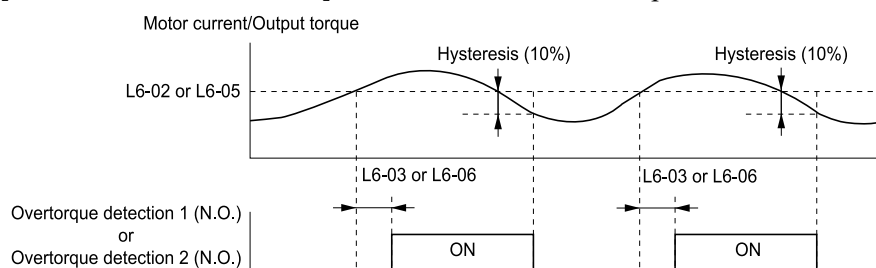

**L6-02: Torque Detection Level 1**

**L6-03: Torque Detection Time 1**

**L6-05: Torque Detection Level 2**

**L6-06: Torque Detection Time 2**

**Figure 12.106 Time Chart for Overtorque Detection**

**Note:**

The drive applies a hysteresis of approximately 10% of the drive rated output current or the motor rated torque to the overtorque/undertorque/underload detection function.

### Undertorque Detection Time Chart

When you use Overtorque/Undertorque Detection 1, the drive detects undertorque if the motor current or motor torque is less than or equal to the detection level set in  $L6-02$  for the time set in  $L6-03$ . Parameter  $L6-01$  sets the operation after detection.

When you use Overtorque/Undertorque Detection 2, set the operation in  $L6-04$ ,  $L6-05$ , and  $L6-06$ .

Use  $H2-01$  to  $H2-03$  [MFDO Function Selection] to set the terminal that outputs the alarm.

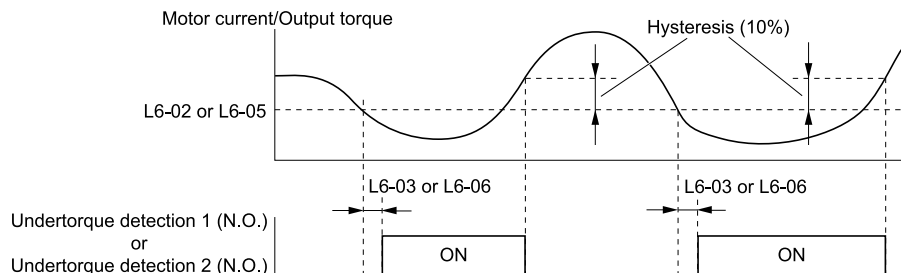

**L6-02: Torque Detection Level 1**

**L6-03: Torque Detection Time 1**

**L6-05: Torque Detection Level 2**

**L6-06: Torque Detection Time 2**

**Figure 12.107 Time Chart for Undertorque Detection**

**Note:**

The drive applies a hysteresis of approximately 10% of the drive rated output current or the motor rated torque to the overtorque/undertorque/underload detection function.

**Underload Detection Time Chart**

When L6-01 = 9 [UL6 @ Speed Agree - Alarm only] to 12 [UL6 @ RUN - Fault], the drive will detect underload if the motor current or output torque is less than or equal to the detection level for the time set in L6-03.

**Note:**

The linear curve of L6-02, L6-13 [Motor Underload Curve Select], and L6-14 [Motor Underload Level @ Min Freq] sets the underload detection level.

Use H2-01 to H2-03 [MFDO Function Selection] to set the terminal that outputs the alarm.

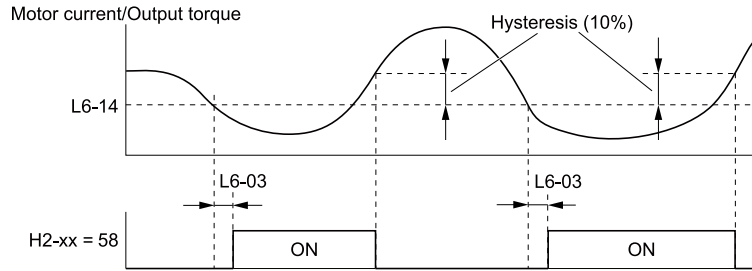

H2-xx = 58: UL6 Underload Detected  
L6-03: Torque Detection Time 1

L6-14: Motor Underload Level @ Min Freq

**Figure 12.108 Time Chart for Underload Detection at Minimum Frequency**

**Note:**

The drive applies a hysteresis of approximately 10% of the drive rated output current or the motor rated torque to the overtorque/undertorque/underload detection function.

**■ L6-01: Torque Detection Selection 1**

No. (Hex.)	Name	Description	Default (Range)
L6-01 (04A1)	Torque Detection Selection 1	<input checked="" type="checkbox"/> V/f <input checked="" type="checkbox"/> OLVP/M <input checked="" type="checkbox"/> EZOLV Sets torque detection conditions that will trigger an overtorque or undertorque response from the drive.	0 (0 - 12)

- The drive detects *oL* [overtorque] if the motor current or output torque is more than the level set in L6-02 [Torque Detection Level 1] for the time set in L6-03 [Torque Detection Time 1].
- The drive detects *UL* [undertorque] if the motor current or output torque is less than the level set in L6-02 for the time set in L6-03.
- The drive detects *UL6* [Underload or Belt Break Detected] if the motor current or output torque is less than the linear curve set in L6-02 and L6-14 [Motor Underload Level @ Min Freq].

**0 : Disabled**

The drive will not detect overtorque or undertorque.

**1 : oL @ Speed Agree - Alarm only**

The drive detects overtorque when the output frequency aligns with the frequency reference. Detection does not occur during acceleration/deceleration. The drive outputs an *oL3* [Overtorque Detection 1] and operation continues.

**2 : oL @ RUN - Alarm only**

When the Run command is enabled, the drive constantly detects overtorque. The drive outputs an *oL3* and operation continues.

**3 : oL @ Speed Agree - Fault**

The drive detects overtorque when the output frequency aligns with the frequency reference. Detection does not occur during acceleration/deceleration. The drive outputs an *oL3* [Overtorque Detection 1] and operation stops.

**4 : oL @ RUN - Fault**

When the Run command is enabled, the drive constantly detects overtorque. The drive outputs an *oL3* and operation stops.

**5 : UL @ Speed Agree - Alarm only**

The drive detects undertorque when the output frequency aligns with the frequency reference. Detection does not occur during acceleration/deceleration. The drive outputs a *UL3* [*Undertorque Detection 1*] and operation continues.

### 6 : UL @ RUN - Alarm only

When the Run command is enabled, the drive constantly detects undertorque. The drive outputs a *UL3* and operation continues.

### 7 : UL @ Speed Agree - Fault

The drive detects undertorque when the output frequency aligns with the frequency reference. Detection does not occur during acceleration/deceleration. The drive outputs a *UL3* and operation stops.

### 8 : UL @ RUN - Fault

When the Run command is enabled, the drive constantly detects undertorque. The drive outputs a *UL3* and operation stops.

### 9 : UL6 @ Speed Agree - Alarm only

The drive detects and shows a *UL6* [*Underload or Belt Break Detected*] alarm during speed agree. The drive will clear the alarm when the output current increases to more than the *UL6* detection level plus 10% of the drive rated current.

### 10 : UL6 @ RUN - Alarm only

The drive detects and shows a *UL6* alarm while the drive is in the operation. The drive will clear the alarm when the output current increases to more than the *UL6* detection level plus 10% of the drive rated current.

### 11 : UL6 @ Speed Agree - Fault

The drive detects and shows a *UL6* fault during speed agree.

### 12 : UL6 @ RUN - Fault

The drive detects and shows a *UL6* fault while the drive is in the operation.

## ■ L6-02: Torque Detection Level 1

No. (Hex.)	Name	Description	Default (Range)
L6-02 (04A2)	Torque Detection Level 1	<b>V/f</b> <b>OLV/PM</b> <b>EZOLV</b> Sets the detection level for Overtorque/Undertorque Detection 1. In V/f control, drive rated output current = 100% value. In vector control, motor rated torque = 100% value.	15% (0 - 300%)

#### Note:

You can also use an analog input terminal to supply the torque detection level. To enable this function, set *H3-xx* = 7 [*MFAI Function Selection = Torque Detection Level*]. If you set *L6-02* and *H3-x* = 7, the analog input is most important and the drive disables *L6-02*.

## ■ L6-03: Torque Detection Time 1

No. (Hex.)	Name	Description	Default (Range)
L6-03 (04A3)	Torque Detection Time 1	<b>V/f</b> <b>OLV/PM</b> <b>EZOLV</b> Sets the detection time for Overtorque/Undertorque Detection 1.	10.0 s (0.0 - 10.0 s)

## ■ L6-04: Torque Detection Selection 2

No. (Hex.)	Name	Description	Default (Range)
L6-04 (04A4)	Torque Detection Selection 2	<b>V/f</b> <b>OLV/PM</b> <b>EZOLV</b> Sets the speed range that detects overtorque and undertorque and the operation of drives (operation status) after detection.	0 (0 - 8)

The drive detects overtorque if the motor current or output torque is more than the level set in *L6-05* [*Torque Detection Level 2*] for the length of time set in *L6-06* [*Torque Detection Time 2*]. The drive detects undertorque if the motor current or output torque is less than the level set in *L6-05* for the length the time set in *L6-06*.

### 0 : Disabled

The drive will not detect overtorque or undertorque.

### 1 : oL @ Speed Agree - Alarm only

The drive detects overtorque when the output frequency aligns with the frequency reference. Detection does not occur during acceleration/deceleration. The drive outputs an *oL4* [*Overtorque Detection 2*] and operation continues.

**2 : oL @ RUN - Alarm only**

When the Run command is enabled, the drive constantly detects overtorque. The drive outputs an *oL4* and operation continues.

**3 : oL @ Speed Agree - Fault**

The drive detects overtorque when the output frequency aligns with the frequency reference. Detection does not occur during acceleration/deceleration. The drive outputs an *oL4* [*Overtorque Detection 2*] and operation stops.

**4 : oL @ RUN - Fault**

When the Run command is enabled, the drive constantly detects overtorque. The drive outputs an *oL4* and operation stops.

**5 : UL @ Speed Agree - Alarm only**

The drive detects undertorque when the output frequency aligns with the frequency reference. Detection does not occur during acceleration/deceleration. The drive outputs a *UL4* [*Undertorque Detection 2*] and operation continues.

**6 : UL @ RUN - Alarm only**

When the Run command is enabled, the drive constantly detects undertorque. The drive outputs a *UL4* and operation continues.

**7 : UL @ Speed Agree - Fault**

The drive detects undertorque when the output frequency aligns with the frequency reference. Detection does not occur during acceleration/deceleration. The drive outputs a *UL4* and operation stops.

**8 : UL @ RUN - Fault**

When the Run command is enabled, the drive constantly detects undertorque. The drive outputs a *UL4* and operation stops.

**■ L6-05: Torque Detection Level 2**

No. (Hex.)	Name	Description	Default (Range)
L6-05 (04A5)	Torque Detection Level 2	<div style="display: flex; gap: 5px;"> <span>V/f</span> <span>OLV/IPM</span> <span>EZOLV</span> </div> Sets the detection level for Overtorque/Undertorque Detection 2. In V/f control, drive rated output current = 100% value. In vector control, motor rated torque = 100% value.	150% (0 - 300%)

**Note:**

Overtorque/Undertorque Detection 2 cannot set the detection level for the analog input terminal.

**■ L6-06: Torque Detection Time 2**

No. (Hex.)	Name	Description	Default (Range)
L6-06 (04A6)	Torque Detection Time 2	<div style="display: flex; gap: 5px;"> <span>V/f</span> <span>OLV/IPM</span> <span>EZOLV</span> </div> Sets the detection time for Overtorque/Undertorque Detection 2.	0.1 s (0.0 - 10.0 s)

**■ L6-13: Motor Underload Curve Select**

No. (Hex.)	Name	Description	Default (Range)
L6-13 (062E)	Motor Underload Curve Select	<div style="display: flex; gap: 5px;"> <span>V/f</span> <span>OLV/IPM</span> <span>EZOLV</span> </div> Sets the motor underload protection ( <i>UL6</i> [ <i>Undertorque Detection 6</i> ]) based on motor load and sets the level of <i>L6-02</i> [ <i>Torque Detection Level 1</i> ] to refer to Fbase or Fmax.	0 (0, 1)

**0 : Base Frequency Enable**

**1 : Max Frequency Enable**

If the output current is less than the curve for longer than the time set in *L6-03* [*Torque Detection Time 1*], the drive will detect a fault or an alarm as specified by *L6-01* [*Torque Detection Selection 1*].

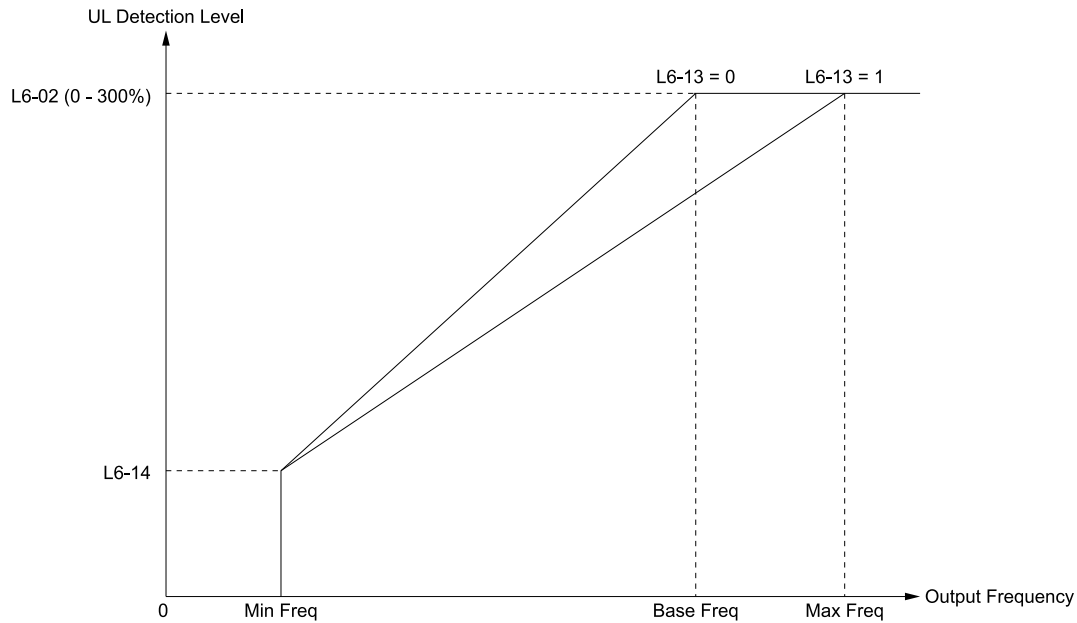

**L6-02: Torque Detection Level 1**  
**L6-13 = 0: Base Frequency Enable**

**L6-13 = 1: Max Frequency Enable**  
**L6-14: Motor Underload Level @ Min Freq**

Figure 12.109 UL6 Detection Curve

### ■ L6-14: Motor Underload Level @ Min Freq

No. (Hex.)	Name	Description	Default (Range)
L6-14 (062F)	Motor Underload Level @ Min Freq	<input type="checkbox"/> V/f <input type="checkbox"/> OLV/PM <input type="checkbox"/> EZOLV Sets the <i>UL6 [Undertorque Detection 6]</i> detection level at minimum frequency by percentage of drive rated current.	15% (0 - 300%)

### ◆ L7: Torque Limit

The torque limit function limits the internal torque reference for the drive to limit the quantity of torque generated by the motor to a constant quantity. This function keeps the torque applied to loads and regenerative torque less than a set quantity. This function also prevents damage to machinery and increases the reliability of continuous operation. You can set torque limits individually for the four quadrants, which include torque direction (motoring/regeneration) and direction of motor rotation (forward/reverse). When the torque reference value is at the set torque limit, the MFDO terminal set for *During Torque Limit [H2-xx = 30]* activates.

**Note:**

- The drive output current limits maximum output torque. The drive limits torque to 110% of the rated output current. The actual output torque is not more than the limits of the drive rated output current when you set the torque limit to a high value.
- When you use torque limits for lifting applications, do not lower the torque limit value too much. When the torque limit function is triggered, falls and rollbacks can occur because of sudden acceleration stops and stalls of the motor.

### ■ Configuring Settings

Use one of these methods to set torque limits:

- Use *L7-01 to L7-04 [Torque Limit]* to set the four torque limit quadrants individually.
- Use MFAI to set the four torque limit quadrants individually. Set *H3-02, H3-10 = 10, 11, 12 [MFAI Function Select = Forward/Reverse/Regenerative Torque Limit]*.
- Use MFAI to set all four torque limit quadrants together. Set *H3-02, H3-10 = 15 [General Torque Limit]*.
- Use a communication option to set all four torque limit quadrants together.

Figure 12.110 shows the configuration method for each quadrant.

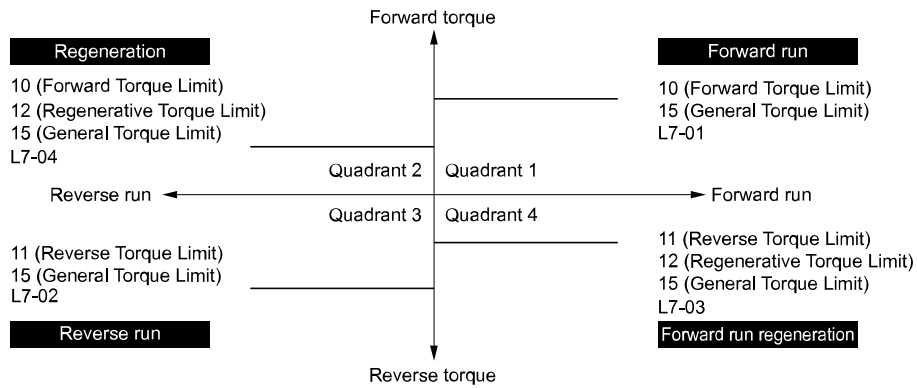

Figure 12.110 Torque Limits and Analog Input Setting Parameters

**Note:**

- When L7-01 to L7-04 and analog inputs or communication option torque limits set torque limits for the same quadrant, the drive enables the lowest value. In this example of parameter settings, the torque limit for quadrant 1 is 130% and the torque limit for quadrants 2, 3, and 4 is 150%. Settings: L7-01 = 130%, L7-02 to L7-04 = 200%, and MFAI torque limit = 150%
- The drive output current limits maximum output torque. The torque limit is to 120% of the rated output current. The actual output torque is not more than the limits of the drive rated output current when you set the torque limit to a high value.

■ **L7-01: Forward Torque Limit**

No. (Hex.)	Name	Description	Default (Range)
L7-01 (04A7) RUN	Forward Torque Limit	<input type="checkbox"/> V/f <input type="checkbox"/> OLV/IPM <input checked="" type="checkbox"/> EZOLV Sets the torque limit value for forward motoring as a percentage, where motor rated torque is the 100% value.	200% (0 - 300%)

**Note:**

- When you use this method to set the torque limit, it enables the lowest torque limit:  
–Set H3-02 or H3-10 = 10, 15 [MFAI Function Selection = Forward Torque Limit, General Torque Limit].  
–Use a communication option to set the torque limits
- You must think about drive capacity when a large quantity of torque is necessary. If you set the value too high, the drive can detect oC [Overcurrent].
- If you set the value too low with large loads, the motor can stall.

■ **L7-02: Reverse Torque Limit**

No. (Hex.)	Name	Description	Default (Range)
L7-02 (04A8) RUN	Reverse Torque Limit	<input type="checkbox"/> V/f <input type="checkbox"/> OLV/IPM <input checked="" type="checkbox"/> EZOLV Sets the torque limit value for reversed motoring as a percentage, where motor rated torque is the 100% value.	200% (0 - 300%)

**Note:**

- When you use this method to set the torque limit, it enables the lowest torque limit:  
–Set H3-02 or H3-10 = 10, 15 [MFAI Function Selection = Forward Torque Limit, General Torque Limit].  
–Use a communication option to set the torque limits
- You must think about drive capacity when a large quantity of torque is necessary. If you set the value too high, the drive can detect oC [Overcurrent].
- If you set the value too low with large loads, the motor can stall.

■ **L7-03: Forward Regenerative Trq Limit**

No. (Hex.)	Name	Description	Default (Range)
L7-03 (04A9) RUN	Forward Regenerative Trq Limit	<input type="checkbox"/> V/f <input type="checkbox"/> OLV/IPM <input checked="" type="checkbox"/> EZOLV Sets the torque limit value for forward regenerative conditions as a percentage of the motor rated torque.	200% (0 - 300%)

**Note:**

- When you use this method to set the torque limit, it enables the lowest torque limit:
  - Set *H3-02* or *H3-10* = 10, 15 [*MFAI Function Selection* = Forward Torque Limit, General Torque Limit].
  - Use a communication option to set the torque limits
- You must think about drive capacity when a large quantity of torque is necessary. If you set the value too high, the drive can detect *oC* [*Overcurrent*].
- If you set the value too low with large loads, the motor can stall.

### ■ L7-04: Reverse Regenerative Trq Limit

No. (Hex.)	Name	Description	Default (Range)
L7-04 (04AA) RUN	Reverse Regenerative Trq Limit	<input type="checkbox"/> V/f <input type="checkbox"/> OLV/PM <input checked="" type="checkbox"/> EZOLV Sets the torque limit value for reversed regenerative conditions as a percentage of the motor rated torque.	200% (0 - 300%)

**Note:**

- When you use this method to set the torque limit, it enables the lowest torque limit:
  - Set *H3-02* or *H3-10* = 10, 15 [*MFAI Function Selection* = Forward Torque Limit, General Torque Limit].
  - Use a communication option to set the torque limits
- You must think about drive capacity when a large quantity of torque is necessary. If you set the value too high, the drive can detect *oC* [*Overcurrent*].
- If you set the value too low with large loads, the motor can stall.

### ■ L7-16: Torque Limit Process at Start

No. (Hex.)	Name	Description	Default (Range)
L7-16 (044D)	Torque Limit Process at Start	<input type="checkbox"/> V/f <input type="checkbox"/> OLV/PM <input checked="" type="checkbox"/> EZOLV Assigns a time filter to allow the torque limit to build at start.	1 (0, 1)

**0 : Disabled**

There is torque limit at start without a delay time.

Use this setting to maximize the response time when sudden acceleration or deceleration at start is necessary.

**1 : Enabled**

There is a delay time of 64 ms at start to build the torque limit.

## ◆ L8: Drive Protection

*L8 parameters* set protective functions that prevent faults such as overheating, phase loss, and ground faults.

### ■ L8-02: Overheat Alarm Level

No. (Hex.)	Name	Description	Default (Range)
L8-02 (04AE)	Overheat Alarm Level	<input type="checkbox"/> V/f <input type="checkbox"/> OLV/PM <input checked="" type="checkbox"/> EZOLV Sets the <i>oH</i> detection level temperature.	Determined by <i>o2-04</i> (50 - 150 °C)

If the heatsink temperature is more than the temperature set in this parameter, the drive detects an overheat pre-alarm. To enable this function, set one of *H2-01* to *H2-03* [*MFDO Function Select*] to 20 [*Drive Overheat Pre-Alarm (oH)*].

If the temperature increases to the overheat fault level, the drive will trigger an *oH1* [*Heatsink Overheat*] fault and stop operation.

### ■ L8-03: Overheat Pre-Alarm Selection

No. (Hex.)	Name	Description	Default (Range)
L8-03 (04AF)	Overheat Pre-Alarm Selection	<input type="checkbox"/> V/f <input type="checkbox"/> OLV/PM <input checked="" type="checkbox"/> EZOLV Sets drive operation if it detects an <i>oH</i> alarm.	4 (0 - 4)

**0 : Ramp to Stop**

The drive ramps the motor to stop in the deceleration time. Fault relay output terminal MA-MC activates and MB-MC deactivates.

**1 : Coast to Stop**

The output turns off and the motor coasts to stop. Fault relay output terminal MA-MC turns activates and MB-MC deactivates.

**2 : Fast Stop (Use C1-09)**

The drive stops the motor in the deceleration time set in C1-09 [Fast Stop Time]. Fault relay output terminal MA-MC activates and MB-MC deactivates.

**3 : Alarm Only**

The keypad shows oH and the drive continues operation. The output terminal set for Alarm [H2-01 to H2-03 = 10] activates.

**4 : Operate at Reduced Speed (L8-19)**

The drive decelerates to the level set in L8-19 [Freq Reduction @ oH Pre-Alarm] and continues operation. oH flashes on the keypad.

oH flashes on the keypad. When the alarm is output, the drive decelerates each 10 seconds. If the drive decelerates 10 times and the alarm continues to be output, the output terminal set for oH Pre-Alarm Reduction Limit [H2-01 to H2-03 = 4D] activates. When the alarm is not output during deceleration, the drive accelerates until it is at the frequency reference that was applicable before the alarm was turned off. Figure 12.111 shows the output of the alarm and the drive operation at a decreased output frequency.

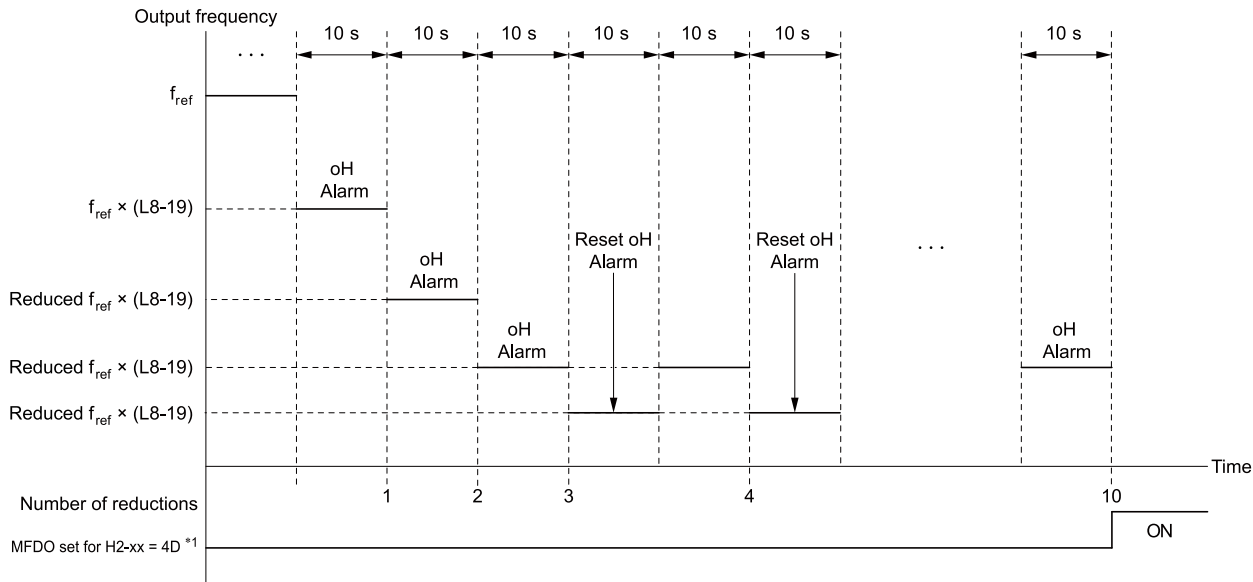

H2-xx = 4D: oH Pre-Alarm Reduction Limit  
L8-19: Freq Reduction @ oH Pre-Alarm

oH Alarm: Heatsink Overheat

**Figure 12.111 Drive Operation at a Decreased Output Frequency when the Overheat Alarm is Output**

\*1 If the oH alarm continues after 10 reduction cycles, the terminal set for H2-xx = 4D [oH Pre-Alarm Reduction Limit] will activate.

**Note:**

- The drive will use the largest value of Y1-06 [Minimum Speed], Y4-12 [Thrust Frequency], or d2-02 [Frequency Reference Lower Limit] as the lower limit for output frequency.
- Parameter L8-97 [Carrier Freq Reduce during OH] enables and disables the carrier frequency reduction during oH pre-alarm.

**■ L8-05: Input Phase Loss Protection Sel**

No. (Hex.)	Name	Description	Default (Range)
L8-05 (04B1)	Input Phase Loss Protection Sel	<input type="checkbox"/> V/f <input type="checkbox"/> OLVP/M <input type="checkbox"/> EZOLV Sets the function to enable and disable input phase loss detection.	1 (0, 1)

**0 : Disabled**



**1 : Enabled**

The drive measures ripples in DC bus voltage to detect input phase loss.

The drive detects phase loss when power supply phase loss occurs or the main circuit capacitor becomes unusable, which causes *PF [Input Phase Loss]* to show on the keypad.

Disable the detection of the input power supply phase loss function in these conditions:

- During deceleration
- The run command is not input
- The output current is less than 30% of the drive rated current.

**■ L8-07: Output Phase Loss Protection Sel**

No. (Hex.)	Name	Description	Default (Range)
L8-07 (04B3)	Output Phase Loss Protection Sel	<input type="checkbox"/> V/f <input type="checkbox"/> OLV/PM <input type="checkbox"/> EZOLV Sets the function to enable and disable output phase loss detection. The drive starts output phase loss detection when the output current decreases to less than 5% of the drive rated current.	1 (0 - 2)

**Note:**

The drive can incorrectly start output phase loss detection in these conditions:

- The motor rated current is very small compared to the drive rating.
- The drive is operating a PM motor with a small load.

**0 : Disabled****1 : Fault when one phase is lost**

If the drive loses one output phase, it will trigger *LF [Output Phase Loss]*.

The output turns off and the motor coasts to stop.

**2 : Fault when two phases are lost**

If the drive loses more than one output phase, it will trigger *LF [Output Phase Loss]*.

The output turns off and the motor coasts to stop.

**■ L8-09: Output Ground Fault Detection**

No. (Hex.)	Name	Description	Default (Range)
L8-09 (04B5)	Output Ground Fault Detection	<input type="checkbox"/> V/f <input type="checkbox"/> OLV/PM <input type="checkbox"/> EZOLV Sets the function to enable and disable ground fault protection.	Determined by o2-04 (0, 1)

**0 : Disabled**

The drive will not detect ground faults.

**1 : Enabled**

If there is high leakage current or a ground short circuit in one or two output phases, the drive will detect *GF [Ground Fault]*.

**Note:**

If the ground path impedance is low, the drive can detect *oC [Overcurrent]*, *SC [Short Circuit/IGBT Failure]*, or *ov [Overvoltage]* instead of *GF*.

**■ L8-10: Heatsink Fan Operation Selection**

No. (Hex.)	Name	Description	Default (Range)
L8-10 (04B6)	Heatsink Fan Operation Selection	<input type="checkbox"/> V/f <input type="checkbox"/> OLV/PM <input type="checkbox"/> EZOLV Sets operation of the heatsink cooling fan.	0 (0 - 2)

**0 : During Run, w/ L8-11 Off-Delay**

The drive turns on the fan when a Run command is active.

When you release the Run command and the delay time set in *L8-11 [Heatsink Fan Off-Delay Time]* is expired, the fan stops. This setting extends the fan lifetime.

**1 : Always On**

The fan turns on when you supply power to the drive.

**2 : Temperature-Dependent Fan Ctrl.**

The fan turns on when the drive detects that the main circuit is overheating.

**■ L8-11: Heatsink Fan Off-Delay Time**

No. (Hex.)	Name	Description	Default (Range)
L8-11 (04B7)	Heatsink Fan Off-Delay Time	<div style="display: flex; gap: 5px;"> <span>V/f</span> <span>OLV/IPM</span> <span>EZOLV</span> </div> Sets the length of time that the drive will wait before it stops the cooling fan after it cancels the Run command when $L8-10 = 0$ [Heatsink Fan Operation Selection = During Run, w/ L8-11 Off-Delay].	300 s (0 - 300 s)

**■ L8-12: Ambient Temperature Setting**

No. (Hex.)	Name	Description	Default (Range)
L8-12 (04B8)	Ambient Temperature Setting	<div style="display: flex; gap: 5px;"> <span>V/f</span> <span>OLV/IPM</span> <span>EZOLV</span> </div> Sets the ambient temperature of the drive installation area.	40 °C (Determined by L8-35)

The drive automatically adjusts the drive rated current to the best value as specified by the set temperature. Set the ambient temperature of the area where you install the drive to a value that is more than the drive rating.

Refer to [Derating Depending on Ambient Temperature on page 430](#) for information about derating depending on ambient temperature.

**■ L8-15: Drive oL2 @ Low Speed Protection**

No. (Hex.)	Name	Description	Default (Range)
L8-15 (04BB)	Drive oL2 @ Low Speed Protection	<div style="display: flex; gap: 5px;"> <span>V/f</span> <span>OLV/IPM</span> <span>EZOLV</span> </div> Sets the function to decrease the drive overload level at which the drive will trigger oL2 [Drive Overload] during low speed operation (6 Hz or slower) to prevent damage to the main circuit transistors.	1 (0, 1)

**Note:**

Contact Yaskawa or your nearest sales representative before disabling this function at low speeds. If you frequently operate drives with high output current in low speed ranges, it can cause heat stress and decrease the life span of drive IGBTs.

**0 : Disabled (No Additional Derate)**

The drive does not decrease the overload protection level.

**1 : Enabled (Reduced oL2 Level)**

When the drive detects oL2 during low speed operation, it automatically decreases the overload detection level.

At zero speed, the drive derates the overload by 50%.

**■ L8-18: Software Current Limit Selection**

No. (Hex.)	Name	Description	Default (Range)
L8-18 (04BE)	Software Current Limit Selection	<div style="display: flex; gap: 5px;"> <span>V/f</span> <span>OLV/IPM</span> <span>EZOLV</span> </div> Set the software current limit selection function to prevent damage to the main circuit transistor caused by too much current.	0 (0, 1)

**0 : Disabled**

When the output current is at the software current limit value, the drive does not restrict the output voltage.

**Note:**

The drive may detect an oC [Overcurrent] when loads are particularly heavy or the acceleration time is particularly short.

**1 : Enabled**

When the output current is at the software current limit value, the drive decreases output voltage to decrease output current.

When the output current decreases to the software current limit level, the drive starts usual operation.

### ■ L8-19: Freq Reduction @ oH Pre-Alarm

No. (Hex.)	Name	Description	Default (Range)
L8-19 (04BF)	Freq Reduction @ oH Pre-Alarm	<input type="checkbox"/> V/f <input type="checkbox"/> OLV/PM <input type="checkbox"/> EZOLV Sets the ratio at which the drive derates the frequency reference during an oH alarm.	20.0% (10.0 - 100.0%)

When  $L8-03 = 4$  [Overheat Pre-Alarm Selection = Operate at Reduced Speed (L8-19)] and an oH alarm is output, this function is enabled.

### ■ L8-27: Overcurrent Detection Gain

No. (Hex.)	Name	Description	Default (Range)
L8-27 (04DD)	Overcurrent Detection Gain	<input type="checkbox"/> V/f <input type="checkbox"/> OLV/PM <input type="checkbox"/> EZOLV Sets the PM motor overcurrent detection level as a percentage of the motor rated current value.	300.0% (0.0 - 1000.0%)

**Note:**

- The overcurrent detection function detects the lower of these two values:
  - Drive overcurrent level
  - Motor rated current  $\times L8-27 / 100$
- Set  $L7-xx$  [Torque Limit] parameters  $< L8-27$ .
- When you set  $L8-27 = 0.0$ , it disables this function. In usual conditions, do not set  $L8-27 = 0.0$ . If the drive rated current is much higher than the motor rated current, PM motor magnets can demagnetize if current flows at the drive overcurrent detection level.

### ■ L8-29: Output Unbalance Detection Sel

No. (Hex.)	Name	Description	Default (Range)
L8-29 (04DF)	Output Unbalance Detection Sel	<input type="checkbox"/> V/f <input type="checkbox"/> OLV/PM <input type="checkbox"/> EZOLV Sets the function to detect $LF2$ [Output Current Imbalance].	1 (0, 1)

This function prevents damage to PM motors. Current unbalance can heat a PM motor and demagnetize the magnets. When the current is unbalanced, the drive will detect  $LF2$  to stop the motor and prevent damage to the motor.

**0 : Disabled**

**1 : Enabled**

**Note:**

You must set  $E9-01 = 1$  [Motor Type Selection = Permanent Magnet (PM)] and  $A1-02 = 8$  [EZOLV] to show  $L8-29$ .

### ■ L8-31: LF2 Detection Time

No. (Hex.)	Name	Description	Default (Range)
L8-31 (04E1)	LF2 Detection Time	<input type="checkbox"/> V/f <input type="checkbox"/> OLV/PM <input type="checkbox"/> EZOLV Sets the $LF2$ [Output Current Imbalance] detection time.	3 (1 - 100)

When the output current is unbalanced for longer than the time set in  $L8-31$ , the drive detects  $LF2$ .

**Note:**

- Set  $L8-29 = 1$  [Output Unbalance Detection Sel = Enabled] to enable  $L8-31$ .
- If the drive incorrectly detects  $LF2$ , increase  $L8-31$  in 5-unit increments.
- The keypad shows  $L8-31$  when  $E9-01 = 1$  [Motor Type Selection = Permanent Magnet (PM)] in EZ Vector Control.

### ■ L8-35: Installation Method Selection

No. (Hex.)	Name	Description	Default (Range)
L8-35 (04EC)	Installation Method Selection	<input type="checkbox"/> V/f <input type="checkbox"/> OLV/PM <input type="checkbox"/> EZOLV Sets the type of drive installation.	Determined by the drive (0 - 3)

**Note:**

- Parameter *A1-03 [Initialize Parameters]* does not initialize this parameter.
- This parameter is set to the correct value when the drive is shipped. Change the value only in these conditions:
  - When you do a Side-by-Side installation
  - When you install a UL Type 1 kit on an IP20/UL Open Type drive to convert the drive to an IP20/UL Type 1
  - When you convert an IP20/UL Type 1 drive to IP20/UL Open Type
  - When you install models 2011 to 2169 and 4005 to 4156 with the heatsink external to the enclosure
- The drive will detect an *oPE02 [Parameter Range Setting Error]* in these conditions:
  - If you set *L8-12 = 60 °C* and *L8-35 = 1 or 3* on models 2011 to 2114 and 4005 to 4124
  - If you set *L8-35 = 1 or 3* on models 2143 to 2273 and 4156 to 4302

The drive automatically adjusts the overload protection detection level to the best value as specified by the setting value. Refer to *Derating Depending on Ambient Temperature on page 430* for information on derating depending on ambient temperature.

**0 : IP20/UL Open Type**

Use this setting to install an IP20/UL Open Type drive.

Make sure that there is 60 mm (2.4 in) minimum of space between drives or between the drive and side of the enclosure panel.

**1 : Side-by-Side Mounting**

Use this setting to install more than one drive Side-by-Side.

Make sure that there is 2 mm (0.08 in) minimum of space between drives.

**2 : IP20/UL Type 1**

Use this setting to install an IP20/UL Type 1 drive.

**3 : IP55/UL Type 12**

Use this setting to install an IP55/UL Type 12 drive.

**■ L8-38: Carrier Frequency Reduction**

No. (Hex.)	Name	Description	Default (Range)
L8-38 (04EF)	Carrier Frequency Reduction	<div style="display: flex; gap: 5px;"> <span style="background-color: black; color: white; padding: 2px;">V/f</span> <span style="border: 1px solid gray; padding: 2px;">OLV/PM</span> <span style="border: 1px solid gray; padding: 2px;">EZOLV</span> </div> <p>Sets the carrier frequency reduction function. The drive decreases the carrier frequency when the output current is more than a specified level.</p>	Determined by o2-04 (1 - 3)

If you decrease the carrier frequency, it increases the overload tolerance. The overload capacity increases temporarily for *oL2 [Drive Overload]* and lets the drive operate through transient load peaks and not trip.

**1 : Enabled below 6 Hz**

The drive decreases the carrier frequency at speeds less than 6 Hz when the current is more than 100% of the drive rated current.

When the current is less than 88% or the output frequency is more than 7 Hz, the drive goes back to the usual carrier frequency.

**2 : Enabled for All Speeds**

The drive decreases the carrier frequency at these speeds:

- Output current is a minimum of 100% of the drive rated current and the frequency reference is less than 6 Hz.
- Output current is a minimum of 109% of the drive rated current and the frequency reference is 7 Hz or more.

When the drive switches the carrier frequency to the set value, it uses a hysteresis of 12%.

**3 : Enable at Overload**

The drive decreases the carrier frequency at one of these conditions:

- Output frequency is less than 6 Hz and output current is more than 120%
- Output frequency is 7 Hz or more and the IGBT temperature detected by thermistor is high

### ■ L8-41: High Current Alarm Selection

No. (Hex.)	Name	Description	Default (Range)
L8-41 (04F2)	High Current Alarm Selection	<div style="display: flex; justify-content: space-between; align-items: center;"> <span>V/f</span> <span>OLV/PM</span> <span>EZOLV</span> </div> Sets the function to cause an <i>HCA</i> [High Current Alarm] when the output current is more than 150% of the drive rated current.	0 (0, 1)

#### 0 : Disabled

The drive will not detect an *HCA*.

#### 1 : Enabled

If the output current is more than 150% of the drive rated current, the drive will detect an *HCA*.

The MFDO terminal set for an alarm [H2-01 to H2-03 = 10] activates.

### ■ L8-90: STPo Detection Level (Low Speed)

No. (Hex.)	Name	Description	Default (Range)
L8-90 (0175) Expert	STPo Detection Level (Low Speed)	<div style="display: flex; justify-content: space-between; align-items: center;"> <span>V/f</span> <span>OLV/PM</span> <span>EZOLV</span> </div> Sets the detection level that the control fault must be equal to or more than to cause an <i>STPo</i> [Motor Step-Out Detected].	0 times (0 - 5000 times)

This function detects when PM motors are not synchronized.

The drive cannot detect when motors are not synchronized because the frequency reference is low during start up and the motor is locked. If fault detection is necessary in these conditions, set the control fault detection level to enable detection of desynchronization because of motor locking. Increase the setting in 5-unit increments.

### ■ L8-97: Carrier Freq Reduce during OH

No. (Hex.)	Name	Description	Default (Range)
L8-97 (3104)	Carrier Freq Reduce during OH	<div style="display: flex; justify-content: space-between; align-items: center;"> <span>V/f</span> <span>OLV/PM</span> <span>EZOLV</span> </div> Sets the function to decrease carrier frequency during oH pre-alarm.	0 (0, 1)

#### Note:

When  $A1-02 = 8$  [Control Method Selection = EZOLV], this parameter is available only when  $E9-01 = 0$  [Motor Type Selection = Induction (IM)].

#### 0 : Disabled

#### 1 : Enabled

## ◆ L9: Drive Protection 2

*L9* parameters are used to configure the protection function used to detect cooling fan faults.

### ■ L9-16: FAn1 Detect Time

No. (Hex.)	Name	Description	Default (Range)
L9-16 (11DC) Expert	FAn1 Detect Time	<div style="display: flex; justify-content: space-between; align-items: center;"> <span>V/f</span> <span>OLV/PM</span> <span>EZOLV</span> </div> Sets the detection time for <i>FAn1</i> [Drive Cooling Fan Fault]. Yaskawa recommends that you do not change this parameter value.	4.0 s (0.0 - 30.0 s)

## 12.10 n: Special Adjustment

*n* parameters set these functions:

- Function to prevent hunting
- High-slip braking
- Fine-tune the parameters that adjust motor control

### ◆ n1: Hunting Prevention

The Hunting Prevention function will not let low inertia or operation with a light load cause hunting. Hunting frequently occurs when you have a high carrier frequency and an output frequency less than 30 Hz.

#### ■ n1-01: Hunting Prevention Selection

No. (Hex.)	Name	Description	Default (Range)
n1-01 (0580)	Hunting Prevention Selection	<input type="radio"/> V/f <input type="radio"/> OLV/PM <input type="radio"/> EZOLV Sets the function to prevent hunting.	1 (0, 1)

When drive response is more important than the decrease of motor vibration, disable this function.

If hunting occurs, or if you use a high carrier frequency or Swing PWM, set this parameter to 2 for better hunting prevention.

**0 : Disabled**

**1 : Enabled (Normal)**

#### ■ n1-02: Hunting Prevention Gain Setting

No. (Hex.)	Name	Description	Default (Range)
n1-02 (0581) Expert	Hunting Prevention Gain Setting	<input type="radio"/> V/f <input type="radio"/> OLV/PM <input type="radio"/> EZOLV Sets the performance of the hunting prevention function. Usually it is not necessary to change this parameter.	1.00 (0.00 - 2.50)

Adjust this parameter in these conditions:

- When  $n1-01 = 1, 2$  [*Hunting Prevention Selection = Enabled (Normal), Enabled (High Carrier Frequency)*]: If oscillation occurs when you operate a motor with a light load, increase the setting value in 0.1-unit increments.
- When  $n1-01 = 1, 2$ , if the motor stalls: Decrease the setting value in 0.1-unit increments.

#### ■ n1-03: Hunting Prevention Time Constant

No. (Hex.)	Name	Description	Default (Range)
n1-03 (0582) Expert	Hunting Prevention Time Constant	<input type="radio"/> V/f <input type="radio"/> OLV/PM <input type="radio"/> EZOLV Sets the primary delay time constant of the hunting prevention function. Usually it is not necessary to change this parameter.	Determined by o2-04 (0 - 500 ms)

Adjust this parameter in these conditions:

- Load inertia is large: Increase the setting value. If the setting value is too high, response will be slower. Also, there will be oscillation when the frequency is low.
- Oscillation occurs at low frequencies: Decrease the setting value.

#### ■ n1-05: Hunting Prevent Gain in Reverse

No. (Hex.)	Name	Description	Default (Range)
n1-05 (0530) Expert	Hunting Prevent Gain in Reverse	<input type="radio"/> V/f <input type="radio"/> OLV/PM <input type="radio"/> EZOLV Sets the performance of the hunting prevention function. This parameter adjusts Reverse run. Usually it is not necessary to change this parameter.	0.00 (0.00 - 2.50)

**Note:**

When you set this parameter to 0, the value set in *n1-02* [Hunting Prevention Gain Setting] is effective when the motor rotates in reverse.

Adjust this parameter in these conditions:

- When *n1-01* = 1, 2 [Hunting Prevention Selection = Enabled (Normal), Enabled (High Carrier Frequency)]: If oscillation occurs when you operate a motor with a light load, increase the setting value in 0.1-unit increments.
- When *n1-01* = 1, 2, if the motor stalls: Decrease the setting value in 0.1-unit increments.

### ■ n1-13: DC Bus Stabilization Control

No. (Hex.)	Name	Description	Default (Range)
n1-13 (1B59) Expert	DC Bus Stabilization Control	<input type="radio"/> V/f <input type="radio"/> OLV/PM <input type="radio"/> EZOLV Sets the oscillation suppression function for the DC bus voltage.	0 (0, 1)

**0 : Disabled**

**1 : Enabled**

**Note:**

If the DC bus voltage does not become stable with light loads and the drive detects *ov* [Overvoltage], set this parameter to 1.

### ■ n1-14: DC Bus Stabilization Time

No. (Hex.)	Name	Description	Default (Range)
n1-14 (1B5A) Expert	DC Bus Stabilization Time	<input type="radio"/> V/f <input type="radio"/> OLV/PM <input type="radio"/> EZOLV Adjusts the responsiveness of the oscillation suppression function for the DC bus voltage. Set <i>n1-13</i> = 1 [DC Bus Stabilization Control = Enabled] to enable this parameter.	100.0 ms (0.0 - 500.0 ms)

**Note:**

Adjust this parameter in 100 ms increments.

## ◆ n3: High Slip Braking (HSB) and Overexcitation Braking

*n3* parameters configure High Slip Braking and Overexcitation Deceleration.

### ■ High Slip Braking

High slip braking quickly decelerates motors without using braking resistors.

This lets you stop a motor more quickly than with the ramp to stop processes. This function is best for applications that do not frequently stop the motor, for example the fast stop function for high-inertia loads. High Slip Braking starts when the MFDI for *High Slip Braking (HSB) Activate* [H1-xx = 68] activates.

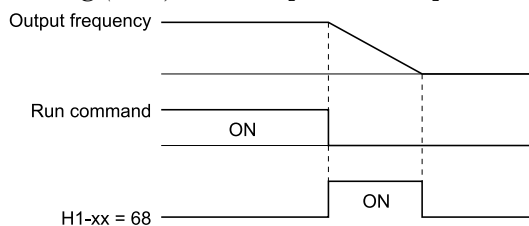

**Figure 12.112 High Slip Braking Time Chart**

An induction motor is necessary to use high slip braking. Set *A1-02* = 0 [Control Method Selection = V/f Control] to enable high slip braking.

#### Principles of Operation

HSB significantly decreases the frequency supplied to the motor at the same time that deceleration starts to increase motor slip.

The drive tries to control output current during deceleration to prevent *oC* [Overcurrent] or *ov* [Overvoltage] faults. It also tries to control slip to supply maximum braking torque.

**High Slip Braking Precautions**

- Do not use the high slip braking function in these applications:
  - Frequent deceleration
  - Deceleration time differences
  - Continuous regenerative loads
  - When it is necessary to accelerate again during deceleration
- Motor loss increases during high slip braking. Use this function when the duty time factor is 5% ED (Duty Cycle) or less and the braking time is 90 seconds or less. The load inertia and motor characteristics have an effect on the braking time.
- The drive ignores the configured deceleration time during high slip braking. To stop motors in the configured deceleration time, set  $L3-04 = 4$  [*Stall Prevention during Decel = Overexcitation/High Flux*].
- You cannot use high slip braking to decelerate at user-defined speeds. To decelerate at user-defined speeds, use the overexcitation deceleration function.
- You cannot accelerate the motor again during high slip braking until you fully stop the motor and input the Run command again.
- You cannot use high slip braking and the KEB Ride-Thru function at the same time. If you enable those two functions, the drive will detect *oPE03* [*Multi-Function Input Setting Err*].

**Overexcitation Deceleration**

Overexcitation deceleration quickly decelerates motors without using braking resistors. This lets you stop a motor more quickly than with the ramp to stop processes.

Overexcitation deceleration increases excitation current during deceleration to cause a large quantity of braking torque through motor overexcitation. You can set the deceleration speed to adjust the deceleration time for overexcitation deceleration.

Overexcitation deceleration lets you accelerate the motor again during deceleration.

Enter the Run command during overexcitation deceleration to cancel overexcitation deceleration and accelerate the drive to the specified speed.

To enable this function, set  $L3-04 = 4$  [*Stall Prevention during Decel = Overexcitation/High Flux*].

When  $L3-04 = 4$ , the motor will decelerate for the deceleration time set in *C1-02* or *C1-04*. If the drive detects *ov* [*Overvoltage*], increase the deceleration time.

**Notes on Overexcitation Deceleration**

- Do not use Overexcitation Deceleration for these applications:
  - Frequent sudden decelerations
  - Continuous regenerative loads
  - Low inertia machines
  - Machines that have no tolerance for torque ripples
- Motor loss increases during overexcitation deceleration. Use this function when the duty time factor is 5% ED or less and the braking time is 90 seconds or less. The load inertia and motor characteristics have an effect on the braking time.

**n3-01: HSB Deceleration Frequency Width**

No. (Hex.)	Name	Description	Default (Range)
n3-01 (0588) Expert	HSB Deceleration Frequency Width	 Sets the amount by which the output frequency is to be lowered during high-slip braking, as a percentage of <i>E1-04</i> [ <i>Maximum Output Frequency</i> ], which represents the 100% value.	5% (1 - 20%)

When you must detect *ov* [*DC Bus Overvoltage*] during high-slip braking, set this parameter to a large value.



### ■ n3-02: HSB Current Limit Level

No. (Hex.)	Name	Description	Default (Range)
n3-02 (0589) Expert	HSB Current Limit Level	<p><b>V/f</b> <b>OLV/PM</b> <b>EZOLV</b></p> <p>Sets the maximum current output during high-slip braking as a percentage, where <i>E2-01 [Motor Rated Current (FLA)]</i> is 100%. Also sets the current suppression to prevent exceeding drive overload tolerance.</p>	Determined by L8-38 (0 - 200%)

When you decrease the setting value for current suppression, it will make the deceleration time longer.

- When you must detect *ov [DC Bus Overvoltage]* during high-slip braking, set this parameter to a low value.
- If the motor current increases during high-slip braking, decrease the setting value to prevent burn damage in the motor.

### ■ n3-03: HSB Dwell Time at Stop

No. (Hex.)	Name	Description	Default (Range)
n3-03 (058A) Expert	HSB Dwell Time at Stop	<p><b>V/f</b> <b>OLV/PM</b> <b>EZOLV</b></p> <p>Sets the dwell time, a length of time when high-slip braking is ending and during which the motor speed decreases and runs at a stable speed. For a set length of time, the drive will hold the actual output frequency at the minimum output frequency set in <i>E1-09</i>.</p>	1.0 s (0.0 - 10.0 s)

If there is too much inertia or when the motor is coasting to a stop after high-slip braking is complete, increase the setting value. If the setting value is too low, machine inertia can cause the motor to rotate after high-slip braking is complete.

### ■ n3-04: HSB Overload Time

No. (Hex.)	Name	Description	Default (Range)
n3-04 (058B) Expert	HSB Overload Time	<p><b>V/f</b> <b>OLV/PM</b> <b>EZOLV</b></p> <p>Sets the time used to detect <i>oL7 [High Slip Braking Overload]</i>, which occurs when the output frequency does not change during high-slip braking. Usually it is not necessary to change this parameter.</p>	40 s (30 - 1200 s)

If a force on the load side is rotating the motor or if there is too much load inertia connected to the motor, the drive will detect *oL7*.

The current flowing to the motor from the load can overheat the motor and cause burn damage to the motor. Set this parameter to prevent burn damage to the motor.

### ■ n3-13: OverexcitationBraking (OEB) Gain

No. (Hex.)	Name	Description	Default (Range)
n3-13 (0531)	OverexcitationBraking (OEB) Gain	<p><b>V/f</b> <b>OLV/PM</b> <b>EZOLV</b></p> <p>Sets the gain value that the drive multiplies by the V/f pattern output value during overexcitation deceleration to calculate the overexcitation level.</p>	1.10 (1.00 - 1.40)

The V/f pattern output value goes back to its usual level after the motor stops or accelerates again to the frequency reference speed.

The best value of this parameter changes when the flux saturation characteristics of the motor change.

- Gradually increase the value of *n3-13* to 1.25 or 1.30 to increase the braking power of Overexcitation Deceleration. If the gain is too much, the motor can have flux saturation and cause a large quantity of current to flow.
- This can increase the deceleration time. Decrease the setting value if flux saturation causes overcurrent. If you increase the setting value, the drive can detect *oC [Overcurrent]*, *oL1 [Motor Overload]*, and *oL2 [Drive Overload]*. Decrease the value of *n3-21 [HSB Current Suppression Level]* to prevent *oC* and *oL*.
- If you use overexcitation deceleration frequently or if you use overexcitation deceleration for an extended period of time, it can increase motor temperature. Decrease the setting value in these conditions.
- If *ov [Overvoltage]* occurs, increase the deceleration time.

### ■ n3-21: HSB Current Suppression Level

No. (Hex.)	Name	Description	Default (Range)
n3-21 (0579)	HSB Current Suppression Level	<input checked="" type="radio"/> V/f <input type="radio"/> OLV/PM <input type="radio"/> EZOLV Sets the upper limit of the current that is suppressed at the time of overexcitation deceleration as a percentage of the drive rated current.	100% (0 - 150%)

If flux saturation during Overexcitation Deceleration makes the motor current become more than the value set in *n3-21*, the drive will automatically decrease the overexcitation gain. If *oC* [Overcurrent], *oL1* [Motor Overload], or *oL2* [Drive Overload] occur during overexcitation deceleration, decrease the setting value.

If repetitive or long overexcitation deceleration cause the motor to overheat, decrease the setting value.

### ■ n3-23: Overexcitation Braking Operation

No. (Hex.)	Name	Description	Default (Range)
n3-23 (057B)	Overexcitation Braking Operation	<input checked="" type="radio"/> V/f <input type="radio"/> OLV/PM <input type="radio"/> EZOLV Sets the direction of motor rotation where the drive will enable overexcitation.	0 (0 - 2)

**0 : Disabled**

**1 : Enabled Only when Rotating FWD**

**2 : Enabled Only when Rotating REV**

**Note:**

When *n3-23* = 1, 2, the drive enables overexcitation only in the direction of motor rotation in which a regenerative load is applied. Increased motor loss can decrease *ov* [Overvoltage] faults.

## ◆ n7: EZ Drive

The *n7* parameters provide special adjustments for EZ Vector Control.

### ■ n7-01: Damping Gain for Low Frequency

No. (Hex.)	Name	Description	Default (Range)
n7-01 (3111) Expert	Damping Gain for Low Frequency	<input type="radio"/> V/f <input type="radio"/> OLV/PM <input checked="" type="radio"/> EZOLV Sets the oscillation suppression gain for the low speed range.	1.0 (0.1 - 10.0)

**Note:**

- If oscillation occurs in the low speed range, increase the acceleration time or increase the setting value in 0.5-unit increments.
- To get starting torque with the setting for *C4-01* [Torque Compensation Gain], decrease the setting value in 0.3-unit increments.

### ■ n7-05: Response Gain for Load Changes

No. (Hex.)	Name	Description	Default (Range)
n7-05 (3115) Expert	Response Gain for Load Changes	<input type="radio"/> V/f <input type="radio"/> OLV/PM <input checked="" type="radio"/> EZOLV Sets the response gain related to changes in the load.	50 (10 - 1000)

**Note:**

To improve tracking related to load changes, increase the setting value in 5-unit increments. If oscillation occurs during load changes, decrease the setting value in 5-unit increments.

### ■ n7-07: Speed Calculation Gain1

No. (Hex.)	Name	Description	Default (Range)
n7-07 (3117) Expert	Speed Calculation Gain1	<input type="radio"/> V/f <input type="radio"/> OLV/PM <input checked="" type="radio"/> EZOLV Sets the speed calculation gain during usual operation. Usually it is not necessary to change this setting.	15.0 (1.0 - 50.0)

## ■ n7-08: Speed Calculation Gain2

No. (Hex.)	Name	Description	Default (Range)
n7-08 (3118) Expert	Speed Calculation Gain2	<input type="checkbox"/> V/f <input type="checkbox"/> OLV/PM <input checked="" type="checkbox"/> EZOLV Sets the speed calculation gain during a speed search.	25.0 (1.0 - 50.0)

### Note:

- When  $E9-01 = 1$  [Motor Type Selection = Permanent Magnet (PM)], the setting range is 1.0 - 80.0.
- When you increase the setting value, you can do a speed search of a motor rotating at a high frequency. If the setting value is too high, the calculated speed will oscillate and a restart will fail. Decrease the setting value in these conditions.

## ■ n7-10: Pull-in Current Switching Speed

No. (Hex.)	Name	Description	Default (Range)
n7-10 (311A) Expert	Pull-in Current Switching Speed	<input type="checkbox"/> V/f <input type="checkbox"/> OLV/PM <input checked="" type="checkbox"/> EZOLV Parameter $n8-51$ [Pull-in Current @ Acceleration], is in effect when the output frequency is $\leq n7-10$ , where the speed is set as a percentage of rated speed.	10.0% (0.0 - 100.0%)

### Note:

- The value set in  $n8-51$  [Pull-in Current @ Acceleration] is enabled for speeds that are not higher than  $n7-10$  during deceleration. The value set in  $b8-01$  [Energy Saving Control Selection] is enabled for speeds higher than  $n7-10$ .
- If there is a large quantity of oscillation when you operate in the low speed range, increase the setting value.
- When it is most important to save energy in the low speed range, decrease the setting value.

## ■ n7-11: Drv Mode Switch Hysteresis Band

No. (Hex.)	Name	Description	Default (Range)
n7-11 (311B) Expert	Drv Mode Switch Hysteresis Band	<input type="checkbox"/> V/f <input type="checkbox"/> OLV/PM <input checked="" type="checkbox"/> EZOLV Sets the hysteresis level for Switching Speed set in $n7-10$ [Pull-in Current Switching Speed]. When the speed is lower than $n7-10 + n7-11$ during acceleration, the drive enables pull-in current.	5.0% (1.0 - 20.0%)

### Note:

- The value set in  $n8-51$  [Pull-in Current @ Acceleration] is enabled for speeds that are not higher than  $n7-10 + n7-11$  during acceleration. The value set in  $b8-01$  [Energy Saving Control Selection] is enabled for speeds higher than  $n7-10 + n7-11$ .
- If there is a large quantity of oscillation when you operate in the low speed range, increase the setting value.
- When it is most important to save energy in the low speed range, decrease the setting value.

## ■ n7-13: Pull-in Current Switching Time

No. (Hex.)	Name	Description	Default (Range)
n7-13 (311D) Expert	Pull-in Current Switching Time	<input type="checkbox"/> V/f <input type="checkbox"/> OLV/PM <input checked="" type="checkbox"/> EZOLV Sets a time to enable the pull-in current commands.	100 ms (0 - 1000 ms)

If there is a large quantity of oscillation at speeds around  $n7-10$  [Pull-in Current Switching Speed], decrease the setting in decrements of 20 ms.

## ■ n7-17: Resistance TemperatureCorrection

No. (Hex.)	Name	Description	Default (Range)
n7-17 (3122)	Resistance TemperatureCorrection	<input type="checkbox"/> V/f <input type="checkbox"/> OLV/PM <input checked="" type="checkbox"/> EZOLV Sets the function to adjust for changes in the motor resistance value caused by changes in the temperature.	1 (0 to 2)

0 : Invalid

1 : Valid (Only 1 time)

2 : Valid (Every time)

**Note:**

- For settings 1 and 2, the adjustment time can cause a delay before startup.
- For settings 1 and 2, the drive can set the line-to-line resistance value of E9-10 [Motor Line-to-Line Resistance].
- When the temperature will change at startup, use setting 2.
- To decrease the startup time, set this parameter to 0, then do line-to-line resistance tuning.
- If you will start from coasting, set this parameter to 0, then do line-to-line resistance tuning.

◆ **n8: PM Motor Control Tuning**

n8 parameters are used to make adjustments when controlling PM motors.

■ **n8-23: ACR q Gain @PoleEst**

No. (Hex.)	Name	Description	Default (Range)
n8-23 (0556) Expert	ACR q Gain @PoleEst	V/f <input type="checkbox"/> OLV/PM <input type="checkbox"/> EZOLV <input type="checkbox"/> Sets the proportional gain for current regulator q-axis control when the drive estimates the initial pole. Usually it is not necessary to change this setting.	0 (0 - 2000)

■ **n8-24: ACR q Integral Time @PoleEst**

No. (Hex.)	Name	Description	Default (Range)
n8-24 (0557) Expert	ACR q Integral Time @PoleEst	V/f <input type="checkbox"/> OLV/PM <input type="checkbox"/> EZOLV <input type="checkbox"/> Sets the integral time for current regulator q-axis control when the drive estimates the initial pole. Usually it is not necessary to change this setting.	0.0 ms (0.0 - 100.0 ms)

■ **n8-25: ACR q Limit @PoleEst**

No. (Hex.)	Name	Description	Default (Range)
n8-25 (0558) Expert	ACR q Limit @PoleEst	V/f <input type="checkbox"/> OLV/PM <input type="checkbox"/> EZOLV <input type="checkbox"/> Sets the q-axis limit of the current regulator when the drive estimates the initial pole. Usually it is not necessary to change this setting.	0% (0 - 150%)

■ **n8-26: ACR d Gain @PoleEst**

No. (Hex.)	Name	Description	Default (Range)
n8-26 (0559) Expert	ACR d Gain @PoleEst	V/f <input type="checkbox"/> OLV/PM <input type="checkbox"/> EZOLV <input type="checkbox"/> Sets the proportional gain for current regulator d-axis control when the drive estimates the initial pole. Usually it is not necessary to change this setting.	500 (0 - 2000)

■ **n8-27: ACR d Integral Time @PoleEst**

No. (Hex.)	Name	Description	Default (Range)
n8-27 (055A) Expert	ACR d Integral Time @PoleEst	V/f <input type="checkbox"/> OLV/PM <input type="checkbox"/> EZOLV <input type="checkbox"/> Sets the integral time for current regulator d-axis control when the drive estimates the initial pole. Usually it is not necessary to change this setting.	0.0 ms (0.0 - 100.0 ms)

■ **n8-28: ACR d Lim @PoleEst**

No. (Hex.)	Name	Description	Default (Range)
n8-28 (055B) Expert	ACR d Lim @PoleEst	V/f <input type="checkbox"/> OLV/PM <input type="checkbox"/> EZOLV <input type="checkbox"/> Sets the d-axis limit of the current regulator when the drive estimates the initial pole. Usually it is not necessary to change this setting.	100% (0 - 150%)

### ■ n8-35: Initial Pole Detection Method

No. (Hex.)	Name	Description	Default (Range)
n8-35 (0562)	Initial Pole Detection Method	V/f <b>OLV/PM</b> EZOLV Sets how the drive detects the position of the rotor at start.	0 (0, 1)

**Note:**

- When you operate an SPM motor, set  $n8-35 = 0$ . When you operate an IPM motor, set  $n8-35 = 0$  to  $2$ .
- When you set  $n8-35 = 1$ , do High Frequency Injection Auto-Tuning.
- When you set  $n8-35 = 0$  or  $2$ , you must examine the drive and machinery setup that you use for the application. If the drive incorrectly detects the polarity, the drive can rotate in the direction opposite of the Run command.

#### 0 : Pull-in

Starts the rotor with pull-in current.

#### 1 : High Frequency Injection

Injects high frequency to detect the rotor position. This setting can cause a loud excitation sound when the motor starts.

### ■ n8-36: HFI Frequency Level for L Tuning

No. (Hex.)	Name	Description	Default (Range)
n8-36 (0563)	HFI Frequency Level for L Tuning	V/f <b>OLV/PM</b> EZOLV Sets the injection frequency for high frequency injection.	500 Hz (200 - 1000 Hz)

**Note:**

- Set  $n8-35 = 1$  [*Initial Pole Detection Method = High Frequency Injection*] to enable this parameter.
- The drive automatically calculates this value when High Frequency Injection Auto-Tuning completes successfully.

### ■ n8-37: HFI Voltage Amplitude Level

No. (Hex.)	Name	Description	Default (Range)
n8-37 (0564) Expert	HFI Voltage Amplitude Level	V/f <b>OLV/PM</b> EZOLV Sets the high frequency injection amplitude as a percentage where 200 V = 100% for 208 V class drives and 400 V = 100% for a 480 V class drives. Usually it is not necessary to change this setting.	20.0% (0.0 - 50.0%)

**Note:**

Set  $n8-35 = 1$  [*Initial Pole Detection Method = High Frequency Injection*] to enable this parameter.

The drive automatically calculates this value when High Frequency Injection Auto-Tuning completes successfully.

### ■ n8-39: HFI LPF Cutoff Freq

No. (Hex.)	Name	Description	Default (Range)
n8-39 (0566)	HFI LPF Cutoff Freq	V/f <b>OLV/PM</b> EZOLV Sets the low-pass filter shut-off frequency for high frequency injection.	250 Hz (0 - 1000 Hz)

**Note:**

- Set  $n8-35 = 1$  [*Initial Pole Detection Method = High Frequency Injection*] to enable this parameter.
- The drive automatically calculates this value when High Frequency Injection Auto-Tuning completes successfully.

### ■ n8-41: HFI P Gain

No. (Hex.)	Name	Description	Default (Range)
n8-41 (0568) Expert	HFI P Gain	V/f <b>OLV/PM</b> EZOLV Sets the response gain for the high frequency injection speed estimation.	2.5 (-10.0 - +10.0)

**Note:**

- Set  $n8-35 = 1$  [Initial Pole Detection Method = High Frequency Injection] to enable this parameter.
- Set  $n8-41 > 0.0$  for IPM motors.

Configure the setting as follows.

- Decrease the setting in 0.5-unit increments if there is hunting or oscillation.
- Increase the setting in 0.5-unit increments if tracking related to load changes is necessary.

■ **n8-42: HFI I Time**

No. (Hex.)	Name	Description	Default (Range)
n8-42 (0569) Expert	HFI I Time	<div style="display: flex; justify-content: space-between; align-items: center;"> <span>V/f</span> <span><b>OLV/IPM</b></span> <span>EZOLV</span> </div> <p>Sets the integral time constant for the high frequency injection speed estimation. Usually it is not necessary to change this setting.</p>	0.10 s (0.00 - 9.99 s)

**Note:**

Set  $n8-35 = 1$  [Initial Pole Detection Method = High Frequency Injection] to enable this parameter.

■ **n8-45: Speed Feedback Detection Gain**

No. (Hex.)	Name	Description	Default (Range)
n8-45 (0538)	Speed Feedback Detection Gain	<div style="display: flex; justify-content: space-between; align-items: center;"> <span>V/f</span> <span><b>OLV/IPM</b></span> <span>EZOLV</span> </div> <p>Sets the internal speed feedback detection reduction unit gain as a magnification value. Usually it is not necessary to change this setting.</p>	0.80 (0.00 - 10.00)

Adjust this parameter in these conditions:

- If vibration or hunting occur, increase the setting value in 0.05 unit increments.
- If the responsiveness of torque and speed is unsatisfactory, decrease the setting value 0.05 unit increments and examine the response.

■ **n8-46: PM Phase Compensation Gain**

No. (Hex.)	Name	Description	Default (Range)
n8-46 (0539) Expert	PM Phase Compensation Gain	<div style="display: flex; justify-content: space-between; align-items: center;"> <span>V/f</span> <span><b>OLV/IPM</b></span> <span>EZOLV</span> </div> <p>Sets the gain to compensate for phase differences. Usually it is not necessary to change this setting.</p>	0.3 (0.0 - 10.0)

If there is vibration in the motor, increase the value. When you must detect  $oC$  [Overcurrent] or  $ov$  [DC Bus Overvoltage], set this parameter to a low value.

■ **n8-47: Pull-in Current Comp Filter Time**

No. (Hex.)	Name	Description	Default (Range)
n8-47 (053A)	Pull-in Current Comp Filter Time	<div style="display: flex; justify-content: space-between; align-items: center;"> <span>V/f</span> <span><b>OLV/IPM</b></span> <span>EZOLV</span> </div> <p>Sets the time constant the drive uses to align the pull-in current reference value with the actual current value. Usually it is not necessary to change this setting.</p>	5.0 s (0.0 - 100.0 s)

Adjust this parameter in these conditions:

- If the time for the reference value of the pull-in current to align with the target value is too long, increase the setting value.
- If vibration or hunting occur, decrease the setting value in 0.2 unit increments.
- If the motor stalls during run at constant speed, decrease the setting value in 0.2 unit increments.

### ■ n8-48: Pull-in/Light Load Id Current

No. (Hex.)	Name	Description	Default (Range)
n8-48 (053B)	Pull-in/Light Load Id Current	<div style="display: flex; justify-content: space-between; align-items: center;"> <span>V/f</span> <span>OLV/PM</span> <span>EZOLV</span> </div> Sets the d-axis current that flows to the motor during run at constant speed as a percentage where E5-03 [PM Motor Rated Current (FLA)] = 100%.	30% (0 - 200%)

Adjust in the following situations.

- Slightly reduce this value if there is too much current when driving a light load at a constant speed.
- Increase the setting value in steps of 5% when hunting or vibration occurs during run at constant speed.
- Increase the setting value in steps of 5% if the motor stalls during run at constant speed.

### ■ n8-49: Heavy Load Id Current

No. (Hex.)	Name	Description	Default (Range)
n8-49 (053C)	Heavy Load Id Current	<div style="display: flex; justify-content: space-between; align-items: center;"> <span>V/f</span> <span>OLV/PM</span> <span>EZOLV</span> </div> Sets the d-axis current to that the drive will supply to the motor to run it at a constant speed with a heavy load. Considers E5-03 [PM Motor Rated Current (FLA)] to be 100%. Usually it is not necessary to change this setting.	Determined by E5-01 (-200.0 - +200.0%)

When you use an IPM motor, you can use the reluctance torque of the motor to make the motor more efficient and help conserve energy.

When you operate an SPN motor, set this parameter to 0.

Adjust this parameter in these conditions:

- If the load is large and motor rotation is not stable, decrease the setting value.
- If you change the E5 parameters [PM Motor Settings], set n8-49 = 0, then adjust this parameter.

### ■ n8-50: Medium Load Iq Level (High)

No. (Hex.)	Name	Description	Default (Range)
n8-50 (053D)	Medium Load Iq Level (High)	<div style="display: flex; justify-content: space-between; align-items: center;"> <span>V/f</span> <span>OLV/PM</span> <span>EZOLV</span> </div> Sets the load current level to start high efficiency control as a percentage of E5-03 [PM Motor Rated Current (FLA)]. Usually it is not necessary to change this setting.	80% (50 - 255%)

### ■ n8-51: Pull-in Current @ Acceleration

No. (Hex.)	Name	Description	Default (Range)
n8-51 (053E)	Pull-in Current @ Acceleration	<div style="display: flex; justify-content: space-between; align-items: center;"> <span>V/f</span> <span>OLV/PM</span> <span>EZOLV</span> </div> Sets the pull-in current allowed to flow during acceleration/deceleration as a percentage of the motor rated current.	Determined by A1-02 (0 - 200%)

Adjust in the following situations.

- When the motor does not smoothly because of large loads, increase the setting value in 5% increments.
- If too much current flows during acceleration, decrease the setting value.

**Note:**

When A1-02 = 8 [Control Method Selection = EZOLV], this parameter will always be in effect for speed ranges less than n7-10 [Pull-in Current Switching Speed].

### ■ n8-52: ACR P Gain

No. (Hex.)	Name	Description	Default (Range)
n8-52 (053F) Expert	ACR P Gain	<div style="display: flex; justify-content: space-between; align-items: center;"> <span>V/f</span> <span>OLV/PM</span> <span>EZOLV</span> </div> Sets the proportional gain of the current regulator. Usually it is not necessary to change this setting.	10.0 (-100.0 - 100.0)

### ■ n8-54: Voltage Error Compensation Time

No. (Hex.)	Name	Description	Default (Range)
n8-54 (056D) Expert	Voltage Error Compensation Time	<input type="checkbox"/> V/f <input checked="" type="checkbox"/> OLV/IPM <input type="checkbox"/> EZOLV Sets the time constant that the drive uses when adjusting for voltage errors.	1.00 s (0.00 - 10.00 s)

Adjust this parameter in these conditions:

- If oscillation occurs at the time of start up, increase the setting value.
- If hunting occurs when operating at low speed, increase the setting value.
- If fast changes in the load cause hunting, increase the setting value in 0.1-unit increments. If you cannot stop hunting, set *n8-51 [Pull-in Current @ Acceleration]* to 0% and set *n8-54* to 0.00 s, and disable compensation for voltage errors.

### ■ n8-55: Motor to Load Inertia Ratio

No. (Hex.)	Name	Description	Default (Range)
n8-55 (056E)	Motor to Load Inertia Ratio	<input type="checkbox"/> V/f <input checked="" type="checkbox"/> OLV/IPM <input type="checkbox"/> EZOLV Sets the ratio between motor inertia and machine inertia.	0 (0 - 3)

Sets the ratio between motor inertia and machine inertia to adjust the ACR.

Adjust in the following situations.

- If torque and speed response are unsatisfactory, gradually increase the setting from 0.
- If the motor does not run smoothly, gradually increase the setting from 0.
- If the motor stalls during run at constant speed, gradually increase the setting from 0.
- If there is vibration or hunting, decrease the setting.

**Note:**

- If the value too low, the drive will detect *STPo [Motor Step-Out Detected]*.
- If you use one motor or more than motor at low inertia and the value is too high, there can be vibration in the motor.

#### 0 : Below 1:10

Use this setting in these conditions:

- The ratio between the motor inertia and machine inertia is less than 1:10
- There are large current ripples

#### 1 : Between 1:10 and 1:30

Use this setting in these conditions:

- The ratio between the motor inertia and machine inertia is approximately 1:10 to 1:30
- Parameter *n8-55 = 0* and the drive detects *STPo* because of an impact load or sudden acceleration/deceleration.

#### 2 : Between 1:30 and 1:50

Use this setting in these conditions:

- The ratio between the motor inertia and machine inertia is approximately 1:30 to 1:50
- Parameter *n8-55 = 1* and the drive detects *STPo* because of an impact load or sudden acceleration/deceleration.

#### 3 : Beyond 1:50

Adjust this parameter in these conditions:

- The ratio between the motor inertia and machine inertia is more than 1:50
- Parameter *n8-55 = 2* and the drive detects *STPo* because of an impact load or sudden acceleration/deceleration.



### ■ n8-56: PM High Performance Selection

No. (Hex.)	Name	Description	Default (Range)
n8-56 (056F) Expert	PM High Performance Selection	V/f <b>OLV/PM</b> EZOLV Usually it is not necessary to change this setting. Sets the high efficiency control method for IPM motor.	1 (0 - 2)

0 : Disabled

1 : Enabled (Vd)

2 : Enabled (Vd & Vq)

### ■ n8-62: Output Voltage Limit Level

No. (Hex.)	Name	Description	Default (Range)
n8-62 (057D) Expert	Output Voltage Limit Level	V/f <b>OLV/PM</b> EZOLV Sets the output voltage limit to prevent saturation of the output voltage. Usually it is not necessary to change this parameter.	208 V Class: 200.0 V, 480 V Class: 400.0 V (208 V Class: 0.0 - 240.0 V, 480 V Class: 0.0 - 480.0 V)

Set this parameter lower than the input power supply voltage.

**Note:**

- When  $A1-02 = 8$  [Control Method Selection = EZOLV], this parameter is available in Expert Mode.
- When  $A1-02 = 8$ , the default setting is:  
–208 V Class: 230.0 V  
–480 V Class: 460.0 V

### ■ n8-63: Output Voltage Limit P Gain

No. (Hex.)	Name	Description	Default (Range)
n8-63 (057E) Expert	Output Voltage Limit P Gain	V/f <b>OLV/PM</b> EZOLV Sets the proportional gain for output voltage control. Usually it is not necessary to change this setting.	1.00 (0.00 - 100.00)

### ■ n8-64: Output Voltage Limit I Time

No. (Hex.)	Name	Description	Default (Range)
n8-64 (057F) Expert	Output Voltage Limit I Time	V/f <b>OLV/PM</b> EZOLV Sets the integral time for output voltage control. Usually it is not necessary to change this setting.	0.040 s (0.000 - 5.000)

### ■ n8-65: Speed Fdbk Gain @ oV Suppression

No. (Hex.)	Name	Description	Default (Range)
n8-65 (065C) Expert	Speed Fdbk Gain @ oV Suppression	V/f <b>OLV/PM</b> EZOLV Sets the gain of internal speed feedback detection suppression while the overvoltage suppression function is operating as a magnification value. Usually it is not necessary to change this parameter.	1.50 (0.00 - 10.00)

Adjust this parameter in these conditions:

- If there is resonance or hunting when you use the overvoltage suppression function, increase the setting value.
- If motor response is low when you use the overvoltage suppression function, decrease the setting value in 0.05-unit increments.

### ■ n8-66: Output Voltage Limit Filter Time

No. (Hex.)	Name	Description	Default (Range)
n8-66 (0235) Expert	Output Voltage Limit Filter Time	<input type="checkbox"/> V/f <input checked="" type="checkbox"/> OLV/PM <input type="checkbox"/> EZOLV Sets the filter time constant for output voltage control. Usually it is not necessary to change this setting.	0.020 s (0.000 - 5.000)

### ■ n8-74: Light Load Iq Level

No. (Hex.)	Name	Description	Default (Range)
n8-74 (05C3)	Light Load Iq Level	<input type="checkbox"/> V/f <input checked="" type="checkbox"/> OLV/PM <input type="checkbox"/> EZOLV Set n8-48 [Pull-in/Light Load Id Current] to the percentage of load current (q-axis current) that you will apply, where E5-03 [PM Motor Rated Current (FLA)] = a setting value of 100%.	30% (0 - 255%)

**Note:**

- If n8-74 > n8-75 [Medium Load Iq Level (low)], the drive will detect oPE08 [Parameter Selection Error].
- The change is linear between n8-74 and n8-75 and the level of the pull-in current from n8-48 to n8-78 [Medium Load Id Current].

### ■ n8-75: Medium Load Iq Level (low)

No. (Hex.)	Name	Description	Default (Range)
n8-75 (05C4)	Medium Load Iq Level (low)	<input type="checkbox"/> V/f <input checked="" type="checkbox"/> OLV/PM <input type="checkbox"/> EZOLV Set n8-78 [Medium Load Id Current] to the percentage of load current (q-axis current) that you will apply, where E5-03 [PM Motor Rated Current (FLA)] = a setting value of 100%.	50% (0 - 255%)

**Note:**

- If n8-74 [Light Load Iq Level] > n8-75, the drive will detect oPE08 [Parameter Selection Error].
- The change is linear between n8-74 and n8-75 and the level of the pull-in current from n8-48 to n8-78 [Medium Load Id Current].

### ■ n8-76: Id Switching Filter Time

No. (Hex.)	Name	Description	Default (Range)
n8-76 (05CD) Expert	Id Switching Filter Time	<input type="checkbox"/> V/f <input checked="" type="checkbox"/> OLV/PM <input type="checkbox"/> EZOLV Sets the filter time constant for d-axis current reference. Usually it is not necessary to change this setting.	200 ms (0 - 5000 ms)

### ■ n8-77: Heavy Load Iq Level

No. (Hex.)	Name	Description	Default (Range)
n8-77 (05CE)	Heavy Load Iq Level	<input type="checkbox"/> V/f <input checked="" type="checkbox"/> OLV/PM <input type="checkbox"/> EZOLV Set n8-49 [Heavy Load Id Current] to the percentage of load current (q-axis current) that you will apply, where E5-03 [PM Motor Rated Current (FLA)] = a setting value of 100%.	90% (0 - 255%)

**Note:**

The change is linear between n8-75 [Medium Load Iq Level (low)] and n8-77 and the level of the pull-in current from n8-78 [Medium Load Id Current] to n8-49 [Heavy Load Id Current].

### ■ n8-78: Medium Load Id Current

No. (Hex.)	Name	Description	Default (Range)
n8-78 (05F4)	Medium Load Id Current	<input type="checkbox"/> V/f <input checked="" type="checkbox"/> OLV/PM <input type="checkbox"/> EZOLV Sets the level of the pull-in current for mid-range loads.	0% (-200 - +200%)

### ■ n8-79: Pull-in Current @ Deceleration

No. (Hex.)	Name	Description	Default (Range)
n8-79 (05FE)	Pull-in Current @ Deceleration	<div style="display: flex; justify-content: space-between; align-items: center;"> <span>V/f</span> <span>OLV/PM</span> <span>EZOLV</span> </div> Sets the pull-in current that can flow during deceleration as a percentage of the E5-03 [PM Motor Rated Current (FLA)].	50% (0 - 200%)

If overcurrent occurs during deceleration, slowly decrease the setting in 5% increments.

**Note:**

When  $n8-79 = 0$ , the drive will use the value set in  $n8-51$  [Pull-in Current @ Acceleration].

### ■ n8-84: Polarity Detection Current

No. (Hex.)	Name	Description	Default (Range)
n8-84 (02D3) Expert	Polarity Detection Current	<div style="display: flex; justify-content: space-between; align-items: center;"> <span>V/f</span> <span>OLV/PM</span> <span>EZOLV</span> </div> Sets the current for processing an estimation of the initial motor magnetic pole as a percentage, where E5-03 [PM Motor Rated Current] is the 100% value.	100% (0 - 150%)

**WARNING! Sudden Movement Hazard.** Make sure that the polarity is correct before you send a Run command. If the drive incorrectly detects the polarity, the drive can rotate in the direction opposite of the Run command and cause serious injury or death.

If you use a Yaskawa motor and the motor nameplate has an “Si” item, set this parameter to a value equal to or more than “Si × 2”. Consult the motor manufacturer for the maximum setting values.

#### Find the Polarity of Magnetic Poles

At start, the drive estimates the magnetic poles and finds the polarity of the magnetic poles.

Use U6-57 [PolePolarityDeterVal] to make sure that the drive correctly estimated the polarity of the magnetic poles.

The drive automatically calculates  $n8-84$  when High Frequency Injection Auto-Tuning completes successfully.

### ■ n8-91: Id Limit at Voltage Saturation

No. (Hex.)	Name	Description	Default (Range)
n8-91 (02F7) Expert	Id Limit at Voltage Saturation	<div style="display: flex; justify-content: space-between; align-items: center;"> <span>V/f</span> <span>OLV/PM</span> <span>EZOLV</span> </div> Sets the limit value of feedback output voltage limit Id operation. Usually it is not necessary to change this setting.	-50% (-200 - 0%)

## 12.11 o: Keypad-Related Settings

*o* parameters set keypad functions.

### ◆ o1: Keypad Display Selection

*o1* parameters select the parameters shown on the initial keypad screen and to configure the parameter setting units and display units. These parameters also adjust the backlight and contrast of the LCD display.

#### ■ Home Screen Display Format

*o1-40* [Home Screen Display Selection] changes the display of the monitor shown on the Home screen. You can show numerical values or one of these three displays on the Home screen monitor:

##### Bar Graph Display

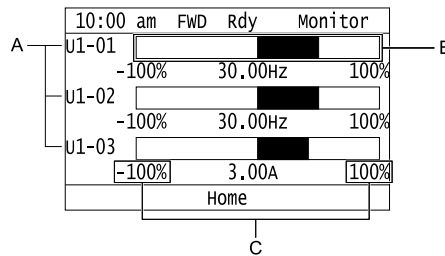

- A - Select *Ux-xx* [Monitors] with *o1-24*, *o1-25*, and *o1-26*.
- B - Configure display regions with *o1-41*, *o1-43*, and *o1-45*.

- C - Select display ranges with *o1-42*, *o1-44*, and *o1-46*.

##### Analog Gauge Display

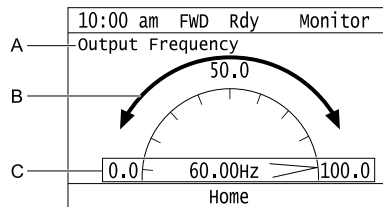

- A - Select *Ux-xx* [Monitors] with *o1-24*.
- B - Configure display regions with *o1-56*.

- C - Select display ranges with *o1-55*.

##### Trend Plot Display

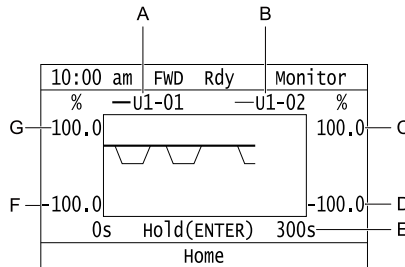

- A - Select *Ux-xx* [Monitors] (Monitor 1) with *o1-24*.
- B - Select *Ux-xx* [Monitors] (Monitor 2) with *o1-25*.
- C - Set the maximum value of Monitor 2 with *o1-50*
- D - Set the minimum value of Monitor 2 with *o1-49*

- E - Set the time scale with *o1-51*
- F - Set the minimum value of Monitor 1 with *o1-47*
- G - Set the maximum value of Monitor 1 with *o1-48*

##### Full Screen Information Display

When you set *o1-82* = 1 [Message Screen Display = ON], you can show an active status message in full screen on the keypad.

Table 12.62 Example of Message Displays for Pre-Charge

Default (o1-82 = 0)	Full Screen Message (o1-82 = 1)
<pre> 10:00 am FWD Rdy Home AUTO Pre-Charge: Exit in 10min Freq Reference (KPD) U1-01 Hz 45.00 Output Frequency U1-02 Hz 45.00 Menu </pre>	<pre> 10:00 am FWD Rdy Pre-Charge Mode Exit in 10min Home </pre>

**Note:**

- When  $o1-80 = 0$  [OFF], drive Faults,  $oFAxx$ , or  $CPF$ s do not trigger a full-screen message to display.
- When  $o1-81 = 0$  [Alarm Screen Display = OFF], drive Alarms do not trigger a full-screen message to display.
- When  $o1-82 = 0$  [Message Screen Display = OFF], drive Messages do not trigger a full-screen message to display. The keypad will continue to show limit errors and other informative screens.
- You cannot select the display method of  $oPExx$  [Parameter Setting Errors]. The keypad shows  $oPExx$  errors as full screen displays and status monitor displays. Active  $oPExx$  errors have display priority over active faults and alarms.

**Status Monitor Display**

When  $o1-40 = 0$  [Home Screen Display Selection = Custom Monitor], the keypad will show the Status Monitor on the second and third lines of the HOME screen.

- The second line shows HOA status and other information, for example:
  - Fault/Alarm/ $oPExx$ / $oFAxx$  codes
  - MEMOBUS Multiplex drive status
  - Information Text status
- The third line shows information texts, for example:
  - Pre-Charge messages
  - Sleep messages
  - MEMOBUS Multiplex Staging and De-staging messages

It will also show Information Text for Sequence Timer status.

Table 12.63 shows the examples of Status Monitor display during normal operation.

**Table 12.63 Normal Operation Display**

Custom Monitors Setting (o1-24 to o1-35)	Display with No Message	Display with Message
More than one monitor set	<pre> 10:00 am FWD Rdy Home OFF ----- Freq Reference (AI) 40.00 U1-01 Hz Output Frequency 40.00 U1-02 Hz Menu                     </pre>	<pre> 10:00 am FWD Rdy Home AUTO Pre-charge: Exit in 8sec ----- Freq Reference (AI) 40.00 U1-01 Hz Output Frequency 40.00 U1-02 Hz Menu                     </pre>
Only one monitor set	<pre> 10:00 am FWD Rdy Home OFF ----- Setpoint U5-99 80.00% Menu                     </pre>	<pre> 10:00 am FWD Rdy Home AUTO Pre-charge: Exit in 8sec ----- Freq Reference (KPD) U1-01 40.00Hz Menu                     </pre>
No monitor set	<pre> 10:00 am FWD Rdy Home OFF ----- Menu                     </pre>	<pre> 10:00 am FWD Rdy Home AUTO Sleep Active: wait for Start ----- Menu                     </pre>

The keypad will also show Information Text on the second and third lines. Information Texts are display indications of the current drive status. Information Texts are similar to Messages, but they cannot display as full-screen.

**Table 12.64 Displays for Information Text**

Keypad Display	Description
<pre> 10:00 am FWD Rdy Home OFF Parameters Locked ----- Freq Reference (KPD) 40.00 U1-01 Hz Output Frequency 40.00 U1-02 Hz Menu                     </pre>	The keypad shows Information Text only on the second line.
<pre> 10:00 am FWD Rdy Home AUTO Parameters Locked Sequence Timer 1: RUN ----- Freq Reference (KPD) 40.00 U1-01 Hz Output Frequency 40.00 U1-02 Hz Menu                     </pre>	The keypad shows Information Texts on the second and third lines.

When an alarm occurs, the keypad will show the alarm code and alarm name on the second and third lines.

```

10:00 am FWD Rdy Home
AUTO UL3
Undertorque Detection 1
-----
Setpoint
U5-99 % 80.00
Output Frequency 54.21
U1-02 Hz
Menu
    
```

**Figure 12.113 Display for Alarm**

When a fault occurs, the drive will reset the scroll position of the HOME screen display and show the related message on the second and third line.

**Note:**

The drive will not reset the HOME screen display if an alarm or message occurs.

10:00 am	FWD	Home
<b>OFF</b>	EF3	
External Fault (Terminal S3)		
Setpoint		80.00
U5-99 %		
Output Frequency		0.00
U1-02 Hz		
Reset	Menu	

**Figure 12.114 Display for Fault**

When the keypad must show more than one status (Alarms/Faults, Information Text, Messages) on the Status Monitor, the keypad will cycle a different display each 2 s.

If there is a new alarm or fault, it will stop the display cycle and the keypad will show the alarm or fault screen for 1 s. The keypad will then start the 2-second display cycles again from the Information Text display screen.

If the Information Text only has an effect on the second line, the keypad will show a Message or an Alarm on the third line. The Message display has priority because it is possible to have more than one active Message at the same time.

**Table 12.65 Displays for More than One Status**

Keypad Display		Description																																																																	
<table border="1"> <tr><td>10:00 am</td><td>FWD</td><td>Rdy</td><td>Home</td></tr> <tr><td><b>AUTO</b></td><td>UL3</td><td></td><td></td></tr> <tr><td colspan="4">Undertorque Detection 1</td></tr> <tr><td>Freq Reference</td><td></td><td></td><td>40.00</td></tr> <tr><td>U1-01 Hz</td><td></td><td></td><td></td></tr> <tr><td>Output Frequency</td><td></td><td></td><td>40.00</td></tr> <tr><td>U1-02 Hz</td><td></td><td></td><td></td></tr> <tr><td colspan="4">Menu</td></tr> </table>	10:00 am	FWD	Rdy	Home	<b>AUTO</b>	UL3			Undertorque Detection 1				Freq Reference			40.00	U1-01 Hz				Output Frequency			40.00	U1-02 Hz				Menu					<table border="1"> <tr><td>10:00 am</td><td>FWD</td><td>Rdy</td><td>Home</td></tr> <tr><td><b>AUTO</b></td><td></td><td></td><td></td></tr> <tr><td colspan="4">Pre-charge: Exit in 8sec</td></tr> <tr><td>Freq Reference</td><td></td><td></td><td>40.00</td></tr> <tr><td>U1-01 Hz</td><td></td><td></td><td></td></tr> <tr><td>Output Frequency</td><td></td><td></td><td>40.00</td></tr> <tr><td>U1-02 Hz</td><td></td><td></td><td></td></tr> <tr><td colspan="4">Menu</td></tr> </table>	10:00 am	FWD	Rdy	Home	<b>AUTO</b>				Pre-charge: Exit in 8sec				Freq Reference			40.00	U1-01 Hz				Output Frequency			40.00	U1-02 Hz				Menu				When the keypad must show an alarm and message at the same time, it will toggle the second and third lines each 2 s.
10:00 am	FWD	Rdy	Home																																																																
<b>AUTO</b>	UL3																																																																		
Undertorque Detection 1																																																																			
Freq Reference			40.00																																																																
U1-01 Hz																																																																			
Output Frequency			40.00																																																																
U1-02 Hz																																																																			
Menu																																																																			
10:00 am	FWD	Rdy	Home																																																																
<b>AUTO</b>																																																																			
Pre-charge: Exit in 8sec																																																																			
Freq Reference			40.00																																																																
U1-01 Hz																																																																			
Output Frequency			40.00																																																																
U1-02 Hz																																																																			
Menu																																																																			
<table border="1"> <tr><td>10:00 am</td><td>FWD</td><td>Rdy</td><td>Home</td></tr> <tr><td><b>AUTO</b></td><td>Parameters Locked</td><td></td><td></td></tr> <tr><td colspan="4">Undertorque Detection 1</td></tr> <tr><td>Freq Reference (KPD)</td><td></td><td></td><td>40.00</td></tr> <tr><td>U1-01 Hz</td><td></td><td></td><td></td></tr> <tr><td>Output Frequency</td><td></td><td></td><td>40.00</td></tr> <tr><td>U1-02 Hz</td><td></td><td></td><td></td></tr> <tr><td colspan="4">Menu</td></tr> </table>	10:00 am	FWD	Rdy	Home	<b>AUTO</b>	Parameters Locked			Undertorque Detection 1				Freq Reference (KPD)			40.00	U1-01 Hz				Output Frequency			40.00	U1-02 Hz				Menu					<table border="1"> <tr><td>10:00 am</td><td>FWD</td><td>Rdy</td><td>Home</td></tr> <tr><td><b>AUTO</b></td><td>UL3</td><td></td><td></td></tr> <tr><td colspan="4">Undertorque Detection 1</td></tr> <tr><td>Freq Reference (KPD)</td><td></td><td></td><td>40.00</td></tr> <tr><td>U1-01 Hz</td><td></td><td></td><td></td></tr> <tr><td>Output Frequency</td><td></td><td></td><td>40.00</td></tr> <tr><td>U1-02 Hz</td><td></td><td></td><td></td></tr> <tr><td colspan="4">Menu</td></tr> </table>	10:00 am	FWD	Rdy	Home	<b>AUTO</b>	UL3			Undertorque Detection 1				Freq Reference (KPD)			40.00	U1-01 Hz				Output Frequency			40.00	U1-02 Hz				Menu				When the keypad must show an Information Text only on the second line and an alarm at the same time, it will toggle the second line each 2 s.
10:00 am	FWD	Rdy	Home																																																																
<b>AUTO</b>	Parameters Locked																																																																		
Undertorque Detection 1																																																																			
Freq Reference (KPD)			40.00																																																																
U1-01 Hz																																																																			
Output Frequency			40.00																																																																
U1-02 Hz																																																																			
Menu																																																																			
10:00 am	FWD	Rdy	Home																																																																
<b>AUTO</b>	UL3																																																																		
Undertorque Detection 1																																																																			
Freq Reference (KPD)			40.00																																																																
U1-01 Hz																																																																			
Output Frequency			40.00																																																																
U1-02 Hz																																																																			
Menu																																																																			
<table border="1"> <tr><td>10:00 am</td><td>FWD</td><td>Rdy</td><td>Home</td></tr> <tr><td><b>AUTO</b></td><td>Parameters Locked</td><td></td><td></td></tr> <tr><td colspan="4">Pre-charge: Exit in 8sec</td></tr> <tr><td>Freq Reference (KPD)</td><td></td><td></td><td>40.00</td></tr> <tr><td>U1-01 Hz</td><td></td><td></td><td></td></tr> <tr><td>Output Frequency</td><td></td><td></td><td>40.00</td></tr> <tr><td>U1-02 Hz</td><td></td><td></td><td></td></tr> <tr><td colspan="4">Menu</td></tr> </table>	10:00 am	FWD	Rdy	Home	<b>AUTO</b>	Parameters Locked			Pre-charge: Exit in 8sec				Freq Reference (KPD)			40.00	U1-01 Hz				Output Frequency			40.00	U1-02 Hz				Menu					<table border="1"> <tr><td>10:00 am</td><td>FWD</td><td>Rdy</td><td>Home</td></tr> <tr><td><b>AUTO</b></td><td></td><td></td><td></td></tr> <tr><td colspan="4">Pre-charge: Exit in 8sec</td></tr> <tr><td>Freq Reference (KPD)</td><td></td><td></td><td>40.00</td></tr> <tr><td>U1-01 Hz</td><td></td><td></td><td></td></tr> <tr><td>Output Frequency</td><td></td><td></td><td>40.00</td></tr> <tr><td>U1-02 Hz</td><td></td><td></td><td></td></tr> <tr><td colspan="4">Menu</td></tr> </table>	10:00 am	FWD	Rdy	Home	<b>AUTO</b>				Pre-charge: Exit in 8sec				Freq Reference (KPD)			40.00	U1-01 Hz				Output Frequency			40.00	U1-02 Hz				Menu				When the keypad must show an Information Text only on the second line and a message at the same time, it will toggle the second line each 2 s.
10:00 am	FWD	Rdy	Home																																																																
<b>AUTO</b>	Parameters Locked																																																																		
Pre-charge: Exit in 8sec																																																																			
Freq Reference (KPD)			40.00																																																																
U1-01 Hz																																																																			
Output Frequency			40.00																																																																
U1-02 Hz																																																																			
Menu																																																																			
10:00 am	FWD	Rdy	Home																																																																
<b>AUTO</b>																																																																			
Pre-charge: Exit in 8sec																																																																			
Freq Reference (KPD)			40.00																																																																
U1-01 Hz																																																																			
Output Frequency			40.00																																																																
U1-02 Hz																																																																			
Menu																																																																			

## 12.11 o: Keypad-Related Settings

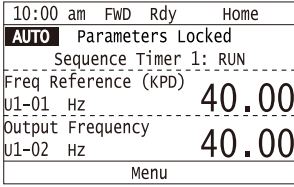
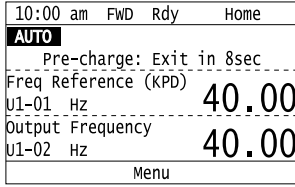
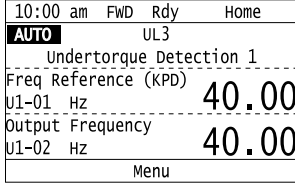
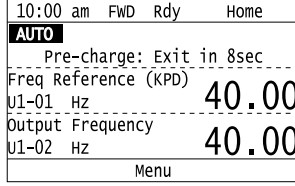
Keypad Display		Description
		When the keypad must show an Information Text and message at the same time, it will toggle the second and third lines each 2 s.
		

### o1-03: Frequency Display Unit Selection

No. (Hex.)	Name	Description	Default (Range)
o1-03 (0502)	Frequency Display Unit Selection	<input type="radio"/> V/f <input type="radio"/> OL/PM <input type="radio"/> EZOLV Sets the display units for the frequency reference and output frequency.	0 (0 - 3)

#### Note:

- Select the units for these parameters:
  - d1-01 [Reference 1] to d1-08 [Reference 8], d1-17 [Jog Reference]
  - U1-01 [Frequency Reference]
  - U1-02 [Output Frequency]
  - U1-05 [Motor Speed]
  - U1-16 [SFS Output Frequency]
  - U4-14 [PeakHold Output Freq]
  - U5-07 [AUTO Mode Freq Ref]
  - U5-08 [HAND Mode Freq Ref]
- For motor 2, the settings are always 0 [in Hz unit].

#### 0 : 0.01Hz units

#### 1 : 0.01% units

The maximum output frequency is 100%.

#### Note:

- Parameter A1-02 [Control Method Selection] selects which parameter is the maximum output frequency.
  - A1-02 ≠ 8 [EZOLV]: E1-04 [Maximum Output Frequency]
  - A1-02 = 8: E9-02 [Maximum Speed]

#### 2 : min<sup>-1</sup> (r/min) unit

The drive uses the maximum output frequency and number of motor poles calculate this value automatically.

#### Note:

- When you set o1-03 = 2, make sure that you set the number of motor poles in these parameters:
  - E2-04 [Motor Pole Count]
  - E4-04 [Motor 2 Motor Poles]
  - E5-04 [PM Motor Pole Count]
  - E9-08 [Motor Pole Count]

#### 3 : User Units (o1-09 -o1-11)



Uses *o1-09* [Freq. Reference Display Units], *o1-10* [User Units Maximum Value], and *o1-11* [User Units Decimal Position] to set the unit of measure. The value of parameter *o1-10* is the value when you remove the decimal point from the maximum output frequency. Parameter *o1-11* is to the number of digits after the decimal point in the maximum output frequency.

To display a maximum output frequency of 100.00, set parameters to these values:

- *o1-10* = 10000
- *o1-11* = 2 [User Units Decimal Position = Two Decimal Places (XXX.XX)]

### ■ o1-05: LCD Contrast Adjustment

No. (Hex.)	Name	Description	Default (Range)
o1-05 (0504) RUN	LCD Contrast Adjustment	<b>V/f</b> <b>OLV/PM</b> <b>EZOLV</b> Sets the contrast of the LCD display on the keypad.	5 (0 - 10)

When you decrease the setting value, the contrast of the LCD display decreases. When you increase the setting value, the contrast increases.

### ■ o1-09: Freq. Reference Display Units

No. (Hex.)	Name	Description	Default (Range)
o1-09 (051C)	Freq. Reference Display Units	<b>V/f</b> <b>OLV/PM</b> <b>EZOLV</b> Sets the unit of display for the frequency reference parameters and frequency-related monitors when <i>o1-03</i> = 3 [Frequency Display Unit Selection = User Units (o1-09 ~ o1-11)].	50 (0 - 50)

**0** : “WC: inches of water column

**1** : PSI: pounds per square inch

**2** : GPM: gallons/min

**3** : °F: Fahrenheit

**4** : ft<sup>3</sup>/min: cubic feet/min

**5** : m<sup>3</sup>/h: cubic meters/hour

**6** : L/h: liters/hour

**7** : L/s: liters/sec

**8** : bar: bar

**9** : Pa: Pascal

**10** : °C: Celsius

**11** : m: meters

**12** : ft: feet

**13** : L/min: liters/min

**14** : m<sup>3</sup>/min: cubic meters/min

**15** : “Hg: Inch Mercury

**16** : kPa: kilopascal

**48** : %: Percent

**49** : Custom(o1-13~15)

**50** : None

### ■ o1-10: User Units Maximum Value

No. (Hex.)	Name	Description	Default (Range)
o1-10 (0520)	User Units Maximum Value	<b>V/f</b> <b>OLV/PM</b> <b>EZOLV</b> Sets the value that the drive shows as the maximum output frequency.	Determined by o1-03 (1 - 60000)

## 12.11 o: Keypad-Related Settings

To display a maximum output frequency of 100.00, set parameters to these values:

- $o1-10 = 10000$
- $o1-11 = 2$  [*User Units Decimal Position = Two Decimal Places (XXX.XX)*]

**Note:**

Set  $o1-03 = 3$  [*Frequency Display Unit Selection = User Units (o1-10 & o1-11)*] before you set  $o1-10$  and  $o1-11$ .

### ■ o1-11: User Units Decimal Position

No. (Hex.)	Name	Description	Default (Range)
o1-11 (0521)	User Units Decimal Position	<input type="radio"/> V/f <input type="radio"/> OLV/IPM <input type="radio"/> EZOLV Sets the number of decimal places for frequency reference and monitor values.	Determined by o1-03 (0 - 3)

**0 : No Decimal Places (XXXXX)**

**1 : One Decimal Places (XXXX.X)**

**2 : Two Decimal Places (XXX.XX)**

**3 : Three Decimal Places (XX.XXX)**

**Note:**

Set  $o1-03 = 3$  [*Frequency Display Unit Selection = User Units (o1-10 & o1-11)*] before you set  $o1-10$  [*User Units Maximum Value*] and  $o1-11$ .

### ■ o1-13: Freq. Reference Custom Unit 1

No. (Hex.)	Name	Description	Default (Range)
o1-13 (3105)	Freq. Reference Custom Unit 1	<input type="radio"/> V/f <input type="radio"/> OLV/IPM <input type="radio"/> EZOLV Sets the first character of the custom unit display when $o1-03 = 3$ [ <i>Frequency Display Unit Selection = User Units</i> ] and $o1-09 = 49$ [ <i>Freq. Reference Display Units = Custom (o1-13~15)</i> ].	41 (20 - 7A)

Refer to [Custom Units on page 656](#) for more information about available selections.

### ■ o1-14: Freq. Reference Custom Unit 2

No. (Hex.)	Name	Description	Default (Range)
o1-14 (3106)	Freq. Reference Custom Unit 2	<input type="radio"/> V/f <input type="radio"/> OLV/IPM <input type="radio"/> EZOLV Sets the second character of the custom unit display when $o1-03 = 3$ [ <i>Frequency Display Unit Selection = User Units</i> ] and $o1-09 = 49$ [ <i>Freq. Reference Display Units = Custom (o1-13~15)</i> ].	41 (20 - 7A)

Refer to [Custom Units on page 656](#) for more information about available selections.

### ■ o1-15: Freq. Reference Custom Unit 3

No. (Hex.)	Name	Description	Default (Range)
o1-15 (3107)	Freq. Reference Custom Unit 3	<input type="radio"/> V/f <input type="radio"/> OLV/IPM <input type="radio"/> EZOLV Sets the third character of the custom unit display when $o1-03 = 3$ [ <i>Frequency Display Unit Selection = User Units</i> ] and $o1-09 = 49$ [ <i>Freq. Reference Display Units = Custom (o1-13~15)</i> ].	41 (20 - 7A)

Refer to [Custom Units on page 656](#) for more information about available selections.

### ■ o1-17: F3 Key Function Selection

No. (Hex.)	Name	Description	Default (Range)
o1-17 (3109)	F3 Key Function Selection	<input type="radio"/> V/f <input type="radio"/> OLV/IPM <input type="radio"/> EZOLV Sets the action when you push the F3 key and the LCD display text above the F3 key.	0 (0 - 4)

**0 : Standard (based on screen)**

F3 key function changes when the screen shown on the keypad changes.

**1 : MONITOR (shortcut)**

F3 key takes you directly to the Monitor screen with *U1-01 [Frequency Reference]* selected.

#### 4 : RLY (ON/OFF H2-XX = A9)

F3 key toggles the state of the digital output set for *H2-xx = A9 [MFDO Function Selection = RELAY Operator Control]*.

#### ■ o1-18: User Defined Parameter 1

No. (Hex.)	Name	Description	Default (Range)
o1-18 (310A)	User Defined Parameter 1	<input type="checkbox"/> V/f <input type="checkbox"/> OLV/PM <input type="checkbox"/> EZOLV Lets you set values to use as reference information.	0 (0 - 999)

#### ■ o1-19: User Defined Parameter 2

No. (Hex.)	Name	Description	Default (Range)
o1-19 (310B)	User Defined Parameter 2	<input type="checkbox"/> V/f <input type="checkbox"/> OLV/PM <input type="checkbox"/> EZOLV Lets you set values to use as reference information.	0 (0 - 999)

#### ■ o1-24 to o1-35: Custom Monitor 1 to 12

No. (Hex.)	Name	Description	Default (Range)
o1-24 to o1-35 (11AD - 11B8) RUN	Custom Monitor 1 to 12	<input type="checkbox"/> V/f <input type="checkbox"/> OLV/PM <input type="checkbox"/> EZOLV Set a maximum of 12 monitors as user monitors. These parameters are only available on an HOA keypad.	o1-24: 101 o1-25: 102 o1-26: Determined by b5-01 o1-27 to o1-35: 0 (0, 101 - 1299)

These parameters save the monitor items selected by the HOA keypad [Custom Monitor].

##### Note:



- The default setting for *o1-26* changes when *b5-01 [PID Mode Setting]* changes:
  - b5-01 = 0 [Disabled]*: 103
  - b5-01 ≠ 0*: 501
- You can show a maximum of three selected monitors on one HOA keypad screen.
  - When you select only one monitor, the text size of this monitor increases. For example, when *o1-25 to o1-35 = 0*, the text size of the monitor saved in *o1-24* increases.
  - When you select two monitors, the text size of these monitors increase.
  - When you select four or more monitors, the fourth monitor and all additional monitors are shown on the next screens.
- Monitors selected with *o1-24 to o1-26* can be displayed as a bar graph, analog gauge, or trend plot.
  - Bar graph display: 3 monitors maximum  
Select with *o1-24, o1-25, and o1-26*.
  - Analog gauge display: 1 monitor  
Select with *o1-24*.
  - Trend plot display: 2 monitors  
Select with *o1-24 and o1-25*.
- You can only set parameters *o1-24 to o1-26* with analog output monitors.
- You can set all monitors to parameters *o1-27 to o1-35*.

#### ■ o1-36: LCD Backlight Brightness

No. (Hex.)	Name	Description	Default (Range)
o1-36 (11B9) RUN	LCD Backlight Brightness	<input type="checkbox"/> V/f <input type="checkbox"/> OLV/PM <input type="checkbox"/> EZOLV Sets the intensity of the HOA keypad backlight.	5 (1 - 5)

When you decrease the setting value, the intensity of the backlight decreases.

### ■ o1-37: LCD Backlight ON/OFF Selection

No. (Hex.)	Name	Description	Default (Range)
o1-37 (11BA) RUN	LCD Backlight ON/OFF Selection	   Sets the automatic shut off function for the LCD backlight.	1 (0, 1)

**Note:**



Use o1-36 [LCD Backlight Brightness] to adjust the intensity of the LCD backlight.

#### 0 : OFF

The automatic backlight shut off function is enabled. The backlight will automatically turn off after the time set in o1-38 [LCD Backlight Off-Delay] is expired.

**Note:**



When o1-37 = 0 and the backlight is OFF, the keys other than  are disabled.

When the backlight is OFF, push a key on the keypad to temporarily turn the backlight ON. To use the key function to operate the drive, push the same key again. For example, push  to turn the backlight ON, then push  again to enter a Run command to the drive.

#### 1 : ON

The automatic backlight shut off function is disabled. The backlight will always be ON.



### ■ o1-38: LCD Backlight Off-Delay

No. (Hex.)	Name	Description	Default (Range)
o1-38 (11BB) RUN	LCD Backlight Off-Delay	   Sets the time until the LCD backlight automatically turns off.	60 s (10 - 300 s)

When o1-37 = 0 [LCD Backlight ON/OFF Selection = OFF], the backlight will automatically turn off after the time set in o1-38 expires.

When the backlight is off, push a key on the keypad to temporarily turn the backlight on. After the backlight turns on, it will turn off automatically after the time set in o1-38 is expired.

### ■ o1-39: Show Initial Setup Screen

No. (Hex.)	Name	Description	Default (Range)
o1-39 (11BC) RUN	Show Initial Setup Screen	   Sets the function to show the HOA keypad initial setup screen each time you energize the drive. This parameter is only available on an HOA keypad.	1 (0, 1)

The initial setup screen shows a menu where you can select the display language, set the date, time, and other basic settings. When you set this parameter to 0, the drive will not show this screen each time you energize the drive.



#### 0 : No

The drive will not show the initial setup display screen each time you energize the drive. The drive will show the Home screen.

#### 1 : Yes

When you input the Run command before you energize the drive or when you turn on the Run command while the drive shows the initial setup screen, the drive will replace the initial setup screen with the Home screen.

### ■ o1-40: Home Screen Display Selection

No. (Hex.)	Name	Description	Default (Range)
o1-40 (11BD) RUN	Home Screen Display Selection	   Sets the monitor display mode for the Home screen. This parameter is only available on an HOA keypad.	0 (0 - 3)

**0 : Custom Monitor****1 : Bar Graph****2 : Analog Gauge****3 : Trend Plot****■ o1-41: 1st Monitor Area Selection**

No. (Hex.)	Name	Description	Default (Range)
o1-41 (11C1) RUN	1st Monitor Area Selection	<input type="checkbox"/> V/f <input type="checkbox"/> OLV/PM <input type="checkbox"/> EZOLV Sets the horizontal range used to display the monitor set in o1-24 [Custom Monitor 1] as a bar graph. This parameter is only available on an HOA keypad.	0 (0 - 1)

**0 : +/- Area ( - o1-42 ~ o1-42 )****1 : + Area ( 0 ~ o1-42 )****■ o1-42: 1st Monitor Area Setting**

No. (Hex.)	Name	Description	Default (Range)
o1-42 (11C2) RUN	1st Monitor Area Setting	<input type="checkbox"/> V/f <input type="checkbox"/> OLV/PM <input type="checkbox"/> EZOLV Sets the horizontal axis value used to display the monitor set in o1-24 [Custom Monitor 1] as a bar graph. This parameter is only available on an HOA keypad.	100.0% (0.0 - 100.0%)

**■ o1-43: 2nd Monitor Area Selection**

No. (Hex.)	Name	Description	Default (Range)
o1-43 (11C3) RUN	2nd Monitor Area Selection	<input type="checkbox"/> V/f <input type="checkbox"/> OLV/PM <input type="checkbox"/> EZOLV Selects the horizontal range used to display the monitor set in o1-25 [Custom Monitor 2] as a bar graph. This parameter is only available on an HOA keypad.	0 (0 - 1)

**0 : +/- Area ( - o1-44 ~ o1-44 )****1 : + Area ( 0 ~ o1-44 )****■ o1-44: 2nd Monitor Area Setting**

No. (Hex.)	Name	Description	Default (Range)
o1-44 (11C4) RUN	2nd Monitor Area Setting	<input type="checkbox"/> V/f <input type="checkbox"/> OLV/PM <input type="checkbox"/> EZOLV Sets the horizontal axis value used to display the monitor set in o1-25 [Custom Monitor 2] as a bar graph. This parameter is only available on an HOA keypad.	100.0% (0.0 - 100.0%)

**■ o1-45: 3rd Monitor Area Selection**

No. (Hex.)	Name	Description	Default (Range)
o1-45 (11C5) RUN	3rd Monitor Area Selection	<input type="checkbox"/> V/f <input type="checkbox"/> OLV/PM <input type="checkbox"/> EZOLV Sets the horizontal range used to display the monitor set in o1-26 [Custom Monitor 3] as a bar graph. This parameter is only available on an HOA keypad.	0 (0 - 1)

**0 : +/- Area ( - o1-46 ~ o1-46 )****1 : + Area ( 0 ~ o1-46 )****■ o1-46: 3rd Monitor Area Setting**

No. (Hex.)	Name	Description	Default (Range)
o1-46 (11C6) RUN	3rd Monitor Area Setting	<input type="checkbox"/> V/f <input type="checkbox"/> OLV/PM <input type="checkbox"/> EZOLV Sets the horizontal axis value used to display the monitor set in o1-26 [Custom Monitor 3] as a bar graph. This parameter is only available on an HOA keypad.	100.0% (0.0 - 100.0%)

■ **o1-47: Trend Plot 1 Scale Minimum Value**

No. (Hex.)	Name	Description	Default (Range)
o1-47 (11C7) RUN	Trend Plot 1 Scale Minimum Value	<b>V/f</b> <b>OLV/IPM</b> <b>EZOLV</b> Sets the horizontal axis minimum value used to display the monitor set in o1-24 [Custom Monitor 1] as a trend plot. This parameter is only available on an HOA keypad.	-100.0% (-300.0 - +299.9%)

■ **o1-48: Trend Plot 1 Scale Maximum Value**

No. (Hex.)	Name	Description	Default (Range)
o1-48 (11C8) RUN	Trend Plot 1 Scale Maximum Value	<b>V/f</b> <b>OLV/IPM</b> <b>EZOLV</b> Sets the horizontal axis maximum value used to display the monitor set in o1-24 [Custom Monitor 1] as a trend plot. This parameter is only available on an HOA keypad.	100.0% (-299.9 - +300.0%)

■ **o1-49: Trend Plot 2 Scale Minimum Value**

No. (Hex.)	Name	Description	Default (Range)
o1-49 (11C9) RUN	Trend Plot 2 Scale Minimum Value	<b>V/f</b> <b>OLV/IPM</b> <b>EZOLV</b> Sets the horizontal axis minimum value used to display the monitor set in o1-25 [Custom Monitor 2] as a trend plot. This parameter is only available on an HOA keypad.	-100.0% (-300.0 - +299.9%)

■ **o1-50: Trend Plot 2 Scale Maximum Value**

No. (Hex.)	Name	Description	Default (Range)
o1-50 (11CA) RUN	Trend Plot 2 Scale Maximum Value	<b>V/f</b> <b>OLV/IPM</b> <b>EZOLV</b> Sets the horizontal axis maximum value used to display the monitor set in o1-25 [Custom Monitor 2] as a trend plot. This parameter is only available on an HOA keypad.	100.0% (-299.9 - +300.0%)

■ **o1-51: Trend Plot Time Scale Setting**

No. (Hex.)	Name	Description	Default (Range)
o1-51 (11CB) RUN	Trend Plot Time Scale Setting	<b>V/f</b> <b>OLV/IPM</b> <b>EZOLV</b> Sets the time scale (horizontal axis) to display the trend plot. When you change this setting, the drive automatically adjusts the data sampling time. This parameter is only available on an HOA keypad.	300 s (1 - 3600 s)

■ **o1-55: Analog Gauge Area Selection**

No. (Hex.)	Name	Description	Default (Range)
o1-55 (11EE) RUN	Analog Gauge Area Selection	<b>V/f</b> <b>OLV/IPM</b> <b>EZOLV</b> Sets the range used to display the monitor set in o1-24 [Custom Monitor 1] as an analog gauge. This parameter is only available on an HOA keypad.	1 (0, 1)

0 : +/- Area ( - o1-56 ~ o1-56 )

1 : + Area ( 0 ~ o1-56 )

■ **o1-56: Analog Gauge Area Setting**

No. (Hex.)	Name	Description	Default (Range)
o1-56 (11EF) RUN	Analog Gauge Area Setting	<b>V/f</b> <b>OLV/IPM</b> <b>EZOLV</b> Sets the value used to display the monitor set in o1-24 [Custom Monitor 1] as an analog meter. This parameter is only available on an HOA keypad.	100.0% (0.0 - 100.0%)

### ■ o1-58: Motor Power Unit Selection

No. (Hex.)	Name	Description	Default (Range)
o1-58 (3125)	Motor Power Unit Selection	<b>V/f</b> <b>OLV/PM</b> <b>EZOLV</b> Sets the setting unit for parameters that set the motor rated power.	1 (0, 1)

The drive shows these parameter values in the set units:

- E2-11 [Motor Rated Power]
- E4-11 [Motor 2 Rated Power]
- E5-02 [PM Motor Rated Power]
- E9-07 [Motor Rated Power]
- T1-02 [Motor Rated Power]
- T2-04 [PM Motor Rated Power]
- T4-08 [Motor Rated Capacity]

#### 0 : kW

Shows the motor output in kW units.

#### 1 : HP

Shows the motor output in HP units.

### ■ o1-80: Fault Screen Display

No. (Hex.)	Name	Description	Default (Range)
o1-80 (31BA)	Fault Screen Display	<b>V/f</b> <b>OLV/PM</b> <b>EZOLV</b> Sets a full-screen display message to show on the keypad when a fault or CPF occurs.	1 (0, 1)

#### 0 : OFF

#### 1 : ON

### ■ o1-81: Alarm Screen Display

No. (Hex.)	Name	Description	Default (Range)
o1-81 (31BB)	Alarm Screen Display	<b>V/f</b> <b>OLV/PM</b> <b>EZOLV</b> Sets a full-screen display message to show on the keypad when an alarm occurs.	0 (0, 1)

#### 0 : OFF

#### 1 : ON

### ■ o1-82: Message Screen Display

No. (Hex.)	Name	Description	Default (Range)
o1-82 (31BC)	Message Screen Display	<b>V/f</b> <b>OLV/PM</b> <b>EZOLV</b> Sets a full-screen display message to show on the keypad when a status message is active.	0 (0, 1)

#### 0 : OFF

#### 1 : ON

## ◆ o2: Keypad Operation

### ■ o2-02: OFF Key Function Selection

No. (Hex.)	Name	Description	Default (Range)
o2-02 (0506)	OFF Key Function Selection	<div style="display: flex; justify-content: space-between; align-items: center;"> <span>V/f</span> <span>OLV/PM</span> <span>EZOLV</span> </div> <p>Sets the function to use  on the keypad to stop the drive when the Run command source for the drive is REMOTE (external) and not assigned to the keypad.</p>	1 (0, 1)

**0 : Disabled**

**1 : Enabled**

stays enabled when the Run command source is not assigned to the keypad.

To start the drive again after you push to stop operation, turn the external Run command OFF and ON again.

### ■ o2-03: User Parameter Default Value

No. (Hex.)	Name	Description	Default (Range)
o2-03 (0507)	User Parameter Default Value	<div style="display: flex; justify-content: space-between; align-items: center;"> <span>V/f</span> <span>OLV/PM</span> <span>EZOLV</span> </div> <p>Sets the function to keep the settings of changed parameters as user parameter defaults to use during initialization.</p>	0 (0 - 2)

When you set  $o2-03 = 1$  [Set defaults], the drive saves changed parameter settings as user parameter setting values in a part of the memory that is isolated from drive parameters.

When you set  $A1-03 = 1110$  [Initialize Parameters = User Initialization] to initialize the drive, the drive resets the internal parameter setting values to those user parameter setting values.

**0 : No change**

**1 : Set defaults**

Saves changed parameter setting values as user default settings.

Set  $o2-03 = 1$  then push to save the user parameter setting values. After the drive saves the setting value,  $o2-03$  automatically resets to 0.

**2 : Clear all**

Deletes all of the saved user parameter setting values.

Set  $o2-03 = 2$  then push to clear the user parameter setting values. The drive will automatically reset  $o2-03$  to 0. If you delete the user parameter setting values, you cannot set  $A1-03 = 1110$  to initialize parameters.

### ■ o2-04: Drive Model (KVA) Selection

No. (Hex.)	Name	Description	Default (Range)
o2-04 (0508)	Drive Model (KVA) Selection	<div style="display: flex; justify-content: space-between; align-items: center;"> <span>V/f</span> <span>OLV/PM</span> <span>EZOLV</span> </div> <p>Sets the Drive Model code. Set this parameter after you replace the control board.</p>	Determined by the drive (-)

**NOTICE:** Set  $o2-04$  [Drive Model (KVA) Selection] correctly. If you set this parameter incorrectly, it will decrease drive performance, cause the protection function to operate incorrectly, and cause damage to the drive.

**Note:**

When the setting value of  $o2-04$  changes, related parameter setting values also change. Refer to [Defaults by o2-04 \[Drive Model \(kVA\) Selection\] on page 600](#) for more information.

These tables list the relation between  $o2-04$  setting values and drive models.

o2-04 Setting	Drive Model
65	2011
67	2017

o2-04 Setting	Drive Model
68	2024
6A	2031



o2-04 Setting	Drive Model
6B	2046
6D	2059
6E	2075
6F	2088
70	2114
72	2143
73	2169
74	2211
75	2273
95	4005
97	4008xF
99	4011
9A	4014
9B	4021

o2-04 Setting	Drive Model
9D	4027
9E	4034
9F	4040
A0	4052
A2	4065
A3	4077
A4	4096
A5	4124
A6	4156
A7	4180
A8	4240
A9	4302
BB	4008xV, 4008xT



### ■ o2-05: Home Mode Freq Ref Entry Mode

No. (Hex.)	Name	Description	Default (Setting Range)
o2-05 (0509)	Home Mode Freq Ref Entry Mode	<div style="display: flex; align-items: center;"> <span style="margin-right: 5px;">V/f</span> <span style="margin-right: 5px;">OLV/PM</span> <span style="margin-right: 5px;">EZOLV</span> </div> <p>Sets the function that makes it necessary to push  to use the keypad to change the frequency reference value while in Drive Mode.</p>	0 (0, 1)

#### 0 : ENTER Key Required

You must push  to use the keypad to change the frequency reference value.

#### 1 : Immediate / MOP-style

The frequency reference changes when you enter it with the keypad. This then changes the output frequency. It is not necessary to push . The drive keeps the frequency reference for 5 seconds after you use  and  on the keypad to change the frequency reference value.

### ■ o2-06: Keypad Disconnect Detection

No. (Hex.)	Name	Description	Default (Range)
o2-06 (050A)	Keypad Disconnect Detection	<div style="display: flex; align-items: center;"> <span style="margin-right: 5px;">V/f</span> <span style="margin-right: 5px;">OLV/PM</span> <span style="margin-right: 5px;">EZOLV</span> </div> <p>Sets the function that stops the drive if you disconnect the keypad connection cable from the drive or if you damage the cable while the keypad is the Run command source.</p>	1 (0, 1)

If the keypad installed to the drive is disconnected, this parameter will continue to operate.

This parameter is enabled in these conditions:

- $b1-02 = 0$  [Run Command Selection 1 = Keypad]
- In HAND Mode

#### 0 : Disabled

The drive continues operation if it detects a keypad disconnection.

#### 1 : Enabled

When the drive detects a keypad disconnection, the drive detects  $oPr$  [Keypad Connection Fault], and stops operation. The motor coasts to stop.

### ■ o2-09: Reserved

No. (Hex.)	Name	Description	Default (Range)
o2-09 (050D)	Reserved	-	-

### ■ o2-19: Parameter Write during Uv

No. (Hex.)	Name	Description	Default (Range)
o2-19 (061F)	Parameter Write during Uv	<div style="display: flex; align-items: center;"> <span style="border: 1px solid black; padding: 2px;">V/f</span> <span style="border: 1px solid black; padding: 2px; margin-left: 5px;">OLV/IPM</span> <span style="border: 1px solid black; padding: 2px; margin-left: 5px;">EZOLV</span> </div> Enables and disables the function to change parameter settings during a Uv [DC Bus Undervoltage] condition.	0 (0, 1)

**0 : Disabled**

**1 : Enabled**

### ■ o2-23: External 24V Powerloss Detection

No. (Hex.)	Name	Description	Default (Setting Range)
o2-23 (11F8) RUN	External 24V Powerloss Detection	<div style="display: flex; align-items: center;"> <span style="border: 1px solid black; padding: 2px;">V/f</span> <span style="border: 1px solid black; padding: 2px; margin-left: 5px;">OLV/IPM</span> <span style="border: 1px solid black; padding: 2px; margin-left: 5px;">EZOLV</span> </div> Sets the function to give a warning if the backup external 24 V power supply turns off when the main circuit power supply is in operation.	0 (0, 1)

**Note:**

The drive will not run when it is operating from one 24-V external power supply.

**0 : Disabled**

The drive does not detect the loss of the 24-V external power supply.

**1 : Enabled**

The keypad shows the *L24v [Loss of External Power 24 Supply]* indicator if the drive detects the loss of the 24-V external power supply.

**Note:**

A minor fault signal is not output from  $H2-xx = 10$  [MFDO Function Selection = Alarm].

### ■ o2-24: LED Light Function Selection

No. (Hex.)	Name	Description	Default (Range)
o2-24 (11FE)	LED Light Function Selection	<div style="display: flex; align-items: center;"> <span style="border: 1px solid black; padding: 2px;">V/f</span> <span style="border: 1px solid black; padding: 2px; margin-left: 5px;">OLV/IPM</span> <span style="border: 1px solid black; padding: 2px; margin-left: 5px;">EZOLV</span> </div> Sets the function to show the LED status rings and keypad LED lamps.	2 (0 - 2)

**Note:**

When you use *A1-03 [Initialize Parameters]* to initialize the drive, the drive will not reset this parameter.

**0 : Enable Status Ring & Keypad LED**

**1 : LED Status Ring Disable**

**2 : Keypad LED Light Disable**

### ■ o2-26: Alarm Display at Ext. 24V Power

No. (Hex.)	Name	Description	Default (Range)
o2-26 (1563)	Alarm Display at Ext. 24V Power	<div style="display: flex; align-items: center;"> <span style="border: 1px solid black; padding: 2px;">V/f</span> <span style="border: 1px solid black; padding: 2px; margin-left: 5px;">OLV/IPM</span> <span style="border: 1px solid black; padding: 2px; margin-left: 5px;">EZOLV</span> </div> When you connect a backup external 24 V power supply, this parameter sets the function to trigger an alarm when the main circuit power supply voltage decreases.	1 (0, 1)

**0 : Disabled**

The drive will not detect *EP24v [External Power 24V Supply]* if the main circuit power supply voltage decreases. The [Ready] light on the LED Status Ring flashes quickly to identify that drive operation is not possible.

**1 : Enabled**

The drive detects *EP24v* when the main circuit power supply voltage decreases.

**Note:**

A minor fault signal is not output from  $H2-xx = 10$  [*MFDO Function Selection = Alarm*].

**■ o2-27: bCE Detection Selection**

No. (Hex.)	Name	Description	Default (Range)
o2-27 (1565)	bCE Detection Selection	<input type="checkbox"/> V/f <input type="checkbox"/> OLV/PM <input type="checkbox"/> EZOLV Sets drive operation if the Bluetooth device is disconnected when you operate the drive in Bluetooth Mode.	3 (0 - 4)

**0 : Ramp to Stop****1 : Coast to Stop****2 : Fast Stop (Use C1-09)****3 : Alarm Only****4 : No Alarm Display****◆ o3: Copy Function**

*o3 parameters* set the operation of the parameter backup function.

**■ o3-01: Copy Keypad Function Selection**

No. (Hex.)	Name	Description	Default (Range)
o3-01 (0515)	Copy Keypad Function Selection	<input type="checkbox"/> V/f <input type="checkbox"/> OLV/PM <input type="checkbox"/> EZOLV Sets the function that saves and copies drive parameters to a different drive with the keypad.	0 (0 - 4)

**0 : Copy Select****1 : Backup (drive → keypad)**

The parameter setting values are read from the drive and saved in the keypad.

**2 : Restore (keypad → drive)**

Copies the parameter setting values saved in the keypad to a different drive.

**3 : Verify (check for mismatch)**

Makes sure that the parameter setting values in the drive agree with the parameters saved in the keypad.

**4 : Erase (backup data of keypad)**

Deletes the parameter setting values saved in the keypad.

**■ o3-02: Copy Allowed Selection**

No. (Hex.)	Name	Description	Default (Range)
o3-02 (0516)	Copy Allowed Selection	<input type="checkbox"/> V/f <input type="checkbox"/> OLV/PM <input type="checkbox"/> EZOLV Sets the copy function when $o3-01 = 1$ [ <i>Copy Keypad Function Selection = Backup (drive → keypad)</i> ].	0 (0, 1)

**Note:**

When you select [Parameter Backup] on the keypad menu screen to do the backup function, the drive automatically sets  $o3-02 = 1$ .

**0 : Disabled****1 : Enabled**

### ■ o3-04: Select Backup/Restore Location

No. (Hex.)	Name	Description	Default (Range)
o3-04 (0B3E)	Select Backup/Restore Location	<div style="display: flex; gap: 5px;"> <span style="border: 1px solid black; padding: 2px;">V/f</span> <span style="border: 1px solid black; padding: 2px;">OLV/PM</span> <span style="border: 1px solid black; padding: 2px;">EZOLV</span> </div> Sets the storage location for drive parameters when you back up and restore parameters. This parameter is only available on an HOA keypad.	0 (0 - 3)

You can use the HOA keypad to make a maximum of 4 parameter backup sets.

#### 0 : Memory Location 1

#### 1 : Memory Location 2

#### 2 : Memory Location 3

#### 3 : Memory Location 4

### ■ o3-05: Select Items to Backup/Restore

No. (Hex.)	Name	Description	Default (Range)
o3-05 (0BDA)	Select Items to Backup/Restore	<div style="display: flex; gap: 5px;"> <span style="border: 1px solid black; padding: 2px;">V/f</span> <span style="border: 1px solid black; padding: 2px;">OLV/PM</span> <span style="border: 1px solid black; padding: 2px;">EZOLV</span> </div> Sets which parameters the drive backs up, restores, and references. This parameter is only available on an HOA keypad.	1 (0, 1)

#### 0 : Standard Parameters

#### 1 : Standard + DWEZ Parameters

##### Note:

- Parameters *qx-xx* [DriveWorksEZ Parameters] and *rx-xx* [DriveWorksEZ Connections] show when *A1-07 = 1 or 2* [DriveWorksEZ Function Selection = DWEZ Enabled or Enabled/Disabled wDigital Input].
- The password for DriveWorksEZ PC software is necessary to back up *qx-xx* and *rx-xx*. If you enter an incorrect password, the drive detects *PWEr* [DWEZ Password Mismatch].

### ■ o3-06: Auto Parameter Backup Selection

No. (Hex.)	Name	Description	Default (Range)
o3-06 (0BDE)	Auto Parameter Backup Selection	<div style="display: flex; gap: 5px;"> <span style="border: 1px solid black; padding: 2px;">V/f</span> <span style="border: 1px solid black; padding: 2px;">OLV/PM</span> <span style="border: 1px solid black; padding: 2px;">EZOLV</span> </div> Sets the function that automatically backs up parameters. This parameter is only available on an HOA keypad.	1 (0, 1)

When you connect the drive and keypad, the drive will automatically back up drive parameters to the keypad as specified by *o3-06* and *o3-07*.

#### 0 : Disabled

#### 1 : Enabled

##### Note:

When you replace the HOA keypad then energize the drive, the keypad automatically shows the restore operation screen to restore the drive configuration with the parameters backed up to the HOA keypad. If you connect an HOA keypad that does not have parameter backup data, the keypad will not show the restore operation screen.

### ■ o3-07: Auto Parameter Backup Interval

No. (Hex.)	Name	Description	Default (Range)
o3-07 (0BDF)	Auto Parameter Backup Interval	<div style="display: flex; gap: 5px;"> <span style="border: 1px solid black; padding: 2px;">V/f</span> <span style="border: 1px solid black; padding: 2px;">OLV/PM</span> <span style="border: 1px solid black; padding: 2px;">EZOLV</span> </div> Sets the interval at which the automatic parameter backup function saves parameters from the drive to the keypad.	1 (0 - 3)

The drive saves parameter settings to the keypad at these times:

- After you energize the drive and the auto backup period passes.
- When you use ROM enter or the keypad to change parameters, the drive saves those changes in the drive, waits for the auto backup period to pass, then saves those parameters in the keypad.

**Note:**

The drive can write data to the keypad a maximum of 100,000 times. If you write data to the keypad more than 100,000 times, you must replace the keypad.

**0 : Every 10 minutes**

**1 : Every 30 minutes**

**2 : Every 60 minutes**

**3 : Every 12 hours**

## ◆ o4: Maintenance Mon Settings

*o4 parameters* set the expected service life to help you know when to replace parts. The drive will show an alarm to tell you when the replacement part interval is near.

### ■ o4-01: Elapsed Operating Time Setting

No. (Hex.)	Name	Description	Default (Range)
o4-01 (050B)	Elapsed Operating Time Setting	<input type="checkbox"/> V/f <input type="checkbox"/> OL/PM <input type="checkbox"/> EZOLV Sets the initial value of the cumulative drive operation time in 10-hour units.	0 h (0 - 9999 h)

When you select *o4-01* on the keypad, it will show the current value of *U4-01* in units of 10 hours (h). When you change the setting of *o4-01* through the monitor, the *U4-01* count starts again as specified by the setting of *o4-01*.

**Note:**

Set this parameter in 10-hour (h) units. When *o4-01* = 30, *U4-01* [Cumulative Ope Time] = 300 h.

### ■ o4-02: Elapsed Operating Time Selection

No. (Hex.)	Name	Description	Default (Range)
o4-02 (050C)	Elapsed Operating Time Selection	<input type="checkbox"/> V/f <input type="checkbox"/> OL/PM <input type="checkbox"/> EZOLV Sets the condition that counts the cumulative operation time.	1 (0, 1)

### 0 : U4-01 Shows Total Power-up Time

Counts the time from when you energize drive to when you de-energize the drive.

### 1 : U4-01 Shows Total RUN Time

Counts the time that the drive outputs voltage.

### ■ o4-03: Fan Operation Time Setting

No. (Hex.)	Name	Description	Default (Range)
o4-03 (050E)	Fan Operation Time Setting	<input type="checkbox"/> V/f <input type="checkbox"/> OL/PM <input type="checkbox"/> EZOLV Sets the value from which to start the cumulative drive cooling fan operation time in 10-hour units.	0 h (0 - 9999 h)

Use monitor *U4-03* [Cooling Fan Ope Time] to view the total operation time of the cooling fan. When you replace a cooling fan, set *o4-03* = 0 to reset *U4-03*. Select *o4-03* on the keypad to show the current value of *U4-03* in 10-hour (h) units. If you use the monitor to change *o4-03*, the recount of *U4-03* starts with the *o4-03* setting.

**Note:**

The drive sets *o4-03* in 10-hour (h) units. When *o4-03* = 30, *U4-03* [Cooling Fan Ope Time] will show "300 h".

### ■ o4-05: Capacitor Maintenance Setting

No. (Hex.)	Name	Description	Default (Range)
o4-05 (051D)	Capacitor Maintenance Setting	<input type="checkbox"/> V/f <input type="checkbox"/> OL/PM <input type="checkbox"/> EZOLV Sets the <i>U4-05</i> [Capacitor Maintenance] monitor value.	0% (0 - 150%)

When you replace a drive, set *o4-05* = 0 to reset *U4-05*. When the *o4-05* setting changes, the count of *U4-05* starts again as specified by the setting of *o4-05*. After you complete the configuration, *o4-05* automatically resets to 0.

**Note:**

The maintenance period changes for different operating environments.

■ **o4-07: Softcharge Relay Maintenance Set**

No. (Hex.)	Name	Description	Default (Range)
o4-07 (0523)	Softcharge Relay Maintenance Set	<input type="checkbox"/> V/f <input type="checkbox"/> OLV/IPM <input type="checkbox"/> EZOLV Sets the U4-06 [PreChargeRelayMainte] monitor value.	0% (0 - 150%)

When you replace a drive, set o4-07 = 0 to reset U4-06. When the o4-07 setting changes, the count of U4-06 starts again as specified by the setting of o4-07. After you complete the configuration, o4-07 automatically resets to 0.

**Note:**

The maintenance period changes for different operating environments.

■ **o4-09: IGBT Maintenance Setting**

No. (Hex.)	Name	Description	Default (Range)
o4-09 (0525)	IGBT Maintenance Setting	<input type="checkbox"/> V/f <input type="checkbox"/> OLV/IPM <input type="checkbox"/> EZOLV Sets the U4-07 [IGBT Maintenance] monitor value.	0% (0 - 150%)

When you replace a drive, set o4-09 = 0 to reset U4-07. When the o4-09 setting changes, the count of U4-07 starts again as specified by the setting of o4-09. After you complete the configuration, o4-09 automatically resets to 0.

**Note:**

The maintenance period changes for different operating environments.

■ **o4-11: Fault Trace/History Init (U2/U3)**

No. (Hex.)	Name	Description	Default (Range)
o4-11 (0510)	Fault Trace/History Init (U2/U3)	<input type="checkbox"/> V/f <input type="checkbox"/> OLV/IPM <input type="checkbox"/> EZOLV Resets the records of Monitors U2-xx [Fault Trace] and U3-xx [Fault History].	0 (0, 1)

**Note:**

When you initialize the drive with A1-03 [Initialize Parameters], the drive will not reset the records for U2-xx and U3-xx.

**0 : Disabled**

Keeps the records of Monitors U2-xx and U3-xx.

**1 : Enabled**

Resets the records for Monitors U2-xx and U3-xx. After the reset, the drive automatically resets o4-11 to 0.

■ **o4-12: kWh Monitor Initialization**

No. (Hex.)	Name	Description	Default (Range)
o4-12 (0512)	kWh Monitor Initialization	<input type="checkbox"/> V/f <input type="checkbox"/> OLV/IPM <input type="checkbox"/> EZOLV Resets the monitor values for U4-10 [kWh, Lower 4 Digits] and U4-11 [kWh, Upper 5 Digits].	0 (0, 1)

**Note:**

When you initialize the drive with A1-03 [Initialize Parameters], the drive will not reset U4-10 and U4-11.

**0 : No Reset**

Keeps the monitor values for U4-10 and U4-11.

**1 : Reset**

Resets the values of U4-10 and U4-11. After the reset, the drive automatically resets o4-12 to 0.

### ■ o4-13: RUN Command Counter @ Initialize

No. (Hex.)	Name	Description	Default (Range)
o4-13 (0528)	RUN Command Counter @ Initialize	<b>V/f</b> <b>OLV/PM</b> <b>EZOLV</b> Resets the monitor values for U4-02 [Num of Run Commands], U4-24 [Number of Runs (Low)], and U4-25 [Number of Runs (High)].	0 (0, 1)

#### 0 : No Reset

Keeps the monitor values for U4-02, U4-24, and U4-25.

#### 1 : Reset

Resets the values of U4-02, U4-24, and U4-25. After the reset, the drive automatically resets o4-13 to 0.

### ■ o4-22: Time Format

No. (Hex.)	Name	Description	Default (Range)
o4-22 (154F) RUN	Time Format	<b>V/f</b> <b>OLV/PM</b> <b>EZOLV</b> Sets the time display format. This parameter is only available on an HOA keypad.	1 (0 - 2)

Sets the display of the time shown in the upper-left of the HOA keypad screen.

#### 0 : 24 Hour Clock

#### 1 : 12 Hour Clock

#### 2 : 12 Hour JP Clock

### ■ o4-23: Date Format

No. (Hex.)	Name	Description	Default (Range)
o4-23 (1550) RUN	Date Format	<b>V/f</b> <b>OLV/PM</b> <b>EZOLV</b> Sets the date display format. This parameter is only available on an HOA keypad.	2 (0 - 2)

Sets the date format that the drive uses for the fault history and other records.

#### 0 : YYYY/MM/DD

#### 1 : DD/MM/YYYY

#### 2 : MM/DD/YYYY

#### Note:

The Fault History in the Monitor Mode shows when faults occurred. Refer to [Show Fault History on page 171](#) for more information.

### ■ o4-24: bAT Detection Selection

No. (Hex.)	Name	Description	Default (Range)
o4-24 (310F) RUN	bAT Detection Selection	<b>V/f</b> <b>OLV/PM</b> <b>EZOLV</b> Sets operation when the drive detects bAT [Keypad Battery Low Voltage] and TiM [Keypad Time Not Set].	0 (0 - 2)

#### 0 : Disable

The drive will not detect bAT or TiM.

#### 1 : Enable (Alarm Detected)

TiM or bAT shows on the keypad, and operation continues. The output terminal set for Alarm [H2-01 to H2-03 = 10] activates.

#### 2 : Enable (Fault Detected)

The drive output shuts off and the motor coasts to stop. Fault relay output terminal MA-MC activates, and MB-MC deactivates.

## ◆ o5: Log Function

The data log function saves drive status information as a CSV file in the microSD memory card in the keypad. *Monitors Ux-xx* are the source of data log information. You can record a maximum of 10 monitors.

Change the HOA keypad screen from the main menu to the Diagnostic Tools screen and select the data log function. Set the number of the monitor to record and the sampling time, then start to record the data log.

**Table 12.66 Setting Parameters for Data Log Items**

No.	Name	Default	Data Log Monitors
o5-03	Log Monitor Data 1	101	U1-01 [Frequency Reference]
o5-04	Log Monitor Data 2	102	U1-02 [Output Frequency]
o5-05	Log Monitor Data 3	103	U1-03 [Output Current]
o5-06	Log Monitor Data 4	107	U1-07 [DC Bus Voltage]
o5-07	Log Monitor Data 5	108	U1-08 [Output Power]
o5-08	Log Monitor Data 6	<ul style="list-style-type: none"> <li>• A1-02 = 0, 5 [Control Method Selection = V/f, OLV/PM]: 000</li> <li>• A1-02 = 8 [EZOLV]: 105</li> </ul>	<ul style="list-style-type: none"> <li>• A1-02 = 0, 5: Not selected</li> <li>• A1-02 = 8: U1-05 [Motor Speed]</li> </ul>
o5-09	Log Monitor Data 7	110	U1-10 [Input Terminal Status]
o5-10	Log Monitor Data 8	112	U1-12 [Drive Status]
o5-11	Log Monitor Data 9	000	Not selected
o5-12	Log Monitor Data 10	000	Not selected

### Note:

- Do not de-energize the drive or disconnect the keypad from the drive during log transfer communication. A loss of connection can cause the log function to fail after you restore power or connect the keypad.
- You can use a microSDHC card that has a maximum of 32 GB capacity.

## ■ Log File Specifications

Item	Specification
File storage location	A folder called [Log_File] is created in the root directory of the microSD card.
Filename	GLOG0xxx.csv <b>Note:</b> [xxx] identifies a 3-digit decimal number
Maximum number of files	999 (GLOG0001.csv to GLOG0999.csv)
Character code	ASCII code
Line break code	<CR><LF>
Separating character	[ , ] (Commas)
Header rows	First Row: Drive information including the drive model, software version, control method, and sampling time Second Row: Log data information including the monitor number, number decimal points, and unit code

## ■ Log File Configuration

The [Log\_Files] folder is created in the root directory of the micro SD card. This is where the log data is stored as CSV files. Log data files are created in this configuration. The number of rows changes when the number of selected monitors change.

First row	Drive information
Second row	Log data information
Third row	Log data 1
:	Log data 2
:	Log data 3
:	:
Last row	Log data n





## 12.11 o: Keypad-Related Settings

Unit Code (Hex.)	Unit	Unit Code (Hex.)	Unit	Unit Code (Hex.)	Unit	Unit Code (Hex.)	Unit
02	RPM	0A	Ω	12	us	1A	–
03	%	0B	ms	13	min	1B	–
04	VAC	0C	kHz	14	°C	1C	–
05	VDC	0D	PSI	15	W	1D	–
06	A	0E	MPM	16	kWH	1E	–
07	sec	0F	FPM	17	MWH	1F	–

### Third and Subsequent Rows: Log Data



This example shows the data text strings and data generated for the third row of log data.

Example of generated data:

02,0012,160107111239,1770,1770,00BE,0118,0028,0000,0000,0000,0000,0000,0000,0000C

No.	Item	Number of Characters	Description
1	Attribute	2	[02] shows that the record is a monitor data record.
2	File number	4	The [xxx] part of the [GLOG0xxx.csv] filename is a 3-digit decimal number in hexadecimal format.
3	Time stamp	12	Data log data was retrieved (YYMMDDHHMMSS)
4	Log Monitor Data 1	4	Monitor number selected by o5-03 [Log Monitor Data 1]
5	Log Monitor Data 2	4	Monitor number selected by o5-04 [Log Monitor Data 2]
:	:	:	:
13	Log Monitor Data 10	4	Monitor number selected by o5-12 [Log Monitor Data 10]
14	Reserved	4	-
15	Encoding data	4	Encoding data for log monitor data 1 to 10 (Hex.) Bits 0 to 9 show the encoding of log monitor data 1 to 10. A bit value of 1 shows that the data represents a negative value. (Log monitor data 1 to 10 are absolute value data without encoding) Example when log monitor data 2, 5, and 8 show negative values: Bits 1, 4, and 7 have values of 1, and the encoding data = 0010010010 (Bin.) = 0092 (Hex.)
16	File number	6	Row number (Hex.) in the data log file

### ■ o5-01: Log Start/Stop Selection

No. (Hex.)	Name	Description	Default (Range)
o5-01 (1551) RUN	Log Start/Stop Selection	   Sets the data log function. This parameter is only available on an HOA keypad.	0 (0 - 1)



#### 0 : OFF

Stops the data log.



#### 1 : ON

Starts the data log as specified by the sampling cycle set in o5-02 [Log Sampling Interval].

### ■ o5-02: Log Sampling Interval

No. (Hex.)	Name	Description	Default (Range)
o5-02 (1552) RUN	Log Sampling Interval	   Sets the data log sampling cycle. This parameter is only available on an HOA keypad.	100 ms (100 - 60000 ms)

### ■ o5-03: Log Monitor Data 1



No. (Hex.)	Name	Description	Default (Range)
o5-03 (1553) RUN	Log Monitor Data 1	   Sets the data log monitor. This parameter is only available on an HOA keypad.	101 (000, 101 - 1299)

**Note:**

Set the *U monitor* number you want to log.

For example, to display *U1-01 [Frequency Reference]*, set *o5-03 = 101*. When it is not necessary to set a data log monitor, set this parameter to *000*.

### ■ o5-04: Log Monitor Data 2



No. (Hex.)	Name	Description	Default (Range)
o5-04 (1554) RUN	Log Monitor Data 2	   Sets the data log monitor. This parameter is only available on an HOA keypad.	102 (000, 101 - 1299)

**Note:**

Set the *U monitor* number you will log.

For example, to show *U1-02 [Output Frequency]*, set *o5-04 = 102*. When it is not necessary to set data log monitor, set this parameter to *000*.

### ■ o5-05: Log Monitor Data 3



No. (Hex.)	Name	Description	Default (Range)
o5-05 (1555) RUN	Log Monitor Data 3	   Sets the data log monitor. This parameter is only available on an HOA keypad.	103 (000, 101 - 1299)

**Note:**

Set the *U monitor* number you want to log.

For example, to show *U1-03 [Output Current]*, set *o5-05 = 103*. When it is not necessary to set a data log monitor, set this parameter to *000*.

### ■ o5-06: Log Monitor Data 4



No. (Hex.)	Name	Description	Default (Range)
o5-06 (1556) RUN	Log Monitor Data 4	   Sets the data log monitor. This parameter is only available on an HOA keypad.	107 (000, 101 - 1299)

**Note:**

Set the *U monitor* number you want to log.

For example, to show *U1-07 [DC Bus Voltage]*, set *o5-06 = 107*. When it is not necessary to set a data log monitor, set this parameter to *000*.

### ■ o5-07: Log Monitor Data 5



No. (Hex.)	Name	Description	Default (Range)
o5-07 (1557) RUN	Log Monitor Data 5	   Sets the data log monitor. This parameter is only available on an HOA keypad.	108 (000, 101 - 1299)

**Note:**

Set the *U monitor* number you want to log.

For example, to show *U1-08 [Output Power]*, set *o5-07 = 108*. When it is not necessary to set a data log monitor, set this parameter to *000*.



### ■ o5-08: Log Monitor Data 6

No. (Hex.)	Name	Description	Default (Setting Range)
o5-08 (1558) RUN	Log Monitor Data 6	   Sets the data log monitor. This parameter is only available on an HOA keypad.	105 (000, 101 - 1299)

**Note:**

- When  $A1-02 = 0$  or  $5$  [Control Method Selection = *V/f*, *OLV/PM*], the default setting is  $0$ .
- Set the *U monitor* number you want to log.  
For example, to display *U1-01* [Frequency Reference], set  $o5-08 = 101$ . When it is not necessary to set a data log monitor, set this parameter to  $000$ .

### ■ o5-09: Log Monitor Data 7



No. (Hex.)	Name	Description	Default (Range)
o5-09 (1559) RUN	Log Monitor Data 7	   Sets the data log monitor. This parameter is only available on an HOA keypad.	110 (000, 101 - 1299)

**Note:**

Set the *U monitor* number you will log.

For example, to show *U1-01* [Frequency Reference], set  $o5-09 = 101$ . When it is not necessary to set data log monitor, set this parameter to  $000$ .

### ■ o5-10: Log Monitor Data 8



No. (Hex.)	Name	Description	Default (Range)
o5-10 (155A) RUN	Log Monitor Data 8	   Sets the data log monitor. This parameter is only available on an HOA keypad.	112 (000, 101 - 1299)

**Note:**

Set the *U monitor* number you want to log.

For example, to display *U1-01* [Frequency Reference], set  $o5-10 = 101$ . When it is not necessary to set a data log monitor, set this parameter to  $000$ .

### ■ o5-11: Log Monitor Data 9



No. (Hex.)	Name	Description	Default (Range)
o5-11 (155B) RUN	Log Monitor Data 9	   Sets the data log monitor. This parameter is only available on an HOA keypad.	000 (000, 101 - 1299)

**Note:**

Set the *U monitor* number you want to log.

For example, to display *U1-01* [Frequency Reference], set  $o5-11 = 101$ . When it is not necessary to set a data log monitor, set this parameter to  $000$ .

### ■ o5-12: Log Monitor Data 10

No. (Hex.)	Name	Description	Default (Range)
o5-12 (155C) RUN	Log Monitor Data 10	   Sets the data log monitor. This parameter is only available on an HOA keypad.	000 (000, 101 - 1299)

**Note:**

Set the *U monitor* number you want to log.

For example, to display *U1-01 [Frequency Reference]*, set *o5-12 = 101*. When it is not necessary to set a data log monitor, set this parameter to *000*.

## 12.12 S: Special Applications

*S* parameters set these functions:

- Dynamic Noise Control
- Sequence Run Timers
- PI2 Control
- HAND/OFF/AUTO Mode Operation
- Emergency Override Function

### ◆ S1: Dynamic Noise Control

The Dynamic Audible Noise Control Function suppresses the output voltage to decrease audible noise.

This function is available when  $A1-02 = 0$  [Control Method Selection = V/f] and can help you quickly restore output voltage after an impact caused a sudden increase in the time constant. Dynamic Audible Noise Control is useful in applications where load impact is common. You cannot use  $b8-01 = 1$  [Energy Saving Control Selection = Enabled] and  $S1-01 = 1$  [Dynamic Noise Control = Enabled] at the same time.

#### ■ Set Parameters for Dynamic Noise Control

1. Set  $S1-01 = 1$  [Dynamic Noise Control = Enabled] to enable Dynamic Noise Control.

**Note:**

- When  $S1-01 = 1$ , the tolerance to an impact load will decrease compared to V/f Control without Energy Saving.
- You must disable Dynamic Noise Control for applications without an impact load.

The current level increases from the added load and improves the drive responsiveness.

2. Increase  $S1-02$  [Voltage Reduction Rate] to make the flux stronger and increase the torque.

**Note:**

The Dynamic Noise Control function will decrease the load movement to a minimum level.

3. Decrease  $S1-03$  [Voltage Restoration Level] and  $S1-04$  [Voltage Restoration Off Level] to recover the voltage more quickly during the impact load conditions.

**Note:**

Under certain conditions, voltage stability may be unsatisfactory.

4. Decrease  $S1-05$  [Volt Restore Sensitivity Time K] to decrease the voltage level and increase the voltage restoration speed when the load increase.
5. Decrease  $S1-06$  [Volt Restore Impact Load Time K] to increase drive response to an impact load.

When the output voltage is unstable, increase these values to decrease the load response:

- Difference between  $S1-03$  and  $S1-04$
- $S1-05$
- $S1-06$

#### ■ S1-01: Dynamic Noise Control

No. (Hex.)	Name	Description	Default (Range)
S1-01 (3200)	Dynamic Noise Control	<div style="display: flex; gap: 5px;"> <span style="background-color: #ccc; padding: 2px;">V/f</span> <span style="background-color: #ccc; padding: 2px;">OLV/PM</span> <span style="background-color: #ccc; padding: 2px;">EZOLV</span> </div> Sets the function that decreases the output voltage in variable torque applications to decrease audible noise.	1 (0, 1)

**0 : Disabled**

**1 : Enabled**

### ■ S1-02: Voltage Reduction Rate

No. (Hex.)	Name	Description	Default (Range)
S1-02 (3201)	Voltage Reduction Rate	<b>V/f</b> <b>OLV/PM</b> <b>EZOLV</b> Sets the rate at which the drive will decrease the output voltage as a percentage of the V/f pattern when operating with no load.	50.0% (50.0 - 100.0%)

### ■ S1-03: Voltage Restoration Level

No. (Hex.)	Name	Description	Default (Range)
S1-03 (3202)	Voltage Restoration Level	<b>V/f</b> <b>OLV/PM</b> <b>EZOLV</b> Sets the level at which the drive will start to restore the voltage as a percentage of the drive rated torque.	20.0% (0.0 - 90.0%)

### ■ S1-04: Voltage Restoration Off Level

No. (Hex.)	Name	Description	Default (Range)
S1-04 (3203)	Voltage Restoration Off Level	<b>V/f</b> <b>OLV/PM</b> <b>EZOLV</b> Sets the level at which voltage restoration for the V/f pattern is complete as a percentage of the drive rated torque. If the output is more than S1-04, the drive will control the voltage as specified by the V/f pattern setting.	50.0% (10.0 - 100.0%)

**Note:**

The lower limit of this parameter is the value of S1-03 [Voltage Restoration Level] + 10.0%.

### ■ S1-05: Volt Restore Sensitivity Time K

No. (Hex.)	Name	Description	Default (Range)
S1-05 (3204)	Volt Restore Sensitivity Time K	<b>V/f</b> <b>OLV/PM</b> <b>EZOLV</b> Sets the level of sensitivity of the output torque and LPF time constant for the voltage reduction rate. You can adjust the level of sensitivity with the load response.	1.000 s (0.000 - 3.000 s)

### ■ S1-06: Volt Restore Impact Load Time K

No. (Hex.)	Name	Description	Default (Range)
S1-06 (3205)	Volt Restore Impact Load Time K	<b>V/f</b> <b>OLV/PM</b> <b>EZOLV</b> Sets the voltage restoration time constant when you add an impact load.	0.050 s (0.000 - 1.000 s)

### ■ S1-07: Output Phase Loss Level

No. (Hex.)	Name	Description	Default (Range)
S1-07 (324C)	Output Phase Loss Level	<b>V/f</b> <b>OLV/PM</b> <b>EZOLV</b> Decreases the output phase loss level when Dynamic Noise control is active.	100.0% (10.0 - 100.0%)

## ◆ S2: Sequence Run Timers

S2 parameters set the programmable run timers for Real Time Clock (RTC). The timers set the drive to start and stop automatically at specified times. You can set the timers to run daily, on weekdays, on weekends, or only on specific days of the week.

### ■ Sequence Timer 1

When the current time reaches the S2-01 [Timer 1 Start Time] value, the drive will do the S2-04 [Timer 1 Sequence Selection] action. When the current time reaches the S2-02 [Timer 1 Stop Time] value, the drive will stop the S2-04 action. To use this function, set the current day in S2-03 [Timer 1 Day Selection].

- When S2-04 = 0 [Digital Out Only] or the terminal set for H1-xx = 51 [MFDI Function Selection = Sequence Timer Disable] is active:

Sequence Timer 1 has no effect on the drive Run command. The drive starts correctly based on the status of the Run command source set in *b1-02 [Run Command Selection 1]*.

- When *S2-04 = 1 or 2 [Run or Run - PID Disable]* and the terminal set for *H1-xx = 51* is not active: The drive will run during the active time of Sequence Timer 1 when the drive has a Run command. The drive uses the frequency reference set in *S2-05 [Timer 1 Reference Source]*. When *S2-04 = 2*, PID control is disabled.

If you activate the input from the terminal set for *H1-xx = 52 [Sequence Timer Cancel]* while Sequence Timer 1 is active, the timer will be disabled until the next scheduled sequence timer occurrence. To enable Sequence Timer 1 again, disable and enable the drive Run command again. While Sequence Timer 1 is active, the terminal set for *H2-xx = 51 [MFDO Function Selection = Sequence Timer 1]* will be active regardless of the *S2-04* setting.

When *S2-01 = S2-02*, Sequence Timer 1 is active continuously for the days set in *S2-03*. The timer will start at the *S2-01/S2-02* time on the first day and stop at the same time on the last day. When you set only one day in *S2-03*, the timer will stop at 11:59 on that day. When *S2-03 = 1 [Daily]*, the timer will run from the start/stop time until 11:59 every day.

HOA Keypad will show these messages to identify the status of the drive and Sequence Timer 1:

- *Sequence Timer 1 RUN: S2-04 = 1 or 2*, Sequence Timer 1 is active and the drive is running.
- *Sequence Timer OFF*: The drive has a Run command, *S2-04 = 1 or 2* and Sequence Timer 1 is not active.

When the drive is in *Sequence Timer OFF* condition, the drive should not detect *Uv [DC Bus Undervoltage]* or *ov [Overvoltage]* fault, but only detect as an alarm.

**Note:**

If *S2-03 > 0* and the HOA keypad is not connected, the drive will detect *oPr [Keypad Connection Fault]*. The *o2-06 [Keypad Disconnect Detection]* setting does not have an effect.

■ **Sequence Timers 2 to 4**

These timers operate identically to Sequence Timer 1. Parameters *S2-06 [Timer 2 Start Time]* to *S2-20 [Timer 4 Reference Source]* set Sequence Timers 2 to 4.

■ **Priority**

When more than one sequence timers overlap, the timer with the lowest number has priority.

- Sequence Timer 1 = highest priority
- Sequence Timer 4 = lowest priority

**Note:**

Jog Forward/Reverse has higher priority than any of the Sequence Timers.

Figure 12.115 shows an example of sequence timer operation when you set the drive parameters as specified in Table 12.68.

**Table 12.68 Parameter Settings for Example of Sequence Timer 1**

Time Display Format	Sequence Timer 1	Sequence Timer 2	Sequence Timer 3	Sequence Timer 4
o4-22 = 0 [24 Hour Clock]	S2-01 = 05:00	S2-06 = 19:00	S2-11 = 06:00	S2-16 = 17:00
	S2-02 = 15:00	S2-07 = 22:00	S2-12 = 14:00	S2-17 = 21:00
	S2-03 = 2 [Mon - Fri]	S2-08 = 2 [Mon - Fri]	S2-13 = 3 [Sat - Sun]	S2-18 = 10 [Sunday]
	S2-04 = 1 [Run]	S2-09 = 2 [Run - PI Disable]	S2-14 = 1 [Run]	S2-19 = 0 [Digital Out Only]
	S2-05 = 0 [Operator (d1-01/YA-01)]	S2-10 = 1 [Operator (d1-02/YA-02)]	S2-15 = 2 [Operator (d1-03/YA-03)]	-



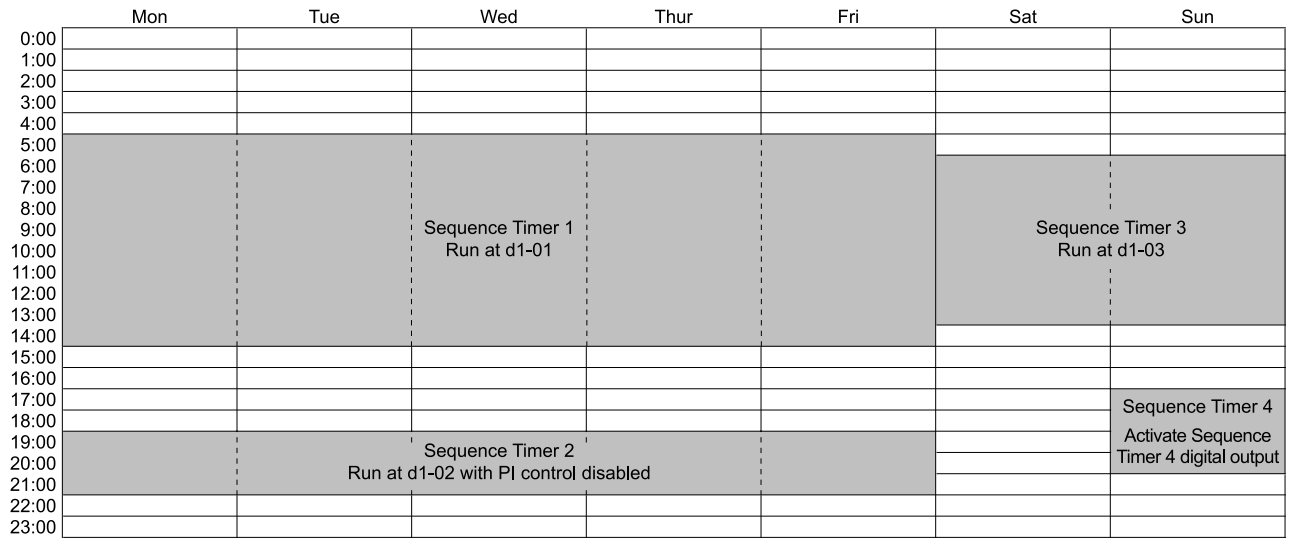

**d1-01: Reference 1**  
**d1-02: Reference 2**

**d1-03: Reference 3**

**Figure 12.115 Example of Sequence Timer 1**

Figure 12.116 shows an example of sequence timer operation when you set the drive parameters as specified in Table 12.69.

**Table 12.69 Parameter Settings for Example of Sequence Timer 2**

Tine Display Format	Sequence Timer 1	Sequence Timer 2	Sequence Timer 3	Sequence Timer 4
o4-22 = 0 [24 Hour Clock]	S2-01 = 00:00	S2-06 = 06:00	-	-
	S2-02 = 00:00	S2-07 = 06:00	-	-
	S2-03 = 2 [Mon - Fri]	S2-08 = 3 [Sat - Sun]	S2-13 = 0 [Timer Disabled]	S2-18 = 10 [Timer Disabled]
	S2-04 = 1 [Run]	S2-09 = 1 [Run]	-	-
	S2-05 = 0 [Operator (d1-01/YA-01)]	S2-10 = 2 [Operator (d1-03/YA-03)]	-	-

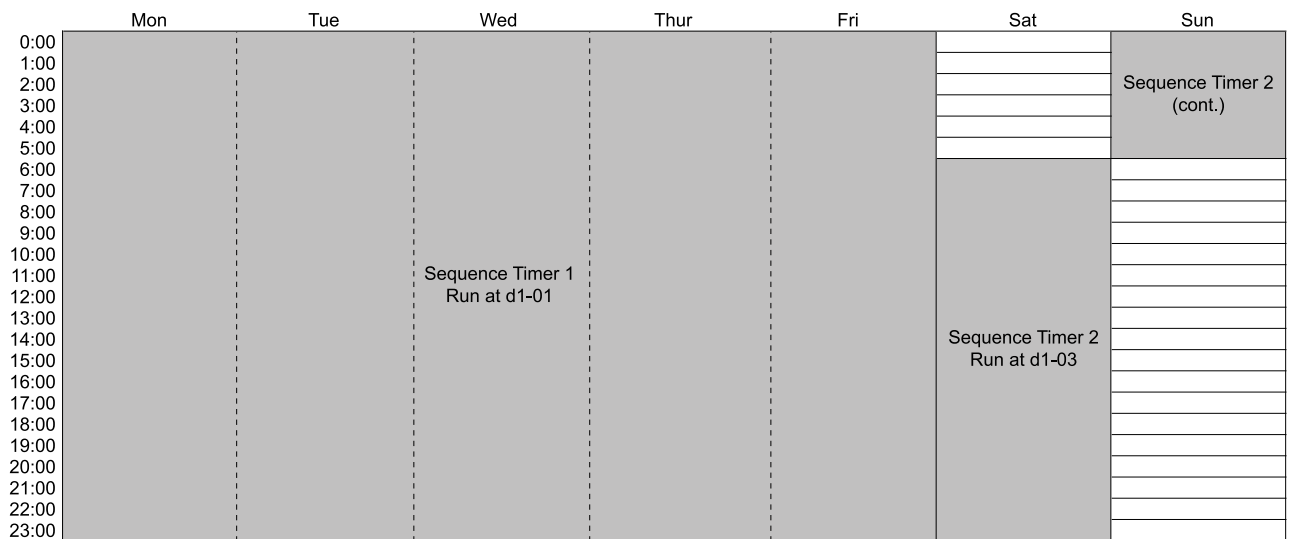

**d1-01: Reference 1**

**d1-03: Reference 3**

**Figure 12.116 Example of Sequence Timer 2**

Figure 12.117 shows an example of sequence timer operation when you set the drive parameters as specified in Table 12.70.

**Table 12.70 Parameter Settings for Example of Sequence Timer 3**

Tine Display Format	Sequence Timer 1	Sequence Timer 2	Sequence Timer 3	Sequence Timer 4
o4-22 = 0 [24 Hour Clock]	S2-01 = 05:00	S2-06 = 15:00	S2-11 = 09:00	-
	S2-02 = 15:00	S2-07 = 22:00	S2-12 = 24:00	-
	S2-03 = 2 [Mon - Fri]	S2-08 = 2 [Mon - Fri]	S2-13 = 9 [Saturday]	S2-18 = 0 [Timer Disabled]
	S2-04 = 1 [Run]	S2-09 = 2 [Run - PI Disable]	S2-14 = 1 [Run]	-
	S2-05 = 0 [Operator (d1-01/YA-01)]	S2-10 = 1 [Operator (d1-02/YA-02)]	S2-15 = 2 [Operator (d1-03/YA-03)]	-

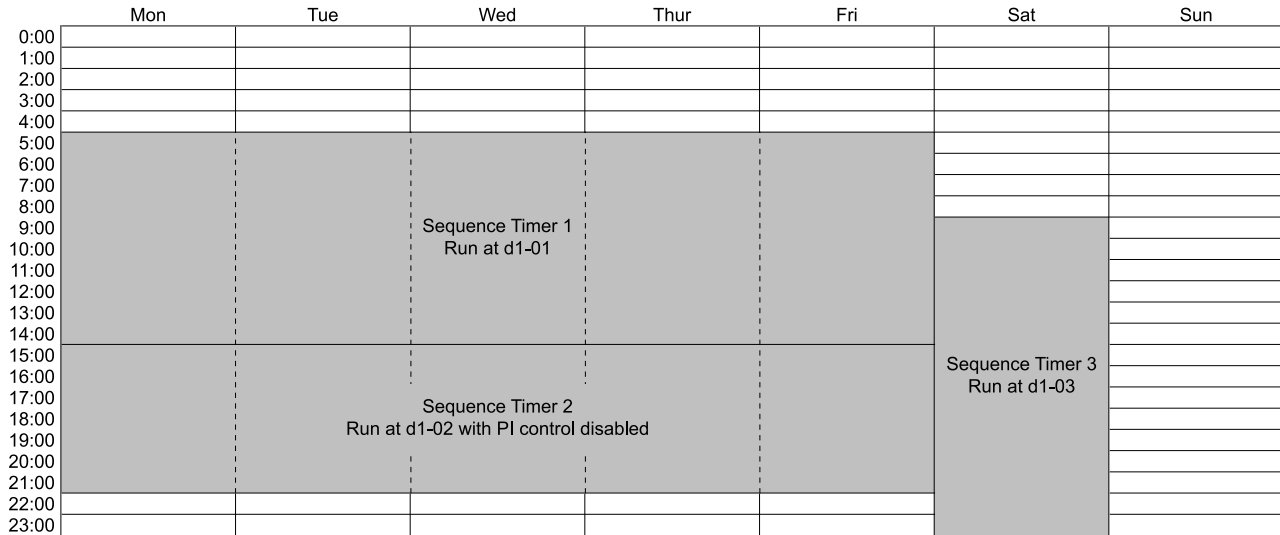

**d1-01: Reference 1**  
**d1-02: Reference 2**

**d1-03: Reference 3**

**Figure 12.117 Example of Sequence Timer 3**

**■ Sequence Timer Home Screen Text**

When you set o1-40 = 0 [Home Screen Display Selection = Custom Monitor], the message text on the Status Monitor will show the status of the Sequence Timer when the Sequence Timer has an effect on the drive Run condition.

- When you set the Sequence Timers to use for Digital Output only (S2-04 [Timer 1 Sequence Selection], S2-09 [Timer 2 Sequence Selection], S2-14 [Timer 3 Sequence Selection], and S2-19 [Timer 4 Reference Source] = 0 [Digital Out Only]), the message text will not show the status of the Sequence Timer.
- When the drive uses the Sequence Timers to overwrite the Run command in AUTO (S2-04, S2-09, S2-14, or S2-19 ≠ 0), the drive will update the message text. Refer to Table 12.71 for more information.

Table 12.71 Sequence Timer Home Screen Text

Status Monitor Display	Description
<pre> 10:00 am FWD Rdy Home OFF Seq Timer Set: Wait for RUN Cmd Setpoint          80.00 U5-99 % Output Frequency  0.00 U1-02 Hz Menu </pre>	You set the Sequence Timers to operate the drive, but there is no Run command.
<pre> 10:00 am FWD Rdy Home AUTO Sequence Timer Active: IDLE Freq Reference    0.00 U1-01 Hz Output Frequency  0.00 U1-02 Hz Menu </pre>	You set the Sequence timers to operate the drive and applied the Run command, but the timer did not start.
<pre> 10:00 am FWD Rdy Home AUTO Sequence Timer 1: RUN Freq Reference    45.00 U1-01 Hz Output Frequency  45.00 U1-02 Hz Menu </pre>	You set the Sequence timers to operate the drive, applied the Run command, and the timer started to operate the drive. The message text shows the active timer number.

### ■ S2-01: Timer 1 Start Time

No. (Hex.)	Name	Description	Default (Range)
S2-01 (3206)	Timer 1 Start Time	<input type="checkbox"/> V/f <input type="checkbox"/> OLV/PM <input type="checkbox"/> EZOLV Sets the start time for timer 1.	12:00 (12:00 AM - 11:59 PM)

**Note:**

- Default is when  $o4-22 = 1$  [Time Format = 12 Hour Clock]. When  $o4-22 = 0$  [24 Hour Clock], default is 00:00. When  $o4-22 = 2$  [12 Hour JP Clock], default is 00:00 AM.
- Range is when  $o4-22 = 1$ . When  $o4-22 = 0$ , range is 00:00 to 24:00. When  $o4-22 = 2$ , range is 00:00 AM to 11:59 PM.

### ■ S2-02: Timer 1 Stop Time

No. (Hex.)	Name	Description	Default (Range)
S2-02 (3207)	Timer 1 Stop Time	<input type="checkbox"/> V/f <input type="checkbox"/> OLV/PM <input type="checkbox"/> EZOLV Sets the stop time for timer 1.	12:00 (12:00 AM - 11:59 PM)

**Note:**

- Default is when  $o4-22 = 1$  [Time Format = 12 Hour Clock]. When  $o4-22 = 0$  [24 Hour Clock], default is 00:00. When  $o4-22 = 2$  [12 Hour JP Clock], default is 00:00 AM.
- Range is when  $o4-22 = 1$ . When  $o4-22 = 0$ , range is 00:00 to 24:00. When  $o4-22 = 2$ , range is 00:00 AM to 11:59 PM.

### ■ S2-03: Timer 1 Day Selection

No. (Hex.)	Name	Description	Default (Range)
S2-03 (3208)	Timer 1 Day Selection	<input type="checkbox"/> V/f <input type="checkbox"/> OLV/PM <input type="checkbox"/> EZOLV Sets the days for which sequence timer 1 is active.	0 (0 - 10)

**0 : Timer Disabled**

**1 : Daily**

**2 : Mon - Fri**

**3 : Sat - Sun**

**4 : Monday**

- 5 : Tuesday
- 6 : Wednesday
- 7 : Thursday
- 8 : Friday
- 9 : Saturday
- 10 : Sunday

### ■ S2-04: Timer 1 Sequence Selection

No. (Hex.)	Name	Description	Default (Range)
S2-04 (3209)	Timer 1 Sequence Selection	<input type="checkbox"/> V/f <input type="checkbox"/> OLV/IPM <input type="checkbox"/> EZOLV Sets the drive response when sequence timer 1 is active.	0 (0 - 3)

### 0 : Digital Out Only

- 1 : Run
- 2 : Run - PID Disable
- 3 : Allow Alternation

### ■ S2-05: Timer 1 Reference Source

No. (Hex.)	Name	Description	Default (Range)
S2-05 (320A)	Timer 1 Reference Source	<input type="checkbox"/> V/f <input type="checkbox"/> OLV/IPM <input type="checkbox"/> EZOLV Selects the frequency reference source to run the drive when sequence timer 1 is active (only applicable when S2-04 > 0 [Timer 1 Sequence Selection ≠ Digital Out Only]).	0 (0 - 8)

### 0 : Operator (d1-01/YA-01)

- 1 : Operator (d1-02/YA-02)
- 2 : Operator (d1-03/YA-03)
- 3 : Operator (d1-04/YA-04)
- 4 : Terminals
- 5 : Serial Com
- 6 : Option PCB
- 8 : Set by b1-01

#### Note:

For reference source 0 to 3, the drive will use *d1-xx* frequency reference when PID mode is disabled and *YA-xx* setpoint when PID is enabled.

### ■ S2-06: Timer 2 Start Time

No. (Hex.)	Name	Description	Default (Range)
S2-06 (320B)	Timer 2 Start Time	<input type="checkbox"/> V/f <input type="checkbox"/> OLV/IPM <input type="checkbox"/> EZOLV Sets the start time for timer 2.	12:00 (12:00 AM - 11:59 PM)

#### Note:

- Default is when *o4-22* = 1 [Time Format = 12 Hour Clock]. When *o4-22* = 0 [24 Hour Clock], default is 00:00. When *o4-22* = 2 [12 Hour JP Clock], default is 00:00 AM.
- Range is when *o4-22* = 1. When *o4-22* = 0, range is 00:00 to 24:00. When *o4-22* = 2, range is 00:00 AM to 11:59 PM.

### ■ S2-07: Timer 2 Stop Time

No. (Hex.)	Name	Description	Default (Range)
S2-07 (320C)	Timer 2 Stop Time	<input type="checkbox"/> V/f <input type="checkbox"/> OLV/IPM <input type="checkbox"/> EZOLV Sets the stop time for timer 2.	12:00 (12:00 AM - 11:59 PM)

**Note:**

- Default is when  $o4-22 = 1$  [Time Format = 12 Hour Clock]. When  $o4-22 = 0$  [24 Hour Clock], default is 00:00. When  $o4-22 = 2$  [12 Hour JP Clock], default is 00:00 AM.
- Range is when  $o4-22 = 1$ . When  $o4-22 = 0$ , range is 00:00 to 24:00. When  $o4-22 = 2$ , range is 00:00 AM to 11:59 PM.

**■ S2-08: Timer 2 Day Selection**

No. (Hex.)	Name	Description	Default (Range)
S2-08 (320D)	Timer 2 Day Selection	<input type="checkbox"/> V/f <input type="checkbox"/> OLVP/PM <input type="checkbox"/> EZOLV Sets the days for which sequence timer 2 is active.	0 (0 - 10)

**0 : Timer disabled****1 : Daily****2 : Mon - Fri****3 : Sat - Sun****4 : Monday****5 : Tuesday****6 : Wednesday****7 : Thursday****8 : Friday****9 : Saturday****10 : Sunday****■ S2-09: Timer 2 Sequence Selection**

No. (Hex.)	Name	Description	Default (Range)
S2-09 (320E)	Timer 2 Sequence Selection	<input type="checkbox"/> V/f <input type="checkbox"/> OLVP/PM <input type="checkbox"/> EZOLV Sets the drive response when sequence timer 2 is active.	0 (0 - 3)

**0 : Digital Out Only****1 : Run****2 : Run - PID Disable****3 : Allow Alternation****■ S2-10: Timer 2 Reference Source**

No. (Hex.)	Name	Description	Default (Range)
S2-10 (320F)	Timer 2 Reference Source	<input type="checkbox"/> V/f <input type="checkbox"/> OLVP/PM <input type="checkbox"/> EZOLV Selects the frequency reference source to run the drive when sequence timer 2 is active (only applicable when $S2-09 > 0$ [Timer 2 Sequence Selection $\neq 0$ ]).	0 (0 - 8)

**0 : Operator (d1-01/YA-01)****1 : Operator (d1-02/YA-02)****2 : Operator (d1-03/YA-03)****3 : Operator (d1-04/YA-04)****4 : Terminals****5 : Serial Com****6 : Option PCB****8 : Set by b1-01****Note:**

For reference source 0 to 3, the drive will use  $d1-xx$  frequency reference when PID mode is disabled and  $YA-xx$  setpoint when PID is enabled.

### ■ S2-11: Timer 3 Start Time

No. (Hex.)	Name	Description	Default (Range)
S2-11 (3210)	Timer 3 Start Time	<input type="checkbox"/> V/f <input type="checkbox"/> OL/VP <input type="checkbox"/> EZOLV Sets the start time for timer 3.	12:00 (12:00 AM - 11:59 PM)

**Note:**

- Default is when  $o4-22 = 1$  [Time Format = 12 Hour Clock]. When  $o4-22 = 0$  [24 Hour Clock], default is 00:00. When  $o4-22 = 2$  [12 Hour JP Clock], default is 00:00 AM.
- Range is when  $o4-22 = 1$ . When  $o4-22 = 0$ , range is 00:00 to 24:00. When  $o4-22 = 2$ , range is 00:00 AM to 11:59 PM.

### ■ S2-12: Timer 3 Stop Time

No. (Hex.)	Name	Description	Default (Range)
S2-12 (3211)	Timer 3 Stop Time	<input type="checkbox"/> V/f <input type="checkbox"/> OL/VP <input type="checkbox"/> EZOLV Sets the stop time for timer 3.	12:00 (12:00 AM - 11:59 PM)

**Note:**

- Default is when  $o4-22 = 1$  [Time Format = 12 Hour Clock]. When  $o4-22 = 0$  [24 Hour Clock], default is 00:00. When  $o4-22 = 2$  [12 Hour JP Clock], default is 00:00 AM.
- Range is when  $o4-22 = 1$ . When  $o4-22 = 0$ , range is 00:00 to 24:00. When  $o4-22 = 2$ , range is 00:00 AM to 11:59 PM.

### ■ S2-13: Timer 3 Day Selection

No. (Hex.)	Name	Description	Default (Range)
S2-13 (3212)	Timer 3 Day Selection	<input type="checkbox"/> V/f <input type="checkbox"/> OL/VP <input type="checkbox"/> EZOLV Sets the days for which sequence timer 3 is active.	0 (0 - 10)

0 : Timer Disabled

1 : Daily

2 : Mon - Fri

3 : Sat - Sun

4 : Monday

5 : Tuesday

6 : Wednesday

7 : Thursday

8 : Friday

9 : Saturday

10 : Sunday

### ■ S2-14: Timer 3 Sequence Selection

No. (Hex.)	Name	Description	Default (Range)
S2-14 (3213)	Timer 3 Sequence Selection	<input type="checkbox"/> V/f <input type="checkbox"/> OL/VP <input type="checkbox"/> EZOLV Sets the drive response when sequence timer 3 is active.	0 (0 - 3)

0 : Digital Out Only

1 : Run

2 : Run - PID Disable

3 : Allow Alternation

### ■ S2-15: Timer 3 Reference Source

No. (Hex.)	Name	Description	Default (Range)
S2-15 (3214)	Timer 3 Reference Source	<div style="display: flex; justify-content: space-between; align-items: center;"> <span>V/f</span> <span>OLV/PM</span> <span>EZOLV</span> </div> Selects the frequency reference source to run the drive when sequence timer 3 is active (only applicable when $S2-14 > 0$ [Timer 3 Sequence Selection ≠ Digital Out Only]).	0 (0 - 8)

**0 : Operator (d1-01/YA-01)**

**1 : Operator (d1-02/YA-02)**

**2 : Operator (d1-03/YA-03)**

**3 : Operator (d1-04/YA-04)**

**4 : Terminals**

**5 : Serial Com**

**6 : Option PCB**

**8 : Set by b1-01**

**Note:**

For reference source 0 to 3, the drive will use  $d1-xx$  frequency reference when PID mode is disabled and  $YA-xx$  setpoint when PID is enabled.

### ■ S2-16: Timer 4 Start Time

No. (Hex.)	Name	Description	Default (Range)
S2-16 (3215)	Timer 4 Start Time	<div style="display: flex; justify-content: space-between; align-items: center;"> <span>V/f</span> <span>OLV/PM</span> <span>EZOLV</span> </div> Sets the start time for timer 4.	12:00 (12:00 AM - 11:59 PM)

**Note:**

• Default is when  $o4-22 = 1$  [Time Format = 12 Hour Clock]. When  $o4-22 = 0$  [24 Hour Clock], default is 00:00. When  $o4-22 = 2$  [12 Hour JP Clock], default is 00:00 AM.

• Range is when  $o4-22 = 1$ . When  $o4-22 = 0$ , range is 00:00 to 24:00. When  $o4-22 = 2$ , range is 00:00 AM to 11:59 PM.

### ■ S2-17: Timer 4 Stop Time

No. (Hex.)	Name	Description	Default (Range)
S2-17 (3216)	Timer 4 Stop Time	<div style="display: flex; justify-content: space-between; align-items: center;"> <span>V/f</span> <span>OLV/PM</span> <span>EZOLV</span> </div> Sets the stop time for timer 4.	12:00 (12:00 AM - 11:59 PM)

**Note:**

• Default is when  $o4-22 = 1$  [Time Format = 12 Hour Clock]. When  $o4-22 = 0$  [24 Hour Clock], default is 00:00. When  $o4-22 = 2$  [12 Hour JP Clock], default is 00:00 AM.

• Range is when  $o4-22 = 1$ . When  $o4-22 = 0$ , range is 00:00 to 24:00. When  $o4-22 = 2$ , range is 00:00 AM to 11:59 PM.

### ■ S2-18: Timer 4 Day Selection

No. (Hex.)	Name	Description	Default (Range)
S2-18 (3217)	Timer 4 Day Selection	<div style="display: flex; justify-content: space-between; align-items: center;"> <span>V/f</span> <span>OLV/PM</span> <span>EZOLV</span> </div> Sets the days for which sequence timer 4 is active.	0 (0 - 10)

**0 : Timer disabled**

**1 : Daily**

**2 : Mon - Fri**

**3 : Sat - Sun**

**4 : Monday**

**5 : Tuesday**

**6 : Wednesday**

**7 : Thursday**

8 : Friday

9 : Saturday

10 : Sunday

### ■ S2-19: Timer 4 Sequence Selection

No. (Hex.)	Name	Description	Default (Range)
S2-19 (3218)	Timer 4 Sequence Selection	<input type="checkbox"/> V/f <input type="checkbox"/> OLV/IPM <input type="checkbox"/> EZOLV Sets the drive response when sequence timer 4 is active.	0 (0 - 3)

0 : Digital Out Only

1 : Run

2 : Run - PID Disable

3 : Allow Alternation

### ■ S2-20: Timer 4 Reference Source

No. (Hex.)	Name	Description	Default (Range)
S2-20 (3219)	Timer 4 Reference Source	<input type="checkbox"/> V/f <input type="checkbox"/> OLV/IPM <input type="checkbox"/> EZOLV Selects the frequency reference source to run the drive when sequence timer 4 is active (only applicable when S2-19 > 0 [Timer 4 Sequence Selection ≠ Digital Out Only]).	0 (0 - 8)

0 : Operator (d1-01/YA-01)

1 : Operator (d1-02/YA-02)

2 : Operator (d1-03/YA-03)

3 : Operator (d1-04/YA-04)

4 : Terminals

5 : Serial Com

6 : Option PCB

8 : Set by b1-01

Note:

For reference source 0 to 3, the drive will use *d1-xx* frequency reference when PID mode is disabled and *YA-xx* setpoint when PID is enabled.

## ◆ S3: PI2 Control

*S3 parameters* set the PI2 Control function. You can use this function to monitor the input, setpoint, feedback and output levels of the PI2 Control through several additional monitors. You can also set the drive to activate certain MFDO terminals when the PI2 feedback level is less than or more than a set value. The difference between the target and the feedback value (deviation) is fed into the PI controller and the PI controller outputs the frequency to *U5-xx* for monitoring. Refer to [b5: PID Control on page 649](#) for more information.

### ■ PI2 Control Setpoint and Feedback

PI2 Control has three ways to set the target setpoint. This is the order of the input setpoints from most important to least important:

- MEMOBUS setpoint: 000DH (while 000FH, bit 4 = 1)
- Analog setpoint: *H3-xx* = 25 [MFAI Function Selection = PI2 Control Setpoint]
- Digital setpoint: *S3-05* [PI2 Control Setpoint]

For the feedback, PI2 Control only has analog setting *H3-xx* = 26 [PI2 Control Feedback] as the feedback level.

### ■ PI2 Control Monitors

These monitors will work as the PI2 Control monitors for the setpoint, feedback, input, and output:



- U5-17 [PI2 Control Setpoint]: Uses the target setpoint, which is set as specified by the setpoint source the drive will use.
- U5-18 [PI2 Control Feedback]: Uses an analog input when H3-xx = 26 [PI2 Control Feedback].
- U5-19 [PI2 Control Input]: Input into the proportional and integral calculation as specified by the target setpoint and feedback.
- U5-20 [PI2 Control Output]: Different for different S3-01 [PI2 Control Enable Selection] and S3-12 [PI2 Control Disable Mode Sel] settings.
  - When S3-01 > 0 [Enabled], the drive will show the calculated PI2 Control output.
  - When S3-01 = 0 [Disabled], S3-12 [PI2 Control Disable Mode Sel] will set what to show.

### PI2 Control Block Diagram

Figure 12.118 shows the general overview for the PI2 Control.

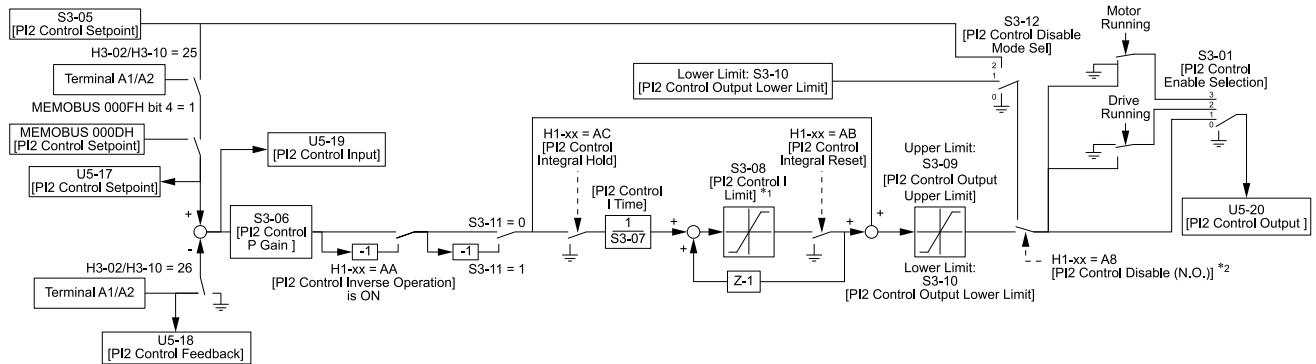

Figure 12.118 PI2 Control Block Diagram

- \*1 The drive calculates the actual integral limit as:
  - Upper limit = Min (S3-08, S3-09 - PI2 P portion)
  - Lower limit = Min (-S3-08, S3-10 - PI2 P portion)
- \*2 When the MFDI set for H1-xx = A8 [MFDI Function Selection = PI2 Control Disable] is activated, you must set the PI Integrator as:
  - S3-12 = 1 [Lower Limit (S3-10)]: PI Value = S3-10
  - S3-12 = 2 [Setpoint]: PI Value = S3-05

### S3-01: PI2 Control Enable Selection

No. (Hex.)	Name	Description	Default (Range)
S3-01 (321A)	PI2 Control Enable Selection	<input type="checkbox"/> V/f <input type="checkbox"/> OLV/PM <input type="checkbox"/> EZOLV Sets when the PI Auxiliary Control function is enabled:	0 (0 - 3)

**0 : Disabled**

**1 : Always**

PI2 Control is always active.

**2 : Drive Running**

PI2 Control is active only when the drive is running.

**3 : Motor Running**

PI2 Control is active when the drive receives a Run command and is not in baseblock, DC injection, or zero speed.

### S3-02: PI2 Control Transducer Scale

No. (Hex.)	Name	Description	Default (Range)
S3-02 (321B) RUN	PI2 Control Transducer Scale	<input type="checkbox"/> V/f <input type="checkbox"/> OLV/PM <input type="checkbox"/> EZOLV Sets the full scale (10 V or 20 mA) output of the pressure transducer that is connected to the analog input terminals programmed for PI2 (Setpoint or Feedback).	100.00 (1.00 - 600.00)

**Note:**

Parameters S3-04 [PI2 Control Unit Selection], S3-03 [PI2 Control Decimal Place Pos], and S3-02 [PI2 Control Transducer Scale] set the unit, resolution, and upper limit.

### ■ S3-03: PI2 Control Decimal Place Pos

No. (Hex.)	Name	Description	Default (Range)
S3-03 (321C) RUN	PI2 Control Decimal Place Pos	<input type="checkbox"/> V/f <input type="checkbox"/> OLV/PM <input type="checkbox"/> EZOLV Sets the decimal place display for secondary PI units.	2 (0 - 3)

**0 : No Decimal Places (XXXXX)**

**1 : One Decimal Places (XXXX.X)**

**2 : Two Decimal Places (XXX.XX)**

**3 : Three Decimal Places (XX.XXX)**

### ■ S3-04: PI2 Control Unit Selection

No. (Hex.)	Name	Description	Default (Range)
S3-04 (321D) RUN	PI2 Control Unit Selection	<input type="checkbox"/> V/f <input type="checkbox"/> OLV/PM <input type="checkbox"/> EZOLV Sets the units displayed for the PI2 Control parameters and monitor.	48 (0 - 50)

**0 : “WC: inches of water column**

**1 : PSI: pounds per square inch**

**2 : GPM: gallons/min**

**3 : °F: Fahrenheit**

**4 : ft<sup>3</sup>/min: cubic feet/min**

**5 : m<sup>3</sup>/h: cubic meters/hour**

**6 : L/h: liters/hour**

**7 : L/s: liters/sec**

**8 : bar: bar**

**9 : Pa: Pascal**

**10 : °C: Celsius**

**11 : m: meters**

**12 : ft: feet**

**13 : L/min: liters/min**

**14 : m<sup>3</sup>/min: cubic meters/min**

**15 : “Hg: Inch Mercury**

**16 : kPa: kilopascal**

**48 : %: Percent**

**49 : Custom(S3-18~20)**

**50 : None**

### ■ S3-05: PI2 Control Setpoint

No. (Hex.)	Name	Description	Default (Range)
S3-05 (321E) RUN	PI2 Control Setpoint	<input type="checkbox"/> V/f <input type="checkbox"/> OLV/PM <input type="checkbox"/> EZOLV Sets the PI2 Control target setpoint.	0.00 (0.00 - 600.00)

**Note:**

Parameters S3-04 [PI2 Control Unit Selection], S3-03 [PI2 Control Decimal Place Pos], and S3-02 [PI2 Control Transducer Scale] set the unit, resolution, and upper limit.

### ■ S3-06: PI2 Control Proportional Gain

No. (Hex.)	Name	Description	Default (Range)
S3-06 (321F) RUN	PI2 Control Proportional Gain	<input type="checkbox"/> V/f <input type="checkbox"/> OLV/PM <input type="checkbox"/> EZOLV Sets the proportional gain of the PI2 Control. Set this parameter to 0.00 to disable proportional control.	1.00 (0.00 - 25.00)

### ■ S3-07: PI2 Control Integral Time

No. (Hex.)	Name	Description	Default (Range)
S3-07 (3220) RUN	PI2 Control Integral Time	<input type="checkbox"/> V/f <input type="checkbox"/> OLV/PM <input type="checkbox"/> EZOLV Sets the integral time for the suction pressure control. Set this parameter to 0.00 to disable the integrator.	1.0 s (0.0 - 360.0 s)

### ■ S3-08: PI2 Control Integral Max Limit

No. (Hex.)	Name	Description	Default (Range)
S3-08 (3221) RUN	PI2 Control Integral Max Limit	<input type="checkbox"/> V/f <input type="checkbox"/> OLV/PM <input type="checkbox"/> EZOLV Sets the maximum output possible from the integrator.	100.0% (0.0 - 100.0%)

### ■ S3-09: PI2 Control Output Upper Limit

No. (Hex.)	Name	Description	Default (Range)
S3-09 (3222) RUN	PI2 Control Output Upper Limit	<input type="checkbox"/> V/f <input type="checkbox"/> OLV/PM <input type="checkbox"/> EZOLV Sets the maximum output possible from the PI Auxiliary Control function.	100.0% (0.0 - 100.0%)

### ■ S3-10: PI2 Control Output Lower Limit

No. (Hex.)	Name	Description	Default (Range)
S3-10 (3223) RUN	PI2 Control Output Lower Limit	<input type="checkbox"/> V/f <input type="checkbox"/> OLV/PM <input type="checkbox"/> EZOLV Sets the minimum output possible from the PI Auxiliary Control function.	0.0% (-100.0 - +100.0%)

### ■ S3-11: PI2 Control Output Level Sel

No. (Hex.)	Name	Description	Default (Range)
S3-11 (3224)	PI2 Control Output Level Sel	<input type="checkbox"/> V/f <input type="checkbox"/> OLV/PM <input type="checkbox"/> EZOLV Sets the PI2 controller output direction.	0 (0, 1)

#### 0 : Direct Acting (Normal Output)

When the feedback is higher than the setpoint, the speed decreases.

#### 1 : Inverse Acting (Reverse Output)

When the feedback is lower than the setpoint, the speed decreases.

### ■ S3-12: PI2 Control Disable Mode Sel

No. (Hex.)	Name	Description	Default (Range)
S3-12 (3225) RUN	PI2 Control Disable Mode Sel	<input type="checkbox"/> V/f <input type="checkbox"/> OLV/IPM <input type="checkbox"/> EZOLV Sets what U5-20 [PI2 Control Output] will output when disabled.	0 (0 - 2)

#### 0 : No Output (0%)

U5-20 will show only 0.

#### 1 : Lower Limit (S3-10)

U5-20 will show the lower limit of the PI2 Control Output set with S3-10 [PI2 Control Output Lower Limit].

#### 2 : Setpoint

U5-20 will show the target setpoint of the PI2 Control that aligns with U5-18 [PI2 Control Feedback].

### ■ S3-13: PI2 Control Low Feedback Lvl

No. (Hex.)	Name	Description	Default (Range)
S3-13 (3226) RUN	PI2 Control Low Feedback Lvl	<input type="checkbox"/> V/f <input type="checkbox"/> OLV/IPM <input type="checkbox"/> EZOLV Sets the secondary PI low feedback detection level.	0.00 (0.00 - 600.00)

#### Note:

Parameters S3-04 [PI2 Control Unit Selection], S3-03 [PI2 Control Decimal Place Pos], and S3-02 [PI2 Control Transducer Scale] set the unit, resolution, and upper limit.

### ■ S3-14: PI2 Control Low Feedback Time

No. (Hex.)	Name	Description	Default (Range)
S3-14 (3227) RUN	PI2 Control Low Feedback Time	<input type="checkbox"/> V/f <input type="checkbox"/> OLV/IPM <input type="checkbox"/> EZOLV Sets the secondary PI low feedback detection delay time in seconds.	1.0 s (0.0 - 25.5 s)

### ■ S3-15: PI2 Control High Feedback Lvl

No. (Hex.)	Name	Description	Default (Range)
S3-15 (3228) RUN	PI2 Control High Feedback Lvl	<input type="checkbox"/> V/f <input type="checkbox"/> OLV/IPM <input type="checkbox"/> EZOLV Sets the secondary PI high feedback detection level.	100.00 (0.00 - 600.00)

#### Note:

Parameters S3-04 [PI2 Control Unit Selection], S3-03 [PI2 Control Decimal Place Pos], and S3-02 [PI2 Control Transducer Scale] set the unit, resolution, and upper limit.

### ■ S3-16: PI2 Control High Feedback Time

No. (Hex.)	Name	Description	Default (Range)
S3-16 (3229) RUN	PI2 Control High Feedback Time	<input type="checkbox"/> V/f <input type="checkbox"/> OLV/IPM <input type="checkbox"/> EZOLV Sets the secondary PI high feedback detection delay time in seconds.	1.0 s (0.0 - 25.5 s)

### ■ S3-17: PI2 Control Feedback Det Sel

No. (Hex.)	Name	Description	Default (Range)
S3-17 (322A) RUN	PI2 Control Feedback Det Sel	<input type="checkbox"/> V/f <input type="checkbox"/> OLV/IPM <input type="checkbox"/> EZOLV Sets when the low and high feedback detection multifunction outputs (71h and 72h) for PI2 Control are active.	0 (0, 1)

## 0 : While PI2 Control Enabled

Low and high feedback level detection are active only when PI2 Control is active.

## 1 : Always

Low and high feedback level detection are always active.

### Note:

Feedback level detection compares PI2 Control Feedback from analog input  $H3-xx = 26$  [MFAI Function Selection = PI2 Control Feedback] to these parameters:

- S3-13 [PI2 Control Low Feedback Lvl] for low feedback level detection
- S3-15 [PI2 Control High Feedback Lvl] for high feedback level detection

## ■ S3-18: PI2 Control Custom Unit 1

No. (Hex.)	Name	Description	Default (Range)
S3-18 (322B) RUN	PI2 Control Custom Unit 1	<b>V/f</b> <b>OLV/PM</b> <b>EZOLV</b> Sets the first character of the PI2 Control custom unit display when $S3-04 = 49$ [PI2 Control Unit Selection = Custom(S3-18-20)].	41 (20 - 7A)

## ■ S3-19: PI2 Control Custom Unit 2

No. (Hex.)	Name	Description	Default (Range)
S3-19 (322C) RUN	PI2 Control Custom Unit 2	<b>V/f</b> <b>OLV/PM</b> <b>EZOLV</b> Sets the second character of the PI2 Control custom unit display when $S3-04 = 49$ [PI2 Control Unit Selection = Custom(S3-18-20)].	41 (20 - 7A)

## ■ S3-20: PI2 Control Custom Unit 3

No. (Hex.)	Name	Description	Default (Range)
S3-20 (322D) RUN	PI2 Control Custom Unit 3	<b>V/f</b> <b>OLV/PM</b> <b>EZOLV</b> Sets the third character of the PI2 Control custom unit display when $S3-04 = 49$ [PI2 Control Unit Selection = Custom(S3-18-20)].	41 (20 - 7A)



## ◆ S5: Hand/Off/Auto Operation

$S5$  parameters set the drive operation in HAND, OFF, or AUTO Mode. The drive operation in each mode changes when the  $S5-04$  [HAND-OFF-AUTO Behavior] setting changes.

Table 12.72 Definitions of Each Mode

Operation Mode	Description
AUTO	The drive operates as specified by the frequency reference and Run command from the sources set in $b1-01$ [Frequency Reference Selection 1] and $b1-02$ [Run Command Selection 1].
HAND	The drive operates as specified by the frequency reference from the source set in $S5-01$ [HAND Frequency Reference Source].
OFF	The drive is stopped and will not run until you activate the MFDI set for $H1-xx = AF$ or $B0$ [MFDI Function Selection = Emergency Override FWD or REV]. The drive uses the frequency reference source set in $b1-01$ . When $b1-02 = 0$ [Keypad] to 3 [Option PCB], the MFDI set for $H1-xx = 12, 13, \text{ or } 69$ [Forward Jog, Reverse Jog, or Jog Run 2] will also run the drive.

- When  $S5-01 = 1$  [HAND Ref  $S5-05$  or PID SP  $S5-06$ ]:  
The drive operates as specified by the frequency reference set in  $S5-05$  [HAND Frequency Reference] or PID setpoint set in  $S5-06$  [HAND Setpoint].
- When  $S5-01 = 2$  [Set by  $b1-01$ ]:  
The drive operates as specified by the frequency reference from the source set in  $b1-01$ .



Parameter  $S5-02$  [HAND/AUTO Switchover During Run] sets the drive to change between HAND and AUTO Modes during run. When  $S5-02 = 1$  [Enabled] and you pushed  or , the drive will change between HAND and AUTO Modes.

**Note:**

- When  $b1-02 = 1$  [Digital Input] to 3 and the drive is running in HAND Mode,  will have no effect, regardless of the  $S5-02$  setting.
- When  $S5-04 = 1$  [Normal], the drive will always be in AUTO Mode at power up.
- When  $S5-04 = 0$  [Legacy], the power up state changes when  $S5-10$  [AUTO Key Memory at Power Down] changes.

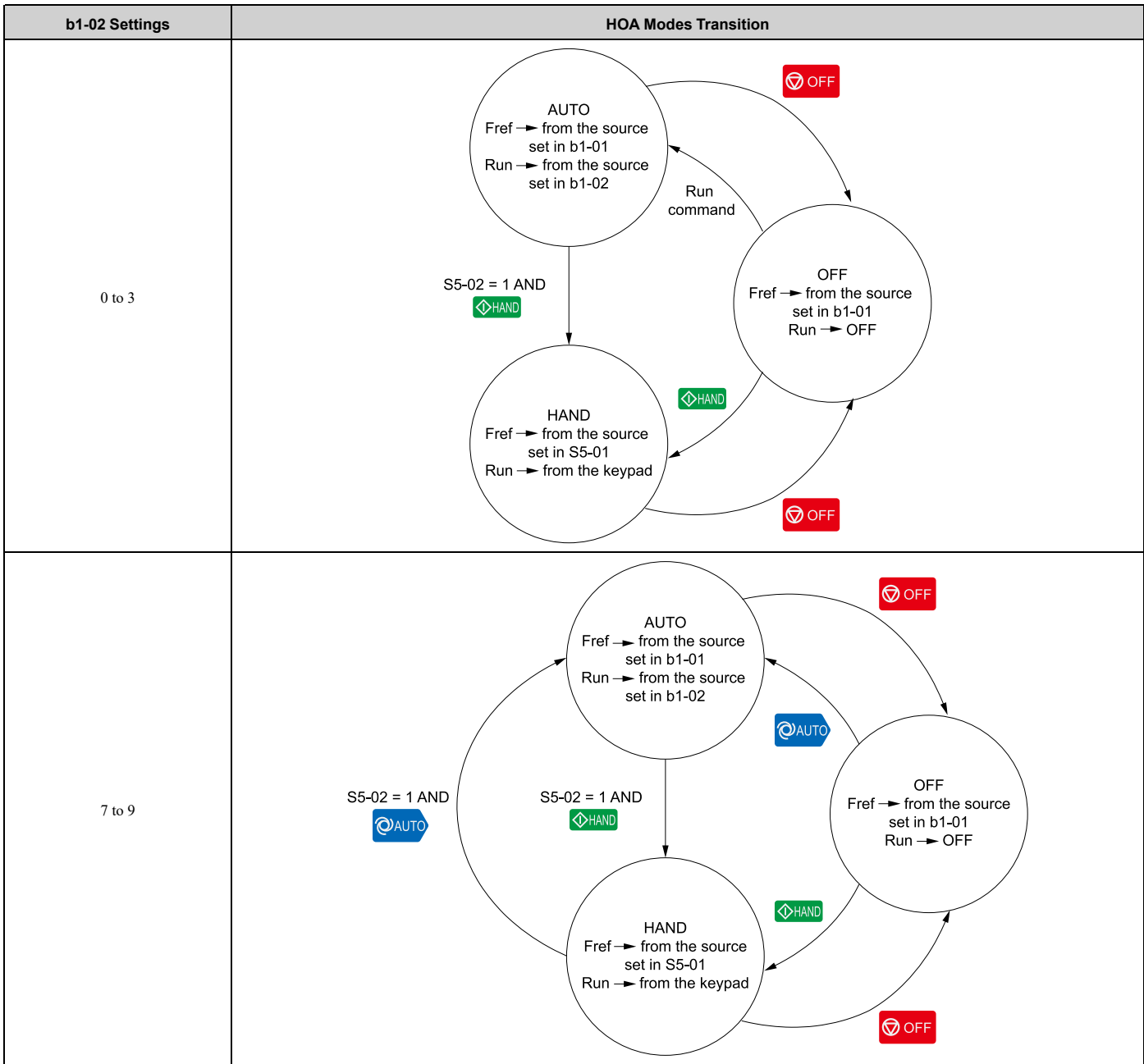
**Table 12.73 Drive Operation in Normal Mode**



When you use the MFDIs set for  $H1-xx = 6D$  and  $6E$  [AUTO Command and HAND Command],  and  on the HOA keypad do not function. When  $S5-04 = 1$ , use these MFDIs together.

**Table 12.74 MFDI Settings and Drive Operation in Normal Mode**

H1-xx = 6D [AUTO Command]	H1-xx = 6E [HAND Command]	Operation Mode	Frequency Reference Source	Run Command Source
OFF	OFF	OFF	Based on $b1-01$	-
OFF	ON	HAND	Based on $S5-01$	Keypad

H1-xx = 6D [AUTO Command]	H1-xx = 6E [HAND Command]	Operation Mode	Frequency Reference Source	Run Command Source
ON	OFF	AUTO	Based on b1-01	Based on b1-02
ON	ON	OFF	Based on b1-01	-

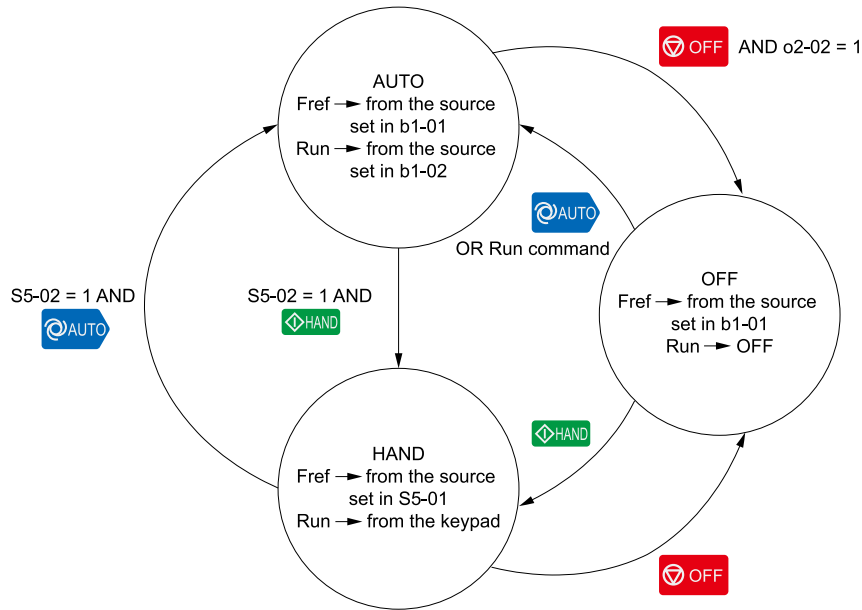

Figure 12.119 Drive Operation in Legacy Mode

When S5-04 = 0, you can only use MFDIs set for H1-xx = 6D and 6E individually.

Table 12.75 MFDI Settings and Drive Operation in Legacy Mode

H1-xx = 6D [AUTO Command]	H1-xx = 6E [HAND Command]	Operation Mode	Frequency Reference Source	Run Command Source
OFF	-	HAND	Based on S5-01	Keypad
ON	-	AUTO	Based on b1-01	Based on b1-02
-	OFF	AUTO	Based on b1-01	Based on b1-02
-	ON	HAND	Based on S5-01	Keypad

### AUTO Command

To input an AUTO command from , you must set these MFDIs:

- H1-xx = 6D [AUTO Command]
- H1-xx = 6E [HAND Command] when S5-04 = 0 [HAND-OFF-AUTO Behavior = Legacy]



When S5-04 = 0, the drive will receive the AUTO Command when the MFDI set for H1-xx = 6D is activated or when the MFDI set for H1-xx = 6E is deactivated.

**Note:**

- If you set the terminal for H1-xx = 6D and 6E at the same time when S5-04 = 0, the drive will detect an oPE34 [HAND/OFF/AUTO Input Setting].
- When S5-04 = 1 [Normal], the drive will receive the AUTO Command only when the terminal set for H1-xx = 6D is activated and the terminal set for H1-xx = 6E is deactivated.

In Legacy and Normal modes, the drive establishes the AUTO Run command when the AUTO Command and External Run command are active.

**AUTO Command from AUTO Key**

When  $b1-02 = 7$  to  $9$  [Run Command Selection 1 = AUTO Command + Term Run to AUTO Command + Option Run] and you push  when the drive does not have an external Run command, the drive will enter Auto Mode and the  will be OFF.

When the drive is in Auto Mode and it receives an external Run command, the drive will run in Auto Mode.

**Table 12.76 AUTO Run Command Behavior when  $b1-01 = 7$  to  $9$**

AUTO Command	External Run (Terminal, Serial, or Option)	AUTO LED  *1	Drive Operation	Description	HOA State
No	No	OFF	No	<ul style="list-style-type: none"> <li>Drive Stopped</li> <li>Drive is in OFF Mode</li> </ul>	OFF
Yes	No	OFF	No	<ul style="list-style-type: none"> <li>Drive is in AUTO Mode</li> <li>Waiting for Run command</li> </ul>	AUTO
No	Yes	OFF	No	<ul style="list-style-type: none"> <li>Drive received the Run command</li> <li>Waiting for AUTO command</li> </ul>	OFF
Yes	Yes	ON	Yes	Drive is operating in AUTO Mode	AUTO
Yes	Yes	Long Blink (50% duty)	No	<ul style="list-style-type: none"> <li>Drive is in Sleep Mode</li> <li>Output Frequency is 0 or drive decelerates to STOP</li> </ul>	AUTO
Yes	Yes	Double Blink	No	Waiting for cycle of commands Example: <ul style="list-style-type: none"> <li>Drive Ready condition was removed</li> <li>Drive starts Fast-Stop operation</li> </ul>	AUTO

\*1 The LED is available when  $o2-24 \neq 2$  [LED Light Function Selection  $\neq$  Keypad LED Light Disable].

By default, the drive will energize in AUTO Mode. When you de-energize the drive in AUTO Mode while  $S5-10 = 1$  [AUTO Key Memory at Power Down = Enabled], the drive will memorize the  press and it will energize in AUTO Mode again. When you de-energize the drive in HAND or OFF Mode, the drive will energize in OFF Mode.

**Note:**

If you set  $b1-02 = 0$  [Run Command Selection 1 = Keypad] and  $S5-10 = 2$  [AUTO Mode] at the same time, the drive detects  $oPE05$  [Run Cmd/Freq Ref Source Sel Err].

**■ HAND Command**

You can input the HAND Command from:

-  when  $S5-07 = 1$  [Operation HAND Key = Enabled]
- One of MFDI terminals set for:
  - $H1-xx = 6E$  [HAND Command]
  - $H1-xx = 6D$  [AUTO Command] when  $S5-04 = 0$  [HAND-OFF-AUTO Behavior = Legacy]

When  $S5-04 = 0$ , the drive will receive the HAND Command when the MFDI set for  $H1-xx = 6E$  is activated, or when the MFDI set for  $H1-xx = 6D$  is OFF and the drive receives a Run command.

**Note:**

The drive will disable  when  $o2-02 = 0$  [OFF Key Function Selection = Disabled] and  $b1-02 \neq 0$  [Run Command Selection 1  $\neq$  Keypad].



HAND Command	External Run (Terminal, Serial, or Option)	HAND LED  *1	Drive Operation	HOA Mode	Description	HOA State
No	No	OFF	No	Normal Legacy	<ul style="list-style-type: none"> <li>Drive Stopped</li> <li>Drive is in OFF Mode</li> </ul>	OFF
Yes	No	OFF	No	Legacy	HAND Mode ready but No Run command	HAND
Yes	Yes	ON	Yes	Legacy	Drive is operating in HAND Mode	HAND



HAND Command	External Run (Terminal, Serial, or Option)	HAND LED 	Drive Operation	HOA Mode	Description	HOA State
Yes	Yes	Long Blink (50% duty)	No	Legacy	Output Frequency is 0 or drive decelerates to STOP	HAND
Yes	Yes	Double Blink	No	Legacy	Waiting for cycle of commands Example: • Drive Ready condition was removed • Drive starts Fast-Stop operation	HAND
Yes	Yes/No	ON	Yes	Normal	Drive is operating in HAND Mode	HAND
Yes	Yes/No	Long Blink (50% duty)	No	Normal	Output Frequency is 0 or drive decelerates to STOP	HAND
Yes	Yes/No	Double Blink	No	Normal	Waiting for cycle of commands Example: • Drive Ready condition was removed • Drive starts Fast-Stop operation	HAND

\*1 The LED is available when  $o2-24 \neq 2$  [LED Light Function Selection  $\neq$  Keypad LED Light Disable].

### ■ S5-01: HAND Frequency Reference Source

No. (Hex.)	Name	Description	Default (Range)
S5-01 (322F)	HAND Frequency Reference Source	   Sets the frequency reference source when HAND Mode is active.	1 (0 - 2)

#### 0 : HAND Analog Input

The drive operates as specified by the frequency reference from the MFAI terminal set for  $H3-xx = 2E$  [MFAI Function Selection = Hand Frequency Ref or Setpoint].



#### 1 : HAND Ref S5-05 or PID SP S5-06

The drive operates as specified by the frequency reference set in  $S5-05$  [HAND Frequency Reference] or PID setpoint set in  $S5-06$  [HAND Setpoint].

#### 2 : Set by b1-01

The drive operates as specified by the frequency reference from the source set in  $b1-01$ .



### ■ S5-02: HAND/AUTO Switchover During Run

No. (Hex.)	Name	Description	Default (Range)
S5-02 (3230)	HAND/AUTO Switchover During Run	   Sets the function to enable or disable switching between HAND and AUTO Mode during run.	1 (0, 1)

#### 0 : Disabled

#### 1 : Enabled

### ■ S5-03: HAND Mode PID Selection

No. (Hex.)	Name	Description	Default (Range)
S5-03 (3231) RUN	HAND Mode PID Selection	   Sets the function to enable or disable PI function when HAND mode is active.	0 (0, 1)

#### 0 : Disabled

#### 1 : Enabled

##### Note:

If  $b5-01 = 0$  [PID Mode Setting = Disabled], the drive disables Hand Mode PID.

### ■ S5-04: HAND-OFF-AUTO Behavior

No. (Hex.)	Name	Description	Default (Range)
S5-04 (3232)	HAND-OFF-AUTO Behavior	<input type="checkbox"/> V/f <input type="checkbox"/> OLV/IPM <input type="checkbox"/> EZOLV Sets the drive behavior when the drive is in HAND Mode, OFF Mode, or AUTO Mode.	1 (0, 1)

0 : Legacy

1 : Normal

Note:

When you set this parameter to 1, the drive will always be in AUTO Mode when you energize the drive.

### ■ S5-05: HAND Frequency Reference

No. (Hex.)	Name	Description	Default (Range)
S5-05 (3233) RUN	HAND Frequency Reference	<input type="checkbox"/> V/f <input type="checkbox"/> OLV/IPM <input type="checkbox"/> EZOLV Sets the frequency reference when HAND Mode is active, PID is disabled and $S5-01 = 1$ [HAND Frequency Reference Source = HAND Ref S5-05 or PID SP S5-06].	0.00 Hz (0.00 - 400.00 Hz)

### ■ S5-06: HAND Setpoint

No. (Hex.)	Name	Description	Default (Range)
S5-06 (3234) RUN	HAND Setpoint	<input type="checkbox"/> V/f <input type="checkbox"/> OLV/IPM <input type="checkbox"/> EZOLV Sets the System Setpoint when HAND Mode is active, PID is enabled and $S5-01 = 1$ [HAND Frequency Reference Source = HAND Ref S5-05 or PID SP S5-06].	0.0 (0.0 - 6000.0)

Note:

Parameters  $b5-46$  [PID Unit Display Selection],  $b5-38$  [PID User Unit Display Scaling], and  $b5-39$  [PID User Unit Display Digits] set the unit, range, and resolution.

### ■ S5-07: Operation HAND Key

No. (Hex.)	Name	Description	Default (Range)
S5-07 (3235)	Operation HAND Key	<input type="checkbox"/> V/f <input type="checkbox"/> OLV/IPM <input type="checkbox"/> EZOLV Sets the HAND key on the HOA keypad to let you switch between HAND Mode and AUTO Mode.	1 (0, 1)

0 : Disabled

1 : Enabled

### ■ S5-08: HAND Reference Prime Loss Level

No. (Hex.)	Name	Description	Default (Range)
S5-08 (3D31) RUN	HAND Reference Prime Loss Level	<input type="checkbox"/> V/f <input type="checkbox"/> OLV/IPM <input type="checkbox"/> EZOLV Sets the level at which the drive will detect the Loss of Prime in the pump.	0.0 (0.0 - 1000.0)

Note:

- If these conditions occur at the same time, the drive will detect LOP [Loss of Prime]:
  - The monitor set by  $Y1-18$  [Prime Loss Detection Method]  $\leq S5-08$  for longer than  $Y1-20$  [Prime Loss Time]
  - Output frequency  $\geq S5-05$  [HAND Frequency Reference]
- The drive response to the Loss of Prime condition changes when the  $Y1-22$  [Prime Loss Selection] setting changes.
- Parameter  $Y1-18$  [Prime Loss Detection Method] sets the units for this parameter.

## ■ S5-10: AUTO Key Memory at Power Down

No. (Hex.)	Name	Description	Default (Range)
S5-10 (3280) RUN	AUTO Key Memory at Power Down	<b>V/f</b> <b>OLV/PM</b> <b>EZOLV</b> Sets the function to keep the AUTO Mode status when you de-energize the drive.	2 (0 - 2)

### 0 : Disabled

The drive always powers up in OFF Mode.

### 1 : Enabled w/ Memory

When you de-energize the drive, the drive saves the AUTO Mode status. When you energize the drive again, the drive goes straight to AUTO Mode when you use the keypad to input the AUTO command.

### 2 : AUTO Mode

The drive always powers up in AUTO Mode.

## ◆ S6: Protection

*S6* parameters set the Emergency Override function.

### ■ Emergency Override

The Emergency Override function ignores faults and alarms that can stop the drive and will force the drive to run with a set speed or the frequency reference. You can use this function for an applications where it is necessary to continue the drive operation when there is an emergency situation with the installation, for example, smoke purge.

Emergency Override function will be active when:

- The terminal set for *H1-xx = AF* or *B0* [*MFDI Function Selection = Emergency Override FWD or REV*] is active
- You set bit 1 in MEMOBUS Register 15FBH for Emergency Override FWD or bit 2 in MEMOBUS register for Emergency Override REV

If FWD and REV Emergency Override selections are active at the same time, an *EF* [*External Fault*] will occur.

The values set in *S6-09* [*Emergency Override Min Speed*] and *S6-10* [*Emergency Override Max Speed*] are the lower limit and upper limit for the output frequency during Emergency Override. The drive applies upper and lower limit values to *S6-02* [*Emergency Override Ref Selection*].

While the drive is in Emergency Override Mode, the drive records the operation time in *U4-61* [*Total EMOVR Run Time*]. When the value is more than 60000 min, the alternation timer is at its maximum value. When you set *A1-03 = 2220* or *3300* [*Initialize Parameters = 2-Wire Initialization or 3-Wire Initialization*] to initialize the drive, the drive will not reset the counter.

### Functions Ignored by Emergency Override

When the drive is in factory default setting, Emergency Override ignores these digital inputs:

- Drive Enable
- Drive Enable 2
- Customer Safeties
- BAS Interlock

The drive will give priority to these inputs over Emergency Override when you set *S6-08* [*EMOVR Drive Enable Input Mode*], *S6-16* [*EMOVR Customer Safety Mode*], or *S6-17* [*EMOVR BAS Interlock Mode*] correctly.

Table 12.77 Emergency Override Behaviors of each MFDI State and Parameter Setting

H1-xx [MFDI Function Selection]	MFDI State	Parameter Setting	EMOV Behavior
6A [Drive Enable]	OFF	S6-08 = 0 [Drive Enable Status Ignored]	Enabled
	ON		Enabled
	OFF	S6-08 = 1 [EMOVRun Only When Drive Disabled]	Enabled
	ON		Disabled
70 [Drive Enable 2]	OFF	S6-08 = 0 [Drive Enable Status Ignored]	Enabled
	ON		Enabled
	OFF	S6-08 = 1 [EMOVRun Only When Drive Disabled]	Enabled
	ON		Disabled
B1 [Customer Safeties]	OFF	S6-16 = 0 [Customer Safety Ignored]	Enabled
	ON		Enabled
	OFF	S6-16 = 1 [EMOVRun Only When Safety OK]	Disabled
	ON		Enabled
	OFF	S6-16 = 2 [EMOVRun Only When Safety NOT OK]	Enabled
	ON		Disabled
B2 [BAS Interlock]	OFF	S6-17 = 0 [BAS Interlock Ignored]	Enabled
	ON		Enabled
	OFF	S6-17 = 1 [EMOVRun Only When Interlock OK]	Disabled
	ON		Enabled
	OFF	S6-17 = 2 [EMOVRun When Interlock NOT OK]	Enabled
	ON		Disabled

**Note:**

When you program more than one input to the drive, for example Drive Enable and Customer Safeties, all the inputs must align with the conditions for Emergency Override to take effect.

**Emergency Override Speed Command Operation**

When Emergency Override is active, *S6-02 [Emergency Override Reference Selection]* sets the frequency reference source:

- When *S6-02 = 0 [Use S6-01 Reference]*:  
The drive will operate at the speed set in *S6-01 [Emergency Override Speed]*.
- When *S6-02 = 1 [Use Frequency Reference]*:  
The drive will use the currently selected AUTO mode frequency reference set in *b1-01 [Frequency Reference Selection 1]* as the run speed.

When *S6-02 = 0 or 1*, MEMOBUS register 3A94H can override the Emergency Override Speed when you set register 3A93H bit 3 to ON.

**Note:**

The drive will not memorize MEMOBUS registers 3A93H and 3A94H while you re-energize the drive.

**Emergency Override PID Mode Operation**

Emergency Override will operate in PID mode and maintain the setpoint when *S6-02 = 2 [System PID Mode]* or *S6-02 = 3 [Independent PID Mode]*.

- When *S6-02 = 2*:  
Emergency Override uses the system units set in *b5-38 [PID User Unit Display Scaling]*, *b5-39 [PID User Unit Display Digits]*, and *b5-46 [PID Unit Display Selection]* and the normally selected PID Feedback and PID Setpoint. If it is necessary to override the PID Feedback and the PID Setpoint, set an analog input to *H3-xx = 2B [Emergency Override PID Feedback]* for the PID Feedback and *H3-xx = 2C [Emergency Override PID Setpoint]* for the PID Setpoint.
- When *S6-02 = 3*:

Emergency Override uses the dedicated units set in *S6-03 [EMOVR Independent PID Scale]*, *S6-04 [EMOVR Independent PID Unit]*, and *S6-05 [EMOVR Independent PID Unit Digit]*. The PID Setpoint uses the setpoint set in *S6-06 [EMOVR PID Setpoint]* if you do not set *H3-xx = 2C [Emergency Override PID Setpoint]*. The PID Feedback uses the system Feedback set in *H3-xx = B [PID Feedback]* if you do not set *H3-xx = 2B [Emergency Override PID Feedback]*.

When *S6-02 = 2 or 3*:

- MEMOBUS register 3A95H can override the Emergency Override PID Feedback when you set register 3A93H bit 4 to ON.
- MEMOBUS register 3A96H can override the Emergency Override PID Setpoint when you set register 3A93H bit 5 to ON.

**Note:**

- The drive will not memorize MEMOBUS registers 3A93H, 3A95H, and 3A96H while you re-energize the drive.
- When *S6-02 = 2 or 3*, the drive will also run in Standard PID mode when *b5-01 = 0 or 3 [PID Mode Setting = Disabled or Fref + PID Trim]*. The drive operation for Fref + PID Trim is not available during Emergency Override operation.

### Interactions with Other Drive Functions

If the drive is detecting a fault that you can reset when the Emergency Override command is activated, the drive will clear the fault. These settings do not have an effect:

- The settings of *S6-11 [EMOVR Drive Protection Fault ON]* to *S6-14 [EMOVR Application 1 Fault ON]*
- How many Auto Restart Attempts remain

**Note:**

The drive cannot reset *Err [EEPROM Write Error]* or *SCF [Safety Circuit Fault]* faults.

The Emergency Override function has priority over these functions:

- Fault Restart operation
  - *L5-01 [Number of Auto-Restart Attempts]*  
When the Emergency Override is active, the drive resets the internal counter of *L5-01* to 0 and the drive will allow an infinite number of Auto Restart Attempts.
  - Fault retry parameters: *H5-36 [CE Fault Restart Select]*, *L5-07 [Fault Reset Enable Select Grp1]*, *L5-08 [Fault Reset Enable Select Grp2]*, and *L5-53 [Thermostat Fault Retry Selection]*  
When Emergency Override is active, the drive ignores these parameter settings and the drive will always allow an infinite number of Auto Restart Attempts.
- Fast Stop operation
- *CALL [Serial Comm Transmission Error]* detection
- PID Sleep function (*Y2-02 [Sleep Level]*)
- All Run commands and direction commands  
If the drive has an applicable Run command from terminals when the drive was previously in Emergency Override and the Emergency Override digital input is now OFF, the drive will respond as specified by *S5-02 [HAND/AUTO Switchover During Run]* and *S5-04 [HAND-OFF-AUTO Behavior]*.

During Emergency Override, the drive ignores the faults in [Table 12.78](#) when *S6-07 = 0 [EMOVR Fault Suppression Mode = Fault Suppression]*:

**Table 12.78 Faults Ignored during Emergency Override**

Faults	Faults
bAT [Keypad Battery Low Voltage]	dWFL [DriveWorksEZ Fault]
bCE [Bluetooth Communication Error]	EF0 [Option Card External Fault]
bUS [Option Communication Error]	EF1 - EF7 [External Fault (Terminal Sx)]
CE [Modbus Communication Error]	Err [EEPROM Write Error]
CoF [Current Offset Fault]	FAn1 [Drive Cooling Fan Fault]
dEv [Speed Deviation]	HLCE [High Level Communications Error]
dWF1 [EEPROM Memory DWEZ Data Error]	LF [Output Phase Loss]
dWF2 [DriveWorksEZ Fault 2]	LF2 [Output Current Imbalance]
dWF3 [DriveWorksEZ Fault 3]	MSL [Net Master Lost]

Faults
nSE [Node Setup Error]
OD [Output Disconnect]
oH3 [Motor Overheat (PTC Input)]
oH4 [Motor Overheat Fault (PTC Input)]
oL1 [Motor Overload]
oL2 [Drive Overloaded]
oL3 [Overtorque Detection 1]
oL4 [Overtorque Detection 2]
oL7 [High Slip Braking Overload]
oPr [Keypad Connection Fault]
oS [Overspeed]

Faults
ov2 [DC Bus Overvoltage 2]
PE1 [PLC Fault 1]
PE2 [PLC Fault 2]
PF [Input Phase Loss]
TiM [Keypad Time Not Set]
UL3 [Undertorque Detection 1]
UL4 [Undertorque Detection 2]
UL6 [Underload or Belt Break Detected]
Uv1 [DC Bus Undervoltage]
VLTS [Thermostat Fault]

**Note:**

- During Emergency Override, the drive will not prevent oH [Heatsink Overheat] and oHI [Heatsink Overheat] faults. The drive will Auto Restart when U4-08 [Heatsink Temperature] is less than L8-02 [Overheat Alarm Level] for oH faults, or the drive Overheat Pre-Alarm Level for oHI faults.
- Emergency Override Fault Activation Bits set in S6-11 [EMOVR Drive Protection Fault ON] to S6-14 [EMOVR Application 1 Fault ON] enable the fault detection for the above functions, if necessary.

During Emergency Override, the drive ignores the alarms in Table 12.79 when S6-07 = 0:

**Table 12.79 Alarms Ignored during Emergency Override**

Alarms
bUS [Option Communication Error]
CE [Modbus Communication Error]
dnE [Drive Disabled]
INTLK [BAS Interlock]
oH3 [Motor Overheat (PTC Input)]
oL3 [Overtorque Detection 1]

Alarms
oL4 [Overtorque Detection 2]
SAFE [Customer Safeties]
UL3 [Undertorque Detection 1]
UL4 [Undertorque Detection 2]
UL6 [Underload or Belt Break Detected]

The drive ignores these alarms, but it enables these MFDO functions during Emergency Override operation:

- H2-xx = B [MFDO Function Selection = Torque Detection 1 (N.O.)]
- H2-xx = 17 [Torque Detection 1 (N.C.)]
- H2-xx = 18 [Torque Detection 2 (N.O.)]
- H2-xx = 19 [Torque Detection 2 (N.C.)]
- H2-xx = 58 [UL6 Underload Detected]

**Emergency Override Test Mode**

Emergency Override Test Mode lets you test Emergency Override operation while all drive faults stay enabled. Parameter S6-07 [EMOVR Fault Suppression Mode] controls this function.

To test Emergency Override operation, use this procedure:

1. Set S6-07 = 1 [Test Mode].  
The keypad will show an [Emergency Override Test Pending] message.
2. Activate an MFDI terminal set for H1-xx = AF or B0 [Emergency Override FWD or Emergency Override REV].  
The drive will start the Test Mode operation. The keypad will show an [Emergency Override Test Mode] message.

When the Emergency Override MFDI deactivates and the drive fully stops, Test Mode deactivates. Parameter S6-07 then automatically returns to setting 0 [Fault Suppression].

**Note:**

- The drive will keep the *S6-07* setting during a power-loss condition.
- Parameter *o1-82* [*Message Screen Display*] sets how the drive will show the messages on the keypad. Refer to [Full Screen Information Display on page 854](#) for more information.

### ■ S6-01: Emergency Override Speed

No. (Hex.)	Name	Description	Default (Range)
S6-01 (3236)	Emergency Override Speed	<div style="display: flex; justify-content: space-between; align-items: center;"> <span><input type="checkbox"/> V/f</span> <span><input type="checkbox"/> OLV/PM</span> <span><input type="checkbox"/> EZOLV</span> </div> Sets the speed command for emergency override mode when <i>S6-02</i> = 0 [ <i>Emergency Override Ref Selection = Use S6-01 Reference</i> ].	1.50 Hz (1.50 - 60.00 Hz)

**Note:**

- When *A1-02* = 8 [*Control Method Selection = EZOLV*], *E1-09* [*Minimum Output Frequency*] (*E9-04* [*Base Frequency*]) sets the lower limit, and *E1-04* [*Maximum Output Frequency*] (*E9-02* [*Maximum Speed*]) sets the upper limit.
- Parameter default is lower-limited to *E1-09* (*E9-04* when *A1-02* = 8). The default setting will automatically increase when *E1-09* (*E9-04*) > *S6-01*.

### ■ S6-02: Emergency Override Ref Selection

No. (Hex.)	Name	Description	Default (Range)
S6-02 (3237)	Emergency Override Ref Selection	<div style="display: flex; justify-content: space-between; align-items: center;"> <span><input type="checkbox"/> V/f</span> <span><input type="checkbox"/> OLV/PM</span> <span><input type="checkbox"/> EZOLV</span> </div> Sets the Emergency Override Speed Source:	0 (0 - 3)

**0 : Use S6-01 Reference**

**1 : Use Frequency Reference**

**2 : System PID Mode**

**3 : Independent PID Mode**

### ■ S6-03: EMOVR Independent PID Scale

No. (Hex.)	Name	Description	Default (Range)
S6-03 (323A)	EMOVR Independent PID Scale	<div style="display: flex; justify-content: space-between; align-items: center;"> <span><input type="checkbox"/> V/f</span> <span><input type="checkbox"/> OLV/PM</span> <span><input type="checkbox"/> EZOLV</span> </div> Sets the scaling on the Emergency PID Feedback and Setpoint (if programmed) Analog Inputs.	100.00 (0.10 - 600.00)

**Note:**

- *S6-05* [*EMOVR Independent PID Unit Digit*] sets the resolution for this parameter.
- *S6-04* [*EMOVR Independent PID Unit*] sets the units for this parameter.

### ■ S6-04: EMOVR Independent PID Unit

No. (Hex.)	Name	Description	Default (Range)
S6-04 (323B)	EMOVR Independent PID Unit	<div style="display: flex; justify-content: space-between; align-items: center;"> <span><input type="checkbox"/> V/f</span> <span><input type="checkbox"/> OLV/PM</span> <span><input type="checkbox"/> EZOLV</span> </div>	48 (0 - 50)

**0 : "WC: inches of water column**

**1 : PSI: pounds per square inch**

**2 : GPM: gallons/min**

**3 : °F: Fahrenheit**

**4 : ft<sup>3</sup>/min: cubic feet/min**

**5 : m<sup>3</sup>/h: cubic meters/hour**

**6 : L/h: liters/hour**

**7 : L/s: liters/sec**

**8 : bar: bar**

**9 : Pa: Pascal**

**10 : °C: Celsius**

11 : m: meters

12 : ft: feet

13 : L/min: liters/min

14 : m<sup>3</sup>/min: cubic meters/min

15 : “Hg: Inch Mercury

16 : kPa: kilopascal

48 : %: Percent

49 : Custom(b5-68~70)

50 : None

■ **S6-05: EMOVR Independent PID Unit Digit**

No. (Hex.)	Name	Description	Default (Range)
S6-05 (323C)	EMOVR Independent PID Unit Digit	<input type="checkbox"/> V/f <input type="checkbox"/> OLV/PM <input type="checkbox"/> EZOLV Sets the number of digits for S6-06 [EMOVR PID Setpoint] when S6-02 = 3[Emergency Override Ref Selection = Independent PID Mode].	2 (0 - 3)

0 : No Decimal Places (XXXXX)

1 : One Decimal Places (XXXX.X)

2 : Two Decimal Places (XXX.XX)

3 : Three Decimal Places (XX.XXX)

■ **S6-06: EMOVR PID Setpoint**

No. (Hex.)	Name	Description	Default (Range)
S6-06 (323D) RUN	EMOVR PID Setpoint	<input type="checkbox"/> V/f <input type="checkbox"/> OLV/PM <input type="checkbox"/> EZOLV Sets the PID Setpoint when S6-02 = 3[Emergency Override Ref Selection = Independent PID Mode].	0.00 (0 - 600.00)

**Note:**

When S6-02 = 3: units and resolution are dependent on S6-04 [EMOVR Independent PID Unit] and S6-05 [EMOVR Independent PID Unit Digit]. Value is internally limited to 300% of S6-03 [EMOVR Independent PID Scale].

■ **S6-07: EMOVR Fault Suppression Mode**

No. (Hex.)	Name	Description	Default (Range)
S6-07 (323E)	EMOVR Fault Suppression Mode	<input type="checkbox"/> V/f <input type="checkbox"/> OLV/PM <input type="checkbox"/> EZOLV Sets the drive to let Emergency Override disable faults during operation.	0 (0, 1)

0 : Fault Suppression

1 : Test Mode

■ **S6-08: EMOVR Drive Enable Input Mode**

No. (Hex.)	Name	Description	Default (Range)
S6-08 (323F)	EMOVR Drive Enable Input Mode	<input type="checkbox"/> V/f <input type="checkbox"/> OLV/PM <input type="checkbox"/> EZOLV Sets whether the Drive Enable Input (if programmed) must be inactive (drive is disabled) for Emergency Override to function.	0 (0, 1)

0 : Drive Enable Status Ignored

1 : EMOVRun Only When Drive Disabled

**Note:**

You must program Drive Enable to a Digital Input for this parameter to have an effect.



### ■ S6-09: Emergency Override Min Speed

No. (Hex.)	Name	Description	Default (Range)
S6-09 (3240)	Emergency Override Min Speed	<b>V/f</b> <b>OLV/PM</b> <b>EZOLV</b> When Emergency Override is active, the output frequency is lower-limited to this value.	0.00 Hz (0.00 - 400.00 Hz)

**Note:**

When  $A1-02 = 8$  [Control Method Selection = EZOLV], the range is 0.00 to 120.00 Hz.

### ■ S6-10: Emergency Override Max Speed

No. (Hex.)	Name	Description	Default (Range)
S6-10 (3241)	Emergency Override Max Speed	<b>V/f</b> <b>OLV/PM</b> <b>EZOLV</b> When Emergency Override is active, the output frequency is upper-limited to this value.	0.00 Hz (0.00 - 400.00)

**Note:**

• When  $A1-02 = 8$  [Control Method Selection = EZOLV], the range is 0.00 to 120.00 Hz.

• Set this parameter to 0.00 Hz to disable the limit.

### ■ S6-11: EMOVR Drive Protection Fault ON

No. (Hex.)	Name	Description	Default (Range)
S6-11 (3242) Expert	EMOVR Drive Protection Fault ON	<b>V/f</b> <b>OLV/PM</b> <b>EZOLV</b> Sets the bit to enable fault detection during Emergency Override.	0 (0 - FFFF)

**bit 0 : Uv1 - DC Bus Undervoltage**

**bit 1 : CoF - Current Offset Fault**

**bit 2 : dWF1 - EEPROM Memory DWEZ Data Error**

**bit 3 : Err - EEPROM Write Error**

**bit 4 : Reserved**

**bit 5 : Reserved**

**bit 6 : oL2 - Drive Overload**

**bit 7 : oPr - Operator Connection**

**bit 8 : PF - Input Phase Loss**

**bit 9 : Reserved**

**bit 10 : Reserved**

**bit 11 : oH - Heatsink Overheat**

**bit 12 : oH1 - Heatsink Overheat**

**bit 13 : OD - Output Disconnect**

**bit 14 : FAn1 - Cooling Fan Fault**

**bit 15 : ov2 - DC Bus Overvoltage 2**

**Note:**

The drive sets the bits in Hex.

### ■ S6-12: EMOVR Motor Protection Fault ON

No. (Hex.)	Name	Description	Default (Range)
S6-12 (3243) Expert	EMOVR Motor Protection Fault ON	<b>V/f</b> <b>OLV/PM</b> <b>EZOLV</b> Sets the bit to enable fault detection during Emergency Override.	0 (0 - FFFF)

**bit 0 : LF - Output Phase Loss**

- bit 1 : LF2 - Output Current Imbalance**
- bit 2 : oH3 - Motor Overheat PTC Input**
- bit 3 : oH4 - Motor Overheat PTC Input**
- bit 4 : Reserved**
- bit 5 : oL1 - Motor Overload**
- bit 6 : oL3 - Overtorque Detection 1**
- bit 7 : oL4 - Overtorque Detection 2**
- bit 8 : oL7 - High Slip Braking Overload**
- bit 9 : Reserved**
- bit 10 : UL3 - Undertorque Detection 1**
- bit 11 : UL4 - Undertorque Detection 2**
- bit 12 : UL6 - Motor Underload**
- bit 13 : Reserved**
- bit 14 : oS - Overspeed**
- bit 15 : dEv: Speed Deviation**

**Note:**

The drive sets the bits in Hex.

■ **S6-13: EMOVR Option Fault ON**

No. (Hex.)	Name	Description	Default (Range)
S6-13 (3244) Expert	EMOVR Option Fault ON	<b>V/f</b> <b>OLV/PM</b> <b>EZOLV</b> Sets the bit to enable fault detection during Emergency Override.	0 (0 - FFFF)

- bit 0 : bUS - Option Communication**
- bit 1 : CE - Communication Error**
- bit 2 : Reserved**
- bit 3 : EF0 - Option Card External Fault**
- bit 4 : PE1 - PLC Fault 1**
- bit 5 : PE2 - PLC Fault 2**
- bit 6 : nSE - Node Setup Error**
- bit 7 to 15 : Reserved**

**Note:**

The drive sets the bits in Hex.

■ **S6-14: EMOVR Application 1 Fault ON**

No. (Hex.)	Name	Description	Default (Range)
S6-14 (3245) Expert	EMOVR Application 1 Fault ON	<b>V/f</b> <b>OLV/PM</b> <b>EZOLV</b> Sets the bit to enable fault detection during Emergency Override.	0 (0 - FFFF)

- bit 0 : Efx - External Faults**
- bit 1 : Reserved**
- bit 2 : HLCE - High Level Communications Error**
- bit 3 : bAT - Keypad Battery Low Voltage**
- bit 4 : TiM - Keypad Time Not Set**
- bit 5 : bCE - Bluetooth Communication Fault**
- bit 6 : dWF2 - DriveWorksEZ Fault 2**

**bit 7 : dWF3 - DriveWorksEZ Fault 3**

**bit 8 : dWFL - DriveWorksEZ Fault**

**bit 9 : MSL - Net Master Lost**

**bit 10 : VLTS - Thermostat Fault**

**bit 11 to 15 : Reserved**

**Note:**

The drive sets the bits in Hex.

### ■ S6-16: EMOVR Customer Safety Mode

No. (Hex.)	Name	Description	Default (Range)
S6-16 (3247)	EMOVR Customer Safety Mode	<b>V/f</b> <b>OLV/PM</b> <b>EZOLV</b> Sets the status for the customer safety input (when programmed) that must occur for Emergency Override to function.	0 (0 - 2)

**0 : Customer Safety Ignored**

**1 : EMOVRRun Only When Safety OK**

**2 : EMOVRRun Only When Safety NOT OK**

**Note:**

You must set a customer safety to a Digital Input for this parameter to have an effect.

### ■ S6-17: EMOVR BAS Interlock Mode

No. (Hex.)	Name	Description	Default (Range)
S6-17 (3248)	EMOVR BAS Interlock Mode	<b>V/f</b> <b>OLV/PM</b> <b>EZOLV</b> Sets the status for the BAS Interlock input (when programmed) that must occur for Emergency Override to function.	0 (0 - 2)

**0 : BAS Interlock Ignored**

**1 : EMOVRRun Only When Interlock OK**

**2 : EMOVRRun When Interlock NOT OK**

**Note:**

Parameter has no effect if BAS Interlock is not programmed to a Digital Input.

### ■ S6-23: OV2 Detect Time

No. (Hex.)	Name	Description	Default (Range)
S6-23 (324E)	OV2 Detect Time	<b>V/f</b> <b>OLV/PM</b> <b>EZOLV</b> Sets the detection time of <i>ov2</i> [DC Bus Overvoltage 2] in 0.1 s increments.	10.0 s (0.0 - 1200.0 s)

**Note:**

Set this parameter to 0.0 s to disable *ov2* detection.

## 12.13 T: Auto-Tuning

*T* parameters set input data for:

- Induction Motor Auto-Tuning
- PM Motor Auto-Tuning

### ◆ T0: Tuning Mode Selection

#### ■ T0-00: Tuning Mode Selection

No. (Hex.)	Name	Description	Default (Range)
T0-00 (1197)	Tuning Mode Selection	<div style="display: flex; gap: 5px;"> <span style="border: 1px solid black; padding: 2px;">V/f</span> <span style="border: 1px solid black; padding: 2px;">OLV/PM</span> <span style="border: 1px solid black; padding: 2px;">EZOLV</span> </div> Sets the type of Auto-Tuning.	0 (0)

#### 0 : Motor Parameter Tuning

**Note:**

The available tuning modes are different for different control methods.

### ◆ T1: Induction Motor Auto-Tuning

*T1* parameters set the Auto-Tuning input data for induction motor tuning.

**Note:**

- The base frequency of drive-dedicated motors and special vector-control motors can be lower than the base frequency of general-purpose motors, which is 50 Hz or 60 Hz. In these conditions, the drive uses the lower frequency as the value for *E1-06* [Base Frequency] and *E1-04* [Maximum Output Frequency] after Auto-Tuning completes. If the maximum output frequency is too low and causes problems, change the setting of *E1-04* after Auto-Tuning completes.
- The drive automatically sets these induction motor parameters:
  - E1-xx* [V/f Pattern for Motor 1]
  - E2-xx* [Motor Parameters]
  - E3-xx* [V/f Pattern for Motor 2]
  - E4-xx* [Motor 2 Parameters]

#### ■ T1-00: Motor 1/Motor 2 Selection

No. (Hex.)	Name	Description	Default (Range)
T1-00 (0700)	Motor 1/Motor 2 Selection	<div style="display: flex; gap: 5px;"> <span style="border: 1px solid black; padding: 2px;">V/f</span> <span style="border: 1px solid black; padding: 2px;">OLV/PM</span> <span style="border: 1px solid black; padding: 2px;">EZOLV</span> </div> Sets which motor to tune when motor 1/2 switching is enabled.	1 (1, 2)

**Note:**

This parameter is available when *H1-xx* = 16 [Motor 2 Selection]. The keypad will not show this parameter when *H1-xx* ≠ 16.

#### 1 : Motor 1 (sets E1-xx, E2-xx)

Auto-Tuning automatically sets parameters *E1-xx* and *E2-xx* for motor 1.

#### 2 : Motor 2 (sets E3-xx, E4-xx)

Auto-Tuning automatically sets parameters *E3-xx* and *E4-xx* for motor 2. Make sure that you connect motor 2 to the drive for Auto-Tuning.

#### ■ T1-01: Auto-Tuning Mode Selection

No. (Hex.)	Name	Description	Default (Range)
T1-01 (0701)	Auto-Tuning Mode Selection	<div style="display: flex; gap: 5px;"> <span style="border: 1px solid black; padding: 2px;">V/f</span> <span style="border: 1px solid black; padding: 2px;">OLV/PM</span> <span style="border: 1px solid black; padding: 2px;">EZOLV</span> </div> Sets the type of Auto-Tuning.	0 (0, 2)

#### 0 : Rotational Auto-Tuning

#### 2 : Stationary Line-Line Resistance

### ■ T1-02: Motor Rated Power

No. (Hex.)	Name	Description	Default (Range)
T1-02 (0702)	Motor Rated Power	<input checked="" type="radio"/> V/f <input type="radio"/> OLV/PM <input type="radio"/> EZOLV Uses the units set in <i>o1-58 [Motor Power Unit Selection]</i> to set the motor rated output power.	Determined by o2-04 (0.00 - 650.00 HP)

### ■ T1-03: Motor Rated Voltage

No. (Hex.)	Name	Description	Default (Range)
T1-03 (0703)	Motor Rated Voltage	<input checked="" type="radio"/> V/f <input type="radio"/> OLV/PM <input type="radio"/> EZOLV Sets the rated voltage (V) of the motor. Enter the base speed voltage for constant output motors.	Determined by o2-04 (208 V Class: 0.0 - 255.5 V, 480 V Class: 0.0 - 511.0 V)

If you do Auto-Tuning on a drive-dedicated motor or a special vector-control motor, the voltage or frequency can be lower than a general-purpose motor. Always compare the data from the nameplate or test report with the Auto-Tuning results and check for differences. Enter the voltage necessary to operate the motor in no-load conditions at rated speed for better control precision around rated speed. If the motor test report or the motor nameplate is not available, enter approximately 90% of the motor rated voltage.

If the drive input power supply voltage is low, enter approximately 90% of the input voltage. When the input power supply voltage is low, the current will increase. Make sure that the main power supply capacity is correct and use a molded-case circuit breaker for the drive.

### ■ T1-04: Motor Rated Current

No. (Hex.)	Name	Description	Default (Range)
T1-04 (0704)	Motor Rated Current	<input checked="" type="radio"/> V/f <input type="radio"/> OLV/PM <input type="radio"/> EZOLV Sets the rated current (A) of the motor.	Determined by o2-04 (10% to 200% of the drive rated current)

Set the motor rated current between 50% and 100% of the drive rated current for the best performance. Enter the current at the motor base speed.

### ■ T1-05: Motor Base Frequency

No. (Hex.)	Name	Description	Default (Range)
T1-05 (0705)	Motor Base Frequency	<input checked="" type="radio"/> V/f <input type="radio"/> OLV/PM <input type="radio"/> EZOLV Sets the base frequency (Hz) of the motor.	60.0 Hz (0.0 - 400.0 Hz)

When you do Auto-Tuning, the drive sets *T1-05* to *E1-04 [Maximum Output Frequency]*. If *T1-05* < 40 Hz, *E1-04* = 40 Hz. If you operate the drive at a speed that is higher than the base frequency, or if you operate in the field weakening range, set *E1-04* (*E3-04* for motor 2) to the maximum output frequency after you complete Auto-Tuning.

### ■ T1-06: Number of Motor Poles

No. (Hex.)	Name	Description	Default (Range)
T1-06 (0706)	Number of Motor Poles	<input checked="" type="radio"/> V/f <input type="radio"/> OLV/PM <input type="radio"/> EZOLV Sets the number of motor poles.	4 (2 to 120)

### ■ T1-07: Motor Base Speed

No. (Hex.)	Name	Description	Default (Range)
T1-07 (0707)	Motor Base Speed	<input checked="" type="radio"/> V/f <input type="radio"/> OLV/PM <input type="radio"/> EZOLV Sets the motor base speed for Auto-Tuning (min <sup>-1</sup> (r/min)).	1750 min <sup>-1</sup> (r/min) (0 - 24000 min <sup>-1</sup> (r/min))

## ■ T1-11: Motor Iron Loss

No. (Hex.)	Name	Description	Default (Range)
T1-11 (070B)	Motor Iron Loss	<input type="radio"/> V/f <input checked="" type="radio"/> OLV/PM <input type="radio"/> EZOLV Sets the iron loss to calculate the energy-saving coefficient.	Determined by E2-10 or E4-10 (0 - 65535 W)

### Note:

The default setting is different for different motor codes and motor parameter settings.

The value shown is *E2-10 [Motor Iron Loss]* or *E4-10 [Motor 2 Iron Loss]* for the motor output set in *T1-02 [Motor Rated Power]*. If the motor test report is available, enter the motor iron loss value to *T1-11*.

## ◆ T2: PM Motor Auto-Tuning

*T2 parameters* set the Auto-Tuning input data for PM motor tuning.

### Note:

The drive automatically sets these PM motor parameters:

- E1-xx [V/f Pattern for Motor 1]
- E5-xx [V/f Pattern for Motor 1]

## ■ T2-01: PM Auto-Tuning Selection

No. (Hex.)	Name	Description	Default (Range)
T2-01 (0750)	PM Auto-Tuning Selection	<input type="radio"/> V/f <input checked="" type="radio"/> OLV/PM <input type="radio"/> EZOLV Sets the type of Auto-Tuning for PM motors.	0 (0 - 5)

### Note:

Yaskawa recommends Rotational (Ld, Lq, R, back-EMF) for specialized motors. Rotational Auto-Tuning rotates the motor to measure the actual induction voltage constants for more accurate control than Stationary Auto-Tuning.

### 0 : Manual Entry w/ Motor Data Sheet

#### 1 : Stationary (Ld, Lq, R)

#### 2 : Stationary (R Only)

#### 4 : Rotational (Ld, Lq, R, back-EMF)

#### 5 : High Frequency Injection

## ■ T2-02: PM Motor Code Selection

No. (Hex.)	Name	Description	Default (Range)
T2-02 (0751)	PM Motor Code Selection	<input type="radio"/> V/f <input checked="" type="radio"/> OLV/PM <input type="radio"/> EZOLV Enter the PM motor code as specified by the rotation speed and motor output.	FFFF (0000 - FFFF)

Enter the motor code in this parameter to automatically set parameters *T2-03* to *T2-14*. When you are operating a specialized motor or a non-Yaskawa motor, set this parameter to *FFFF* and enter the data from the motor nameplate or the motor test report.

You can only enter the permitted PM motor codes. Different drive control methods will accept different PM motor codes.

## ■ T2-03: PM Motor Type

No. (Hex.)	Name	Description	Default (Range)
T2-03 (0752)	PM Motor Type	<input type="radio"/> V/f <input checked="" type="radio"/> OLV/PM <input type="radio"/> EZOLV Sets the type of PM motor the drive will operate.	1 (0, 1)

### 0 : IPM motor

IPM motors have magnets in the rotor, and  $L_d \neq L_q$ .

## 1 : SPM motor

SPM motors have magnets attached to the surface of the rotor with adhesive material, and  $L_d = L_q$ .

### ■ T2-04: PM Motor Rated Power

No. (Hex.)	Name	Description	Default (Range)
T2-04 (0730)	PM Motor Rated Power	<input type="checkbox"/> V/f <input checked="" type="checkbox"/> OLV/PM <input type="checkbox"/> EZOLV Uses the units set in o1-58 [Motor Power Unit Selection] to set the PM motor rated output power.	Determined by o2-04 (0.00 - 650.00 HP)

### ■ T2-05: PM Motor Rated Voltage

No. (Hex.)	Name	Description	Default (Range)
T2-05 (0732)	PM Motor Rated Voltage	<input type="checkbox"/> V/f <input checked="" type="checkbox"/> OLV/PM <input type="checkbox"/> EZOLV Sets the rated voltage (V) of the motor.	208 V Class: 230.0 V, 480 V Class: 460.0 V (208 V Class: 0.0 - 255.0 V, 480 V Class: 0.0 - 510.0 V)

### ■ T2-06: PM Motor Rated Current

No. (Hex.)	Name	Description	Default (Range)
T2-06 (0733)	PM Motor Rated Current	<input type="checkbox"/> V/f <input checked="" type="checkbox"/> OLV/PM <input type="checkbox"/> EZOLV Sets the rated current (A) of the motor.	Determined by o2-04 (10% to 200% of the drive rated current)

### ■ T2-07: PM Motor Base Frequency

No. (Hex.)	Name	Description	Default (Range)
T2-07 (0753)	PM Motor Base Frequency	<input type="checkbox"/> V/f <input checked="" type="checkbox"/> OLV/PM <input type="checkbox"/> EZOLV Sets the base frequency (Hz) of the motor.	60.0 Hz (0.0 - 400.0 Hz)

### ■ T2-08: Number of PM Motor Poles

No. (Hex.)	Name	Description	Default (Range)
T2-08 (0734)	Number of PM Motor Poles	<input type="checkbox"/> V/f <input checked="" type="checkbox"/> OLV/PM <input type="checkbox"/> EZOLV Sets the number of motor poles.	4 (2 - 120)

### ■ T2-10: PM Motor Stator Resistance

No. (Hex.)	Name	Description	Default (Range)
T2-10 (0754)	PM Motor Stator Resistance	<input type="checkbox"/> V/f <input checked="" type="checkbox"/> OLV/PM <input type="checkbox"/> EZOLV Sets the stator resistance for each motor phase.	Determined by T2-02 (0.000 - 65.000 Ω)

**Note:**

This parameter does not set line-to-line resistance.

### ■ T2-11: PM Motor d-Axis Inductance

No. (Hex.)	Name	Description	Default (Range)
T2-11 (0735)	PM Motor d-Axis Inductance	<input type="checkbox"/> V/f <input checked="" type="checkbox"/> OLV/PM <input type="checkbox"/> EZOLV Sets the d-axis inductance of the motor on a per phase basis.	Determined by T2-02 (0.00 - 600.00 mH)

■ T2-12: PM Motor q-Axis Inductance

No. (Hex.)	Name	Description	Default (Range)
T2-12 (0736)	PM Motor q-Axis Inductance	<div style="display: flex; justify-content: space-between; align-items: center;"> <span>V/f</span> <span style="border: 1px solid black; padding: 2px;">OLV/PM</span> <span style="border: 1px solid black; padding: 2px;">EZOLV</span> </div> Sets the q-Axis inductance of the motor on a per phase basis.	Determined by T2-02 (0.00 - 600.00 mH)

■ T2-13: Back-EMF Units Selection

No. (Hex.)	Name	Description	Default (Range)
T2-13 (0755)	Back-EMF Units Selection	<div style="display: flex; justify-content: space-between; align-items: center;"> <span>V/f</span> <span style="border: 1px solid black; padding: 2px;">OLV/PM</span> <span style="border: 1px solid black; padding: 2px;">EZOLV</span> </div> Sets the units that the drive uses to set the induced voltage constant.	0 (0, 1)

0 : mV/(rev/min)

1 : mV/(rad/s)

**Note:**

- When T2-13 = 0, the drive will use E5-24 [PM Back-EMF L-L Vrms (mV/rpm)] and will automatically set E5-09 [PM Back-EMF Vpeak (mV/(rad/s))] = 0.0.
- When T2-13 = 1, the drive will use E5-09 and will automatically set E5-24 = 0.0.

■ T2-14: Back-EMF Voltage Constant (Ke)

No. (Hex.)	Name	Description	Default (Range)
T2-14 (0737)	Back-EMF Voltage Constant (Ke)	<div style="display: flex; justify-content: space-between; align-items: center;"> <span>V/f</span> <span style="border: 1px solid black; padding: 2px;">OLV/PM</span> <span style="border: 1px solid black; padding: 2px;">EZOLV</span> </div> Sets the motor induced voltage constant (Ke).	Determined by T2-13 (0.0 - 2000.0)

■ T2-15: Pull-In Current Level

No. (Hex.)	Name	Description	Default (Range)
T2-15 (0756)	Pull-In Current Level	<div style="display: flex; justify-content: space-between; align-items: center;"> <span>V/f</span> <span style="border: 1px solid black; padding: 2px;">OLV/PM</span> <span style="border: 1px solid black; padding: 2px;">EZOLV</span> </div> Sets the level of the pull-in current as a percentage of E5-03 [PM Motor Rated Current (FLA)]. Usually it is not necessary to change this setting.	30% (0 - 120%)

If the load inertia is high, increase the setting value.

◆ T4: EZ Tuning

Use T4 parameters to input the data necessary for motor parameter Auto-Tuning when AI-02 = 8 [Control Method Selection = EZ Vector Control]. These two modes are available:

T4-01 Setting	Operational Overview	Items Input for Tuning	Items Tuned
0	Manually enter the necessary motor parameters.	<ul style="list-style-type: none"> <li>• T4-02 [Motor Type Selection]</li> <li>• T4-03 [Motor Max Revolutions]</li> <li>• T4-04 [Motor Rated Revolutions]</li> <li>• T4-05 [Motor Rated Frequency] *1</li> <li>• T4-06 [Motor Rated Voltage]</li> <li>• T4-07 [Motor Rated Current]</li> <li>• T4-08 [Motor Rated Capacity]</li> <li>• T4-09 [Number of Poles]</li> </ul>	<ul style="list-style-type: none"> <li>• E9-01 [Motor Type Selection]</li> <li>• E9-02 [Maximum Speed]</li> <li>• E9-03 [Rated Speed]</li> <li>• E9-04 [Base Frequency]</li> <li>• E9-05 [Base Voltage]</li> <li>• E9-06 [Motor Rated Current (FLA)]</li> <li>• E9-07 [Motor Rated Power]</li> <li>• E9-08 [Motor Pole Count]</li> <li>• E9-09 [Motor Rated Slip]</li> <li>• E9-10 [Motor Line-to-Line Resistance]</li> </ul>
1	Do only line-to-line resistance tuning.	Motor Rated Current	E9-10 [Motor Line-to-Line Resistance]

\*1 When you use a PM motor or a synchronous reluctance motor, it is not necessary to enter the rated frequency. The drive will use the rated rotation speed and number of motor poles to automatically calculate the rated frequency.



### ■ T4-01: EZ Tuning Mode Selection

No. (Hex.)	Name	Description	Default (Range)
T4-01 (3130)	EZ Tuning Mode Selection	<input type="radio"/> V/f <input type="radio"/> OLV/PM <input checked="" type="radio"/> EZOLV Sets the type of Auto-Tuning for EZOLV control.	0 (0, 1)

#### 0 : Motor Parameter Setting

#### 1 : Line-to-Line Resistance

### ■ T4-02: Motor Type Selection

No. (Hex.)	Name	Description	Default (Range)
T4-02 (3131)	Motor Type Selection	<input type="radio"/> V/f <input type="radio"/> OLV/PM <input checked="" type="radio"/> EZOLV Sets the type of motor.	0 (0, 1, 2)

#### 0 : Induction (IM)

#### 1 : Permanent Magnet (PM)

#### 2 : Synchronous Reluctance (SynRM)

### ■ T4-03: Motor Max Revolutions

No. (Hex.)	Name	Description	Default (Range)
T4-03 (3132)	Motor Max Revolutions	<input type="radio"/> V/f <input type="radio"/> OLV/PM <input checked="" type="radio"/> EZOLV Sets the maximum motor revolutions ( $\text{min}^{-1}$ ).	- ((40 to 120 Hz) $\times$ 60 $\times$ 2 / E9-08)

### ■ T4-04: Motor Rated Revolutions

No. (Hex.)	Name	Description	Default (Range)
T4-04 (3133)	Motor Rated Revolutions	<input type="radio"/> V/f <input type="radio"/> OLV/PM <input checked="" type="radio"/> EZOLV Sets rated rotation speed ( $\text{min}^{-1}$ ) of the motor.	- ((40 Hz to 120 Hz) $\times$ 60 $\times$ 2 / E9-08)

### ■ T4-05: Motor Rated Frequency

No. (Hex.)	Name	Description	Default (Range)
T4-05 (3134)	Motor Rated Frequency	<input type="radio"/> V/f <input type="radio"/> OLV/PM <input checked="" type="radio"/> EZOLV Sets the rated frequency (Hz) of the motor.	Determined by E9-01 and o2-04 (40.0 - 120.0 Hz)

#### Note:

When  $T4-02 = 1, 2$  [Motor Type Selection = Permanent Magnet (PM), Synchronous Reluctance (SynRM)], input is not necessary because it assumes: Motor Rated Revolutions/60  $\times$  Number of Motor Poles/2.

### ■ T4-06: Motor Rated Voltage

No. (Hex.)	Name	Description	Default (Range)
T4-06 (3135)	Motor Rated Voltage	<input type="radio"/> V/f <input type="radio"/> OLV/PM <input checked="" type="radio"/> EZOLV Sets the rated voltage (V) of the motor.	208 V Class: 230.0 V, 480 V Class: 460.0 V (208 V Class: 0.0 - 255.0 V, 480 V Class: 0.0 - 510.0 V)

### ■ T4-07: Motor Rated Current

No. (Hex.)	Name	Description	Default (Range)
T4-07 (3136)	Motor Rated Current	<input type="checkbox"/> V/f <input type="checkbox"/> OLVI/PM <input checked="" type="checkbox"/> EZOLV Sets the rated current (A) of the motor.	Determined by o2-04 (10% to 200% of the drive rated current)

**Note:**

The value set here becomes the base value for motor protection and the torque limit.

### ■ T4-08: Motor Rated Capacity

No. (Hex.)	Name	Description	Default (Range)
T4-08 (3137)	Motor Rated Capacity	<input type="checkbox"/> V/f <input type="checkbox"/> OLVI/PM <input checked="" type="checkbox"/> EZOLV Sets the motor rated power in the units set in o1-58 [Motor Power Unit Selection].	Determined by E9-10 (0.10 - 650.00 HP)

### ■ T4-09: Number of Poles

No. (Hex.)	Name	Description	Default (Range)
T4-09 (3138)	Number of Poles	<input type="checkbox"/> V/f <input type="checkbox"/> OLVI/PM <input checked="" type="checkbox"/> EZOLV Sets the number of motor poles.	Determined by E9-01 (2 - 120)

## 12.14 Y: Application Features

### ◆ Y1: Application Basics

#### ■ Y1-01: Multiplex Mode

No. (Hex.)	Name	Description	Default (Range)
Y1-01 (3C00)	Multiplex Mode	<input type="checkbox"/> V/f <input type="checkbox"/> OLV/PM <input type="checkbox"/> EZOLV Sets the base operation mode of the drive controller.	0 (0, 3)

#### 0 : Drive Only

Designed for single pump stand-alone applications.

#### 3 : Memobus Network

You can network maximum of four drives together for system redundancy and accurate control.

These functions will operate slightly different when  $Y1-01 = 3$ :

- Start Level: Active on the first pump in the network. Drives that are staging or in alternation will not undergo this process.
- Sleep: Active when the drive is the only drive running on the network.
- Pre-charge: Active only on the first drive to run in the network.
- Low City Pressure: Active on any drive in the network. An alarm condition will cause other drives in the network to stop running and show a “Network Drive Error” “Check Faulted Drive” message.
- Utility Delay: When this function is active, the drive is unavailable to the HV600 MEMOBUS network and the Home screen text will show “Idle: No AUTO Cmd”.

#### ■ Y1-04: Sleep Wake-up Level

No. (Hex.)	Name	Description	Default (Range)
Y1-04 (3C03) RUN	Sleep Wake-up Level	<input type="checkbox"/> V/f <input type="checkbox"/> OLV/PM <input type="checkbox"/> EZOLV Sets the level that feedback must be less than for the time set in $Y1-05$ [Sleep Wake-up Level Delay Time] to start the system. This level also sets the wake up level when the drive is in Sleep Mode. When $Y1-04 < 0$ , the feedback level must decrease this amount to less than the setpoint.	0.0% (0.00 - 99.99%)

#### Note:

- When PID operates in reverse mode, the feedback value must increase to more than the start level for the time set in  $Y1-05$  for the system to start.
- When  $Y2-01 = 5$  [Sleep Level Type = Output Frequency (non-PID)], the drive will ignore this parameter.
- When  $Y1-01 = 3$  [Multiplex Mode = Memobus Network], function is active only on the first drive in the network. Drives that are staging or in alternation will not undergo this process.
- Set this parameter to 0.0 to disable the function.
- Range is 0.00 to 99.99 with a delta symbol ( $\Delta$ ) to identify Delta to Setpoint.
- Display unit and scaling change when the system units change.

#### ■ Y1-05: Sleep Wake-up Level Delay Time

No. (Hex.)	Name	Description	Default (Range)
Y1-05 (3C04) RUN	Sleep Wake-up Level Delay Time	<input type="checkbox"/> V/f <input type="checkbox"/> OLV/PM <input type="checkbox"/> EZOLV Sets the drive to start the System again when the feedback decreases to less than $Y1-04$ [Sleep Wake-up Level] for the time set in this parameter.	1 s (0 - 3600 s)

#### ■ Y1-06: Minimum Speed

No. (Hex.)	Name	Description	Default (Range)
Y1-06 (3C05) RUN	Minimum Speed	<input type="checkbox"/> V/f <input type="checkbox"/> OLV/PM <input type="checkbox"/> EZOLV Sets the minimum frequency at which the drive will run. The drive applies this setting to HAND and AUTO modes.	0.0 Hz Determined by Y1-07

**Note:**

- The unit, decimal place, and setting range change when the *Y1-07 [Minimum Speed Units]* setting changes:
  - *Y1-07 = 0 [Hz]*: The setting range is 0.0 Hz to *E1-04* Hz.
  - *Y1-07 = 1 [RPM]*: The setting range is 0 RPM to (*E1-04* × 60) RPM.
- When *A1-02 = 8 [Control Method Selection = EZ Vector Control]*, the range is 0.0 Hz to (*E9-02* × 2) Hz.

■ **Y1-07: Minimum Speed Units**

No. (Hex.)	Name	Description	Default (Range)
Y1-07 (3C06)	Minimum Speed Units	<input type="checkbox"/> V/f <input type="checkbox"/> OLV/IPM <input type="checkbox"/> EZOLV Sets the units and decimal place for <i>Y1-06 [Minimum Speed]</i> .	0 (0, 1)

**0 : Hz**

**1 : RPM**

**Note:**

Changing *Y1-07* will set *Y1-06 [Minimum Speed]* to the default value.

■ **Y1-08: Low Feedback Level**

No. (Hex.)	Name	Description	Default (Range)
Y1-08 (3C07) RUN	Low Feedback Level	<input type="checkbox"/> V/f <input type="checkbox"/> OLV/IPM <input type="checkbox"/> EZOLV Sets the lower detection level for the PID feedback.	0.00% (0.00 - 99.99%)

**Note:**

- Parameters *b5-46 [PID Unit Display Selection]*, *b5-38 [PID User Unit Display Scaling]*, and *b5-39 [PID User Unit Display Digits]* set the unit, scaling, and resolution.
- Range is 0.00 to 99.99 with a delta symbol (Δ) to identify Delta to Setpoint.

■ **Y1-09: Low Feedback Lvl Fault Dly Time**

No. (Hex.)	Name	Description	Default (Range)
Y1-09 (3C08) RUN	Low Feedback Lvl Fault Dly Time	<input type="checkbox"/> V/f <input type="checkbox"/> OLV/IPM <input type="checkbox"/> EZOLV Sets the delay time for the drive to detect an <i>LFB [Low Feedback Sensed]</i> fault after the feedback level decreases to less than the value set in <i>Y1-08 [Low Feedback Level]</i> .	10 s (0 - 3600 s)

**Note:**

- Set *Y1-10 = 0 [Low Feedback Selection = Fault (and Digital Output)]* to enable this parameter.
- When *Y1-01 = 3 [Multiplex Mode = Memobus Network]*, *Y9-18 [Staging Mode]* uses this value to calculate the quick de-stage feedback level.

■ **Y1-10: Low Feedback Selection**

No. (Hex.)	Name	Description	Default (Range)
Y1-10 (3C09)	Low Feedback Selection	<input type="checkbox"/> V/f <input type="checkbox"/> OLV/IPM <input type="checkbox"/> EZOLV Sets the drive response when the feedback decreases to less than <i>Y1-08 [Low Feedback Level]</i> for longer than the time set in <i>Y1-09 [Low Feedback Lvl Fault Dly Time]</i> .	0 (0 - 2)

The drive enables the Low Feedback detection when:

- Parameter *Y1-08 > 0.0*
- Drive is running in AUTO Mode, including sleep boost and feedback drop detection (*b5-09 = 0 [PID Output Level Selection = Normal Output (Direct Acting)]*)
- There is a Run command, including sleep and timer operation (*b5-09 = 1 [Reverse Output (Reverse Acting)]*)

**0 : Fault (and Digital Output)**

The keypad will show *LFB [Low Feedback Sensed]* and the motor coasts to stop. The output terminal set for *H2-xx = 97 [MFDO Function Selection = Low Feedback]* will activate.

To deactivate the digital output, do a Fault Reset.

## 1 : Alarm (and Digital Output)

The keypad will show *LOFB [Low Feedback Sensed]* and the output terminal set for  $H2-xx = 97$  will activate.

To deactivate the digital output and clear the alarm, increase the feedback to more than  $Y1-08 + Y1-14$  [*Feedback Hysteresis Level*], or make sure that one or more of the conditions that enable Low Feedback detection are no longer true.

## 2 : Digital Output Only

The output terminal set for  $H2-xx = 97$  will activate.

To deactivate the digital output and clear the alarm, increase the feedback to more than  $Y1-08 + Y1-14$ , or make sure that one or more of the conditions that enable Low Feedback detection are no longer true.

### ■ Y1-11: High Feedback Level

No. (Hex.)	Name	Description	Default (Range)
Y1-11 (3C0A) RUN	High Feedback Level	<b>V/f</b> <b>OLV/PM</b> <b>EZOLV</b> Sets the upper detection level for the PID feedback.	0.00% (0.00 - 99.99%)

**Note:**

- Parameters  $b5-46$  [*PID Unit Display Selection*],  $b5-38$  [*PID User Unit Display Scaling*], and  $b5-39$  [*PID User Unit Display Digits*] set the unit, scaling, and resolution.
- Range is 0.00 to 99.99 with a delta symbol ( $\Delta$ ) to identify Delta to Setpoint.

### ■ Y1-12: High Feedback Lvl Fault Dly Time

No. (Hex.)	Name	Description	Default (Range)
Y1-12 (3C0B) RUN	High Feedback Lvl Fault Dly Time	<b>V/f</b> <b>OLV/PM</b> <b>EZOLV</b> Sets the delay time between when the drive detects high feedback until the drive faults on an <i>HFB [High Feedback Sensed]</i> fault.	5 s (0 - 3600 s)

**Note:**

This parameter is effective only when  $Y1-13 = 0$  [*High Feedback Selection = Fault (and Digital Output)*].

### ■ Y1-13: High Feedback Selection

No. (Hex.)	Name	Description	Default (Range)
Y1-13 (3C0C)	High Feedback Selection	<b>V/f</b> <b>OLV/PM</b> <b>EZOLV</b> Sets the drive response when the feedback increased to more than $Y1-11$ [ <i>High Feedback Level</i> ] for longer than the time set in $Y1-12$ [ <i>High Feedback Lvl Fault Dly Time</i> ].	0 (0 - 2)

The drive enables the High Feedback detection when:

- Parameter  $Y1-11 > 0.0$
- There is a Run command, including sleep and timer operation ( $b5-09 = 0$  [*PID Output Level Selection = Normal Output (Direct Acting)*])
- Drive is running in AUTO Mode, including feedback drop detection ( $b5-09 = 1$  [*Reverse Output (Reverse Acting)*])

## 0 : Fault (and Digital Output)

The keypad will show *HFB [High Feedback Sensed]* and the motor coasts to stop. The output terminal set for  $H2-xx = 96$  [*MFDO Function Selection = High Feedback*] will activate.

To deactivate the digital output, do a Fault Reset.

## 1 : Alarm (and Digital Output)

The keypad will show *HIFB [High Feedback Sensed]* and the output terminal set for  $H2-xx = 96$  will activate.

To deactivate the digital output and clear the alarm, decrease the feedback to be less than  $Y1-11 - Y1-14$  [*Feedback Hysteresis Level*], or make sure that one or more of the conditions that enable High Feedback detection are no longer true.

## 2 : Digital Output Only

The output terminal set for  $H2-xx = 96$  will activate.

To deactivate the digital output and clear the alarm, decrease the feedback to be less than  $Y1-11 - Y1-14$ , or make sure that one or more of the conditions that enable High Feedback detection are no longer true.

### ■ Y1-14: Feedback Hysteresis Level

No. (Hex.)	Name	Description	Default (Range)
Y1-14 (3C0D) RUN	Feedback Hysteresis Level	<input type="checkbox"/> V/f <input type="checkbox"/> OLV/IPM <input type="checkbox"/> EZOLV Sets the hysteresis level for low and high level feedback detection.	0.0% (0.0 - 10.00%)

**Note:**

Parameters  $b5-46$  [PID Unit Display Selection],  $b5-38$  [PID User Unit Display Scaling], and  $b5-39$  [PID User Unit Display Digits] set the unit, scaling, and resolution.

### ■ Y1-15: Maximum Setpoint Difference

No. (Hex.)	Name	Description	Default (Range)
Y1-15 (3C0E) RUN	Maximum Setpoint Difference	<input type="checkbox"/> V/f <input type="checkbox"/> OLV/IPM <input type="checkbox"/> EZOLV Sets a percentage of difference between the setpoint and the feedback. The difference must be more than this value for the time set in $Y1-16$ [Not Maintaining Setpoint Time] to trigger the drive response set in $Y1-17$ [Not Maintaining Setpoint Sel].	0.0% (0.0 - 6000.0%)

**Note:**

- Unit and decimal place change when the system units change.
- If there is a fault, the drive will coast to a stop.
- Set this parameter to 0.0 to disable the function.
- This function is only active during run when in Auto Mode.
- When  $Y1-01 = 3$  [Multiplex Mode = Memobus Network], the function is active on the lead drive, but will stop all drives running on the network if there is an NMS [Setpoint Not Met] fault (system fault).

### ■ Y1-16: Not Maintaining Setpoint Time

No. (Hex.)	Name	Description	Default (Range)
Y1-16 (3C0F) RUN	Not Maintaining Setpoint Time	<input type="checkbox"/> V/f <input type="checkbox"/> OLV/IPM <input type="checkbox"/> EZOLV Sets the delay time before a Setpoint Not Met condition occurs. The drive must detect the setpoint difference set in $Y1-15$ [Maximum Setpoint Difference] before the timer will start.	60 s (0 - 3600 s)

**Note:**

Set  $Y1-15 = 0$  [Maximum Setpoint Difference = 0] to disable this function.

### ■ Y1-17: Not Maintaining Setpoint Sel

No. (Hex.)	Name	Description	Default (Range)
Y1-17 (3C10)	Not Maintaining Setpoint Sel	<input type="checkbox"/> V/f <input type="checkbox"/> OLV/IPM <input type="checkbox"/> EZOLV Sets the drive response when the feedback increases to more or decreases to less than the setpoint for more than the amount set in $Y1-15$ [Maximum Setpoint Difference].	0 (0 - 2)

The drive enables the Not Maintaining Set Point detection when:

- Drive is operating in PID control ( $b5-01 \neq 0$  [PID Mode Setting  $\neq$  Disabled])
- Drive is operating in AUTO Mode
- Drive is not in Pre-Charge Mode
- Drive is not in the sleep state
- Drive is not in stabilization delay condition after staging or de-staging while in MEMOBUS multiplex Mode
- Parameter  $Y1-15 > 0$  [Maximum Setpoint Difference  $> 0$ ]

### 0 : Fault (and Digital Output)

The keypad will show an NMS [Setpoint Not Met] fault and the motor coasts to stop. The output terminal set for  $H2-xx = AC$  [Setpoint Not Maintained] will activate.

To deactivate the digital output, do a Fault Reset.

- If Not Maintaining Setpoint condition continues for longer than *Y1-16 [Not Maintaining Setpoint Time]* the drive will detect an *NMS* fault.
- If the feedback increases or decreases to less than *Y1-15* from the setpoint before *Y1-16* expires, the drive will deactivate the output terminal, clear the alarm, and reset *Y1-16*.

### 1 : Alarm (and Digital Output)

The keypad will show an *NMS [Setpoint Not Met]* alarm and the output terminal set for *H2-xx = AC* will activate.

To deactivate the digital output and clear the alarm, increase or decrease the feedback to less than *Y1-15* from the setpoint.

**Note:**

There is no time limit for this condition.

### 2 : Digital Output Only

The drive will detect Not Maintaining Setpoint and the output terminal set for *H2-xx = AC* will activate.

To deactivate the digital output, increase or decrease the feedback to less than *Y1-15* from the setpoint.

**Note:**

There is no time limit for this condition.

## ■ Y1-18: Prime Loss Detection Method

No. (Hex.)	Name	Description	Default (Range)
Y1-18 (3C11)	Prime Loss Detection Method	<b>V/f</b> <b>OLV/PM</b> <b>EZOLV</b> Sets the units and quantity that the drive will use to determine <i>LOP [Loss of Prime]</i> .	0 (0 - 2)

The drive compares the *U1-03 [Output Current]*, *U1-08 [Output Power]*, or *U1-09 [Torque Ref]* value with these *LOP* Detection Level parameters:

- *b5-84 [Feedback Loss Loss Of Prime Lvl]*
- *S5-08 [HAND Reference Prime Loss Level]*
- *Y1-19 [Prime Loss Level]*
- *Y4-05 [Pre-Charge Loss of Prime Level]*

### 0 : Current (A)

### 1 : Power (kW)

### 2 : Torque (%)

**Note:**

The monitors compared with *LOP* Detection Level are different for different control methods:

- V/f, OLV/PM: *U6-01 [Iq Secondary Current]*
- EZOLV: *U1-09 [Torque Reference]*

## ■ Y1-19: Prime Loss Level

No. (Hex.)	Name	Description	Default (Range)
Y1-19 (3C12) RUN	Prime Loss Level	<b>V/f</b> <b>OLV/PM</b> <b>EZOLV</b> Sets the level to detect the <i>LOP [Loss of Prime]</i> in the pump when in Auto or Sleep Boost Mode.	0.0 (0.0 - 1000.0)

**Note:**

*Y1-18 [Prime Loss Detection Method]* selection sets the units for this parameter.

### ■ Y1-20: Prime Loss Time

No. (Hex.)	Name	Description	Default (Range)
Y1-20 (3C13) RUN	Prime Loss Time	<div style="display: flex; gap: 5px;"> <span>V/f</span> <span>OLV/PM</span> <span>EZOLV</span> </div> Sets the delay time before the drive detects an <i>LOP [Loss of Prime]</i> condition. The timer starts when the drive detects the conditions in <i>Y1-18 [Prime Loss Detection Method]</i> and <i>Y1-19 [Prime Loss Level]</i> .	20 s (0 - 600 s)

### ■ Y1-21: Prime Loss Activation Freq

No. (Hex.)	Name	Description	Default (Range)
Y1-21 (3C14)	Prime Loss Activation Freq	<div style="display: flex; gap: 5px;"> <span>V/f</span> <span>OLV/PM</span> <span>EZOLV</span> </div> Sets the frequency level above which the drive enables Loss of Prime detection.	0.0 Hz (0.0 - E1-04 Hz)

**Note:**

- When *A1-02 = 8 [Control Method Selection = EZOLV]*, the upper limit is the Hz equivalent of *E9-02 [Maximum Speed]*.
- When *H1-xx = 16 [MFDD Function Selection = Motor 2 Selection]* for Motor 2, the upper limit is the larger value between *E1-04 [Maximum Output Frequency]* and *E3-04 [Motor 2 Maximum Output Frequency]*.

### ■ Y1-22: Prime Loss Selection

No. (Hex.)	Name	Description	Default (Range)
Y1-22 (3C15)	Prime Loss Selection	<div style="display: flex; gap: 5px;"> <span>V/f</span> <span>OLV/PM</span> <span>EZOLV</span> </div> Sets the drive response when the drive is in the Loss of Prime condition.	0 (0 - 2)

#### 0 : Fault (and Digital Output)

The keypad shows an *LOP [Loss of Prime]* fault and the motor coasts to stop. The output terminal set for *H2-xx = 94 [MFDO Function Selection = Loss of Prime]* will activate.

To deactivate the digital output, do a Fault Reset.

#### 1 : Alarm (and Digital Output)

The keypad shows an *LOP [Loss of Prime]* alarm and the output terminal set for *H2-xx = 94* will activate.

#### 2 : Digital Output Only

The output terminal set for *H2-xx = 94* will activate.

### ■ Y1-23: Prime Loss Max Restart Time

No. (Hex.)	Name	Description	Default (Range)
Y1-23 (3C16)	Prime Loss Max Restart Time	<div style="display: flex; gap: 5px;"> <span>V/f</span> <span>OLV/PM</span> <span>EZOLV</span> </div> Sets the time in minutes that the drive will wait before it tries a restart after a restart fails or after it does not do a restart because of a fault.	0.2 min (0.2 - 6000.0 min)

### ■ Y1-40: Maximum Speed

No. (Hex.)	Name	Description	Default (Range)
Y1-40 (3C27) RUN	Maximum Speed	<div style="display: flex; gap: 5px;"> <span>V/f</span> <span>OLV/PM</span> <span>EZOLV</span> </div> Sets the maximum speed.	0.0 Hz (Determined by A1-02)

**Note:**

This parameter is not effective when *Y1-40 = 0.0 Hz* or *Y1-40 > E1-04 [Maximum Output Frequency] × d2-01 [Frequency Reference Upper Limit]*.



## ◆ Y2: PID Sleep and Protection

### ■ Sleep Function

The Sleep Function uses the monitor data set in *Y2-01 [Sleep Level Type]* to know if the drive is necessary in the system and turn off the drive.

This function helps to save the energy and prevent the deterioration on the motor.

#### Sleep Activation Level and Sleep Level

##### • Sleep Activation Level:

This level sets when the Sleep Function should start operation. You can use *Y2-04 [Sleep Activation Level]* or Minimum Speed (the largest value from *d2-02*, *Y1-06*, and *Y4-12*) to set this level.

When the output frequency increases to more than the Sleep Activation Level, the Sleep Function will start to monitor the system.

##### • Sleep Level:

This is the level that the drive uses to go to sleep (stop). You can use *Y2-02 [Sleep Level]* or Minimum Speed to set this level.

#### Delta to Setpoint Entry for Sleep Wake-up Level

Delta to Setpoint Entry lets you set *Y1-04 [Sleep Wake-up Level]* relative to the current setpoint and set a PID setpoint when PID is not active.

Table 12.80 Absolute Mode and Delta to Setpoint Mode

Entry Mode	Keypad Display	Description
Absolute	<pre> 10:00 am FWD Parameters Sleep Wake-up Level Y1-04 Absolute Mode 020.00 % Default : 0.00% Range : 0.00~99.99 Back Default Min/Max </pre>	The value set for <i>Y1-04</i> represents the feedback level that will wake-up the drive. You can set <i>Y1-04</i> as an absolute value.
Delta to Setpoint	<pre> 10:00 am FWD Parameters Sleep Wake-up Level Y1-04 Delta to Setpoint Mode Δ20.00 % Default : 0.00% Range : 0.00~99.99 Back Default Min/Max </pre>	<p>When the left-most digit changes to a Δ (delta), you can set a Sleep Wake-up Level relative to the setpoint.</p> <p>The effective Wake-up Level changes when <i>b5-09</i> changes:</p> <ul style="list-style-type: none"> <li>• <i>b5-09 = 0</i>: "Setpoint - <i>Y1-04</i>"</li> <li>• <i>b5-09 = 1</i>: "Setpoint + <i>Y1-04</i>"</li> </ul>

### ■ Y2-01: Sleep Level Type

No. (Hex.)	Name	Description	Default (Range)
Y2-01 (3C64)	Sleep Level Type	<div style="display: flex; gap: 5px;"> <span>V/f</span> <span>OLV/PM</span> <span>EZOLV</span> </div> Sets the data source that the drive uses to know when to activate the Sleep Function.	5 (0 - 5)

**0 : Output Frequency**

**1 : Output Current**

**2 : Feedback**

**3 : Output Speed (RPM)**

**5 : Output Frequency (non-PID)**

#### Note:

- Feedback depends on PID direction operation.
- When the Sleep Function is active, the keypad will show the "Sleep" Alarm.

### ■ Y2-02: Sleep Level

No. (Hex.)	Name	Description	Default (Range)
Y2-02 (3C65) RUN	Sleep Level	<div style="display: flex; gap: 5px;"> <span>V/f</span> <span>OLV/PM</span> <span>EZOLV</span> </div> Sets the level that the level type set in Y2-01 [Sleep Level Type] must be at for the time set in Y2-03 [Sleep Delay Time] for the drive to enter Sleep Mode.	0.0 (0.0 - 6000.0)

When the monitor data of the level type set in Y2-01 is less than this level for longer than the time set in Y2-03, the drive will enter Sleep Mode.

**Note:**

- When you set this parameter to 0.0, this function will not be active.
- This function is active only when the drive operates in AUTO Mode.
- When Y2-01 = 5 [Output Frequency (non-PID)], the drive will disable the Sleep function when you set this parameter to 0.0.
- When Y2-01 ≠ 5, the drive will set the sleep level to the largest value from d2-02 [Frequency Reference Lower Limit], Y1-06 [Minimum Speed], and Y4-12 [Thrust Frequency] when you set this parameter to 0.0.

### ■ Y2-03: Sleep Delay Time

No. (Hex.)	Name	Description	Default (Range)
Y2-03 (3C66) RUN	Sleep Delay Time	<div style="display: flex; gap: 5px;"> <span>V/f</span> <span>OLV/PM</span> <span>EZOLV</span> </div> Sets the delay time before the drive enters Sleep Mode when the drive is at the sleep level set in Y2-02 [Sleep Level].	5 s (0 - 3600 s)

### ■ Y2-04: Sleep Activation Level

No. (Hex.)	Name	Description	Default (Range)
Y2-04 (3C67) RUN	Sleep Activation Level	<div style="display: flex; gap: 5px;"> <span>V/f</span> <span>OLV/PM</span> <span>EZOLV</span> </div> Sets the level above which the output frequency must increase to activate the Sleep Function when Y2-01 = 0, 3, or 5 [Sleep Level Type = Output Frequency, Output Speed (RPM), or Output Frequency (non-PID)].	0.0 (0.0 - 6000.0)

**Note:**

- When you set this parameter to 0.0, this function will not be active, and the Sleep Function will activate above the minimum speed (largest value from d2-02 [Frequency Reference Lower Limit], Y1-06 [Minimum Speed], and Y4-12 [Thrust Frequency]).
- The unit for this parameter is usually Hz. When Y2-01 = 3 [Sleep Level Type = Output Speed (RPM)], the unit is RPM.

### ■ Y2-05: Sleep Boost Level

No. (Hex.)	Name	Description	Default (Range)
Y2-05 (3C68) RUN	Sleep Boost Level	<div style="display: flex; gap: 5px;"> <span>V/f</span> <span>OLV/PM</span> <span>EZOLV</span> </div> Sets the quantity of boost that the drive applies to the setpoint before it goes to sleep.	0.00 (0.00 - 600.00)

**Note:**

- Parameters b5-46 [PID Unit Display Selection], b5-38 [PID User Unit Display Scaling], and b5-39 [PID User Unit Display Digits] set the unit, scaling, and resolution.
- Set this parameter to 0.00 to disable Sleep Boost Function.

### ■ Y2-06: Sleep Boost Hold Time

No. (Hex.)	Name	Description	Default (Range)
Y2-06 (3C69) RUN	Sleep Boost Hold Time	<div style="display: flex; gap: 5px;"> <span>V/f</span> <span>OLV/PM</span> <span>EZOLV</span> </div> Sets the length of time that the drive will keep the boosted pressure before it goes to sleep.	5.0 s (0.5 - 160.0 s)

### ■ Y2-07: Sleep Boost Max Time

No. (Hex.)	Name	Description	Default (Range)
Y2-07 (3C6A) RUN	Sleep Boost Max Time	<b>V/f</b> <b>OLV/PM</b> <b>EZOLV</b> Sets the length of time that the system (feedback) has to reach the boosted setpoint. The system must reach the boosted setpoint in the time set in this parameter, or it will go to sleep.	20.0 s (1.0 - 160.0 s)

### ■ Y2-08: Delta Feedback Drop Level

No. (Hex.)	Name	Description	Default (Range)
Y2-08 (3C6B) RUN	Delta Feedback Drop Level	<b>V/f</b> <b>OLV/PM</b> <b>EZOLV</b> Sets the level of the PID Error (set-point minus feedback) to deactivate the Sleep Mode operation.	0.00 (0.00 - 600.00)

When the drive enters Sleep Mode, the software monitors the feedback to detect a flow-no flow condition. The drive will deactivate the Sleep Mode operation and will go back to its normal operation when:

- The PID Error is more than this level in the time set in Y2-09 [*Feedback Drop Detection Time*]
- The output frequency is more than the level set in Y1-06 [*Minimum Speed*]

**Note:**

- Parameters b5-46 [*PID Unit Display Selection*], b5-38 [*PID User Unit Display Scaling*], and b5-39 [*PID User Unit Display Digits*] set the unit, scaling, and resolution.
- Set this parameter to 0.00 to disable the function.

### ■ Y2-09: Feedback Drop Detection Time

No. (Hex.)	Name	Description	Default (Range)
Y2-09 (3C6C) RUN	Feedback Drop Detection Time	<b>V/f</b> <b>OLV/PM</b> <b>EZOLV</b> Sets the time during which the software monitors the feedback to detect a flow/no-flow condition. Refer to Y2-08 [ <i>Delta Feedback Drop Level</i> ] for more information.	10.0 s (0.0 - 3600.0 s)

### ■ Y2-23: Anti-No-Flow Bandwidth

No. (Hex.)	Name	Description	Default (Range)
Y2-23 (3C7A) RUN	Anti-No-Flow Bandwidth	<b>V/f</b> <b>OLV/PM</b> <b>EZOLV</b> Sets the quantity of PI error bandwidth that the drive uses to detect an Anti- No-Flow condition.	0.00% (0.00 - 2.00%)

**Note:**

Do not set this parameter value too high, because operation can become unstable.

### ■ Y2-24: Anti-No-Flow Detection Time

No. (Hex.)	Name	Description	Default (Range)
Y2-24 (3C7B) RUN	Anti-No-Flow Detection Time	<b>V/f</b> <b>OLV/PM</b> <b>EZOLV</b> Sets the time delay before the drive starts the increased deceleration rate after it detects Anti-No-Flow.	10.0 s (1.0 - 60.0 s)

### ■ Y2-25: Anti-No-Flow Release Level

No. (Hex.)	Name	Description	Default (Range)
Y2-25 (3C7C) RUN	Anti-No-Flow Release Level	<b>V/f</b> <b>OLV/PM</b> <b>EZOLV</b> Sets the amount below the setpoint which the feedback must decrease before the drive will disengage Anti-No-Flow and return to normal PI operation.	0.30% (0.00 - 10.00%)

**Note:**

Parameters *b5-46 [PID Unit Display Selection]*, *b5-38 [PID User Unit Display Scaling]*, and *b5-39 [PID User Unit Display Digits]* set the unit, scaling, and resolution.

◆ **Y4: Application Advanced**

■ **Y4-01: Pre-Charge Level**

No. (Hex.)	Name	Description	Default (Range)
Y4-01 (3CFA) RUN	Pre-Charge Level	<input type="checkbox"/> V/f <input type="checkbox"/> OLVP/M <input type="checkbox"/> EZOLV Sets the level at which the drive will activate the pre-charge function when the drive is running at the frequency set in <i>Y4-02 [Pre-Charge Frequency]</i> .	0.00 (0.00 - 600.00)

**Note:**

- The drive will stop when one of these conditions is true:
  - The feedback level increases to more than *Y4-01*
  - The pre-charge time set in *Y4-03 [Pre-Charge Time]* expires
- Parameters *b5-46 [PID Unit Display Selection]*, *b5-38 [PID User Unit Display Scaling]*, and *b5-39 [PID User Unit Display Digits]* set the unit, scaling, and resolution.

■ **Y4-02: Pre-Charge Frequency**

No. (Hex.)	Name	Description	Default (Range)
Y4-02 (3CFB) RUN	Pre-Charge Frequency	<input type="checkbox"/> V/f <input type="checkbox"/> OLVP/M <input type="checkbox"/> EZOLV Sets the frequency at which the pre-charge function will operate.	0.0 Hz (0.0 - E1-04 Hz)

**Note:**

- When *A1-02 = 8 [Control Method Selection = EZOLV]*, the upper limit is the Hz equivalent of *E9-02 [Maximum Speed]*.
- When *H1-xx = 16 [MFDI Function Selection = Motor 2 Selection]* for Motor 2, the upper limit is the larger value between *E1-04 [Maximum Output Frequency]* and *E3-04 [Motor 2 Maximum Output Frequency]*.

■ **Y4-03: Pre-Charge Time**

No. (Hex.)	Name	Description	Default (Range)
Y4-03 (3CFC) RUN	Pre-Charge Time	<input type="checkbox"/> V/f <input type="checkbox"/> OLVP/M <input type="checkbox"/> EZOLV Sets the length of time that the Pre-Charge function will run.	0.0 min (0.0 - 3600.0 min)

**Note:**

- Set this parameter to 0.0 to disable the function.
- When *Y1-01 = 3 [Multiplex Mode = Memobus Network]*, the function is active only on the first drive to run in the network.

■ **Y4-05: Pre-Charge Loss of Prime Level**

No. (Hex.)	Name	Description	Default (Range)
Y4-05 (3CFE) RUN	Pre-Charge Loss of Prime Level	<input type="checkbox"/> V/f <input type="checkbox"/> OLVP/M <input type="checkbox"/> EZOLV Sets the level at which the drive will detect loss of prime in the pump.	0.0 (0.0 - 1000.0)

**Note:**

Parameter *Y1-18 [Prime Loss Detection Method]* sets units.

■ **Y4-11: Thrust Acceleration Time**

No. (Hex.)	Name	Description	Default (Range)
Y4-11 (3D04) RUN	Thrust Acceleration Time	<input type="checkbox"/> V/f <input type="checkbox"/> OLVP/M <input type="checkbox"/> EZOLV Sets the time at which the drive output frequency will ramp up to the reference frequency set in <i>Y4-12 [Thrust Frequency]</i> .	1.0 s (0.0 - 600.0 s)

When  $Y4-11 = 0$ , the drive will use the standard acceleration rate.

## ■ Y4-12: Thrust Frequency

No. (Hex.)	Name	Description	Default (Range)
Y4-12 (3D05) RUN	Thrust Frequency	<b>V/f</b> <b>OLV/PM</b> <b>EZOLV</b> Sets the Thrust Frequency that the drive will use to know which acceleration and deceleration time to use. The drive will accelerate to this frequency in the $Y4-11$ [Thrust Acceleration Time] time and decelerate from this frequency in the $Y4-13$ [Thrust Deceleration Time] time.	0.0 Hz (0.0 - E1-04 Hz)

**WARNING!** Sudden Movement Hazard. When you set Thrust Frequency, do not re-energize the drive while you enter the Run command. If you de-energized the drive while it is running, the drive can automatically start when you energize it and it can cause serious injury or death.

### Note:

- When  $A1-02 = 8$  [Control Method Selection = EZOLV], the upper limit is the Hz equivalent of  $E9-02$  [Maximum Speed].
- When  $H1-xx = 16$  [MFDI Function Selection = Motor 2 Selection] for Motor 2, the upper limit is the larger value between  $E1-04$  [Maximum Output Frequency] and  $E3-04$  [Motor 2 Maximum Output Frequency].

At start, the drive will use the  $Y4-11$  [Thrust Acceleration Time] time until the output frequency increases to  $Y4-12$ . During the  $Y4-11$  time, the terminal set for  $H2-xx = AB$  [MFDO Function Selection = Thrust Mode] will be active. When the output frequency is at or more than  $Y4-12$ , the drive will use the active acceleration and deceleration times set in  $C1-01$  [Acceleration Time 1] to  $C1-04$  [Deceleration Time 2]. At stop, when the output frequency decreases to  $Y4-12$ , the drive will use  $Y4-13$  [Thrust Deceleration Time] for the remaining deceleration time.

Figure 12.120 shows an example of drive operation during Thrust mode when  $b1-03 = 0$  [Stopping Method Selection = Ramp to Stop].

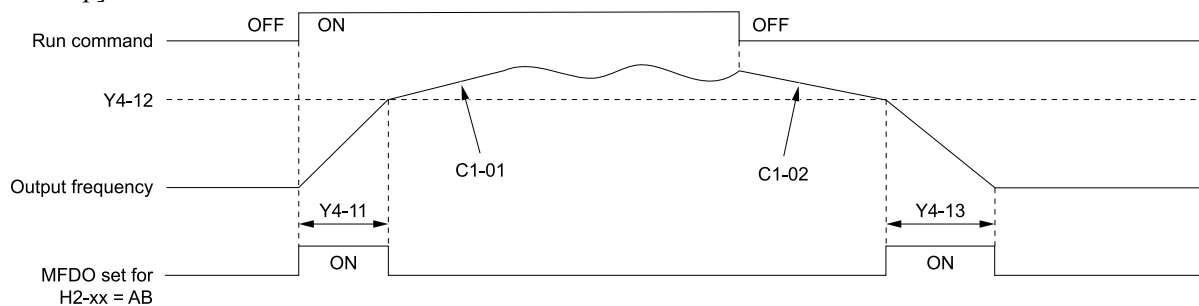

**C1-01: Acceleration Time 1**  
**C1-02: Deceleration Time 1**  
**H2-xx = AB: Thrust Mode**

**Y4-11: Thrust Acceleration Time**  
**Y4-12: Thrust Frequency**  
**Y4-13: Thrust Deceleration Time**

Figure 12.120 Thrust Frequency

## ■ Y4-13: Thrust Deceleration Time

No. (Hex.)	Name	Description	Default (Range)
Y4-13 (3D06) RUN	Thrust Deceleration Time	<b>V/f</b> <b>OLV/PM</b> <b>EZOLV</b> Sets the length of time necessary for the drive to go from the Thrust Frequency in $Y4-12$ [Thrust Frequency] to stop when Thrust Mode is active.	5.0 s (0.0 - 600.0 s)

When  $Y4-13 > 0.0$ , the drive will decelerate from the  $Y4-12$  value to zero in exactly the  $Y4-13$  time.

When  $Y4-13 = 0$ , the drive will use the standard deceleration rate.

## ■ Y4-17: Utility Start Delay

No. (Hex.)	Name	Description	Default (Range)
Y4-17 (3D0A) RUN	Utility Start Delay	<b>V/f</b> <b>OLV/PM</b> <b>EZOLV</b> Sets the length of time that the drive will delay starting at power-up.	0.0 min (0.0 - 1000.0 min)

The Utility Start Delay function will help to prevent a peak power surge when more than one drive powers-up and start to accelerate at the same time. This function will work when the drives all have different *Y4-17* settings, to apply the power draw equally during acceleration.

The drive enables the Utility Start Delay function when *Y4-17* > 0.0. When the drive receives a Run command or when the drive is in AUTO Mode in less than 1 s after power-up, the drive will delay the operation for the time set in *Y4-17*.

### ■ Y4-18: Differential Level

No. (Hex.)	Name	Description	Default (Range)
Y4-18 (3D0B) RUN	Differential Level	<input type="checkbox"/> V/f <input type="checkbox"/> OLV/IPM <input type="checkbox"/> EZOLV Sets the maximum difference that the drive will allow when it subtracts the Differential Feedback from the Primary PID Feedback.	0.00% (-99.99 - +99.99%)

#### Note:

- The drive will respond based on the setting in *Y4-20* [*Differential Level Detection Selection*] when the difference increases to more than the value set in this parameter for the time set in *Y4-19* [*Differential Level Detection Time*].
- Parameters *b5-46* [*PID Unit Display Selection*], *b5-38* [*PID User Unit Display Scaling*], and *b5-39* [*PID User Unit Display Digits*] set the unit, scaling, and resolution.
- Set this parameter to 0.00 to disable Differential Feedback Detection.

### ■ Y4-19: Differential Lvl Detection Time

No. (Hex.)	Name	Description	Default (Range)
Y4-19 (3D0C) RUN	Differential Lvl Detection Time	<input type="checkbox"/> V/f <input type="checkbox"/> OLV/IPM <input type="checkbox"/> EZOLV Sets the length of time that the difference between PID Feedback and the Differential Feedback must be more than <i>Y4-18</i> [ <i>Differential Level</i> ] before the drive will respond as specified by <i>Y4-20</i> [ <i>Differential Level Detection Selection</i> ].	10 s (0 - 3600 s)

### ■ Y4-20: Differential Level Detection Sel

No. (Hex.)	Name	Description	Default (Range)
Y4-20 (3D0D) RUN	Differential Level Detection Sel	<input type="checkbox"/> V/f <input type="checkbox"/> OLV/IPM <input type="checkbox"/> EZOLV Sets the drive response during a Differential Level Detected condition.	0 (0 - 2)

0 : Fault (and Digital Out)

1 : Alarm (and Digital Out)

2 : Digital Out Only

### ■ Y4-22: Low City On-Delay Time

No. (Hex.)	Name	Description	Default (Range)
Y4-22 (3D0F) RUN	Low City On-Delay Time	<input type="checkbox"/> V/f <input type="checkbox"/> OLV/IPM <input type="checkbox"/> EZOLV Sets the length of time that the drive will wait to stop when the drive detects a Low City Pressure condition.	10 s (1 - 1000 s)

### ■ Y4-23: Low City Off-Delay Time

No. (Hex.)	Name	Description	Default (Range)
Y4-23 (3D10) RUN	Low City Off-Delay Time	<input type="checkbox"/> V/f <input type="checkbox"/> OLV/IPM <input type="checkbox"/> EZOLV Sets the length of time that the drive will wait to start again after you clear a Low City Pressure condition.	5 s (0 - 1000 s)

### ■ Y4-24: Low City Alarm Text

No. (Hex.)	Name	Description	Default (Range)
Y4-24 (3D11) RUN	Low City Alarm Text	<b>V/f</b> <b>OLV/PM</b> <b>EZOLV</b> Sets the alarm message to show on the keypad when the drive detects a Low City Pressure condition.	0 (0 - 2)

**0 : Low City Pressure**

**1 : Low Suction Pressure**

**2 : Low Water in Tank**

### ■ Y4-36: Pressure Reached Exit Conditions

No. (Hex.)	Name	Description	Default (Range)
Y4-36 (3D1D) RUN	Pressure Reached Exit Conditions	<b>V/f</b> <b>OLV/PM</b> <b>EZOLV</b> Sets how the digital output responds to Feedback changes after it activates.	1 (0, 1)

**0 : Hysteresis Above & Below**

The terminal set for  $H2-xx = 42$  [MFDO Function Selection = Pressure Reached] will deactivate when the Feedback is less than the “Setpoint - Hysteresis” or more than the “Setpoint + Hysteresis” for the time set in Y4-39 [Pressure Reached Off Delay Time].

**1 : Hysteresis 1-Way**

- When  $b5-09 = 0$  [Normal Output (Direct Acting)]:

The terminal set for  $H2-xx = 42$  will deactivate only when the Feedback is less than the “Setpoint - Hysteresis” for the time set in Y4-39. When the Feedback is more than the Setpoint, the terminal will stay active.

- When  $b5-09 = 1$  [Reverse Output (Reverse Acting)]:

The terminal set for  $H2-xx = 42$  will deactivate only when the Feedback is more than the “Setpoint + Hysteresis” for the time set in Y4-39. When the Feedback is less than the Setpoint, the terminal will stay active.

### ■ Y4-37: Pressure Reached Hysteresis Lvl

No. (Hex.)	Name	Description	Default (Range)
Y4-37 (3D1E) RUN	Pressure Reached Hysteresis Lvl	<b>V/f</b> <b>OLV/PM</b> <b>EZOLV</b> Sets the hysteresis level that will cause the drive to exit the Pressure Reached condition.	0.30 (0.01 - 10.00)

**Note:**

Parameters  $b5-46$  [PID Unit Display Selection],  $b5-38$  [PID User Unit Display Scaling], and  $b5-39$  [PID User Unit Display Digits] set the unit, scaling, and resolution.

### ■ Y4-38: Pressure Reached On Delay Time

No. (Hex.)	Name	Description	Default (Range)
Y4-38 (3D1F) RUN	Pressure Reached On Delay Time	<b>V/f</b> <b>OLV/PM</b> <b>EZOLV</b> Sets the length of time that the drive will wait before it activates the Pressure Reached condition.	1.0 s (0.1 - 60.0 s)

### ■ Y4-39: Pressure Reached Off Delay Time

No. (Hex.)	Name	Description	Default (Range)
Y4-39 (3D20) RUN	Pressure Reached Off Delay Time	<b>V/f</b> <b>OLV/PM</b> <b>EZOLV</b> Sets the length of time that the drive will wait before it deactivates the Pressure Reached condition.	1.0 s (0.1 - 60.0 s)

### ■ Y4-40: Pressure Reached Detection Sel

No. (Hex.)	Name	Description	Default (Range)
Y4-40 (3D21) RUN	Pressure Reached Detection Sel	<b>V/f</b> <b>OLV/PM</b> <b>EZOLV</b> Sets the drive status that triggers the Pressure Reached Detection digital output.	0 (0 - 2)

#### 0 : Always

The digital output set for  $H2-xx = 42$  [MFDO Function Selection = Pressure Reached] will activate in all drive statuses. The digital output will engage when the drive is stopped or sleeping.

#### 1 : Drive Running

The digital output set for  $H2-xx = 42$  will activate only when the drive supplies the output voltage to the motor. The digital output will not engage when the drive is sleeping.

#### 2 : Run Command

The digital output set for  $H2-xx = 42$  will activate only when there is an active Run command, for example, AUTO or HAND.

### ■ Y4-41: Diff Lvl Src Fdbk Backup Select

No. (Hex.)	Name	Description	Default (Range)
Y4-41 (3D22) RUN	Diff Lvl Src Fdbk Backup Select	<b>V/f</b> <b>OLV/PM</b> <b>EZOLV</b> Sets the function to enable or disable <i>Differential Level Source</i> [ $H3-xx = 2D$ ] as the backup transducer if there is a failure with the primary PID Feedback transducer [ $H3-xx = B$ ] and the PID Feedback Backup transducer [ $H3-xx = 24$ ] is not available.	0 (0, 1)

#### 0 : Disabled

#### 1 : Enabled

### ■ Y4-42: Output Disconnect Detection Sel

No. (Hex.)	Name	Description	Default (Range)
Y4-42 (3D23)	Output Disconnect Detection Sel	<b>V/f</b> <b>OLV/PM</b> <b>EZOLV</b> Sets the drive response when you open the output disconnect then connect it again.	0 (0 - 3)

#### Note:

When the Output Disconnect is active, the drive internally disables Output Phase Loss Detection of more than one phase.

#### 0 : Disabled

#### 1 : Alarm - Speed Search

The drive will show an *OD* [Output Disconnect] alarm. When the output is re-closed, the drive will do a baseblock and a Speed Search for the correct recovery.

#### Note:

If at any time the customer Run command is removed, the drive will clear the *OD* alarm and enter a normal stopped state.

#### 2 : Alarm - Start at Zero

The drive will show an *OD* alarm. When the output is re-closed, the drive will do a baseblock and let the soft-starter to ramp up from zero for the correct recovery.

#### Note:

If at any time the customer Run command is removed, the drive will clear the *OD* alarm and enter a normal stopped state.

#### 3 : Fault

The drive will coast to stop and show an *OD* [Output Disconnect] fault.

#### Note:

You cannot Auto-Restart the drive after an *OD* fault.



## ■ Y4-43: Output Disconnect Inject Current

No. (Hex.)	Name	Description	Default (Range)
Y4-43 (3D24)	Output Disconnect Inject Current	<b>V/f</b> <b>OLV/PM</b> <b>EZOLV</b> Sets the level of DC injection current during output disconnect as a percentage of the drive rated current.	30% (5 - 50%)

## ◆ Y9: Network Multiplex Options

*Y9 parameters* set MEMOBUS Multiplex functions.

### ■ MEMOBUS Multiplexing Setup

1. Wire terminals D+ between each individual drive.

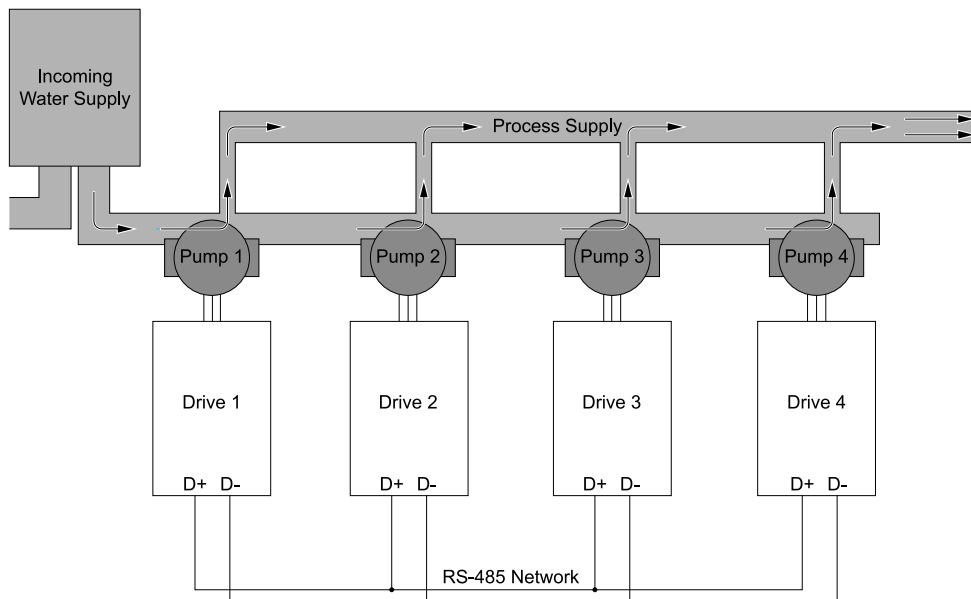

**Figure 12.121 Wiring the Drive RS-485 Network Connections**

2. Wire terminals D- between each individual drive.
3. Set *H5-01* [Serial Node Address] on each drive.

**Note:**

Set *H5-01* to consecutive numbers starting from 1. The setting values for *H5-01* must be unique for each drive.

4. Set *Y9-25* [Highest Node Address] on each drive.

**Note:**

Set the highest value of *H5-01*. This setting must be the same for all the drives on the network.

5. Set *Y1-01* = 3 [MEMOBUS/Modbus Network] on all drives.
6. Cycle power on all of the networked drives or set *H5-20* = 1 [Communication Parameters Reload = Reload Now].

**Note:**

You must cycle power on the drive or set *H5-20* = 1 to activate the *H5-01* setting. If you do not cycle power or set *H5-20*, it can cause communication errors and incorrect performance.

### ■ Verifying the Drive Network Communications

To show the network traffic, view *UA-02* [Network Activity].

Network Activity Monitor UA-02	Network State																				
<table border="1"> <tr> <td>10:00 am</td> <td>FWD</td> <td>Rdy</td> <td>Monitor</td> </tr> <tr> <td>Network Activity</td> <td>UA-02</td> <td>% &lt;M&gt;</td> <td style="text-align: right;">99.5</td> </tr> <tr> <td>Time to Alternation</td> <td>UA-03</td> <td>min</td> <td style="text-align: right;">1439</td> </tr> <tr> <td>Running Queue No</td> <td>UA-04</td> <td></td> <td style="text-align: right;">0</td> </tr> <tr> <td colspan="4" style="text-align: center;">Home</td> </tr> </table>	10:00 am	FWD	Rdy	Monitor	Network Activity	UA-02	% <M>	99.5	Time to Alternation	UA-03	min	1439	Running Queue No	UA-04		0	Home				The drive is the master of the network and is communicating with other drives. <M> identifies that the drive is the master.
10:00 am	FWD	Rdy	Monitor																		
Network Activity	UA-02	% <M>	99.5																		
Time to Alternation	UA-03	min	1439																		
Running Queue No	UA-04		0																		
Home																					
<table border="1"> <tr> <td>10:00 am</td> <td>FWD</td> <td>Rdy</td> <td>Monitor</td> </tr> <tr> <td>Network Activity</td> <td>UA-02</td> <td>% &lt;+&gt;</td> <td style="text-align: right;">98.1</td> </tr> <tr> <td>Time to Alternation</td> <td>UA-03</td> <td>min</td> <td style="text-align: right;">1439</td> </tr> <tr> <td>Running Queue No</td> <td>UA-04</td> <td></td> <td style="text-align: right;">0</td> </tr> <tr> <td colspan="4" style="text-align: center;">Home</td> </tr> </table>	10:00 am	FWD	Rdy	Monitor	Network Activity	UA-02	% <+>	98.1	Time to Alternation	UA-03	min	1439	Running Queue No	UA-04		0	Home				The drive is a node on the network and is communicating with the master. <+> identifies that the drive is a node.
10:00 am	FWD	Rdy	Monitor																		
Network Activity	UA-02	% <+>	98.1																		
Time to Alternation	UA-03	min	1439																		
Running Queue No	UA-04		0																		
Home																					
<table border="1"> <tr> <td>10:00 am</td> <td>FWD</td> <td>Rdy</td> <td>Monitor</td> </tr> <tr> <td>Network Activity</td> <td>UA-02</td> <td>% &lt;-&gt;</td> <td style="text-align: right;">0.0</td> </tr> <tr> <td>Time to Alternation</td> <td>UA-03</td> <td>min</td> <td style="text-align: right;">1439</td> </tr> <tr> <td>Running Queue No</td> <td>UA-04</td> <td></td> <td style="text-align: right;">0</td> </tr> <tr> <td colspan="4" style="text-align: center;">Home</td> </tr> </table>	10:00 am	FWD	Rdy	Monitor	Network Activity	UA-02	% <->	0.0	Time to Alternation	UA-03	min	1439	Running Queue No	UA-04		0	Home				The drive cannot communicate with other drives. <-> identifies that the drive is offline.
10:00 am	FWD	Rdy	Monitor																		
Network Activity	UA-02	% <->	0.0																		
Time to Alternation	UA-03	min	1439																		
Running Queue No	UA-04		0																		
Home																					

Make sure of these points:

- No drives show [<->]
- All drives are receiving valid data identified by a regular change in the monitor value.
- A minimum of one drive shows [<M>] and the others show [<+>].

If a drive shows [<->]:

- Make sure that the physical connections are correct.
- Confirm the setting of *H5-xx [Modbus Communication]*.
- Confirm the values set in *Y9-25* and *Y9-27* on all drives.
  - Set *Y9-25* to the highest *H5-01* value.
  - Set *Y9-27* = 0 on one of the drives.
- Cycle power to the drive.

### ■ Multiplexing

The Lead Drive uses *Y9-08 [Staging Mode]* to *Y9-11 [Staging Delay Time]* to determine if it is necessary to stage, and *Y9-12 [De-staging Mode]* to *Y9-15 [De-staging Delay Time]* to determine if it is necessary to de-stage.

Staging will request a new Lead Drive and make the current drive a Lag Drive. MEMOBUS Multiplex will request a stage only when there are drives available to run and the number of drives running is fewer than *Y9-23 [Max Drives Allowed to Run]*.

De-staging will make the previous Lead Drive (now a Lag Drive) a Lead Drive again, and stop the current Lead Drive. MEMOBUS Multiplex will request a de-stage only when there are two or more drives running. With this setup, there can only be one Lead Drive on the network at any time. The drive does the quick de-stage function when the drive detects:

- High feedback (based on *Y1-09 [Low Feedback Lvl Fault Dly Time]* and *Y9-18 [High Feedback De-stage Level]*) for 2 s for Direct-Acting PI operation.
- Low feedback (based on *Y9-34 [Low Feedback De-stage]*) for 2 s for Reverse-Acting PI operation.

**Note:**

The drive starts to detect staging and de-staging when the Lead Drive is equal to or more than the minimum speed. The minimum speed is the largest value from *d2-02 [Frequency Reference Lower Limit]*, *Y1-06 [Minimum Speed]*, and *Y4-12 [Thrust Frequency]*.

## ■ Home Screen Text

When  $Y1-01 = 3$  [Multiplex Mode = Memobus Network] and  $o1-40 = 0$  [Home Screen Display Selection = Custom Monitor], the top line text of the HOME Screen Status Display is different as specified by the AUTO Mode Run command or the Network Run command.

Keypad Display	Network State
<pre> 10:00 am FWD Rdy Home <b>OFF</b> Idle: No AUTO Cmd ----- Setpoint U5-99 % 80.00 Output Frequency U1-02 Hz 0.00 Menu </pre>	<ul style="list-style-type: none"> <li>The drive is not operating in Auto Mode.</li> <li>Drive cannot accept commands from the HV600 MEMOBUS network.</li> </ul>
<pre> 10:00 am FWD Rdy Home <b>AUTO</b> Idle: wait for Net Cmd ----- Setpoint U5-99 % 80.00 Output Frequency U1-02 Hz 0.00 Menu </pre>	<ul style="list-style-type: none"> <li>The drive is in Auto Mode.</li> <li>The drive is waiting for a Run command from the HV600 MEMOBUS network.</li> </ul>
<pre> 10:00 am FWD Rdy Home <b>AUTO</b> Lead Drive ----- Setpoint U5-99 % 80.00 Output Frequency U1-02 Hz 46.65 Menu </pre>	<ul style="list-style-type: none"> <li>The drive is in Auto Mode.</li> <li>The drive is in Lead operation and is regulating the system.</li> <li>This drive sets staging and de-staging conditions.</li> </ul>
<pre> 10:00 am FWD Rdy Home <b>AUTO</b> Lag Drive: Holding Speed ----- Freq Reference (KPD) U1-01 Hz 57.12 Output Frequency U1-02 Hz 57.11 Menu </pre>	<ul style="list-style-type: none"> <li>The drive is in Auto Mode.</li> <li>The drive is in Lag operation and is holding the speed at the time it made the switch from a Lead Drive to a Lag.</li> <li>The drive will hold the speed until the <math>Y9-07</math> [Lag Fixed Speed Delay] time is expired.</li> </ul>
<pre> 10:00 am FWD Rdy Home <b>AUTO</b> Lag Drive: Fixed Y9-06 ----- Freq Reference (KPD) U1-01 Hz 55.00 Output Frequency U1-02 Hz 55.00 Menu </pre>	<ul style="list-style-type: none"> <li>The drive is in Auto Mode.</li> <li>The drive is in Lag operation and is operating at the speed set in <math>Y9-06</math> [Lag Fixed Speed].</li> </ul>
<pre> 10:00 am FWD Rdy Home <b>AUTO</b> Lag Drive: Follow Lead ----- Freq Reference (KPD) U1-01 Hz 45.86 Output Frequency U1-02 Hz 45.87 Menu </pre>	<ul style="list-style-type: none"> <li>The drive is in Auto Mode.</li> <li>The drive is in Lag operation and is following the speed of the current Lead Drive.</li> </ul>
<pre> 10:00 am FWD Rdy Home <b>AUTO</b> Alternation in Progress ----- Setpoint U5-99 % 80.00 Output Frequency U1-02 Hz 54.33 Menu </pre>	<p>The drive is in Alternation Stabilization Mode.</p>

Keypad Display	Network State
	<ul style="list-style-type: none"> <li>The drive is in HAND Mode</li> <li>The drive is ignoring HV600 MEMOBUS commands.</li> </ul>
	<p>There is an AUTO command, but PI Aux Control or Low City Pressure will not let the drive operate.</p>

**Note:**

Parameter o1-82 [Message Screen Display] sets how the drive will show the messages on the keypad. Refer to [Full Screen Information Display on page 854](#) for more information.

**MEMOBUS Multiplexing System-wide Parameter Entry**

This function lets you send parameter changes through the MEMOBUS Multiplex network.

You cannot send the parameters in [Table 12.81](#) to other drives on the MEMOBUS Multiplex network.

**Table 12.81 Non-System-Wide Parameters**

No.	Name	No.	Name
A1-03	Initialize Parameters	o4-09	IGBT Maintenance Setting
H5-01	Drive Node Address	o4-11	Fault Trace/History Init (U2/U3)
o2-04	Drive Model (KVA) Selection	o4-12	kWh Monitor Initialization
o2-09	Region Code	o4-13	RUN Command Counter @ Initialize
o3-01	Copy Keypad Function Selection	q1-xx - q8-xx	DriveWorksEZ Parameters
o4-01	Elapsed Operating Time Setting	Y1-01	Multiplex Mode
o4-03	Fan Operation Time Setting	Y9-20	Allow Network Run
o4-05	Capacitor Maintenance Setting	Y9-21	Run Priority
o4-07	Softcharge Relay Maintenance Set	Y9-27	Network Recovery

Parameter Y9-98 [Network Parameter Push] enables and disables the network parameter push function.

- When Y9-98 = 0 [Disabled], you can only write changes to the drive on which you changed the parameter.
- When Y9-98 = 1 [Enabled/Prompt], changes to system-wide parameters show the prompt shown in [Table 12.82](#) that asks to write the change to the selected drive or to all the drives on the network.

The system will only write changes to non-system-wide parameters to the drive on which you changed the parameter. Refer to [Table 12.81](#) for a list of non-system-wide parameters that you cannot send to other drives on the MEMOBUS Multiplex network.

Table 12.82 Apply Parameter Changes to Prompt when Y9-98 = 1

Status	Keypad Display	Description
A System-Wide Parameter Is Changed	<pre> 10:00 am FWD Parameters ----- Apply Changes to All Drives on Memobus Network <b>This Drive Only</b> Cancel Back </pre>	<p>When you change System-wide parameter, the keypad will show <i>[Apply Changes to]</i> message and you can set one of these selections:</p> <ul style="list-style-type: none"> <li><i>[All Devices on Memobus Network]</i>: Writes the changes to the drive on which you changed the parameter and all other online drives.</li> <li><i>[This Device Only]</i>: Writes the changes only to the drive on which you changed the parameter.</li> <li><i>[Cancel]</i>: Cancels the change.</li> </ul>
Writing to Nodes Is in Progress	<pre> 10:00 am FWD Parameters ----- WAIT Network Write in Progress Back </pre>	<p>When you set <i>[All Devices on Memobus Network]</i>, the MEMOBUS Multiplex network will start to write each node. The keypad shows the <i>[WAIT Network Write in Progress]</i> message for 5 seconds while the MEMOBUS Multiplex network writes to each node.</p>
All Drives Have Been Accessed to Update the Nodes	<pre> 10:00 am FWD Parameters ----- Node Addresses Updated: o o X o 1 2 3 4 X: Fail o: Okay Back </pre>	<p>After all drives have been accessed, the keypad will show <i>[Node Addresses Updated]</i> message. The number of nodes as specified by Y9-25 <i>[Highest Node Address]</i>.</p> <p>On the keypad:</p> <ul style="list-style-type: none"> <li><i>[x]</i> shows nodes that did not update</li> <li><i>[o]</i> shows nodes that completed successfully</li> </ul> <p>When all nodes are updated successfully, the keypad will show the <i>[Node Addresses Updated]</i> message for 1.5 seconds or until you push a key.</p> <p>If there are nodes that did not update, the keypad will show the message for 15 seconds or until you push a key. The keypad then goes back to the parameter selection screen.</p>
Taking Longer Than 5 Seconds to Confirm the Parameter Change	<pre> 10:00 am FWD Parameters ----- waiting on confirmation from networked drives. Verify parameters were written successfully on each drive. Back </pre>	<p>If the drive on the network does not receive confirmations from all nodes for longer than 5 seconds, the keypad will show a Waiting on Confirmation message.</p> <p>The Waiting on Confirmation message will go away after 15 seconds or when you push a key. The display then goes back to the parameter selection screen.</p> <p>When the drive receives confirmation before 15-second timer is expired, the keypad will show the <i>[Node Addresses Updated]</i> message.</p>

## ■ Y9-01: Lead Drive Selection

No. (Hex.)	Name	Description	Default (Range)
Y9-01 (3DF4)	Lead Drive Selection	<div style="display: flex; gap: 5px;"> <span style="border: 1px solid black; padding: 2px;">V/f</span> <span style="border: 1px solid black; padding: 2px;">OLV/PM</span> <span style="border: 1px solid black; padding: 2px;">EZOLV</span> </div> Sets how to select the new Lead Drive.	1 (0 - 2)

### Note:

- When Y9-01 = 1, MEMOBUS network uses monitor U4-01 *[Cumulative Ope Time]*. The settings of o4-01 *[Elapsed Operating Time Setting]* and o4-02 *[Elapsed Operating Time Selection]* will have a direct effect on this parameter. Yaskawa recommends to keep o4-02 = 1 *[U4-01 Shows Total RUN Time]*.
- When U4-01 > 65535 hours, alternation timer has reached its maximum value. Yaskawa recommends to reset the runtime hours (o4-01) on all the drives to keep the function working correctly.

**0 : Next Available**

**1 : Lowest Runtime**

**2 : Stop History**

## ■ Y9-02: System Feedback Source

No. (Hex.)	Name	Description	Default (Range)
Y9-02 (3DF5)	System Feedback Source	<div style="display: flex; gap: 5px;"> <span style="border: 1px solid black; padding: 2px;">V/f</span> <span style="border: 1px solid black; padding: 2px;">OLV/PM</span> <span style="border: 1px solid black; padding: 2px;">EZOLV</span> </div> Sets the signal to use for PID Feedback when Y1-01 = 3 <i>[Multiplex Mode = Memobus Network]</i> .	0 (0 - 3)

**0 : Analog Only**

The drive will not read the Network PID Feedback register as the feedback source, although the drive will continue to transmit its own PID Feedback signal to the network.

The feedback detection will operate as specified by *b5-82 [Feedback Loss 4 ~ 20mA Detect Sel]*.

**Note:**

If the Multiplex drive is operating as a Lag drive, parameter *Y9-06 [Lag Fixed Speed]* has priority over *b5-83 [Feedback Loss GoTo Frequency]*.

**1 : Ana->Net, No Alarm**

The drive will read the Network PID Feedback register if the analog feedback signal is lost.

If the network Feedback signal is also not valid, the drive will operate as specified by *b5-82*.

**Note:**

If you set *b5-82 = 0 [Disabled]* or you do not use a 4 to 20 mA PID Feedback signal, it will disable analog feedback detection and will not let the drive switch to the Network PID Feedback.

**2 : Ana->Net, Alarm**

The drive will read the Network PID Feedback register if the analog feedback signal is lost. The keypad will show an *AFBL [Analog Fbk Lost, Switched to Net]* alarm.

If the network Feedback signal is also not valid, the drive will operate as specified by *b5-82*.

**Note:**

If you set *b5-82 = 0* or you do not use a 4 to 20 mA PID Feedback signal, it will disable analog feedback detection and will not let the drive switch to the Network PID Feedback.



**3 : Network Only**

The drive always read the Network PID Feedback register.

If the network feedback signal is not valid, the drive will operate as specified by *b5-82*, with these differences:

- *b5-82 = 1*: The drive will not detect an alarm. It will show a *[Network Feedback Lost]* message.
- *b5-82 = 2*: The drive will not detect a fault. It will show a *[Network Feedback Lost]* message, it will not accept network Run commands, and it will set the stopping method to coast-to-stop.



**■ Y9-03: Alternation Time**

No. (Hex.)	Name	Description	Default (Range)
Y9-03 (3DF6) RUN	Alternation Time	   Sets how much time a drive will request for the alternation, which is set in <i>Y9-04 [Alternation Mode]</i> .	24 H (0 - 1000 H)

**Note:**

- Parameter *Y9-19 [Alternation Time Unit]* sets the unit text.
- Set this parameter to 0 to disable the alternation function.

**■ Y9-04: Alternation Mode**

No. (Hex.)	Name	Description	Default (Range)
Y9-04 (3DF7)	Alternation Mode	   Sets how the drive does alternation.	0 (0 - 3)

**Note:**

You can use this parameter only when *Y1-03 = 3 [Multiplex Mode = Memobus Network]*.

**0 : FIFO Auto**

The drive will remove the First Drive in the operation queue and will use the MEMOBUS Multiplex function to start the Lead Drive automatically as necessary. If there is no Lead Drive, the MEMOBUS Multiplex function cannot operate. When there is only one drive running, the drive will force a new Lead Drive to run.

**1 : FIFO Forced**

The drive will remove the First Drive in the operation queue and will force a new Lead Drive to run.

**2 : LIFO**

The drive will remove the current Lead Drive and replace it with a new Lead Drive.

**3 : FIFO @Sleep**

The drive will remove the First Drive in the operation queue and will force a new Lead Drive to run only when the drive is in Sleep.

### ■ Y9-05: Lag Drive Mode

No. (Hex.)	Name	Description	Default (Range)
Y9-05 (3DF8)	Lag Drive Mode	<input type="checkbox"/> V/f <input type="checkbox"/> OLV/PM <input type="checkbox"/> EZOLV Sets the function of the Lag Drives.	0 (0 - 3)

#### 0 : Fixed Speed

After the Y9-07 [Lag Fixed Speed Delay] time is expired, the drive will operate at the Y9-06 [Lag Fixed Speed] setting.

#### 2 : Turn Off

After the Y9-07 time is expired, the drive will stop and become available for Network operation again.

#### 3 : Follow Lead Speed

After the Y9-07 time is expired, the drive will operate based on the speed of the current Lead Drive. The drive will apply the Y9-30 [Lag Speed Follower Gain] and Y9-31 [Lag Speed Follower Bias] settings.

### ■ Y9-06: Lag Fixed Speed

No. (Hex.)	Name	Description	Default (Range)
Y9-06 (3DF9) RUN	Lag Fixed Speed	<input type="checkbox"/> V/f <input type="checkbox"/> OLV/PM <input type="checkbox"/> EZOLV Sets the speed at which the drive will run when the drive set in Y9-05 = 0 [Lag Drive Mode = Fixed Speed] changes from a lead to a lag and the time set in Y9-07 [Lag Fixed Speed Delay] is expired.	55.0 Hz (0.0 - 400.0 Hz)

### ■ Y9-07: Lag Fixed Speed Delay

No. (Hex.)	Name	Description	Default (Range)
Y9-07 (3DFA) RUN	Lag Fixed Speed Delay	<input type="checkbox"/> V/f <input type="checkbox"/> OLV/PM <input type="checkbox"/> EZOLV Sets how long the drive holds its current speed before the drive operates as specified in Y9-05 [Lag Drive Mode] when the drive changes from a Lead to a Lag and Y9-05 ≠ 1 [Fixed Speed].	5 s (0 - 1000 s)

### ■ Y9-08: Staging Mode

No. (Hex.)	Name	Description	Default (Range)
Y9-08 (3DFB)	Staging Mode	<input type="checkbox"/> V/f <input type="checkbox"/> OLV/PM <input type="checkbox"/> EZOLV Sets the method to determine when it is necessary to stage a new drive to keep the setpoint.	0 (0 - 2)

#### 0 : Output Frequency

The drive monitors the output frequency of the Lead Drive.

When the output frequency > Y9-09 [Staging Frequency Level] for the time set in Y9-11 [Staging Delay Time] and when there is a drive available to run, the Lead Drive will send a network stage request.

#### 1 : Feedback

The drive monitors the feedback level of the Lead Drive.

When the difference between the setpoint and feedback is more than Y9-10 [Staging Delta Feedback Level] for the time set in Y9-11 and when there is a drive available to run, the Lead Drive will send a network stage request.

#### 2 : Feedback + Fout

The drive monitors the feedback level and output frequency of the Lead Drive.

When the output frequency > Y9-09 and the difference between the setpoint and feedback is more than Y9-10 for the time set in Y9-11, and when there is a drive available to run, the Lead Drive will send a network stage request.

## ■ Y9-09: Staging Frequency Level

No. (Hex.)	Name	Description	Default (Range)
Y9-09 (3DFC) RUN	Staging Frequency Level	<div style="display: flex; gap: 5px;"> <span style="background-color: black; color: white; padding: 2px;">V/f</span> <span style="background-color: black; color: white; padding: 2px;">OLV/PM</span> <span style="background-color: black; color: white; padding: 2px;">EZOLV</span> </div> Sets the level above which the output frequency must increase before the Lead Drive will send a request for a new Lead Drive through the MEMOBUS network.	59.5 Hz (0.0 - 400.0 Hz)

### Note:

- When  $A1-02 = 8$  [Control Method Selection = EZOLV], the range is 0.0 - 120.0 Hz.
- Parameter Y9-08 [Staging Mode] sets the condition to request for a new Lead Drive.
  - Y9-08 = 0 [Output Frequency]: The output frequency must increase to more than this level for the time set in Y9-11 [Staging Delay Time] to request for a new Lead Drive.
  - Y9-08 = 2 [Feedback + Fout]: The delta feedback (setpoint minus feedback) must be more than Y9-10 [Staging Delta Feedback Level] level for the time set in Y9-11 [Staging Delay Time] and the output frequency must increase to more than this level to request for a new Lead Drive.

## ■ Y9-10: Staging Delta Feedback Level

No. (Hex.)	Name	Description	Default (Range)
Y9-10 (3DFD) RUN	Staging Delta Feedback Level	<div style="display: flex; gap: 5px;"> <span style="background-color: black; color: white; padding: 2px;">V/f</span> <span style="background-color: black; color: white; padding: 2px;">OLV/PM</span> <span style="background-color: black; color: white; padding: 2px;">EZOLV</span> </div> Sets the level above which the difference between the setpoint and feedback must increase before the lead drive will send a request for a new Lead Drive through the MEMOBUS network.	0.40 (0.00 - 600.00)

### Note:

- When  $b5-09 = 0$  [PID Output Level Selection = Normal Output (Direct Acting)], the drive uses the setpoint minus the feedback to determine the delta feedback level.
- When  $b5-09 = 1$  [Reverse Output (Reverse Acting)], the drive uses the feedback minus the setpoint to determine the delta feedback level.
- Parameter Y9-08 [Staging Mode] sets the condition to request for a new Lead Drive:
  - Y9-08 = 1 [Feedback]: The difference between the setpoint and feedback must increase to more than this level for the time set in Y9-11 [Staging Delay Time] to request for a new Lead Drive.
  - Y9-08 = 2 [Feedback + Fout]: The difference between the setpoint and feedback must increase to more than this level and the output frequency must be more than Y9-09 [Staging Frequency Level] for the time set in Y9-11 [Staging Delay Time] to request for a new Lead Drive.

## ■ Y9-11: Staging Delay Time

No. (Hex.)	Name	Description	Default (Range)
Y9-11 (3DFE) RUN	Staging Delay Time	<div style="display: flex; gap: 5px;"> <span style="background-color: black; color: white; padding: 2px;">V/f</span> <span style="background-color: black; color: white; padding: 2px;">OLV/PM</span> <span style="background-color: black; color: white; padding: 2px;">EZOLV</span> </div> Sets the delay time before adding a new Lead Drive to the system.	10 s (0 - 3600 s)

## ■ Y9-12: De-staging Mode

No. (Hex.)	Name	Description	Default (Range)
Y9-12 (3DFF)	De-staging Mode	<div style="display: flex; gap: 5px;"> <span style="background-color: black; color: white; padding: 2px;">V/f</span> <span style="background-color: black; color: white; padding: 2px;">OLV/PM</span> <span style="background-color: black; color: white; padding: 2px;">EZOLV</span> </div> Sets the method to determine when it is necessary to de-stage the previous Lead Drive to keep the setpoint.	0 (0 - 2)

## 0 : Output Frequency

The drive monitors the output frequency of the Lead Drive.

When the output frequency  $< Y9-13$  [De-staging Frequency Level] for the time set in Y9-15 [De-staging Delay Time] and when this drive is not the only drive running, the Lead Drive will send a de-stage request.

### 1 : Feedback

The drive monitors the feedback level of the Lead Drive.

When the difference between the feedback and the setpoint is more than Y9-14 [De-staging Delta Feedback Level] for the time set in Y9-15 and when this drive is not the only drive running, the Lead Drive will send a de-stage request.

### 2 : Feedback + Fout



The drive monitors the feedback level and output frequency.

When the output frequency  $< Y9-13$  and the difference between the feedback and the setpoint is more than  $Y9-14$  for the time set in  $Y9-15$ , and when this drive is not the only drive running, the Lead Drive will send a de-stage request.

### ■ Y9-13: De-staging Frequency Level

No. (Hex.)	Name	Description	Default (Range)
Y9-13 (3E00) RUN	De-staging Frequency Level	<input type="checkbox"/> V/f <input type="checkbox"/> OLV/PM <input type="checkbox"/> EZOLV Sets the level below which the output frequency must decrease before the Lead Drive will request to be removed from the system through the MEMOBUS network.	40.0 Hz (0.0 - 400.0 Hz)

**Note:**

- When  $A1-02 = 8$  [Control Method Selection = EZOLV], the range is 0.0 - 120.0 Hz.
- Parameter  $Y9-12$  [De-staging Mode] sets the condition to request for the removal:
  - $Y9-12 = 0$  [Output Frequency]: The output frequency must decrease to less than this level for the time set in  $Y9-15$  [De-staging Delay Time] to request for the removal.
  - $Y9-12 = 2$  [Feedback + Fout]: The output frequency must decrease to less than this level and the difference between the feedback and setpoint must be more than  $Y9-14$  [De-staging Delta Feedback Level] for the time set in  $Y9-15$  [De-staging Delay Time] to request for the removal.

### ■ Y9-14: De-staging Delta Feedback Level

No. (Hex.)	Name	Description	Default (Range)
Y9-14 (3E01) RUN	De-staging Delta Feedback Level	<input type="checkbox"/> V/f <input type="checkbox"/> OLV/PM <input type="checkbox"/> EZOLV Sets the level above which the difference between the feedback and setpoint must increase before the lead drive will request to be removed from the system through the MEMOBUS network.	0.00 (0.00 - 600.00)

**Note:**

- When  $b5-09 = 0$  [PID Output Level Selection = Normal Output (Direct Acting)], the drive uses the feedback minus the setpoint to determine the delta feedback level.
- When  $b5-09 = 1$  [Reverse Output (Reverse Acting)], the drive uses the setpoint minus the feedback to determine the delta feedback level.
- Parameter  $Y9-12$  [De-staging Mode] sets the condition to request for the removal:
  - $Y9-12 = 1$  [Feedback]: The difference between the feedback and setpoint must increase to more than this level for the time set in  $Y9-15$  [De-staging Delay Time] to request for the removal.
  - $Y9-12 = 2$  [Feedback + Fout]: The difference between the feedback and setpoint must increase to more than this level and the output frequency must be less than  $Y9-13$  [De-staging Frequency Level] level for the time set in  $Y9-15$  [De-staging Delay Time] to request for the removal.
- Parameters  $b5-46$  [PID Unit Display Selection],  $b5-38$  [PID User Unit Display Scaling], and  $b5-39$  [PID User Unit Display Digits] set the unit, range, and resolution.

### ■ Y9-15: De-staging Delay Time

No. (Hex.)	Name	Description	Default (Range)
Y9-15 (3E02) RUN	De-staging Delay Time	<input type="checkbox"/> V/f <input type="checkbox"/> OLV/PM <input type="checkbox"/> EZOLV Sets the delay time before removing the Lead Drive from the system.	10 s (0 - 3600 s)

### ■ Y9-16: Stabilization Time

No. (Hex.)	Name	Description	Default (Range)
Y9-16 (3E03) RUN	Stabilization Time	<input type="checkbox"/> V/f <input type="checkbox"/> OLV/PM <input type="checkbox"/> EZOLV Sets the time used to keep the system stable when you stage or de-stage a drive.	3 s (0 - 3600 s)

**Note:**

Lead-lag control and pump protection is stopped during the stabilization time.

### ■ Y9-17: Setpoint Modifier

No. (Hex.)	Name	Description	Default (Range)
Y9-17 (3E04) RUN	Setpoint Modifier	<b>V/f</b> <b>OLV/PM</b> <b>EZOLV</b> Sets the value by which the system setpoint is incremented as specified by the number of drives that are running.	0.00 (-99.99 - +99.99)

### ■ Y9-18: High Feedback De-stage Level

No. (Hex.)	Name	Description	Default (Range)
Y9-18 (3E05) RUN	High Feedback De-stage Level	<b>V/f</b> <b>OLV/PM</b> <b>EZOLV</b> Sets the feedback level to trigger a quick de-stage as a percentage of Y1-11 [High Feedback Level].	97.0% (0.0 - 100.0%)

**Note:**

- The quick de-stage ignores parameters Y9-12 [De-staging Mode] to Y9-15 [De-staging Delay Time] and only uses an internal 2 s delay.
- Set this parameter to 0.0 to disable the function.

### ■ Y9-19: Alternation Time Unit

No. (Hex.)	Name	Description	Default (Range)
Y9-19 (3E06) RUN	Alternation Time Unit	<b>V/f</b> <b>OLV/PM</b> <b>EZOLV</b> Sets the units for Y9-03 [Alternation Time]. You can set this parameter to 1 [Minutes (min)] during commission to test the alternation function.	0 (0, 1)

**Note:**

You can use this parameter only when Y1-03 = 3 [Multiplex Mode = Memobus Network].

#### 0 : Hours (H)

#### 1 : Minutes (min)

### ■ Y9-20: Allow Network Run

No. (Hex.)	Name	Description	Default (Range)
Y9-20 (3E07)	Allow Network Run	<b>V/f</b> <b>OLV/PM</b> <b>EZOLV</b> Sets when the drive will respond to a network Run command.	0 (0 - 3)

#### 0 : Always

Drive will respond to all network Run commands (first drive, staging, or alternation).

#### 1 : First/Alternation

Drive can only be the first drive or for alternation.

#### 2 : First Only

The drive can only be a first drive.

#### 3 : Alternation Only

The drive is only available for alternation.

### ■ Y9-21: Run Priority

No. (Hex.)	Name	Description	Default (Range)
Y9-21 (3E08) RUN	Run Priority	<b>V/f</b> <b>OLV/PM</b> <b>EZOLV</b> Sets the Lead Drive selection priority to override the Y9-01 [Lead Drive Selection] selection.	8 (1 - 16)

**Note:**

- The drive with the lowest *Y9-21* value has the highest priority and will become the Lead Drive first. If more than one drive has the lowest *Y9-21* value, then *Y9-01* [*Lead Drive Selection*] selects which drive becomes the lead.
- When you set *Y9-21* to the same value for all drives on the MEMOBUS network, it will disable this function. If more than one drive has the same *Y9-21* value, then *Y9-01* will select the next Lead Drive.
- To give First Drive (and Lead Drive) control back to the drive with highest priority level set in *Y9-21*, set *Y9-24* [*Lead Swap at Sleep Delay Time*] on the other drives with a lower priority level.

### ■ Y9-22: System Fault Retry Attempts

No. (Hex.)	Name	Description	Default (Range)
Y9-22 (3E09) RUN	System Fault Retry Attempts	<input type="checkbox"/> V/f <input type="checkbox"/> OLV/PM <input type="checkbox"/> EZOLV Sets the number of times that the MEMOBUS Network will allow automatic restarts of system faults. The drive uses <i>L5-04</i> [ <i>Interval Method Restart Time</i> ] to select the time to try a system fault restart.	5 (0 - 10)

**Note:**

Set this parameter to the same value for all drives on the network for correct operation.

### ■ Y9-23: Max Drives Allowed to Run

No. (Hex.)	Name	Description	Default (Range)
Y9-23 (3E0A)	Max Drives Allowed to Run	<input type="checkbox"/> V/f <input type="checkbox"/> OLV/PM <input type="checkbox"/> EZOLV Sets the maximum number of drives that can run on the system.	4 (1 - 4)

### ■ Y9-24: Lead Swap at Sleep Delay Time

No. (Hex.)	Name	Description	Default (Range)
Y9-24 (3E0B) RUN	Lead Swap at Sleep Delay Time	<input type="checkbox"/> V/f <input type="checkbox"/> OLV/PM <input type="checkbox"/> EZOLV Sets the length of time that the Lead Drive will be in Sleep Mode before the drive will request for a swap when there is another drive available with a lower <i>Y9-21</i> [ <i>Run Priority</i> ] setting.	0 s (0 - 7200 s)

**Note:**

Set this parameter to 0 to disable the function.

### ■ Y9-25: Highest Node Address

No. (Hex.)	Name	Description	Default (Range)
Y9-25 (3E0C)	Highest Node Address	<input type="checkbox"/> V/f <input type="checkbox"/> OLV/PM <input type="checkbox"/> EZOLV Sets the highest possible node address in the MEMOBUS network.	4 (2 - 4)

**Note:**

For optimal network performance, set the serial communication address *H5-01* [*Drive Node Address*] beginning with 01H consecutively up to the last drive and then set this parameter to the final *H5-01* address.

### ■ Y9-26: Master Time-out

No. (Hex.)	Name	Description	Default (Range)
Y9-26 (3E0D)	Master Time-out	<input type="checkbox"/> V/f <input type="checkbox"/> OLV/PM <input type="checkbox"/> EZOLV Sets the minimum length of time that the slave drives will wait for a message from the master before they do the action set in <i>Y9-27</i> [ <i>Network Recovery</i> ].	4.0 s (1.0 - 10.0 s)

### ■ Y9-27: Network Recovery

No. (Hex.)	Name	Description	Default (Range)
Y9-27 (3E0E)	Network Recovery	<input type="checkbox"/> V/f <input type="checkbox"/> OLV/PM <input type="checkbox"/> EZOLV Sets the slave drive response when it does not receive a message from the master for the time set in <i>Y9-26</i> [ <i>Master Time-out</i> ].	0 (0 - 3)

## 0 : Automatic

When the Master drive becomes slave drive, another drive will function as a Master drive after the Master Time-out is expired.

**1 : Slave/Resume**

The drive will not become the network master.

When the Master drive becomes slave drive, another drive will function as a Master drive after the Master Time-out is expired.

**Note:**

The drive continues to operate in its current operation status although this can cause an unwanted condition.

**2 : Slave/Stop**

The drive will not become the network master.

The drive will detect an *MSL [Net Master Lost]* fault if the master goes offline. The drive will stop operation if the master goes offline.

**3 : Fault MSL**

The drive will detect an *MSL* fault and stop the operation after the *Y9-26* time is expired.

**■ Y9-28: NETSCAN Alarm Time**

No. (Hex.)	Name	Description	Default (Range)
Y9-28 (3E0F)	NETSCAN Alarm Time	<b>V/f</b> <b>OLV/PM</b> <b>EZOLV</b> Sets the length of time that the slave drives will wait for a message from the master before they will show an <i>NETSC [NETSCAN Waiting for Master]</i> alarm.	2.0 s (1.0 - 10.0 s)

**Note:**

If the network response is late or many node drives are offline, increase the value of this parameter. The master identifies an offline drive as node 1 to *Y9-25 [Highest Node Address]* that does not have a power supply, has connection problems, or is not connected to the network.

**■ Y9-29: Network AUTO Start Delay**

No. (Hex.)	Name	Description	Default (Range)
Y9-29 (3E10) RUN	Network AUTO Start Delay	<b>V/f</b> <b>OLV/PM</b> <b>EZOLV</b> Sets the length of time that the network will wait before it selects and starts the Lead Drive after the First Drive on the network is in AUTO Mode.	2.0 s (0.0 - 60.0 s)

**■ Y9-30: Lag Speed Follower Gain**

No. (Hex.)	Name	Description	Default (Range)
Y9-30 (3E11) RUN	Lag Speed Follower Gain	<b>V/f</b> <b>OLV/PM</b> <b>EZOLV</b> Sets the gain applied to the speed of the current Lead Drive when <i>Y9-05 = 3 [Lag Drive Mode = Follow Lead Speed]</i> . Set the bias to apply in <i>Y9-31 [Lag Speed Follower Bias]</i> .	100.0% (0.0 - 300.0%)

**■ Y9-31: Lag Speed Follower Bias**

No. (Hex.)	Name	Description	Default (Range)
Y9-31 (3E12) RUN	Lag Speed Follower Bias	<b>V/f</b> <b>OLV/PM</b> <b>EZOLV</b> Sets the bias applied to the speed of the current Lead Drive when <i>Y9-05 = 3 [Lag Drive Mode = Follow Lead Speed]</i> . Set the gain to apply in <i>Y9-30 [Lag Speed Follower Gain]</i> .	0.00 Hz (-60.00 - +60.00 Hz)

**■ Y9-32: Lag Follower Deceleration Rate**

No. (Hex.)	Name	Description	Default (Range)
Y9-32 (3E13) RUN	Lag Follower Deceleration Rate	<b>V/f</b> <b>OLV/PM</b> <b>EZOLV</b> Sets the deceleration time when the <i>Y9-33 [Lag Follower Decel Activ Time]</i> timer is running and the drive is running as Lag Drive Speed Follower ( <i>Y9-05 = 3 [Lag Drive Mode = Follow Lead Speed]</i> ).	60.0 s (0.0 - 1000.0 s)

### ■ Y9-33: Lag Follower Decel Activ Time

No. (Hex.)	Name	Description	Default (Range)
Y9-33 (3E14) RUN	Lag Follower Decel Activ Time	<b>V/f</b> <b>OLV/PM</b> <b>EZOLV</b> Sets the time during which the deceleration time set in Y9-32 [ <i>Lag Follower Deceleration Rate</i> ] is effective. The drive will use the standard deceleration rate when it is expired.	0.0 s (0.0 - 3600.0 s)

**Note:**

Set this parameter to 0.0 to disable the function.

### ■ Y9-34: Low Feedback De-stage

No. (Hex.)	Name	Description	Default (Range)
Y9-34 (3E15) RUN	Low Feedback De-stage	<b>V/f</b> <b>OLV/PM</b> <b>EZOLV</b> Sets the low feedback level that will trigger a quick de-stage.	0.00 (0.00 - 600.00)

**Note:**

- Parameters *b5-46* [*PID Unit Display Selection*], *b5-38* [*PID User Unit Display Scaling*], and *b5-39* [*PID User Unit Display Digits*] set the unit, range, and resolution.
- The quick de-stage ignores *Y9-12* [*De-staging Mode*] and *Y9-15* [*De-staging Delay Time*] and only uses an internal 2 s delay.
- Set this parameter to 0.00 to disable the function.

### ■ Y9-35: Alternation Stabilize Time

No. (Hex.)	Name	Description	Default (Range)
Y9-35 (3E16) RUN	Alternation Stabilize Time	<b>V/f</b> <b>OLV/PM</b> <b>EZOLV</b> Sets the maximum length of time the drive will stay running after it is called to alternate-out. The drive will be in Alternation Stabilization Mode during this time.	0 s (0 - 1000 s)

**Note:**

Set this parameter to 0 to disable the function.

### ■ Y9-36: Alternation Stabilize Bias

No. (Hex.)	Name	Description	Default (Range)
Y9-36 (3E17) RUN	Alternation Stabilize Bias	<b>V/f</b> <b>OLV/PM</b> <b>EZOLV</b> Sets the minimum quantity of PID error applied to the drive during Alternation Stabilization Mode. A lower value can cause it to stay running longer, while a higher value will make the change faster, but it will have a larger pressure change.	0.50% (0.00 - 10.00%)

**Note:**

Set as a percentage of *b5-38* [*PID Unit Scaling*].

### ■ Y9-50: PI Auxiliary Control Source

No. (Hex.)	Name	Description	Default (Range)
Y9-50 (3E25)	PI Auxiliary Control Source	<b>V/f</b> <b>OLV/PM</b> <b>EZOLV</b> Sets the signal to use for <i>PI Auxiliary Control</i> [ <i>YF-xx</i> ] when <i>Y1-01</i> = 3 [ <i>Multiplex Mode = Memobus Network</i> ].	0 (0 - 3)

**Note:**

- Drives that have *YF-19* = 0 [*PI Aux Ctrl Feedback WireBreak = Disabled*] and *Y9-50* ≠ 3 will have wire-break detection and will continuously send valid or invalid PI Aux Feedback signals to the Network.
- When *YF-19* = 2 [*Fault (no retry, coast to stop)*] and *Y9-50* ≠ 3, the PI Auxiliary Feedback detection will cause an alarm(not a fault) when one of these conditions is true:
  - The drive is in HAND Mode
  - There is no Lead Drive on the network
  - The drive is not in AUTO Mode

### 0 : Analog Only

The drive will not read the Network PI Aux Feedback register as the source, although the drive will still transmit its signal to the network.

The drive will respond as specified by *YF-19*.

**1 : Ana->Net, No Alarm**

The drive will read the Network PI Auxiliary Feedback register if the analog detection finds a signal loss through the terminal set for *H3-xx = 27* [*MFAI Function Selection = PI Auxiliary Control Feedback*]. When a wire-break detection occurs, the drive will automatically use the network value.

If the Network PI Auxiliary Feedback signal is also not valid, the drive will operate as specified by *YF-19*.

**Note:**

When *YF-19 = 0*, the drive will disable wire-break detection and will not let the drive switch to the Network PI Auxiliary Feedback.

**2 : Ana->Net, Alarm**

The drive will read the Network PI Auxiliary Feedback register if the analog detection finds a signal loss through the terminal set for *H3-xx = 27*. When a wire-break detection occurs, the drive will automatically use the network value and the keypad will show an *AuFbl* [*PI Aux Fdbk Lost Switched to Net*] alarm.

If the Network PI Auxiliary Feedback signal is also not valid, the drive will operate as specified by *YF-19*.

**Note:**

When *YF-19 = 0*, the drive will disable wire-break detection and will not let the drive switch to the Network PI Auxiliary Feedback.

**3 : Network Only**

The drive will always read the Network PI Auxiliary Feedback register.

If the Network PI Auxiliary Feedback signal is also not valid, the drive will operate as specified by *YF-19*, with these differences:

- When *YF-19 = 1* [*Alarm Only*], the drive will show a [*PI Aux Control: Net Feedback Lost*] message. It will not show an alarm.
- When *YF-19 = 2*, the drive will show a [*PI Aux Control: Net Feedback Lost*] message, not accept Network Run commands, and set the stopping method to coast-to-stop. It will not show a fault.

**■ Y9-51: PI Aux Control Turn-Off Method**

No. (Hex.)	Name	Description	Default (Range)
Y9-51 (3E26)	PI Aux Control Turn-Off Method	<input type="checkbox"/> V/f <input type="checkbox"/> OLV/IPM <input type="checkbox"/> EZOLV Sets the MEMOBUS Multiplex response to the PI Aux Control.	0 (0, 1)

**0 : Disabled**

PI Aux Feedback Level does not have an effect on Idle or Lag Drives.

PI Aux Feedback Level will not cause an alternation.

**1 : Enabled**

The drive operation changes when *YF-23* [*PI Aux Ctrl Output Level Select*] changes:

- *YF-23 = 0* [*Direct Acting*]:  
When the PI Aux Control level is more than *YF-06* [*PI Aux Control Wake-Up Level*], a drive is offline and the system will remove a Lag Drive.  
When the PI Aux Control level is more than *YF-03* [*PI Aux Control Setpoint*], the system will alternate a Lead Drive in PI Aux Control.
- *YF-23 = 1* [*Inverse Acting*]:  
When the PI Aux Control level is less than *YF-06*, a drive is offline and the system will remove a Lag Drive.  
When the PI Aux Control level is less than *YF-03*, the system will alternate a Lead Drive in PI Aux Control.

**■ Y9-98: Network Parameter Push**

No. (Hex.)	Name	Description	Default (Range)
Y9-98 (3E55)	Network Parameter Push	<input type="checkbox"/> V/f <input type="checkbox"/> OLV/IPM <input type="checkbox"/> EZOLV Sets how the system sends System-wide parameters into the MEMOBUS Multiplex network.	1 (0, 1)

0 : Disabled

1 : Enabled/Prompt

## ◆ YA: Preset Setpoint

### ■ Setpoint Selection

Parameters *YA-01 [Setpoint 1]* to *YA-04 [Setpoint 4]* set the PID setpoint.

The priority over PID setpoint changes when the settings of MFDI functions *H1-xx = 3E* and *3F [PID Setpoint Selection 1 and 2]* change. [Table 12.83](#) shows how the different MFDI functions (*H1-xx = 3E* and *3F [PID Setpoint Selection 1 and 2]*) have an effect on the PID setpoint value.

**Table 12.83 Switching of MFDI and PID Setpoint Value**

H1-xx = 3E	H1-xx = 3F	PID Setpoint Value
OFF	OFF	One of these values: <ul style="list-style-type: none"> <li>• Frequency Reference (determined by <i>b1-01 [Frequency Reference Selection 1]</i>)</li> <li>• <i>YA-01 [Setpoint 1]</i> (when <i>b1-01 = 0 [Keypad]</i>)</li> <li>• Analog Setpoint (when <i>H3-xx = C [MFAI Function Selection = PID Setpoint]</i>)</li> <li>• MEMOBUS setpoint</li> </ul>
ON	OFF	YA-02 [Setpoint2]
OFF	ON	YA-03 [Setpoint3]
ON	ON	YA-04 [Setpoint4]

You can also use *H1-xx = 83 to 85 [Dedicated Multi-Setpoint YA-02 to YA-04]* to select the digital setpoints as an alternative to *3E* and *3F*. [Table 12.84](#) shows which Setpoint is active as specified by the Dedicated Multi-Setpoint Selections.

**Table 12.84 Dedicated Multi-Setpoint Selections and Active Setpoints**

Alternate Multi-Setpoint YA-02 H1-xx = 83	Alternate Multi-Setpoint YA-03 H1-xx = 84	Alternate Multi-Setpoint YA-04 H1-xx = 85	Setpoint
OFF	OFF	OFF	YA-01
ON	ON/OFF	ON/OFF	YA-02
OFF	ON	ON/OFF	YA-03
OFF	OFF	ON	YA-04

**Note:**

- For all sources, you can change the value of setpoint with other functions, for example Sleep Boost function and the Multiplexing functions.
- If you set a minimum of one PID Setpoint Selection (*H1-xx = 3E* or *3F*) and a minimum one Alternate Multi-Setpoint Selection (*H1-xx = 83, 84, or 85*), the drive will detect an *oPE03 [Multi-Function Input Setting Err]*.

### System Feedback Monitor

Monitor *U1-61 [System Feedback]* shows the currently set PID Feedback from these four sources:

- *H3-xx = B [MFAI Function Selection = PID Feedback]*
- *H3-xx = 24 [PID Feedback Backup]*
- *H3-xx = 2D [Differential Level Source]*
- *Y9-02 ≠ 0 [System Feedback Source ≠ Analog only]*

Monitor *U1-61* will show the PID Feedback when the PID is disabled.

**Note:**

The System Feedback ignores these feedback sources, which are only shown in *U5-01 [PID Feedback]*:



- MEMOBUS Register 15FF (Hex.) [Memobus PID Feedback]
- *H3-xx = 2B [Emergency Override PID Feedback]*
- MEMOBUS Register 3A95 (Hex.) [Emergency Override PID Feedback]

### Automatic Setpoint Display Switch-over when in PID Mode

When the drive is in PID mode, the Home screen will change to show *U5-99 [Setpoint]*. It will not show *U1-01 [Frequency Reference]*.

When  $b1-01 = 0$  [*Frequency Reference Selection 1 = Keypad*] and you push  on the Home screen, the keypad will show YA-01, YA-02, YA-03, or YA-04 and let you change it.



### ■ YA-01: Setpoint 1

No. (Hex.)	Name	Description	Default (Range)
YA-01 (3E58) RUN	Setpoint 1	   Sets the PID Setpoint when $b1-01 = 0$ [ <i>Frequency Reference Selection 1 = Keypad or Multi-Speed Selection</i> ].	0.00 (0.00 - 600.00)

**Note:**

Parameters  $b5-46$  [*PID Unit Display Selection*],  $b5-38$  [*PID User Unit Display Scaling*], and  $b5-39$  [*PID User Unit Display Digits*] set the unit, scaling, and resolution.



### ■ YA-02: Setpoint 2

No. (Hex.)	Name	Description	Default (Range)
YA-02 (3E59) RUN	Setpoint 2	   Sets the PID Setpoint as specified by the Multi-Setpoint digital inputs.	0.00 (0.00 - 600.00)

**Note:**

Parameters  $b5-46$  [*PID Unit Display Selection*],  $b5-38$  [*PID User Unit Display Scaling*], and  $b5-39$  [*PID User Unit Display Digits*] set the unit, scaling, and resolution.



### ■ YA-03: Setpoint 3

No. (Hex.)	Name	Description	Default (Range)
YA-03 (3E5A) RUN	Setpoint 3	   Sets the PID Setpoint as specified by the Multi-Setpoint digital inputs.	0.00 (0.00 - 600.00)

**Note:**

Parameters  $b5-46$  [*PID Unit Display Selection*],  $b5-38$  [*PID User Unit Display Scaling*], and  $b5-39$  [*PID User Unit Display Digits*] set the unit, scaling, and resolution.

### ■ YA-04: Setpoint 4

No. (Hex.)	Name	Description	Default (Range)
YA-04 (3E5B) RUN	Setpoint 4	   Sets the PID Setpoint as specified by the Multi-Setpoint digital inputs.	0.00 (0.00 - 600.00)

**Note:**

Parameters  $b5-46$  [*PID Unit Display Selection*],  $b5-38$  [*PID User Unit Display Scaling*], and  $b5-39$  [*PID User Unit Display Digits*] set the unit, scaling, and resolution.

## ◆ YC: Foldback Features

YC parameters set Output Current Limit function.

### ■ Output Current Limit

The Output Current Limit function sets the current limit of motor. This function prevents long-term overload conditions of motor when there is bearing degradation.

The drive will try to decrease the frequency reference to limit the output current. Parameter YC-02 [*Current Limit*] sets the current limit setpoint. When the motor current increases to more than the setpoint, the drive will decrease the output frequency.



## ■ YC-01: Output Current Limit Select

No. (Hex.)	Name	Description	Default (Range)
YC-01 (3EBC)	Output Current Limit Select	<b>V/f</b> <b>OLV/PM</b> <b>EZOLV</b> Sets the function to enable or disable the output current regulator.	0 (0, 1)

**0** : Disabled

**1** : Enabled

## ■ YC-02: Current Limit

No. (Hex.)	Name	Description	Default (Range)
YC-02 (3EBD) RUN	Current Limit	<b>V/f</b> <b>OLV/PM</b> <b>EZOLV</b> Sets the current limit.	0.0 A (0.0 - 1000.0 A)

**Note:**

Value is internally limited to 300% of the drive rated current set in *n9-01* [Inverter Rated Current].

## ◆ YF: PI Auxiliary Control

PI Auxiliary Control lets the drive control pressure when the PI Auxiliary Level is adequate. When the PI Auxiliary Control Level decreases to the PI Auxiliary Control Setpoint set in parameter *YF-03* [PI Aux Control Setpoint], the drive will regulate based on the PI Aux Level and the pressure will decrease. The drive also goes to sleep, wakes up, and detects an alarm and/or fault based on the PI Auxiliary Control level.

### ■ Enable PI Aux Level Control Features

Set *YF-01* = 1 [PI Aux Control Selection = Enabled] to enable PI Aux Level Control and PI Aux Low Level Detection.

Figure 12.122 shows the primary PID and PI Auxiliary Control Diagram when *YF-01* = 1.

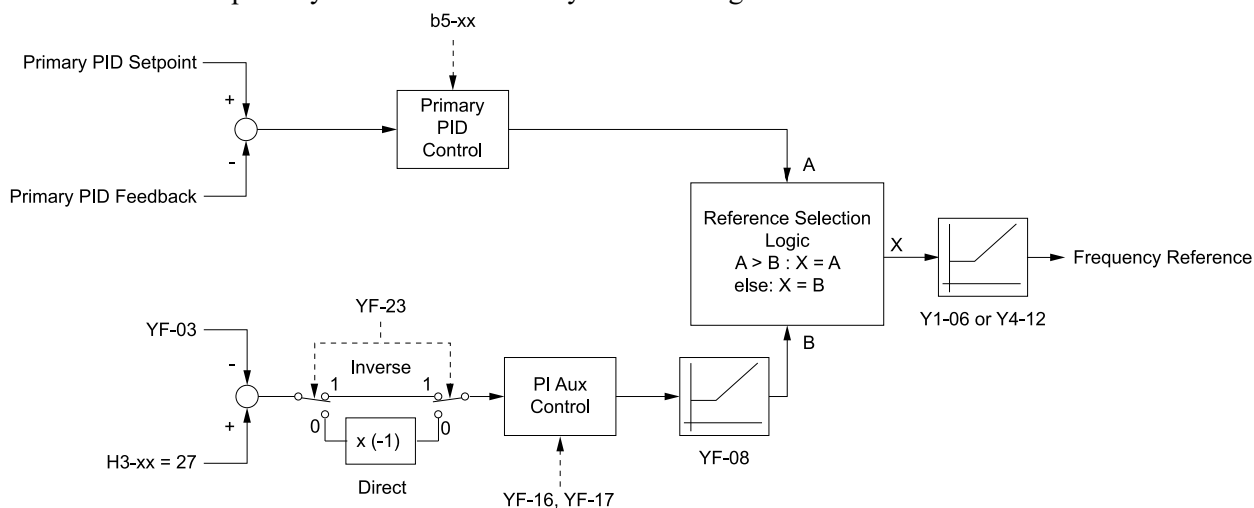

**b5-xx**: PID Control

**H3-xx = 27**: PI Auxiliary Control Feedback

**Y1-06**: Minimum Speed

**Y4-12**: Thrust Frequency

**YF-03**: PI Aux Control Setpoint

**YF-08**: PI Aux Control Minimum Speed

**YF-16**: PI Auxiliary Control P Gain

**YF-17**: PI Auxiliary Control I Time

**YF-23**: PI Aux Ctrl Output Level Select

Figure 12.122 Primary PID and PI Auxiliary Control Diagram

### High PI Auxiliary Feedback Level Detection

Table 12.85 Absolute Mode and Delta to Setpoint Mode

Entry Mode	Keypad Display		Description
	YF-09	YF-12	
Absolute	<div style="border: 1px solid black; padding: 5px; font-family: monospace;">                     10:00 am FWD Parameters                      PI Aux Control Low Lvl Detection                      Absolute Mode                        020.00 %                      Default : 0.00%                      Range : 0.00~99.99                      Back Default Min/Max                 </div>	<div style="border: 1px solid black; padding: 5px; font-family: monospace;">                     10:00 am FWD Parameters                      PI Aux Control High Level Detect                      Absolute Mode                        020.00 %                      Default : 0.00%                      Range : 0.00~99.99                      Back Default Min/Max                 </div>	The values set for <i>YF-09</i> and <i>YF-12</i> represent the feedback level that will cause a Low PI Auxiliary Feedback and High PI Auxiliary Feedback. You can set these parameters as an absolute value.  When the left-most digit changes to a Δ (delta), you can set the Low Feedback Level and High Feedback Level relative to the setpoint. The effective Low PI Auxiliary Feedback Level is "Setpoint - <i>YF-09</i> ", and the effective High PI Auxiliary Feedback Level is "Setpoint + <i>YF-12</i> ".
Delta to Setpoint	<div style="border: 1px solid black; padding: 5px; font-family: monospace;">                     10:00 am FWD Parameters                      PI Aux Control Low Lvl Detection                      Delta to Setpoint Mode                        Δ20.00 %                      Default : 0.00%                      Range : 0.00~99.99                      Back Default Min/Max                 </div>	<div style="border: 1px solid black; padding: 5px; font-family: monospace;">                     10:00 am FWD Parameters                      PI Aux Control High Level Detect                      Delta to Setpoint Mode                        Δ20.00 %                      Default : 0.00%                      Range : 0.00~99.99                      Back Default Min/Max                 </div>	

### YF-01: PI Aux Control Selection

No. (Hex.)	Name	Description	Default (Range)
YF-01 (3F50)	PI Aux Control Selection	<input type="checkbox"/> V/f <input checked="" type="checkbox"/> OLV/PM <input type="checkbox"/> EZOLV Sets the PI Auxiliary Control function.	0 (0, 1)

0 : Disabled

1 : Enabled

When *Y1-01* = 3 [*Multiplex Mode = Memobus Network*] and *YF-01* = 1, a staged Lead drive will de-stage as specified by minimum or maximum PI Auxiliary Feedback Level:

- A staged Lead drive will de-stage when *U5-16* [*PI Aux Ctrl Feedback*] is less than *YF-04* [*PI Aux Control Minimum Level*] for the time set in *YF-05* [*PI Aux Control Sleep Delay Time*].
- A staged Lead drive will de-stage when *U5-16* is more than *YF-24* [*PI Auxiliary Ctrl Maximum Level*] for the time set in *YF-05*.

### YF-02: PI Aux Control Transducer Scale

No. (Hex.)	Name	Description	Default (Range)
YF-02 (3F51) RUN	PI Aux Control Transducer Scale	<input type="checkbox"/> V/f <input checked="" type="checkbox"/> OLV/PM <input type="checkbox"/> EZOLV Sets the full scale (10 V or 20 mA) output of the pressure transducer connected to the analog input terminal programmed for <i>H3-xx</i> = 27 [ <i>PI Aux Control Feedback Level</i> ].	145.0 (1.0 - 6000.0)

**Note:**

Parameters *YF-21* [*PI Aux Ctrl Level Unit Selection*] and *YF-22* [*PI Aux Level Decimal Place Pos*] set the unit and resolution.

### YF-03: PI Aux Control Setpoint

No. (Hex.)	Name	Description	Default (Range)
YF-03 (3F52) RUN	PI Aux Control Setpoint	<input type="checkbox"/> V/f <input checked="" type="checkbox"/> OLV/PM <input type="checkbox"/> EZOLV Sets the level to which the drive will try to regulate.	20.0 PSI (0.0 - 6000.0)

**Note:**

Parameters *YF-21* [*PI Aux Ctrl Level Unit Selection*] and *YF-22* [*PI Aux Level Decimal Place Pos*] set the unit and resolution.

### ■ YF-04: PI Aux Control Minimum Level

No. (Hex.)	Name	Description	Default (Range)
YF-04 (3F53) RUN	PI Aux Control Minimum Level	<b>V/f</b> <b>OLV/PM</b> <b>EZOLV</b> Sets the level below which the drive must be for longer than <i>YF-05 [PI Aux Control Sleep Delay Time]</i> before the drive goes to sleep and turns off all lag pumps.	10.0 PSI (0.0 - 6000.0)

**Note:**

- Set this parameter to 0.0 to disable the function.
- Parameters *YF-21 [PI Aux Ctrl Level Unit Selection]* and *YF-22 [PI Aux Level Decimal Place Pos]* set the unit and resolution.

### ■ YF-05: PI Aux Control Sleep Delay Time

No. (Hex.)	Name	Description	Default (Range)
YF-05 (3F54) RUN	PI Aux Control Sleep Delay Time	<b>V/f</b> <b>OLV/PM</b> <b>EZOLV</b> Sets the length of time that the drive will delay before it goes to sleep after the level is less than <i>YF-04 [PI Aux Control Minimum Level]</i> (when <i>YF-23 = 1 [PI Aux Ctrl Output Level Select = Inverse Acting]</i> ) or more than <i>YF-24 [PI Auxiliary Ctrl Maximum Level]</i> (when <i>YF-23 = 0 [Direct Acting]</i> ).	5 s (0 - 3600 s)

### ■ YF-06: PI Aux Control Wake-up Level

No. (Hex.)	Name	Description	Default (Range)
YF-06 (3F55) RUN	PI Aux Control Wake-up Level	<b>V/f</b> <b>OLV/PM</b> <b>EZOLV</b> Sets the level to wake up the drive when the drive after <i>YF-04 [PI Aux Control Minimum Level]</i> or <i>YF-24 [PI Auxiliary Ctrl Maximum Level]</i> put the drive to sleep.	30.0 PSI (0.0 - 999.9 PSI)

**Note:**

- Parameter *YF-23 [PI Aux Ctrl Output Level Select]* sets the condition to wake up the drive.
  - *YF-23 = 0 [Direct Acting]*: The PI Aux Feedback must be less than the level set in this parameter for longer than the time set in *YF-07* to wake up.
  - *YF-23 = 1 [Inverse Acting]*: The PI Aux Feedback must be more than the level set in this parameter for longer than the time set in *YF-07 [PI Aux Control Wake-up Time]* to wake up.
- Parameters *YF-21 [PI Aux Ctrl Level Unit Selection]* and *YF-22 [PI Aux Level Decimal Place Pos]* set the unit and resolution.

### ■ YF-07: PI Aux Control Wake-up Time

No. (Hex.)	Name	Description	Default (Range)
YF-07 (3F56)	PI Aux Control Wake-up Time	<b>V/f</b> <b>OLV/PM</b> <b>EZOLV</b> Sets the time to wake up the drive when the drive after <i>YF-04 [PI Aux Control Minimum Level]</i> or <i>YF-24 [PI Auxiliary Ctrl Maximum Level]</i> put the drive to sleep.	1 s (0 - 3600 s)

**Note:**

- Parameter *YF-23 [PI Aux Ctrl Output Level Select]* sets the condition to wake up the drive.
- *YF-23 = 0 [Direct Acting]*: The PI Aux Feedback must be less than the level set in *YF-06* for longer than the time set in *YF-07* to wake up.
  - *YF-23 = 1 [Inverse Acting]*: The PI Aux Feedback must be more than the level set in *YF-06 [PI Aux Control Wake-up Level]* for longer than the time set in *YF-07* to wake up.

### ■ YF-08: PI Aux Control Minimum Speed

No. (Hex.)	Name	Description	Default (Range)
YF-08 (3F57) RUN	PI Aux Control Minimum Speed	<b>V/f</b> <b>OLV/PM</b> <b>EZOLV</b> Sets the minimum speed at which the drive can run when the PI Auxiliary Control has an effect on the output speed.	0.00 Hz (0.00 - 400.00 Hz)

**Note:**

The drive will use *Y1-06 [Minimum Speed]* and *Y4-12 [Thrust Frequency]* as the minimum speed when PI Aux Control does not have an effect on the output speed or when you set *YF-08 < Y1-06 and Y4-12*.

### ■ YF-09: PI Aux Control Low Level Detect

No. (Hex.)	Name	Description	Default (Range)
YF-09 (3F58) RUN	PI Aux Control Low Level Detect	<b>V/f</b> <b>OLV/PM</b> <b>EZOLV</b> Sets the level below which the drive must be for longer than <i>YF-10</i> [ <i>PI Aux Control Low Lvl Det Time</i> ] to respond as specified by <i>YF-11</i> [ <i>PI Aux Control Low Level Det Sel</i> ].	0.0 PSI (0.0 - 999.9 PSI)

**Note:**

- Set this parameter to 0.0 to disable the function.
- Parameter *YF-10* only applies to when *YF-11* = 2 and 3 [*Fault and Auto-Restart (time set by YF-15)*].
- Range is 0.0 to 999.9 with a delta symbol ( $\Delta$ ) to identify Delta to Setpoint.
- Parameters *YF-21* [*PI Aux Ctrl Level Unit Selection*] and *YF-22* [*PI Aux Level Decimal Place Pos*] set the unit and resolution.

### ■ YF-10: PI Aux Low Level Detection Time

No. (Hex.)	Name	Description	Default (Range)
YF-10 (3F59) RUN	PI Aux Low Level Detection Time	<b>V/f</b> <b>OLV/PM</b> <b>EZOLV</b> Sets the length of time that the PI Aux Feedback must be less than <i>YF-09</i> [ <i>PI Aux Control Low Lvl Detection</i> ] to trigger a drive response when <i>YF-11</i> = 2 and 3 [ <i>PI Aux Control Low Level Det Sel = Fault and Auto-Restart (time set by YF-15)</i> ].	0.1 s (0.0 - 300.0 s)

### ■ YF-11: PI Aux Control Low Level Det Sel

No. (Hex.)	Name	Description	Default (Range)
YF-11 (3F5A)	PI Aux Control Low Level Det Sel	<b>V/f</b> <b>OLV/PM</b> <b>EZOLV</b> Sets drive response when the PI Aux Feedback decreases to less than <i>YF-09</i> [ <i>PI Aux Control Low Lvl Detection</i> ] for longer than <i>YF-10</i> [ <i>PI Aux Control Low Lvl Det Time</i> ].	1 (0 - 3)

**Note:**

- Set *YF-01* = 1 [*PI Aux Control Selection = Enabled*] and *YF-09* [*PI Aux Control Low Level Detect*] > 0 to enable PI Aux Low Level Detection.
- Parameter *YF-10* only applies when *YF-11* = 2 or 3.

### 0 : No Display

When the PI Aux Feedback decreases to less than the *YF-09* [*PI Aux Control Low Level Detect*] level, the digital output set for *H2-xx* = *9E* [*MFDO Function Selection = Low PI Auxiliary Control Level*] will activate. When the level increases to more than the *YF-09* level, the digital output will immediately deactivate.

### 1 : Alarm Only

When the PI Aux Feedback decreases to less than *YF-09* level, the keypad will show an *LOAUX* [*Low PI Aux Feedback Level*] alarm and the digital output set for *H2-xx* = *9E* will activate. When the feedback increases to more than *YF-09* level, the drive will clear the alarm and the digital output will deactivate.

### 2 : Fault

When the output frequency is more than zero, and the PI Aux Feedback decreases to less than the *YF-09* level, the digital output set for *H2-xx* = *9E* and an *LOAUX* alarm will immediately activate. If the feedback stays less than the *YF-09* level for the time set in *YF-10* [*PI Aux Low Level Detection Time*], the drive will detect an *LOAUX* [*Low PI Aux Feedback Level*] fault.

### 3 : Auto-Restart (time set by YF-15)

When the output frequency is more than zero, and the PI Aux Feedback decreases to less than the *YF-09* level, the digital output set for *H2-xx* = *9E* and an *LOAUX* alarm will immediately activate. If the feedback stays less than the *YF-09* level for the time set in *YF-10* [*PI Aux Low Level Detection Time*], the drive will detect an *LOAUX* fault.

When *L5-01* [*Number of Auto-Restart Attempts*] > 0 and if the drive detects an *LOAUX* fault, the drive will automatically try an Auto-Restart after *YF-15* [*PI Aux Level Detect Restart Time*] is expired. If the feedback is not more than the *YF-09* level, the Auto-Restart counter will increment and the drive will stay faulted.

## ■ YF-12: PI Aux Control High Level Detect

No. (Hex.)	Name	Description	Default (Range)
YF-12 (3F5B) RUN	PI Aux Control High Level Detect	<b>V/f</b> <b>OLV/PM</b> <b>EZOLV</b> Sets the value above which the level must be for longer than YF-13 [PI Aux High Level Detection Time] to respond as specified by YF-14 [PI Aux Hi Level Detection Select].	0.0 PSI (0.0 - 999.9 PSI)

### Note:

- Set this parameter to 0.0 to disable the function.
- Parameter YF-13 only applies to when YF-14 = 2 and 3 [Fault and Auto-Restart (time set by YF-15)].
- Range is 0.0 to 999.99 with a delta symbol ( $\Delta$ ) to identify Delta to Setpoint.
- Parameters YF-21 [PI Aux Ctrl Level Unit Selection] and YF-22 [PI Aux Level Decimal Place Pos] set the unit and resolution.

## ■ YF-13: PI Aux High Level Detection Time

No. (Hex.)	Name	Description	Default (Range)
YF-13 (3F5C) RUN	PI Aux High Level Detection Time	<b>V/f</b> <b>OLV/PM</b> <b>EZOLV</b> Sets the length of time that the level must be more than YF-12 [PI Aux Control High Level Detect] before the drive will respond when YF-14 = 2, 3 [PI Aux Hi Level Detection Select].	0.1 s (0.0 - 300.0 s)

## ■ YF-14: PI Aux Control Hi Level Det Sel

No. (Hex.)	Name	Description	Default (Range)
YF-14 (3F5D)	PI Aux Control Hi Level Det Sel	<b>V/f</b> <b>OLV/PM</b> <b>EZOLV</b> Sets the drive response when the PI Aux Feedback increases to more than the YF-12 [PI Aux Control High Level Detect] level for longer than the time set in YF-13 [PI Aux High Level Detection Time].	1 (0 - 3)

### Note:

- Set YF-01 = 1 [PI Aux Control Selection = Enabled] and YF-12 [PI Aux Control High Level Detect] > 0 to enable PI Aux High Level Detection.
- Parameter YF-13 only applies when YF-14 = 2 or 3

## 0 : NoDisplay (Digital Output Only)

When the PI Aux Feedback increases to more than the YF-12 level, the digital output set for H2-xx = 9F [MFDO Function Selection = High PI Auxiliary Control Level] will immediately activate. When the level decreases to less than the YF-12 level, the digital output will immediately deactivate.

## 1 : Alarm Only

When the PI Aux Feedback increases to more than YF-12 level, the keypad will show an HIAUX [High PI Aux Feedback Level] alarm and the digital output set for H2-xx = 9F will activate. When the feedback decreases to less than YF-12 level, the drive will clear the alarm and the digital output will deactivate.

## 2 : Fault

When the output frequency is more than zero, and the PI Aux Feedback increases to more than YF-12 level, the digital output set for H2-xx = 9F and an HIAUX alarm will immediately activate. If the feedback stays more than the YF-12 level for the time set in YF-13 [PI Aux High Level Detection Time], the drive will then detect an HIAUX [High PI Aux Feedback Level] fault.

## 3 : Auto-Restart (time set by YF-15)

When the output frequency is more than zero, and the PI Aux Feedback increases to more than YF-12 level, the digital output set for H2-xx = 9F and an HIAUX alarm will immediately activate. If the feedback stays more than the YF-12 level for the time set in YF-13, the drive will then detect an HIAUX fault.

When L5-01 [Number of Auto-Restart Attempts] > 0 and if the drive detects an HIAUX fault, the drive will automatically try an Auto-Restart after YF-15 [PI Aux Level Detect Restart Time] is expired. If the feedback is not less than the YF-12 level, the Auto-Restart counter will increment and the drive will stay faulted.

### ■ YF-15: PI Aux Level Detect Restart Time

No. (Hex.)	Name	Description	Default (Range)
YF-15 (3F5E)	PI Aux Level Detect Restart Time	<b>V/f</b> <b>OLV/PM</b> <b>EZOLV</b> Sets the length of time the drive will wait before it tries an Auto-Restart of <i>LOAUX</i> [Low PI Aux Feedback Level] or <i>HIAUX</i> [High PI Aux Feedback Level] fault.	5.0 min (0.1 - 6000.0 min)

### ■ YF-16: PI Auxiliary Control P Gain

No. (Hex.)	Name	Description	Default (Range)
YF-16 (3F5F) RUN	PI Auxiliary Control P Gain	<b>V/f</b> <b>OLV/PM</b> <b>EZOLV</b> Sets the proportional gain for the suction pressure control.	2.00 (0.00 - 25.00)

### ■ YF-17: PI Auxiliary Control I Time

No. (Hex.)	Name	Description	Default (Range)
YF-17 (3F60) RUN	PI Auxiliary Control I Time	<b>V/f</b> <b>OLV/PM</b> <b>EZOLV</b> Sets the integral time for the suction pressure control.	5.0 s (0.0 - 360.0 s)

**Note:**

Set this parameter to 0.0 to disable the integrator.

### ■ YF-18: PI Aux Control Detect Time Unit

No. (Hex.)	Name	Description	Default (Range)
YF-18 (3F61)	PI Aux Control Detect Time Unit	<b>V/f</b> <b>OLV/PM</b> <b>EZOLV</b> Sets the time unit for <i>YF-10</i> [PI Aux Control Low Lvl Det Time] and <i>YF-13</i> [PI Aux High Level Detection Time].	1 (0, 1)

**0 : Minutes (min)**

**1 : Seconds (sec)**

### ■ YF-19: PI Aux Ctrl Feedback WireBreak

No. (Hex.)	Name	Description	Default (Range)
YF-19 (3F62)	PI Aux Ctrl Feedback WireBreak	<b>V/f</b> <b>OLV/PM</b> <b>EZOLV</b> Sets how the analog input selected for PI Aux Feedback will respond when it is programmed to receive a 4 mA to 20 mA signal and the signal is lost.	2 (0 - 2)

**0 : Disabled**

**1 : Alarm Only**

The keypad will show an *AUXFB* [PI Aux Feedback Level Loss] alarm.

**2 : Fault (no retry, coast to stop)**

When the drive is in AUTO, HAND, or Sleep mode, the keypad will show an *AUXFB* [PI Aux Feedback Level Loss] fault.

**Note:**

If the drive has not received a Run command, the keypad will only show an *AUXFB* alarm.

### ■ YF-20: PI Aux Main PI Speed Control

No. (Hex.)	Name	Description	Default (Range)
YF-20 (3F63)	PI Aux Main PI Speed Control	<b>V/f</b> <b>OLV/PM</b> <b>EZOLV</b> Sets if the PI Auxiliary Controller has an effect on output speed.	1 (0, 1)

0 : Disabled

1 : Enabled

### ■ YF-21: PI Aux Ctrl Level Unit Selection

No. (Hex.)	Name	Description	Default (Range)
YF-21 (3F64)	PI Aux Ctrl Level Unit Selection	<input type="checkbox"/> V/f <input type="checkbox"/> OLV/PM <input type="checkbox"/> EZOLV Set the units shown for the PI Aux Level parameters and monitors.	1 (0 - 50)

0 : “WC: inches of water column

1 : PSI: pounds per square inch

2 : GPM: gallons/min

3 : °F: Fahrenheit

4 : ft<sup>3</sup>/min: cubic feet/min

5 : m<sup>3</sup>/h: cubic meters/hour

6 : L/h: liters/hour

7 : L/s: liters/sec

8 : bar: bar

9 : Pa: Pascal

10 : °C: Celsius

11 : m: meters

12 : ft: feet

13 : L/min: liters/min

14 : m<sup>3</sup>/min: cubic meters/min

15 : “Hg: Inch Mercury

16 : kPa: kilopascal

48 : %: Percent

49 : Custom (YF-32 ~ 34)

50 : None

### ■ YF-22: PI Aux Level Decimal Place Pos

No. (Hex.)	Name	Description	Default (Range)
YF-22 (3F65)	PI Aux Level Decimal Place Pos	<input type="checkbox"/> V/f <input type="checkbox"/> OLV/PM <input type="checkbox"/> EZOLV Sets the number of decimal places for the PI Aux Level parameters and monitors.	1 (0 - 3)

0 : No Decimal Places (XXXXX)

1 : One Decimal Places (XXXX.X)

2 : Two Decimal Places (XXX.XX)

3 : Three Decimal Places (XX.XXX)

### ■ YF-23: PI Aux Ctrl Output Level Select

No. (Hex.)	Name	Description	Default (Range)
YF-23 (3F66)	PI Aux Ctrl Output Level Select	<input type="checkbox"/> V/f <input type="checkbox"/> OLV/PM <input type="checkbox"/> EZOLV Sets the PI Auxiliary Controller to be Direct-acting or Inverse-acting.	1 (0, 1)

0 : Direct Acting

When the feedback is higher than the setpoint, the speed will be lower.

1 : Inverse Acting

When the feedback is lower than the setpoint, the speed will be lower.

### ■ YF-24: PI Auxiliary Ctrl Maximum Level

No. (Hex.)	Name	Description	Default (Range)
YF-24 (3F67) RUN	PI Auxiliary Ctrl Maximum Level	<input type="checkbox"/> V/f <input type="checkbox"/> OLV/IPM <input type="checkbox"/> EZOLV Sets the maximum level for PI Auxiliary Control. When the level is more than this setting for longer than YF-05 [PI Aux Control Sleep Delay Time], the drive will go to sleep and turn off all lag drives.	0.0 PSI (0.0 - 6000.0 PSI)

**Note:**

- Set this parameter to 0.0 to disable the function.
- Parameters YF-21 [PI Aux Ctrl Level Unit Selection] and YF-22 [PI Aux Level Decimal Place Pos] set the unit and resolution.

### ■ YF-25: PI Aux Control Activation Level

No. (Hex.)	Name	Description	Default (Range)
YF-25 (3F68) RUN	PI Aux Control Activation Level	<input type="checkbox"/> V/f <input type="checkbox"/> OLV/IPM <input type="checkbox"/> EZOLV Sets the level to activate the PI Auxiliary Control.	0.0 PSI (0.0 - 6000.0 PSI)

**Note:**

- The drive response changes when the YF-23 [PI Aux Ctrl Output Level Select] setting changes.
  - YF-23 = 0 [Direct Acting]:  
When the PI Aux Feedback level is more than this setting for longer than YF-26 [PI Aux Control Activation Delay], the drive will activate the PI Auxiliary Control to control the output frequency.
  - YF-23 = 1 [Inverse Acting]:  
When the PI Aux Feedback level is less than this setting for longer than YF-26, the drive will activate PI Auxiliary Control to control the output frequency.
- When you set this parameter to 0.0 PSI, PI Auxiliary Control is always enabled.
- Parameters YF-21 [PI Aux Ctrl Level Unit Selection] and YF-22 [PI Aux Level Decimal Place Pos] set the unit and resolution.

### ■ YF-26: PI Aux Control Activation Delay

No. (Hex.)	Name	Description	Default (Range)
YF-26 (3F69) RUN	PI Aux Control Activation Delay	<input type="checkbox"/> V/f <input type="checkbox"/> OLV/IPM <input type="checkbox"/> EZOLV Sets the delay time to activate the PI Auxiliary Control.	2 s (0 - 3600 s)

**Note:**

- The drive response changes when the YF-23 [PI Aux Ctrl Output Level Select] setting changes.
  - YF-23 = 0 [Direct Acting]:  
When the PI Aux Feedback level is more than YF-25 [PI Aux Control Activation Level] for longer than this time, the drive will activate the PI Auxiliary Control to control the output frequency.
  - YF-23 = 1 [Inverse Acting]:  
When the PI Aux Feedback level is less than YF-25 for longer than this time, the drive will activate PI Auxiliary Control to control the output frequency.
- When you set this parameter to 0.0 PSI, PI Auxiliary Control is always enabled.

### ■ YF-32: PI Aux Custom Unit Character 1

No. (Hex.)	Name	Description	Default (Range)
YF-32 (3F6F)	PI Aux Custom Unit Character 1	<input type="checkbox"/> V/f <input type="checkbox"/> OLV/IPM <input type="checkbox"/> EZOLV Sets the first character of the PI Aux custom unit display when YF-21 = 49 [PI Aux Ctrl Level Unit Selection = Custom (YF-32 ~ 34)].	41 (20 - 7A)

Refer to [Custom Units on page 656](#) for more information about available selections.



### ■ YF-33: PI Aux Custom Unit Character 2

No. (Hex.)	Name	Description	Default (Range)
YF-33 (3F70)	PI Aux Custom Unit Character 2	<div style="display: flex; gap: 5px;"> <span>V/f</span> <span>OLV/PM</span> <span>EZOLV</span> </div> Sets the second character of the PI Aux custom unit display when $YF-21 = 49$ [PI Aux Ctrl Level Unit Selection = Custom (YF-32 ~ 34)].	41 (20 - 7A)

Refer to [Custom Units on page 656](#) for more information about available selections.

### ■ YF-34: PI Aux Custom Unit Character 3

No. (Hex.)	Name	Description	Default (Range)
YF-34 (3F71)	PI Aux Custom Unit Character 3	<div style="display: flex; gap: 5px;"> <span>V/f</span> <span>OLV/PM</span> <span>EZOLV</span> </div> Sets the third character of the PI Aux custom unit display when $YF-21 = 49$ [PI Aux Ctrl Level Unit Selection = Custom (YF-32 ~ 34)].	41 (20 - 7A)

Refer to [Custom Units on page 656](#) for more information about available selections.

### ■ YF-35: PI Aux Minimum Transducer Scale

No. (Hex.)	Name	Description	Default (Range)
YF-35 (3F72) RUN	PI Aux Minimum Transducer Scale	<div style="display: flex; gap: 5px;"> <span>V/f</span> <span>OLV/PM</span> <span>EZOLV</span> </div> Sets the minimum scale output of the pressure transducer that is connected to the terminal set for $H3-xx = 27$ [MFAI Function Selection = PI Auxiliary Control Feedback].	0.0 PSI (-999.9 - +999.9 PSI)

**Note:**

- To enable this parameter, set it to less than  $YF-02$  [PI Aux Control Transducer Scale]. If you set it to more than  $YF-02$ , it will disable the PI Auxiliary Feedback (set to 0).
- Parameters  $YF-21$  [PI Aux Ctrl Level Unit Selection] and  $YF-22$  [PI Aux Level Decimal Place Pos] set the unit and resolution.

# Index

## Symbols

## Numerics

- 24 V power supply
  - Power supply input terminals ..... 105

## A

- AC reactor
  - Wiring ..... 122
- Acceleration and deceleration times
  - Switching by external input ..... 671
  - Switching by Motor 2 Selection commands ..... 672
- Acceleration time
  - Parameter ..... 671
- Adjustment of control functionality ..... 194
- AFBL ..... 345
- Alarm ..... 314, 345
- ALM indicator ..... 135
- ALM/ERR
  - LED status ..... 141
- Altitude
  - Derating ..... 432
  - Environment ..... 32
- Ambient humidity ..... 32
- Ambient Temperature Setting ..... 32
  - Derating ..... 430
  - Parameter ..... 836
- Analog gauge
  - Monitors ..... 154
- Analog input
  - Function selection for terminals A1 and A2 ..... 774
- Analog Output
  - Gain/Bias Adjustment ..... 786
  - Monitor Parameter Selection ..... 786
  - Signal Level Selection ..... 786
  - Terminal AM Monitor Selection ..... 788
  - Terminal FM Monitor Selection ..... 787
- APOGEE FLN
  - Communication specifications ..... 259
- Application Preset ..... 613
  - Operation ..... 185
- ASR
  - Fine tuning ..... 679
  - Parameter ..... 677
  - Vector Control Adjustment Procedure ..... 677
- AuDis ..... 345
- AuFbl ..... 345
- AUTO Command ..... 897
- AUTO indicator ..... 135, 137
- AUTO key ..... 135
- AUTO LED ..... 137
- Auto-Tuning ..... 187
  - Induction Motor ..... 187
  - Induction Motor Parameters ..... 910
  - PM Motor Parameters ..... 912
  - PM Motors ..... 187
  - Precautions ..... 190
  - Procedure ..... 172
  - Rotational Auto-Tuning Precautions ..... 191

- Stationary Auto-Tuning for Line-to-Line Resistance
  - precautions ..... 191
- Stationary Auto-Tuning Precautions ..... 191
- Stator resistance Auto-Tuning precautions ..... 191
- Auto-Tuning Error ..... 314, 363
- AUXFB
  - Fault ..... 322
  - Minor Fault ..... 345

## B

- Backlight
    - Timing of shut-off ..... 181
  - Backup
    - Parameters (drive to keypad) ..... 163
  - Backup function ..... 869
  - BACnet
    - Communication specifications ..... 242
    - Enter command ..... 255
    - Self-diagnosis ..... 255, 278, 290
  - Bar graph
    - Monitors ..... 152
  - Base frequency
    - Parameter ..... 700
  - Base Frequency
    - Motor 2 Parameters ..... 705
  - Base voltage
    - Motor 2 parameters ..... 706
    - Parameter ..... 701
  - Basic operation
    - Get started ..... 143
  - bAT
    - Fault ..... 322
    - Minor Fault ..... 345
  - Battery
    - Disposal ..... 417
    - Replacement ..... 411
    - Specifications ..... 411
  - bb ..... 345
  - bCE
    - Fault ..... 322
    - Minor Fault ..... 345
  - Bi-Directional function ..... 692
  - Bu-Fb ..... 346
  - BuDif ..... 346
  - BuFbl ..... 346
  - bUS
    - Detection conditions ..... 719
    - Fault ..... 322
    - Minor Fault ..... 346
    - Operation Selection after Detection ..... 718
  - bUSy ..... 346
- ## C
- CALL ..... 346
  - Capacitor Maintenance Setting ..... 871
  - Carrier frequency
    - Diminish ..... 838
    - Parameter ..... 681
  - Carrier Frequency
    - Derating ..... 429
  - CE
    - Detection Selection ..... 791
    - Detection Time ..... 792
    - Fault ..... 322

Minor Fault.....	347	CSEr .....	366
Operation Selection after Detection.....	790	Cumulative Operation TimeSetting.....	871
Checklist		Current Detection Speed Search .....	639
Test run .....	197	CyPo .....	348
Circulation Fan		<b>D</b>	
Replacement.....	385	Data log.....	179
CoF.....	323	Monitor selection.....	179
Communication option		Sampling time.....	180
Parameter .....	713	Start procedure.....	178
Connecting multiple drives .....	713	Stop procedure.....	178
Control circuit terminals		DC Injection Braking	
Configuration of terminal block.....	107	Parameter .....	635
I/O terminals function selection switches .....	112	De-staging	
Terminal functions .....	103	De-staging Mode .....	938
Wire gauge .....	109	Deceleration time	
Wiring.....	102	Parameter .....	671
Wiring procedure for terminal block.....	110	Delete	
Control method		Delete Backed-up Parameters.....	167
Selection .....	610	Delta to Setpoint Entry	
Cooling Fan		PI Auxiliary Control High Feedback Level.....	948
Activation Conditions Setting .....	835	PI Auxiliary Control Low Feedback Level .....	948
Estimated Lifespan.....	383	Sleep Wake-up level .....	923
Off Delay Timer .....	836	Derating	
Replacement.....	385	Altitude .....	432
Copy Function Error.....	314, 366	Ambient Temperature Setting.....	430, 836
CPEr .....	366	Carrier Frequency .....	429
CPF00.....	323	IP20/UL Open Type.....	837
CPF01.....	323	IP20/UL Type 1 .....	837
CPF02.....	323	IP55/UL Type 12 .....	837
CPF03.....	323	Side-by-side .....	837
CPF06.....	324	dEv	
CPF07.....	324	Fault .....	327
CPF08.....	324	Minor Fault.....	348
CPF11.....	324	dFPS .....	366
CPF12.....	324	Diagnosing and Resetting Faults .....	368
CPF13.....	324	DIFF	
CPF14.....	324	Fault .....	328
CPF16.....	325	Minor Fault.....	348
CPF17.....	325	DIP switch .....	112
CPF18.....	325	Disposal	
CPF19.....	325	Battery .....	417
CPF20.....	325	Drive .....	417–418
CPF21.....	325	microSD card .....	417
CPF22.....	325	Packing material .....	417–418
CPF23.....	325	dnE .....	348
CPF24.....	326	Down command .....	735, 737
CPF26.....	326	Parameter .....	691–692
CPF27.....	326	Drive	
CPF28.....	326	Disposal.....	417–418
CPF29.....	326	Exterior Dimensions Diagram (IP20).....	434–435
CPF30.....	326	Exterior Dimensions Diagram (IP20/UL Type 1) .....	453–455
CPF31.....	326	Exterior Dimensions Diagram (IP55/UL Type 12 with Main Switch) .....	446–450, 459–460
CPF32.....	326	Exterior Dimensions Diagram (IP55/UL Type 12).....	441–445, 456–458
CPF33.....	327	Exterior Dimensions Diagram (IP55/UL Type 12 with Main Switch) .....	458
CPF34.....	327	Exterior Dimensions Diagram (UL Type 1).....	436–440
CPF35.....	327	Initialization .....	611
CPF36.....	327	Initialize Parameters .....	611
CPF37.....	327	Inspection.....	380
CPF38.....	327	Long-Term Storage.....	413
CPF39.....	327	Rating (208 V).....	421
CPyE.....	366		
Crimp ferrule .....	109		
CrST .....	348		

Rating (480 V) .....	422	Er-01 .....	364
Drive Model Selection .....	866	Er-02 .....	364
Drive watt loss .....	427	Er-03 .....	364
dv7 .....	328	Er-04 .....	364
dWA2 .....	348	Er-05 .....	364
dWA3 .....	348	Er-08 .....	365
dWAL .....	348	Er-09 .....	365
dWF1 .....	328	Er-12 .....	365
dWF2 .....	328	Er-13 .....	365
dWF3 .....	328	Er-18 .....	365
dWFL .....	328	Er-19 .....	365
Dynamic Noise Control .....	880	Er-20 .....	365
<b>E</b>		Er-25 .....	365
EF .....	348	Err .....	330
EF0		Error Code List .....	315
Detection conditions .....	719	Exterior Dimensions Diagram (IP20)	
Fault .....	328	Drive .....	434–435
Minor Fault .....	349	Exterior Dimensions Diagram (IP20/UL Type 1)	
Operation Selection after Detection .....	719	Drive .....	453–455
EF1		Exterior Dimensions Diagram (IP55/UL Type 12 with Main Switch)	
Fault .....	328	Drive .....	446–450, 458–460
Minor Fault .....	349	Exterior Dimensions Diagram (IP55/UL Type 12)	
EF2		Drive .....	441–445, 456–458
Fault .....	329	Exterior Dimensions Diagram (UL Type 1)	
Minor Fault .....	349	Drive .....	436–440
EF3		External 24 V power supply	
Fault .....	329	Power supply input terminals .....	105
Minor Fault .....	349	External heatsink installation .....	55
EF4		<b>F</b>	
Fault .....	329	Fan Operation Time Setting .....	871
Minor Fault .....	349	FAn1 .....	330
EF5		Fast Stop Time	
Fault .....	329	Parameter .....	673
Minor Fault .....	349	Fault .....	314, 322
EF6		Fault code	
Fault .....	329	MEMOBUS/Modbus .....	307
Minor Fault .....	349	Fault Code List .....	315
EF7		Fault history	
Fault .....	329	Display procedure .....	171
Minor Fault .....	350	Fault Reset .....	368
Elapsed Operating Time Selection .....	871	Fault Restart	
Electrolytic Capacitor		Parameter .....	820
Estimated Lifespan .....	383	FDBKL	
Emergency Override .....	901	Fault .....	330
Test Mode .....	904	Minor Fault .....	350
Enclosure type		Field weakening	
Change to UL Type 1 .....	54	Parameter .....	692
End1 .....	363	Fine tuning .....	194
End2 .....	363	Firmware update lock .....	623
End3 .....	363	FLGT .....	350
End4 .....	363	Foldback function	
End5 .....	363	Output Current Limit .....	946
End6 .....	363	FR<MS .....	351
End7 .....	363	FR<TH .....	351
End8 .....	363	Freq Ref Setting Method Select .....	867
End9 .....	364	Frequency Agreement	
Energy-saving control		Parameter .....	818
Parameter .....	668	Frequency reference .....	625
Enter command .....	255, 289	Command source correlation diagram .....	684
EOF .....	350	Making changes using keypad .....	149
EOR .....	350	Offset frequency addition .....	692
EP24v .....	350	Upper and lower frequency limits .....	688

Frequency reference hold function		Keypad.....	40
Parameter.....	691–692	Terminal cover.....	46
Fuse rating.....	124	UL Type 1 protective cover.....	54
<b>G</b>		Installation environment.....	32
Gateway mode.....	713	Interlock	
Getting set up.....	143	Circuit example.....	118
GF.....	330	INTLK.....	352
Protection Functions.....	835	IP20/UL Open Type	
Ground		Derating.....	837
Drive.....	84	IP20/UL Type 1	
Ground Fault Circuit Interrupter		Derating.....	837
GFCI.....	119	IP55/UL Type 12	
Wiring.....	119	Derating.....	837
Ground Fault Detection		<b>J</b>	
Protection Functions.....	835	Jog command.....	688
<b>H</b>		Jump frequency	
HAND Command.....	898	Parameter.....	689
HAND indicator.....	135, 137	Jumper switch.....	112
HAND LED.....	137	<b>K</b>	
HCA.....	351	KEB ride-thru function	
Alarm Settings.....	839	Compensation Time.....	807
HFB.....	330	Operation during momentary power loss.....	807
HIAUX		Parameter.....	805
Fault.....	331	KEB Ride-Thru Function	
Minor Fault.....	351	KEB Method Selection.....	810
HIFB.....	351	Single Drive KEB Method.....	810
High-Slip Braking		Keypad	
Parameter.....	841	Application Preset.....	185
HLCE.....	331	Backlight setting.....	181
HOA behavior		Battery Replacement.....	411
Legacy Mode.....	900	Data log setting.....	179
Normal Mode.....	900	Display drive information.....	183
HOA Operation		Display software version.....	183
AUTO Mode.....	895	External dimensions.....	41
HAND Mode.....	895	HOME screen.....	149
Legacy Mode.....	895	Installation.....	40
Normal Mode.....	895	Installation on control panel.....	41
OFF Mode.....	895	Language selection.....	174, 609
HOME screen.....	149	Meaning of indicators.....	135
HOME screen display.....	854	Method of operation.....	135
Full Screen Information Display.....	854	Remove.....	40
MEMOBUS Multiplex.....	933	Set date and time.....	175
Sequence Timer.....	884	Set time.....	175
Status Monitor Display.....	855	Start/stop data logging.....	178
Horsepower.....	865	Keypad Disconnect Detection.....	867
How to read catalog codes.....	25	Keypad Display.....	854
Humidity		Keypad Display Selection.....	858
Environment.....	32	Keypad Operation.....	866
<b>I</b>		Keypad-related settings.....	854
iFEr.....	366	kWh Monitor Initialization.....	872
IGBT Maintenance Setting.....	872	<b>L</b>	
Induction Motor		L24v.....	352
Auto-Tuning.....	187	Language selection.....	609
Input Phase Detection		Procedure.....	174
Protection Functions.....	834	LCD contrast adjustment.....	859
Input voltage		LCP.....	352
Parameter.....	695	Leakage current.....	805
Inspection		LED Light Function Selection.....	868
Drive.....	380	LED status ring	
Installation		ALM/ERR.....	141
Front cover.....	46	Ready.....	141

RUN .....	141	Multiplexing .....	932
LF .....	331	Network activity monitor .....	931
Protective function .....	835	Network communications .....	931
LF2 .....	331	Setup .....	931
Protection Functions .....	837	Staging .....	932, 937
LFB .....	331	System-wide parameters .....	934
Load Inertia Ratio		MEMOBUS/Modbus communications	
Parameter .....	818	Setting for termination resistor .....	115
LOAUX		MEMOBUS/Modbus Communications	
Fault .....	332	Parameter .....	789
Minor Fault .....	352	Serial communication terminals .....	107
LOFB .....	352	Metasys	
LoG .....	352	Communication specifications .....	269
LOP		Self-diagnosis .....	255, 278, 290
Fault .....	332	microSD card	
Minor Fault .....	352	Disposal .....	417
Low City Pressure		Insertion slot .....	135
Alarm text .....	929	Mid point B frequency	
LSP .....	353	Motor 2 parameters .....	705
LT-1 .....	353	Parameter .....	701
LT-2 .....	353	Mid point B voltage	
LT-3 .....	353	Motor 2 parameters .....	705
LT-4 .....	353	Parameter .....	701
LWT .....	353	Middle Output Frequency	
<b>M</b>		Motor 2 Parameters .....	705
Main circuit terminals		Parameter .....	701
Configuration of terminal block .....	68	Middle Output Frequency Voltage	
Line voltage drop .....	75	Motor 2 Parameters .....	705
Wire gauge .....	75	Parameter .....	701
Wiring .....	65	Minimum output frequency	
Wiring procedure for terminal block .....	87	Parameter .....	701
Main menu		Minimum Output Frequency	
Display procedure .....	149	Motor 2 Parameters .....	705
Maintenance Period .....	871	Induction Motor	
Maximum Output Frequency		Motor Parameters .....	702
Motor 2 Parameters .....	704	Minimum Output Voltage	
Parameter .....	700	Motor 2 Parameters .....	705
Maximum Output Voltage		Parameter .....	701
Motor 2 Parameters .....	704	Minor Fault .....	314, 345
Parameter .....	700	Minor fault code	
MCCB .....	119	MEMOBUS/Modbus .....	308
MEMOBUS		Minor Fault Code List .....	315
Broadcast Messages .....	307	Modbus	
Command data .....	291	Broadcast Messages .....	307
Communication error code .....	309	Command data .....	291
Communication specifications .....	279	Communication error code .....	309
Enter command .....	289	Communication specifications .....	279
Fault code .....	307	Enter command .....	289
Loopback test .....	285	Fault code .....	307
Minor fault code .....	308	Loopback test .....	285
Monitor data .....	295	Minor fault code .....	308
Register reading .....	285	Monitor data .....	295
Register writing .....	285	Register reading .....	285
Self-diagnosis .....	255, 278, 290	Register writing .....	285
Wiring .....	279	Self-diagnosis .....	255, 278, 290
MEMOBUS Alternation		Wiring .....	279
Alternation Mode .....	936	Molded-case circuit breaker .....	119
MEMOBUS Multiplex		Momentary Power Loss	
De-staging .....	932, 938	KEB Compensation Time .....	807
HOME screen display .....	933	Monitors	
Lag Drive Mode .....	937	Data log setting .....	179–180
Lead Drive Selection .....	935	Display analog gauge .....	154
		Display bar graph .....	152

Display procedure .....	150	<b>N</b>	
Set custom monitors.....	151	N2	
Show custom monitors.....	152	Communication specifications.....	269
Start/stop data logging.....	178	Nameplate.....	25
Trend Plot Display .....	156	ndAT .....	366
<b>Motor</b>		NETSC .....	353
Change direction of motor rotation .....	149	<b>NMS</b>	
Wiring.....	65	Fault .....	332
Wiring distance .....	84	Minor Fault.....	353
<b>Motor 2</b>		nSE.....	332
Base Frequency .....	705	NumOfRunCommands Counter Initial.....	873
Base voltage.....	706	<b>O</b>	
Control mode settings.....	704	oC .....	332
Leakage Inductance .....	707	Overcurrent Detection Gain.....	837
Line-to-Line Resistance .....	707	<b>OD</b>	
Maximum Output Frequency .....	704	Fault .....	333
Maximum Output Voltage.....	704	Minor Fault.....	354
Mid point B frequency.....	705	oFA00.....	333
Mid point B voltage.....	705	oFA01.....	334
Middle Output Frequency .....	705	oFA05.....	334
Middle Output Frequency Voltage .....	705	oFA06.....	334
Minimum Output Frequency.....	705	oFA10.....	334
Minimum Output Voltage .....	705	oFA11.....	334
Motor Iron Loss.....	707	oFA12.....	334
Motor rated power (kW).....	707	oFA13.....	334
No-load Current .....	706	oFA14.....	334
Number of motor poles .....	707	oFA15.....	335
Rated current.....	706	oFA16.....	335
Rated Slip.....	706	oFA17.....	335
V/f Pattern .....	704	oFA30.....	335
<b>Motor Code Selection .....</b>	<b>708</b>	oFA31.....	335
<b>Motor Overheating</b>		oFA32.....	335
Operation During Detection of Alarms.....	226, 803	oFA33.....	335
Operation During Detection of Faults (PTC Input).....	227, 803	oFA34.....	335
<b>Motor Overload</b>		oFA35.....	336
Electric Thermal Protection Operation Time .....	226, 801	oFA36.....	336
Protection Functions .....	224, 800	oFA37.....	336
<b>Motor parameters</b>		oFA38.....	336
Motor 2 .....	706	oFA39.....	336
Motor 2 No-load Current .....	706	oFA40.....	336
Motor 2 number of motor poles .....	707	oFA41.....	336
Motor 2 rated Current.....	706	oFA42.....	336
Motor 2 rated power (kW) .....	707	oFA43.....	337
<b>Motor Parameters .....</b>	<b>694, 702</b>	OFF key .....	135
Motor 2 Iron Loss .....	707	OFF Key Function Selection .....	866
Motor 2 Leakage Inductance.....	707	Off-Delay Timer.....	647
Motor 2 Line-to-Line Resistance.....	707	Offset frequency	
Motor 2 Rated Slip .....	706	Parameter .....	692
<b>Motor parameters (induction motors) .....</b>	<b>702</b>	<b>oH</b>	
Leakage Inductance .....	703	Alarm Settings .....	833
Line-to-Line Resistance .....	703	Fault .....	337
Motor Iron Loss.....	703	Minor Fault.....	354
Motor rated power (kW).....	703	oH1.....	337
No-load Current .....	702	oH2.....	354
Number of motor poles .....	703	Alarm Settings .....	833
Rated current.....	223, 702	<b>oH3</b>	
Rated Slip.....	702	Fault .....	337
<b>Motor Power Unit Selection .....</b>	<b>865</b>	Minor Fault.....	354
MSL.....	332	Operation During Detection of Alarms.....	226, 803
Multi-step speed operation.....	684	oH4.....	338
Setting procedure.....	685	Operation During Detection of Faults (PTC Input).....	227, 803
Multiplex Mode .....	917	oL1 .....	338

oL2	339
Protection Functions	836
oL3	
Fault	339
Minor Fault	355
oL4	
Fault	339
Minor Fault	355
oL7	340
On-Delay Timer	647
oPE01	358
oPE02	358
oPE03	358
oPE05	360
oPE07	360
oPE08	360
oPE09	361
oPE10	361
oPE11	361
oPE16	361
oPE33	361
oPE34	362
oPE35	362
Operation During Momentary Power Loss	
KEB ride-thru function	805
Operation method selection	807
Parameter	807
Speed Search function	638
oPr	340
Option card	
Parameter	713
Options	461
oS	
Fault	340
Minor Fault	355
Output Phase Loss Detection	
Protective function	835
ov	
Fault	340
Minor Fault	355
ov2	341
ov2 Detection	909
ovEr	355
Overexcitation deceleration	
Parameter	842
Overtorque detection	
Parameter	826
<b>P</b>	
P1	
Communication specifications	259
Parameter	
Access Level Selection	609
Automatic selection	624
Backup (drive to keypad)	163
Changing setting values	161
Checking modified parameters	168–169
Checking user custom parameters	162
Delete Backed-up Parameters	167
Modified Parameters Screen	168
Restore (Auto Backup)	184
Restore (keypad to drive)	164
Restoring default settings	170

User-set	624
Verify (keypad and drive)	166
Parameter Setting Errors	314, 358
PASS	355
Password	
Setting	613
Verification	613
PC	
Connection procedure	117
PE1	341
PE2	341
Peripheral Devices	461
PF	341, 355
Protection Functions	834
Phase Order Selection	634
PI Auxiliary Control	947
Absolute Mode	948
Delta to Setpoint Mode	948
High Feedback Level Detection	948
PI2 control	
control block diagram	891
PI2 Control	890
PID control	649
control block diagram	651
Feedback value input	650
fine tuning	653
Parameter	657
Setpoint input	650
PM motor parameters	
d-Axis inductance	709
Induced voltage constant 1	709
Induced voltage constant 2	710
Motor rated current	223, 708
Motor rated power	708
Number of motor poles	708
q-Axis inductance	709
Stator resistance	709
PM Motor Parameters	708
PM motors	
Motor Code Selection	708
PM Motors	
Auto-Tuning	187
Fine Adjustment	846
Motor Parameters	708
Power loss	427
Pressure Reached Detection	930
Pressure-Reached Detection	
Exit conditions	929
Protection Functions	
DC bus undervoltage	808
Drive Overheating	833
GF	835
Ground Fault Detection	835
Input Phase Detection	834
LF2	837
Motor Overheating (PTC Input)	227, 803
Motor Overload	224, 800
oC	837
oH2	833
oH4	227, 803
oL2	836
Overcurrent	837
Overload	836



PF .....	834	Side-by-side	
Uv1 .....	808	Derating .....	837
Protective function		Simple Positioning Stop .....	692
Drive Overheating .....	833	Sleep Function	
HCA .....	839	Sleep .....	923
LF .....	835	Wake-up .....	923
Motor Overheating .....	226, 803	Sleep Wake-up level	
oH .....	833	Absolute Mode .....	923
oH3 .....	226, 803	Delta to Setpoint Mode .....	923
Output Current Overload .....	839	Slip compensation	
Output Phase Loss Detection .....	835	Parameter .....	674
Software Current Limit Selection .....	836	Softcharge Relay Maintenance Set .....	872
PWEr .....	366	Software Current Limit Selection	
<b>R</b>		Protective function .....	836
Rating (208 V)		Software version	
Drive .....	421	Display procedure .....	183
Rating (480 V)		Speed Agreement	
Drive .....	422	Parameter .....	818
rdEr .....	367	Speed Detection	
Ready		Parameter .....	818
LED status .....	141	Speed Estimation Speed Search .....	640
Remove		Speed Search function	
Front cover .....	46	Operation during momentary power loss .....	807
Keypad .....	40	Parameter .....	638
Terminal cover .....	46	Staging	
RESET key .....	135	Staging Mode .....	937
Restore		Stall Prevention function	
Parameters (Auto Backup) .....	184	Parameter .....	811
Parameters (keypad to drive) .....	164	Stationary Auto-Tuning	
Reverse Operation Selection .....	630	Induction Motor .....	187
RJ-45 connector .....	135	PM Motors .....	187
Rotational Auto-Tuning		Precautions .....	191
Induction Motor .....	187	Stationary Auto-Tuning for Line-to-Line Resistance .....	187
PM Motors .....	187	Precautions .....	191
Precautions .....	191	Stator resistance Auto-Tuning .....	187
rUn .....	356	Precautions .....	191
RUN		STo .....	356
LED status .....	141	SToF .....	356
Run command .....	627	Stop command .....	627
Run Command at Power Up .....	634	Stopping Method Selection .....	627
<b>S</b>		STPo .....	342
S-curve characteristics		Surge protective device	
Parameter .....	674	Connection .....	123
Sampling time setting		<b>T</b>	
Data log .....	180	Temperature	
SC .....	341	Environment .....	32
SCF .....	342	Terminal block .....	107
SE .....	356	Configuration of main circuit terminal block .....	68
Sequence Timer		Control circuit terminal block functions .....	103
HOME screen display .....	884	I/O terminals function selection switches .....	112
Sequence Timers .....	881	Terminal function selection	
SEr .....	342	Terminal A1 .....	112, 114
Serial communication terminals		Terminal A2 .....	112, 114
MEMOBUS/Modbus Communications .....	107	Terminal AM .....	112, 115
Set date and time		Terminal FM .....	112, 115
Operation .....	175	Terminal screw	
Set time		Screwdriver .....	76
Operation .....	175	Termination resistor	
Setpoint selection		Setting switch .....	115
System Feedback Monitor .....	945	Test run	
Short Circuit Braking		Checklist .....	197
Parameter .....	635	Fine tuning .....	194

Procedure .....	143
Procedure for no-load test run .....	192
Procedure for test run with actual load .....	193
Thermal overload relay	
Connection .....	120
Thrust Mode	
Thrust frequency.....	927
Tightening torque	
Control circuit terminals.....	109
Main circuit terminals.....	75
TiM	
Fault .....	342
Minor Fault.....	356
Timer function	
Parameter .....	647
Torque Compensation	
Parameter .....	676
Torque limit function	
Parameter .....	831
Trend Plot	
Monitors .....	156
Troubleshooting	
Code Displayed .....	315
No Code Displayed.....	370
Troubleshooting without Fault Display .....	370
TrPC.....	356
Tuning .....	671
<b>U</b>	
U2, U3 Initialization .....	872
UL Type 1	
Attach protective cover .....	54
UL3	
Fault .....	342
Minor Fault.....	357
UL4	
Fault .....	343
Minor Fault.....	357
UL6	
Fault .....	343
Minor Fault.....	357
Undertorque detection	
Parameter .....	826
Unit selector .....	865
Up command.....	735, 737
Parameter .....	691–692
USB port .....	135
Connecting a PC.....	117
User Parameter Default Value .....	866
User-Set Display Units Max Value .....	859
User-SetDisplayUnits Dec Display .....	860
Utility Start Delay.....	927
Uv .....	357
Uv1.....	343
Detection level settings .....	808
Uv2.....	343
Uv3.....	343
<b>V</b>	
vAEr .....	367
V/f Pattern.....	694
Second Motor .....	704
Verify	
Parameters (keypad and drive) .....	166

vFyE .....	367
Vibration-resistant.....	32
VLTS.....	344
Voltage Saturation.....	853
<b>W</b>	
WEEE.....	418
Wire gauge	
Main circuit terminals.....	75
Voltage drop.....	75
Wire gauges	
Control circuit terminals.....	109
Wiring.....	119
AC reactor .....	122
Checklist.....	126
Control circuit terminal block .....	110
Control circuit terminals.....	102
Main circuit terminal block .....	87
Main circuit terminals.....	65
MEMOBUS/Modbus .....	279
Motor.....	65
Thermal overload relay .....	120
Wiring distance	
Drive and motor .....	84

## Revision History

Date of Publication	Revision Number	Section	Revised Content
September 2022	4	All	Revision: Reviewed and corrected entire documentation. Upgraded drive software version to PRG: 01016.
		5	Addition: Seismic Standards.
		-	Format revision: Changed the design of front cover and back cover.
June 2021	3	All	Revision: Reviewed and corrected entire documentation. Upgraded drive software version to PRG: 01014.
		8, 10, 11, 12	Revision: Modified documentation because of design changes for model 4008 (IP55/UL Type 12).
March 2021	2	All	Revision: Reviewed and corrected entire documentation. Upgraded drive software version to PRG: 01013. Addition: IP55/UL Type 12 drives with Main Switch added along with corresponding data.
March 2020	1	All	Revision: Reviewed and corrected entire documentation. Upgraded drive software version to PRG: 01012.
December 2019	-	-	First Edition

# YASKAWA

## HV600 DRIVE TECHNICAL REFERENCE

### YASKAWA AMERICA, INC.

2121, Norman Drive South, Waukegan, IL  
60085, U.S.A.  
+1-800-YASKAWA (927-5292)  
[www.yaskawa.com](http://www.yaskawa.com)

### DRIVE CENTER (INVERTER PLANT)

2-13-1, Nishimiyaichi, Yukuhashi, Fukuoka,  
824-8511, Japan  
Phone: +81-930-25-2548  
[www.yaskawa.co.jp](http://www.yaskawa.co.jp)

### YASKAWA EUROPE GmbH

Hauptstraße 185, 65760 Eschborn, Germany  
Phone: +49-6196-569-300  
E-mail: [support@yaskawa.eu.com](mailto:support@yaskawa.eu.com)  
[www.yaskawa.eu.com](http://www.yaskawa.eu.com)

### YASKAWA ELÉTRICO DO BRASIL LTDA.

777, Avenida Piraporinha, Diadema, São  
Paulo, 09950-000, Brasil  
Phone: +55-11-3585-1100  
[www.yaskawa.com.br](http://www.yaskawa.com.br)

In the event that the end user of this product is to be the military and said product is to be employed in any weapons systems or the manufacture thereof, the export will fall under the relevant regulations as stipulated in the Foreign Exchange and Foreign Trade Regulations. Therefore, be sure to follow all procedures and submit all relevant documentation according to any and all rules, regulations and laws that may apply.

Specifications are subject to change without notice for ongoing product modifications and improvements.

Original instructions.

© 2019 YASKAWA Electric Corporation

YASKAWA ELECTRIC CORPORATION

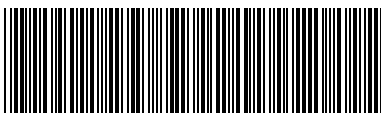

\*SIEPC71061732\*

SIEPC71061732  
Revision: E <4>-0  
September 2022  
Published in Japan  
22-3-23\_YAI