

## AC Servo Drives

# $\Sigma$ -V Series

## USER'S MANUAL

### Operation of Digital Operator

Model: JUSP-OP05A-1-E

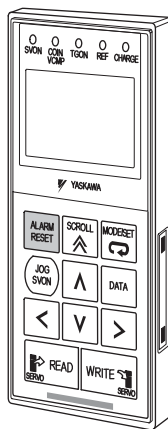

Introduction 1

Parameter/Monitor Modes 2

Utility Function Mode 3

Parameter Copy Mode 4

Copyright © 2007 YASKAWA ELECTRIC CORPORATION

---

All rights reserved. No part of this publication may be reproduced, stored in a retrieval system, or transmitted, in any form, or by any means, mechanical, electronic, photocopying, recording, or otherwise, without the prior written permission of Yaskawa. No patent liability is assumed with respect to the use of the information contained herein. Moreover, because Yaskawa is constantly striving to improve its high-quality products, the information contained in this manual is subject to change without notice. Every precaution has been taken in the preparation of this manual. Nevertheless, Yaskawa assumes no responsibility for errors or omissions. Neither is any liability assumed for damages resulting from the use of the information contained in this publication.

---

# About this Manual

This manual provides the users of the  $\Sigma$ -V series of SGM□S/SGDV servodrives with an explanation of the digital operator (Model: JUSP-OP05A-1-E) and its features, including the following items:

- Functions and connection method
- Parameters and monitor mode
- Utility function mode
- Parameter copy mode

## ■ Intended Audience

This manual is intended for the following users.

- Those performing trial operation or adjustments of  $\Sigma$ -V Series servodrives.
- Those maintaining or inspecting  $\Sigma$ -V Series servodrives.

## ■ Description of Technical Terms

The following table shows the meanings of terms used in this manual.

Term	Meaning
Cursor	Input position indicated by digital operator
Servomotor	$\Sigma$ -V Series SGMJV, SGMAV, SGMPS, SGMGV, SGMVS, or SGMCS (Direct Drive) servomotor
SERVOPACK	$\Sigma$ -V Series SGDVS SERVOPACK
Servo Drive	A set including a servomotor and SERVOPACK (i.e., a servo amplifier)
Servo System	A servo control system that includes the combination of a servo drive with a host controller and peripheral devices
Servo ON	Power to motor ON
Servo OFF	Power to motor OFF

## ■ Specific technical terms

Different technical terms are used for rotational servomotors and linear servomotors, and the terms for rotational servomotors are used in this manual.

Rotational Servomotors	Linear Servomotors
torque	force
rotation	movement
moment of inertia	mass
motor speed [ $\text{min}^{-1}$ ]	moving speed [ $\text{mm/s}$ ]

## ■ Indication of Reverse Signals

In this manual, the names of reverse signals (ones that are valid when low) are written with a forward slash (/) before the signal name, as shown in the following example:

- $\overline{S-ON} = /S-ON$
- $\overline{P-CON} = /P-CON$

## ■ Related Manuals

Refer to the following manuals as required.

Manuals	SERVOPACKs, Servomotors, and Peripheral Devices	Ratings and Characteristics	System Design	Panel Configuration and Wiring	Trial operation	Trial Operation and Servo Adjustment	Inspection and Maintenance
$\Sigma$ -V series Catalog (KAEP S800000 42)	✓	✓	✓				
$\Sigma$ -V series User's Manual Setup Rotational Motor (SIEP S800000 43)				✓	✓		
$\Sigma$ -V series User's Manual Setup Linear Motor (SIEP S800000 44)				✓	✓		
$\Sigma$ -V series User's Manual Design and Maintenance Rotational Motor/ Analog and Pulse (SIEP S800000 45)			✓		✓	✓	✓
$\Sigma$ -V series User's Manual Design and Maintenance Rotational Motor/ MECHATROLINK-II Communications Reference (SIEP S800000 46)			✓		✓	✓	✓
$\Sigma$ -V series User's Manual Design and Maintenance Linear Motor/ Analog and Pulse (SIEP S800000 47)			✓		✓	✓	✓

Manuals	SERVOPACKs, Servomotors, and Peripheral Devices	Ratings and Characteristics	System Design	Panel Configuration and Wiring	Trial operation	Trial Operation and Servo Adjustment	Inspection and Maintenance
Σ-V series User's Manual Design and Maintenance Linear Motor/ MECHATROLINK-II Communications Reference (SIEP S800000 48)			✓		✓	✓	✓
Σ series Digital Operator Safety Precautions (TOBP C730800 00)							✓
Σ-V series User's Manual MECHATROLINK-II Command (SIEP S800000 54)			✓		✓	✓	
Σ-Vseries AC SERVOPACK SGDV Safety Precautions (TOBP C710800 10)	✓			✓			✓
AC SERVMOTOR Safety Precautions (TOBP C230200 00)				✓			✓

---

# Safety Information

The following conventions are used to indicate precautions in this manual. Failure to heed precautions provided in this manual can result in serious or possibly even fatal injury or damage to the products or to related equipment and systems.



Indicates precautions that, if not heeded, could possibly result in loss of life or serious injury.



Indicates precautions that, if not heeded, could result in relatively serious or minor injury, damage to the product, or faulty operation.

In some situations, the precautions indicated could have serious consequences if not heeded.

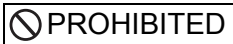

Indicates prohibited actions that must not be performed. For example, this symbol would be used to

indicate that fire is prohibited as follows: .



Indicates compulsory actions that must be performed. For example, this symbol would be used as follows to

indicate that grounding is compulsory: .

---

# Notes for Safe Operation



Read this manual thoroughly before checking products on delivery, storage and transportation, installation, wiring, operation and inspection, and disposal of the AC servodrives.

## WARNING

- Never touch any rotating servomotor parts while the servomotor is running. Failure to observe this warning may result in injury.
- Before starting operation with a machine connected, make sure that an emergency stop can be applied at any time. Failure to observe this warning may result in injury or damage to the equipment.
- Never touch the inside of the SERVOPACKs. Failure to observe this warning may result in electric shock.
- Do not remove the cover of the power supply terminal block while the power is ON. Failure to observe this warning may result in electric shock.
- After the power is turned OFF or after a voltage resistance test, do not touch terminals while the CHARGE lamp is ON. Residual voltage may cause electric shock.
- Follow the procedures and instructions provided in the manuals for the products being used in the trial operation. Failure to do so may result not only in faulty operation and damage to equipment, but also in personal injury.
- The output range of the rotational serial data for the  $\Sigma$ -V absolute position detecting system is different from that of earlier systems for 12-bit and 15-bit encoders. As a result, the infinite-length positioning system of the  $\Sigma$  Series must be changed for use with products in the  $\Sigma$ -V Series.
- The multiturn limit value need not be changed except for special applications. Changing it inappropriately or unintentionally can be dangerous.
- If the Multiturn Limit Disagreement alarm occurs, check the setting of parameter Pn205 in the SERVOPACK to be sure that it is correct. If Fn013 is executed when an incorrect value is set in Pn205, an incorrect value will be set in the encoder. The alarm will disappear even if an incorrect value is set, but incorrect positions will be detected, resulting in a dangerous situation where the machine will move to unexpected positions.
- Do not remove the top front cover, cables, connectors, or optional items from the SERVOPACK while the power is ON. Failure to observe this warning may result in electric shock.
- Do not damage, pull, exert excessive force on, or place heavy objects on the cables. Failure to observe this warning may result in electric shock, stopping operation of the product, or fire.
- Do not modify the product. Failure to observe this warning may result in injury, damage to the equipment, or fire.

---

## WARNING

- Provide appropriate braking devices on the machine side to ensure safety. The holding brake on a servomotor with a brake is not a braking device for ensuring safety.  
Failure to observe this warning may result in injury.
- Do not come close to the machine immediately after resetting an instantaneous power interruption to avoid an unexpected restart. Take appropriate measures to ensure safety against an unexpected restart.  
Failure to observe this warning may result in injury.
-  Connect the ground terminal according to local electrical codes (100  $\Omega$  or less for a SERVOPACK with a 100 V, 200 V power supply, 10  $\Omega$  or less for a SERVOPACK with a 400 V power supply).  
Improper grounding may result in electric shock or fire.
-  Installation, disassembly, or repair must be performed only by authorized personnel.  
Failure to observe this warning may result in electric shock or injury.
- The person who designs a system using the safety function (Hard Wire Baseblock function) must have full knowledge of the related safety standards and full understanding of the instructions in this manual.  
Failure to observe this warning may result in injury or damage to the equipment.



## ■ Storage and Transportation

### CAUTION

- **Do not store or install the product in the following places.**  
Failure to observe this caution may result in fire, electric shock, or damage to the equipment.
  - Locations subject to direct sunlight
  - Locations subject to temperatures outside the range specified in the storage or installation temperature conditions
  - Locations subject to humidity outside the range specified in the storage or installation humidity conditions
  - Locations subject to condensation as the result of extreme changes in temperature
  - Locations subject to corrosive or flammable gases
  - Locations subject to dust, salts, or iron dust
  - Locations subject to exposure to water, oil, or chemicals
  - Locations subject to shock or vibration
- **Do not hold the product by the cables or motor shaft, or encoder while transporting it.**  
Failure to observe this caution may result in injury or malfunction.
- **Do not place any load exceeding the limit specified on the packing box.**  
Failure to observe this caution may result in injury or malfunction.
- **If disinfectants or insecticides must be used to treat packing materials such as wooden frames, pallets, or plywood, the packing materials must be treated before the product is packaged, and methods other than fumigation must be used.**  
Example: Heat treatment, where materials are kiln-dried to a core temperature of 56°C for 30 minutes or more.  
If the electronic products, which include stand-alone products and products installed in machines, are packed with fumigated wooden materials, the electrical components may be greatly damaged by the gases or fumes resulting from the fumigation process. In particular, disinfectants containing halogen, which includes chlorine, fluorine, bromine, or iodine can contribute to the erosion of the capacitors.

## ■ Installation

### CAUTION

- **Never use the product in an environment subject to water, corrosive gases, inflammable gases, or combustibles.**  
Failure to observe this caution may result in electric shock or fire.
- **Do not step on or place a heavy object on the product.**  
Failure to observe this caution may result in injury.
- **Do not cover the inlet or outlet ports and prevent any foreign objects from entering the product.**  
Failure to observe this caution may cause internal elements to deteriorate resulting in malfunction or fire.
- **Be sure to install the product in the correct direction.**  
Failure to observe this caution may result in malfunction.
- **Provide the specified clearances between the SERVOPACK and the control panel or with other devices.**  
Failure to observe this caution may result in fire or malfunction.
- **Do not apply any strong impact.**  
Failure to observe this caution may result in malfunction.

## ■ Wiring

### CAUTION

- Be sure to wire correctly and securely.  
Failure to observe this caution may result in motor overrun, injury, or malfunction.
- Do not connect a commercial power supply to the U, V, or W terminals for the servomotor connection.  
Failure to observe this caution may result in injury or fire.
- Securely connect the main circuit terminals.  
Failure to observe this caution may result in fire.
- Do not bundle or run the main circuit cables together with the I/O signal cables or the encoder cables in the same duct. Keep the main circuit cables separated from the I/O signal cables and encoder cables by at least 30 cm.  
Placing these cables too close to each other may result in malfunction.
- Use shielded twisted-pair cables or screened unshielded twisted-pair cables for I/O signal cables and the encoder cables.
- The maximum wiring length is 3 m for I/O signal cables, 50 m for encoder cables or servomotor main circuit cables, and 10 m for control power supply cables for the SERVOPACK with a 400-V power supply (+24 V, 0 V).
- Do not touch the power supply terminals while the CHARGE lamp is ON after turning power OFF because high voltage may still remain in the SERVOPACK. Make sure the charge indicator is OFF first before starting to do wiring or inspections.
- Be sure to observe the following precautions when wiring the SERVOPACK main circuit terminal blocks.
  - Do not turn the SERVOPACK power ON until all wiring, including the main circuit terminal blocks, has been completed.
  - Remove detachable main circuit terminals from the SERVOPACK prior to wiring.
  - Insert only one power line per opening in the main circuit terminals.
  - Make sure that no part of the core wire comes into contact with (i.e., short-circuits) adjacent wires.
- Install a battery at either the host controller or the SERVOPACK, but not both.  
It is dangerous to install batteries at both ends simultaneously, because that sets up a loop circuit between the batteries.
- Always use the specified power supply voltage.  
An incorrect voltage may result in fire or malfunction.
- Make sure that the polarity is correct.  
Incorrect polarity may cause ruptures or damage.
- Take appropriate measures to ensure that the input power supply is supplied within the specified voltage fluctuation range. Be particularly careful in places where the power supply is unstable.  
An incorrect power supply may result in damage to the equipment.
- Install external breakers or other safety devices against short-circuiting in external wiring.  
Failure to observe this caution may result in fire.
- Take appropriate and sufficient countermeasures for each form of potential interference when installing systems in the following locations.
  - Locations subject to static electricity or other forms of noise
  - Locations subject to strong electromagnetic fields and magnetic fields
  - Locations subject to possible exposure to radioactivity
  - Locations close to power suppliesFailure to observe this caution may result in damage to the equipment.

---

 CAUTION

- Do not reverse the polarity of the battery when connecting it. Failure to observe this caution may damage the battery, the SERVOPACK or servomotor, or cause an explosion.
- Wiring or inspection must be performed by a technical expert.
- Use a 24-VDC power supply with double insulation or reinforced insulation.

## ■ Operation

### CAUTION

- Always use the servomotor and SERVOPACK in one of the specified combinations. Failure to observe this caution may result in fire or malfunction.
- Conduct trial operation on the servomotor alone with the motor shaft disconnected from the machine to avoid accidents.  
Failure to observe this caution may result in injury.
- During trial operation, confirm that the holding brake works correctly. Furthermore, secure system safety against problems such as signal line disconnection.
- Before starting operation with a machine connected, change the parameter settings to match the parameters of the machine.  
Starting operation without matching the proper settings may cause the machine to run out of control or malfunction.
- Do not turn the power ON and OFF more than necessary.  
Do not use the SERVOPACK for applications that require the power to turn ON and OFF frequently. Such applications will cause elements in the SERVOPACK to deteriorate.  
As a guideline, at least one hour should be allowed between the power being turned ON and OFF once actual operation has been started.
- When carrying out JOG operation (Fn002), origin search (Fn003), or EasyFFT (Fn206), forcing movable machine parts to stop does not work for forward overtravel or reverse overtravel. Take necessary precautions.  
Failure to observe this caution may result in damage to the equipment.
- When using the servomotor for a vertical axis, install safety devices to prevent workpieces from falling due to alarms or overtravels. Set the servomotor so that it will stop in the zero clamp state when overtravel occurs.  
Failure to observe this caution may cause workpieces to fall due to overtravel.
- When not using the turning-less function, set the correct moment of inertia ratio (Pn103).  
Setting an incorrect moment of inertia ratio may cause machine vibration.
- Do not touch the SERVOPACK heat sinks, regenerative resistor, or servomotor while power is ON or soon after the power is turned OFF.  
Failure to observe this caution may result in burns due to high temperatures.
- Do not make any extreme adjustments or setting changes of parameters.  
Failure to observe this caution may result in injury or damage to the equipment due to unstable operation.
- When an alarm occurs, remove the cause, reset the alarm after confirming safety, and then resume operation.  
Failure to observe this caution may result in damage to the equipment, fire, or injury.
- Do not use the holding brake of the servomotor for braking.  
Failure to observe this caution may result in malfunction.
- An alarm or warning may occur if communications are performed with the host controller while the SigmaWin+ or digital operator is operating.  
If an alarm or warning occurs, it may stop the current process and stop the system.

---

## ■ Maintenance and Inspection

### CAUTION

- Do not disassemble the SERVOPACK.  
Failure to observe this caution may result in electric shock or injury.
- Do not attempt to change wiring while the power is ON.  
Failure to observe this caution may result in electric shock or injury.
- When replacing the SERVOPACK, resume operation only after copying the previous SERVOPACK parameters to the new SERVOPACK.  
Failure to observe this caution may result in damage to the equipment.

## ■ Disposal Precautions

### CAUTION

- Correctly discard the product as stipulated by regional, local, and municipal laws and regulations. Be sure to include these contents in all labelling and warning notifications on the final product as necessary.



## ■ General Precautions

### Observe the following general precautions to ensure safe application.

- The products shown in illustrations in this manual are sometimes shown without covers or protective guards. Always replace the cover or protective guard as specified first, and then operate the products in accordance with the manual.
- The drawings presented in this manual are typical examples and may not match the product you received.
- If the manual must be ordered due to loss or damage, inform your nearest Yaskawa representative or one of the offices listed on the back of this manual.

---

# Warranty

## (1) Details of Warranty

### ■ Warranty Period

The warranty period for a product that was purchased (hereinafter called “delivered product”) is one year from the time of delivery to the location specified by the customer or 18 months from the time of shipment from the Yaskawa factory, whichever is sooner.

### ■ Warranty Scope

Yaskawa shall replace or repair a defective product free of charge if a defect attributable to Yaskawa occurs during the warranty period above. This warranty does not cover defects caused by the delivered product reaching the end of its service life and replacement of parts that require replacement or that have a limited service life.

This warranty does not cover failures that result from any of the following causes.

1. Improper handling, abuse, or use in unsuitable conditions or in environments not described in product catalogs or manuals, or in any separately agreed-upon specifications
2. Causes not attributable to the delivered product itself
3. Modifications or repairs not performed by Yaskawa
4. Abuse of the delivered product in a manner in which it was not originally intended
5. Causes that were not foreseeable with the scientific and technological understanding at the time of shipment from Yaskawa
6. Events for which Yaskawa is not responsible, such as natural or human-made disasters

## (2) Limitations of Liability

1. Yaskawa shall in no event be responsible for any damage or loss of opportunity to the customer that arises due to failure of the delivered product.
2. Yaskawa shall not be responsible for any programs (including parameter settings) or the results of program execution of the programs provided by the user or by a third party for use with programmable Yaskawa products.
3. The information described in product catalogs or manuals is provided for the purpose of the customer purchasing the appropriate product for the intended application. The use thereof does not guarantee that there are no infringements of intellectual property rights or other proprietary rights of Yaskawa or third parties, nor does it construe a license.
4. Yaskawa shall not be responsible for any damage arising from infringements of intellectual property rights or other proprietary rights of third parties as a result of using the information described in catalogs or manuals.

---

### (3) Suitability for Use

1. It is the customer's responsibility to confirm conformity with any standards, codes, or regulations that apply if the Yaskawa product is used in combination with any other products.
2. The customer must confirm that the Yaskawa product is suitable for the systems, machines, and equipment used by the customer.
3. Consult with Yaskawa to determine whether use in the following applications is acceptable. If use in the application is acceptable, use the product with extra allowance in ratings and specifications, and provide safety measures to minimize hazards in the event of failure.
  - Outdoor use, use involving potential chemical contamination or electrical interference, or use in conditions or environments not described in product catalogs or manuals
  - Nuclear energy control systems, combustion systems, railroad systems, aviation systems, vehicle systems, medical equipment, amusement machines, and installations subject to separate industry or government regulations
  - Systems, machines, and equipment that may present a risk to life or property
  - Systems that require a high degree of reliability, such as systems that supply gas, water, or electricity, or systems that operate continuously 24 hours a day
  - Other systems that require a similar high degree of safety
4. Never use the product for an application involving serious risk to life or property without first ensuring that the system is designed to secure the required level of safety with risk warnings and redundancy, and that the Yaskawa product is properly rated and installed.
5. The circuit examples and other application examples described in product catalogs and manuals are for reference. Check the functionality and safety of the actual devices and equipment to be used before using the product.
6. Read and understand all use prohibitions and precautions, and operate the Yaskawa product correctly to prevent accidental harm to third parties.

### (4) Specifications Change

The names, specifications, appearance, and accessories of products in product catalogs and manuals may be changed at any time based on improvements and other reasons. The next editions of the revised catalogs or manuals will be published with updated code numbers. Consult with your Yaskawa representative to confirm the actual specifications before purchasing a product.

---

# CONTENTS

About this Manual	iii
Safety Information	vi
Notes for Safe Operation	vii
Warranty	xiv
<b>1 Introduction</b>	<b>1-1</b>
1.1 Part Names and Functions	1-3
1.2 Switching Mode	1-5
<b>2 Parameter/Monitor Modes</b>	<b>2-1</b>
2.1 Parameter Mode	2-2
2.1.1 Parameter Setting	2-2
2.1.2 Parameter Classification	2-6
2.2 Monitor Mode	2-7
2.2.1 Monitor Items	2-7
2.2.2 Monitor Mode Display	2-10
<b>3 Utility Function Mode</b>	<b>3-1</b>
3.1 Outline	3-3
3.2 Operations	3-6
3.2.1 Alarm History Display (Fn000)	3-6
3.2.2 JOG Operation (Fn002)	3-8
3.2.3 Origin Search (Fn003)	3-11
3.2.4 Program JOG Operation (Fn004)	3-14
3.2.5 Initializing Parameter Settings (Fn005)	3-17
3.2.6 Clearing Alarm History (Fn006)	3-19
3.2.7 Absolute Encoder Multiturn Reset and Encoder Alarm Reset (Fn008)	3-20
3.2.8 Automatic Tuning of Analog (Speed, Torque) Reference Offset (Fn009)	3-22
3.2.9 Manual Servo-tuning of Speed Reference Offset (Fn00A)	3-24
3.2.10 Manual Servo-tuning of Torque Reference Offset (Fn00B)	3-26
3.2.11 Offset Adjustment of Analog Monitor Output (Fn00C)	3-28
3.2.12 Gain Adjustment of Analog Monitor Output (Fn00D)	3-30
3.2.13 Automatic Offset-Signal Adjustment of the Motor Current Detection Signal (Fn00E)	3-32
3.2.14 Manual Offset-Signal Adjustment of the Motor Current Detection Signal (Fn00F)	3-34
3.2.15 Write Prohibited Setting (Fn010)	3-36
3.2.16 Servomotor Model Display (Fn011)	3-39
3.2.17 Software Version Display (Fn012)	3-41
3.2.18 Multiturn Limit Value Setting Change When a Multiturn Limit Disagreement Alarm Occurs (Fn013)	3-42
3.2.19 Resetting Configuration Errors in Option Modules (Fn014)	3-44
3.2.20 Vibration Detection Level Initialization (Fn01B)	3-46
3.2.21 Display of SERVOPACK and Servomotor ID (Fn01E)	3-49
3.2.22 Display of Servomotor ID in Feedback Option Module (Fn01F)	3-51



3.2.23	Origin Setting (Fn020)	3-53
3.2.24	Software Reset (Fn030)	3-54
3.2.25	Polarity Detection (Fn080)	3-56
3.2.26	Tuning-less Levels Setting (Fn200)	3-58
3.2.27	Advanced Autotuning (Fn201)	3-60
3.2.28	Advanced Autotuning by Reference (Fn202)	3-67
3.2.29	One-parameter Tuning (Fn203)	3-71
3.2.30	Anti-Resonance Control Adjustment Function (Fn204)	3-79
3.2.31	Vibration Suppression Function (Fn205)	3-87
3.2.32	EasyFFT (Fn206)	3-91
3.2.33	Online Vibration Monitor (Fn207)	3-95

## 4 Parameter Copy Mode 4-1

4.1	Outline	4-2
4.2	Operations	4-3
4.2.1	Read-out Parameters from SERVOPACK (SERVO → OP)	4-3
4.2.2	Write-in Parameters (OP → SERVO)	4-6
4.2.3	Verify Parameters (VERIFY)	4-9
4.2.4	Parameter Block List Display (LIST)	4-12

## Revision History

# 1

---

## Introduction

1.1 Part Names and Functions .....	1-3
1.2 Switching Mode .....	1-5

The JUSP-OP05A-1-E optional digital operator for the  $\Sigma$ -V Series SGD V SERVOPACK is used to set and display the SERVOPACK parameters. Connect the digital operator to the CN3 connector of the SERVOPACK.

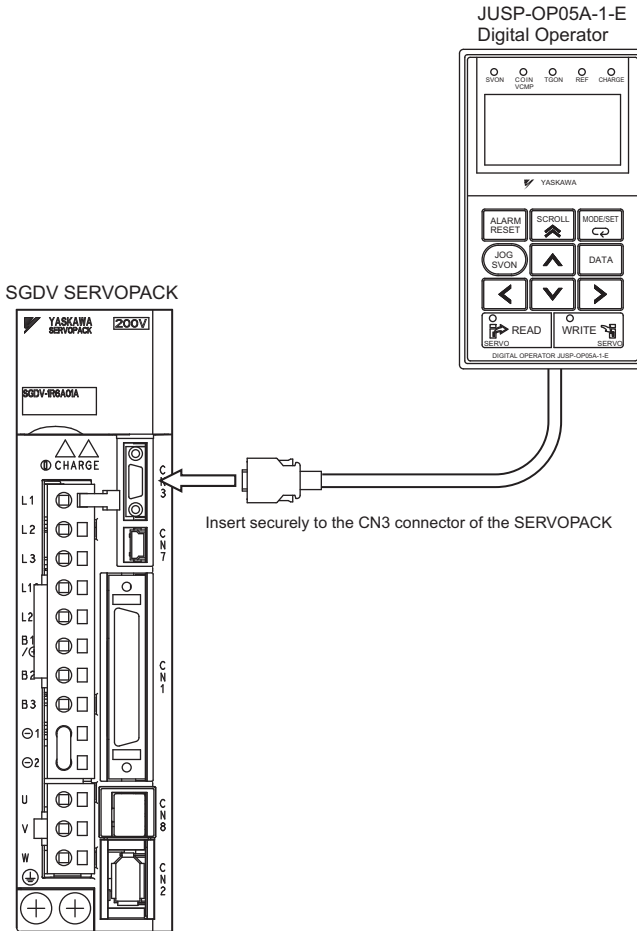

Note: JUSP-OP05A digital operators are used with  $\Sigma$ -III SERVOPACKS. A special connector (JZSP-CVS05-A3-E) is required to use these operators with  $\Sigma$ -V SERVOPACKS. For details, refer to  *$\Sigma$ -V Series User's Manual, Setup, Rotational Motor* (Manual No.: S1EP S800000 43).

## 1.1 Part Names and Functions

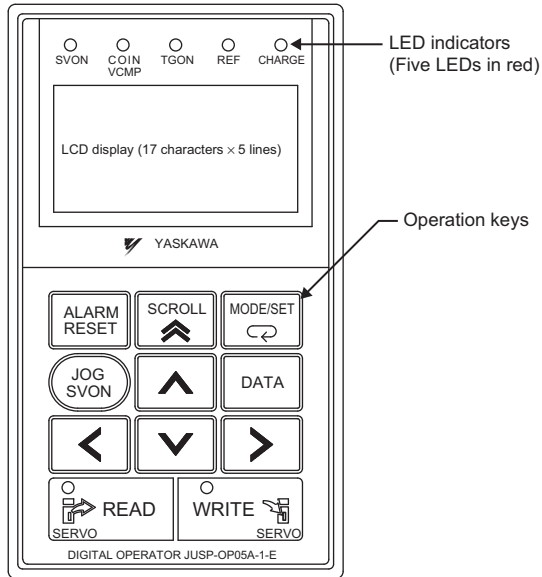









### (1) LED Display

The digital operator has an LCD display with a maximum of 17 characters for each of the 5 lines. It also has 5 LED indicators to show the status of the servo ON, positioning completion, and others. Details of the LED indicators are as follows.

Name	Function
SVON	Lit when the servo is ON. Unlit when the servo is OFF.
COIN VCMP	Lit when positioning is completed. Lit when the speed is coincident.
TGON	Lit while the servomotor is running.
REF	Position control: Lit when the reference pulse is input. Speed control: Lit when the speed reference input is greater than the setting value of Pn502. Torque control: Lit when the torque reference input exceeds 10 % of the rated torque.
CHARGE	Lit when the main circuit power supply is ON.

## (2) Operation Keys

Operation Key	Main Function
	Resets the alarm. (The alarm cannot be reset unless the cause of the alarm is removed.)
	Switches the display mode of digital operator.
	<ul style="list-style-type: none"> <li>• Switches the cursor position between the parameter number and the setting when setting a parameter.</li> <li>• Saves the parameter setting in the SERVOPACK.</li> <li>• Opens the selected utility function display in the utility function mode.</li> </ul>
	<ul style="list-style-type: none"> <li>• Moves the cursor up or down in parameter/monitor mode.</li> <li>• Moves the cursor four lines up in the utility function mode.</li> </ul>
	Switches between the servo ON and servo OFF signals while executing a utility function, such as a JOG operation or advanced autotuning.
	Moves the cursor to left or right in parameter/monitor mode.
	<ul style="list-style-type: none"> <li>• Switches between parameters (Pn) and monitors (Un).</li> <li>• Increases or decreases the parameter number, setting data, monitor number, and utility function number.</li> <li>• Rotates the servomotor in a forward or reverse direction at a JOG operation.</li> </ul>
	In the parameter copy mode, reads parameters saved in the SERVOPACK to the digital operator.
	<ul style="list-style-type: none"> <li>• In the parameter copy mode, writes parameters in the digital operator to the SERVOPACK.</li> <li>• In the parameter/monitor mode, saves the status of the display to the digital operator. When the power is turned ON, that saved display will appear first.</li> </ul>

## 1.2 Switching Mode

Connect the digital operator to the SERVOPACK, and turn ON the power to the SERVOPACK. The initial display appears, and then the parameter/monitor mode display appears. Press the  Key to change the mode.

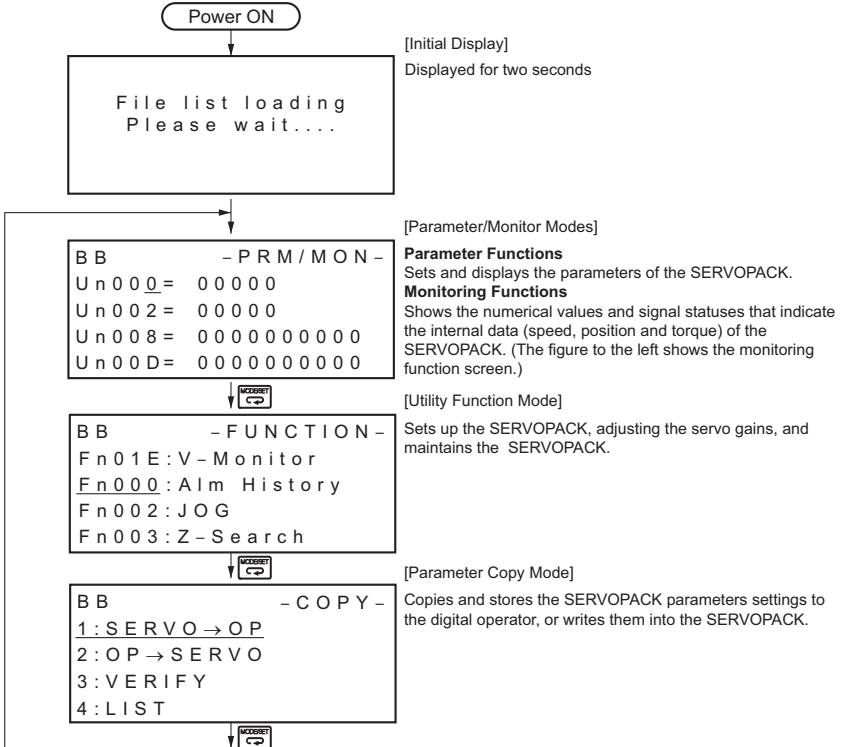

An abbreviation of the name of the active mode is displayed in the upper right, and the SERVOPACK status is displayed in the upper left.

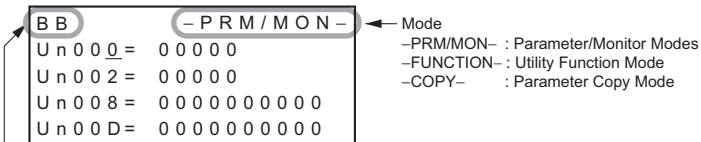

- Status
- BB: Base blocked
  - RUN: Servomotor is ON
  - A.□□□: An alarm occurs (□□□: Alarm code)
  - PT NT: Forward run and reverse run prohibited (Overtravel)
  - P-OT: Forward run prohibited (Overtravel)
  - N-OT: Reverse run prohibited (Overtravel)
  - NO-OP: Setting disabled or setting error
  - HBB: During hard wire base block

<NOTE> Other Alarm Displays

If a communications error occurs between the SERVOPACK and digital operator, the following communications error codes are displayed. These errors may be caused by incorrect connector connection. Check the connection and correct it. Then, turn the power OFF and ON. If the communications error message still appears, replace the digital operator or the SERVOPACK.

CPF00  
COM-ERR(OP&SV)

CPF01  
COM-ERR(OP&SV)

---

## Parameter/Monitor Modes

2.1	Parameter Mode	2-2
2.1.1	Parameter Setting	2-2
2.1.2	Parameter Classification	2-6
2.2	Monitor Mode	2-7
2.2.1	Monitor Items	2-7
2.2.2	Monitor Mode Display	2-10



## 2.1 Parameter Mode

This section describes how to display and set parameters in the parameter/monitor mode.

There are two types of notation used for parameters, one for parameter that requires a value setting (parameter for numeric settings) and one for parameter that requires the selection of a function (parameter for selecting functions).











- Note: 1. The details of parameters are not described in this manual. For more information on parameters, refer to manuals listed in **■ Related Manuals** on page iv.
2. To indicate a specific digit of the parameters whose each digit has a meaning and has to be set, the digit number is added to the parameter number. For example, Pn000.0 (the 1st digit of parameter Pn000).







### 2.1.1 Parameter Setting

#### (1) Operation Example 1: Setting the Parameters for Selecting Functions

There are some parameters which require the setting of each digit such as Pn000 (function selection basic switch) and Pn001 (function selection application switch 1).

This example shows the operation procedure to set “1” (reverse rotation) for Pn000.0 (motor direction selection).

Step	Display after Operation	Keys	Operation
1	<pre> BB          - P R M / M O N - Un000 = 00000 Un002 = 00000 Un008 = 0000000000 Un00D = 0000000000           </pre>		Press the  Key to select the parameter/monitor mode.
2	<pre> BB          - P R M / M O N - Un000 = 00000 Un002 = 00000 Un008 = 0000000000 Un00D = 0000000000           </pre>	 	Press the  or  Key to move the cursor to “Un.”
3	<pre> BB          - P R M / M O N - Pn000 = n.0000 Un002 = 00000 Un008 = 0000000000 Un00D = 0000000000           </pre>	 	Press the  or  Key to switch “Un” to “Pn.”























Step	Display after Operation	Keys	Operation
4	<pre> BB          - P R M / M O N - P n 0 0 0 = n.0 0 0 0 <u>0</u> U n 0 0 2 = 0 0 0 0 0 U n 0 0 8 = 0 0 0 0 0 0 0 0 0 0 U n 0 0 D = 0 0 0 0 0 0 0 0 0 0 </pre>		Press the  Key to move the cursor to the setting side (to the position of the first digit of Pn000.0).
5	<pre> BB          - P R M / M O N - P n 0 0 0 = n.0 0 0 0 <u>1</u> U n 0 0 2 = 0 0 0 0 0 U n 0 0 8 = 0 0 0 0 0 0 0 0 0 0 U n 0 0 D = 0 0 0 0 0 0 0 0 0 0 </pre>		Press the  Key once to set "1" for the first digit of Pn.000.0.
6	<pre> A . 9 4 1          - P R M / M O N - P n 0 0 0 = n.0 0 0 0 <u>1</u> U n 0 0 2 = 0 0 0 0 0 U n 0 0 8 = 0 0 0 0 0 0 0 0 0 0 U n 0 0 D = 0 0 0 0 0 0 0 0 0 0 </pre>		Press the  Key. The new setting of Pn000 is written to the SERVOPACK. The cursor moves to the parameter number side and the warning A.941 is displayed.
7	To enable the change in the setting, turn the power OFF and ON again.*		









\* When the setting is modified, the parameters whose modified setting is validated only after setting validation, the warning A.941 "Change of Parameters Requires the Setting Validation" is displayed. Turn the power OFF then ON to clear the warning and validate the new setting.



2.1.1 Parameter Setting

(2) Operation Example 2: Setting the Parameters for Numeric Settings

This example shows the operation procedure to set “1000” (min-1) for Pn304 (JOG speed).

Step	Display after Operation	Keys	Operation
1	<pre> BB          - P R M / M O N - Un00<u>0</u> = 00000 Un002 = 00000 Un008 = 0000000000 Un00D = 0000000000                     </pre>		Press the  Key to select the parameter/monitor mode.
2	<pre> BB          - P R M / M O N - Un000 = 00000 Un002 = 00000 Un008 = 0000000000 Un00D = 0000000000                     </pre>	 	Press the  or  Key to move the cursor to “Un.”
3	<pre> BB          - P R M / M O N - Pn000 = n.0000 Un002 = 00000 Un008 = 0000000000 Un00D = 0000000000                     </pre>	 	Press the  or  Key to switch “Un” to “Pn.”
4	<pre> BB          - P R M / M O N - Pn<u>0</u>00 = n.0000 Un002 = 00000 Un008 = 00000 pulse Un00D = 0000000000                     </pre>		Press the  Key once to move the cursor to the right side of “Pn.”
5	<pre> BB          - P R M / M O N - Pn<u>3</u>04 = 00500 Un002 = 00000 Un008 = 0000000000 Un00D = 0000000000                     </pre>	   	Press the arrow keys to display “Pn304.” To move the cursor to different columns:  ,  Key To change the settings:  or  Key
6	<pre> BB          - P R M / M O N - Pn304 = 005<u>0</u>0 Un002 = 00000 Un008 = 0000000000 Un00D = 0000000000                     </pre>		Press the  Key. The cursor moves to the setting side (to the position of the first digit of Pn304).

Step	Display after Operation	Keys	Operation
7	<pre> BB          - P R M / M O N - P n 3 0 4 = 0 0 <u>5</u> 0 0 U n 0 0 2 = 0 0 0 0 0 U n 0 0 8 = 0 0 0 0 0 0 0 0 0 0 U n 0 0 D = 0 0 0 0 0 0 0 0 0 0 </pre>		Press the  Key twice to move the cursor to the third digit of Pn304.
8	<pre> BB          - P R M / M O N - P n 3 0 4 = 0 1 <u>0</u> 0 0 U n 0 0 2 = 0 0 0 0 0 U n 0 0 8 = 0 0 0 0 0 0 0 0 0 0 U n 0 0 D = 0 0 0 0 0 0 0 0 0 0 </pre>	   	Press the  Key five times to change the setting to “1000.”
9	<pre> BB          - P R M / M O N - P n 3 0 <u>4</u> = 0 1 0 0 0 U n 0 0 2 = 0 0 0 0 0 U n 0 0 8 = 0 0 0 0 0 0 0 0 0 0 U n 0 0 D = 0 0 0 0 0 0 0 0 0 0 </pre>		Press the  Key to write the settings. The cursor moves to the parameter number side.

Note: If the  Key has not been pressed but the  Key has been pressed to select another mode such as the utility function mode, any changes that have been made to the parameter will be saved in the SERVOPACK.

### 2.1.2 Parameter Classification

Parameters of the  $\Sigma$ -V Series SERVOPACK are classified into two types of parameters. One type of parameters is required for setting up the basic conditions for operation and the other type is required for tuning parameters that are required to adjust servomotor characteristics.

Classification	Meaning	Display Method	Setting Method
Setup Parameters	Parameters required for setup.	Always displayed (Factory setting: Pn00B.0 = 0)	Set each parameter individually.
Tuning Parameters	Parameters for tuning control gain and other parameters.	Set Pn00B.0 to 1.	There is no need to set each parameter individually.

## 2.2 Monitor Mode

This section describes available monitor modes and operation procedures in the parameter/monitor mode.

### 2.2.1 Monitor Items

Parameter No	Content of Display	Unit
Un000	Motor rotating speed	min <sup>-1</sup>
Un001	Speed reference	min <sup>-1</sup>
Un002	Internal torque reference (in percentage to the rated torque)	%
Un003	Rotational angle 1 (encoder pulses from the phase-C origin: decimal display)	Encoder pulse
Un004	Rotational angle 2 (from polarity origin (electric angle))	Degree
Un005	Input signal monitor *1	–
Un006	Output signal monitor *2	–
Un007	Input reference pulse speed (displayed only in position control mode)	min <sup>-1</sup>
Un008	Position error amount (displayed only in position control mode)	Reference unit
Un009	Accumulated load ratio (in percentage to the rated torque: effective torque in cycle of 10 seconds)	%
Un00A	Regenerative load ratio (in percentage to the processable regenerative power: regenerative power consumption in cycle of 10 seconds)	%
Un00B	Power consumed by DB resistance (in percentage to the processable power at DB activation: display in cycle of 10 seconds)	%
Un00C	Input reference pulse counter	Reference unit
Un00D	Feedback pulse counter	Encoder pulse
Un00E	Fully-closed feedback pulse counter	External encoder resolution
Un010	Upper limit setting of motor maximum speed/ Upper limit setting of encoder output resolution	–
Un011	Hall sensor signal monitor	–
Un012	Total run time	100 ms
Un013	Feedback pulse counter	Reference unit
Un014	Effective gain monitor (gain settings 1=1, gain settings 2=2)	–

## 2 Parameter/Monitor Modes

### 2.2.1 Monitor Items

Parameter No	Content of Display	Unit
Un015	Safety input/output signal monitor *3	–
Un020	Motor rated speed	min <sup>-1</sup>
Un021	Motor maximum speed	min <sup>-1</sup>
Un084	Linear scale pitch (Scale pitch=Un084×10 <sup>Un085</sup> [pm])	–
Un085	Linear scale pitch index (Scale pitch=Un084×10 <sup>Un085</sup> [pm])	–

- \*1. The input signal monitor Un005 is displayed as follows. The upper portion indicates the OFF status, the lower portion indicates the ON status. The undefined digits are displayed in the lower portion (ON status).

U n 0 0 5 = 

Display LED Number	Input Terminal Name	Signal Name (Factory Setting)
1	CN1-40 (can be allocated)	/S-ON (Servo ON) input
2	CN1-41 (can be allocated)	/P-CON (Proportional operation reference) input
3	CN1-42 (can be allocated)	P-OT (Forward run prohibited) input
4	CN1-43 (can be allocated)	N-OT (Reverse run prohibited) input
5	CN1-44 (can be allocated)	/ALM-RST (Alarm reset) input
6	CN1-45 (can be allocated)	/P-CL (Forward current limit ON) input
7	CN1-46 (can be allocated)	/N-CL (Reverse current limit ON) input
8	CN1-4 (cannot be allocated)	SEN (SEN signal) input

- \*2. The output signal monitor Un006 is displayed as follows. The upper portion indicates the OFF status, the lower portion indicates the ON status. The undefined digits are displayed in the lower portion (ON status).

U n 0 0 6 = 

Display LED Number	Output Terminal Name	Signal Name (Factory Setting)
1	CN1-31, C-32 (cannot be allocated)	ALM (Servo alarm) output
2	CN1-25, C-26 (can be allocated)	/COIN (Positioning completion) output or /V-CMP (Speed coincidence) output
3	CN1-27, C-28 (can be allocated)	/TGON (Detection during servomotor rotation) output
4	CN1-29, C-30 (can be allocated)	/S-RDY (Servo ready) output
5	CN1-37 (cannot be allocated)	AL01 (Alarm code) output
6	CN1-38 (cannot be allocated)	AL02 (Alarm code) output
7	CN1-39 (cannot be allocated)	AL03 (Alarm code) output
8	—	—

- \*3. The output signal monitor Un015 is displayed as follows. The upper portion indicates the ON status, the lower portion indicates the OFF status. The undefined digits are displayed in the lower portion (OFF status).

U n 0 1 5 = 

Display LED Number	Output Terminal Name	Signal Name
1	CN8-3, C-4 (cannot be allocated)	/HWBB1 (Hard Wire Baseblock 1) input
2	CN8-5, C-6 (cannot be allocated)	/HWBB2 (Hard Wire Baseblock 2) input
3	—	—
4	—	—
5	—	—
6	—	—
7	—	—
8	—	—













### 2.2.2 Monitor Mode Display







• Operation Example

Select Un000 (Motor speed) on the first line, Un002 (Internal torque reference) on the second line, Un005 (Input signal monitor) on the third line, and Un006 (Output signal monitor) on the fourth line, and then save the display.

The following example shows when changing the displayed factory setting items.

BB	-PRM/MON-	
Un000 =	00000	← Motor speed
Un002 =	00000	← Internal torque reference
Un005 =	■■■■■■■■■■	← Input signal monitor
Un006 =	■■■■■■■■■■	← Output signal monitor

Step	Display after Operation	Keys	Operation										
1	<table border="1"> <tr> <td>BB</td> <td>-PRM/MON-</td> </tr> <tr> <td>Un00<u>0</u> =</td> <td>00000</td> </tr> <tr> <td>Un002 =</td> <td>00000</td> </tr> <tr> <td>Un008 =</td> <td>0000000000</td> </tr> <tr> <td>Un00D =</td> <td>0000000000</td> </tr> </table>	BB	-PRM/MON-	Un00 <u>0</u> =	00000	Un002 =	00000	Un008 =	0000000000	Un00D =	0000000000		Press the  Key to select the parameter/monitor mode.
BB	-PRM/MON-												
Un00 <u>0</u> =	00000												
Un002 =	00000												
Un008 =	0000000000												
Un00D =	0000000000												
2	<table border="1"> <tr> <td>BB</td> <td>-PRM/MON-</td> </tr> <tr> <td>Un000 =</td> <td>00000</td> </tr> <tr> <td>Un002 =</td> <td>00000</td> </tr> <tr> <td>Un008 =</td> <td>0000000000</td> </tr> <tr> <td>Un00<u>D</u> =</td> <td>0000000000</td> </tr> </table>	BB	-PRM/MON-	Un000 =	00000	Un002 =	00000	Un008 =	0000000000	Un00 <u>D</u> =	0000000000		Press the  Key once to move the cursor to the fourth line.
BB	-PRM/MON-												
Un000 =	00000												
Un002 =	00000												
Un008 =	0000000000												
Un00 <u>D</u> =	0000000000												
3	<table border="1"> <tr> <td>BB</td> <td>-PRM/MON-</td> </tr> <tr> <td>Un000 =</td> <td>00000</td> </tr> <tr> <td>Un002 =</td> <td>00000</td> </tr> <tr> <td>Un008 =</td> <td>0000000000</td> </tr> <tr> <td>Un00<u>6</u> =</td> <td>■■■■■■■■■■</td> </tr> </table>	BB	-PRM/MON-	Un000 =	00000	Un002 =	00000	Un008 =	0000000000	Un00 <u>6</u> =	■■■■■■■■■■	 OR 	Press the  or  Key to display Un006 (Output signal monitor).
BB	-PRM/MON-												
Un000 =	00000												
Un002 =	00000												
Un008 =	0000000000												
Un00 <u>6</u> =	■■■■■■■■■■												
4	<table border="1"> <tr> <td>BB</td> <td>-PRM/MON-</td> </tr> <tr> <td>Un000 =</td> <td>00000</td> </tr> <tr> <td>Un002 =</td> <td>00000</td> </tr> <tr> <td>Un00<u>8</u> =</td> <td>0000000000</td> </tr> <tr> <td>Un006 =</td> <td>■■■■■■■■■■</td> </tr> </table>	BB	-PRM/MON-	Un000 =	00000	Un002 =	00000	Un00 <u>8</u> =	0000000000	Un006 =	■■■■■■■■■■		Press the  Key once to move the cursor to the line above.
BB	-PRM/MON-												
Un000 =	00000												
Un002 =	00000												
Un00 <u>8</u> =	0000000000												
Un006 =	■■■■■■■■■■												

Step	Display after Operation	Keys	Operation
5	<pre> BB          - P R M / M O N - Un000 = 00000 Un002 = 00000 Un00<u>5</u> = ██████████ Un006 = ██████████ </pre>	<p style="text-align: center;">   or   </p>	<p>Press the  or  Key to display Un005 (Input signal monitor). The desired items are displayed.</p>
6	<pre> BB          - P R M / M O N - Un000 = 00000 Un002 = 00000 Un00<u>5</u> = ██████████ Un006 = ██████████ </pre>	<p style="text-align: center;">  </p>	<p>Press the  Key.  The LED on the key blinks and the display with selected items is saved.  Note: Do not turn OFF the SERVO-  PACK's control power while saving.</p>

## Utility Function Mode

3.1 Outline .....	3-3
3.2 Operations .....	3-6
3.2.1 Alarm History Display (Fn000) .....	3-6
3.2.2 JOG Operation (Fn002) .....	3-8
3.2.3 Origin Search (Fn003) .....	3-11
3.2.4 Program JOG Operation (Fn004) .....	3-14
3.2.5 Initializing Parameter Settings (Fn005) .....	3-17
3.2.6 Clearing Alarm History (Fn006) .....	3-19
3.2.7 Absolute Encoder Multiturn Reset and Encoder Alarm Reset (Fn008) .....	3-20
3.2.8 Automatic Tuning of Analog (Speed, Torque) Reference Offset (Fn009) .....	3-22
3.2.9 Manual Servo-tuning of Speed Reference Offset (Fn00A) .....	3-24
3.2.10 Manual Servo-tuning of Torque Reference Offset (Fn00B) .....	3-26
3.2.11 Offset Adjustment of Analog Monitor Output (Fn00C) .....	3-28
3.2.12 Gain Adjustment of Analog Monitor Output (Fn00D) .....	3-30
3.2.13 Automatic Offset-Signal Adjustment of the Motor Current Detection Signal (Fn00E) .....	3-32
3.2.14 Manual Offset-Signal Adjustment of the Motor Current Detection Signal (Fn00F) .....	3-34
3.2.15 Write Prohibited Setting (Fn010) .....	3-36
3.2.16 Servomotor Model Display (Fn011) .....	3-39
3.2.17 Software Version Display (Fn012) .....	3-41
3.2.18 Multiturn Limit Value Setting Change When a Multiturn Limit Disagreement Alarm Occurs (Fn013) .....	3-42
3.2.19 Resetting Configuration Errors in Option Modules (Fn014) .....	3-44
3.2.20 Vibration Detection Level Initialization (Fn01B) .....	3-46
3.2.21 Display of SERVOPACK and Servomotor ID (Fn01E) .....	3-49
3.2.22 Display of Servomotor ID in Feedback Option Module (Fn01F) .....	3-51
3.2.23 Origin Setting (Fn020) .....	3-53
3.2.24 Software Reset (Fn030) .....	3-54
3.2.25 Polarity Detection (Fn080) .....	3-56
3.2.26 Tuning-less Levels Setting (Fn200) .....	3-58
3.2.27 Advanced Autotuning (Fn201) .....	3-60
3.2.28 Advanced Autotuning by Reference (Fn202) .....	3-67
3.2.29 One-parameter Tuning (Fn203) .....	3-71
3.2.30 Anti-Resonance Control Adjustment Function (Fn204) .....	3-79

3.2.31 Vibration Suppression Function (Fn205) .....	3-87
3.2.32 EasyFFT (Fn206) .....	3-91
3.2.33 Online Vibration Monitor (Fn207) .....	3-95

## 3.1 Outline

Utility functions are used to execute the functions related to servomotor operation and adjustment.

Each utility function has a number starting with Fn.

### Utility Functions List

Function No.	Name	Function	Remarks	
			*1	*2
Fn000	Alarm history display	Displays the history up to the last 10 alarms.	–	–
Fn002	JOG operation	Runs the servomotor using the operation keys on the digital operator.	✓	✓
Fn003	Origin search	Runs the servomotor using the operation keys on the digital operator and stop the servomotor at the detected phase-C position.	✓	✓
Fn004	Program JOG operation	Runs the servomotor in the pre-programmed motion pattern.	✓	✓
Fn005	Initializing parameter settings	Initializes the settings of parameters to the factory setting.	✓	✓
Fn006	Clearing alarm history	Clears the alarm history.	✓	–
Fn008	Absolute encoder multiturn reset and encoder alarm reset	Resets the absolute encoder alarm, and resets the multiturn data to zero.	✓	✓
Fn009	Automatic tuning of analog (speed, torque) reference offset	Adjusts automatically the speed or torque analog reference offset.	✓	✓
Fn00A	Manual servo turning of speed reference offset	Adjusts manually the speed reference offset.	✓	–
Fn00B	Manual servo turning of torque reference offset	Adjusts manually the torque reference offset.	✓	–
Fn00C	Offset adjustment of analog monitor output	Adjusts manually the analog monitor output offset.	✓	–

- \*1. The utility function marked with a “✓” in column \*1 under Remarks is disabled when the Write Prohibited Setting (Fn010=0001) is set.  
“NO-OP” is displayed when the Utility Function Mode main menu display is switched to each utility function display.
- \*2. The utility function marked with a “✓” in column \*2 under Remarks is disabled when the /S-ON (Servo ON) input signal is ON.  
“NO-OP” is displayed when the Utility Function Mode main menu display is switched to each utility function display.

(cont'd)

Function No.	Name	Function	Remarks	
			*1	*2
Fn00D	Gain adjustment of analog monitor output	Adjusts manually the analog monitor output gain.	✓	–
Fn00E	Automatic offset-signal adjustment of the motor current detection signal	Adjusts automatically the servomotor current detection offset.	✓	✓
Fn00F	Manual offset-signal adjustment of the motor current detection signal	Adjusts manually the servomotor current detection offset.	✓	–
Fn010	Write prohibited setting	Prohibits or permits overwriting the parameter.	–	–
Fn011	Servomotor model display	Displays the servomotor model.	–	–
Fn012	Software version display	Displays the software version number of the SERVOPACK.	–	–
Fn013	Multiturn limit value setting change when a multiturn limit disagreement alarm occurs	Resets the alarm A.CC0 occurred when the multiturn limit value was modified, and set the new limit value.	✓	–
Fn014	Resetting configuration error in option modules	Clears the detected results that are saved on each individual option module.	✓	–
Fn01B	Vibration detection level initialization	Automatically adjusts the detection level of vibration alarm/warning.	✓	–
Fn01E *3	Display of SERVOPACK and servomotor ID	Displays the model, serial number, and manufacturing date of the SERVOPACK and servomotor stored in the feedback option module.	–	–
Fn01F *3	Display of servomotor ID in feedback option module	Displays encoder ID.	–	–
Fn020	Origin setting	Stores phase information of the motor from home position in the SERVOPACK, using the current position as the home position.	✓	✓

- \*1. The utility function marked with a “✓” in column \*1 under Remarks is disabled when the Write Prohibited Setting (Fn010=0001) is set.  
“NO-OP” is displayed when the Utility Function Mode main menu display is switched to each utility function display.
- \*2. The utility function marked with a “✓” in column \*2 under Remarks is disabled when the /S-ON (Servo ON) input signal is ON.  
“NO-OP” is displayed when the Utility Function Mode main menu display is switched to each utility function display.
- \*3. Fn01E and Fn01F can be executed only from the JUSP-OP05A-1-E digital operator.

(cont'd)



Function No.	Name	Function	Remarks	
			*1	*2
Fn030	Software reset	Uses a software program to internally reset the SERVOPACK and, as when the power is turned OFF and then ON again, to make all calculations, including those for parameters.	–	✓
Fn080	Polarity detection	Detects polarity and stores phase information of the motor from home position in the SERVOPACK.	✓	✓
Fn200	Tuning-less levels setting	Sets the level of tuning-less function.	✓	–
Fn201	Advanced autotuning	Automatically sets servo gain and filter by automatic operation.	✓	✓
Fn202	Advanced autotuning by reference	Sets servo gains and filters automatically while the motor is running.	✓	–
Fn203	One-parameter tuning	Changes four servo gains collectively at the same time.	✓	–
Fn204	Anti-resonance control adjustment function	Suppresses continuous vibration (trembling) of approximately 100 Hz to 1,000 Hz.	✓	–
Fn205	Vibration suppression function	Suppresses low and transient vibration (trembling) of approximately 1 Hz to 100 Hz.	✓	–
Fn206	EasyFFT	Brings the motor to micro motion from the SERVOPACK to detect vibration frequency and set notch filter.	✓	✓
Fn207	Online vibration monitor	Detects vibration frequency while motor is running and sets notch filter.	✓	–

- \*1. The utility function marked with a “✓” in column \*1 under Remarks is disabled when the Write Prohibited Setting (Fn010=0001) is set.  
“NO-OP” is displayed when the Utility Function Mode main menu display is switched to each utility function display.
- \*2. The utility function marked with a “✓” in column \*2 under Remarks is disabled when the /S-ON (Servo ON) input signal is ON.  
“NO-OP” is displayed when the Utility Function Mode main menu display is switched to each utility function display.

## 3.2 Operations

This section describes the operation method on the execution display selected from the main menu of the utility function.



Press the  Key in the parameter/monitor mode to display the main menu of utility function mode.

Press the  or  Key to select a utility function to be executed, and then press the  Key to display the execution display of selected utility function.

Press the  Key to scroll up or down four lines at a time.

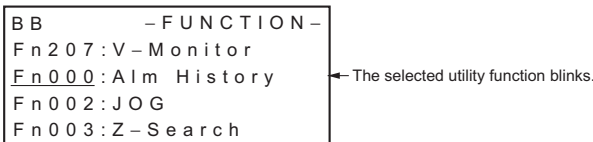
### Utility Function Mode Main Menu Display



If the utility function that cannot be executed is selected and the  or  Key is pressed, “NO-OP” is displayed for one second.

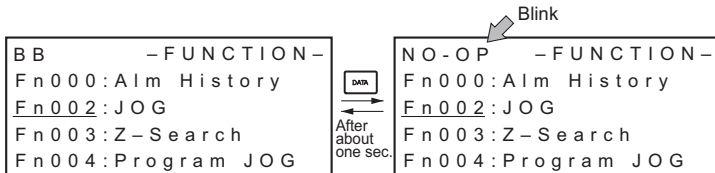

Note: When the Write Prohibited Setting (Fn010) is set, executing operation such as JOG operation (Fn002) displays “NO-OP.”

### 3.2.1 Alarm History Display (Fn000)

This function displays the last ten alarms that have occurred in the SERVOPACK. The latest ten alarm numbers and time stamps\* can be checked.

\* Time Stamps

A function that measures the ON times of the control power supply and main circuit power supply in 100-ms units and displays the total operating time when an alarm occurs. The time stamp operates around the clock for approximately 13 years.

<Example of Time Stamps>

If 36000 is displayed,

$3600000 \text{ [ms]} = 3600 \text{ [s]} = 60 \text{ [min]} = 1 \text{ [h]}$

Therefore, the total number of operating hours is 1 hour.



















## (1) Preparation

There are no tasks that must be performed before displaying the alarm history.

## (2) Operating Procedure

Use the following procedure.

Step	Display after Operation	Keys	Operation
1	<pre> BB      -FUNCTION- Fn207:V-Monitor Fn000:Alm History Fn002:JOG Fn003:Z-Search           </pre>	  	<p>Press the  Key to view the main menu for the utility function mode.</p> <p>Use the  or  Key to move through the list and select Fn000.</p>
2	<pre> A.D00  -ALARM- 0:D00  00001207196 1:720  00000032651 2:511  00000009043 3:---           </pre>		<p>Press the  Key. The display changes to the Fn000 execution display.</p>
3	<pre> A.D00  -ALARM- 1:720  00000032651 2:511  00000009043 3:--- 4:---           </pre> <p>   </p> <p>           Time stamp            Alarm no.            Alarm history no.            0: Latest            9: Oldest         </p>	 	<p>Press the  or  Key to scroll through the alarm history. The alarm history can be viewed.</p>
4	<pre> BB      -FUNCTION- Fn207:V-Monitor Fn000:Alm History Fn002:JOG Fn003:Z-Search           </pre>		<p>Press the  Key.</p> <p>The display returns to the main menu of the utility function mode.</p>

- Note:
1. If the same alarm occurs after more than one hour, the alarm will be saved. If it occurs in less than one hour, it will not be saved.
  2. The display “□.---” means no alarm occurs.
  3. Delete the alarm history using the parameter Fn006. The alarm history is not cleared on alarm reset or when the SERVOPACK main circuit power is turned OFF.

### 3.2.2 JOG Operation (Fn002)

JOG operation is used to check the operation of the servomotor under speed control without connecting the SERVOPACK to the host controller.

<b>⚠ CAUTION</b>
<ul style="list-style-type: none"> <li>While the SERVOPACK is in JOG operation, the overtravel function will be disabled. Consider the operating range of the machine when performing JOG operation for the SERVOPACK.</li> </ul>

#### (1) Preparation

The following conditions must be met to perform a jog operation.







- The write prohibited setting (Fn010) must not be set to write-protect parameters.
- The main circuit power supply must be ON.
- All alarms must be cleared.
- The hardwire baseblock (HWBB) must be disabled.
- The servomotor power must be OFF.
- The JOG speed must be set considering the operating range of the machine.  
Set the jog speed in Pn304.

<b>Pn304</b>	Jog Speed				Classification	
			Speed	Position		Torque
	Setting Range	Setting Unit	Factory Setting	When Enabled		
	0 to 10000	1 min <sup>-1</sup> *	500	Immediately	Setup	























\* When using an SGMCS direct drive motor, the setting unit will be automatically changed to 0.1 min<sup>-1</sup>.

#### (2) Operating Procedure

Use the following procedure. The following example is given when the rotating direction of servomotor is set as Pn000.0=0 (Forward rotation by forward reference).

Step	Display after Operation	Keys	Operation
1	<pre>BB      -FUNCTION- Fn000: Alm History Fn002: JOG Fn003: Z-Search Fn004: Program JOG</pre>	  	<p>Press the  Key to view the main menu for the utility function mode.</p> <p>Use the  or  Key to move through the list and select Fn002.</p>

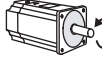
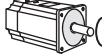

(cont'd)

Step	Display after Operation	Keys	Operation
2	<pre> BB                - JOG - Pn304=00500 Un000= 00000 Un002= 00000 Un00D= 0000000000 </pre>		Press the  Key. The display changes to the Fn002 execution display.
3	<pre> BB                - JOG - Pn304=0050<u>0</u> Un000= 00000 Un002= 00000 Un00D= 0000000000 </pre>		Press the  Key. The cursor moves to the setting side (the right side) of Pn304 (JOG speed).
4	<pre> BB                - JOG - Pn304=01<u>0</u>00 Un000= 00000 Un002= 00000 Un00D= 0000000000 </pre>	   	Press the  or  Key and the  or  Key to set the JOG speed to 1000 min <sup>-1</sup> .
5	<pre> BB                - JOG - Pn304=01000 Un000= 00000 Un002= 00000 Un00D= 0000000000 </pre>		Press the  Key. The setting value is entered, and the cursor moves to the parameter number side (the left side).
6	<pre> RUN              - JOG - Pn304=01000 Un000= 00000 Un002= 00000 Un00D= 0000000000 </pre>		Press the  Key. The status display changes from “BB” to “RUN”, and the servomotor power turns ON.
7	<pre> RUN              - JOG - Pn304=01000 Un000= 00000 Un002= 00000 Un00D= 0000000000 </pre>	 	<p>The servomotor will rotate at the present speed set in Pn304 while the  Key (for forward rotation) or  Key (for reverse rotation) is pressed.</p>  Forward  Reverse
8	<pre> BB                - JOG - Pn304=01000 Un000= 00000 Un002= 00000 Un00D= 0000000000 </pre>		After having confirmed the correct motion of servomotor, press the  Key. The status display changes from “RUN” to “BB”, and the servomotor power turns OFF.

### 3 Utility Function Mode

#### 3.2.2 JOG Operation (Fn002)

(cont'd)

Step	Display after Operation	Keys	Operation
9	<pre>BB      -FUNCTION- Fn000: Alm History Fn002: JOG Fn003: Z-Search Fn004: Program JOG</pre>		Press the  Key. The display returns to the main menu of the utility function mode.
10	Turn OFF the power and then turn it ON again.		

### 3.2.3 Origin Search (Fn003)

The origin search is designed to position the origin pulse position of the incremental encoder (phase C) and to clamp at the position.

#### ⚠ CAUTION

- Perform origin searches without connecting the coupling.  
The forward run prohibited (P-OT) and reverse run prohibited (N-OT) signals are not effective in origin search mode.

This function is used when the motor shaft needs to be aligned to the machine.

Motor speed at the time of execution:  $60 \text{ min}^{-1}$

(For SGMCS direct drive motors, the speed at the time of execution is  $6 \text{ min}^{-1}$ .)

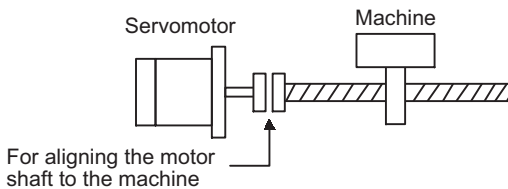

#### (1) Preparation























The following conditions must be met to perform the origin search.

- The write prohibited setting (Fn010) must not be set to write-protect parameters.
- The main circuit power supply must be ON.
- All alarms must be cleared.
- The hardwire baseblock (HWBB) must be disabled.
- The servomotor power must be OFF.



3.2.3 Origin Search (Fn003)

(2) Operating Procedure

Use the following procedure.

Step	Display after Operation	Keys	Operation											
1	<pre> BB      —FUNCTION— Fn002: JOG Fn003: Z-Search Fn004: Program JOG Fn005: Prm Init                     </pre>	  	<p>Press the  Key to view the main menu for the utility function mode.</p> <p>Use the  or  Key to move through the list and select Fn003.</p>											
2	<pre> BB      —Z-Search— Un000= 00000 Un002= 00000 Un003= 0000000774 Un00D= 0000000000                     </pre>		<p>Press the  Key. The display changes to the Fn003 execution display.</p>											
3	<pre> RUN     —Z-Search— Un000= 00000 Un002= 00000 Un003= 0000000774 Un00D= 0000000000                     </pre>		<p>Press the  Key. The status display changes from “BB” to “RUN”, and the servomotor power turns ON.</p> <p>Note: If the servomotor is already at the zero position, “-Complete-” is displayed.</p>											
4	<pre> RUN     —Complete— Un000= 00000 Un002= 00000 Un003= 0000000000 Un00D= 0000001D58                     </pre>		<p>Pressing the  Key will rotate the motor in the forward direction. Pressing the  Key will rotate the motor in the reverse direction. The rotation of the servomotor changes according to the setting of Pn000.0.</p> <table border="1" data-bbox="593 901 991 1045"> <thead> <tr> <th>Parameter</th> <th> key (Forward)</th> <th> key (Reverse)</th> </tr> </thead> <tbody> <tr> <td>Pn000</td> <td>n.□□□0</td> <td>CCW</td> <td>CW</td> </tr> <tr> <td></td> <td>n.□□□1</td> <td>CW</td> <td>CCW</td> </tr> </tbody> </table> <p>Note: Direction when viewed from the load of the servomotor.</p> <p>Press the  or  Key until the motor stops. If the origin search completed normally, “-Complete-” is displayed on the right top on the screen.</p>	Parameter	 key (Forward)	 key (Reverse)	Pn000	n.□□□0	CCW	CW		n.□□□1	CW	CCW
Parameter	 key (Forward)	 key (Reverse)												
Pn000	n.□□□0	CCW	CW											
	n.□□□1	CW	CCW											
5	<pre> BB      —Z-Search— Un000= 00000 Un002= 00000 Un003= 0000000000 Un00D= 0000001D58                     </pre>		<p>When the origin search is completed, press the  Key.</p> <p>The status display changes from “RUN” to “BB”, and the servomotor power turns OFF. The display “-Complete-” changes to “-Z-Search-.”</p>											

(cont'd)

Step	Display after Operation	Keys	Operation
6	<pre> BB          —FUNCTION— Fn002: JOG Fn003: Z-Search Fn004: Program JOG Fn005: Prm Init           </pre>		Press the  Key. The display returns to the main menu of the utility function mode.
7	Turn OFF the power and then turn it ON again.		

### 3.2.4 Program JOG Operation (Fn004)

The program JOG operation is a utility function, that allows continuous operation determined by the preset operation pattern, movement distance, movement speed, acceleration/deceleration time, waiting time, and number of times of movement. This function can be used to move the servomotor without it having to be connected to a host controller for the machine as a trial operation in JOG operation mode. Program JOG operation can be used to confirm the operation and for simple positioning operations.

#### (1) Preparation

The following conditions must be met to perform the program JOG operation.

- The write prohibited setting (Fn010) must not be set to write-protect parameters.
- The main circuit power supply must be ON.
- All alarms must be cleared.
- The hardwire baseblock (HWBB) must be disabled.
- The servomotor power must be OFF.
- The travel distance and speed must be set correctly considering the machine operation range and safe operation speed.
- There must be no overtravel.

#### (2) Related Parameters

The following parameters set the program JOG operation pattern. Do not change the settings while the program JOG operation is being executed.



















Setting Item for Program JOG Operation Pattern	Parameter No.
Operation Pattern	Pn530.0
Movement Distance	Pn531
Movement Speed	Pn533*
Acceleration/Deceleration Time	Pn534
Waiting Time	Pn535
Number of Times of Movement	Pn536

\* Pn585 when using a linear motor.



## (3) Operating Procedure

Use the following procedure to perform the program JOG operation after setting a program JOG operation pattern.



Step	Display after Operation	Keys	Operation
1	<pre>BB      -FUNCTION- Fn003: Z-Search Fn004: Program JOG Fn005: Prm Init Fn006: AlmHist Clr</pre>	  	<p>Press the  Key to view the main menu for the utility function mode.</p> <p>Use the  or  Key to move through the list and select Fn004.</p>
2	<pre>BB      -PRG JOG- Pn531=00032768 Pn533=00500 Pn534=00100 Pn536=00001</pre>		<p>Press the  Key. The display changes to the Fn004 execution display.</p>
3*	<pre>BB      -PRG JOG- Pn531=00032768 Pn533=00500 Pn534=00100 Pn536=00010</pre>	 	<p>Confirm that the parameters have been set.</p> <p>Press the  Key to view Pn530.</p> <p>Press the  Key to view the parameters in the following order:  Pn530 → Pn531 → Pn533 → Pn534 → Pn535 → Pn536.</p>
4	<pre>RUN     -PRG JOG- Pn531=00032768 Pn533=00500 Pn534=00100 Pn536=00010</pre>		<p>Press the  Key.</p> <p>The status display changes from “BB” to “RUN”, and the servomotor power turns ON.</p>
5	<pre>RUN     -PRG JOG- Pn531=00032768 Pn533=00500 Pn534=00100 Pn536=00010</pre>	 	<p>Press the  (forward movement start) or  (reverse movement start) Key according to the first movement direction of the preset operation pattern. The servomotor starts moving after the preset waiting time in Pn535.</p> <p>Note: Pressing the  Key again changes the status to “BB” (baseblocked status) and stops movement even during operation.</p>

\* The settings can be changed for a parameter.

### 3 Utility Function Mode

#### 3.2.4 Program JOG Operation (Fn004)

(cont'd)

Step	Display after Operation	Keys	Operation
6	<pre> END      -PRG JOG- P n 5 3 1=00032768 P n 5 3 3=00500 P n 5 3 4=00100 P n 5 3 6=000<u>10</u>                     </pre>		<p>When the set program JOG operation movement is completed, "END" is displayed for one second, and then "RUN" is displayed.</p> <p>Press the  Key. The servomotor becomes baseblocked status. The display returns to the main menu of the utility function mode.</p>
7	After program JOG operation, turn OFF the power and then turn ON again.		

### 3.2.5 Initializing Parameter Settings (Fn005)

This function is used when returning to the factory settings after changing parameter settings.



**IMPORTANT**

- Be sure to initialize the parameter settings while the servomotor power is OFF.
- After initialization, turn OFF the power supply and then turn ON again to validate the settings.

Note: Any value adjusted with Fn00C, Fn00D, Fn00E, and Fn00F cannot be initialized by Fn005.









#### (1) Preparation

The following conditions must be met to initialize the parameter values.

- The write prohibited setting (Fn010) must not be set to write-protect parameters.
- The servomotor power must be OFF.

#### (2) Operating Procedure

Use the following procedure.

Step	Display after Operation	Keys	Operation
1	<pre>BB      -FUNCTION- Fn004: Program JOG Fn005: Prm Init Fn006: AlmHist Clr Fn008: Mturn Clr</pre>	  	Press the  Key to view the main menu for the utility function mode. Use the  or  Key to move through the list and select Fn005.
2	<pre>BB Parameter Init Start : [DATA] Return: [SET]</pre>		Press the  Key. The display changes to the Fn005 execution display.

### 3 Utility Function Mode

#### 3.2.5 Initializing Parameter Settings (Fn005)

(cont'd)

Step	Display after Operation	Keys	Operation
3	<div style="border: 1px solid black; padding: 5px; width: fit-content;"> <pre> BB Parameter Init Start : [DATA] Return : [SET]                     </pre> </div>	<div style="display: flex; gap: 10px; align-items: center;"> <div style="border: 1px solid black; padding: 2px 5px;">DATA</div> <div style="border: 1px solid black; padding: 2px 5px;">MODE/SET </div> </div>	<p>Press the  Key to initialize parameters.</p> <p>During initialization, “Parameter Init” is flashing in the display.</p> <p>After the initialization is completed, “Parameter Init” stops flashing and the status display changes as follows:</p> <ul style="list-style-type: none"> <li>• SERVOPACKs with Analog Voltage/Pulse Train References “BB” → “DONE” → “A.941”</li> <li>• SERVOPACKs with Other References “BB” → “DONE” → “BB”</li> </ul> <p>Note: Press the  Key not to initialize parameters. The display returns to the main menu of the utility function mode.</p>
4	Turn OFF the power and then turn it ON again to validate the new setting.		

### 3.2.6 Clearing Alarm History (Fn006)

The clear alarm history function deletes all of the alarm history recorded in the SERVOPACK.

Note: The alarm history is not deleted when the alarm reset is executed or the main circuit power supply of the SERVOPACK is turned OFF.













#### (1) Preparation

The follow conditions must be met to clear the alarm history.

- The write prohibited setting (Fn010) must not be set to write-protect parameters.

#### (2) Operating Procedure

Use the following procedure.

Step	Display after Operation	Keys	Operation
1	<pre> BB      -FUNCTION- Fn005:Prm Init Fn006:AlmHist Clr Fn008:Mturn Clr Fn009:Ref Adj           </pre>	  	<p>Press the  Key to view the main menu for the utility function mode.</p> <p>Use the  or  Key to move through the list and select Fn006.</p>
2	<pre> BB Alarm History       Data Clear Start : [DATA] Return: [SET]           </pre>		<p>Press the  Key. The display changes to the Fn006 execution display.</p>
3	<pre> BB Alarm History       Data Clear Start : [DATA] Return: [SET]           </pre>	 	<p>Press the  Key to clear the alarm history.</p> <p>While clearing the data, "DONE" is displayed in the status display. After the data has been successfully cleared, "BB" is displayed.</p> <p>Note: Press the  Key not to clear the alarm history. The display returns to the main menu of the utility function mode.</p>

### 3.2.7 Absolute Encoder Multiturn Reset and Encoder Alarm Reset (Fn008)

#### CAUTION

- The rotational data will be a value between -2 and +2 rotations when the absolute encoder setup is executed. The reference position of the machine system will change. Set the reference position of the host controller to the position after setup.  
If the machine is started without adjusting the position of the host controller, unexpected operation may cause injury or damage to the machine. Take sufficient care when operating the machine.

Setting up the absolute encoder is necessary in the following cases.

- When starting the machine for the first time
- When an encoder backup error alarm (A.810) is generated
- When an encoder checksum error alarm (A.820) is generated
- When initializing the rotational serial data of the absolute encoder

#### (1) Precautions on Setup

- If the following absolute encoder alarms are displayed, cancel the alarm by using the same method as the set up (initializing) with Fn008. They cannot be canceled with the ALM\_CLR command.
  - Encoder backup error alarm (A.810)
  - Encoder checksum error alarm (A.820)
- Any other alarms (A.8□□) that monitor the inside of the encoder should be canceled by turning OFF the power.















#### (2) Preparation

The following conditions must be met to setup the absolute encoder.

- The write prohibited setting (Fn010) must not be set to write-protect parameters.
- The servomotor power must be OFF.

## (3) Operating Procedure

Use the following procedure.

Step	Display after Operation	Keys	Operation
1	<pre> BB      —FUNCTION— Fn006:AlmHistClr Fn008:MturnClr Fn009:RefAdj Fn00A:VelAdj           </pre>	  	Press the  Key to view the main menu for the utility function mode. Use the  or  Key to move through the list and select Fn008.
2	<pre> BB Multiturn Clear PGCL1           </pre>		Press the  Key. The display changes to the Fn008 execution display.
3	<pre> BB Multiturn Clear PGCL1           </pre>		Keep pressing the  Key until “PGCL1” is changed to “PGCL5.”
4	<pre> DONE Multiturn Clear PGCL5           </pre>		Press the  Key to setup the absolute encoder. After completing the setup, “DONE” is flashed for approximately one second and “BB” is displayed.
5	<pre> BB      —FUNCTION— Fn006:AlmHistClr Fn008:MturnClr Fn009:RefAdj Fn00A:VelAdj           </pre>		Press the  Key. The display returns to the main menu of the utility function mode.
6	Turn OFF the power and then turn it ON again to validate the new setting.		

### 3.2.8 Automatic Tuning of Analog (Speed, Torque) Reference Offset (Fn009)

This function measures the amount of offsets and adjusts the reference voltage automatically. The amount of offsets measured is saved in the SERVOPACK.

Note: This function cannot be used when a position loop has been formed with a host controller. Use the manual servo turning of speed reference offset (Fn00A) function or the manual servo turning of torque reference offset (Fn00B) function to adjust the reference voltage.









#### (1) Preparation

The following conditions must be met to adjust the offsets of speed or torque analog reference automatically.

- The write prohibited setting (Fn010) must not be set to write-protect parameters.
- The servomotor power must be OFF.



#### (2) Operating Procedure

Use the following procedure.

Step	Display after Operation	Keys	Operation
1	<pre> BB          - PRM / MON - Un000=  00000 Un002=  00000 Un008=  0000000000 Un00D=  0000000000                     </pre>		Set the analog voltage input to 0 V.
2	<pre> BB          - FUNCTION - Fn008: Mturn Clr Fn009: Ref Adj Fn00A: Vel Adj Fn00B: Trq Adj                     </pre>	  	Press the  Key to view the main menu of the utility function mode. Use the  or  Key to move through the list and select Fn009.
3	<pre> BB Ref Adjust  Start : [DATA] Return: [SET]                     </pre>		Press the  Key. The display changes to the Fn009 execution display.



(cont'd)

Step	Display after Operation	Keys	Operation
4	<div style="border: 1px solid black; padding: 5px; width: fit-content;">           B B            Ref Adjust             Start : [DATA]            Return: [SET]         </div>	<div style="border: 1px solid black; padding: 2px; display: inline-block; margin-bottom: 5px;">DATA</div> OR <div style="border: 1px solid black; padding: 2px; display: inline-block; margin-bottom: 5px;">MODE/SET ↔</div>	<p>Press the  Key to execute the automatic adjustment of analog voltage reference (speed or torque) offset. "DONE" is displayed during the processing, and "BB" is displayed at the completion.</p> <p>Press the  Key not to execute the automatic adjustment. The display returns to the main menu of the utility function mode.</p>

### 3.2.9 Manual Servo-tuning of Speed Reference Offset (Fn00A)

With this function, the speed reference offset can be adjusted by manually inputting the amount of the offset. Use this function in the following cases.

- To adjust position error to zero when a position loop is formed with the host controller and the servomotor is stopped by servolock.
- To deliberately set the offset amount to some value.
- To check the offset amount calculated in the automatic adjustment mode.









#### (1) Preparation

The following conditions must be met to adjust the offsets of speed reference manually.









- The write prohibited setting (Fn010) must not be set to write-protect parameters.
- The main circuit power supply must be ON.
- All alarms must be cleared.
- The hardwire baseblock (HWBB) must be disabled.
- When an absolute encoder is used, the SEN signal is ON (high level).

#### (2) Operating Procedure

Use the following procedure.

Step	Display after Operation	Keys	Operation
1			Set the analog voltage input to 0 V.
2	<pre> BB          -FUNCTION- Fn009:Ref Adj Fn00A:Vel Adj Fn00B:Trq Adj Fn00C:MonZero Adj                     </pre>	  	Press the  Key to view the main menu of the utility function mode. Use the  or  Key to move through the list and select Fn00A.
3	<pre> BB Velocity Adjust ZADJV= 00000 Vref = 00000                     </pre>		Press the  Key. The display changes to the Fn00A execution display.
4	<pre> RUN Velocity Adjust ZADJV= 00000 Vref = 00000                     </pre>		Turn ON the servo ON (/S-ON) signal.

(cont'd)

Step	Display after Operation	Keys	Operation
5	<pre> RUN   Velocity Adjust ZADJV=+0001<u>2</u> Vref = 00000           </pre>	 OR 	Press the  or  Key to adjust the reference speed offset value.
6	<pre> RUN   Velocity Adjust ZADJV=+0001<u>5</u> Vref = 00000           </pre>		Press the  Key to write the speed reference offset value into the SERVO-PACK. When the writing is completed, the status display shows "DONE" for one second.
7	<pre> RUN      -FUNCTION- Fn009:Ref Adj Fn00A:Vel Adj Fn00B:Trq Adj Fn00C:MonZero Adj           </pre>		Press the  Key. The display returns to the main menu of the utility function mode.

### 3.2.10 Manual Servo-tuning of Torque Reference Offset (Fn00B)

This function executes the manual adjustment of the torque reference offset value. Use this function in the following cases.

- To deliberately set the offset amount to some value.
- To check the offset amount calculated in the automatic adjustment mode.









#### (1) Preparation

The following conditions must be met to adjust the offsets of torque reference manually.









- The write prohibited setting (Fn010) must not be set to write-protect parameters.
- The main circuit power supply must be ON.
- All alarms must be cleared.
- The hardwire baseblock (HWBB) must be disabled.
- When an absolute encoder is used, the SEN signal is ON (high level).

#### (2) Operating Procedure

Use the following procedure.

Step	Display after Operation	Keys	Operation
1			Set the analog voltage input to 0 V.
2	<pre> BB      - FUNCTION - Fn00A:Vel Adj Fn00B:Trq Adj Fn00C:MonZero Adj Fn00D:MonGain Adj           </pre>	  	Press the  Key to view the main menu of the utility function mode. Use the  or  Key to move through the list and select Fn00B.
3	<pre> BB Torque Adjust ZADJT=-00004 Tref = 00000           </pre>		Press the  Key. The display changes to the Fn00B execution display.
4	<pre> RUN Torque Adjust ZADJT=-00004 Tref = 00000           </pre>		Turn ON the servo ON (/S-ON) signal.

(cont'd)

Step	Display after Operation	Keys	Operation
5	<pre> RUN Torque Adjust ZADJT=-0000<u>7</u> Tref = 00000 </pre>	 or 	Press the  or  Key to adjust the reference torque offset value.
6	<pre> RUN Torque Adjust ZADJT=-0000<u>7</u> Tref = 00000 </pre>		Press the  Key to write the torque reference offset value into the SERVOPACK. When the writing is completed, the status display shows "DONE" for one second.
7	<pre> RUN      -FUNCTION- Fn00A:Vel Adj Fn00B:Trq Adj Fn00C:MonZero Adj Fn00D:MonGain Adj </pre>		Press the  Key. The display returns to the main menu of the utility function mode.

### 3.2.11 Offset Adjustment of Analog Monitor Output (Fn00C)

This function is used to manually adjust the offsets for the analog monitor outputs (torque reference monitor output and motor speed monitor output). The offset values are factory-set before shipping. Therefore, the user need not usually use this function.

- Note:
- The adjustment value will not be initialized when parameter settings are initialized using Fn005.
  - Make offset adjustment with a measuring instrument connected, so that the analog monitor output is zero.















#### (1) Preparation

The following condition must be met to adjust the offsets of the analog monitor output.









- The write prohibited setting (Fn010) must not be set to write-protect parameters.

#### (2) Operating Procedure

Use the following procedure.

Step	Display after Operation	Keys	Operation
1	<pre> BB      -FUNCTION- Fn00B:Trq Adj Fn00C:MonZero Adj Fn00D:MonGain Adj Fn00E:Cur AutoAdj                     </pre>	  	<p>Press the  Key to view the main menu for the utility function mode.</p> <p>Use the  or  Key to move through the list and select Fn00C.</p>
2	<pre> BB      -Zero ADJ- CH1=-0000<u>2</u> CH2= 00001 Un002= 00000 Un000= 00000                     </pre>		<p>Press the  Key. The display changes to the Fn00C execution display.</p>
3	<pre> BB      -Zero ADJ- CH1=-0000<u>5</u> CH2= 00001 Un002= 00000 Un000= 00000                     </pre>	 	<p>Press the  or  Key to adjust the offset of CH1 (torque reference monitor).</p> <p>Adjust the offset so that the measurement instrument reading is as close to 0 V as possible.</p>
4	<pre> BB      -Zero ADJ- CH1=-00005 CH2= 0000<u>1</u> Un002= 00000 Un000= 00000                     </pre>		<p>After the offset adjustment of CH1 has completed, adjust the offset of CH2 (motor speed monitor).</p> <p>Press the  Key. The cursor moves to CH2 side.</p>

(cont'd)

Step	Display after Operation	Keys	Operation
5	<pre> BB      -Zero ADJ- CH1=-00005 CH2= 0000<u>6</u> Un002= 00000 Un000= 00000 </pre>	 	<p>Adjust the offset of CH2 in the same way as for CH1.</p> <p>Press the  or  Key to adjust the offset of CH2.</p> <p>Adjust the offset so that the measurement instrument reading is as close to 0 V as possible.</p>
6	<pre> BB      -Zero ADJ- CH1=-00005 CH2= 0000<u>6</u> Un002= 00000 Un000= 00000 </pre>		<p>After having completed the offset adjustment both for CH1 and CH2, press the  Key.</p> <p>The adjustment results are saved in the SERVOPACK, and the status display shows “DONE” for one second. The status display then returns to show “BB” again.</p>
7	<pre> BB      -FUNCTION- Fn00B:Trq Adj Fn00C:MonZero Adj Fn00D:MonGain Adj Fn00E:Cur AutoAdj </pre>		<p>Press the  Key.</p> <p>The display returns to the main menu of the utility function mode.</p>

### 3.2.12 Gain Adjustment of Analog Monitor Output (Fn00D)

This function is used to manually adjust the gains for the analog monitor outputs (torque reference monitor output and motor speed monitor output). The gain values are factory-set before shipping. Therefore, the user need not usually use this function. The setting range of the gain adjustment width for analog monitor output is -128 to +127 (× 0.4%).

The setting of gain adjustment width is made on the base of 100%. For example, the setting “-125” makes  $100\% - (125 \times 0.4\%) = 50\%$ , which means that the monitor output voltage is 1/2. The setting “125” makes  $100\% + (125 \times 0.4\%) = 150\%$ , which means that the monitor output voltage is 1.5 times.

Note: The adjustment value will not be initialized when parameter settings are initialized using Fn005.















#### (1) Preparation

The following condition must be met to adjust the gain of the analog monitor output.

- The write prohibited setting (Fn010) must not be set to write-protect parameters.









#### (2) Operating Procedure

Use the following procedure.

Step	Display after Operation	Keys	Operation
1	<pre>BB      -FUNCTION- Fn00C: MonZero Adj Fn00D: MonGain Adj Fn00E: Cur AutoAdj Fn00F: Cur ManuAdj</pre>	  	<p>Press the  Key to view the main menu for the utility function mode.</p> <p>Use the  or  Key to move through the list and select Fn00D.</p>
2	<pre>BB      -Gain ADJ- CH1=-0000<u>1</u> CH2=-00001 Un002= 00000 Un000= 00000</pre>		<p>Press the  Key. The display changes to the Fn00D execution display.</p>
3	<pre>BB      -Gain ADJ- CH1= 0012<u>5</u> CH2=-00001 Un002= 00000 Un000= 00000</pre>	 	<p>Press the  or  Key to adjust the gain adjustment width of CH1 (torque reference monitor).</p>
4	<pre>BB      -Gain ADJ- CH1= 00125 CH2=-0000<u>1</u> Un002= 00000 Un000= 00000</pre>		<p>After the gain adjustment of CH1 has completed, adjust the gain adjustment width of CH2 (motor speed monitor).</p> <p>Press the  Key. The cursor moves to CH2 side.</p>



(cont'd)

Step	Display after Operation	Keys	Operation
5	<pre> BB      -Gain ADJ- CH1= 00125 CH2=-0012<u>5</u> Un002= 00000 Un000= 00000 </pre>	 	<p>Adjust the gain of CH2 in the same way as for CH1.</p> <p>Press the  or  Key to adjust the gain adjustment width of CH2 (motor speed monitor).</p>
6	<pre> BB      -Gain ADJ- CH1= 00125 CH2=-0012<u>5</u> Un002= 00000 Un000= 00000 </pre>		<p>After having completed the adjustment both for CH1 and CH2, press the  Key.</p> <p>The adjustment results are saved in the SERVOPACK, and the status display shows “DONE” for one second. The status display then returns to show “BB” again.</p>
7	<pre> BB      -FUNCTION- Fn00C: MonZero Adj Fn00D: MonGain Adj Fn00E: Cur AutoAdj Fn00F: Cur ManuAdj </pre>		<p>Press the  Key.</p> <p>The display returns to the main menu of the utility function mode.</p>

### 3.2.13 Automatic Offset-Signal Adjustment of the Motor Current Detection Signal (Fn00E)

Perform this adjustment only if highly accurate adjustment is required for reducing torque ripple caused by current offset. The user need not usually use this function.

 <b>IMPORTANT</b>	<ul style="list-style-type: none"> <li>• Be sure to perform this function while the servomotor power is OFF.</li> <li>• Execute the automatic offset adjustment if the torque ripple is too big when compared with those of other SERVO-PACKs.</li> </ul>
---	---

Note: Fn005 cannot initialize any value adjusted with Fn00E.









#### (1) Preparation

The following conditions must be met to automatically adjust the offset of the motor current detection signal.





- The write prohibited setting (Fn010) must not be set to write-protect parameters.
- The main circuit power supply must be ON.
- All alarms must be cleared.
- The hardware baseblock (HWBB) must be disabled.
- When an absolute encoder is used, the SEN signal is ON (high level).
- The servomotor power must be OFF.

#### (2) Operating Procedure

Use the following procedure.

Step	Display after Operation	Keys	Operation
1	<pre> BB      - FUNCTION - Fn00D: MonGain Adj Fn00E: Cur AutoAdj Fn00F: Cur ManuAdj Fn010: Prm Protect                     </pre>	  	<p>Press the  Key to view the main menu for the utility function mode.</p> <p>Use the  or  Key to move through the list and select Fn00E.</p>
2	<pre> BB Auto Offset-ADJ of Motor Current Start : [DATA] Return: [SET]                     </pre>		<p>Press the  Key. The display changes to the Fn00E execution display.</p>

(cont'd)

Step	Display after Operation	Keys	Operation
3	<pre> BB Auto Offset-ADJ of Motor Current Start : [DATA] Return : [SET] </pre>	 	<p>Press the  Key to start the automatic offset-signal adjustment of motor current detection.</p> <p>When the adjustment is completed, the status display shows "DONE" for one second. The status display then returns to show "BB" again.</p> <p>Note: Press the  Key to cancel the automatic adjustment. The display returns to the main menu of the utility function mode.</p>

### 3.2.14 Manual Offset-Signal Adjustment of the Motor Current Detection Signal (Fn00F)

Use this function only if the torque ripple is still high after the automatic offset-signal adjustment of the motor current detection signal (Fn00E).

 <b>IMPORTANT</b>	<p>If this function is executed carelessly, it may worsen the characteristics.</p> <p>Observe the following precautions when performing manual servo tuning.</p> <ul style="list-style-type: none"> <li>• Run the servomotor at a speed of approximately 100 min<sup>-1</sup>.</li> <li>• Adjust the offset while monitoring the torque reference with the analog monitor until the ripple of torque reference monitor's waveform is minimized.</li> <li>• Adjust the phase-U and phase-V offset amounts alternately several times until these offsets are well balanced.</li> </ul>
---	--

Note: Fn005 cannot initialize any value adjusted with Fn00F.









#### (1) Preparation

The following condition must be met to manually adjust the offset of the motor current detection signal.















- The write prohibited setting (Fn010) must not be set to write-protect parameters.

#### (2) Operating Procedure

Use the following procedure.

Step	Display after Operation	Keys	Operation
1	<pre> BB      -FUNCTION- Fn00F: Cur ManuAdj Fn010: Prm Protect Fn011: Motor Info Fn012: Soft Ver                     </pre>	  	<p>Press the  Key to view the main menu for the utility function mode.</p> <p>Use the  or  Key to move through the list and select Fn00F.</p>
2	<pre> BB Manual Offset-ADJ of Motor Current ZADJIU= 0000<u>9</u> ZADJIV= 0000<u>6</u>                     </pre>		<p>Press the  Key.</p> <p>The display changes to the Fn00F execution display.</p>

(cont'd)

Step	Display after Operation	Keys	Operation
3	<pre> RUN Manual Offset-ADJ of Motor Current ZADJIU= 0000<u>9</u> ZADJIV= 0000<u>6</u> </pre>		Turn ON the servo ON (/S-ON) signal.
4	<pre> RUN Manual Offset-ADJ of Motor Current ZADJIU= 0001<u>9</u> ZADJIV= 0000<u>6</u> </pre>	 	Adjust the phase-U offset. Press the  or  Key to adjust the offset amount. Adjust the offset amount by 10 in the direction that the torque ripple is reduced. Adjustment range: -512 to +511 (ZADJIU: Offset value of phase-U current)
5	<pre> RUN Manual Offset-ADJ of Motor Current ZADJIU= 0001<u>9</u> ZADJIV= 0000<u>6</u> </pre>		Adjust the phase-V offset. Press the  Key. The cursor moves to the phase-V side.
6	<pre> RUN Manual Offset-ADJ of Motor Current ZADJIU= 0001<u>9</u> ZADJIV= 0001<u>6</u> </pre>	 	Press the  or  Key to adjust the offset amount. Adjust the offset amount by 10 in the direction that the torque ripple is reduced. Adjustment range: -512 to +511 (ZADJIV: Offset value of phase-V current)
Repeat the operations of steps 4 to 6 (phase-U and-V alternately) until adjusting the offset amounts both for phase-U and -V in both directions cannot reduce the torque ripple any more. Then, perform the same operation by adjusting by smaller amount.			
7	<pre> RUN Manual Offset-ADJ of Motor Current ZADJIU= 0001<u>9</u> ZADJIV= 0001<u>6</u> </pre>		Press the  Key to save the result of adjustment in the SERVOPACK. When the saving is completed, the status display shows "DONE" for one second. The status display then returns to show "RUN" again.
8	<pre> RUN      -FUNCTION- Fn00E:Cur ManuAdj Fn010:Prm Protect Fn011:Motor Info Fn012:Soft Ver </pre>		Press the  Key. The display returns to the main menu of the utility function mode.

### 3.2.15 Write Prohibited Setting (Fn010)

This function prevents changing parameters by mistake and sets restrictions on the execution of the utility function.

Parameter changes and execution of the utility function become restricted in the following manner when the write prohibited setting is set.

- Parameters: Cannot be changed. If you attempt to change it, “NO-OP” will flash on the display and the screen will return to the main menu.
- Utility Function: Some functions cannot be executed. (Refer to the following table.) If you attempt to execute these utility functions, “NO-OP” will flash on the display and the screen will return to the main menu.

Parameter No.	Function	Write Prohibited Setting
Fn000	Alarm history display	Executable
Fn002	JOG operation	Cannot be executed
Fn003	Origin search	Cannot be executed
Fn004	Program JOG operation	Cannot be executed
Fn005	Initializing parameter settings	Cannot be executed
Fn006	Clearing alarm history	Cannot be executed
Fn008	Absolute encoder multiturn reset and encoder alarm reset	Cannot be executed
Fn009	Automatic tuning of analog (speed, torque) reference offset	Cannot be executed
Fn00A	Manual servo turning of speed reference offset	Cannot be executed
Fn00B	Manual servo turning of torque reference offset	Cannot be executed
Fn00C	Offset adjustment of analog monitor output	Cannot be executed
Fn00D	Gain adjustment of analog monitor output	Cannot be executed
Fn00E	Automatic offset-signal adjustment of the motor current detection signal	Cannot be executed
Fn00F	Manual offset-signal adjustment of the motor current detection signal	Cannot be executed
Fn010	Write prohibited setting	–
Fn011	Servomotor model display	Executable
Fn012	Software version display	Executable
Fn013	Multiturn limit value setting change when a multiturn limit disagreement alarm occurs	Cannot be executed
Fn014	Resetting configuration error in option modules	Cannot be executed

(cont'd)

Parameter No.	Function	Write Prohibited Setting
Fn01B	Vibration detection level initialization	Cannot be executed
Fn01E	Display of SERVOPACK and servomotor ID	Executable
Fn01F	Display of servomotor ID in feedback option module	Executable
Fn020	Origin setting	Cannot be executed
Fn030	Software reset	Executable
Fn080	Polarity detection	Cannot be executed
Fn200	Tuning-less levels setting	Cannot be executed
Fn201	Advanced autotuning	Cannot be executed
Fn202	Advanced autotuning by reference	Cannot be executed
Fn203	One-parameter tuning	Cannot be executed
Fn204	Anti-resonance control adjustment function	Cannot be executed
Fn205	Vibration suppression function	Cannot be executed
Fn206	EasyFFT	Cannot be executed
Fn207	Online vibration monitor	Cannot be executed















### (1) Preparation

There are no tasks that must be performed before the execution.

## 3.2.15 Write Prohibited Setting (Fn010)

## (2) Operating Procedure

Follow the steps to set enable or disable writing.

Step	Display after Operation	Keys	Operation
1	<pre> BB          -FUNCTION- Fn00F:Cur ManuAdj Fn010:Prm Protect Fn011:Motor Info Fn012:Soft Ver           </pre>	  	<p>Press the  Key to view the main menu for the utility function mode.</p> <p>Use the  or  Key to move through the list and select Fn010.</p>
2	<pre> BB Parameter Write Protect  P. 000<u>0</u>           </pre>		<p>Press the  Key. The display changes to the Fn010 execution display.</p>
3	<pre> BB Parameter Write Protect  P. 000<u>1</u>           </pre>	 	<p>Press the  or  Key to select one of the following settings.</p> <p>P.0000: Write permitted [Factory setting]</p> <p>P.0001: Write prohibited</p>
4	<pre> BB Parameter Write Protect  P. 000<u>1</u>           </pre>		<p>Press the  Key. The setting value is written into the SERVOPACK, and the status display changes as follows: "DONE" to "BB."</p> <p>Note: Saved settings will be enabled after the SERVOPACK is restarted.</p>
5	Turn OFF the power and then turn it ON again to validate the new setting.		

Note: To make the setting available, change the setting to P.0000 as shown in step 3.



### 3.2.16 Servomotor Model Display (Fn011)











This function is used to check the servomotor model, voltage, capacity, encoder type, and encoder resolution. If the SERVOPACK has been custom-made, you can also check the specification codes of SERVOPACKs.

#### (1) Preparation

There are no tasks that must be performed before the execution.

#### (2) Operating Procedure

Use the following procedure.

Step	Display after Operation	Keys	Operation																										
1	<pre> BB      -FUNCTION- Fn010: Prm Protect Fn011: Motor Info Fn012: Soft Ver Fn013: M turnLmSet           </pre>	  	Press the  Key to view the main menu for the utility function mode. Use the  or  Key to move through the list and select Fn011.																										
2*	<div style="display: flex; flex-direction: column; align-items: flex-start;"> <table border="1" style="margin-bottom: 10px;"> <tr><td>Servomotor Model</td></tr> <tr><td>60 SGM<sub>AV</sub></td></tr> <tr><td>62 SGM<sub>SV</sub></td></tr> <tr><td>63 SGM<sub>GV</sub></td></tr> <tr><td>6D SGM<sub>JV</sub></td></tr> <tr><td>21 SGM<sub>PS</sub></td></tr> <tr><td>32 SGMCS-□□C</td></tr> <tr><td>33 SGMCS-□□D</td></tr> <tr><td>34 SGMCS-□□B</td></tr> <tr><td>35 SGMCS-□□E</td></tr> <tr><td>36 SGMCS-□□L</td></tr> <tr><td>37 SGMCS-□□M</td></tr> <tr><td>38 SGMCS-□□N</td></tr> <tr><td>39 SGMCS-□□R</td></tr> </table> <div style="display: flex; align-items: center; margin-bottom: 10px;"> <div style="margin-right: 10px;">↓</div> <div style="border: 1px solid black; padding: 5px;"> <pre> BB      - MotorInfo - TYPE  [60] AC200V ENCODER [01] 400W 20bit           </pre> </div> <div style="margin-left: 10px;">↑</div> </div> <div style="display: flex; justify-content: space-between; width: 100%;"> <div style="border: 1px solid black; padding: 5px; width: 45%;"> <p style="text-align: center;">Encoder Type</p> <table border="1"> <tr><td>00</td><td>Incremental</td></tr> <tr><td>01</td><td>Multiturn absolute value</td></tr> <tr><td>02</td><td>Absolute value per rotation*</td></tr> </table> </div> <div style="width: 45%;"> <p style="text-align: center;">Encoder Resolution</p> <table border="1"> <tr><td>13</td><td>13 bit</td></tr> <tr><td>17</td><td>17 bit</td></tr> <tr><td>20</td><td>20 bit</td></tr> </table> </div> </div> </div>	Servomotor Model	60 SGM <sub>AV</sub>	62 SGM <sub>SV</sub>	63 SGM <sub>GV</sub>	6D SGM <sub>JV</sub>	21 SGM <sub>PS</sub>	32 SGMCS-□□C	33 SGMCS-□□D	34 SGMCS-□□B	35 SGMCS-□□E	36 SGMCS-□□L	37 SGMCS-□□M	38 SGMCS-□□N	39 SGMCS-□□R	00	Incremental	01	Multiturn absolute value	02	Absolute value per rotation*	13	13 bit	17	17 bit	20	20 bit		Press the  Key. The display changes to the Fn011 execution display and shows the information about the servomotor and encoder being used.
Servomotor Model																													
60 SGM <sub>AV</sub>																													
62 SGM <sub>SV</sub>																													
63 SGM <sub>GV</sub>																													
6D SGM <sub>JV</sub>																													
21 SGM <sub>PS</sub>																													
32 SGMCS-□□C																													
33 SGMCS-□□D																													
34 SGMCS-□□B																													
35 SGMCS-□□E																													
36 SGMCS-□□L																													
37 SGMCS-□□M																													
38 SGMCS-□□N																													
39 SGMCS-□□R																													
00	Incremental																												
01	Multiturn absolute value																												
02	Absolute value per rotation*																												
13	13 bit																												
17	17 bit																												
20	20 bit																												
3	<pre> BB      -FUNCTION- Fn010: Prm Protect Fn011: Motor Info Fn012: Soft Ver Fn013: M turnLmSet           </pre>		Press the  Key. The display returns to the main menu of the utility function mode.																										

\* The absolute encoder without multi-turning can only be used with a direct-drive motor.

\* For linear servomotors, the display designation is as follows.

### 3 Utility Function Mode

#### 3.2.16 Servomotor Model Display (Fn011)

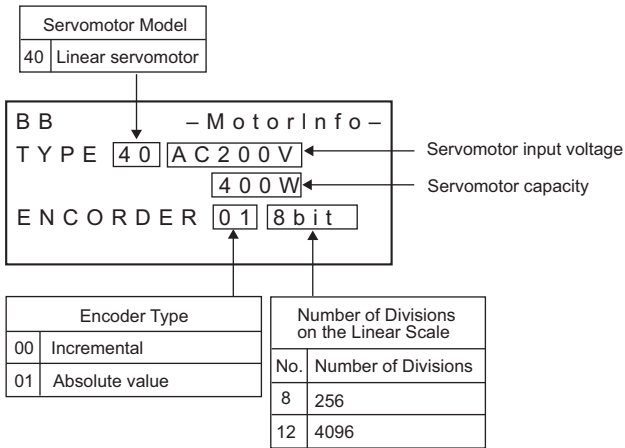

### 3.2.17 Software Version Display (Fn012)











This function is used to check the SERVOPACK and encoder software version numbers.

#### (1) Preparation

There are no tasks that must be performed before the execution.

#### (2) Operating Procedure

Use the following procedure.

Step	Display after Operation	Keys	Operation
1	<pre> BB      -FUNCTION- Fn011:Motor Info Fn012:Soft Ver Fn013:MturnLmSet Fn014:Opt Init           </pre>	  	<p>Press the  Key to view the main menu for the utility function mode.</p> <p>Use the  or  Key to move through the list and select Fn012.</p>
2	<pre> BB      -Soft Ver- DRIVER Ver.=0001 ENCODER Ver.=0003           </pre>		<p>Press the  Key. The display changes to the Fn012 execution display.</p> <p>The software versions of the SERVOPACK and the connected encoder will appear.</p> <p>Note: If the servomotor is not connected, "Not connect" is displayed.</p>
3	<pre> BB      -FUNCTION- Fn011:Motor Info Fn012:Soft Ver Fn013:MturnLmSet Fn014:Opt Init           </pre>		<p>Press the  Key. The display returns to the main menu of the utility function mode.</p>

3.2.18 Multiturn Limit Value Setting Change When a Multiturn Limit Disagreement Alarm Occurs (Fn013)

**3.2.18** Multiturn Limit Value Setting Change When a Multiturn Limit Disagreement Alarm Occurs (Fn013)

When the multiturn limit set value is changed with parameter Pn205, a multiturn limit disagreement alarm (A.CC0) will be displayed because the value differs from that of the encoder.

Alarm Display	Alarm Name	Alarm Output	Meaning
A.CC0	Multiturn Limit Disagreement	OFF (H)	Different multiturn limits have been set in the encoder and SERVOPACK.

If this alarm is displayed, perform the operation described below and change the multiturn limit value in the encoder to the value set in Pn205.













(1) Preparation

The following condition must be met to clear the alarm and change the multiturn limit value.



- The write prohibited setting (Fn010) must not be set to write-protect parameters.

(2) Operating Procedure

Use the following procedure.

Step	Display after Operation	Keys	Operation
1	<pre>A. CC0  —FUNCTION— Fn012: Soft Ver Fn013: MturnLmSet Fn014: Opt Init Fn01B: Vibl_vl Init</pre>	  	<p>Press the  Key to view the main menu for the utility function mode.</p> <p>Use the  or  Key to move through the list and select Fn013.</p>
2	<pre>A. CC0 Multiturn Limit Set Start : [ DATA ] Return: [ SET ]</pre>		<p>Press the  Key.</p> <p>The display changes to the Fn013 execution display.</p>
3	<pre>A. CC0 Multiturn Limit Set Start : [ DATA ] Return: [ SET ]</pre>	 	<p>Press the  Key to set the multiturn limit value. When the setting is completed, the status display shows “DONE” for one second. The status display then returns to show “A.CC0” again.</p> <p>Note: If the  Key is pressed instead of the  Key, the multiturn limit value will not be reset.</p>

(cont'd)

Step	Display after Operation	Keys	Operation
4	<pre> A. CC0  —FUNCTION— Fn012: Soft Ver Fn013: MturnLmSet Fn014: Opt Init Fn01B: VibI_vl Init           </pre>		Press the  Key. The display returns to the main menu of the utility function mode.
5	Turn OFF the power and then turn it ON again to validate the new setting.		

### 3.2.19 Resetting Configuration Errors in Option Modules (Fn014)

The SERVOPACK with option module recognizes installation status and types of option modules that are connected to SERVOPACK. If an error is detected, the SERVOPACK issues an alarm. This function clears these alarms.

- Note: 1. Alarms related to option module can be cleared only by this function. These alarms cannot be cleared by alarm reset or turning OFF the main circuit power supply.  
 2. Before clearing the alarm, perform corrective action for the alarm.















#### (1) Preparation

The following condition must be met to clear detection alarms of the option module.





- The write prohibited setting (Fn010) must not be set to write-protect parameters.

#### (2) Operating Procedure

Use the following procedure.

Step	Display after Operation	Keys	Operation
1	<pre> BB          - FUNCTION - Fn013: MturnLmSet Fn014: Opt Init Fn01B: Vibl_vl Init Fn01E: SvMotOp ID                     </pre>	  	<p>Press the  Key to view the main menu for the utility function mode.</p> <p>Use the  or  Key to move through the list and select Fn014.</p>
2	<pre> BB          - Opt Init - 01: Command Opt 02: Safety Opt 03: Feedback Opt                     </pre>		<p>Press the  Key. The display changes to the Fn014 execution display.</p>
3	<pre> BB          - Opt Init - 01: Command Opt 02: Safety Opt 03: Feedback Opt                     </pre>	 	<p>Press the  or  Key to select an option module to be cleared.</p>
4	<pre> BB          - Opt Init - Feedback Opt Initialize Start : [DATA] Return: [SET]                     </pre>		<p>Press the  Key. The display shown on the left appears.</p>

(cont'd)

Step	Display after Operation	Keys	Operation
5	<pre> BB      - Opt Init - 01: Command Opt 02: Safety Opt 03: Feedback Opt           </pre>		Press the  Key to clear the configuration error of the option module. The error is cleared and the status display shows "DONE" for one second. The status display then returns to step 3.
6	<pre> RUN      - FUNCTION - Fn013: MturnLmSet Fn014: Opt Init Fn01B: VibI_vl Init Fn01E: SvMotOp ID           </pre>		Press the  Key. The display returns to the main menu of the utility function mode.
7	Turn OFF the power and then turn it ON again to validate the new setting.		

### 3.2.20 Vibration Detection Level Initialization (Fn01B)

This function detects vibration when servomotor is connected to a machine in operation and automatically adjusts the vibration detection level (Pn312) to output more exactly the vibration alarm (A.520) and the vibration warning (A.911).

The vibration detection function detects vibration elements according to the motor speed.

Parameter		Meaning	When Enabled	Classification
<b>Pn310</b>	n.□□□0 [Factory setting]	Does not detect vibration.	Immediately	Setup
	n.□□□1	Outputs the warning (A.911) when vibration is detected.		
	n.□□□2	Outputs the alarm (A.520) when vibration is detected.		

If the vibration exceeds the detection level calculated by the following formula, the alarm or warning will be output according to the setting of vibration detection switch (Pn310).

Detection level =

$$\frac{\text{Vibration detection level (Pn312 [min}^{-1}\text{])} \times \text{Vibration detection sensitivity (Pn311 [\%])}{100}$$

- Use this function if the vibration alarm (A.520) or the vibration warning (A.911) is not output correctly when a vibration at the factory setting of the vibration detection level (Pn312) is detected. In other cases, it is not necessary to use this function.
- The vibration alarm or warning detection sensibility differs depending on the machine conditions. In this case, fine-tune the setting of the vibration detection sensitivity (Pn311) using the above detection level formula as a guide.

<b>Pn311</b>	Vibration Detection Sensitivity <input type="text" value="Speed"/> <input type="text" value="Position"/> <input type="text" value="Torque"/>				Classification
	Setting Range	Setting Unit	Factory Setting	When Enabled	
	50 to 500	1%	100	Immediately	Tuning





## IMPORTANT

- The vibration may not be detected because of improper servo gains. Also, not all kinds of vibrations can be detected. Use the detection result as a guideline.
- Set a proper moment of inertia ratio (Pn103). Improper setting may result in the vibration alarm, warning mis-detection, or non-detection.
- The references that are used to operate your system must be input to execute this function.
- Execute this function under the operating condition for which the vibration detection level should be set.
- Execute this function while the motor speed reaches at least 10% of its maximum.











### (1) Preparation

The following conditions must be met to initialize the vibration detection level.

- The write prohibited setting (Fn010) must not be set to write-protect parameters.
- The test without a motor function must be disabled (Pn00C.0 = 0).

### (2) Operating Procedure





Use the following procedure.

Step	Display after Operation	Keys	Operation
1	<pre> RUN      - FUNCTION - Fn014: Opt Init Fn01B: Vibl_vl Init Fn01E: SvMotOp ID Fn01F: FBOPMot ID           </pre>	  	Press the  Key to view the main menu for the utility function mode. Use the  or  Key to move through the list and select Fn01B.
2	<pre> RUN Vibration Detect Level Init Start : [DATA] Return: [SET]           </pre>		Press the  Key. The display changes to the Fn01B execution display.
3	<pre> RUN Vibration Detect Level Init  Init           </pre>		Press the  Key. “Init” is displayed flashing, and the vibration level is detected and initialized. Note: Continues initialization until the  Key is pressed again.

### 3 Utility Function Mode

#### 3.2.20 Vibration Detection Level Initialization (Fn01B)

(cont'd)

Step	Display after Operation	Keys	Operation
4	<pre> RUN Vibration Detect Level Init  DONE                     </pre>		Press the  Key. The display changes from “Init” to “DONE,” for one second and the new setting of Pn312 becomes enabled.
5	<pre> RUN      -FUNCTION- Fn014:Opt Init Fn01B:Vibl_vl Init Fn01E:SvMotOp ID Fn01F:FBOPMot ID                     </pre>		Press the  Key. The display returns to the main menu of the utility function mode.

### 3.2.21 Display of SERVOPACK and Servomotor ID (Fn01E)

This function displays ID information for SERVOPACK, servomotor, encoder, and option module connected to the SERVOPACK. The ID information of some option modules (SGDV-OFA01A, for example) is not stored in the SERVOPACK. “Not available” will be displayed for these option modules.

The following items can be displayed.

ID	Items to be Displayed
SERVOPACK ID	<ul style="list-style-type: none"> <li>• SERVOPACK model</li> <li>• SERVOPACK serial number</li> <li>• SERVOPACK manufacturing date</li> <li>• SERVOPACK input voltage (V)</li> <li>• Maximum applicable motor capacity (W)</li> <li>• Maximum applicable motor rated current (Arms)</li> </ul>
Servomotor ID	<ul style="list-style-type: none"> <li>• Servomotor model</li> <li>• Servomotor order number</li> <li>• Servomotor manufacturing date</li> <li>• Servomotor input voltage (V)</li> <li>• Servomotor capacity (W)</li> <li>• Servomotor rated current (Arms)</li> </ul>
Encoder ID	<ul style="list-style-type: none"> <li>• Encoder model</li> <li>• Encoder serial number</li> <li>• Encoder manufacturing date</li> <li>• Encoder type/resolution</li> </ul>
Safety Option Module ID*	<ul style="list-style-type: none"> <li>• Safety Option Module model</li> <li>• Safety Option Module serial number</li> <li>• Safety Option Module manufacturing date</li> <li>• Safety Option Module ID number</li> </ul>
Feedback Option Module ID*	<ul style="list-style-type: none"> <li>• Feedback Option Module model</li> <li>• Feedback Option Module serial number (Reserved area)</li> <li>• Feedback Option Module manufacturing date</li> <li>• Feedback Option Module ID</li> </ul>

\* If the option module is not connected, “Not connect” will be displayed after the module name.



























#### (1) Preparation

There are no tasks that must be performed before the execution.

## 3.2.21 Display of SERVOPACK and Servomotor ID (Fn01E)

## (2) Operating Procedure

Use the following procedure.

Step	Display after Operation	Keys	Operation
1	<pre> RUN      - FUNCTION - Fn01B:ViblvI Init Fn01E: S v M o t O p I D Fn01F: F B O p M o t I D Fn020: S - O r i g S e t           </pre>	  	<p>Press the  Key to view the main menu for the utility function mode.</p> <p>Use the  or  Key to move through the list and select Fn01E.</p>
2	<pre> Serial number SERVOPACK model BB      - S v M o t O p I D - Driver SGDV - R70A01A ← D00241234590001 ← 02. 04 200V, 50W ↑           ↑           ↑ Manufacturing date Input voltage Capacity           </pre>	  	<p>Press the  Key.</p> <p>The display changes to the Fn01E execution display.</p> <p>The SERVOPACK ID information is displayed. Use the  or  Key to scroll left and right and to view other information.</p>
3	<pre> Serial number Servomotor model BB      - S v M o t O p I D - Motor SGMAV - A5A3A21 ← D00245789090001 ← 07. 04 200V, 50W ↑           ↑           ↑ Manufacturing date Input voltage Capacity           </pre>	  	<p>Press the  Key.</p> <p>The servomotor ID information is displayed. Use the  or  Key to scroll left and right and to view other information.</p>
4	<pre> Serial number Encoder model BB      - S v M o t O p I D - Encoder UTVIH - B20EA ← K247 - 0225E00200 ← 07. 04 20bit - ABS ↑           ↑           ↑ Manufacturing date Encoder type Encoder resolution           </pre>	  	<p>Press the  Key.</p> <p>The encoder ID information is displayed.</p> <p>Use the  or  Key to scroll left and right and to view other information.</p>
5	<pre> RUN      - FUNCTION - Fn01B:ViblvI Init Fn01E: S v M o t O p I D Fn01F: F B O p M o t I D Fn020: S - O r i g S e t           </pre>		<p>Press the  Key.</p> <p>The display returns to the main menu of the utility function mode.</p>

### 3.2.22 Display of Servomotor ID in Feedback Option Module (Fn01F)

This function displays ID information for servomotor and encoder in Feedback Option Module connected to the SERVOPACK. If the option module is not connected, “Not connect” will be displayed after the module name.

The following items can be displayed.













ID	Items to be Displayed
Servomotor ID	<ul style="list-style-type: none"> <li>• Servomotor model</li> <li>• Servomotor order number</li> <li>• Servomotor input voltage (V)</li> <li>• Servomotor capacity (W)</li> <li>• Servomotor rated current (Arms)</li> </ul>
Encoder ID	<ul style="list-style-type: none"> <li>• Encoder model</li> <li>• Encoder serial number</li> <li>• Encoder type/resolution (Two types of resolution display available: Number of bits and number of pulses/rev.)</li> </ul>
Parameter File ID	<ul style="list-style-type: none"> <li>• Parameter file source ID (14 characters)</li> <li>• Parameter file version (4 digits hexadecimal display)</li> </ul>

#### (1) Preparation

There are no tasks that must be performed before the execution.

#### (2) Operating Procedure











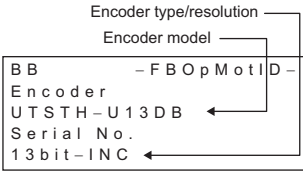

Use the following procedure.

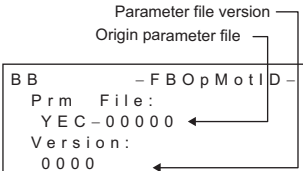
Step	Display after Operation	Keys	Operation
1	<pre> BB          - FUNCTION - Fn01E: SvMotOp ID Fn01F: FBOPMot ID Fn020: S- Orig Set Fn030: Soft Reset           </pre>	  	<p>Press the  Key to view the main menu for the utility function mode.</p> <p>Use the  or  Key to move through the list and select Fn01F.</p>
2	<pre>           Serial number           Servomotor model BB          - FBOPMotID - Motor SGM - 04A312 ← R10419-511-DK5000 ← 200V, 400W           ↑           ↑ Input voltage Capacity           </pre>	  	<p>Press the  Key.</p> <p>The display changes to the Fn01F execution display.</p> <p>The servomotor ID information is displayed. Use the  or  Key to scroll left and right and to view other information.</p>

### 3 Utility Function Mode

#### 3.2.22 Display of Servomotor ID in Feedback Option Module (Fn01F)

(cont'd)

Step	Display after Operation	Keys	Operation
3	 <p>Encoder type/resolution Encoder model BB - F B O p M o t I D - Encoder UTSTH-U13DB ← Serial No. 13bit-INC ←</p>		<p>Press the  Key. The encoder ID information is displayed. Use the  or  Key to scroll left and right and to view other information.</p>
4	 <p>Parameter file version Origin parameter file BB - F B O p M o t I D - Prm File: YEC-0000 ← Version: 0000 ←</p>		<p>Press the  Key. The parameter file ID information is displayed. Use the  or  Key to scroll left and right and to view other information.</p>
5	 <p>BB - FUNCTION - Fn01E:SvMotOp ID Fn01F:FBOPMot ID Fn020:S-Orig Set Fn030:Soft Reset</p>		<p>Press the  Key. The display returns to the main menu of the utility function mode.</p>

### 3.2.23 Origin Setting (Fn020)

When using an external absolute encoder for fully-closed loop control, this function is used to set the current position of the external absolute encoder as the origin (zero point position).

This function can be used with the following products.

Mitutoyo Corporation

ABS ST780A series

Model: ABS ST78□A/ST78□AL















#### (1) Preparation

The following conditions must be met to set the origin.

- The write prohibited setting (Fn010) must not be set to write-protect parameters.
- The servomotor power must be OFF.

#### (2) Operating Procedure

Use the following procedure.

Step	Display after Operation	Keys	Operation
1	<pre> BB          - FUNCTION - Fn01F:FBOP Mot ID Fn020: S- Orig Set Fn030: Soft Reset Fn080: Pole Detect           </pre>	  	<p>Press the  Key to view the main menu for the utility function mode.</p> <p>Use the  or  Key to move through the list and select Fn020.</p>
2	<pre> BB Scale Origin Set           ORGSET1           </pre>		<p>Press the  Key. The display changes to the Fn020 execution display.</p>
3	<pre> BB Scale Origin Set           ORGSET5           </pre>	 	<p>Press the  or  Key to "ORGSET5".</p>
4	<pre> BB Scale Origin Set           </pre>		<p>Press the  key to start setting the origin. The message, "Scale Origin Set," flashes while the origin is being set. After the origin has been successfully set, the displayed status changes as follows: "BB" to "DONE" to "A.941*".</p>
5	Turn OFF the power and then turn it ON again to validate the new setting.		

\* With SGD V SERVOPACK that support MECHATROLINK, "A.941" will not be shown, and "BB" will be displayed instead.

### 3.2.24 Software Reset (Fn030)

This function enables resetting the SERVOPACK internally from software. This function is used when resetting alarms and changing the settings of parameters that normally require restarting the SERVOPACK. This function can be used to change those parameters without restarting the SERVOPACK.

 <b>IMPORTANT</b>	<ul style="list-style-type: none"> <li>• Start software reset operation after the servomotor power is OFF.</li> <li>• This function resets the SERVOPACK independently of host controller. The SERVOPACK carries out the same processing as when the power supply is turned ON and outputs the ALM signal. The status of other output signals may be forcibly changed.</li> </ul>
---	---













(1) Preparation

The following condition must be met to perform a software reset.

- The servomotor power must be OFF.







(2) Operating Procedure

Use the following procedure.

Step	Display after Operation	Keys	Operation
1	<pre> BB      - FUNCTION - Fn020: S- Orig Set Fn030: Soft Reset Fn080: Pole Detect Fn200: TuneLvl Set                     </pre>	  	<p>Press the  Key to view the main menu for the utility function mode.</p> <p>Use the  or  Key to move through the list and select Fn030.</p>
2	<pre> BB Software Reset RESET1                     </pre>		<p>Press the  Key. The display changes to the Fn030 execution display.</p>
3	<pre> BB Software Reset RESET5                     </pre>	 	<p>Press the  or  Key to select "RESET5".</p>

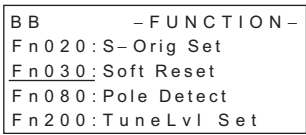

(cont'd)

Step	Display after Operation	Keys	Operation
4			Press the  Key to execute the software reset. After the software reset starts, "RESET5" will no longer be displayed.
5			After the reset has been successfully completed, the screen which appears when the power is turned ON will be displayed. Then, the mode changes to the parameter/monitor display mode.
6			Press the  Key. The display returns to the main menu of the utility function mode.

### 3.2.25 Polarity Detection (Fn080)

This function detects the polarity and stores motor phase information in the SERVOPACK. With this function, phase information stored in the SERVOPACK is read every time the power is turned ON, so an immediate start of operations is possible with no need to detect the polarity.











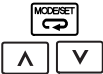

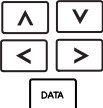

(1) Preparation

The following condition must be met to execute the polarity detection.



- The write prohibited setting (Fn010) must not be set to write-protect parameters.

(2) Operating Procedure

Use the following procedure.

Step	Display after Operation	Keys	Operation
1	<pre> BB          - FUNCTION - Fn030: Soft Reset Fn080: Pole Detect Fn200: TuneLvl Set Fn201: AAT                     </pre>		<p>Press the  Key to view the main menu for the utility function mode.</p> <p>Press the  or  Key to move through the list and select Fn080.</p>
2	<pre> BB Magnetic Pole Detect Level = 40                     </pre>		<p>Press the  Key.</p> <p>The display changes to the Fn080 execution display.</p> <p>To adjust the level:</p> <p>Press the  or  Key to move the cursor from/to the digit.</p> <p>Press the  or  Key to change the value of each digit.</p>
3	<pre> BB Magnetic Pole Detect Start : [JOGSVON] Return: [SET]                     </pre>		<p>Press the  Key. The display shown on the left appears.</p>
4	<pre> P D E T Magnetic Pole Adjustment Return: [SET]                     </pre>		<p>Press the  Key. The linear servomotor will be in servo ON status and the polarity detection will start. During the polarity detection, "Magnetic Pole Adjustment" is displayed blinking.</p> <p>When the polarity detection is complete, the linear servomotor will be in servo OFF status.</p>

(cont'd)

Step	Display after Operation	Keys	Operation
5	<pre> BB Magnetic Pole Detect  Return:[SET] </pre>		<p>When the polarity detection is complete, the display shown on the left appears.</p>
6	<pre> BB          -FUNCTION- Fn030:Soft Reset Fn080:Pole Detect Fn200:TuneLvl Set Fn201:AAT </pre>		<p>Press the  Key. The display returns to the main menu of the utility function mode.</p>

### 3.2.26 Tuning-less Levels Setting (Fn200)

This function sets the load level during tuning-less function.

**⚠ CAUTION**

- To ensure safety, perform the tuning-less function in a state where the SERVO-PACK can come to an emergency stop at any time.













#### (1) Preparation

The following conditions must be met to perform the tuning-less function. If the settings are not correct, “NO-OP” will be displayed during the tuning-less function.











- The tuning-less function must be enabled (Pn170.0 = 1).
- The write prohibited setting (Fn010) must not be set to write-protect parameters.
- The test without a motor function must be disabled. (Pn00C.0 = 0).

#### (2) Operating Procedure

Use the following procedure.

Step	Display after Operation	Keys	Operation
1	<pre> RUN      -FUNCTION- Fn080: Pole Detect Fn200: TuneLvl Set Fn201: AAT Fn202: Ref-AAT                     </pre>	  	<p>Press the  Key to view the main menu for the utility function mode.</p> <p>Use the  or  Key to move through the list, select Fn200.</p>
2	<pre> RUN      -TuneLvlSet- Mode=1                     </pre>		<p>Press the  Key to display the load level of the tuning-less mode setting screen.</p> <p>Notes:</p> <ul style="list-style-type: none"> <li>If the response waveform causes overshooting or if the load moment of inertia exceeds the allowable level (i.e., outside the scope of product guarantee), press the  Key and change the mode setting to 2.</li> <li>If a high-frequency noise is heard, press the  Key and change the mode setting to 0.</li> </ul>
3	<pre> RUN      -TuneLvlSet- Level=4                     </pre>		<p>Press the  Key to display the rigidity level of the tuning-less mode setting screen.</p>

(cont'd)

Step	Display after Operation	Keys	Operation
4	<pre> RUN  —TuneLvISet— Level = <u>4</u> NF 2           ↑         2nd notch filter </pre>	  	<p>Press the  Key or the  Key to select the rigidity level.  Select the rigidity level from 0 to 4. The larger the value, the higher the gain is and the better response performance will be. (The factory setting is 4.)</p> <p>Notes:</p> <ul style="list-style-type: none"> <li>• Vibration may occur if the rigidity level is too high. Lower the rigidity level if vibration occurs.</li> <li>• If a high-frequency noise is heard, press the  Key to automatically set a notch filter to the vibration frequency.</li> </ul>
5	<pre> RUN  —TuneLvISet— Level = <u>4</u> </pre>		<p>Press the  Key. “DONE” will flash for approximately two seconds and then “RUN” will be displayed. The settings are saved in the SERVOPACK.</p>
6	<pre> RUN  —FUNCTION— Fn030 Fn200 Fn201 Fn202 </pre>		<p>Press the  Key. The display returns to the main menu of the utility function mode.</p>

Note: If the rigidity level is changed, the automatically set notch filter will be canceled. If vibration occurs, however, the notch filter will be set again automatically.

### 3.2.27 Advanced Autotuning (Fn201)

This function automatically operates the servo system (in reciprocating movement in the forward and reverse directions) within set limits and adjust the SERVOPACK automatically according to the mechanical characteristics while the servo system is operating.

Advanced autotuning can be performed without connecting the host controller.

Advanced autotuning performs the following adjustments.

- Moment of inertia ratio
- Gains (e.g., position loop gain and speed loop gain)
- Filters (torque reference filter and notch filter)
- Friction compensation
- Anti-resonance control
- Vibration suppression (Mode = 2 or 3)

#### CAUTION

- Because advanced autotuning adjusts the SERVOPACK during automatic operation, vibration or overshooting may occur. To ensure safety, perform advanced autotuning in a state where the SERVOPACK can come to an emergency stop at any time.

#### (1) Preparation

The following conditions must be met to perform the advanced autotuning. The message “NO-OP” indicating that the settings are not appropriate will be displayed, if all of the following conditions are not met.

- The main circuit power supply must be ON.
- There must be no overtravel.
- The servomotor power must be OFF.
- The control method must not be set to torque control.
- The gain selection switch must be in manual switching mode (Pn139.0 = 0).
- Gain setting 1 must be selected.
- The test without a motor function must be disabled (Pn00C.0 = 0).
- All alarms and warning must be cleared.
- The hardwire baseblock (HWBB) must be disabled.
- The write prohibited setting (Fn010) must not be set to write-protect parameters.
- Jcalc must be set to ON to calculate the load moment of inertia when the tuning-less function is enabled (Pn170.0 = 1: factory setting).















Note: If advanced autotuning is started while the SERVOPACK is in speed control, the mode will change to position control automatically to perform advanced autotuning. The mode will return to speed control after completing the adjustment. To perform advanced autotuning in speed control, set the mode to 1 (Mode = 1).





## (2) Operating Procedure

 CAUTION

- When using the SERVOPACK with Jcalc = OFF (load moment of inertia is not calculated), be sure to set a suitable value for the moment of inertia ratio (Pn103). If the setting greatly differs from the actual moment of inertia ratio, normal control of the SERVOPACK may not be possible, and vibration may result.
- When using the MP2000 Series with phase control, select the mode = 1 (standard level). If 2 or 3 is selected, phase control of the MP2000 Series may not be possible.









Use the following procedure.

Step	Display after Operation	Keys	Operation
1	<pre> BB      —FUNCTION— Fn200: TuneLvl Set Fn201: AAT Fn202: Ref-AAT Fn203: OnePrmTun           </pre>	  	Press the  Key to view the main menu for the utility function mode. Use the  or  Key to move through the list, select Fn201.
2	<pre> BB      Status Display BB      Advanced AT Jcalc=ON Mode=2 Type=2 Stroke=+00800000       (0003. 0) rev           </pre>		Press the  Key to display the initial setting screen for advanced autotuning.
3	<pre> BB      Advanced AT Jcalc=ON Mode=2 Type=2 Stroke=+00800000       (0003. 0) rev           </pre>	  	Press the  ,  , or  Key and set the items in steps 3-1 to 3-4.
3-1	<p>■Calculating Moment of Inertia</p> <p>Select the mode to be used.            Usually, set Jcalc to ON.            Jcalc = ON: Moment of inertia calculated [Factory setting]            Jcalc = OFF: Moment of inertia not calculated            Note:            If the moment of inertia ratio is already known from the machine specifications, set the value in Pn103 and set Jcalc to OFF.</p>		
3-2	<p>■Mode Selection</p> <p>Select the mode.            Mode = 1: Makes adjustments considering responsiveness and stability (Standard level).            Mode = 2: Makes adjustments for positioning [Factory setting].            Mode = 3: Makes adjustments for positioning, giving priority to overshooting suppression.</p>		







Step	Display after Operation	Keys	Operation
3-3	<p>■Type Selection</p> <p>Select the type according to the machine element to be driven. If there is noise or the gain does not increase, better results may be obtained by changing the rigidity type.</p> <p>Type = 1: For belt drive mechanisms</p> <p>Type = 2: For ball screw drive mechanisms [Factory setting]</p> <p>Type = 3: For rigid systems in which the servomotor is directly coupled to the machine (without gear or other transmissions)</p>		
3-4	<p>■STROKE (Travel Distance) Setting</p> <p>Travel distance setting range: The travel distance setting range is from -99990000 to +99990000. Specify the STROKE (travel distance) in increments of 1000 reference units. The negative (-) direction is for reverse rotation, and the positive (+) direction is for forward rotation.</p> <p>Initial value: About 3 rotations*</p> <p>* If the servomotor's encoder resolution is 1048576 (20-bit), the STROKE (travel distance) will be set to +800000. If the electronic gear ratio is set to the factory setting (Pn20E=4, Pn210=1), the initial value is calculated as shown with the following equation.</p> $\frac{800000}{1048576} \times \frac{4}{1} \doteq 3 \text{ rotations}$ <p>Notes:</p> <ul style="list-style-type: none"> <li>Set the number of motor rotations to at least 0.5; otherwise, "Error" will be displayed and the travel distance cannot be set.</li> <li>To calculate the moment of inertia and ensure precise tuning, it is recommended to set the number of motor rotations to around 3.</li> <li>For an SGMCS direct drive servomotor, the factory setting for the number of motor rotations is 0.3 or equivalent.</li> </ul>		
4	<pre>BB      Advanced  AT Pn103=00100 Pn100=0040.0 Pn101=0020.00 Pn102=0040.0</pre>		<p>Press the  Key to display the advanced autotuning execution screen.</p>
5	<pre>RUN    Advanced  AT Pn103=00100 Pn100=0040.0 Pn101=0020.00 Pn141=0050.0</pre>		<p>Press the  Key. The servomotor power will be ON and the display will change from "BB" to "RUN."</p> <p>Note: If the mode is set to 2 or 3, the "Pn102" display will change to the "Pn141."</p>



(cont'd)

Step	Display after Operation	Keys	Operation
6	<div style="border: 1px solid black; padding: 5px; width: fit-content;">           A D J    A d v a n c e d    A T            P n 1 0 3 = 0 0 <u>3 0 0</u>            P n 1 0 0 = 0 0 4 0 . 0            P n 1 0 1 = 0 0 2 0 . 0            P n 1 4 1 = 0 0 5 0 . 0         </div> <p>Display example: After the moment of inertia is calculated.</p>	 	<p>Calculates the moment of inertia.</p> <p>Press the  Key if a positive (+) value is set in STROKE (travel distance), or press the  Key if a negative (-) value is set. Calculation of the moment of inertia will start. While the moment of inertia is being calculated, the set value for Pn103 will flash and “ADJ” will flash instead of “RUN.” When calculating the moment of inertia is completed, the display will stop flashing and the moment of inertia is displayed. The servomotor will remain ON, but the auto run operation will be stopped temporarily.</p> <p>Notes:</p> <ul style="list-style-type: none"> <li>• The wrong key for the set travel direction is pressed, the calculation will not start.</li> <li>• If the moment of inertia is not calculated (Jcalc = OFF), the set value for Pn103 will be displayed.</li> <li>• If “NO-OP” or “Error” is displayed during operation, press the  Key to cancel the function. Refer to (3) <i>Failure in Operation</i> and take a corrective action to enable operation.</li> </ul>
7		 	<p>After the servomotor is temporarily stopped, press the  Key to save the calculated moment of inertia ratio in the SERVOPACK. “DONE” will flash for one second, and “ADJ” will be displayed again. Note: To end operation by calculating only the moment of inertia ratio and without adjusting the gain, press the  Key to end operation.</p>

(cont'd)

Step	Display after Operation	Keys	Operation
8	<pre> ADJ      Advanced AT Pn103=00300 Pn100=0100.0 Pn101=0006.36 Pn141=0150.0 </pre>	 	<p>■ Gain Adjustment</p> <p>When the  or  Key is pressed according to the sign (+ or -) of the value set for stroke (travel distance), the calculated value of the moment of inertia ratio will be saved in the SERVOPACK and the auto run operation will restart. While the servomotor is running, the filters, and gains will be automatically set. “ADJ” will flash during the auto setting operation.</p> <p>Note: Precise adjustments cannot be made and “Error” will be displayed as the status if there is machine resonance when starting adjustments. If that occurs, make adjustments using one-parameter tuning (Fn203).</p>
9	<pre> ADJ      Advanced AT Pn103=00300 Pn100=0100.0 Pn101=0006.36 Pn141=0150.0 </pre>		<p>When the adjustment has been completed normally, the servomotor power will turn OFF, and “END” will flash for approximately two seconds and then “ADJ” will be displayed on the status display.</p>
10	<pre> BB      Advanced AT Pn103=00300 Pn100=0100.0 Pn101=0006.36 Pn141=0150.0 </pre>		<p>Press the  Key. The adjusted values will be saved in the SERVOPACK. “DONE” will flash for approximately two seconds, and “BB” will be displayed.</p> <p>Note: Press the  Key to not save the values. The display returns to the main menu of the utility function mode.</p>
11	Turn ON the SERVOPACK power supply again after executing advanced autotuning.		

### (3) Failure in Operation

#### ■ When “NO-OP” Flashes on the Display

Probable Cause	Corrective Actions
The main circuit power supply was OFF.	Turn ON the main circuit power supply.
An alarm or warning occurred.	Remove the cause of the alarm or the warning.
Overtraveling occurred.	Remove the cause of the overtravel.
Gain setting 2 was selected by gain switching.	Disable the automatic gain switching.
The HWBB function operated.	Disable the HWBB function.

### ■ When “Error” Flashes on the Display

Error	Probable Cause	Corrective Actions
The gain adjustment was not successfully completed.	Machine vibration is occurring or the positioning completed signal (/COIN) is turning ON and OFF when the servomotor is stopped.	<ul style="list-style-type: none"> <li>• Increase the set value for Pn522.</li> <li>• Change the mode from 2 to 3.</li> <li>• If machine vibration occurs, suppress the vibration with the anti-resonance control adjustment function and the vibration suppression function.</li> </ul>
An error occurred during the calculation of the moment of inertia.	Refer to the following table ■ <i>When An Error Occurs during Calculation of Moment of Inertia.</i>	
Travel distance setting error	The travel distance is set to approximately 0.5 rotation (0.05 rotation for SGMCS servomotor) or less, which is less than the minimum adjustable travel distance.	Increase the travel distance. It is recommended to set the number of motor rotations to around 3.
The positioning completed signal (/COIN) did not turn ON within approximately 10 seconds after positioning adjustment was completed.	The positioning completed width is too narrow or proportional control (P control) is being used.	<ul style="list-style-type: none"> <li>• Increase the set value for Pn522.</li> <li>• Set V_PPI in the Option field to 0.</li> </ul>
The moment of inertia cannot be calculated when the tuning-less function was activated.	When the tuning-less function was activated, Jcalc was set to OFF so the moment of inertia was not calculated.	<ul style="list-style-type: none"> <li>• Turn OFF the tuning-less function.</li> <li>• Set Jcalc to ON, so the moment of inertia will be calculated.</li> </ul>

### ■ When An Error Occurs during Calculation of Moment of Inertia

The following table shows the probable causes of errors that may occur during the calculation of the moment of inertia with the Jcalc set to ON, along with corrective actions for the errors.

Error Display	Probable Cause	Corrective Actions
Err1	The SERVOPACK started calculating the moment of inertia, but the calculation was not completed.	<ul style="list-style-type: none"> <li>• Increase the speed loop gain (Pn100).</li> <li>• Increase the STROKE (travel distance).</li> </ul>
Err2	The moment of inertia fluctuated greatly and did not converge within 10 tries.	Set the calculation value based on the machine specifications in Pn103 and execute the calculation with the Jcalc set to OFF.
Err3	Low-frequency vibration was detected.	Double the set value of the moment of inertia calculating start level (Pn324).

(cont'd)

Error Display	Probable Cause	Corrective Actions
Err4	The torque limit was reached.	<ul style="list-style-type: none"><li>• When using the torque limit, increase the torque limit.</li><li>• Double the set value of the moment of inertia calculating start level (Pn324).</li></ul>
Err5	While calculating the moment of inertia, the speed control was set to proportional control by setting V_PPI in the Option field to 1.	Operate the SERVOPACK with PI control while calculating the moment of inertia.

### 3.2.28 Advanced Autotuning by Reference (Fn202)

This function is used to automatically achieve optimum tuning of the SERVOPACK in response to the user reference inputs from the host controller.

This function is performed generally to fine-tune the SERVOPACK after advanced autotuning of the SERVOPACK has been performed.

If the moment of inertia ratio is correctly set to Pn103, this function can be performed without performing advanced autotuning.

Advanced autotuning by reference performs the following adjustments.

- Gains (e.g., position loop gain and speed loop gain)
- Filters (torque reference filter and notch filter)
- Friction compensation
- Anti-resonance control
- Vibration suppression

#### CAUTION

- Because advanced autotuning by reference adjusts the SERVOPACK during automatic operation, vibration or overshooting may occur. To ensure safety, perform advanced autotuning by reference in a state where the SERVOPACK can come to an emergency stop at any time.

#### (1) Preparation

The following conditions must be met to perform the advanced autotuning by reference. The message “NO-OP” indicating that the settings are not appropriate will be displayed, if all of the following conditions are not met.

















- The main circuit power supply must be ON.
- All alarms must be cleared.
- The hardwire baseblock (HWBB) must be disabled.
- When an absolute encoder is used, the SEN signal is ON (high level).
- There must be no overtravel.
- The servomotor power must be OFF.
- The position control must be selected when the servomotor power is ON.
- The gain selection switch must be in manual switching mode (Pn139.0 = 0).
- Gain setting 1 must be selected.
- The test without a motor function must be disabled. (Pn00C.0 = 0).
- All warnings must be cleared.
- The write prohibited setting (Fn010) must not be set to write-protect parameters.
- The tuning-less function must be disabled (Pn170.0 = 0).

## (2) Operating Procedure







**⚠ CAUTION**

- When using the MP2000 Series with phase control, select the mode = 1 (standard level). If 2 or 3 is selected, phase control of the MP2000 Series may not be possible.

Set the correct moment of inertia ratio in Pn103 by using the advanced autotuning before performing this procedure.

Step	Display after Operation	Keys	Operation
1	<pre> BB      —FUNCTION— Fn201: AAT Fn202: Ref-AAT Fn203: OnePrmTun Fn204: A-Vib Sup           </pre>	  	<p>Press the  Key to view the main menu for the utility function mode.</p> <p>Use the  or  Key to move through the list and select Fn202.</p>
2	<pre> BB      Advanced AT Mode=3 Type=2           </pre>		<p>Press the  Key to display the initial setting screen for advanced autotuning by reference.</p>
3	<pre> BB      Advanced AT Mode=3 Type=2           </pre>	  	<p>Press the , , or  Key and set the items in steps 3-1 and 3-2.</p>
3-1	<p>■Mode Selection</p> <p>Select the mode.</p> <p>Mode = 1: Makes adjustments considering responsiveness and stability (Standard level).</p> <p>Mode = 2: Makes adjustments for positioning [Factory setting].</p> <p>Mode = 3: Makes adjustments for positioning, giving priority to overshooting suppression.</p>		
3-2	<p>■Type Selection</p> <p>Select the type according to the machine element to be driven.</p> <p>If there is noise or the gain does not increase, better results may be obtained by changing the rigidity type.</p> <p>Type = 1: For belt drive mechanisms</p> <p>Type = 2: For ball screw drive mechanisms [Factory setting]</p> <p>Type = 3: For rigid systems in which the servomotor is directly coupled to the machine (without gear or other transmissions)</p>		
4	<pre> BB      Advanced AT Pn103=00300 Pn100=0040.0 Pn101=0020.00 Pn141=0050.0           </pre>		<p>Press the  Key to display the advanced autotuning by reference execution screen.</p> <p>Note: If the mode is set to 1, Pn102 is displayed. If the mode is set to 2 or 3, the Pn102 display will change to the Pn141.</p>

(cont'd)

Step	Display after Operation	Keys	Operation
5	<pre> RUN      Advanced AT Pn103=00300 Pn100=0040.0 Pn101=0020.00 Pn141=0050.0 </pre>		Turn ON the Servo ON (/S-ON) signal.
6	<pre> ADJ      Advanced AT Pn103=00300 Pn100=0100.0 Pn101=0006.36 Pn141=0150.0 </pre>	 	<p>Input a reference from the host controller and then press the  or  Key to start the adjustment.</p> <p>“ADJ” will flash during adjustment on the status display.</p> <p>Note: Adjustment cannot be performed during “BB” is shown on the status display.</p>
7	<pre> ADJ      Advanced AT Pn103=00300 Pn100=0100.0 Pn101=0006.36 Pn141=0150.0 </pre>		When the adjustment has been completed normally, “END” will flash for approximately two seconds and “ADJ” will be displayed.
8	<pre> RUN      Advanced AT Pn103=00300 Pn100=0100.0 Pn101=0006.36 Pn141=0150.0 </pre>		<p>Press the  Key. The adjusted values will be saved in the SERVOPACK.</p> <p>“DONE” will flash for approximately two seconds, and “RUN” will be displayed.</p> <p>Note: Press the  Key to not save the values. The display returns to the main menu of the utility function mode.</p>
9	Turn ON the SERVOPACK power supply again after executing advanced autotuning by reference.		

## (3) Failure in Operation

## ■ When “NO-OP” Flashes on the Display

Probable Cause	Corrective Actions
The main circuit power supply was OFF.	Turn ON the main circuit power supply.
An alarm or warning occurred.	Remove the cause of the alarm or the warning.
Overtraveling occurred.	Remove the cause of the overtravel.
Gain setting 2 was selected by gain switching.	Disable the automatic gain switching.
HWBB operated.	Disable the HWBB function.

## ■ When “Error” Flashes on the Display

Error	Probable Cause	Corrective Actions
The gain adjustment was not successfully completed.	Machine vibration is occurring or the positioning completed signal (/COIN) is turning ON and OFF when the servomotor is stopped.	<ul style="list-style-type: none"> <li>• Increase the set value for Pn522.</li> <li>• Change the mode from 2 to 3.</li> <li>• If machine vibration occurs, suppress the vibration with the anti-resonance control adjustment function and the vibration suppression function.</li> </ul>
The positioning completed signal (/COIN) did not turn ON within approximately 10 seconds after positioning adjustment was completed.	The positioning completed width is too narrow or proportional control (P control) is being used.	<ul style="list-style-type: none"> <li>• Increase the set value for Pn522.</li> <li>• Set 0 to V_PPI of Option field.</li> </ul>



### 3.2.29 One-parameter Tuning (Fn203)

This function is used to manually make tuning level adjustments during operation with a position reference or speed reference input from the host controller.

This function enables automatically setting related servo gain settings to balanced conditions by adjusting one or two tuning levels.

One-parameter tuning performs the following adjustments.

- Gains (e.g., position loop gain and speed loop gain)
- Filters (torque reference filter and notch filter)
- Friction compensation
- Anti-resonance control

#### CAUTION

- Vibration or overshooting may occur during adjustment. To ensure safety, perform one-parameter tuning in a state where the SERVOPACK can come to an emergency stop at any time.

#### (1) Preparation

The following conditions must be met to perform the one-parameter tuning. The message “NO-OP” indicating that the settings are not appropriate will be displayed, if all of the following conditions are not met.

- The test without a motor function must be disabled (Pn00C.0 = 0).
- The write prohibited setting (Fn010) must not be set to write-protect parameters.
- The tuning-less function must be disabled (Pn170.0 = 0).
- The tuning mode must be set to 0 or 1 when performing speed control.

## (2) Operating Procedure

The following procedure is used for one-parameter tuning.























There are the following two operation procedures depending on the tuning mode being used.

- When the tuning mode is set to 0 or 1, the model following control will be disabled and one-parameter tuning will be used as the tuning method for applications other than positioning.
- When the tuning mode is set to 2 or 3, the model following control will be enabled and it can be used for tuning for positioning.



















Make sure that the moment of inertia ratio (Pn103) is set correctly using advanced autotuning before beginning operation.

 <b>CAUTION</b>
• When using the MP2000 Series with phase control, select the tuning mode = 0 or 1. If 2 or 3 is selected, phase control of the MP2000 Series may not be possible.



## ■ Setting the Tuning Mode 0 or 1

Step	Display after Operation	Keys	Operation
1	<pre> BB      —FUNCTION— Fn202: Ref-AAT Fn203: OnePrmTun Fn204: A-Vib Sup Fn205: Vib Sup           </pre>	  	<p>Press the  Key to view the main menu for the utility function mode.</p> <p>Press the  or  Key to move through the list and select Fn203.</p>
2	<pre>       Status Display BB —OnePrmTun— Pn103=00300           </pre>		<p>Press the  Key to display the moment of inertia ratio set in Pn103 at present. Move the digit with the  or  Key and change the value with the  or  Key.</p>
3	<pre> BB      —OnePrmTun— Setting Tuning Mode = 0 Type = 2           </pre>		<p>Press the  Key to display the initial setting screen for one-parameter tuning.</p>
4	<pre> BB      —OnePrmTun— Setting Tuning Mode = 0 Type = 2           </pre>	  	<p>Press the , , or  Key and set the items in steps 4-1 and 4-2.</p>
4-1	<p>■Tuning Mode</p> <p>Select the tuning mode. Select the tuning mode 0 or 1.            Tuning Mode = 0: Makes adjustments giving priority to stability.            Tuning Mode = 1: Makes adjustments giving priority to responsiveness.</p>		
4-2	<p>■Type Selection</p> <p>Select the type according to the machine element to be driven.            If there is noise or the gain does not increase, better results may be obtained by changing the rigidity type.            Type = 1: For belt drive mechanisms            Type = 2: For ball screw drive mechanisms [Factory setting]            Type = 3: For rigid systems in which the servomotor is directly coupled to the machine (without gear or other transmissions).</p>		
5	<pre> RUN      —OnePrmTun— Setting Tuning Mode = 0 Type = 2           </pre>		<p>If the servomotor power is OFF, turn ON the servo ON (/S-ON) signal. The display will change from “BB” to “RUN.”            If the servomotor power is ON, go to step 6.</p>
6	<pre> RUN      —OnePrmTun— Pn100=0040.0 Pn101=0020.00 Pn102=0040.0           </pre>		<p>Press the  Key to display the set value.</p>

(cont'd)





















Step	Display after Operation	Keys	Operation
7	<pre> RUN   -OnePrmTun-       LEVEL = 0050       NF1 NF2  ARES                     </pre>		<p>Press the  Key again to display the LEVEL setting screen.</p>
8	<pre> RUN   -OnePrmTun-       LEVEL = 0050       NF1 NF2  ARES                     </pre>	   	<p>If readjustment is required, select the digit with the  or  Key or change the LEVEL with the  or  Key. Check the response.</p> <p>If readjustment is not required, go to step 9.</p> <p>Note: The higher the level, the greater the responsiveness will be. If the value is too large, however, vibration will occur.</p> <ul style="list-style-type: none"> <li>• If vibration occurs, press the  Key. The SERVOPACK will automatically detect the vibration frequencies and make notch filter or an anti-resonance control settings. When the notch filter is set, "NF1" or "NF2" will be displayed on the bottom row. When the anti-resonance control is set, "ARES" will be displayed in the lower right corner.</li> </ul> <pre> RUN   -OnePrmTun-       LEVEL=0070       NF1  NF2  ARES                     </pre> <ul style="list-style-type: none"> <li>• If the vibration is great, the vibration frequency will be detected automatically even if the  Key is not pressed and a notch filter or an anti-resonance control will be set.</li> </ul>
9	<pre> RUN   -OnePrmTun- Pn100=0050.0 Pn101=0016.0 Pn102=0050.0                     </pre>		<p>Press the  Key. A confirmation screen will be displayed after LEVEL adjustment.</p>
10	<pre> RUN   -OnePrmTun- Pn100=0050.0 Pn101=0016.0 Pn102=0050.0                     </pre>		<ul style="list-style-type: none"> <li>• Press the  Key to save the adjusted values. After the data is saved, "DONE" will flash for approximately two seconds and then "RUN" will be displayed.</li> <li>• To return to the previous value, press the  Key.</li> <li>• Press the  Key to readjust the level without saving the values.</li> </ul>

(cont'd)

Step	Display after Operation	Keys	Operation
11	<pre> RUN      —FUNCTION— Fn202: Ref-AAT Fn203: OnePrmTun Fn204: A-Vib Sup Fn205: Vib Sup           </pre>		Press the  Key to complete the one-parameter tuning operation. The display returns to the main menu of the utility function mode.

Note: The status display will always be RUN when the servomotor power is ON.

### ■ Setting the Tuning Mode 2 or 3

Step	Display after Operation	Keys	Operation
1	<pre> BB      —FUNCTION— Fn202: Ref-AAT Fn203: OnePrmTun Fn204: A-Vib Sup Fn205: Vib Sup           </pre>	  	<p>Press the  Key to view the main menu for the utility function mode.</p> <p>Press the  or  Key to move through the list and select Fn203.</p>
2	<pre>       Status Display BB —OnePrmTun— Pn103=00300           </pre>		<p>Press the  Key to display the moment of inertia ratio set in Pn103 at present. Move the digit with the  or  Key and change the value with the  or  Key.</p>
3	<pre> BB      —OnePrmTun— Setting Tuning Mode = 2 Type = 2           </pre>		<p>Press the  Key to display the initial setting screen for one-parameter tuning.</p>
4	<pre> BB      —OnePrmTun— Setting Tuning Mode = 2 Type = 2           </pre>	  	<p>Press the , , or  Key and set the items in steps 4-1 and 4-2.</p>
4-1	<p>■Tuning Mode</p> <p>Select the tuning mode. Select the tuning mode 2 or 3.  Tuning Mode = 2: Enables model following control and makes adjustments for positioning.  Tuning Mode = 3: Enables model following control, makes adjustments for positioning, and suppresses overshooting.</p>		
4-2	<p>■Type Selection</p> <p>Select the type according to the machine element to be driven.  If there is noise or the gain does not increase, better results may be obtained by changing the rigidity type.  Type = 1: For belt drive mechanisms  Type = 2: For ball screw drive mechanisms [Factory setting]  Type = 3: For rigid systems in which the servomotor is directly coupled to the machine (without gear or other transmissions).</p>		







### 3 Utility Function Mode

#### 3.2.29 One-parameter Tuning (Fn203)

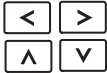







(cont'd)

Step	Display after Operation	Keys	Operation
5	<pre> RUN  —OnePrmTun— Setting Tuning Mode=2 Type=2           </pre>		<p>If the servomotor power is OFF, turn ON the servo ON (/S-ON) signal. The display will change from “BB” to “RUN.”</p> <p>If the servomotor power is ON, go to step 6.</p>
6	<pre> RUN  —OnePrmTun— Pn100=0040.0 Pn101=0020.00 Pn141=0050.0           </pre>	<div style="border: 1px solid black; padding: 2px; display: inline-block;">DATA</div>	<p>Press the <div style="border: 1px solid black; padding: 2px; display: inline-block;">DATA</div> Key to display the set value.</p>
7	<pre> RUN  —OnePrmTun— FF LEVEL=0050.0 FB LEVEL=0040.0           </pre>	<div style="border: 1px solid black; padding: 2px; display: inline-block;">DATA</div>	<p>Press the <div style="border: 1px solid black; padding: 2px; display: inline-block;">DATA</div> Key again to display FF LEVEL and FB LEVEL setting screens.</p>

(cont'd)

Step	Display after Operation	Keys	Operation
8	<pre> RUN  —OnePrmTun— FF LEVEL=0050. 0 FB LEVEL=0040. 0 </pre>		<p>If readjustment is required, select the digit with the  or  Key or change the FF LEVEL and FB LEVEL with the  or  Key. Check the response.</p> <p>If readjustment is not required, go to step 9.</p> <p>Note: The higher the FF LEVEL, the positioning time will be shorter and the response will be better. If the level is too high, however, overshooting or vibration may occur. Overshooting will be reduced if the FB LEVEL is increased.</p> <p>■ If Vibration Occurs</p> <ul style="list-style-type: none"> <li>If vibration occurs, press the  Key. The SERVOPACK will automatically detect the vibration frequencies and make notch filter or an anti-resonance control settings. When the notch filter is set, “NF1” and “NF2” are displayed on the bottom row. When the anti-resonance control is set, “ARES” will be displayed on the bottom low.</li> </ul> <pre> RUN  —OnePrmTun— FF LEVEL=0050. 0 FB LEVEL=0040. 0  NF1  NF2  ARES </pre> <p>■ If Vibration Is Large</p> <ul style="list-style-type: none"> <li>Even if the  Key is not pressed, the SERVOPACK will automatically detect the vibration frequencies and make notch filter or anti-resonance control settings.</li> </ul> <p>Notes:</p> <ul style="list-style-type: none"> <li>If the FF LEVEL is changed when the servomotor is in operation, it will not be reflected immediately. The changes will be effective after the servomotor comes to a stop with no reference input and then the servomotor starts operation. If the FF LEVEL is changed too much during operation, vibration may occur because the responsiveness is changed rapidly when the settings become effective.</li> <li>The message “FF LEVEL” flashes until the machine reaches the effective FF LEVEL. If the servomotor does not stop within approximately 10 seconds after changing the setting, a timeout will occur. The setting will be returned to the previous value.</li> </ul>

(cont'd)

Step	Display after Operation	Keys	Operation
9	<pre> RUN      —OnePrmTun— Pn100=0040.0 Pn101=0020.00 Pn141=0050.0 NF1 </pre>		Press the  Key to display the confirmation screen after level adjustment.
10	<pre> RUN      —OnePrmTun— Pn100=0040.0 Pn101=0020.00 Pn141=0050.0 NF1 </pre>		<ul style="list-style-type: none"> <li>Press the  Key to save the adjusted values. After the data is saved, “DONE” will flash for approximately two seconds and then “RUN” will be displayed.</li> <li>To return to the previous value, press the  Key.</li> <li>Press the  Key to readjust the level without saving the values.</li> </ul>
11	<pre> RUN      —FUNCTION— Fn202:Ref-AAT Fn203:OnePrmTun Fn204:A-Vib Sup Fn205:Vib Sup </pre>		Press the  Key to complete the one-parameter tuning operation. The display returns to the main menu of the utility function mode.

Note: The status display will always be RUN when the servomotor power is ON.



### 3.2.30 Anti-Resonance Control Adjustment Function (Fn204)

This function increases the effectiveness of the vibration suppression after one-parameter tuning. This function is effective in supporting anti-resonance control adjustment if the vibration frequencies are from 100 to 1,000 Hz.

This function rarely needs to be used because it is automatically set by the advanced autotuning or advanced autotuning by reference input. Use this function only if fine-tuning is required, or vibration detection is failed and readjustment is required.

Perform one-parameter tuning (Fn203) or use another method to increase the responsiveness after performing this function. If the anti-resonance gain is increased with one-parameter tuning performed, vibration may result again. If that occurs, perform this function again to fine-tune the settings.

#### CAUTION

- If this function is executed, related parameters will be set automatically. Therefore, there will be a large response change after this function is executed. Enable the function in a state where the machine can come to an emergency stop at any time to ensure the safety operation of the machine.
- Be sure to set a suitable value for the moment of inertia ratio (Pn103) using advanced autotuning before executing the anti-resonance control adjustment function. If the setting greatly differs from the actual moment of inertia ratio, normal control of the machine may not be possible, and vibration may result.



#### IMPORTANT

- This function detects vibration between 100 and 1,000 Hz. Vibration will not be detected for frequencies outside of this range, and instead, “F----” will be displayed. If that occurs, use one-parameter tuning with tuning mode 2 selected to automatically set a notch filter or use the vibration suppression function (Fn205).
- Vibration can be reduced more effectively by increasing the anti-resonance damping gain (Pn163). The amplitude of vibration may become larger if the damping gain is excessively high. Increase the damping gain from about 0% to 200% in 10% increments while checking the effect of vibration reduction. If the effect of vibration reduction is still insufficient at a gain of 200%, cancel the setting, and lower the control gain using a different method, such as one-parameter tuning.

#### (1) Preparation

The following conditions must be met to perform the anti-resonance control adjustment function.

The message “NO-OP” indicating that the settings are not appropriate will be displayed, if all of the following conditions are not met.

3.2.30 Anti-Resonance Control Adjustment Function (Fn204)

- The tuning-less function must be disabled (Pn170.0 = 0).
- The test without a motor function must be disabled (Pn00C.0 = 0).
- The control must not be set to torque control.
- The write prohibited setting (Fn010) must not be set to write-protect parameters.

(2) Operating Procedure













With this function, an operation reference is sent, and the function is executed while vibration is occurring.

The following methods can be used for the anti-resonance control adjustment function.

- Using Anti-Resonance Control for the First Time
  - With Undetermined Vibration Frequency
  - With Determined Vibration Frequency
- For Fine-tuning After Adjusting the Anti-Resonance Control

■ Using Anti-Resonance Control for the First Time







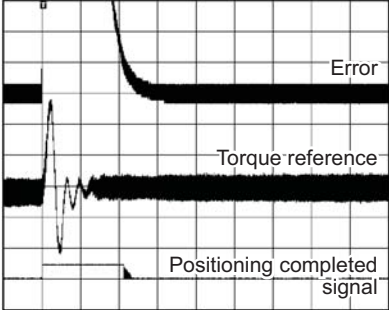





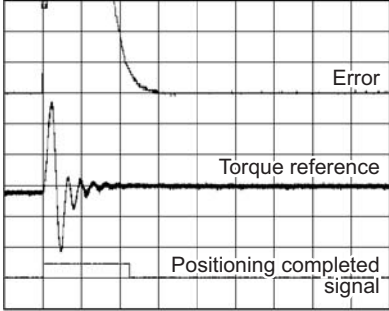

- With Undetermined Vibration Frequency

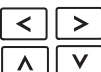
Step	Display after Operation	Keys	Operation
1	<pre> RUN      — FUNCTION — Fn203 : OnePrmTun Fn204 : A-Vib Sup Fn205 : Vib Sup Fn206 : Easy FFT                     </pre>	  	Press the  Key to view the main menu for the utility function mode. Use the  or  Key to move through the list, select Fn204.
2	<p>— Status Display —</p> <pre> RUN — Vib Sup — Tuning Mode = 0                     </pre>		Press the  Key to display the initial setting screen for tuning mode.
3	<pre> RUN      — Vib Sup — Tuning Mode = 0                     </pre>	 	Press the  or  Key and set the tuning mode “0.”























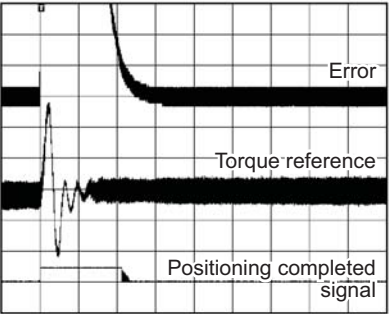

(cont'd)

Step	Display after Operation	Keys	Operation
4	<pre> RUN      - V i b S u p - freq =  - - - -  Hz damp =  0 0 0 0           </pre>	<div style="border: 1px solid black; padding: 2px; display: inline-block;">DATA</div>	<p>Press the <div style="border: 1px solid black; padding: 2px; display: inline-block;">DATA</div> Key while “Tuning Mode = 0” is displayed. The screen shown on the left will appear. The detection of vibration frequencies will start and “freq” will flash. Return to step 3 if vibration is not detected.</p> <p>Note: If vibration is not detected even when vibration is occurring, lower the vibration detection sensitivity (Pn311). When this parameter is lowered, the detection sensitivity will be increased. Vibration may not be detected accurately if too small value is set.</p>
5	<pre> RUN      - V i b S u p - freq =  0 4 0 0  Hz damp =  0 0 0 0           </pre>		<p>The vibration frequency will be displayed in “freq” if vibration is detected.</p>  <p style="text-align: center;">Example of measured waveform</p>
6	<pre> RUN      - V i b S u p - freq =  0 4 0 0  Hz damp =  0 0 0 0           </pre>	<div style="border: 1px solid black; padding: 2px; display: inline-block;">DATA</div>	<p>Press the <div style="border: 1px solid black; padding: 2px; display: inline-block;">DATA</div> Key. The cursor will move to “damp,” and the flashing of “freq” will stop.</p>













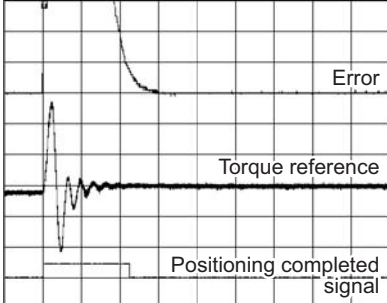

(cont'd)

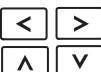
Step	Display after Operation	Keys	Operation
7	<pre> RUN      - Vib Sup - freq = 0400 Hz damp = 012<u>0</u>                     </pre>		<p>Select the digit with the  or  Key, and press the  or  Key to set the damping gain.</p>  <p><b>Example of measured waveform</b>  Note: Increase the damping gain from about 0% to 200% in 10% increments while checking the effect of vibration reduction. If vibration reduction is still insufficient at a gain of 200%, cancel the setting, and lower the control gain by using a different method, such as one-parameter tuning.</p>
8	<pre> RUN      - Vib Sup - freq = 0400 Hz damp = 012<u>0</u>                     </pre>		<p>If fine tuning of the frequency is necessary, press the  Key. The cursor will move from “damp” to “freq.” If fine-tuning is not necessary, skip step 9 and go to step 10.</p>
9	<pre> RUN      - Vib Sup - freq = 0420 Hz damp = 012<u>0</u>                     </pre>		<p>Select the digit with the  or  Key, and press the  or  Key to fine-tune the frequency.</p>
10	<pre> RUN      - Vib Sup - freq = 0420 Hz damp = 0120                     </pre>		<p>Press the  Key to save the settings. “DONE” will flash for approximately two seconds and “RUN” will be displayed.</p>
11	<pre> RUN      -FUNCTION- Fn203: OnePrmTun Fn204: A-Vib Sup Fn205: Vib Sup Fn206: Easy FFT                     </pre>		<p>Press the  Key to complete the anti-resonance control adjustment function. The display returns to the main menu of the utility function mode.</p>































• With Determined Vibration Frequency

Step	Display after Operation	Keys	Operation
1	<pre> RUN      -FUNCTION- Fn203:OnePrmTun Fn204:A-Vib Sup Fn205:Vib Sup Fn206:Easy FFT           </pre>	  	<p>Press the  Key to view the main menu for the utility function mode.</p> <p>Use the  or  Key to move through the list, select Fn204.</p>
2	<pre> RUN      - Vib Sup - Tuning Mode = 0           </pre>		<p>Press the  Key to display the initial setting screen for tuning mode.</p>
3	<pre> RUN      -FUNCTION- Tuning Mode = 1           </pre>	 	<p>Press the  or  Key and set the tuning mode "1."</p>
4	<pre> RUN      - Vib Sup - freq = 0100 Hz damp = 0000           </pre>		<p>Press the  Key while "Tuning Mode = 1" is displayed. The screen shown on the left will appear and "freq" will flash.</p>  <p>Example of measured waveform</p>
5	<pre> RUN      - Vib Sup - freq = 0100 Hz damp = 0000           </pre>	   	<p>Select the digit with the  or  Key, and press the  or  Key to adjust the frequency.</p>
6	<pre> RUN      - Vib Sup - freq = 0400 Hz damp = 000<u>0</u>           </pre>		<p>Press the  Key. The cursor will move to "damp."</p>

(cont'd)

Step	Display after Operation	Keys	Operation
7	<pre> RUN      - Vib Sup - freq = 0400 Hz damp = 0020                     </pre>		<p>Select the digit with the  or  Key, and press the  or  Key to adjust the damping gain.</p>  <p><b>Example of measured waveform</b>  Note: Increase the damping gain from about 0% to 200% in 10% increments while checking the effect of vibration reduction. If vibration reduction is still insufficient at a gain of 200%, cancel the setting, and lower the control gain by using a different method, such as one-parameter tuning.</p>
8	<pre> RUN      - Vib Sup - freq = 0400 Hz damp = 0120                     </pre>		<p>If fine tuning of the frequency is necessary, press the  Key. The cursor will move from “damp” to “freq.” If fine-tuning is not necessary, skip step 9 and go to step 10.</p>
9	<pre> RUN      - Vib Sup - freq = 0400 Hz damp = 0120                     </pre>		<p>Select the digit with the  or  Key, and press the  or  Key to fine-tune the frequency.</p>
10	<pre> RUN      - Vib Sup - freq = 0400 Hz damp = 0120                     </pre>		<p>Press the  Key to save the settings. “DONE” will flash for approximately two seconds and “RUN” will be displayed.</p>
11	<pre> RUN      -FUNCTION- Fn203: OnePrmTun Fn204: A-Vib Sup Fn205: Vib Sup Fn206: Easy FFT                     </pre>		<p>Press the  Key to complete the anti-resonance control adjustment function. The display returns to the main menu of the utility function mode.</p>



### ■ For Fine-tuning After Adjusting the Anti-Resonance Control

Step	Display after Operation	Keys	Operation
1	<pre> RUN      —FUNCTION— Fn203: OnePrmTun Fn204: A-Vib Sup Fn205: Vib Sup Fn206: Easy FFT           </pre>	  	<p>Press the  Key to view the main menu for the utility function mode.</p> <p>Use the  or  Key to move through the list, select Fn204.</p>
2	<pre> RUN      —FUNCTION— Tuning Mode = 1           </pre>		<p>Press the  Key to display the “Tuning Mode = 1” as shown on the left.</p>
3	<pre> RUN      —Vib Sup— freq = 0400 Hz damp = 0120           </pre>		<p>Press the  Key while “Tuning Mode = 1” is displayed. The screen shown on the left will appear and “damp” will flash.</p>
4	<pre> RUN      —Vib Sup— freq = 0400 Hz damp = 01<u>5</u>0           </pre>	   	<p>Select the digit with the  or  Key, and press the  or  Key to set the damping gain.</p> <p>Note: Increase the damping gain from about 0% to 200% in 10% increments while checking the effect of vibration reduction. If vibration reduction is still insufficient at a gain of 200%, cancel the setting, and lower the control gain by using a different method, such as one-parameter tuning.</p>
5	<pre> RUN      —Vib Sup— freq = 0400 Hz damp = 01<u>50</u>           </pre>		<p>If fine tuning of the frequency is necessary, press the  Key. The cursor will move from “damp” to “freq.” If fine-tuning is not necessary, skip step 6 and go to step 7.</p>
6	<pre> RUN      —Vib Sup— freq = 0420 Hz damp = 01<u>50</u>           </pre>	   	<p>Select the digit with the  or  Key, and press the  or  Key to fine-tune the frequency.</p>
7	<pre> RUN      —Vib Sup— freq = 0420 Hz damp = 01<u>50</u>           </pre>		<p>Press the  Key to save the settings. “DONE” will flash for approximately two seconds and “RUN” will be displayed.</p>

### 3 Utility Function Mode

#### 3.2.30 Anti-Resonance Control Adjustment Function (Fn204)

(cont'd)

Step	Display after Operation	Keys	Operation
8	<pre>RUN      —FUNCTION— Fn203: OnePrmTun Fn204: A-Vib Sup Fn205: Vib Sup Fn206: Easy FFT</pre>		Press the  Key to complete the anti-resonance control adjustment function. The display returns to the main menu of the utility function mode.



### 3.2.31 Vibration Suppression Function (Fn205)

This function suppresses transitional vibration at frequency as low as 1 to 100 Hz that is generated mainly when positioning if the machine stand vibrates.

This function is set automatically when advanced autotuning or advanced autotuning by reference is executed. In most cases, this function is not necessary. Use this function only if fine-tuning is required or readjustment is required as a result of a failure to detect vibration.

Perform one-parameter tuning (Fn203) if required to increase the responsiveness after performing this function.

#### CAUTION

- If this function is executed, related parameters will be set automatically. Therefore, there will be a large response change after this function is enabled or disabled. Enable the function in a state where the machine can come to an emergency stop at any time to ensure the safety operation of the machine.
- Be sure to set a suitable value for the moment of inertia ratio (Pn103) using advanced autotuning before executing the vibration suppression function. If the setting greatly differs from the actual moment of inertia ratio, normal control of the SERVOPACK may not be possible, and vibration may result.
- Phase control of the MP2000 Series may not be possible, if the vibration suppression function is performed when using the MP2000 Series with phase control.



#### IMPORTANT

- This function detects vibration frequency between 1 to 100 Hz. Vibration will not be detected for frequencies outside of this range, and instead, "F----" will be displayed.
- Frequency detection will not be performed if no vibration results from position error or the vibration frequencies are outside the range of detectable frequencies. If so, use a device, such as a displacement sensor or vibration sensor, to measure the vibration frequency.
- If vibration frequencies automatically detected are not suppressed, the actual frequency and the detected frequency may differ. Fine-tune the detected frequency if necessary.









3.2.31 Vibration Suppression Function (Fn205)

(1) Preparation











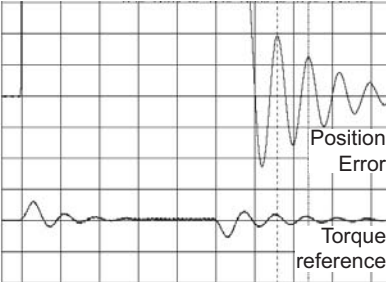

The following conditions must be met to perform the vibration suppression function. The message “NO-OP” indicating that the settings are not appropriate will be displayed, if all of the following conditions are not met.

- The control must be set to position control.
- The tuning-less function must be disabled (Pn170.0 = 0).
- The test without a motor function must be disabled (Pn00C.0 = 0).
- The write prohibited setting (Fn010) must not be set to write-protect parameters.

(2) Operating Procedure

Step	Display after Operation	Keys	Operation
1			Input a operation reference and take the following steps while repeating positioning.
2	<pre> RUN      —FUNCTION— Fn204: A-Vib Sup Fn205: Vib Sup Fn206: Easy FFT Fn207: V-Monitor                     </pre>	  	<p>Press the  Key to view the main menu for the utility function mode.</p> <p>Use the  or  Key to move through the list, select Fn205.</p>
3	<pre> RUN      —Vib Sup— Measure f = 010.4Hz Setting f = 050.4Hz                     </pre>		<p>Press the  Key. The display shown on the left will appear.</p> <p>Measure f: Measurement frequency                  Setting f: Setting frequency [Factory-set to the set value for Pn145]                  If the setting frequency and actual operating frequency are different, “Setting” will flash.                  Note:                  Frequency detection will not be performed if there is no vibration or the vibration frequency is outside the range of detectable frequencies. The following screen will be displayed if vibration is not detected. If the vibration frequencies are not detected, prepare a means of detecting and measuring the vibration. When the vibration frequencies are measured, go to step 5 and manually set the measured vibration frequency to “Setting f.”</p> <pre> RUN      —Vib Sup— Measure f =-----Hz Setting f = 050.0Hz                     </pre>



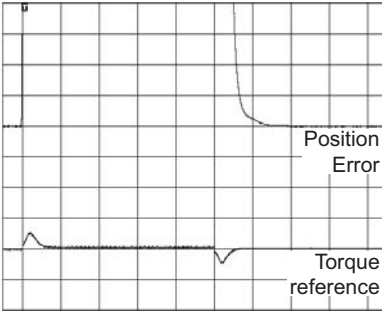

(cont'd)

Step	Display after Operation	Keys	Operation
4	<pre> RUN          -Vib Sup- Measure f=010.4Hz Setting  f=010.4Hz           </pre>		<p>Press the  Key. The displayed “Measure f” value will be displayed as the “Setting f” value as well.</p>  <p>Example of measured waveform</p>
5	<pre> RUN          -Vib Sup- Measure f=010.4Hz Setting  f=012.4Hz           </pre>	   	<p>If the vibration is not completely suppressed, select the digit with the  or  Key, and press the  or  Key to fine-tune the frequency “setting f.” Skip this step and go to step 7 if the fine-tuning of the frequency is not necessary. Note: If the setting frequency and actual operating frequency are different, “Setting” will flash.</p>
6	<pre> RUN          -Vib Sup- Measure f=010.4Hz Setting  f=012.4Hz           </pre>		<p>Press the  Key. The “Setting f” will change to usual display and the frequency currently displayed will be set for the vibration suppression function.</p>  <p>Example of measured waveform</p>

### 3 Utility Function Mode

#### 3.2.31 Vibration Suppression Function (Fn205)

(cont'd)

Step	Display after Operation	Keys	Operation
7	<pre> RUN          -V i b S u p- Measure f   =-----Hz Setting f   =012.4Hz           </pre>		Press the  Key to save the setting. “DONE” will flash for approximately two seconds and “RUN” will be displayed again.
8	<pre> RUN          -FUNCTION- Fn204 Fn205 Fn206 Fn207           </pre>		Press the  Key to complete the vibration suppression function. The display returns to the main menu of the utility function mode.



IMPORTANT

No settings related to the vibration suppression function will be changed during operation.

If the motor does not stop approximately 10 seconds after the setting changes, a timeout error will result and the previous setting will be automatically enabled again.

The vibration suppression function will be enabled in step 6. The motor response, however, will change when the motor comes to a stop with no reference input.

### 3.2.32 EasyFFT (Fn206)

This function sends a frequency waveform reference from the SERVOPACK to the servomotor and rotates the servomotor at very low speed several times over a certain period, thus causing machine vibration. The SERVOPACK detects the resonance frequency from the generated vibration and makes notch filter settings according to the resonance frequency detection. The notch filter is effective for the elimination of high-frequency vibration and noise.

Execute this function after the servomotor power is turned OFF if operation of the SERVOPACK results in high-frequency noise and vibration.

#### WARNING

- The servomotor rotates at very low speed when EasyFFT is executed. Do not touch the servomotor or machine during execution of EasyFFT, otherwise injury may result.

#### CAUTION

- Use the EasyFFT when the servo gain is low, such as in the initial stage of servo adjustment. If EasyFFT is executed after increasing the gain, the servo system may vibrate depending on the machine characteristics or gain balance.







#### (1) Preparation

The following conditions must be met to perform EasyFFT.













- The write prohibited setting (Fn010) must not be set to write-protect parameters.
- The main circuit power supply must be ON.
- All alarms must be cleared.
- The hardwire baseblock (HWBB) must be disabled.
- The servomotor power must be OFF.
- There must be no overtravel.
- The test without a motor function must be disabled (Pn00C.0 = 0).
- An external reference must not be input.

#### (2) Operating Procedure







Use the following procedure.

Step	Display after Operation	Keys	Operation
1	<pre> BB      -FUNCTION- Fn205: Vib Sup Fn206: Easy FFT Fn207: V-Monitor Fn000: Alm History           </pre>	  	<p>Press the  Key to view the main menu for the utility function mode.</p> <p>Use the  or  Key to move through the list and select Fn206.</p>

(cont'd)

Step	Display after Operation	Keys	Operation
2	<pre> BB      -Easy FFT- Setting Input = 015%                     </pre>		<p>Press the  Key. The display changes to the Fn206 execution display.</p> <p>Note: If the display is not switched and “NO-OP” is displayed in the status display, check to make sure that the required operating conditions are being met (<i>I Preparation</i>) and take corrective action.</p>
3	<pre> BB      -Easy FFT- Setting Input = 015%                     </pre>	 	<p>The cursor is on the setting of “Input.”</p> <p>Press the  or  Key to set the sweep torque reference amplitude (Pn456) Setting range: 1 to 800.</p> <p>Note: When making the initial settings for EasyFFT, do not change the setting for the reference amplitude. Start with the original value of 15. Increasing reference amplitude increases the detection accuracy, but the vibration and noise from the machine will increase. Increase the amplitude value little by little.</p>
4	<pre> RUN     -Easy FFT- Ready Input = 015%                     </pre>		<p>Press the  Key to turn the servomotor power ON. The display “BB” and “Setting” changes to “RUN” and “Ready.”</p>
5	<pre> RUN     -Easy FFT- Measure Input = 015%                     </pre>	 	<p>Press the  (forward run start) Key or  (reverse run start) Key to run the servomotor and start the frequency measurement. “Measure” is displayed during the measurement.</p> <p>Within a quarter turn, the servomotor will move forward and then in reverse several times.</p> <p>Note:</p> <ul style="list-style-type: none"> <li>• Press the  Key to cancel the measurement. The servomotor stops moving and the power turns OFF. The detection of the resonance frequency is not completed.</li> <li>• The actions of the servomotor are very minute in this operation. Also at the same time, the servomotor emits a noise. To ensure safety, do not enter the working envelope of the motor.</li> </ul>



(cont'd)

Step	Display after Operation	Keys	Operation
6	<pre> BB      -Easy FFT- Result Input  = 015 % Res    = 1250 Hz Filter1 1375 Hz           </pre>		<p>When the detection processing is successfully completed, “Measure” stops flashing and the results and the notch filter value to be set are displayed. If the processing was not completed, “No Measure” is displayed. To check the results, go to step 8.</p> <p>&lt; Important &gt;</p> <p>If two seconds or more are required for the operation although detection was successfully completed, the detection accuracy might be insufficient. Increasing reference amplitude more than 15 increases the detection accuracy, but the vibration and noise from the machine will increase. Increase the amplitude value little by little.</p> <p>Notes:</p> <ul style="list-style-type: none"> <li>• If a notch filter has been set and is being used, “*” is displayed on the second line.</li> <li>• If the first stage notch filter has been set, the second stage notch filter value is displayed. If the first and second stage notch filters have been set, only the result of frequency detection is displayed.</li> </ul>
7	<pre> BB      -Easy FFT- Ready Input  = 015%           </pre>	 	<p>To exit the EasyFFT function at this stage, press the  Key. The power to the servomotor is turned OFF and the display returns to the utility function mode main menu.</p> <p>To remeasure the vibration frequency, press the  Key to return to step 4. Execute steps 5 to 7.</p>
8	<pre> DONE   -Easy FFT- Result Input  = 015 % Res    = 1250 Hz Filter1 1250 Hz           </pre>		<p>Press the  Key after the normal completion of frequency detection. The notch filter frequencies are automatically updated to the optimum values.</p> <p>The status display shows “DONE” and the display shown on the left appears.</p> <p>If the first stage notch filter frequency has been set (Pn408.0 = 1), the second stage notch filter frequency (Pn 40C) will automatically be updated.</p> <p>Notes:</p> <ul style="list-style-type: none"> <li>• If the first stage or the second stage notch filter frequency has already been set (Pn408 = n.□1□1), the notch filter frequency cannot be set.</li> <li>• If the frequency detected by this function is not used, set the notch filter to be invalid (Pn408.0 = 0).</li> </ul>

### 3 Utility Function Mode

#### 3.2.32 EasyFFT (Fn206)

(cont'd)

Step	Display after Operation	Keys	Operation
9	<pre>BB      -FUNCTION- Fn205:Vib Sup Fn206:Easy FFT Fn207:V-Monitor Fn000:Alm History</pre>		Press the  Key. The servomotor enters a baseblocked status. The display returns to the main menu of the utility function mode.
10	Turn OFF the power and then turn it ON again to validate the new setting.		



### 3.2.33 Online Vibration Monitor (Fn207)

If vibration is generated during operation and this function is executed while the servomotor power is still ON, the machine vibration can sometimes be suppressed by setting a notch filter or torque reference filter for the vibration frequencies.

When online, vibration frequency caused by machine resonance will be detected and the frequency that has the highest peak will be displayed on the panel operator. The effective torque reference filter or notch filter frequency for the vibration frequencies will be automatically selected and the related parameters will be automatically set.

In addition to this function, EasyFFT (Fn206) can be used to detect machine vibration and automatically make notch filter settings.

If a  $\Sigma$ -V Series SERVOPACK is used to make adjustments, it is recommended that you use advanced autotuning. This built-in function is used to maintain interchangeability with previous models. There is normally no need to use it.









#### (1) Preparation

The following conditions must be met to perform online vibration monitoring.











- The write prohibited setting (Fn010) must not be set to write-protect parameters.
- The servomotor power must be ON.
- There must be no overtravel.
- The correct moment of inertia (Pn103) must be set.
- The test without a motor function must be disabled (Pn00C.0 = 0).

#### (2) Operating Procedure

Use the following procedure.

Step	Display after Operation	Keys	Operation
1	<pre> RUN      -FUNCTION- Fn206: Easy FFT Fn207: V-Monitor Fn000: Alm History Fn001: JOG           </pre>	  	<p>Press the  Key to view the main menu for the utility function mode.</p> <p>Use the  or  Key to move through the list and select Fn207.</p>
2	<pre> RUN      -V-MONITOR- Measure F1=----- F2=----- F3=-----           </pre>		<p>Press the  Key.</p> <p>The display changes to the Fn207 execution display.</p> <p>Note: If the display is not switched and “NO-OP” is displayed in the status display, check to make sure that the required operating conditions are being met (<i>(1) Preparation</i>) and take corrective action.</p>

(cont'd)

Step	Display after Operation	Keys	Operation
3	<pre> RUN      -V-MONITOR- Measure F1=----- F2=----- F3=-----                     </pre>		<p>Press the  Key for at least one second to start vibration detection. The  Key must be pressed until “Measure” flashes on the display. After this message appears, the  Key does not have to be pressed and the detection continues automatically.</p>
4	<pre> RUN      -V-MONITOR- Measure F1= 0850 [Hz] F2= 1600 [Hz] F3= 0225 [Hz]                     </pre>		<p>When the vibration detection has completed, “Measure” stops flashing and the detection processing ends automatically. When the detection processing has completed normally, the vibrations with three largest peak values in vibration frequency are displayed for F1, F2, and F3.</p> <p>Notes:</p> <ul style="list-style-type: none"> <li>• Press the  Key to quit the online vibration monitor function. The display returns to the main menu of the utility function mode.</li> <li>• A detected frequency can be displayed. For a vibration with undetectable peak frequency, “----” is displayed. If no frequency was detected, “----” is displayed for F1, F2, and F3.</li> <li>• If the frequency could not be successfully detected, “NO MONITOR” is displayed.</li> </ul>
5	<pre> DONE     -V-MONITOR- SETTING DONE F1= 0850 [Hz] F2= 1600 [Hz] F3= 0225 [Hz]                     </pre>		<p>After the detection has normally completed, press the  Key. The optimum frequency (time constant) of notch filter or torque reference filter for F1 is set automatically. At the same time, the parameter Pn409 is updated for a notch filter, or the parameter Pn401 is updated for a torque reference filter. After the setting is successfully completed, “DONE” flashes.</p>
6	<pre> RUN      -FUNCTION- Fn206: Easy FFT Fn207: V-Monitor Fn000: Alm History Fn001: JOG                     </pre>		<p>Press the  Key. The display returns to the main menu of the utility function mode.</p>

---

## Parameter Copy Mode

4.1 Outline .....	4-2
4.2 Operations .....	4-3
4.2.1 Read-out Parameters from SERVOPACK (SERVO → OP) .....	4-3
4.2.2 Write-in Parameters (OP → SERVO) .....	4-6
4.2.3 Verify Parameters (VERIFY) .....	4-9
4.2.4 Parameter Block List Display (LIST) .....	4-12

## 4.1 Outline

The JUSP-OP05A-1-E digital operator has a storage area of seven blocks of parameters with one block per SERVOPACK. The parameter copy mode can operate parameter blocks to save parameters.

### Parameter Copy Mode Menus and Functions

The following four functions can be executed in parameter copy mode.

Menu Display	Function
1: SERVO → OP	Copies the SERVOPACK parameters to the digital operator.
2: OP → SERVO	Copies the parameters saved in the digital operator to the SERVOPACK.
3: VERIFY	Verifies the parameters in the SERVOPACK and the digital operator, and displays the result.
4: LIST	Displays the parameter blocks saved in the digital operator.

Some restrictions apply to the copying function and the verifying function. These restrictions must be taken into consideration when using these functions.

When any software program of a SERVOPACK is upgraded and new parameters are added, restrictions apply to the copying function (OP → SERVO) and the verifying function (VERIFY) used between an earlier version and a later version. Details of the restrictions are as follows.

- When using the copying function to copy an earlier version of parameters stored in the digital operator and then save them in a SERVOPACK that uses a later version of the program, or when using the verifying function to compare these versions of parameters, new parameters added in the later version will remain as is and will not be verified.
- When using the copying function to copy a later version of parameters stored in the digital operator and then save them in a SERVOPACK that uses an earlier version of the program, or when using the verifying function to compare these versions of parameters, the following restrictions and precautions apply.

<when the earlier version of the software in the SERVOPACK is 0023 or later>

The error message "UnmatchedParameters" will be displayed, and the parameters will not be copied or verified.

<when the earlier version of the software in the SERVOPACK is 0022 or earlier>



Do not use the copying function (OP → SERVO) and the verifying function (VERIFY).

For more information on software versions, refer to *3.2.17 Software Version Display (Fn012)*.

## 4.2 Operations

This section describes the operation method on the execution display selected from the main menu of the parameter copy mode.

Press the  Key to display the parameter copy mode menu.

Press the  or  Key to select a menu to be executed, and press the  Key to switch the display to the corresponding menu execution display.











### Parameter Copy Mode Menu Display

B B	- COPY -	
1 : <u>SERVO → OP</u>		← The selected menu blinks.
2 : OP → SERVO		
3 : VERIFY		
4 : LIST		

### 4.2.1 Read-out Parameters from SERVOPACK (SERVO → OP)

This function reads out the parameters saved in the SERVOPACK, and saves in the storage area (one of seven blocks) in the digital operator.









#### (1) Operating Procedure

Step	Display after Operation	Keys	Operation
1	<pre> B B                - COPY - 1 : <u>SERVO → OP</u> 2 : OP → SERVO 3 : VERIFY 4 : LIST           </pre>	 	Open the parameter copy mode menu display, and select "SERVO → OP" using the  or  Key. The selected menu is blinking.
2	<pre> B B                - SERVO → OP - 0 0 : * * * * 0 1 : * * * * 0 2 : * * * * 0 3 : * * * *           </pre>		Press the  Key. The display changes to the parameter block selection display.
3	<pre> B B                - SERVO → OP - 0 0 : * * * * 0 1 : * * * * 0 2 : * * * * 0 3 : * * * *           </pre>	 	Press the  or  Key to select a parameter block (00 to 06) of the digital operator in which the parameters read out from the SERVOPACK are to be saved.

## 4 Parameter Copy Mode

### 4.2.1 Read-out Parameters from SERVOPACK (SERVO → OP)

(cont'd)

Step	Display after Operation	Keys	Operation
4	<pre> BB      -SERVO→OP- 00:**** Start : [READ] Return: [MODE]           </pre>		Press the  Key. The display changes to the execution display.
5	<pre> BB      -SERVO→OP- 00:**** Reading Parameters.. &lt;&lt; SERVO &gt;&gt;           </pre>	 	Press the  Key to start reading parameters from the SERVOPACK. Note: Press the  Key not to execute reading. The display returns to the parameter block selection display.
6	<pre> BB      -SERVO→OP- 00:****  Completed           </pre>		When the parameters have been read out from the SERVOPACK, “Completed” is displayed.
7	<pre> BB      -SERVO→OP- 00:SGDV-R70 01:**** 02:**** 03:****           </pre>		When the parameters were read out and “Completed” is displayed, the display returns to the parameter block selection display. At this moment, the SERVOPACK model number is displayed for the selected block (“SGDV-R70” in the display on the left).
8	<pre> BB      -COPY- 1:SERVO→OP 2:OP→SERVO 3:VERIFY 4:LIST           </pre>		Press the  Key. The display returns to the parameter copy mode menu display.

## (2) Notes on Read-out Parameters Function

- If the parameter block which has been already saved is selected, and read-out parameter function is executed, the parameter block is overwritten.
- Press the  Key to cancel the operation while reading parameters. “Canceled” is displayed and the display returns to the parameter block selection display.
- When the reading operation is cancelled, or the digital operator is disconnected from the SERVOPACK during reading operation, the selected parameter block becomes empty block (“\*\*\*\*”).
- During reading operation, the executing process is displayed sequentially as shown below. The reading operation takes about 10 seconds.
- When the reading operation is completed, a part of the SERVOPACK model number is registered as the name of block where the parameters are saved. The blocks whose parameters were read out from the same SERVOPACK have the same name.

While the parameters are being read out from the SERVOPACK

```

BB          - S E R V O → O P -
00 : * * * *
      R e a d i n g
      P a r a m e t e r s . .
  
```



Reading operation cancelled

```

BB          - S E R V O → O P -
00 : * * * *
      C a n c e l e d
  
```

Reading operation completed















```

BB          - S E R V O → O P -
00 : S G D V - R 7 0
      C o m p l e t e d
  
```

### 4.2.2 Write-in Parameters (OP → SERVO)



The selected block of parameters saved in the digital operator are written into the SERVOPACK.

#### (1) Operating Procedure

Step	Display after Operation	Keys	Operation
1	<pre> BB          - COPY - 1:SERVO→OP 2:OP→SERVO 3:VERIFY 4:LIST                     </pre>	 	<p>Open the parameter copy mode menu display, and select “OP → SERVO” using the  or  Key. The blinking menu is one that is being selected.</p>
2	<pre> BB          - OP→SERVO - 00:SGDV-R70 01:***** 02:***** 03:*****                     </pre>		<p>Press the  Key. The display changes to the parameter block selection display.</p>
3	<pre> BB          - OP→SERVO - 00:SGDV-R70 01:***** 02:***** 03:*****                     </pre>	 	<p>Press the  or  Key to select a parameter block (00 to 06) of the digital operator that is to be written into the SERVOPACK.</p>
4	<pre> BB          - OP→SERVO - 00:SGDV-R70 Start : [WRITE] Return: [MODE]                     </pre>		<p>Press the  Key. The display changes to the execution display.</p>
5	<pre> BB          - OP→SERVO - 00:SGDV-R70 Reading Parameters.. &lt;&lt; OP &gt;&gt;                     </pre>		<p>Press the  Key to start writing parameters into the SERVOPACK.                      Note: While the power to the servomotor is ON (RUN) and the Write Prohibited Setting (Fn010 = 0001) is set, the  Key is disabled and “Not Available” is displayed if it is pressed.</p>



(cont'd)

Step	Display after Operation	Keys	Operation
6	<pre>A . 9 4 1   - O P → S E R V O - 0 0 : S G D V - R 7 0      C o m p l e t e d</pre>		<p>When the parameters were read out from the specified block in digital operator, and saved in the SERVOPACK, “Completed” is displayed. And A.941 “Change of Parameters Requires the Setting Validation” is displayed.</p>
7	<pre>A . 9 4 1   - O P → S E R V O - <u>0 0 : S G D V - R 7 0</u> 0 1 : * * * * 0 2 : * * * * 0 3 : * * * *</pre>		<p>When the parameters were written and saved, “Completed” is displayed, and then the parameter block selection display appears.</p>
8	<pre>A . 9 4 1           - C O P Y - 1 : S E R V O → O P <u>2 : O P → S E R V O</u> 3 : V E R I F Y 4 : L I S T</pre>		<p>Press the  Key. The display returns to the parameter copy mode menu display. Turn OFF the power and turn ON again to clear A.941.</p>

(2) Notes on Write-in Parameters Function

- Do not disconnect the digital operator from the SERVOPACK while the parameters are being written in. Otherwise, the writing process is cancelled, and a part of parameters are not written in. In such case, re-execute the writing operation. Turning the power OFF then ON before re-executing the writing operation may cause a Parameter Checksum Error (A.020) or Parameter Setting Error (A.040). To clear an alarm, execute Fn005 “Initialize Parameter Settings.”
- If an empty block (“\*\*\*\*”) is selected and the Write-in Parameter function is executed, the message “No Data” is displayed and the writing will not be executed.
- Writing a parameter block to a SERVOPACK with a different voltage and capacity displays the message “Unmatched Parameters” and the parameters cannot be written.
- If the servo is turned ON, “Not Available” will appear for the Write-prohibit setting, and the parameters cannot be written.
- While writing in parameters, the steps are displayed in sequence as they are being processed. The SERVOPACK can write in parameters in 10 seconds.
- After the parameter block has been written into the SERVOPACK, turn the power OFF then ON again. The servo ON input signal is invalid until the setting validation is executed.

While reading the parameters from the digital operator

```

BB      -OP→SERVO-
00:SGDV-R70
      Reading
      Parameters..
<< OP >>
    
```

While writing the parameters into the SERVOPACK

```

A.941  -OP→SERVO-
00:SGDV-R70
      Writing
      Parameters..
<< SERVO >>
    
```

Note: While this display is on screen, the operation is not cancelled by pressing the  Key.

Operation completed

```

















A.941  -OP→SERVO-
00:SGDV-R70

      Completed
    
```

### 4.2.3 Verify Parameters (VERIFY)

The parameters of the selected block saved in the digital operator and those in the SERVOPACK are verified, and the result is displayed.









#### (1) Operating Procedure

Step	Display after Operation	Keys	Operation
1	<pre> BB                - COPY - 1: SERVO → OP 2: OP → SERVO 3: VERIFY 4: LIST </pre>	 	<p>Open the parameter copy mode menu display, and select “VERIFY” using the  or  Key.</p> <p>The blinking menu is one that is being selected.</p>
2	<pre> BB                - VERIFY - 00: SGDV-R70 01: ***** 02: ***** 03: ***** </pre>		<p>Press the  Key.</p> <p>The display changes to the parameter block selection display.</p>
3	<pre> BB                - VERIFY - 00: SGDV-R70 01: ***** 02: ***** 03: ***** </pre>	 	<p>Press the  or  Key to select a parameter block (00 to 06) of the digital operator that is to be compared with the SERVOPACK parameters.</p>
4	<pre> BB                - VERIFY - 00: SGDV-R70 Start : [READ] Return: [MODE] </pre>		<p>Press the  Key.</p> <p>The display changes to the execution display.</p>
5	<pre> BB                - OP → SERVO - 00: SGDV-R70 Reading Parameters.. &lt;&lt; OP &gt;&gt; </pre>	 	<p>Press the  Key to start verifying parameters.</p> <p>Note: Not to execute verifying, press the  Key. The display returns to the parameter block selection display.</p>



## 4 Parameter Copy Mode

### 4.2.3 Verify Parameters (VERIFY)

(cont'd)

Step	Display after Operation	Keys	Operation
6	<pre> BB          - VERIFY - 00:SGDV-R70  Completed                     </pre>		<p>When the verification of the parameters read out from the digital operator, the parameters read out from the SERVOPACK, and the verification is completed, "Completed" is displayed.</p>
7	<p>When all parameters are matched.</p> <pre> BB          - VERIFY -  All Parameters are matched                     </pre> <p>When unmatched parameters are found.</p> <pre> BB          - VERIFY - Pn001 Pn100      Unmatched Pn101      Parameters Pn202                     </pre>	<p> </p>	<p>The verification result is displayed. If any unmatched parameters were found, these unmatched parameter numbers are displayed in a list. Press the  or  Key to scroll the screen to display all the unmatched parameter numbers. (five numbers can be displayed at once.)</p> <p>Pn*** among the displayed unmatched parameters are the reserved parameters for the SERVOPACK.</p>
8	<pre> BB          - VERIFY - 00:SGDV-R70 01:***** 02:***** 03:*****                     </pre>	<p></p>	<p>Press the  Key. The parameter block selection display appears.</p>
9	<pre> BB          - COPY - 1:SERVO→OP 2:OP→SERVO 3:VERIFY 4:LIST                     </pre>	<p></p>	<p>Press the  Key. The display returns to the parameter copy mode menu display.</p>

## (2) Notes on Verify Parameters Function

- If an empty block (“\*\*\*\*”) is selected and the verify function is executed, the message “No Data” is displayed, and the verification will not be executed. Press the  Key to return to the parameter block selection display.
- Pressing the  Key to cancel the operation while verifying parameters. “Canceled” is displayed, and the display returns to the parameter block selection display.
- During verification operation, the executing process is displayed sequentially as shown below. The verification takes about 10 seconds.
- If parameter matching is executed with a parameter block that differs from the model of the SERVOPACK, the message “unmatched parameters” will appear and matching will not be executed.

While reading the parameters from the digital operator

```

BB          -VERIFY-
00:SGDV-R70
  Reading
  Parameters..
<< OP >>

```



Operation cancelled

```

BB          -VERIFY-
00:****
      Canceled

```

In verification process

```

BB          -VERIFY-
00:SGDV-R70
  Verifying
  Parameters..
<< OP-SERVO >>

```

Operation completed

```

BB          -VERIFY-
00:SGDV-R70















      Completed

```



### 4.2.4 Parameter Block List Display (LIST)

The statuses of one of seven parameter blocks in the storage area of digital operator are displayed in a list, and unnecessary parameter blocks can be deleted.

#### (1) Operating Procedure

Step	Display after Operation	Keys	Operation
1	<pre> BB                - COPY - 1:SERVO → OP 2:OP → SERVO 3:VERIFY 4:LIST           </pre>	 	<p>Open the parameter copy mode menu display, and select “LIST” using the  or  Key.</p> <p>The blinking menu is one that is being selected.</p>
2	<pre> BB                - LIST - 00:SGDV-R70 01:**** 02:**** 03:****           </pre>		<p>Press the  Key.</p> <p>The display changes to the parameter block selection display.</p>
3	<pre> BB                - LIST - 00:SGDV-R70 01:**** 02:**** 03:****           </pre>	 	<p>Press the  or  Key to select a parameter block (00 to 06) of the digital operator that is to be deleted.</p>
4	<pre> BB                - LIST - 00:SGDV-R70 FILE DELETE Start : [WRITE] Return: [MODE]           </pre>		<p>Press the  Key.</p> <p>The display is switched to the deletion execution display.</p>
5	<pre> BB                - LIST - 00:SGDV-R70 Deleting Parameters..           </pre>		<p>Press the  Key to start deleting the parameter block.</p> <p>If power is supplied to the motor and RUN is displayed, “Not Available” will be displayed when the  Key is pressed. In this case, writing into SERVOPACK will be disabled.</p>

(cont'd)

Step	Display after Operation	Keys	Operation
6	<pre> BB                - LIST - 00:SGDV-R70  Completed </pre>		When the selected parameter block is deleted, "Completed" is displayed.
7	<pre> BB                - LIST - 00:**** 01:**** 02:**** 03:**** </pre>		After "Completed" is displayed, the parameter block selection display appears. "****" is displayed for the deleted block as an empty block.
8	<pre> BB                - COPY - 1:SERVO→OP 2:OP→SERVO 3:VERIFY 4:LIST </pre>		Press the  Key. The display returns to the parameter copy mode menu display.

## (2) Notes on Deleting Parameters Function

- If an empty block ("\*\*\*\*") is selected and the deletion is executed, the message "No Data" is displayed and the deletion will not be executed. Press the  Key to return to the parameter block selection display.
- If the digital operator is disconnected from the SERVOPACK during operation, the selected parameter block becomes an empty block ("\*\*\*\*").
- During deleting operation, the executing process is displayed sequentially as shown below. The deleting operation takes about 2 seconds.

While deleting the selected parameter block

```

BB                - LIST -
00:SGDV-R70
  Deleting
  Parameters..

```

Operation completed

```

BB                - LIST -
00:SGDV-R70

Completed

```

# Revision History

The revision dates and numbers of the revised manuals are given on the bottom of the back cover.

MANUAL NO. SIEP S800000 55A <1>-1  
 └───┬─── WEB revision number  
 └───┬─── Revision number  
 Published in Japan September 2009  
 └─── Date of publication

Date of Publication	Rev. No.	WEB REV. No.	Section	Revised Contents
January 2020	<12>	1	Preface	Revision: ■ Disposal precaution
			Back cover	Revision: Address
December 2018		0	Back cover	Revision: Address
October 2017	<11>	0	–	Printed version of the manual that is available on the web (web version: SIEP S800000 55B<10>-1)
July 2017	<10>	1	3.2.5	Revision: Operating procedure
			Back cover	Revision: Address
April 2016		0	Back cover	Revision: Address
June 2015	<9>	0	Front cover	Revision: Format
			Back cover	Revision: Address, format
February 2015	<8>	0	Back cover	Revision: Address
June 2013	<7>	0	Back cover	Revision: Address
July 2012	<6>	0	Back cover	Revision: Address
January 2012	<5>	0	Back cover	Revision: Address
April 2011	<4>	0	All chapters	Completely revised
October 2010	<3>	0	Front cover	Revision: Format
			Back cover	Revision: Address, format
August 2010	<2>	0	Back cover	Revision: Address
				Addition: Original instructions
September 2009	<1>	1	Preface	Addition: Warranty
			Back cover	Revision: Address
June 2009		0	Back cover	Revision: Address
April 2007	–	–	–	First edition



# AC Servo Drives

# $\Sigma$ -V Series

# USER'S MANUAL

## Operation of Digital Operator

---

#### **IRUMA BUSINESS CENTER (SOLUTION CENTER)**

480, Kamifujisawa, Iruma, Saitama, 358-8555, Japan  
Phone: +81-4-2962-5151 Fax: +81-4-2962-6138  
www.yaskawa.co.jp

#### **YASKAWA AMERICA, INC.**

2121, Norman Drive South, Waukegan, IL 60085, U.S.A.  
Phone: +1-800-YASKAWA (927-5292) or +1-847-887-7000 Fax: +1-847-887-7310  
www.yaskawa.com

#### **YASKAWA ELÉTRICO DO BRASIL LTDA.**

777, Avenida Piraporinha, Diadema, São Paulo, 09950-000, Brasil  
Phone: +55-11-3585-1100 Fax: +55-11-3585-1187  
www.yaskawa.com.br

#### **YASKAWA EUROPE GmbH**

Hauptstraße 185, 65760 Eschborn, Germany  
Phone: +49-6196-569-300 Fax: +49-6196-569-398  
www.yaskawa.eu.com E-mail: info@yaskawa.eu.com

#### **YASKAWA ELECTRIC KOREA CORPORATION**

35F, Three IFC, 10 Gukjegeumyung-ro, Yeongdeungpo-gu, Seoul, 07326, Korea  
Phone: +82-2-784-7844 Fax: +82-2-784-8495  
www.yaskawa.co.kr

#### **YASKAWA ASIA PACIFIC PTE. LTD.**

30A, Kallang Place, #06-01, 339213, Singapore  
Phone: +65-6282-3003 Fax: +65-6289-3003  
www.yaskawa.com.sg

#### **YASKAWA ELECTRIC (THAILAND) CO., LTD.**

59, 1F-5F, Flourish Building, Soi Ratchadapisek 18, Ratchadapisek Road, Huaykwang, Bangkok, 10310, Thailand  
Phone: +66-2-017-0099 Fax: +66-2-017-0799  
www.yaskawa.co.th

#### **YASKAWA ELECTRIC (CHINA) CO., LTD.**

22F, Link Square 1, No.222, Hubin Road, Shanghai, 200021, China  
Phone: +86-21-5385-2200 Fax: +86-21-5385-3299  
www.yaskawa.com.cn

#### **YASKAWA ELECTRIC (CHINA) CO., LTD. BEIJING OFFICE**

Room 1011, Tower W3 Oriental Plaza, No.1, East Chang An Avenue,  
Dong Cheng District, Beijing, 100738, China  
Phone: +86-10-8518-4086 Fax: +86-10-8518-4082

#### **YASKAWA ELECTRIC TAIWAN CORPORATION**

12F, No. 207, Section 3, Beishin Road, Shindian District, New Taipei City 23143, Taiwan  
Phone: +886-2-8913-1333 Fax: +886-2-8913-1513 or +886-2-8913-1519  
www.yaskawa.com.tw

---

# YASKAWA

YASKAWA ELECTRIC CORPORATION

In the event that the end user of this product is to be the military and said product is to be employed in any weapons systems or the manufacture thereof, the export will fall under the relevant regulations as stipulated in the Foreign Exchange and Foreign Trade Regulations. Therefore, be sure to follow all procedures and submit all relevant documentation according to any and all rules, regulations and laws that may apply. Specifications are subject to change without notice for ongoing product modifications and improvements.

© 2007 YASKAWA ELECTRIC CORPORATION

MANUAL NO. SIEP S800000 55B <12>-1  
Published in Japan January 2020  
19-10-16  
Original instructions