

AC Servo Drives

DC Power Input Σ -V Series

USER'S MANUAL

Design and Maintenance

Rotational Motor

MECHATROLINK-II Communications Reference

SGMMV Servomotor
SGDV SERVOPACK

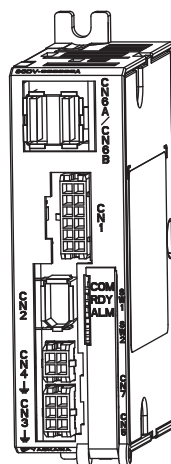

Outline	1
SigmaWin+	2
Wiring and Connection	3
Operation	4
Adjustments	5
Utility Functions (Fn□□□)	6
Monitor Displays (Un□□□)	7
Troubleshooting	8
Appendix	9

Copyright © 2011 YASKAWA ELECTRIC CORPORATION

All rights reserved. No part of this publication may be reproduced, stored in a retrieval system, or transmitted, in any form, or by any means, mechanical, electronic, photocopying, recording, or otherwise, without the prior written permission of Yaskawa. No patent liability is assumed with respect to the use of the information contained herein. Moreover, because Yaskawa is constantly striving to improve its high-quality products, the information contained in this manual is subject to change without notice. Every precaution has been taken in the preparation of this manual. Nevertheless, Yaskawa assumes no responsibility for errors or omissions. Neither is any liability assumed for damages resulting from the use of the information contained in this publication.

About this Manual

This manual describes information required for designing, testing, adjusting, and maintaining DC Power Input Σ -V Series SERVOPACKs.

Keep this manual in a location where it can be accessed for reference whenever required. Manuals outlined on the following page must also be used as required by the application.

■ Description of Technical Terms

The following table shows the meanings of terms used in this manual.

Term	Meaning
Servomotor	Σ -Vmini Series SGMMV servomotor
SERVOPACK	DC Power Input Σ -V Series SGD _V servo amplifier
Servo Drive	A set including a servomotor and SERVOPACK (i.e., a servo amplifier)
Servo System	A servo control system that includes the combination of a servo drive with a host controller and peripheral devices
M-II Model	MECHATROLINK-II communications reference used for SERVOPACK interface
Servo ON	Power to motor ON
Servo OFF	Power to motor OFF
Base Block (BB)	Power supply to motor is turned OFF by shutting off the base current to the power transistor in the current amplifier.
Servo Lock	A state in which the motor is stopped and is in position loop with a position reference of 0.
Main Circuit Cable	Cables which connect to the main circuit terminals, including power supply cables, servomotor main circuit cables, and others.

■ IMPORTANT Explanations

The following icon is displayed for explanations requiring special attention.



IMPORTANT

- Indicates important information that should be memorized, as well as precautions, such as alarm displays, that do not involve potential damage to equipment.

■ Notation Used in this Manual

• Notation for Reverse Signals

The names of reverse signals (i.e., ones that are valid when low) are written with a forward slash (/) before the signal name.

Notation Example

\overline{BK} = /BK

• Notation for Parameters

The notation depends on whether the parameter requires a value setting (parameter for numeric settings) or requires the selection of a function (parameter for selecting functions).

• Parameters for Numeric Settings

Control methods for which the parameter applies.					
		Speed	Position	Torque	
Pn406	Emergency Stop Torque				
	Setting Range	Setting Unit	Factory Setting	When Enabled	Classification
	0% to 800%	1%	800	After change	Setup

Parameter number

Indicates the setting range for the parameter.

Indicates the minimum setting unit for the parameter.

Indicates the parameter setting before shipment.

Indicates when a change to the parameter will be effective.

Indicates the parameter classification.

• Parameters for Selecting Functions

Parameter	Meaning	When Enabled	Classification
Pn002	n.□0□□ [Factory setting]	After restart	Setup
	n.□1□□		

Parameter number

The notation "n.□□□□" indicates a parameter for selecting functions. Each □ corresponds to the setting value of that digit. The notation shown here means that the third digit is 1.

This section explains the selections for the function.

Notation Example

(Display Example for Pn002)

n. 0 0 0 0	Digit Notation		Setting Notation	
	Notation	Meaning	Notation	Meaning
→ 1st digit	Pn002.0	Indicates the value for the 1st digit of parameter Pn002.	Pn002.0 = x or n.□□□x	Indicates that the value for the 1st digit of parameter Pn002 is x.
→ 2nd digit	Pn002.1	Indicates the value for the 2nd digit of parameter Pn002.	Pn002.1 = x or n.□□x□	Indicates that the value for the 2nd digit of parameter Pn002 is x.
→ 3rd digit	Pn002.2	Indicates the value for the 3rd digit of parameter Pn002.	Pn002.2 = x or n.□x□□	Indicates that the value for the 3rd digit of parameter Pn002 is x.
→ 4th digit	Pn002.3	Indicates the value for the 4th digit of parameter Pn002.	Pn002.3 = x or n.x□□□	Indicates that the value for the 4th digit of parameter Pn002 is x.

■ Manuals Related to the DC Power Input Σ -V Series

Refer to the following manuals as required.

Name	Selecting Models and Peripheral Devices	Ratings and Specifications	System Design	Panels and Wiring	Trial Operation	Trial Operation and Servo Adjustment	Maintenance and Inspection
DC Power Input Σ -V Series User's Manual Setup Rotational Motor (No.: SIEP S800000 80)				✓	✓		
Σ -V Series Product Catalog (No.: KAEP S800000 42)	✓	✓	✓				
DC Power Input Σ -V Series User's Manual Design and Maintenance Rotational Motor/ MECHATROLINK-II Communications Reference (this manual)			✓		✓	✓	✓
Σ -V Series User's Manual MECHATROLINK-II Commands (No.: SIEP S800000 54)			✓		✓	✓	
DC Power Input Σ -V Series AC SERVOPACK SGD V Safety Precautions (No.: TOBP C710829 06)	✓			✓			✓
AC SERVOMOTOR Safety Precautions (No.: TOBP C230200 00)				✓			✓

■ Trademarks

MECHATROLINK is a trademark of the MECHATROLINK Members Association.

■ Safety Information

The following conventions are used to indicate precautions in this manual. Failure to heed precautions provided in this manual can result in serious or possibly even fatal injury or damage to the products or to related equipment and systems.



Indicates precautions that, if not heeded, could possibly result in loss of life or serious injury.



Indicates precautions that, if not heeded, could result in relatively serious or minor injury, damage to the product, or faulty operation. In some situations, the precautions indicated could have serious consequences if not heeded.



Indicates prohibited actions that must not be performed. For example, this symbol would be used to indicate that fire is prohibited as follows:





Indicates compulsory actions that must be performed. For example, this symbol would be used to indicate that grounding is compulsory as follows:



Safety Precautions

This section describes important precautions that must be followed during storage, transportation, installation, wiring, operation, maintenance, inspection, and disposal. Be sure to always observe these precautions thoroughly.

WARNING

- Never touch any rotating servomotor parts during operation.
Failure to observe this warning may result in injury.
- Before starting operation with a machine connected, make sure that an emergency stop can be applied at any time.
Failure to observe this warning may result in injury or damage to the equipment.
- Never touch the inside of the SERVOPACKs.
Failure to observe this warning may result in electric shock.
- Immediately after the power is turned OFF or after a voltage resistance test, do not touch terminals.
Residual voltage may cause electric shock.
- Follow the procedures and instructions provided in the manuals for the products being used in the trial operation.
Failure to do so may result not only in faulty operation and damage to equipment, but also in personal injury.
- The multiturn limit value need not be changed except for special applications.
Changing it inappropriately or unintentionally can be dangerous.
- If the Multiturn Limit Disagreement alarm occurs, check the setting of parameter Pn205 in the SERVOPACK to be sure that it is correct.
If Fn013 is executed when an incorrect value is set in Pn205, an incorrect value will be set in the encoder. The alarm will disappear even if an incorrect value is set, but incorrect positions will be detected, resulting in a dangerous situation where the machine will move to unexpected positions.
- Do not remove the cables or connectors from the SERVOPACK while the power is ON.
Failure to observe this warning may result in electric shock.
- Do not damage, pull, exert excessive force on, or place heavy objects on the cables.
Failure to observe this warning may result in electric shock, stopping operation of the product, or fire.
- Do not modify the product.
Failure to observe this warning may result in injury, damage to the equipment, or fire.
- Provide appropriate braking devices on the machine side to ensure safety. The holding brake on a servomotor with a brake is not a braking device for ensuring safety.
Failure to observe this warning may result in injury.
- Do not come close to the machine immediately after resetting an instantaneous power interruption to avoid an unexpected restart. Take appropriate measures to ensure safety against an unexpected restart.
Failure to observe this warning may result in injury.
-  Connect the ground terminal according to local electrical codes (100 Ω or less).
Improper grounding may result in electric shock or fire.
-  Installation, disassembly, or repair must be performed only by authorized personnel.
Failure to observe this warning may result in electric shock or injury.

■ Storage and Transportation



CAUTION

- Do not store or install the product in the following locations.
Failure to observe this caution may result in fire, electric shock, or damage to the equipment.
 - Locations subject to direct sunlight
 - Locations subject to temperatures outside the range specified in the storage/installation temperature conditions
 - Locations subject to humidity outside the range specified in the storage/installation humidity conditions
 - Locations subject to condensation as the result of extreme changes in temperature
 - Locations subject to corrosive or flammable gases
 - Locations subject to dust, salts, or iron dust
 - Locations subject to exposure to water, oil, or chemicals
 - Locations subject to shock or vibration
- Do not hold the product by the cables, motor shaft, or encoder while transporting it.
Failure to observe this caution may result in injury or malfunction.
- Do not place any load exceeding the limit specified on the packing box.
Failure to observe this caution may result in injury or malfunction.
- If disinfectants or insecticides must be used to treat packing materials such as wooden frames, pallets, or plywood, the packing materials must be treated before the product is packaged, and methods other than fumigation must be used.
Example: Heat treatment, where materials are kiln-dried to a core temperature of 56°C for 30 minutes or more.

If the electronic products, which include stand-alone products and products installed in machines, are packed with fumigated wooden materials, the electrical components may be greatly damaged by the gases or fumes resulting from the fumigation process. In particular, disinfectants containing halogen, which includes chlorine, fluorine, bromine, or iodine can contribute to the erosion of the capacitors.

■ Installation



CAUTION

- Never use the product in an environment subject to water, corrosive gases, flammable gases, or combustibles.
Failure to observe this caution may result in electric shock or fire.
- Do not step on or place a heavy object on the product.
Failure to observe this caution may result in injury or malfunction.
- Do not cover the inlet or outlet ports and prevent any foreign objects from entering the product.
Failure to observe this caution may cause internal elements to deteriorate resulting in malfunction or fire.
- Be sure to install the product in the correct direction.
Failure to observe this caution may result in malfunction.
- Provide the specified clearances between the SERVOPACK and the control panel or with other devices.
Failure to observe this caution may result in fire or malfunction.
- Do not apply any strong impact.
Failure to observe this caution may result in malfunction.

■ Wiring

CAUTION

- Be sure to wire correctly and securely.
Failure to observe this caution may result in motor overrun, injury, or malfunction.
- Do not connect a commercial power supply to the U, V, or W terminals for the servomotor connection.
Failure to observe this caution may result in injury or fire.
- Securely connect the main circuit terminals.
Failure to observe this caution may result in fire.
- Do not bundle or run the servomotor main circuit cables together with the I/O signal cables or the encoder cables in the same duct. Keep the servomotor main circuit cables separated from the I/O signal cables and encoder cables by at least 30 cm.
Placing these cables too close to each other may result in malfunction.
- Use shielded twisted-pair cables or screened unshielded twisted-pair cables for I/O signal cables and the encoder cables.
- The maximum wiring length is 3 m for I/O signal cables, 50 m for servomotor main circuit cables and encoder cables, and 10 m for power supply cables.
- Install the battery in the battery unit of the encoder cable with a battery unit.
- Voltage remains in the SERVOPACK even after the power supply is turned OFF. To prevent electric shock, do not touch the input terminals for the main circuit power supply or those for the control power supply.
Before wiring or inspections, confirm that the SERVOPACK has completely discharged.
- Be sure to observe the following precautions when wiring the SERVOPACK main circuit terminal blocks.
 - Do not turn the SERVOPACK power ON until all wiring, including the main circuit terminal blocks, has been completed.
 - Remove detachable power supply input connectors or motor connectors from the SERVOPACK before wiring.
- Make sure that the wiring for both the main circuit power supply and control power supply is correct.
Incorrect wiring may cause damage.
- Make sure that the polarity of the input power supply is correct.
Incorrect polarity may cause damage.
- Always use the specified power supply voltage.
An incorrect voltage may result in fire or malfunction.
- Take appropriate measures to ensure that the input power supply is supplied within the specified voltage fluctuation range.
An incorrect power supply may result in damage to the equipment.
- Install external breakers or other safety devices against short-circuiting in external wiring.
Failure to observe this caution may result in fire.
- Take appropriate and sufficient countermeasures for each form of potential interference when installing systems in the following locations.
 - Locations subject to static electricity or other forms of noise
 - Locations subject to strong electromagnetic fields and magnetic fields
 - Locations subject to possible exposure to radioactivity
 - Locations close to power suppliesFailure to observe this caution may result in damage to the equipment.
- Do not reverse the polarity of the battery when connecting it.
Failure to observe this caution may damage the battery, the SERVOPACK or servomotor, or cause an explosion.
- Wiring or inspection must be performed by a technical expert.
- Use a 24-VDC or 48-VDC power supply with double insulation or reinforced insulation.
- Failures caused by incorrect wiring or wrong voltage application in the brake circuit may damage the equipment or cause an accident resulting in death or injury. Follow the procedures and instructions for wiring and trial operation precisely as described in this manual.
- When using a detector or a breaker for leakage current, select the appropriate one by considering the grounding conditions and the leakage current of noise filter. For details, contact the manufacturer of the noise filter.
- Incorrect wiring or incorrect voltage application to the output circuit may cause short-circuit.
The above failures will prevent the holding brake from working, which may damage the machine or cause an accident resulting in death or injury.



CAUTION

- Inverting the polarity of the brake signal (/BK), i.e. positive logic, will prevent the holding brake from working in case of its signal line disconnection.
If this setting is absolutely necessary, check the operation and confirm that there are no safety problems.
- Provide separate AC/DC power supplies for the main circuits and for controls.
Failure to observe this caution may result in malfunction.
- Do not connect devices (such as motors or solenoids) that greatly change the load or devices (such as electromagnetic switches) that generate surge voltages to the controller power line.
Failure to observe this caution may result in deterioration of the internal elements or a blown fuse.

■ Operation



CAUTION

- Always use the servomotor and SERVOPACK in one of the specified combinations.
Failure to observe this caution may result in fire or malfunction.
- Conduct trial operation on the servomotor alone with the motor shaft disconnected from the machine to avoid accidents.
Failure to observe this caution may result in injury.
- During trial operation, confirm that the holding brake works correctly. Furthermore, secure system safety against problems such as signal line disconnection.
- Before starting operation with a machine connected, change the parameter settings to match the parameters of the machine.
Starting operation without matching the proper settings may cause the machine to run out of control or malfunction.
- Do not turn the power ON and OFF more than necessary.
Do not use the SERVOPACK for applications that require the power to turn ON and OFF frequently. Such applications will cause elements in the SERVOPACK to deteriorate.
As a guideline, at least one hour should be allowed between the power being turned ON and OFF once actual operation has been started.
- When carrying out JOG operation (Fn002), origin search (Fn003), or EasyFFT (Fn206), forcing movable machine parts to stop does not work for forward overtravel or reverse overtravel. Take necessary precautions.
Failure to observe this caution may result in damage to the equipment.
- When using the servomotor for a vertical axis, install safety devices to prevent workpieces from falling due to alarms or overtravels. Set the servomotor so that it will stop in the zero clamp state when overtravel occurs.
Failure to observe this caution may cause workpieces to fall due to overtravel.
- When not using the tuning-less function, set the correct moment of inertia ratio (Pn103).
Setting an incorrect moment of inertia ratio may cause machine vibration.
- Do not touch the SERVOPACK heat sinks or servomotor while power is ON or soon after the power is turned OFF.
Failure to observe this caution may result in burns due to high temperatures.
- Do not make any extreme adjustments or setting changes of parameters.
Failure to observe this caution may result in injury or damage to the equipment due to unstable operation.
- When an alarm occurs, remove the cause, reset the alarm after confirming safety, and then resume operation.
Failure to observe this caution may result in damage to the equipment, fire, or injury.
- Do not use the holding brake of the servomotor for braking.
Failure to observe this caution may result in malfunction.
- The servomotor will decelerate to a stop if the main-circuit or the control-circuit power supply turns OFF during operation without turning servo OFF.
- An alarm or warning may occur if communications are performed with the host controller while the SigmaWin+ is operating.
If an alarm or warning occurs, it may stop the current process and stop the system.

■ Maintenance and Inspection

 CAUTION

- Do not disassemble the SERVOPACK and the servomotor.
Failure to observe this caution may result in electric shock or injury.
- Do not attempt to change wiring while the power is ON.
Failure to observe this caution may result in electric shock or injury.
- When replacing the SERVOPACK, resume operation only after copying the previous SERVOPACK parameters to the new SERVOPACK.
Failure to observe this caution may result in damage to the equipment.

■ Disposal

 CAUTION

- When disposing of the products, treat them as ordinary industrial waste.

■ General Precautions

**Observe the following general precautions
to ensure safe application.**

- The products shown in illustrations in this manual are sometimes shown without covers or protective guards. Always replace the cover or protective guard as specified first, and then operate the products in accordance with the manual.
- The drawings presented in this manual are typical examples and may not match the product you received.
- If the manual must be ordered due to loss or damage, inform your nearest Yaskawa representative or one of the offices listed on the back of this manual.

Warranty

(1) Details of Warranty

■ Warranty Period

The warranty period for a product that was purchased (hereinafter called “delivered product”) is one year from the time of delivery to the location specified by the customer or 18 months from the time of shipment from the Yaskawa factory, whichever is sooner.

■ Warranty Scope

Yaskawa shall replace or repair a defective product free of charge if a defect attributable to Yaskawa occurs during the warranty period above. This warranty does not cover defects caused by the delivered product reaching the end of its service life and replacement of parts that require replacement or that have a limited service life.

This warranty does not cover failures that result from any of the following causes.

1. Improper handling, abuse, or use in unsuitable conditions or in environments not described in product catalogs or manuals, or in any separately agreed-upon specifications
2. Causes not attributable to the delivered product itself
3. Modifications or repairs not performed by Yaskawa
4. Abuse of the delivered product in a manner in which it was not originally intended
5. Causes that were not foreseeable with the scientific and technological understanding at the time of shipment from Yaskawa
6. Events for which Yaskawa is not responsible, such as natural or human-made disasters

(2) Limitations of Liability

1. Yaskawa shall in no event be responsible for any damage or loss of opportunity to the customer that arises due to failure of the delivered product.
2. Yaskawa shall not be responsible for any programs (including parameter settings) or the results of program execution of the programs provided by the user or by a third party for use with programmable Yaskawa products.
3. The information described in product catalogs or manuals is provided for the purpose of the customer purchasing the appropriate product for the intended application. The use thereof does not guarantee that there are no infringements of intellectual property rights or other proprietary rights of Yaskawa or third parties, nor does it construe a license.
4. Yaskawa shall not be responsible for any damage arising from infringements of intellectual property rights or other proprietary rights of third parties as a result of using the information described in catalogs or manuals.

(3) Suitability for Use

1. It is the customer's responsibility to confirm conformity with any standards, codes, or regulations that apply if the Yaskawa product is used in combination with any other products.
2. The customer must confirm that the Yaskawa product is suitable for the systems, machines, and equipment used by the customer.
3. Consult with Yaskawa to determine whether use in the following applications is acceptable. If use in the application is acceptable, use the product with extra allowance in ratings and specifications, and provide safety measures to minimize hazards in the event of failure.
 - Outdoor use, use involving potential chemical contamination or electrical interference, or use in conditions or environments not described in product catalogs or manuals
 - Nuclear energy control systems, combustion systems, railroad systems, aviation systems, vehicle systems, medical equipment, amusement machines, and installations subject to separate industry or government regulations
 - Systems, machines, and equipment that may present a risk to life or property
 - Systems that require a high degree of reliability, such as systems that supply gas, water, or electricity, or systems that operate continuously 24 hours a day
 - Other systems that require a similar high degree of safety
4. Never use the product for an application involving serious risk to life or property without first ensuring that the system is designed to secure the required level of safety with risk warnings and redundancy, and that the Yaskawa product is properly rated and installed.
5. The circuit examples and other application examples described in product catalogs and manuals are for reference. Check the functionality and safety of the actual devices and equipment to be used before using the product.
6. Read and understand all use prohibitions and precautions, and operate the Yaskawa product correctly to prevent accidental harm to third parties.

(4) Specifications Change

The names, specifications, appearance, and accessories of products in product catalogs and manuals may be changed at any time based on improvements and other reasons. The next editions of the revised catalogs or manuals will be published with updated code numbers. Consult with your Yaskawa representative to confirm the actual specifications before purchasing a product.

Harmonized Standards

- North American Safety Standards (UL)



	Model	UL Standards
SERVOPACK	SGDV	UL508C
Servomotor	SGMMV	UL1004

- European Directives



	Model	European Directives	Harmonized Standards
SERVOPACK	SGDV	EMC Directive 2004/108/EC	EN 55011 /group 1, class A EN 61000-6-2 EN 61800-3
		Low Voltage Directive 2006/95/EC	EN 61800-5-1
Servomotor	SGMMV	EMC Directive 2004/108/EC	EN 55011 /group 1, class A EN 61000-6-2 EN 61800-3
		Low Voltage Directive 2006/95/EC	EN 60034-1 EN 60034-5

Contents

About this Manual	iii
Safety Precautions	vii
Warranty	xii
Harmonized Standards	xiv

Chapter 1 Outline	1-1
1.1 DC Power Input Σ -V Series SERVOPACKs	1-2
1.2 Part Names	1-2
1.3 SERVOPACK Ratings and Specifications	1-3
1.3.1 Ratings	1-3
1.3.2 Basic Specifications	1-4
1.3.3 MECHATROLINK-II Function Specifications	1-6
1.4 SERVOPACK Internal Block Diagrams	1-7
1.4.1 MECHATROLINK-II Communications Reference (Model: SGDV-□□□E11A)	1-7
1.5 Examples of Servo System Configurations	1-8
1.6 SERVOPACK Model Designation	1-9
1.7 Inspection and Maintenance	1-10

Chapter 2 SigmaWin+	2-1
2.1 SigmaWin+	2-2
2.2 Preparing SigmaWin+	2-2
2.3 Connecting a PC with SigmaWin+	2-2
2.4 Starting and Operating the SigmaWin+	2-3
2.5 Parameters (Pn□□□)	2-5
2.5.1 Parameter Classification	2-5
2.5.2 Notation for Parameters	2-5
2.5.3 Setting Parameters	2-6

Chapter 3 Wiring and Connection	3-1
3.1 Main Circuit Wiring	3-2
3.1.1 Main Circuit Terminals (CN3, CN4)	3-2
3.1.2 Main Circuit Wires	3-3
3.1.3 Typical Main Circuit Wiring Examples	3-4
3.1.4 Power Supply Capacities and Power Losses	3-5
3.1.5 Input Power Supply, Molded-case Circuit Breaker, and Fuse	3-5
3.1.6 Using More Than One SERVOPACK	3-6
3.1.7 General Precautions for Wiring	3-7
3.2 I/O Signal Connections	3-9
3.2.1 I/O Signal (CN1) Names and Functions	3-9
3.2.2 Example of I/O Signal Connections	3-10
3.3 I/O Signal Allocations	3-11
3.3.1 Input Signal Allocations	3-11
3.3.2 Output Signal Allocations	3-17
3.4 Examples of Connection to Host Controller	3-21
3.4.1 Sequence Input Circuit	3-21
3.4.2 Sequence Output Circuit	3-22
3.5 Wiring MECHATROLINK-II Communications	3-23

3.6 Encoder Connection	3-24
3.6.1 Encoder Signal (CN2) Names and Functions	3-24
3.6.2 Encoder Connection Examples	3-24
3.7 Noise Control and Measures for Harmonic Suppression	3-26
3.7.1 Wiring for Noise Control	3-26
3.7.2 Precautions on Connecting Noise Filter	3-28

Chapter 4 Operation 4-1

4.1 MECHATROLINK-II Communications Settings	4-3
4.1.1 Setting Switches SW1 and SW2	4-3
4.2 MECHATROLINK-II Commands	4-5
4.3 Basic Functions Settings	4-5
4.3.1 Servomotor Rotation Direction	4-5
4.3.2 Overtravel	4-6
4.3.3 Software Limit Settings	4-9
4.3.4 Holding Brakes	4-10
4.3.5 Stopping Servomotors after SV_OFF Command or Alarm Occurrence	4-15
4.3.6 Setting Motor Overload Detection Level	4-16
4.4 Trial Operation	4-18
4.4.1 Inspection and Checking before Trial Operation	4-18
4.4.2 Trial Operation via MECHATROLINK-II	4-19
4.4.3 Electronic Gear	4-20
4.5 Test Without Motor Function	4-22
4.5.1 Motor Information	4-22
4.5.2 Motor Position and Speed Responses	4-23
4.5.3 Limitations	4-24
4.6 Limiting Torque	4-25
4.6.1 Internal Torque Limit	4-25
4.6.2 External Torque Limit	4-26
4.6.3 Checking Output Torque Limiting during Operation	4-27
4.7 Absolute Encoders	4-28
4.7.1 Connecting the Absolute Encoder	4-28
4.7.2 Absolute Data Request (SENS ON Command)	4-29
4.7.3 Battery Replacement	4-30
4.7.4 Absolute Encoder Setup	4-32
4.7.5 Multiturn Limit Setting	4-35
4.7.6 Multiturn Limit Disagreement Alarm (A.CC0)	4-36
4.7.7 Absolute Encoder Origin Offset	4-39
4.8 Other Output Signals	4-40
4.8.1 Servo Alarm Output Signal (ALM)	4-40
4.8.2 Warning Output Signal (/WARN)	4-40
4.8.3 Rotation Detection Output Signal (/TGON)	4-41
4.8.4 Servo Ready Output Signal (/S-RDY)	4-41
4.8.5 Speed Coincidence Output Signal (/V-CMP)	4-42
4.8.6 Positioning Completed Output Signal (/COIN)	4-43
4.8.7 Positioning Near Output Signal (/NEAR)	4-44
4.8.8 Speed Limit Detection Signal (/VLT)	4-44

Chapter 5 Adjustments 5-1

5.1 Type of Adjustments and Basic Adjustment Procedure	5-3
5.1.1 Adjustments	5-3
5.1.2 Basic Adjustment Procedure	5-4
5.1.3 Monitoring Operation during Adjustment	5-5
5.1.4 Safety Precautions on Adjustment of Servo Gains	5-8

5.2	Tuning-less Function	5-11
5.2.1	Tuning-less Function	5-11
5.2.2	Tuning-less Levels Setting (Fn200) Procedure	5-13
5.2.3	Related Parameters	5-17
5.3	Advanced Autotuning (Fn201)	5-18
5.3.1	Advanced Autotuning	5-18
5.3.2	Advanced Autotuning Procedure	5-21
5.3.3	Related Parameters	5-33
5.4	Advanced Autotuning by Reference (Fn202)	5-34
5.4.1	Advanced Autotuning by Reference	5-34
5.4.2	Advanced Autotuning by Reference Procedure	5-36
5.4.3	Related Parameters	5-42
5.5	One-parameter Tuning (Fn203)	5-43
5.5.1	One-parameter Tuning	5-43
5.5.2	One-parameter Tuning Procedure	5-43
5.5.3	One-parameter Tuning Example	5-52
5.5.4	Related Parameters	5-53
5.6	Anti-Resonance Control Adjustment Function (Fn204)	5-54
5.6.1	Anti-Resonance Control Adjustment Function	5-54
5.6.2	Anti-Resonance Control Adjustment Function Operating Procedure	5-55
5.6.3	Related Parameters	5-63
5.7	Vibration Suppression Function (Fn205)	5-64
5.7.1	Vibration Suppression Function	5-64
5.7.2	Vibration Suppression Function Operating Procedure	5-65
5.7.3	Related Parameters	5-70
5.8	Additional Adjustment Function	5-71
5.8.1	Switching Gain Settings	5-71
5.8.2	Manual Adjustment of Friction Compensation	5-75
5.8.3	Current Control Mode Selection Function	5-77
5.8.4	Current Gain Level Setting	5-77
5.8.5	Speed Detection Method Selection	5-77
5.8.6	Backlash Compensation Function	5-78
5.9	Compatible Adjustment Function	5-84
5.9.1	Feedforward Reference	5-84
5.9.2	Mode Switch (P/PI Switching)	5-85
5.9.3	Torque Reference Filter	5-87
5.9.4	Position Integral	5-89

Chapter 6 Utility Functions (Fn□□□)		6-1
6.1	List of Utility Functions	6-2
6.2	Alarm History Display (Fn000)	6-3
6.3	JOG Operation (Fn002)	6-4
6.4	Origin Search (Fn003)	6-6
6.5	Program JOG Operation (Fn004)	6-9
6.6	Initializing Parameter Settings (Fn005)	6-16
6.7	Clearing Alarm History (Fn006)	6-19
6.8	Offset Adjustment of Analog Monitor Output (Fn00C)	6-20
6.9	Gain Adjustment of Analog Monitor Output (Fn00D)	6-22
6.10	Automatic Offset-Signal Adjustment of the Motor Current Detection Signal (Fn00E)	6-24
6.11	Manual Offset-Signal Adjustment of the Motor Current Detection Signal (Fn00F)	6-26
6.12	Write Prohibited Setting (Fn010)	6-28
6.13	Servomotor Model Display (Fn011)	6-30
6.14	Software Version Display (Fn012)	6-31

6.15	Vibration Detection Level Initialization (Fn01B)	6-32
6.16	Display of SERVOPACK and Servomotor ID (Fn01E)	6-35
6.17	Software Reset (Fn030)	6-36
6.18	EasyFFT (Fn206)	6-41
6.19	Online Vibration Monitor (Fn207)	6-45

Chapter 7 Monitor Displays (Un□□□) 7-1

7.1	List of Monitor Displays	7-2
7.2	Viewing Monitor Displays	7-3
7.2.1	System Monitor	7-3
7.2.2	Status Monitor	7-4
7.2.3	Motion Monitor	7-5
7.2.4	Input Signal Monitor	7-6
7.2.5	Output Signal Monitor	7-7

Chapter 8 Troubleshooting 8-1

8.1	Alarm Displays	8-2
8.1.1	List of Alarms	8-2
8.1.2	Troubleshooting of Alarms	8-5
8.2	Warning Displays	8-15
8.2.1	List of Warnings	8-15
8.2.2	Troubleshooting of Warnings	8-16
8.3	Monitoring Communication Data on Occurrence of an Alarm or Warning	8-19
8.4	Troubleshooting Malfunction Based on Operation and Conditions of the Servomotor	8-20

Chapter 9 Appendix. 9-1

9.1	List of Parameters	9-2
9.1.1	Utility Functions	9-2
9.1.2	Parameters	9-3
9.2	List of Monitor Displays	9-30
9.3	Parameter Recording Table	9-31

Index. Index-1

Revision History

Outline

1.1 DC Power Input Σ -V Series SERVOPACKs	1-2
1.2 Part Names	1-2
1.3 SERVOPACK Ratings and Specifications	1-3
1.3.1 Ratings	1-3
1.3.2 Basic Specifications	1-4
1.3.3 MECHATROLINK-II Function Specifications	1-6
1.4 SERVOPACK Internal Block Diagrams	1-7
1.4.1 MECHATROLINK-II Communications Reference (Model: SGD Σ -□□□E11A)	1-7
1.5 Examples of Servo System Configurations	1-8
1.6 SERVOPACK Model Designation	1-9
1.7 Inspection and Maintenance	1-10

1.1 DC Power Input Σ -V Series SERVOPACKs

The DC Power Input Σ -V Series SERVOPACKs are designed for applications that require frequent high-speed, high-precision positioning. The SERVOPACK makes the most of machine performance in the shortest time possible, thus contributing to improving productivity.

1.2 Part Names

This section describes the part names of SGD-V SERVOPACK for MECHATROLINK-II communications reference.

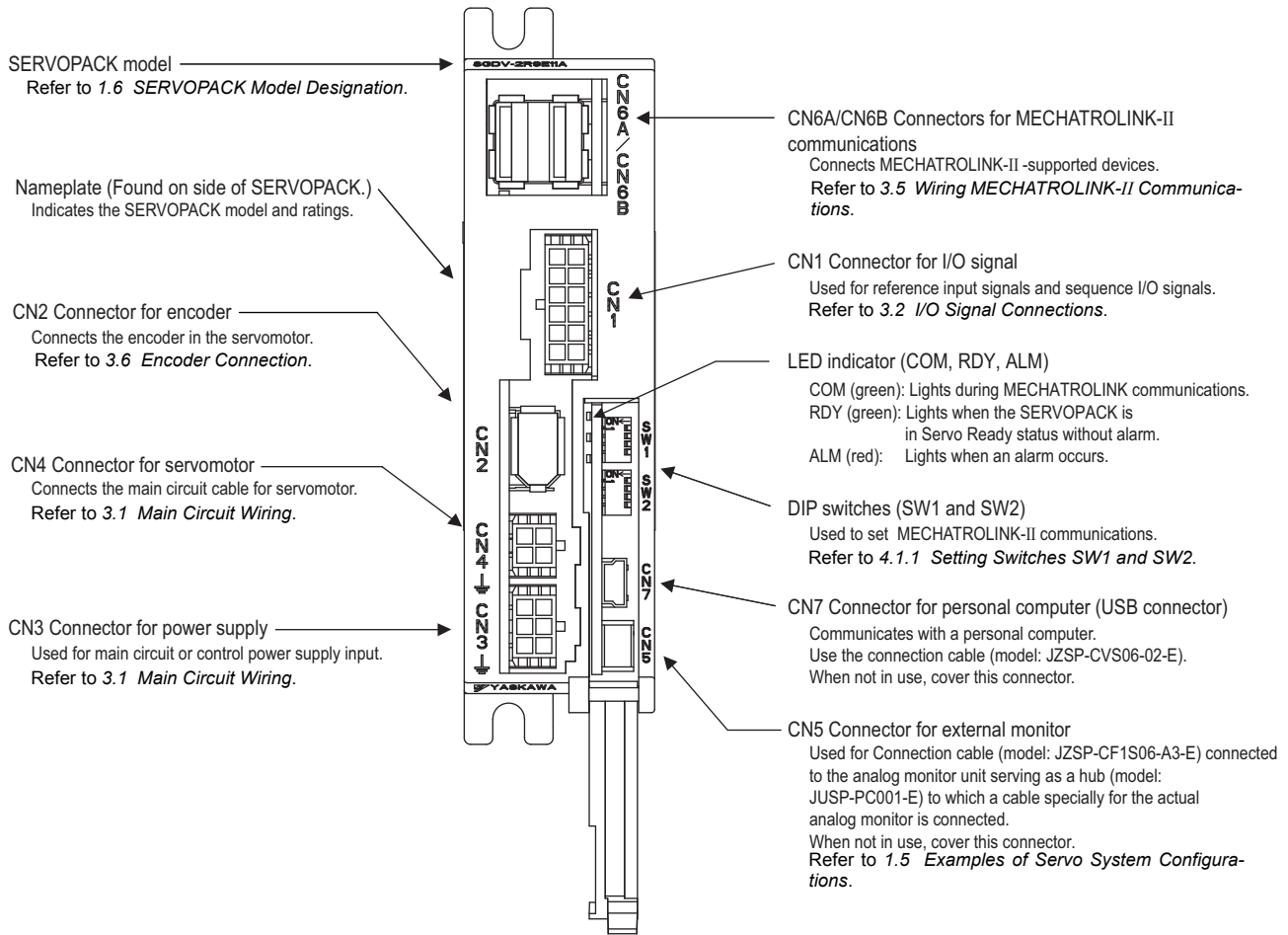

1.3 SERVOPACK Ratings and Specifications

This section describes the ratings and specifications of SERVOPACKs.

1.3.1 Ratings

Ratings of SERVOPACKs are as shown below.

SGDV	1R7		2R9	
Continuous Output Current [Arms]	1.7		2.9	
Instantaneous Max. Output Current [Arms]	4.1		8.6	
Main Circuit Power Supply	24 VDC ±15%	48 VDC ±15%	24 VDC ±15%	48 VDC ±15%
Control Power Supply	24 VDC ±15%			
Overvoltage Category	I			

- * You can use either 24 or 48 VDC for the main circuit power supply. If using a 24-VDC input, the torque-motor speed characteristics of the servomotor will be less than the characteristics of a 48-VDC input. For details, refer to *Torque-Motor Speed Characteristics* of the SGMMV servomotor in *Σ-V Series Product Catalog* (Catalog No.: KAEP S800000 42).

1.3.2 Basic Specifications

Basic specifications of SERVOPACKs are shown below.

Drive Method		Sine-wave current drive with PWM control	
Feedback		Encoder: 17-bit (incremental/absolute)	
Operating Conditions	Surrounding Air Temperature	0°C to +55°C	
	Storage Temperature	-20°C to +85°C	
	Ambient Humidity	90% RH or less	With no freezing or condensation
	Storage Humidity	90% RH or less	
	Vibration Resistance	4.9 m/s ²	
	Shock Resistance	19.6 m/s ²	
	Protection Class	IP10	An environment that satisfies the following conditions. <ul style="list-style-type: none"> • Free of corrosive or flammable gases • Free of exposure to water, oil, or chemicals • Free of dust, salts, or iron dust
	Pollution Degree	2	
	Altitude	1000 m or less	
	Others	Free of static electricity, strong electromagnetic fields, magnetic fields or exposure to radioactivity	
Harmonized Standards		UL508C EN 55011/group 1, class A, EN 61000-6-2, EN 61800-3, EN 61800-5-1	
Mounting		Base-mounted	
Performance	Speed Control Range		1:5000 (The lower limit of the speed control range must be lower than the point at which the rated torque does not cause the servomotor to stop.)
	Speed Regulation* ¹	Load Regulation	0% to 100% load: ±0.01% max. (at rated speed)
		Voltage Regulation	Rated voltage ±10%: 0% (at rated speed)
		Temperature Regulation	25 ± 25 °C: ±0.1% max. (at rated speed)
	Torque Control Tolerance (Repeatability)		±1%
	Soft Start Time Setting* ²		0 to 10 s (Can be set individually for acceleration and deceleration.)

(cont'd)

I/O Signals	Sequence Input	Input Signals which can be allocated	Number of Channels	3 ch
			Functions	<ul style="list-style-type: none"> • Homing deceleration switch (/DEC) • External latch (/EXT 1) • Forward run prohibited (P-OT), reverse run prohibited (N-OT) • Forward external torque limit (/P-CL), reverse external torque limit (/N-CL) Signal allocations can be performed, and positive and negative logic can be changed.
	Sequence Output	Output Signals which can be allocated	Fixed Output	Servo alarm (ALM)
			Number of Channels	3 ch
Functions	<ul style="list-style-type: none"> • Positioning completion (/COIN) • Speed coincidence detection (/V-CMP) • Rotation detection (/TGON) • Servo ready (/S-RDY) • Torque limit detection (/CLT) • Speed limit detection (/VLT) • Brake (/BK) • Warning (/WARN) • Near (/NEAR) Signal allocations can be performed, and positive and negative logic can be changed.			
Communi-cations Function	Personal Computer Communications (USB)	Supports SigmaWin+. Based on the USB 1.1 standard (12 Mbps).		
LED Display	ALM (red), RDY (green), COM (green)			
MECHATROLINK-II Communications Setting Switches	DIP Switch (SW1, SW2)		Number of pins: four pins × 2 switches (Refer to 4.1.1)	
Analog Monitor	Number of points: 2 Output voltage: ± 10 VDC (linearity effective range ± 8 V) Output through the analog monitor unit (model: JUSP-PC001-E), the connection cable (model: JZSP-CF1S06-A3-E), and the analog monitor cable (model: JZSP-CA01-E).			
Dynamic Brake (DB)	Not supported.			
Regenerative Processing	Not supported.			
Overtravel Prevention (OT)	Deceleration to a stop or free run to a stop at P-OT or N-OT			
Protective Function	Overcurrent, overvoltage, overload, and so on.			
Utility Function	Gain adjustment, alarm history, JOG operation, origin search, and so on.			

*1. Speed regulation by load regulation is defined as follows:

$$\text{Speed regulation} = \frac{\text{No-load motor speed} - \text{Total load motor speed}}{\text{Rated motor speed}} \times 100\%$$

*2. Refer to 4.2.10 Velocity Control (VEL CTRL: 3CH) of Σ -V Series User's Manual MECHATROLINK-II Commands (Manual No.: SIEP S800000 54) for details on the soft start function.

1.3.3 MECHATROLINK-II Function Specifications

The following table shows the specifications of MECHATROLINK-II.

Function		Specifications
MECHATROLINK-II Communication	Communication Protocol	MECHATROLINK-II
	Station Address	41H to 5FH (Max. number of stations: 30) Can be selected by the combination of the DIP switch (SW1, SW2).
	Baud Rate	10 Mbps, 4 Mbps Can be selected by the DIP switch (SW2).
	Transmission Cycle	250 μ s, 0.5 ms to 4.0 ms (Multiples of 0.5 ms) Can be selected by the DIP switch (SW2).
	Number of Transmission Bytes	17 bytes per station or 32 bytes per station Can be selected by the DIP switch (SW2).
Reference Method	Control Method	Position, speed, or torque control with MECHATROLINK-II communication
	Reference Input	MECHATROLINK-I, MECHATROLINK-II commands (sequence, motion, data setting/reference, monitoring, or adjustment)

1.4 SERVOPACK Internal Block Diagrams

1.4.1 MECHATROLINK-II Communications Reference (Model: SGDV-□□□E11A)

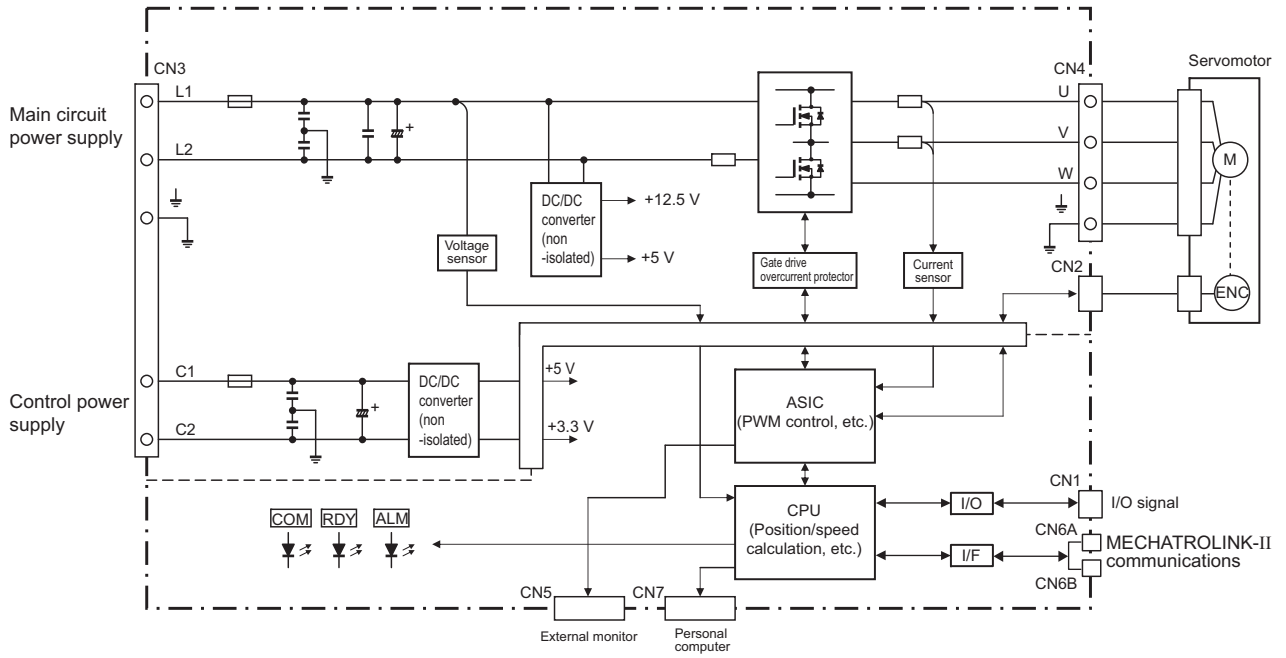

1.5 Examples of Servo System Configurations

This section describes examples of basic servo system configuration.

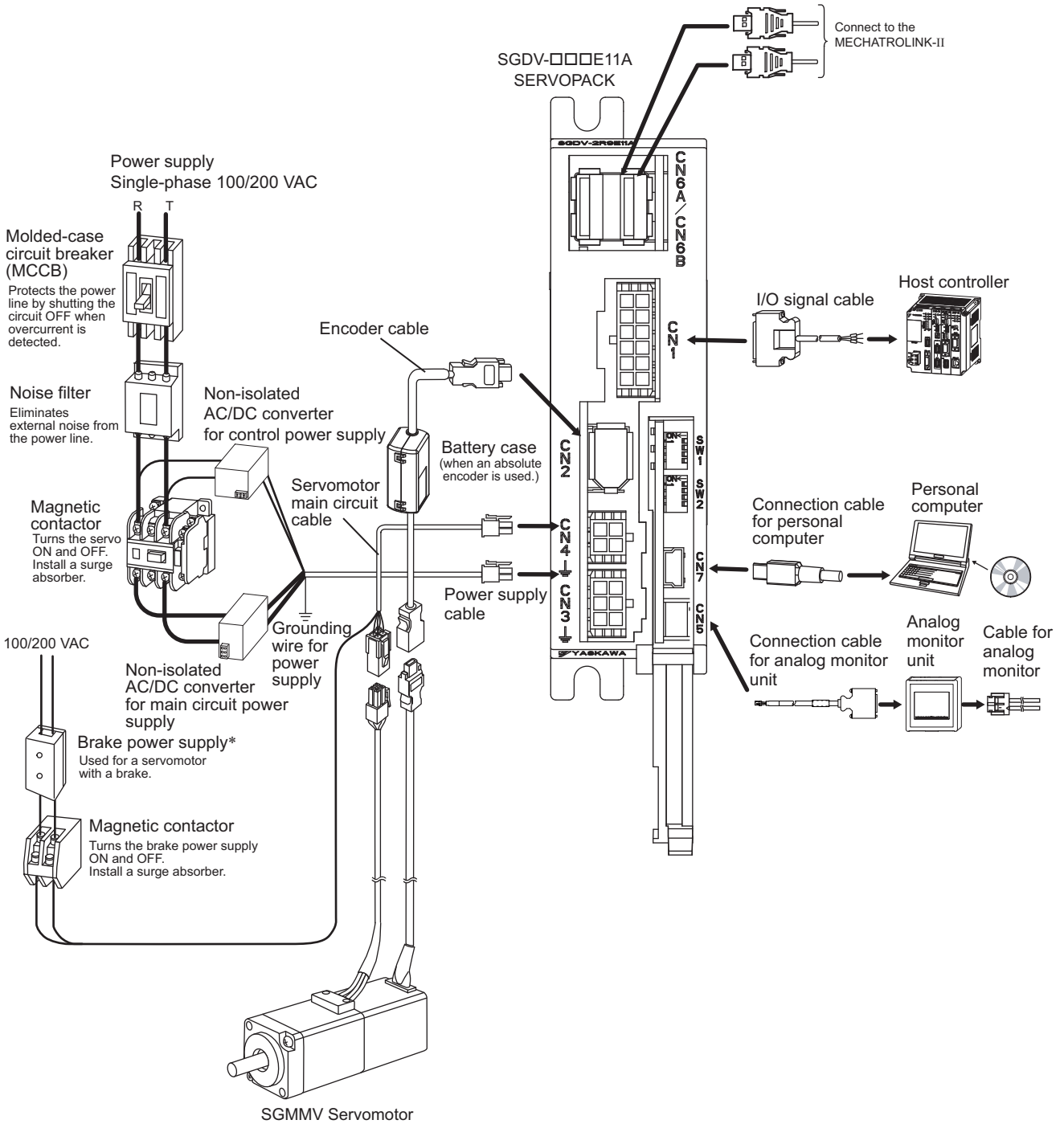

* Use a 24-VDC power supply. (Not included.)

1.6 SERVOPACK Model Designation

This section shows SERVOPACK model designation.

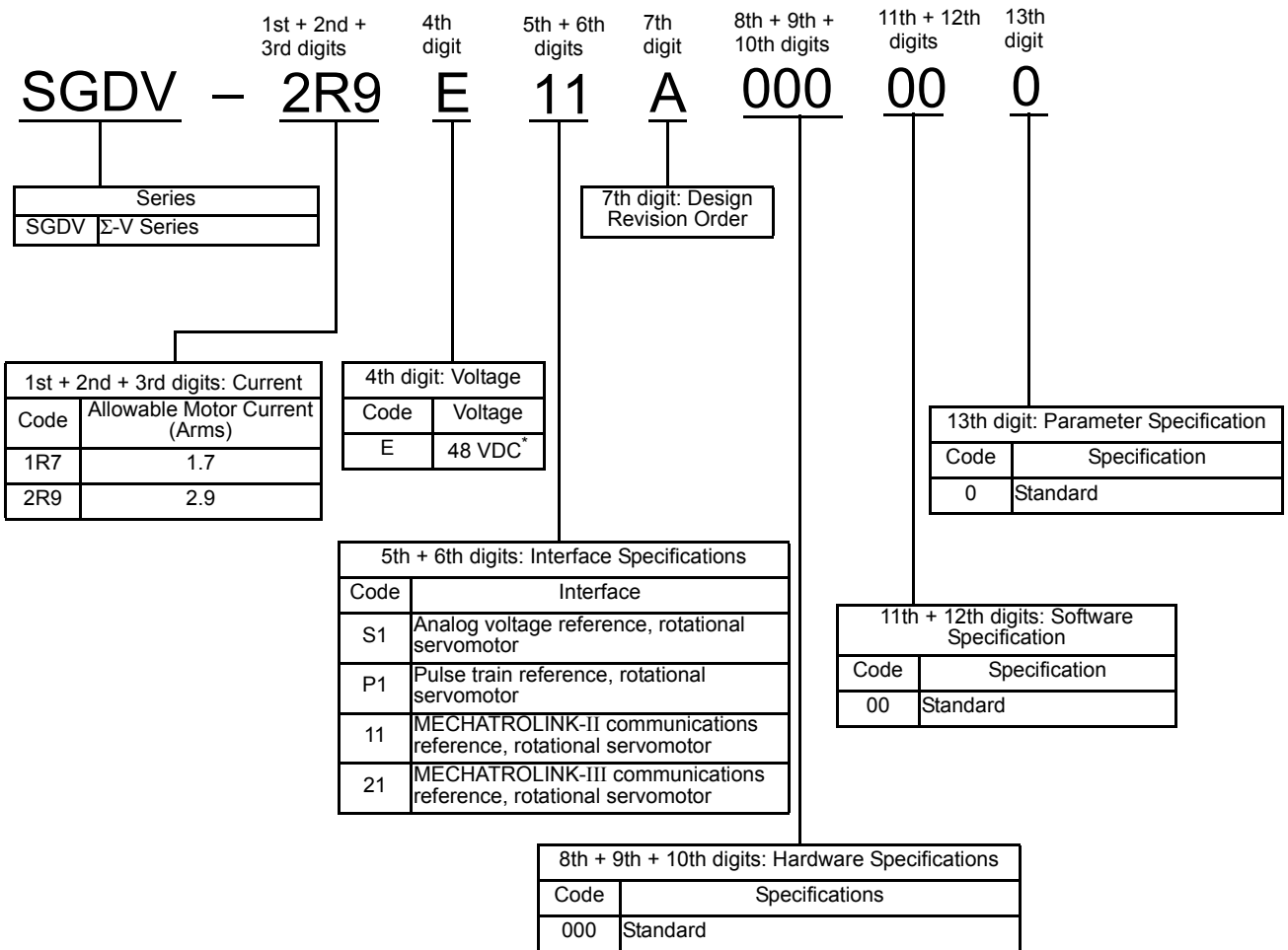

* 24 VDC for the main circuit power supply also can be used.
 Note: If the option codes digits 8 to 13 are all zeros, they are omitted.

1.7 Inspection and Maintenance

This section describes the inspection and maintenance of SERVOPACK.

(1) SERVOPACK Inspection

For inspection and maintenance of the SERVOPACK, follow the inspection procedures in the following table at least once every year. Other routine inspections are not required.

Item	Frequency	Procedure	Comments
Exterior	At least once a year	Check for dust, dirt, and oil on the surfaces.	Clean with compressed air.
Loose Screws		Check for loose connector screws.	Tighten any loose screws.

(2) SERVOPACK's Parts Replacement Schedule

The electric or electronic parts are subject to deterioration over time. To avoid failure, replace these parts at the frequency indicated.

Refer to the standard replacement period in the following table and contact your Yaskawa representative. After an examination of the part in question, we will determine whether the parts should be replaced or not.

 IMPORTANT	<p>The parameters of any SERVOPACKs overhauled by Yaskawa are reset to the factory settings before shipping. Be sure to confirm that the parameters are properly set before starting operation.</p>
--------------------------------------------------------------------------------------------------------	-----------------------------------------------------------------------------------------------------------------------------------------------------------------------------------------------------

Part	Standard Replacement Period	Operating Conditions
Smoothing Capacitor (Aluminum Electrolytic Capacitor)	7 to 8 years	<ul style="list-style-type: none"> • Surrounding Air Temperature: Annual average of 30°C • Load Factor: 80% max. • Operation Rate: 20 hours/day max.

Note: If the above operating conditions are not used, replacement may be required sooner than the standard replacement period. To extend the life of the parts, reduce the ambient temperature. Contact your Yaskawa representative if you require more-detailed information.

SigmaWin+

2.1 SigmaWin+	2-2
2.2 Preparing SigmaWin+	2-2
2.3 Connecting a PC with SigmaWin+	2-2
2.4 Starting and Operating the SigmaWin+	2-3
2.5 Parameters (Pn□□□)	2-5
2.5.1 Parameter Classification	2-5
2.5.2 Notation for Parameters	2-5
2.5.3 Setting Parameters	2-6

2.1 SigmaWin+

SigmaWin+ is a software application that can be used to view SERVOPACK status, set parameters, and perform setup tuning.

2.2 Preparing SigmaWin+

Install SigmaWin+ after downloading the software application from the following Yaskawa website.
<http://www.e-mechatronics.com>.

2.3 Connecting a PC with SigmaWin+

A PC with SigmaWin+ installed can be connected to SERVOPACKs by one of two methods.

Connection Method	Description
Conventional	Use a communications cable to connect one PC with SigmaWin+ installed to one SERVOPACK. To use SigmaWin+ with a different SERVOPACK, disconnect the cable and reconnect the PC to the other SERVOPACK.
With a Controller	Use a communications cable to connect one PC with SigmaWin+ installed to one controller and then connect the controller to one SERVOPACK. If using this method, several SERVOPACKs can be connected to the controller at the same time.

For more information on how to connect a PC with SigmaWin+, refer to the SigmaWin+ Online Manual. To view the online manual, use the following procedure.

1. Turn on the computer.
2. Double click **YE_Applications** icon.
3. Double click **MANUAL** icon.
4. Double click **SigmaWin+ English Edition Online Manual**.

2.4 Starting and Operating the SigmaWin+

Use the following procedure to display the main window of the SigmaWin+.

1. Connect a SERVOPACK to a computer which has SigmaWin+ installed.
For details, refer to the figure provided in 1.5 *Examples of Servo System Configurations*.
2. Turn on the SERVOPACK.
3. Turn on the computer.
4. Double click the **YE_Applications** icon.
5. Double click the **SigmaWin+ English Edition** icon.
The SigmaWin+ startup window will appear. When the startup of SigmaWin+ has been completed, the **Connect** window will appear.



Setup Window

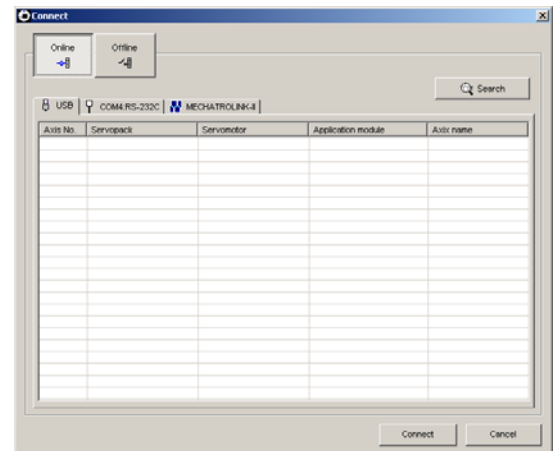

Connect Window

6. Click **Search**.
The **Search Condition Setting** box will appear.

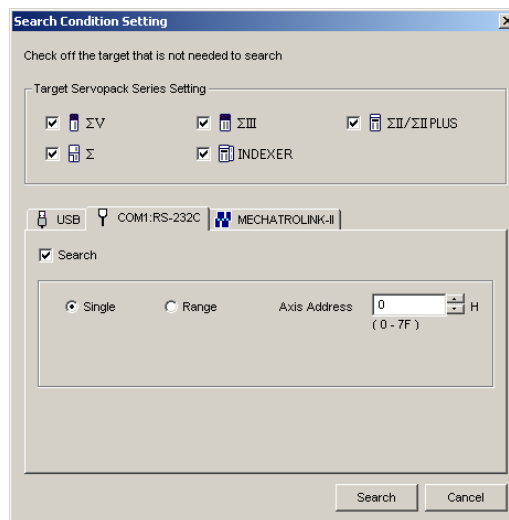

Search Condition Setting box

Note: Use the offline mode when running SigmaWin+ without connecting to the SERVOPACK.

7. Select the ΣV .

8. Click Search.

A message will appear first to indicate that a search is being carried out, and then the search results will be shown in the **Connect** window.

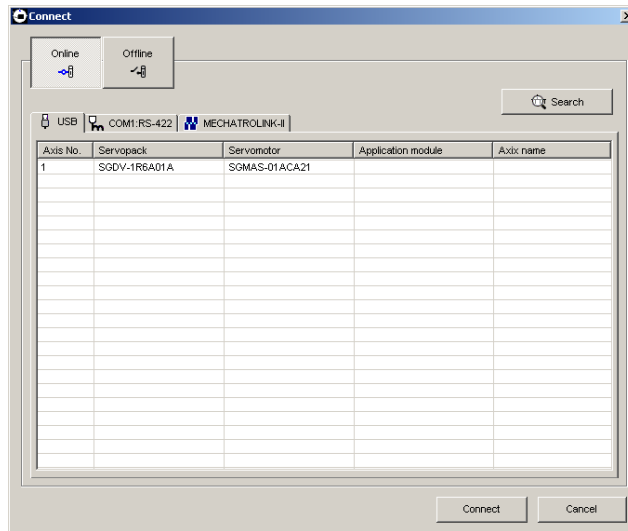

Note: If the message, "SERVOPACK not found", is shown, refer to the online manual. To view the online manual, refer to 2.3 *Connecting a PC with SigmaWin+*.

9. Select the SERVOPACK to be connected.**10. Click Connect.**

The SigmaWin+ main window will appear.

Note: For details on how to operate SigmaWin+, refer to the online manual for SigmaWin+. Refer to 2.3 *Connecting a PC with SigmaWin+* for the procedure to access the Online Manual.

2.5 Parameters (Pn□□□)

This section describes the classifications, methods of notation, and settings for parameters given in this manual.

2.5.1 Parameter Classification

Parameters of the Σ -V Series SERVOPACK are classified into two types of parameters. One type of parameters is required for setting up the basic conditions for operation and the other type is required for tuning parameters that are required to adjust servomotor characteristics.

Classification	Meaning	Display Method	Setting Method
Setup Parameters	Parameters required for setup.	Always displayed (Factory setting: Pn00B.0 = 0)	Set each parameter individually.
Tuning Parameters	Parameters for tuning control gain and other parameters.	Set Pn00B.0 to 1.	There is no need to set each parameter individually.

There are two types of notation used for parameters, one for parameter that requires a value setting (parameter for numeric settings) and one for parameter that requires the selection of a function (parameter for selecting functions).

The notation and settings for both types of parameters are described next.

2.5.2 Notation for Parameters

(1) Parameters for Numeric Settings

The control methods for which the parameters applies.
 Speed : Speed control Position : Position control Torque : Torque control

Pn406	Emergency Stop Torque				
	Setting Range	Setting Unit	Factory Setting	When Enabled	Classification
	0% to 800%	1%	800	After change	Setup

Parameter number

Indicates the setting range for the parameter.

Indicates the minimum setting unit for the parameter.

Indicates the parameter setting before shipment.

Indicates when a change to the parameter will be effective.

Indicates the parameter classification.

(2) Parameters for Selecting Functions

Parameter	Meaning	When Enabled	Classification
Pn002	n.□□□□ [Factory setting]	After restart	Setup
	n.□1□□		

Parameter number

The notation "n.□□□□" indicates a parameter for selecting functions. Each □ corresponds to the setting value of that digit. The notation shown here means that the third digit is 1.

This section explains the selections for the function.

2.5.3 Setting Parameters

There are two ways to set parameters. These are as follows:

- Using the Parameter Editing dialog box
- Using the Online Parameter Editing dialog box

These methods are described below.

(1) Using the Parameter Editing Dialog Box

1. In the SigmaWin+ main window, click **Parameters - Edit Parameters**.

The **Parameter Editing** dialog box will appear.

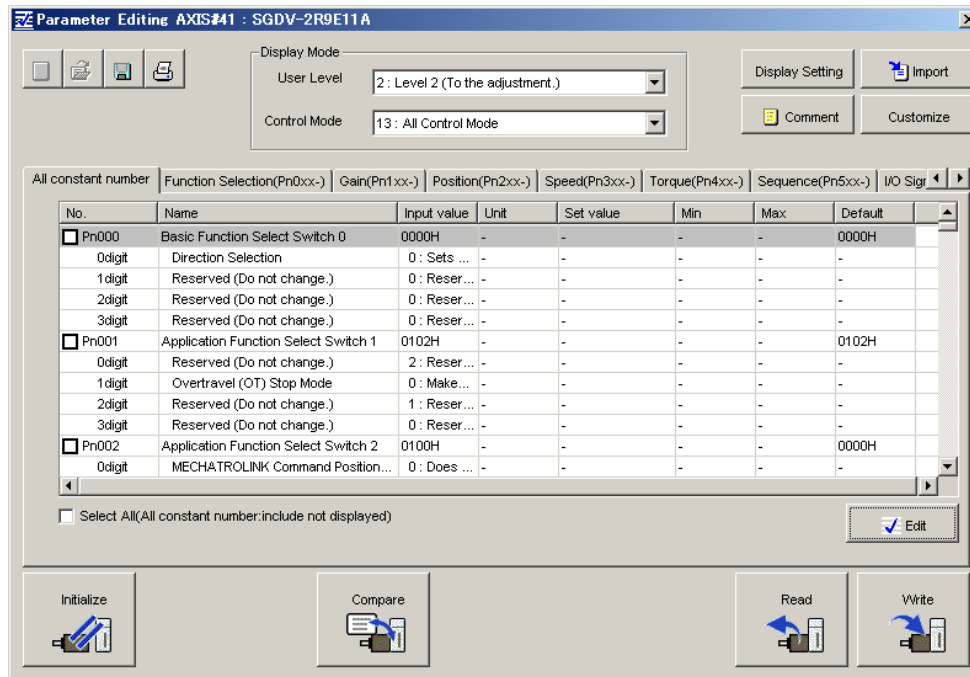

2. Select a parameter to edit.

If the parameter cannot be seen in the **Parameter Editing** dialog box, click the arrows to view the parameter.

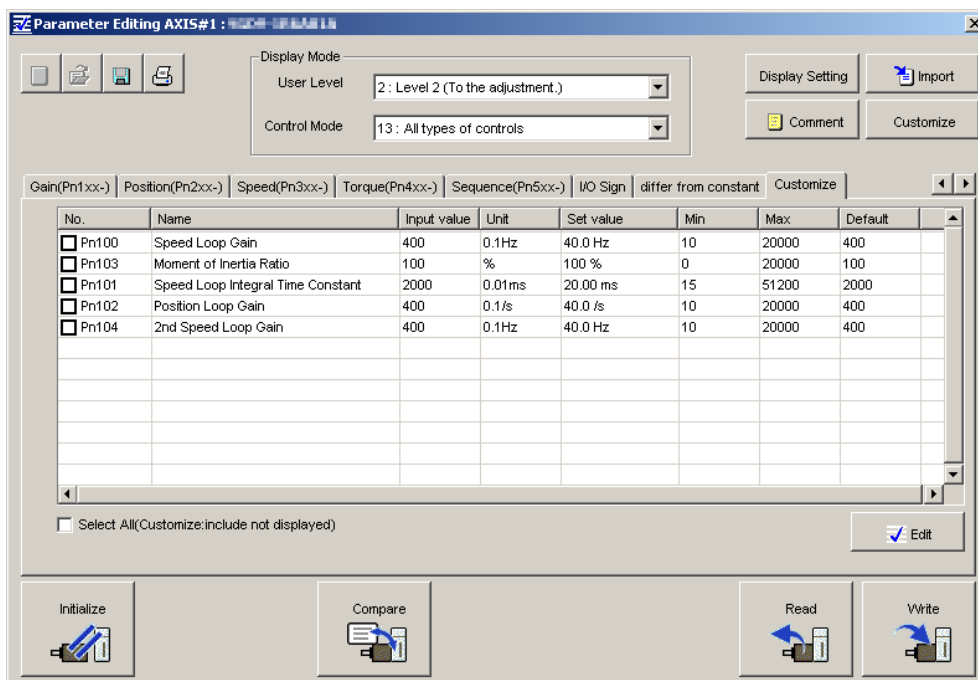

3. Click Edit.

The **Edit** box for the selected parameter will appear.

4. Change the value of the parameter.

<For parameters for numeric settings>
Enter the value to be set.

<For parameters for selecting functions>

Click the arrow to open the setting list for each digit and select one item in each list.

5. Click OK.**6. Click Write.**

The new parameter settings will be saved in the SERVOPACK.

This completes the editing of the parameter. If the following window appears, go to step 7.

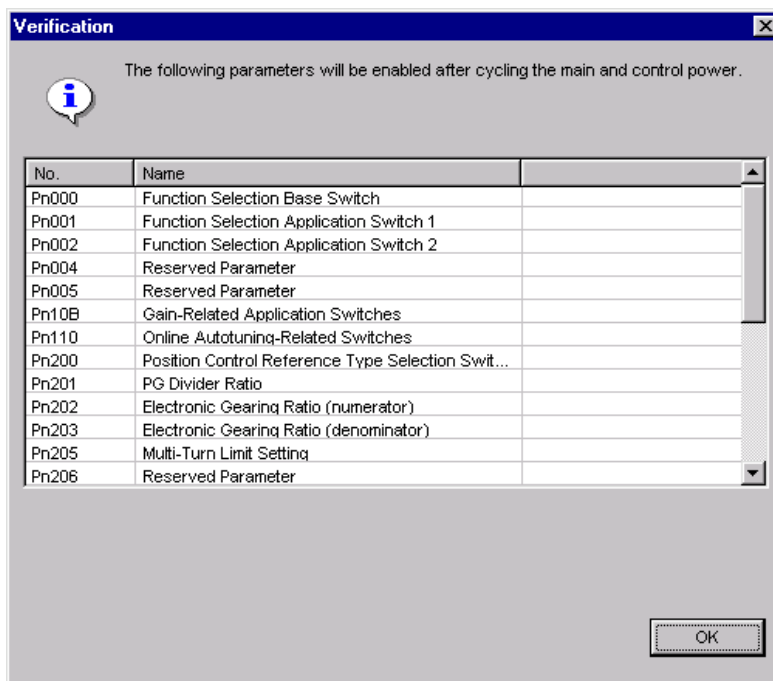
**7. Click OK.****8. To enable the change in the setting, restart the SERVOPACK.**

(2) Using the Online Parameter Editing Dialog Box



IMPORTANT

- Values edited in the Online Parameter Editing dialog box are immediately changed in the SERVOPACK.
- If the power to the SERVOPACK is turned OFF or the communication between the SERVOPACK and the SigmaWin+ is interrupted while editing parameters online, the edited values will not be saved in the SERVOPACK.

1. In the SigmaWin+ main window, click **Parameters - Edit Online Parameters**.
The **Online Parameter Editing** dialog box will appear.

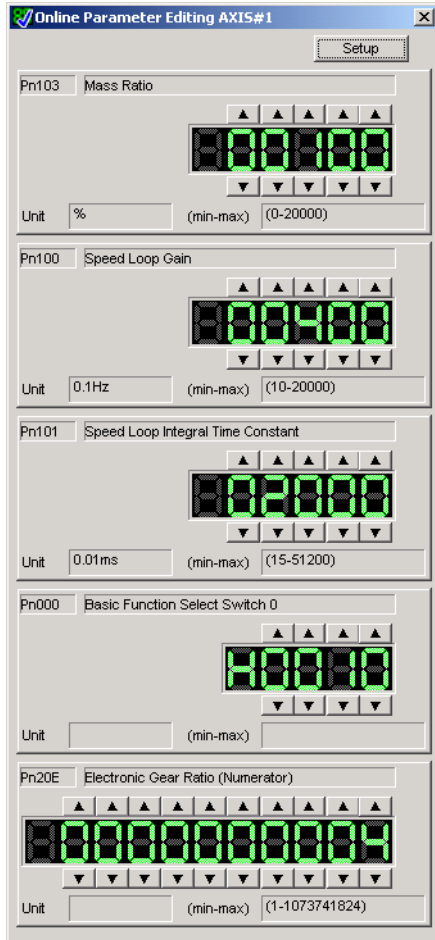

2. Click **Setup**.
The **Set Parameters** box will appear.

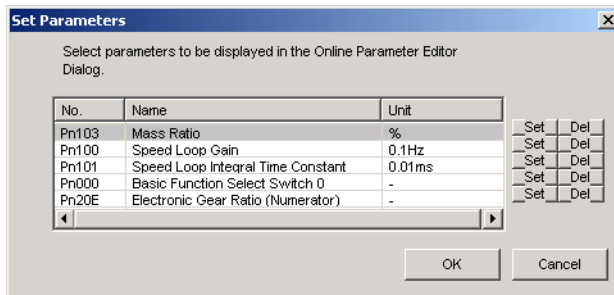

- Click one of the **Set** buttons located on the right of the parameter list.
The **Parameters list** box will appear.

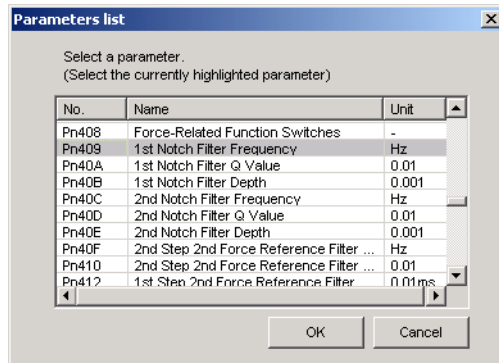

- Select a parameter to edit, and then click **OK**.
The **Set Parameters** box will appear again.
- Click **OK**.
The **Online Parameter Editing** dialog box will appear again.
- Click the setting arrows to change the value of the setting.
If an allowable range is specified, set the value within that range.
The value of the parameter in the SERVOPACK will immediately change to the new value.

Wiring and Connection

3.1	Main Circuit Wiring	3-2
3.1.1	Main Circuit Terminals (CN3, CN4)	3-2
3.1.2	Main Circuit Wires	3-3
3.1.3	Typical Main Circuit Wiring Examples	3-4
3.1.4	Power Supply Capacities and Power Losses	3-5
3.1.5	Input Power Supply, Molded-case Circuit Breaker, and Fuse	3-5
3.1.6	Using More Than One SERVOPACK	3-6
3.1.7	General Precautions for Wiring	3-7
3.2	I/O Signal Connections	3-9
3.2.1	I/O Signal (CN1) Names and Functions	3-9
3.2.2	Example of I/O Signal Connections	3-10
3.3	I/O Signal Allocations	3-11
3.3.1	Input Signal Allocations	3-11
3.3.2	Output Signal Allocations	3-17
3.4	Examples of Connection to Host Controller	3-21
3.4.1	Sequence Input Circuit	3-21
3.4.2	Sequence Output Circuit	3-22
3.5	Wiring MECHATROLINK-II Communications	3-23
3.6	Encoder Connection	3-24
3.6.1	Encoder Signal (CN2) Names and Functions	3-24
3.6.2	Encoder Connection Examples	3-24
3.7	Noise Control and Measures for Harmonic Suppression	3-26
3.7.1	Wiring for Noise Control	3-26
3.7.2	Precautions on Connecting Noise Filter	3-28

3.1 Main Circuit Wiring

The names and specifications of the main circuit terminals are given below.

Also this section describes the general precautions for wiring and precautions under special environments.

3.1.1 Main Circuit Terminals (CN3, CN4)

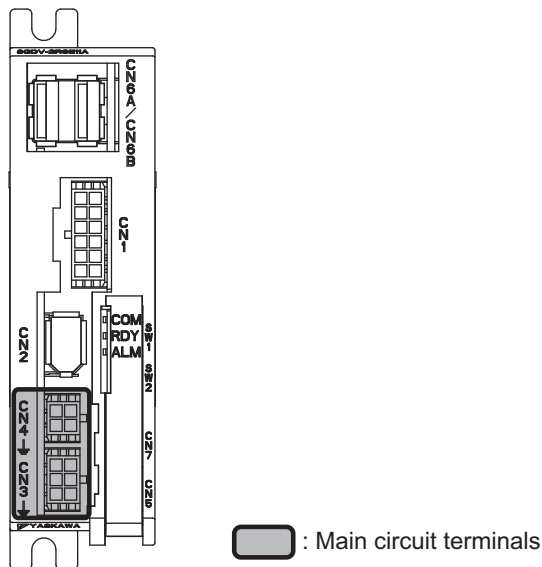

Connector Number	Terminal Symbol	Pin Number	Name	Specification
CN3	L1	6	Main circuit power input terminal (+)	24 VDC ±15% or 48 VDC ±15%
	L2	3	Main circuit power input terminal (-)	
	C1	5	Control power input terminal (+)	24 VDC ±15%
	C2	4	Control power input terminal (-)	
	⏏	1, 2	Ground terminals	Use for connecting the power supply ground terminal.
CN4	U	1	Servomotor connection terminal (phase U)	Use for connecting to the servomotor.
	V	2	Servomotor connection terminal (phase V)	
	W	3	Servomotor connection terminal (phase W)	
	⏏	4	Ground terminals	Use for connecting the servomotor ground terminal.

3.1.2 Main Circuit Wires

Use the following cables for main circuit. These cables are manufactured by YASKAWA Controls Co., Ltd.

Cable	Terminal Symbols	SERVOPACK Model: SGDV-	
		1R7E	2R9E
For power supply	L1, L2, C1, C2, $\underline{\underline{\perp}}$	JZSP-CF1G00-□□-E	
For servomotor main circuit	U, V, W, $\underline{\underline{\perp}}$	JZSP-CF1M00-□□-E (For servomotors without brakes) JZSP-CF1M10-□□-E (For servomotors with brakes) JZSP-CF1M20-□□-E (For servomotors without brakes, flexible type) JZSP-CF1M30-□□-E (For servomotors with brakes, flexible type)	

If you make cables by yourself, read the following items.

 IMPORTANT	<ul style="list-style-type: none"> • Wire sizes are selected for three cables per bundle at 40°C surrounding air temperature with the rated current. • Use the withstand voltage wires (for 100 V or more). • Use the wires whose outside diameter of insulator is 1.85 mm or less. • If cables are bundled in PVC or metal ducts, take into account the reduction of the allowable current. • Use a heat-resistant wire under high surrounding air or panel temperatures. • The length of cables for power supply is 10 m max., and the length of cables for servomotor main circuit is 50 m max.
-------------------------------------------------------------------------------------------------------	----------------------------------------------------------------------------------------------------------------------------------------------------------------------------------------------------------------------------------------------------------------------------------------------------------------------------------------------------------------------------------------------------------------------------------------------------------------------------------------------------------------------------------------------------------------------------------------------------------------------------------------------------------------

Cable	SERVOPACK Model: SGDV-		Remarks	
	1R7E	2R9E		
CN3 for power supply	Connector	43025-0600 (Made by Molex Japan Co., Ltd.)	6 poles	
	Contact	43030-0001 (Made by Molex Japan Co., Ltd.)	-	
	For main circuit power supply (L1, L2, $\underline{\underline{\perp}}$)	UL1007, AWG20	Rated voltage 300 V, Rated temperature 80°C	
	For control circuit power supply (C1, C2, $\underline{\underline{\perp}}$)	UL1007, AWG20	Rated voltage 300 V, Rated temperature 80°C	
CN4 for servomotor main circuit	Connector (SERVOPACK side)	43025-0400 (Made by Molex Japan Co., Ltd.)	4 poles	
	Contact (SERVOPACK side)	43030-0001 (Made by Molex Japan Co., Ltd.)	-	
	Connector (servomotor side)	without brake	43020-0401 (Made by Molex Japan Co., Ltd.)	4 poles
		with brake	43020-0601 (Made by Molex Japan Co., Ltd.)	6 poles
	Contact (servomotor side)	43031-0001 (Made by Molex Japan Co., Ltd.)	-	
	Power line for servomotor main circuit (U, V, W, brake power supply, $\underline{\underline{\perp}}$)	UL1007, AWG20	Rated voltage 300 V, Rated temperature 80°C	

3.1.3 Typical Main Circuit Wiring Examples

Note the following points when designing the power ON sequence.

- Design the power ON sequence so that main power is turned OFF when a servo alarm signal (ALM) is output.
- The ALM signal is output for a maximum of five seconds when the control power is turned ON. Take this into consideration when designing the power ON sequence. Design the sequence so the ALM signal is activated and the alarm detection relay (1Ry) is turned OFF to stop the main circuit's power supply to the SERVOPACK.

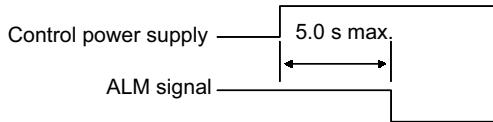

- Select the power supply specifications for the parts in accordance with the input power supply.



IMPORTANT

- When turning ON the control power supply and the main circuit power supply, turn them ON at the same time or turn the main circuit power supply after the control power supply. When turning OFF the power supplies, first turn the power for the main circuit OFF and then turn OFF the control power supply.
- Provide separate AC/DC power supplies for the main circuits and for controls.
- Power supplies must have double or reinforced insulation that conforms to safety standards.
- Do not connect devices (such as motors or solenoids) that greatly change the load or devices (such as electromagnetic switches) that generate surge voltages to the controller power line.

Failure to observe this caution may result in deterioration of the internal elements or a blown fuse.

The typical main circuit wiring examples are shown below.

WARNING

- Voltage remains in the SERVOPACK even after the power supply is turned OFF. To prevent electric shock, do not touch the input terminals for the main circuit power supply or those for the control power supply. Before wiring or inspections, confirm that the SERVOPACK has completely discharged.

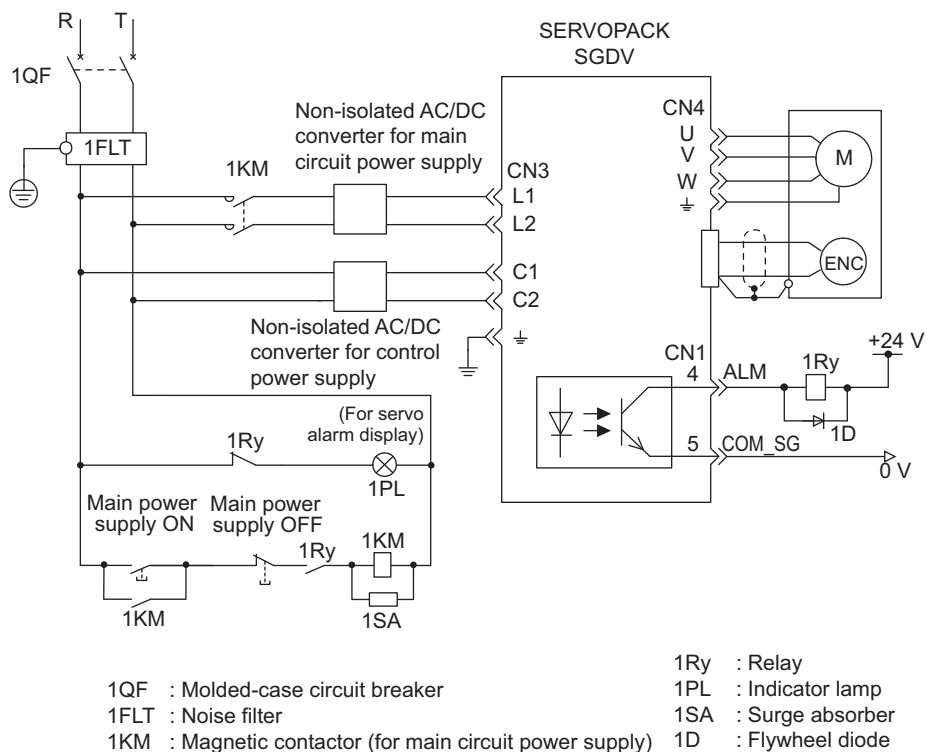

3.1.4 Power Supply Capacities and Power Losses

The following table shows the SERVOPACK's power supply capacities and power losses.

Main Circuit Power Supply	Maximum Applicable Servomotor Capacity [W]	SERVOPACK Model SGD V-	Power Supply Capacity per SERVOPACK [W]	Output Current [Arms]	Main Circuit Power Loss [W]	Control Circuit Power Loss [W]	Total Power Loss [W]
24 VDC	11	1R7E	108	1.7	3.4	7.2	10.6
	30	2R9E	165	2.9	6.9		14.1
48 VDC	11	1R7E	169	1.7	3.4		10.6
	30	2R9E	411	2.9	6.9		14.1

3.1.5 Input Power Supply, Molded-case Circuit Breaker, and Fuse

Use input power supplies that meet the following conditions.

- The main circuit power supply must be a 24-VDC or a 48-VDC power supply.
- The control circuit power supply must be a 24-VDC power supply.
- The main circuit power supply and the control power supply must be two separate input power supplies.
- Power supplies must have double or reinforced insulation that conforms to safety standards.

When choosing molded-case circuit breakers and fuses for input power supplies on the AC side, confirm the specifications of the input power supplies and refer to this table.

Also, choose molded-case circuit breakers and fuses that meet the following cutoff characteristics.

Cutoff characteristics (25°C): ·300% of the rated load input current, five seconds min.

·Does not cut off at the inrush current value of the power supply.

SERVOPACK Model SGD V-	Main Circuit Power Supply	Max. Applicable Servomotor Capacity [W]	Power Supply Capacity per SERVOPACK ^{*1} [W]	Input Current Capacity			Rated Voltage			
				Main Circuit		Control Circuit ^{*2} [A]	Fuse [V]		MCCB [V]	
				Continuous Rated [A]	Instantaneous Max. [A]		100 V 200 V	400 V	100 V 200 V	400 V
1R7E	24 VDC	11	108	2.0	5.5	0.3	250	600	240	480
	48 VDC		169	1.0	4.5					
2R9E	24 VDC	30	165	3.5	8.5					
	48 VDC		411	2.0	10.5					

*1. Values with instantaneous maximum load.

*2. Values with rated load.

3.1.6 Using More Than One SERVOPACK

This section shows an example of the wiring and the precautions when more than one SERVOPACK is used.

(1) Wiring Example

The alarm output (ALM) of each SERVOPACK operates a separate alarm detection relay (1Ry, 2Ry or 3Ry). When the alarm occurs, the ALM output signal transistor is turned OFF.

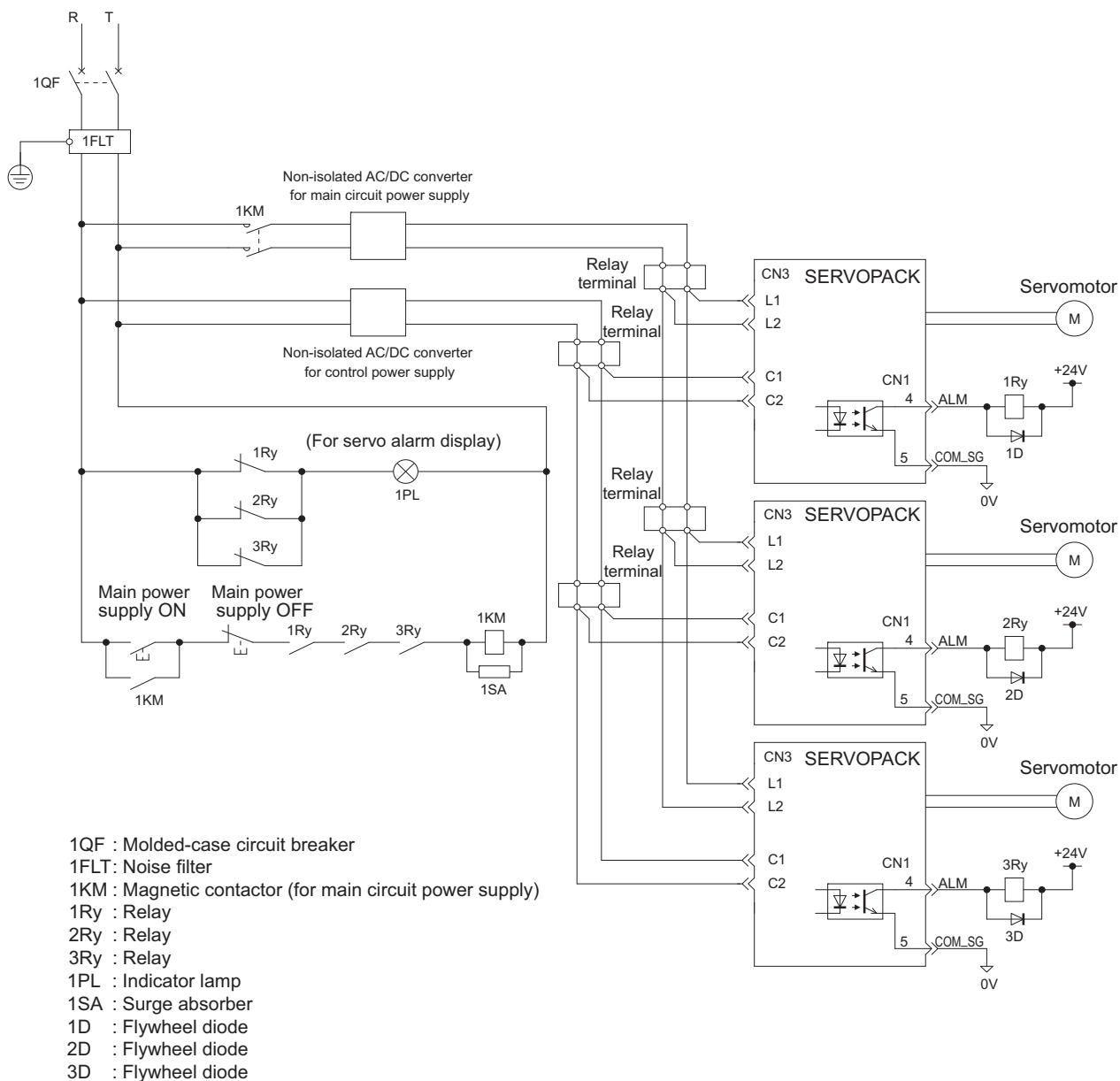

(2) Precautions

- Multiple SERVOPACKs can share a single molded-case circuit breaker (1QF) or noise filter. Always select a molded-case circuit breaker or noise filter that has enough capacity for the total power supply capacity (load conditions) of the SERVOPACKs.
- The same ground, COM_SG, is used for all four sequence output signals for a Σ -series SERVOPACK with a DC power input. If the alarm outputs from the SERVOPACKs are connected in series, it will not be possible to receive the output signals normally when an alarm occurs.

3.1.7 General Precautions for Wiring



IMPORTANT

- Always use a molded-case circuit breaker (1QF) or a fuse to protect the servo system from intersystem faults.
- Install a ground fault detector.
The SERVOPACK does not have a built-in protective circuit for grounding. To configure a safer system, install a ground fault detector against overloads and short-circuiting, or install a ground fault detector combined with a molded-case circuit breaker.
- Do not turn the power ON and OFF more than necessary.
 - Do not use the SERVOPACK for applications that require the power to turn ON and OFF frequently. Such applications will cause elements in the SERVOPACK to deteriorate.
 - As a guideline, at least one hour should be allowed between the power being turned ON and OFF once actual operation has been started.

To ensure safe, stable application of the servo system, observe the following precautions when wiring.

- Use the connection cables specified in *ΣV Series Product Catalog* (Catalog No.: KAEP S800000 42). Design and arrange the system so that each cable will be as short as possible.
- Use shielded twisted-pair cables or screened unshielded twisted-pair cables for I/O signal cables and encoder cables.
- The maximum wiring length is 3 m for I/O signal cables, 50 m for servomotor main circuit cables and encoder cables, and 10 m for power supply cables.
- Observe the following precautions when wiring the ground.
 - Use a cable as thick as possible.
 - Ground to a ground resistance of 100 Ω or less.
 - Be sure to ground at only one point.
 - Ground the servomotor directly if the servomotor is insulated from the machine.
- The signal cable conductors are as thin as 0.2 mm² or 0.3 mm². Do not impose excessive bending force or tension.

■ Precaution When Wiring a Magnetic Contactor on the DC Side of the Main Circuit Power Supply

To shut OFF the main circuit power supply to the SERVOPACK, we recommend that you do so on the AC side of the AC/DC power supply. To shut OFF the power supply on the DC side, connect a capacitor (1C) with the following specifications after the magnetic contactor (1KM). Wire the capacitor (1C) as close to the SERVOPACK as possible.

Main Circuit Power Supply	SERVOPACK Model	Recommended Capacitor Specifications per SERVOPACK			
		Rated Voltage	Rated Capacitance	Recommended Capacitor	
				Model*	Manufacturer
24 VDC	SGDV-1R7E□1A	50 VDC min.	3,000 μF to 3,900 μF	UPJ1H152MHD × 2	Nichicon Corporation
	SGDV-2R9E□1A		3,600 μF to 4,700 μF	UPJ1H182MHD × 2	
48 VDC	SGDV-1R7E□1A	100 VDC min.	2,700 μF to 3,900 μF	LGU2A272MELB	
	SGDV-2R9E□1A		3,300 μF to 4,700 μF	LGU2A332MELB	

* Use the capacitor given above or the equivalent.



IMPORTANT

- The larger the capacitance of the capacitor (1C), the more charging current will flow when the power supply is turned ON. Select an AC/DC power supply so that there will not be insufficient current. Consult the manufacturer of the power supply for the output current capacity of the power supply.
- If you connect a capacitor (1C), more time may be required until the servo ready output signal (/S-RDY) turns ON. Consider this when you design the operation sequence.
Also, more time will be required to discharge after the main circuit power supply is shut OFF. Be careful of electric shock.
For the recommended AC/DC power supplies, refer to the *Σ-V Series Product Catalog* (Catalog No.: KAEP S800000 42).

A wiring example is provided below for connecting a magnetic contactor on the DC side of the main circuit power supply.

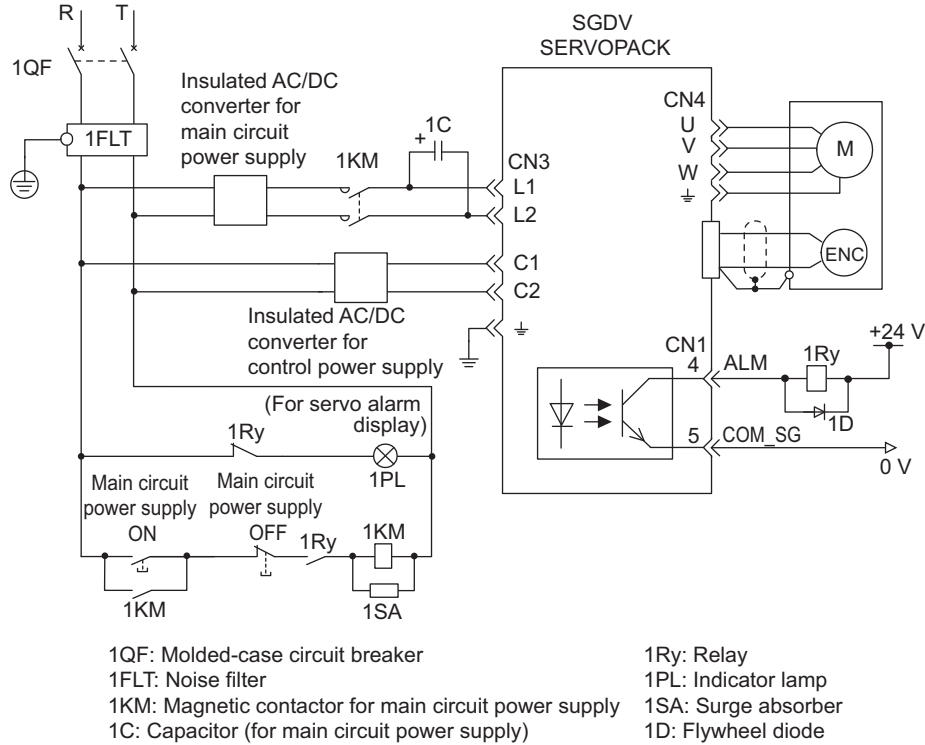

3.2 I/O Signal Connections

This section describes the names and functions of I/O signals (CN1). Also connection examples by control method are shown.

3.2.1 I/O Signal (CN1) Names and Functions

The following table shows the names and functions of I/O signals (CN1).

(1) Input Signals

Signal	Pin No.	Name	Function	Reference Section
/DEC	7	Homing deceleration switch signal	Connects the deceleration limit switch for homing.	–
P-OT N-OT	3 8	Forward run prohibited, Reverse run prohibited	With overtravel prevention: Stops servomotor when movable part travels beyond the allowable range of motion.	4.3.1
/EXT 1	Can be allocated	External latch signal 1	Connects the external signals that latch the current feedback pulse counter. Note: To use this signal, allocate it to CN1-7.	–
+24VIN	2	Control power supply for sequence signal	Control power supply input for sequence signals Allowable voltage fluctuation range: 11 to 25 V Note: The 24 VDC power supply is not included.	3.4.1

- Note 1. The functions allocated to /DEC, P-OT, and N-OT input signals can be changed by using the parameters. For details, refer to 3.3.1 *Input Signal Allocations*.
2. To use /EXT1, allocate it to CN1-7. For details, refer to 3.3.1 *Input Signal Allocations*.
3. If the Forward run prohibited/ Reverse run prohibited function is used, the SERVOPACK is stopped by software controls, not by electrical or mechanical means. If the application does not satisfy the safety requirements, add an external circuit for safety reasons as required.

(2) Output Signals

Signal	Pin No.	Name	Function	Reference Section
ALM	4	Servo alarm output signal	Turns OFF when an error is detected.	–
/BK (/SO1)	11	Brake interlock signal	Controls the brake. The brake is released when the signal turns ON. Allocation can be changed to general-purpose output signals (/SO1).	4.3.2
/SO2 /SO3	10 9	General-purpose output signal	Used for general-purpose output. Note: Set the parameter to allocate a function.	–
/COIN /V-CMP /TGON /S-RDY /CLT /VLT /WARN /NEAR	Can be allocated	Positioning completion Speed coincidence detection Rotation detection Servo ready Torque limit Speed limit detection Warning Near	The allocation of an output signal to a pin can be changed in accordance with the function required.	–
COM_SG	5	Common output ground	Common output ground for the output signals (/SO1 to /SO3).	–
FG	1	Frame ground	Connects the shielded wire from the I/O signal cable.	–

Note: The functions allocated to /SO1 to /SO3 output signals can be changed by using the parameters. For details, refer to 3.3.2 *Output Signal Allocations*.

3.2.2 Example of I/O Signal Connections

The following diagram shows a typical connection example.

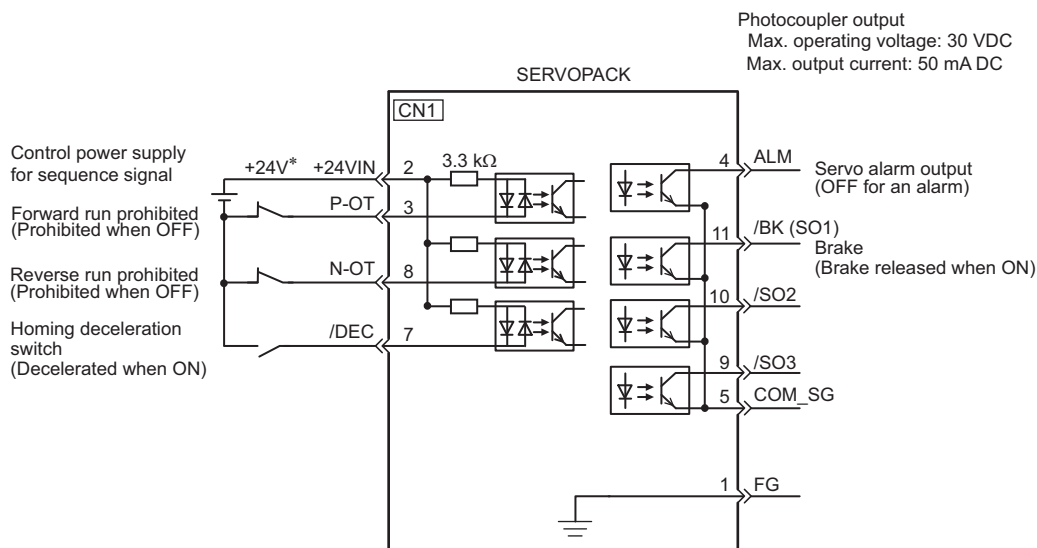

* The 24-VDC power supply is not included. Use a 24-VDC power supply with double insulation or reinforced insulation.

Note: The functions allocated to the input signals /DEC, P-OT, N-OT and the output signals /SO1, /SO2, and /SO3 can be changed by using the parameters. Refer to 3.3.1 *Input Signal Allocations* and 3.3.2 *Output Signal Allocations*.

3.3 I/O Signal Allocations

This section describes the I/O signal allocations.

3.3.1 Input Signal Allocations

IMPORTANT

- Inverting the polarity of the forward run prohibited and reverse run prohibited signals from the factory setting will prevent the overtravel function from working in case of signal line disconnections or other failures. If this setting is absolutely necessary, check the operation and confirm that there are no safety problems.
- When two or more signals are allocated to the same input circuit, input signal level is valid for all allocated signals, resulting in an unexpected machine operation.

Input signals are allocated as shown in the following table.

Refer to the *Interpreting the Input Signal Allocation Tables* and change the allocations accordingly.

<Interpreting the Input Signal Allocation Tables>

Input Signal Names and Parameters	Validity Level	Input Signal	CN1 Pin Numbers			Connection Not Required (SERVOPACK judges the connection)	
			7	3	8	Always ON	Always OFF
Forward Run Prohibited Pn50A.3	H	P-OT	0	1	2 to 6	7	8
	L	/P-OT	9	A	B to F		

The parameter set values to be used are shown. Signals are allocated to CN1 pins according to the selected set values. Values in cells in bold lines are the factory settings.

Level at which input signal allocations are valid.

If always ON (7) or always OFF (8) is set, signals will be processed in the SERVOPACK, which will eliminate the need for wiring changes.

Input Signal Names and Parameters	Validity Level	Input Signal	CN1 Pin Numbers			Connection Not Required (SERVOPACK judges the connection)	
			7	3	8	Always ON	Always OFF
Forward Run Prohibited Pn50A.3	H	P-OT	0	1	2 to 6	7	8
	L	/P-OT	9	A	B to F		
Reverse Run Prohibited Pn50B.0	H	N-OT	0	1	2 to 6	7	8
	L	/N-OT	9	A	B to F		
Forward External Torque Limit Pn50B.2	L	/P-CL	0	1	2 to 6	7	8
	H	P-CL	9	A	B to F		

(cont'd)

Input Signal Names and Parameters	Validity Level	Input Signal	CN1 Pin Numbers			Connection Not Required (SERVOPACK judges the connection)	
			7	3	8	Always ON	Always OFF
Reserve External Torque Limit Pn50B.3	L	/N-CL	0	1	2 to 6	7	8
	H	N-CL	9	A	B to F		
Homing Deceleration LS Pn511.0	L	/DEC	0	1	2 to 6	7	8
	H	DEC	9	A	B to F		
External Latch Signal 1 Pn511.1	L	/EXT1	0 to 6	-	-	7	8
	H	EXT1	9 to F	-	-		

■ Example of Changing Input Signal Allocations

The procedure to set the forward run prohibited signal (P-OT) allocated CN1-3 to “enable forward drive” and instead allocate the forward external torque limit signal (P-CL) to CN1-3 is shown below.

<Parameter Changes>

- Pn50A is changed from n.1881 to n.8881.
- Pn50B is changed from n.8882 to n.8182.

1. In the SigmaWin+ main window, click **Parameters - Edit Parameters**.

The **Parameter Editing** dialog box will appear.

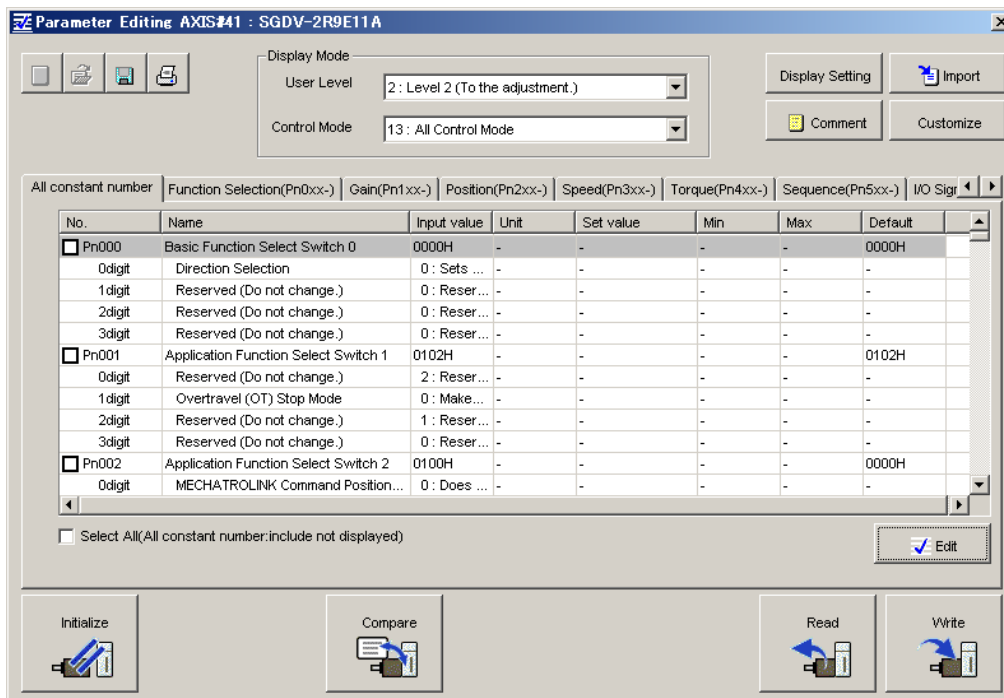

2. Select Pn50A.

If Pn50A cannot be seen in the **Parameter Editing** dialog box, click the arrows button to view the parameter.

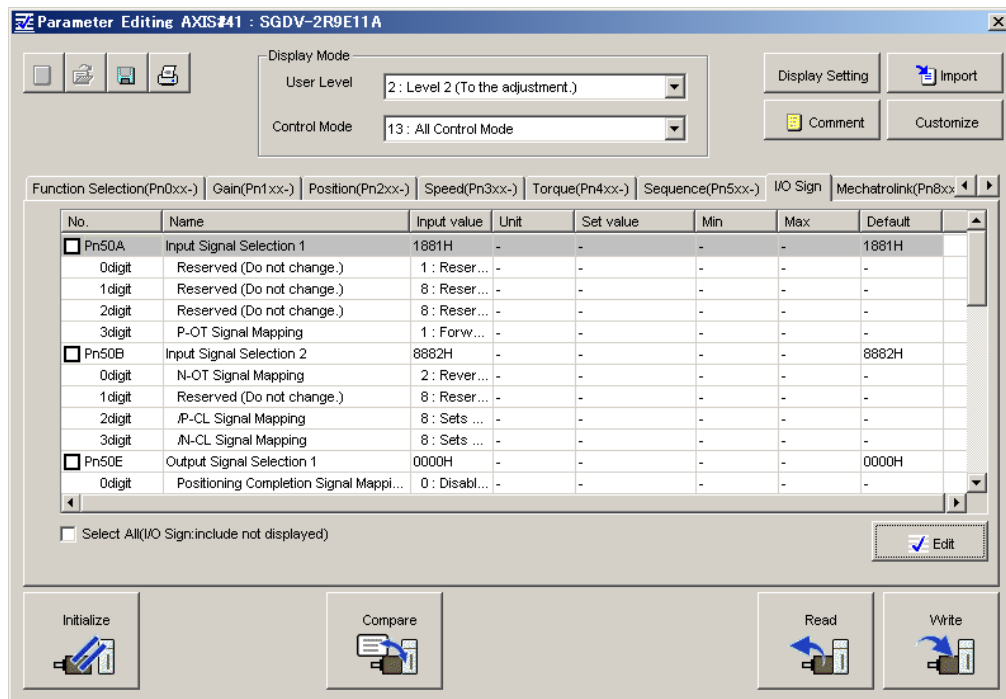

3. Click **Edit**.

The **Edit** box for Pn50A will appear.

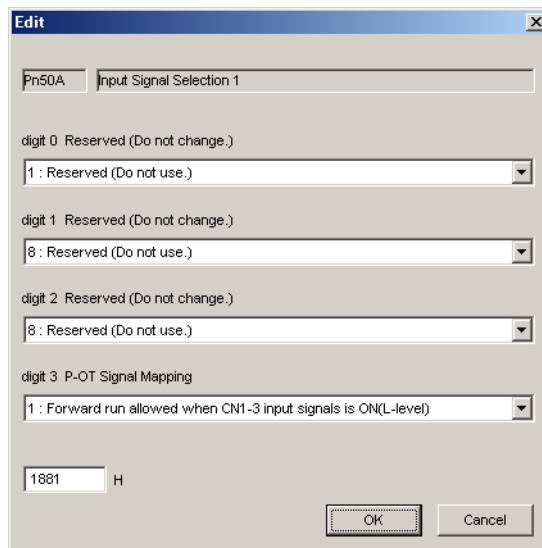

4. For the 3rd digit, select **8: Forward run allowed** in the **P-OT Signal Mapping** list.

Edit

Pn50A Input Signal Selection 1

digit 0 Reserved (Do not change.)
1: Reserved (Do not use.)

digit 1 Reserved (Do not change.)
8: Reserved (Do not use.)

digit 2 Reserved (Do not change.)
8: Reserved (Do not use.)

digit 3 P-OT Signal Mapping
8: Forward run allowed

8881 H

OK Cancel

5. Click **OK**.

The **Edit** box will close, and **Parameter Editing** dialog box will appear again.

6. Select **Pn50B**.

If Pn50B cannot be seen in the **Parameter Editing** dialog box, click the arrows button to view the parameter.

Parameter Editing AXIS#41 : SGDV-2R9E11A

Display Mode
User Level: 2: Level 2 (To the adjustment.)
Control Mode: 13: All Control Mode

Function Selection(Pn0xx-) Gain(Pn1xx-) Position(Pn2xx-) Speed(Pn3xx-) Torque(Pn4xx-) Sequence(Pn5xx-) I/O Sign Mechatrolink(Pn8xx)

No.	Name	Input value	Unit	Set value	Min	Max	Default
<input checked="" type="checkbox"/>	Pn50A Input Signal Selection 1	8881H	-	-	-	-	1881H
0digit	Reserved (Do not change.)	1: Reser...	-	-	-	-	-
1digit	Reserved (Do not change.)	8: Reser...	-	-	-	-	-
2digit	Reserved (Do not change.)	8: Reser...	-	-	-	-	-
3digit	P-OT Signal Mapping	8: Forw...	-	-	-	-	-
<input type="checkbox"/>	Pn50B Input Signal Selection 2	8882H	-	-	-	-	8882H
0digit	N-OT Signal Mapping	2: Rever...	-	-	-	-	-
1digit	Reserved (Do not change.)	8: Reser...	-	-	-	-	-
2digit	/P-CL Signal Mapping	8: Sets ...	-	-	-	-	-
3digit	/N-CL Signal Mapping	8: Sets ...	-	-	-	-	-
<input type="checkbox"/>	Pn50E Output Signal Selection 1	0000H	-	-	-	-	0000H
0digit	Positioning Completion Signal Mappi...	0: Disabl...	-	-	-	-	-

Select All(I/O Sign:include not displayed)

Initialize Compare Read Write

7. Click **Edit**.

The **Edit** box for Pn50B will appear.

Edit

Pn50B Input Signal Selection 2

digit 0 N-OT Signal Mapping
2: Reverse run allowed when CN1-8 input signal is ON(L-level)

digit 1 Reserved (Do not change.)
8: Reserved (Do not use.)

digit 2 /P-CL Signal Mapping
8: Sets signal OFF

digit 3 /N-CL Signal Mapping
8: Sets signal OFF

8882 H

OK Cancel

8. For the 2nd digit, select **1: ON when CN1-3 input signal is ON (L-level)** in the **/P-CL Signal Mapping** list.

Edit

Pn50B Input Signal Selection 2

digit 0 N-OT Signal Mapping
2: Reverse run allowed when CN1-8 input signal is ON(L-level)

digit 1 Reserved (Do not change.)
8: Reserved (Do not use.)

digit 2 /P-CL Signal Mapping
1: ON when CN1-3 input signal is ON(L-level)

digit 3 /N-CL Signal Mapping
8: Sets signal OFF

8182 H

OK Cancel

9. Click OK.

The **Edit** box will close, and the **Parameter Editing** dialog box will appear again.

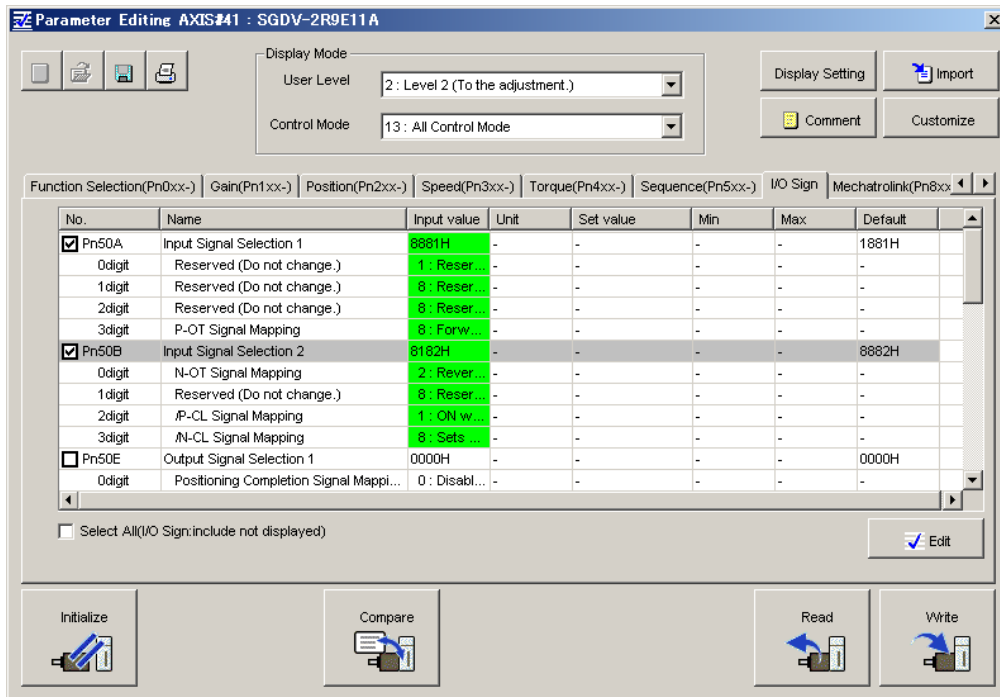

10. Click Write.

The following window will appear after the new parameter setting has been saved in the SERVOPACK.

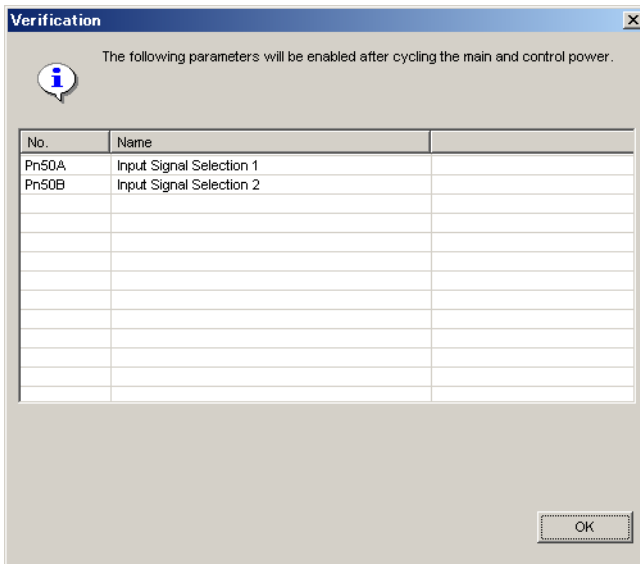

11. Click OK.

12. To enable the change in the setting, restart the SERVOPACK.

3.3.2 Output Signal Allocations



IMPORTANT

- The signals not detected are considered as "Invalid." For example, Positioning Completion (/COIN) signal in speed control is "Invalid."
- Inverting the polarity of the brake signal (/BK), i.e. positive logic, will prevent the holding brake from working in case of its signal line disconnection. If this setting is absolutely necessary, check the operation and confirm that there are no safety problems.
- When two or more signals are allocated to the same output circuit, a signal is output with OR logic circuit.

Output signals are allocated as shown in the following table.

Refer to the *Interpreting the Output Signal Allocation Tables* and change the allocations accordingly.

<Interpreting the Output Signal Allocation Tables>

The parameter set values to be used are shown. Signals are allocated to CN1 pins according to the selected set values. Values in cells in bold lines are the factory settings.

Output Signal Names and Parameters	Output Signal	CN1 Pin Numbers			Invalid (not use)
		11	10	9	
Brake Pn50F.2	/BK	1	2	3	0
Positioning Completion Pn50E.0	/COIN	1	2	3	0
Speed Coincidence Detection Pn50E.1	/V-CMP	1	2	3	0
Rotation Detection Pn50E.2	/TGON	1	2	3	0
Servo Ready Pn50E.3	/S-RDY	1	2	3	0
Torque Limit Detection Pn50F.0	/CLT	1	2	3	0
Speed Limit Detection Pn50F.1	/VLT	1	2	3	0
Brake Pn50F.2	/BK	1	2	3	0
Warning Pn50F.3	/WARN	1	2	3	0
Near Pn510.0	/NEAR	1	2	3	0
Pn512.0=1	Polarity inversion of CN1-11				0
Pn512.1=1	Polarity inversion of CN1-10				(Not invert at factory setting)
Pn512.2=1	Polarity inversion of CN1-9				

■ Example of Changing Output Signal Allocations

The procedure to set the position completion signal (/COIN) that was previously disabled is allocated to CN1-10 is shown below.

<Parameter Changes>

- Pn50E is changed from n.0000 to n.0002.

1. In the SigmaWin+ main window, click **Parameters - Edit Parameters**.

The **Parameter Editing** dialog box will appear.

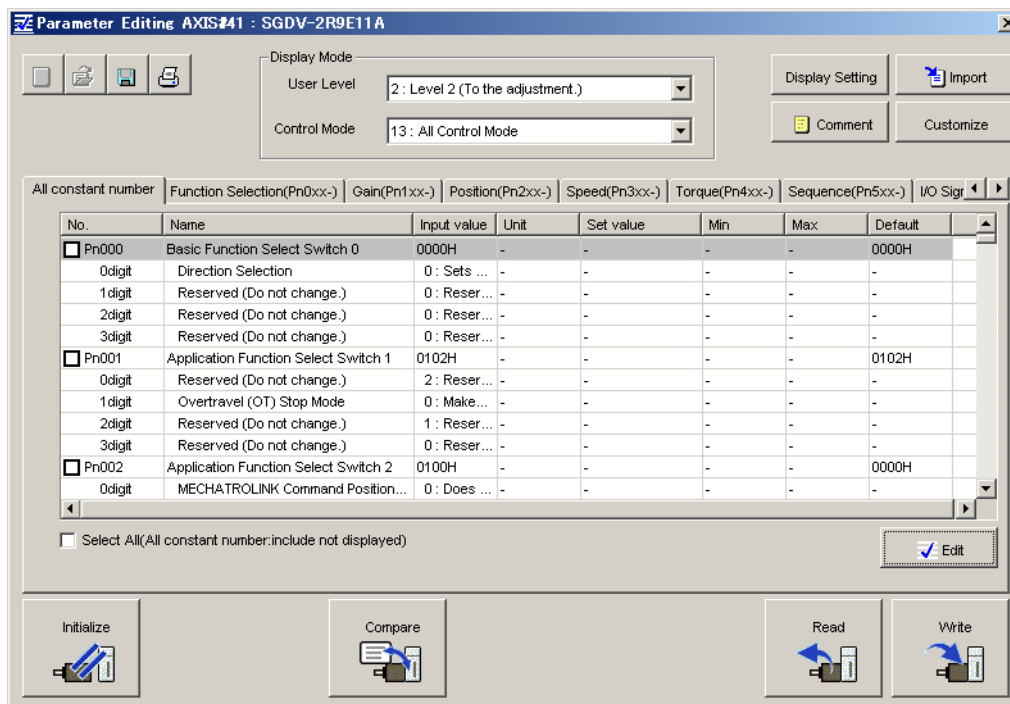

2. Select Pn50E.

If Pn50E cannot be seen in the **Parameter Editing** dialog box, click the arrows button to view the parameter.

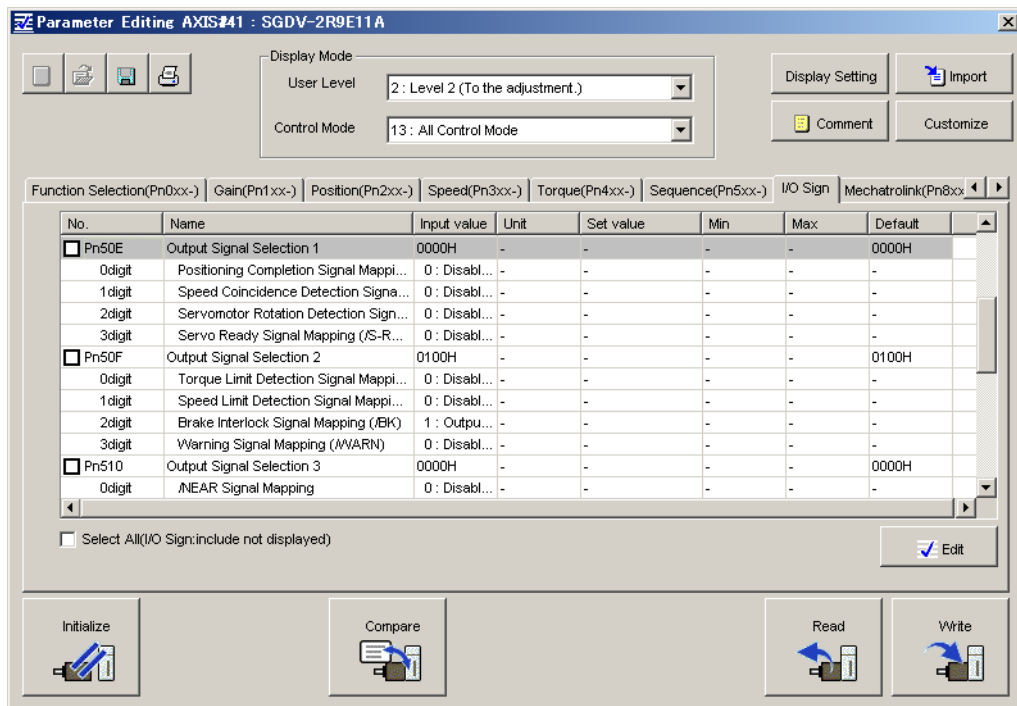

3. Click Edit.

The **Edit** box for Pn50E will appear.

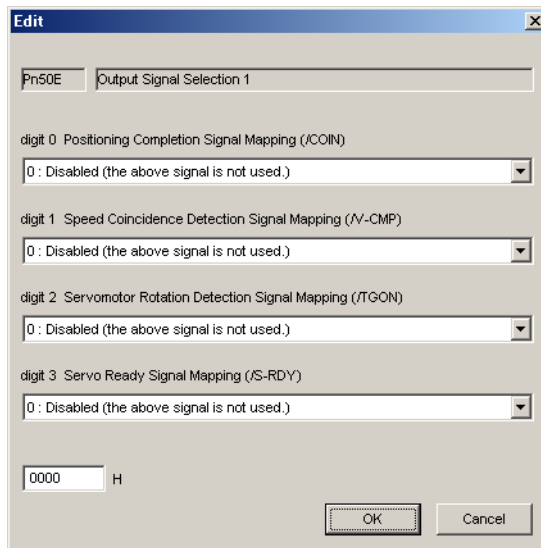

4. For the zero digit, select **2: Outputs the signal from CN1-10 output terminal** in the **Positioning Completion Signal Mapping (/COIN)** list.

Edit

Pn50E Output Signal Selection 1

digit 0 Positioning Completion Signal Mapping (/COIN)
2: Outputs the signal from CN1-10 output terminal

digit 1 Speed Coincidence Detection Signal Mapping (/V-CMP)
0: Disabled (the above signal is not used.)

digit 2 Servomotor Rotation Detection Signal Mapping (/TGON)
0: Disabled (the above signal is not used.)

digit 3 Servo Ready Signal Mapping (/S-RDY)
0: Disabled (the above signal is not used.)

0002 H

OK Cancel

5. Click **OK**.

The **Edit** box will close, and the **Parameter Editing** dialog box will appear again.

6. Click **Write**.

The following window will appear after the new parameter setting has been saved in the SERVOPACK.

Verification

The following parameters will be enabled after cycling the main and control power.

No.	Name
Pn50E	Output Signal Selection 1

OK

7. Click **OK**.

8. To enable the change in the setting, restart the SERVOPACK.

3.4 Examples of Connection to Host Controller

This section shows examples of SERVOPACK I/O signal connection to the host controller.

3.4.1 Sequence Input Circuit

(1) Photocoupler Input Circuit

CN1 connector terminals 2, 3, 7, 8 are explained below.

The sequence input circuit interface is connected through a relay or open-collector transistor circuit. When connecting through a relay, use a low-current relay. If a low-current relay is not used, a faulty contact may result.

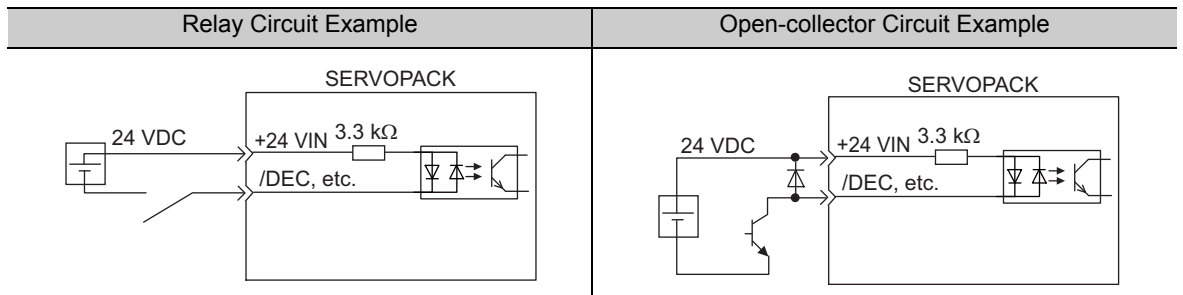

Note: The 24 VDC external power supply capacity must be 50 mA minimum.

The SERVOPACK's input circuit uses bidirectional photocoupler. Select either the sink circuit or the source circuit according to the specifications required for each machine.

- Note:
- The connection example in 3.2.2 shows sink circuits.
 - The ON/OFF polarity differs between when a sink circuit is connected and when a source circuit is connected.

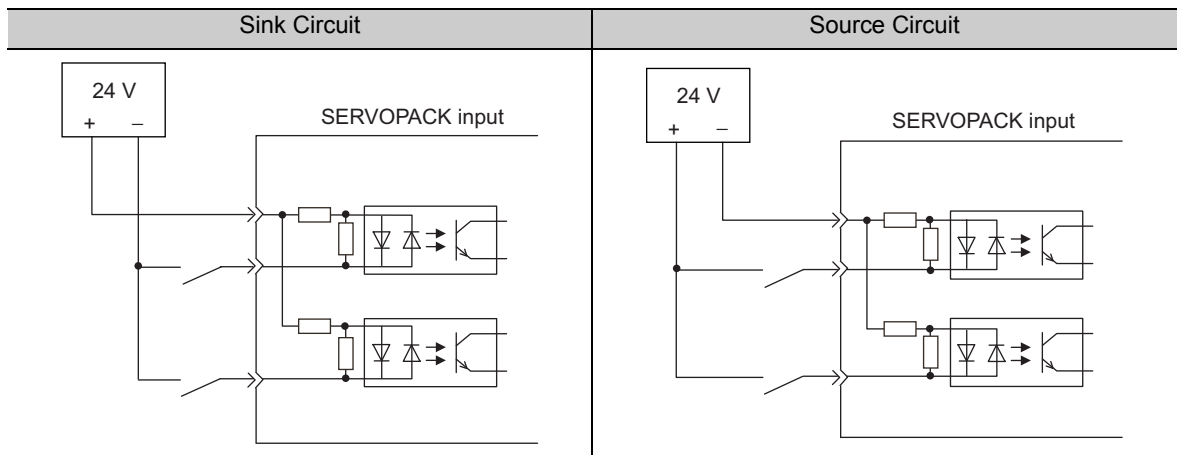

Input Signal Polarities				Input Signal Polarities			
Signal	Level	Voltage Level	Contact	Signal	Level	Voltage Level	Contact
ON	Low (L) level	0 V	Close	ON	High (H) level	24 V	Close
OFF	High (H) level	24 V	Open	OFF	Low (L) level	0 V	Open

3.4.2 Sequence Output Circuit

The signal output circuit from the SERVOPACK is described below.

 IMPORTANT	<p>Incorrect wiring or incorrect voltage application to the output circuit may cause short-circuit.</p> <p>If a short-circuit occurs as a result of any of these causes, the holding brake will not work. This could damage the machine or cause an accident resulting in death or injury.</p>
-------------------------------------------------------------------------------------------------------	------------------------------------------------------------------------------------------------------------------------------------------------------------------------------------------------------------------------------------------------------------------------------------------------

(1) Photocoupler Output Circuit

Photocoupler output circuits are used for servo alarm (ALM) and other sequence output signal circuits. Connect a photocoupler output circuit through a relay or line receiver circuit.

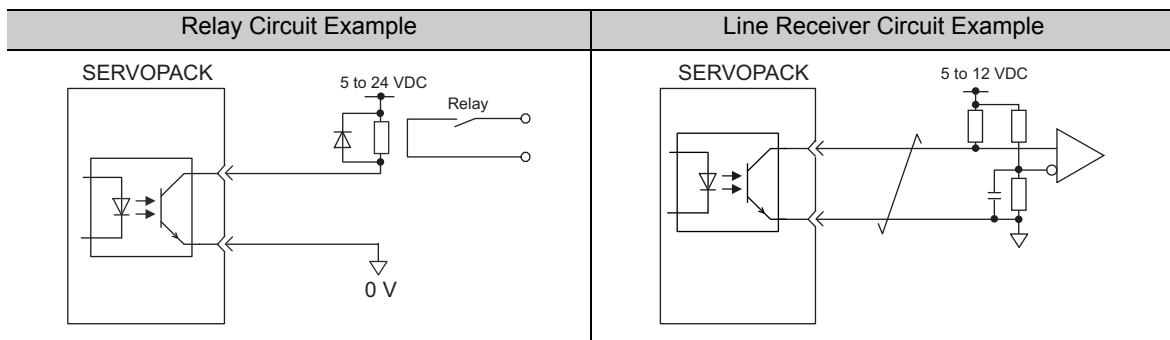

Note: The maximum allowable voltage and the allowable range of current capacity for photocoupler output circuits are as follows.

- Voltage: 30 VDC
- Current: 5 to 50 mA DC

3.5 Wiring MECHATROLINK-II Communications

The following diagram shows an example of connections between a host controller and a SERVOPACK using MECHATROLINK-II communications cables (CN6A, CN6B).

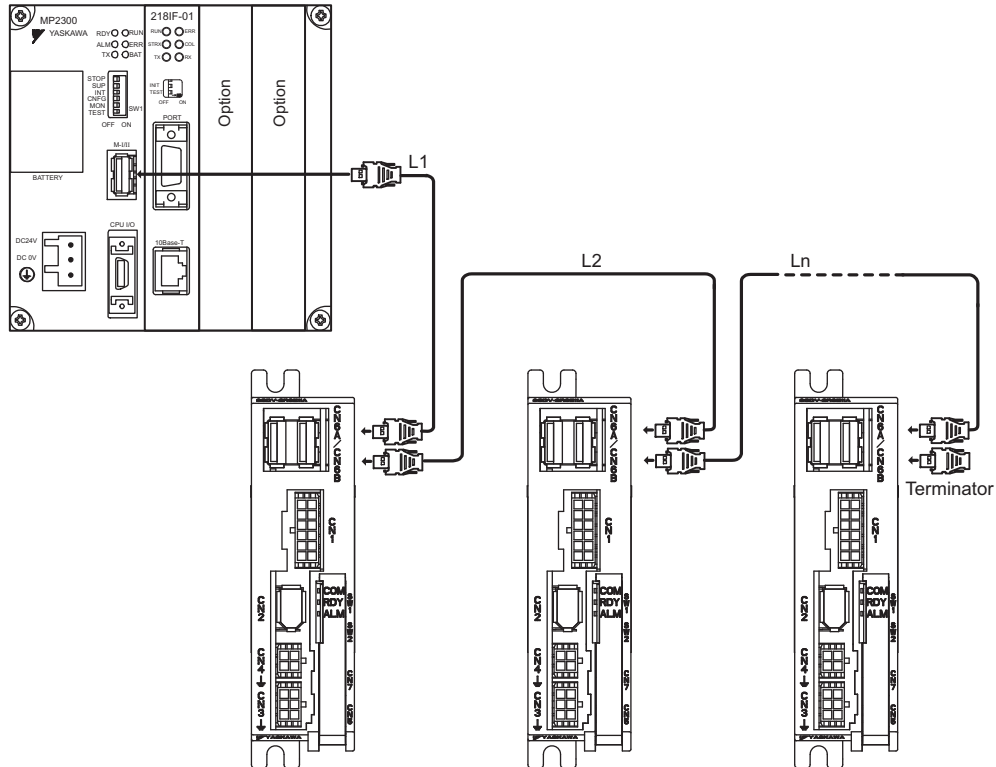

- Note 1. The length of the cable between stations (L1, L2 ... Ln) must be 0.5 m or more.
 2. The total cable length must be $L1 + L2 \dots + Ln \leq 50$ m.
 3. When multiple SERVOPACKs are connected by MECHATROLINK-II communications cable, a terminator must be installed at the final SERVOPACK.

3.6 Encoder Connection

This section describes the encoder signal (CN2) names, functions, and connection examples.

3.6.1 Encoder Signal (CN2) Names and Functions

The following table shows the names and functions of encoder signals (CN2).

Signal Name	Pin No.	Function
PG 5 V	1	Encoder power supply +5 V
PG 0 V	2	Encoder power supply 0 V
(BAT (+))*	3	Battery (+)
(BAT (-))*	4	Battery (-)
PS	5	Serial data (+)
/PS	6	Serial data (-)
Shield	Shell	—

* It is not necessary to connect these pins to the SERVOPACK.

3.6.2 Encoder Connection Examples

The following diagrams show connection examples of the encoder and the SERVOPACK.

(1) Using as an Incremental Encoder

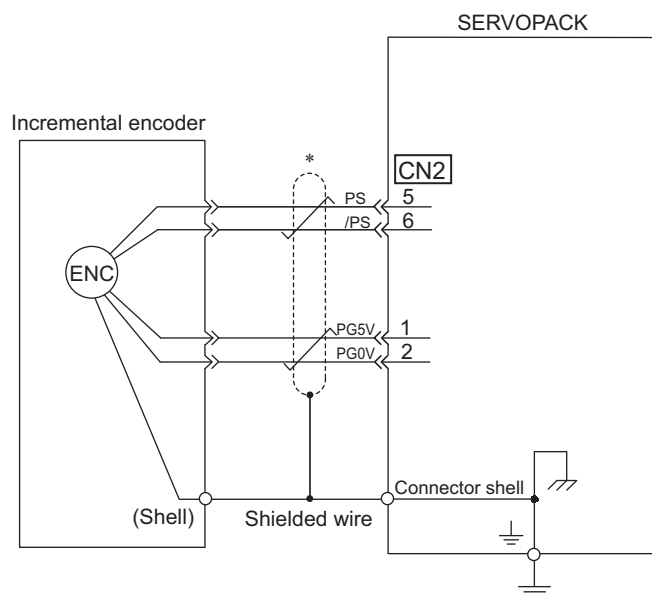

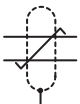
*  : represents shielded twisted-pair wires.

(2) Using as an Absolute Encoder

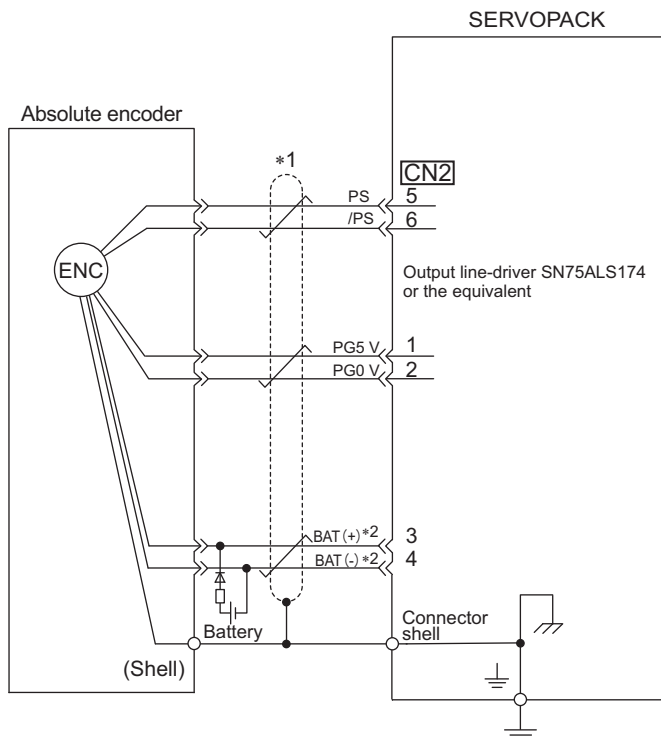

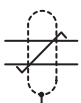
*1.  : represents shielded twisted-pair wires.

*2. When using an absolute encoder, provide power by installing an encoder cable with a JUSP-BA01-E Battery Case.

3.7 Noise Control and Measures for Harmonic Suppression

This section describes the wiring for noise control and the DC reactor for harmonic suppression.

3.7.1 Wiring for Noise Control



IMPORTANT

- Because the SERVOPACK is designed as an industrial device, it provides no mechanism to prevent noise interference.
- The SERVOPACK uses high-speed switching elements in the main circuit. Therefore peripheral devices may receive switching noise. If the equipment is to be used near private houses or if radio interference is a problem, take countermeasures against noise.
- If installation conditions by the EMC directive must be met, refer to *DC Power Input Σ -V Series User's Manual Setup Rotational Motor* (Manual No.: SIEP S800000 80).

The SERVOPACK uses microprocessors. Therefore it may receive switching noise from peripheral devices.

To prevent the noise from the SERVOPACK or the peripheral devices from causing a malfunction of any one of these devices, take the following precautions against noise as required.

- Position the input reference device and noise filter as close to the SERVOPACK as possible.
- Always install a surge absorber in the relay, solenoid and electromagnetic contactor coils.
- Do not bundle or run the servomotor main circuit cables together with the I/O signal cables or the encoder cables in the same duct. Keep the servomotor main circuit cables separated from the I/O signal cables and encoder cables by at least 30 cm.
- Do not share the power supply with an electric welder or electrical discharge machine. When the SERVOPACK is placed near a high-frequency generator, install a noise filter on the input side of the power supply cables. As for the wiring of noise filter, refer to (1) *Noise Filter* shown below.
- Take the grounding measures correctly. As for the grounding, refer to (2) *Correct Grounding*.

(1) Noise Filter

The SERVOPACK has a built-in microprocessor (CPU), so protect it from external noise as much as possible by installing a noise filter in the appropriate place.

The following is an example of wiring for noise control.

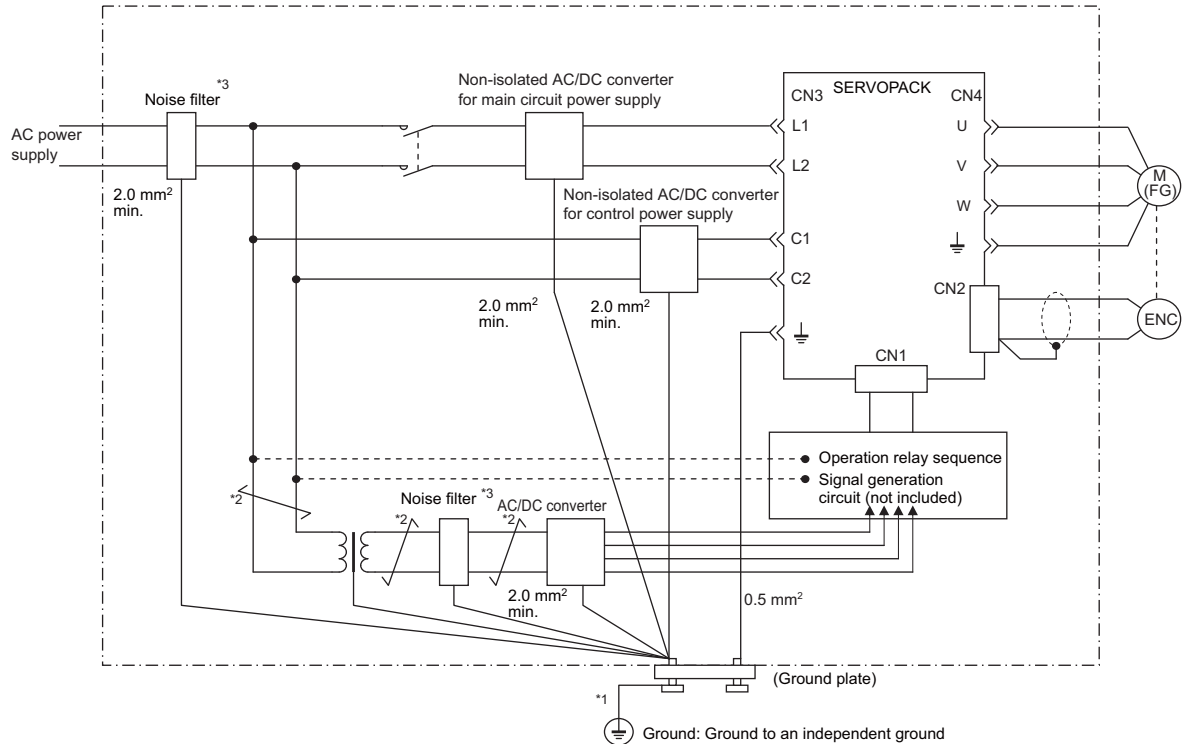

- *1. For ground wires connected to the ground plate, use a thick wire (preferably, plain stitch cooper wire).
- *2.  should be twisted-pair wires.
- *3. When using a noise filter, follow the precautions in 3.7.2 *Precautions on Connecting Noise Filter*.

(2) Correct Grounding

Take the following grounding measures to prevent the malfunction due to noise.

■ Grounding the Motor Frame

Always connect servomotor frame terminal FG to the SERVOPACK ground terminal \perp . Also be sure to ground the ground terminal \perp .

If the servomotor is grounded via the machine, a switching noise current will flow from the SERVOPACK main circuit through servomotor stray capacitance. The above grounding is required to prevent the adverse effects of switching noise.

■ Noise on the I/O Signal Cable

If the I/O signal cable receives noise, ground the 0 V line (SG) of the I/O signal cable. If the servomotor main circuit cable is accommodated in a metal conduit, ground the conduit and its junction box. For all grounding, ground at one point only.

3.7.2 Precautions on Connecting Noise Filter

This section describes the precautions on installing a noise filter.

(1) Noise Filter Brake Power Supply

If using a servomotor with a holding brake, use the following noise filter on the brake power supply input.

Model: FN2070-6/07 (Manufactured by SCHAFFNER Electronic.)

(2) Precautions on Using Noise Filters

Always observe the following installation and wiring instructions.

 IMPORTANT	<p>Some noise filters have large leakage currents. The grounding measures taken also affects the extent of the leakage current. If necessary, select an appropriate leakage current detector or leakage current breaker taking into account the grounding measures that are used and leakage current from the noise filter. Contact the manufacturer of the noise filter for details.</p>
-------------------------------------------------------------------------------------------------------	-------------------------------------------------------------------------------------------------------------------------------------------------------------------------------------------------------------------------------------------------------------------------------------------------------------------------------------------------------------------------------------------

Do not put the input and output lines in the same duct or bundle them together.

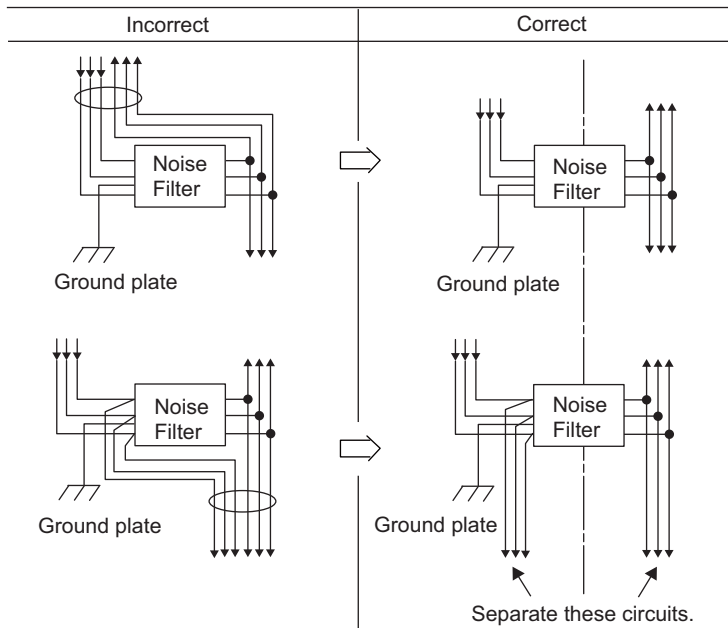

Separate the noise filter ground wire from the output lines.

Do not accommodate the noise filter ground wire, output lines and other signal lines in the same duct or bundle them together.

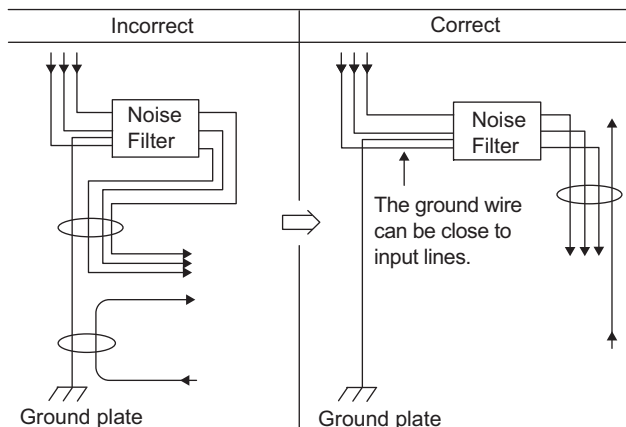

Connect the noise filter ground wire directly to the ground plate.
Do not connect the noise filter ground wire to other ground wires.

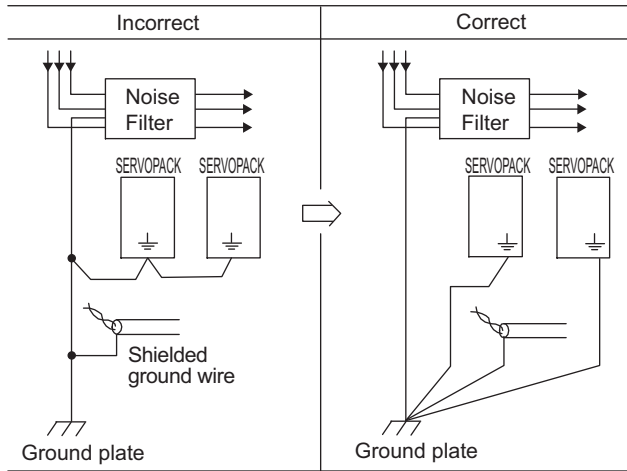

If a noise filter is located inside a control panel, first connect the noise filter ground wire and the ground wires from other devices inside the control panel to the ground plate for the control panel, then ground the plates.

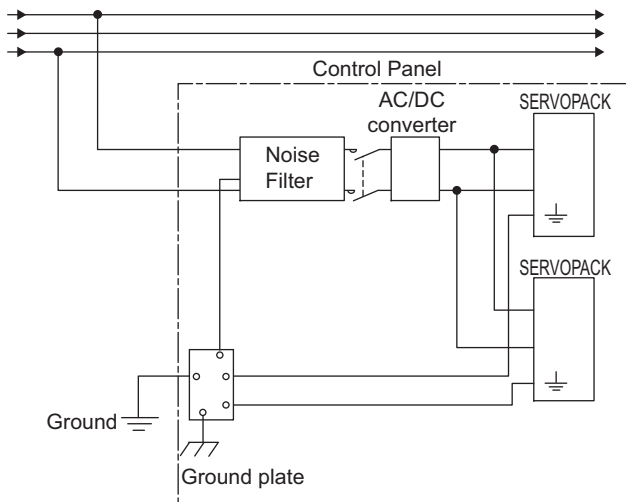

4.1	MECHATROLINK-II Communications Settings	4-3
4.1.1	Setting Switches SW1 and SW2	4-3
4.2	MECHATROLINK-II Commands	4-5
4.3	Basic Functions Settings	4-5
4.3.1	Servomotor Rotation Direction	4-5
4.3.2	Overtravel	4-6
4.3.3	Software Limit Settings	4-9
4.3.4	Holding Brakes	4-10
4.3.5	Stopping Servomotors after SV_OFF Command or Alarm Occurrence	4-15
4.3.6	Setting Motor Overload Detection Level	4-16
4.4	Trial Operation	4-18
4.4.1	Inspection and Checking before Trial Operation	4-18
4.4.2	Trial Operation via MECHATROLINK-II	4-19
4.4.3	Electronic Gear	4-20
4.5	Test Without Motor Function	4-22
4.5.1	Motor Information	4-22
4.5.2	Motor Position and Speed Responses	4-23
4.5.3	Limitations	4-24
4.6	Limiting Torque	4-25
4.6.1	Internal Torque Limit	4-25
4.6.2	External Torque Limit	4-26
4.6.3	Checking Output Torque Limiting during Operation	4-27
4.7	Absolute Encoders	4-28
4.7.1	Connecting the Absolute Encoder	4-28
4.7.2	Absolute Data Request (SENS ON Command)	4-29
4.7.3	Battery Replacement	4-30
4.7.4	Absolute Encoder Setup	4-32
4.7.5	Multiturn Limit Setting	4-35
4.7.6	Multiturn Limit Disagreement Alarm (A.CC0)	4-36
4.7.7	Absolute Encoder Origin Offset	4-39

4.8 Other Output Signals	4-40
4.8.1 Servo Alarm Output Signal (ALM)	4-40
4.8.2 Warning Output Signal (/WARN)	4-40
4.8.3 Rotation Detection Output Signal (/TGON)	4-41
4.8.4 Servo Ready Output Signal (/S-RDY)	4-41
4.8.5 Speed Coincidence Output Signal (/V-CMP)	4-42
4.8.6 Positioning Completed Output Signal (/COIN)	4-43
4.8.7 Positioning Near Output Signal (/NEAR)	4-44
4.8.8 Speed Limit Detection Signal (/VLT)	4-44

4.1 MECHATROLINK-II Communications Settings

This section describes the switch settings necessary for MECHATROLINK-II communications.

4.1.1 Setting Switches SW1 and SW2

The SW2 DIP switch is used to make the settings for MECHATROLINK-II communications.

The station address is set using the DIP switches (SW1, SW2).

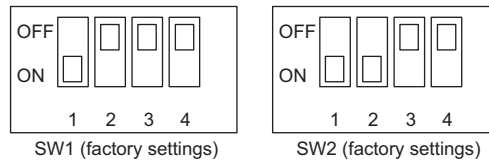

(1) Settings for the SW2 DIP Switch

The following table shows the settings of the DIP switch (SW2).

SW2	Function	Setting	Description	Factory setting
Pin 1	Sets the baud rate.	OFF	4 Mbps (MECHATROLINK-I)	ON
		ON	10 Mbps (MECHATROLINK-II)	
Pin 2	Sets the number of transmission bytes.	OFF	17 bytes	ON
		ON	32 bytes	
Pin 3	Sets the station address.	OFF	Station address = 40H + SW1	OFF
		ON	Station address = 50H + SW1	
Pin 4	Reserved. (Do not change.)	OFF	–	OFF



IMPORTANT

- When connecting to a MECHATROLINK-I network, turn OFF pins 1 and 2.
- When using a MECHATROLINK-I network (Baud rate: 4 Mbps), the settings for the number of transmission bytes is disabled and the number of transmission bytes is always 17.

(2) Setting the Station Address

The following table lists the possible settings of the DIP switches (SW1, SW2) that can be combined to form a station address.

The factory setting for the station address is 41H (Bit 3 of SW2 = OFF, Bit 1 of SW1 = ON, Bit 2 of SW1 = OFF, Bit 3 of SW1 = OFF, Bit 4 of SW1 = OFF).

Setting					Station Address
Bit 3 of SW2	Bit 1 of SW1	Bit 2 of SW1	Bit 3 of SW1	Bit 4 of SW1	
OFF	OFF	OFF	OFF	OFF	Disabled
OFF	ON	OFF	OFF	OFF	41H
OFF	OFF	ON	OFF	OFF	42H
OFF	ON	ON	OFF	OFF	43H
OFF	OFF	OFF	ON	OFF	44H
OFF	ON	OFF	ON	OFF	45H
OFF	OFF	ON	ON	OFF	46H
OFF	ON	ON	ON	OFF	47H
OFF	OFF	OFF	OFF	ON	48H
OFF	ON	OFF	OFF	ON	49H
OFF	OFF	ON	OFF	ON	4AH
OFF	ON	ON	OFF	ON	4BH
OFF	OFF	OFF	ON	ON	4CH
OFF	ON	OFF	ON	ON	4DH
OFF	OFF	ON	ON	ON	4EH
OFF	ON	ON	ON	ON	4FH
ON	OFF	OFF	OFF	OFF	50H
ON	ON	OFF	OFF	OFF	51H
ON	OFF	ON	OFF	OFF	52H
ON	ON	ON	OFF	OFF	53H
ON	OFF	OFF	ON	OFF	54H
ON	ON	OFF	ON	OFF	55H
ON	OFF	ON	ON	OFF	56H
ON	ON	ON	ON	OFF	57H
ON	OFF	OFF	OFF	ON	58H
ON	ON	OFF	OFF	ON	59H
ON	OFF	ON	OFF	ON	5AH
ON	ON	ON	OFF	ON	5BH
ON	OFF	OFF	ON	ON	5CH
ON	ON	OFF	ON	ON	5DH
ON	OFF	ON	ON	ON	5EH
ON	ON	ON	ON	ON	5FH



IMPORTANT

- To enable the change in the setting, restart the SERVOPACK.

4.2 MECHATROLINK-II Commands

For information on the MECHATROLINK-II commands, refer to *Σ-V Series User's Manual MECHATROLINK-II Commands* (Manual No.: SIEP S800000 54).

4.3 Basic Functions Settings

This section describes how to set the basic functions for operation.

4.3.1 Servomotor Rotation Direction

The servomotor rotation direction can be reversed with parameter Pn000.0 without changing the polarity of the speed/position reference.

The standard setting for forward rotation is counterclockwise (CCW) as viewed from the load end of the servomotor.

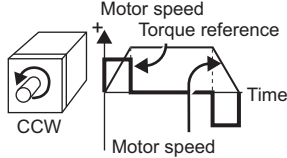
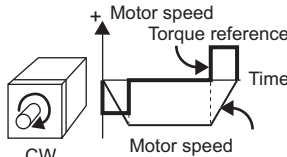
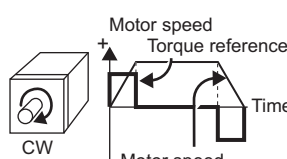
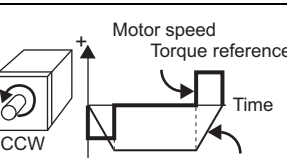
Parameter	Forward/Reverse Reference	Direction of Motor Rotation	Applicable Overtravel (OT)
Pn000	n.□□□0 Sets CCW as forward direction. [Factory setting]	Forward Reference 	P-OT
		Reverse Reference 	N-OT
	n.□□□1 Sets CW as forward direction. (Reverse Rotation Mode)	Forward Reference 	P-OT
		Reverse Reference 	N-OT

Note: SigmaWin+ trace waveforms are shown in the above table.

4.3.2 Overtravel

The overtravel limit function forces movable machine parts to stop if they exceed the allowable range of motion and turn ON a limit switch.

For rotating application such as disc table and conveyor, overtravel function is not necessary. In such a case, no wiring for overtravel input signals is required.

 **CAUTION**

- **Installing limit switches**
 For machines that move using linear motion, connect limit switches to P-OT and N-OT of CN1 as shown below to prevent machine damage. To prevent a contact fault or disconnection from causing accidents, make sure that the limit switches are normally closed.

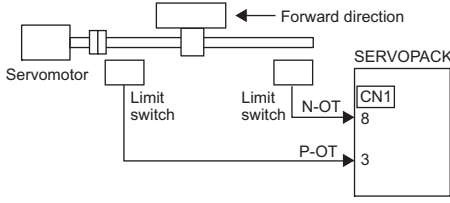
- **Axes to which external force is applied in overtravel**
Vertical axes:
 Occurrence of overtravel may cause a workpiece to fall, because the /BK signal is on, that is when the brake is released. Set the parameter (Pn001 = n.□□1□) to bring the servomotor to zero clamp state after stopping to prevent a workpiece from falling.
Other axes to which external force is applied:
 Overtravel will bring about a baseblock state after the servomotor stops, which may cause the servomotor to be pushed back by the load's external force. To prevent this, set the parameter (Pn001 = n.□□1□) to bring the servomotor to zero clamp state after stopping.
 For details on how to set the parameter, refer to (3) *Servomotor Stopping Method When Overtravel is Used*.

(1) Signal Setting

Type	Name	Connector Pin Number	Setting	Meaning
Input	P-OT	CN1-3	ON	Forward run allowed. Normal operation status.
			OFF	Forward run prohibited. Forward overtravel.
	N-OT	CN1-8	ON	Reverse run allowed. Normal operation status.
			OFF	Reverse run prohibited. Reverse overtravel.

Rotation in the opposite direction is possible during overtravel by inputting the reference.

(2) Overtravel Function Setting

Parameters Pn50A and Pn50B can be set to enable or disable the overtravel function.

If the overtravel function is not used, no wiring for overtravel input signals will be required.

Parameter		Meaning	When Enabled	Classification
Pn50A	n.1□□□ [Factory setting]	Inputs the Forward Run Prohibited (P-OT) signal from CN1-3.	After restart	Setup
	n.8□□□	Disables the Forward Run Prohibited (P-OT) signal. Allows constant forward rotation.		
Pn50B	n.□□□2 [Factory setting]	Inputs the Reverse Run Prohibited (N-OT) signal from CN1-8.		
	n.□□□8	Disables the Reverse Run Prohibited (N-OT) signal. Allows constant reverse rotation.		

A parameter can be used to re-allocate input connector number for the P-OT and N-OT signals. Refer to 3.3.1 *Input Signal Allocations* for details.

(3) Servomotor Stopping Method When Overtravel is Used

There are two servomotor stopping methods when an overtravel is used.

- Decelerate to a stop
Stops by using emergency stop torque.
- Coast to a stop
Stops naturally, with no control, by using the friction resistance of the servomotor in operation.

After servomotor stopping, there are two modes.

- Coast mode
Stopped naturally, with no control, by using the friction resistance of the servomotor in operation.
- Zero clamp mode
A mode forms a position loop by using the position reference zero.

The servomotor stopping method when an overtravel (P-OT, N-OT) signal is input while the servomotor is operating can be set with parameter Pn001.

Parameter		Stop Method	Mode After Stopping	When Enabled	Classification
Pn001	n.□□02 [Factory setting]	Coast	Coast	After restart	Setup
	n.□□1□	Deceleration to a stop	Zero clamp		
	n.□□2□		Coast		

- A servomotor under torque control cannot be decelerated to a stop. Coast status is maintained after the servomotor coasts to a stop.
- For details on servomotor stopping methods after the SV_OFF command is received or an alarm occurs, refer to 4.3.5 *Stopping Servomotors after SV_OFF Command or Alarm Occurrence*.

■ When Servomotor Stopping Method is Set to Decelerate to Stop

Emergency stop torque can be set with Pn406.

Pn406	Emergency Stop Torque				Classification
	Setting Range	Setting Unit	Factory Setting	When Enabled	
	0 to 800	1%	800	Immediately	

- The setting unit is a percentage of the rated torque.
- The factory setting is 800% so that the setting is large enough a value to operate the servomotor at maximum torque. The maximum value of emergency stop torque that is actually available, however, is limited to the maximum torque of the servomotor.

(4) Overtravel Warning Function

This function detects an overtravel warning (A.9A0) if overtravel occurs while the servomotor power is ON. Using this function enables notifying the host controller when the SERVOPACK detects overtravel even if the overtravel signal is ON only momentarily.

To use this function, perform the following settings.

- Set Pn00D = n.1□□□ (overtravel warning function).
- Allocate one of the output signals to the warning signal.

■ Warning Output Timing

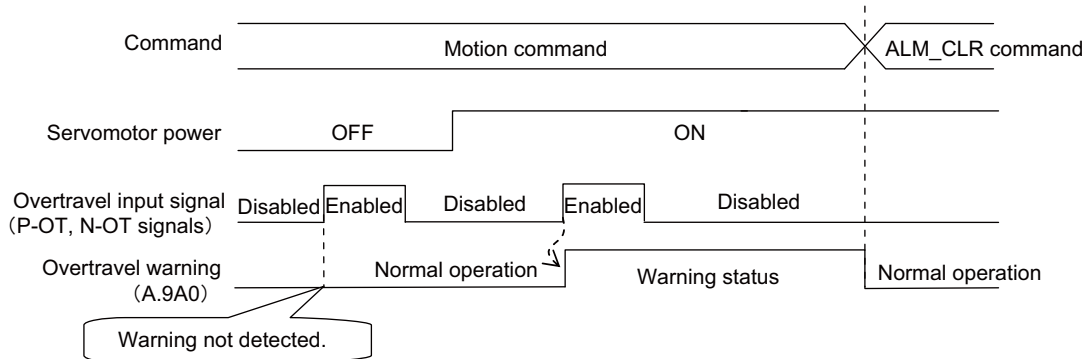

<Notes>

- Warnings are detected for overtravel in the same direction as the reference.
- Warnings are not detected for overtravel in the reverse direction from the reference.
Example: A warning will not be output for a forward reference even if the N-OT signal (reverse run prohibited) turns ON.
- A warning can be detected in either the forward or reverse direction, when there is no reference.
- A warning will not be detected when the servomotor power is OFF even if overtravel occurs.
- A warning will not be detected when the servomotor power changes from OFF to ON even if overtravel status exists.
- To clear the overtravel warning, send a Clear Warning or Alarm command (ALM_CLR) regardless of the status of the servomotor power and the overtravel signal. If the warning is cleared by this method during an overtravel state, the occurrence of the warning will not be indicated until the overtravelling is corrected and reset.
- The overtravel warning will be detected when the software limit is in effect.

CAUTION

- The overtravel warning function only detects warnings. It does not affect on stopping for overtravel or motion operations at the host controller. The next step (e.g., the next motion or other command) can be executed even if an overtravel warning exists. However, depending on the processing specifications and programming for warnings in the host controller, operation may be affected when an overtravel warning occurs (e.g., motion may stop or not stop). Confirm the specifications and programming in the host controller.
- When an overtravel occurs, the SERVOPACK will perform stop processing for overtravel. Therefore, when an overtravel warning occurs, the servomotor may not reach the target position specified by the host controller. Check the feedback position to make sure that the axis is stopped at a safe position.

■ Related Parameter

Parameter	Meaning	When Enabled	Classification
Pn00D	n.0□□□ [Factory setting]	Immediately	Setup
	n.1□□□		

4.3.3 Software Limit Settings

The software limits set limits in software for machine movement that do not use the overtravel signals (P-OT and N-OT). If a software limit is exceeded, an emergency stop will be executed in the same way as it is for overtravel.

(1) Software Limit Function

The software limit function can be enabled or disabled.

Use the parameter Pn801.0 to enable the software limit function.

The software limit function can be enabled under the following conditions. Under all other circumstances, the software limits will not be enabled even if a software limit is exceeded.

- The ZRET command has been executed.
- REFE = 1 using the POS_SET command.

Enable or disable the software limits using one of the following settings.

Parameter		Description	When Enabled	Classification
Pn801	n.□□□0	Software limits enabled in both direction.	Immediately	Setup
	n.□□□1	Forward software limit enabled.		
	n.□□□2	Reverse software limit enabled.		
	n.□□□3 [Factory setting]	Both software limits disabled.		

(2) Software Limit Check using References

Enable or disable software limit checks when target position references such as POSING or INTERPOLATE are input. When the input target position exceeds the software limit, a deceleration stop will be performed from the software limit set position.

Parameter		Description	When Enabled	Classification
Pn801	n.□0□□ [Factory setting]	No software limit check using references.	Immediately	Setup
	n.□1□□	Software limit check using references.		

(3) Software Limit Setting

Set software limits value in the forward and reverse directions.

Because the limit zone is set according to the forward or reverse direction, the reverse limit must be less than the forward limit.

Pn804	Forward Software Limit Position				Classification
	Setting Range	Setting Unit	Factory Setting	When Enabled	
	-1073741823 to 1073741823	1 Reference Unit	1073741823	Immediately	Setup
Pn806	Reverse Software Limit Position				Classification
	Setting Range	Setting Unit	Factory Setting	When Enabled	
	-1073741823 to 1073741823	1 Reference Unit	-1073741823	Immediately	Setup

4.3.4 Holding Brakes

A holding brake is a brake used to hold the position of the movable part of the machine when the SERVO-PACK is turned OFF so that movable part does not move due to gravity or external forces. Holding brakes are built into servomotors with brakes.

The holding brake is used in the following cases.

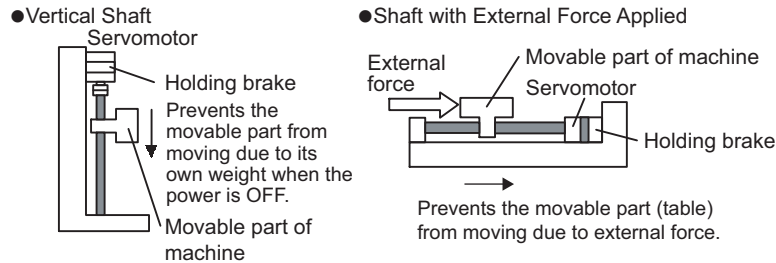



IMPORTANT

- The brake built into the servomotor with brakes is a de-energization brake, which is used only to hold and cannot be used for braking. Use the holding brake only to hold a stopped servomotor.

There is a delay in the braking operation. Set the following ON/OFF timing.

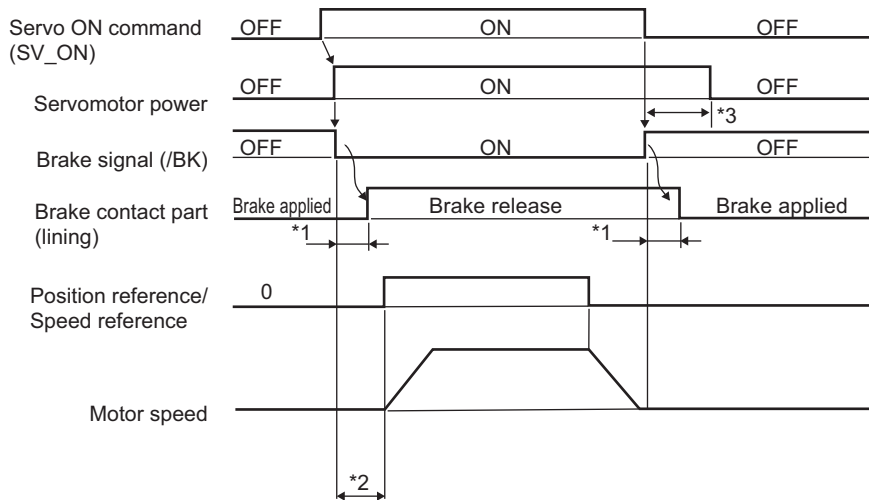

*1. The delay time in brake operation is given in the following table. This is just example of the operation delay time for switching with a direct current. Always evaluate performance on the actual equipment before actual operation.

Model	Voltage	Brake Release Time (ms)	Brake Applied Time (ms)
SGMMV	24 VDC	40	100

*2. After the SV_ON command has been sent and 50 ms has passed since the brake was released, output the reference from the host controller to the SERVOPACK.

*3. Use Pn506, Pn507, and Pn508 to set the timing of when the brake will be activated and when the servomotor power will be turned OFF.

(1) Wiring Example

Use the brake signal (/BK) and the brake power supply to form a brake ON/OFF circuit. The following diagram shows a standard wiring example.

The timing can be easily set using the brake signal (/BK).

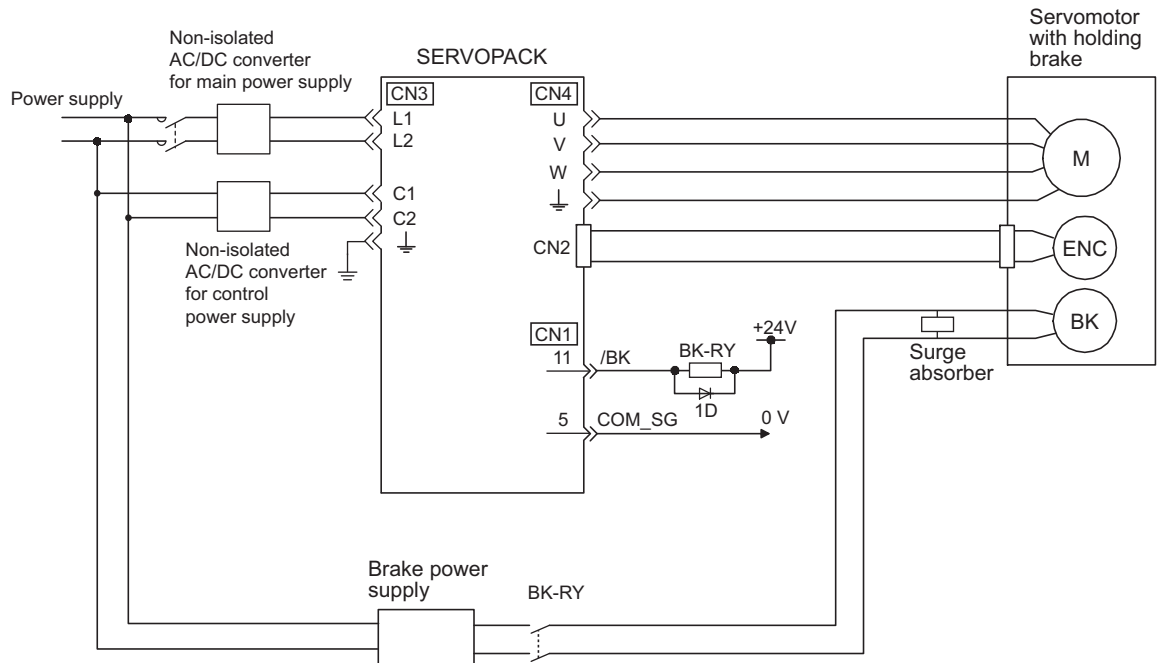

BK-RY: Brake control relay
Brake power supply for 24 VDC is not included.



IMPORTANT

- Always connect a surge absorber.
Recommended surge absorber: Z15D151 (manufactured by SEMITEC Corporation)
- After the surge absorber is connected, check the total time the brake is applied for the system. Depending on the surge absorber, the total time the brake is applied can be changed.
- Configure the relay circuit to apply the holding brake by the emergency stop.

Relay Circuit Example

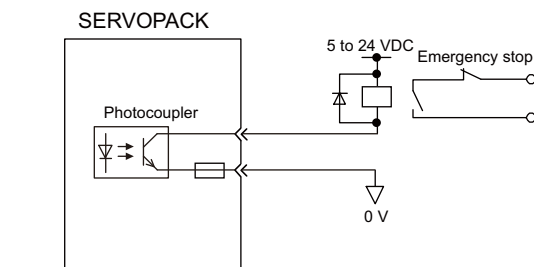

- The allocation of the /BK signal can be changed. Refer to (3) *Brake Signal (/BK) Allocation* to set the parameter Pn50F.
- Always separate the 24-VDC power supply for the 24-V brake from other power supplies, such as the control or I/O signal (CN1) power supplies. If the power supply is shared, the I/O signals might malfunction.

(2) Brake Signal (/BK) Setting

This output signal controls the brake. The allocation of the /BK signal can be changed. Refer to (3) *Brake Signal (/BK) Allocation* for allocation.

The /BK signal turns OFF (applies the brake) when an alarm is detected or the SV_OFF command is received. The brake OFF timing can be adjusted with Pn506.

Type	Name	Connector Pin Number	Setting	Meaning
Output	/BK	CN1-11	ON (closed)	Releases the brake.
			OFF (open)	Applies the brake.



IMPORTANT

The /BK signal is still ON during overtravel and the brake is still released.

(3) Brake Signal (/BK) Allocation

Use parameter Pn50F.2 to allocate the /BK signal.

Parameter	Connector Pin Number	Meaning	When Enabled	Classification	
Pn50F	n.□0□□	–	After restart	Setup	
	n.□1□□ [Factory setting]	CN1-11			The /BK signal is output from output terminal CN1-11.
	n.□2□□	CN1-10			The /BK signal is output from output terminal CN1-10.
	n.□3□□	CN1-9			The /BK signal is output from output terminal CN1-9.



IMPORTANT

When multiple signals are allocated to the same output terminal, the signals are output with OR logic. For the /BK signal, do not use the output terminal that is already being used for another signal.

(4) Brake ON Timing after the Servomotor Stops

When the servomotor stops, the /BK signal turns OFF at the same time as the SV_OFF command is received. Use parameter Pn506 to change the timing to turn OFF the servomotor power after the SV_OFF command has been received.

Pn506	Brake Reference-Servo OFF Delay Time				Classification
	Setting Range	Setting Unit	Factory Setting	When Enabled	
	0 to 50	10 ms	0	Immediately	

- When using the servomotor to control a vertical axis, the machine movable part may shift slightly depending on the brake ON timing due to gravity or an external force. To eliminate this slight shift, set parameter so that the power to the servomotor turns OFF after the brake is applied.
- This parameter changes the brake ON timing while the servomotor is stopped.

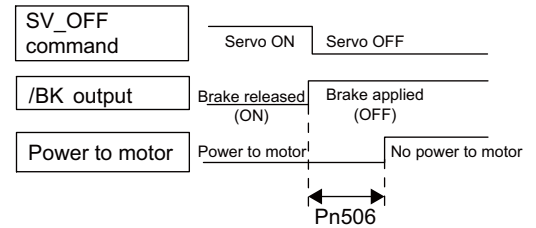

IMPORTANT

The servomotor will turn OFF immediately when an alarm occurs, regardless of the setting of this parameter. The machine movable part may shift due to gravity or external force before the brake operates.

(5) Brake Signal (/BK) Output Timing during Servomotor Rotation

If an alarm occurs while the servomotor is rotating, the servomotor will come to a stop and the brake signal (/BK) will be turned OFF. The timing of brake signal (/BK) output can be adjusted by setting the brake reference output speed level (Pn507) and the waiting time for brake signal when motor running (Pn508).

Note: If the servomotor is set so that it comes to a zero-speed stop for an alarm, follow the information in (4) *Brake ON Timing after the Servomotor Stops* after the servomotor comes to a stop for a zero position reference.

Pn507	Brake Reference Output Speed Level				[Speed] [Position] [Torque]	Classification
	Setting Range	Setting Unit	Factory Setting	When Enabled		
	0 to 10000	1 min ⁻¹	100	Immediately	Setup	
Pn508	Waiting Time for Brake Signal When Motor Running				[Speed] [Position] [Torque]	Classification
	Setting Range	Setting Unit	Factory Setting	When Enabled		
	10 to 100	10 ms	50	Immediately	Setup	

/BK Signal Output Conditions When Servomotor Rotating

The /BK signal goes to high level (brake ON) when either of the following conditions is satisfied:

- When the motor speed falls below the level set in Pn507 after the power to the servomotor is turned OFF.
- When the time set in Pn508 is exceeded after the power to the servomotor is turned OFF.

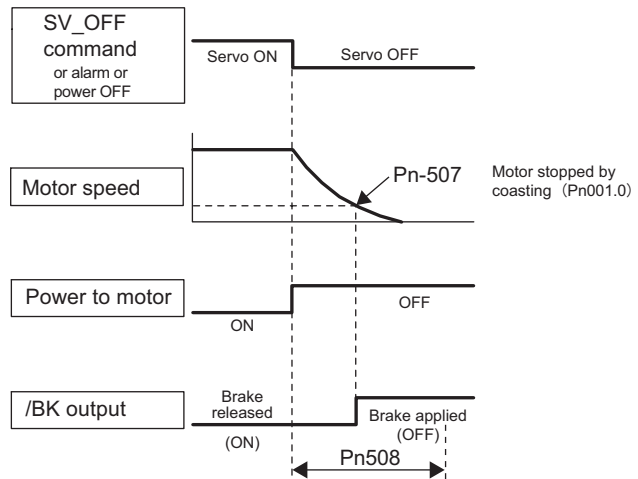



IMPORTANT

- The servomotor will be limited to its maximum speed even if the value set in Pn507 is higher than the maximum speed.
- Do not allocate the rotation detection signal (/TGON) and the brake signal (/BK) to the same terminal. The /TGON signal will otherwise be turned ON by the falling speed on a vertical axis, and the brake may not operate. For the /BK signal, do not use the terminal that is already being used for another signal.

4.3.5 Stopping Servomotors after SV_OFF Command or Alarm Occurrence

The servomotor stopping method can be selected after the SV_OFF command is received or an alarm occurs.



IMPORTANT

- The elements in the SERVOPACK will deteriorate if turning the power supply ON and OFF or starting and stopping the servomotor during the servo ON status while there is a reference input. Use a speed reference or position reference to start and stop the servomotor.
- If turning OFF the main circuit power supply or the control power supply during operation without turning OFF the servo, the servomotor will coast to a stop. In this case, the stop method cannot be set in a parameter.
- To minimize the coasting distance of the servomotor to come to a stop when an alarm occurs, the zero-speed stopping method is factory-set for alarms to which the zero-speed stopping method is applicable. However, in some applications, coasting to a stop may be more suitable than the zero-speed stopping method.

For example, for multiple shafts in coupled operation (e.g., a twin-drive operation), machinery may damage due to differences in the stopping operation if a zero-speed stop alarm occurs for one of the coupled shafts and the other coupled shaft coasts to a stop. In such cases, change the stopping method so that the servomotor coasts to a stop.

(1) Stopping Method for Servomotor after SV_OFF Command is Received

The servomotor coasts to a stop when the servo is turned OFF.

(2) Stopping Method for Servomotor When an Alarm Occurs

There are two types of alarms, Gr.1 and Gr.2, that vary in the stopping method when the alarm occurs.

When a Gr.1 alarm occurs, the servomotor coasts to a stop.

When a Gr.2 alarm occurs, the stopping method that is set in Pn00B.1 is used.

Refer to the information on alarm stopping methods in 8.1.1 *List of Alarms*.

■ Stopping Method for Servomotor for Gr.2 Alarms

Parameter		Stop Mode	Mode After Stopping	When Enabled	Classification
Pn00B	n.□□0□ [Factory setting]	Zero-speed stopping*	Coast	After restart	Setup
	n.□□1□	Coast			

* Zero-speed stopping: The speed reference is set to 0 to stop quickly.

Note: The setting of Pn00B.1 is effective for position control and speed control. The setting of Pn00B.1 is ignored for torque control and the servomotor coasts to a stop.

4.3.6 Setting Motor Overload Detection Level

In this SERVOPACK, the detection timing of the warnings and alarms can be changed by changing how to detect an overload warning (A.910) and overload (low load) alarm (A.720).

The overload characteristics and the detection level of the overload (high load) alarm (A.710) cannot be changed.

(1) Changing Detection Timing of Overload Warning (A.910)

The overload warning level is set by default to 20% so that an overload warning is detected in 20% of the time required to detect an overload alarm. The time required to detect an overload warning can be changed by changing the setting of the overload warning level (Pn52B). This protective function enables the warning output signal (/WARN) to serve as a protective function and to be output at the best timing for your system.

The following graph shows an example of the detection of an overload warning when the overload warning level (Pn52B) is changed from 20% to 50%. An overload warning is detected in half of the time required to detect an overload alarm.

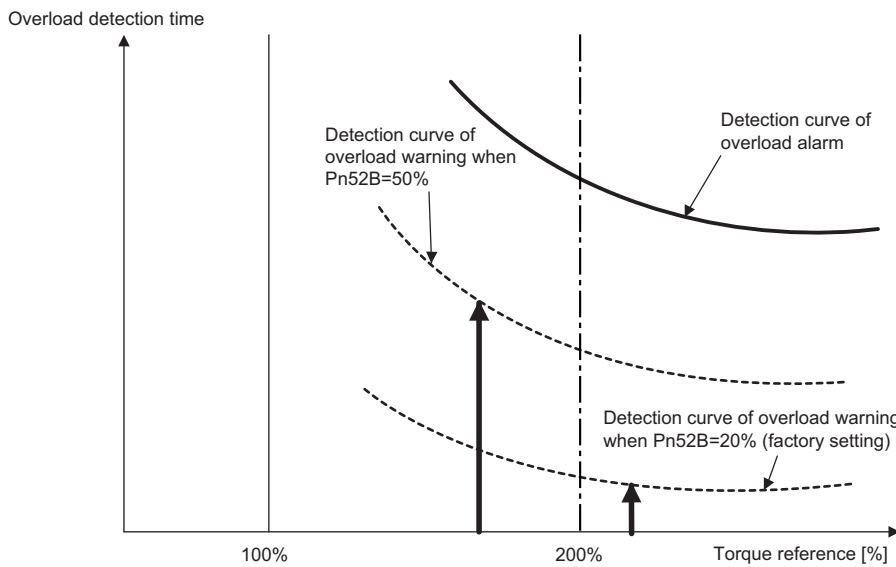

Note: For details, refer to *Overload Characteristics* listed in the section for the relevant servomotor in the *Σ-V Series Product Catalog* (Catalog No.: KAEP S800000 42).

Pn52B	Overload Warning Level				Classification	
			<input type="checkbox"/> Speed	<input type="checkbox"/> Position		<input type="checkbox"/> Torque
	Setting Range	Setting Unit	Factory Setting	When Enabled		
	1 to 100	1%	20	Immediately	Setup	

(2) Changing Detection Timing of Overload (Low Load) Alarm (A.720)

An overload (low load) alarm (A.720) can be detected earlier to protect the servomotor from overloading. The time required to detect an overload alarm can be shortened by using the derated motor base current obtained with the following equation.

Note: The detection level of the overload (high load) alarm (A.710) cannot be changed.

$$\text{Motor base current} \times \text{Derating of base current at detecting overload of motor (Pn52C)} = \text{Derated motor base current}$$

Motor base current: Threshold value of motor current to start calculation for overload alarm
 Derating of base current at detecting overload of motor (Pn52C): Derating of motor base current

The following graph shows an example of the detection of an overload alarm when Pn52C is set to 50%. The calculation for the overload of motors starts at 50% of the motor base current and then an overload alarm will be detected earlier.

Changing the setting of Pn52C will change the detection timing of the overload alarm, so the time required to detect the overload warning will also be changed.

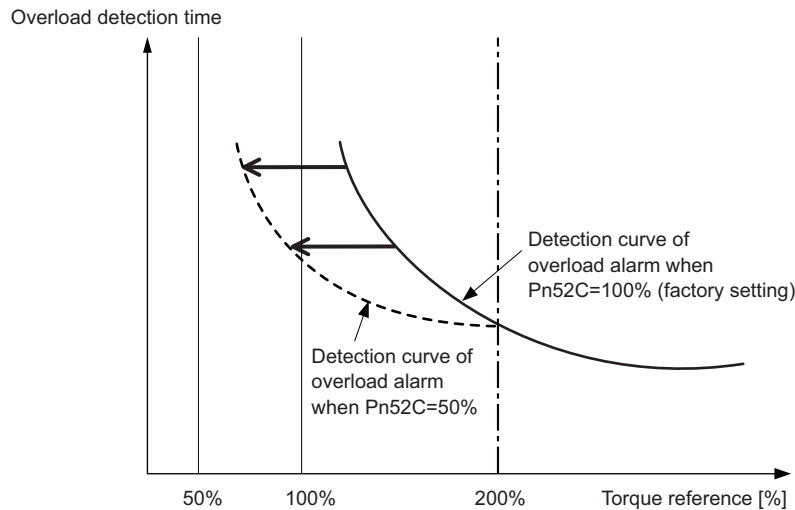

As a guideline of motor heating conditions, the relationship between the heat sink sizes and deratings of base current is shown in a graph in:

Servomotor Heating Conditions in *Rotary Servomotors General Instruction* in Σ -V Series Product Catalog (Catalog No.: KAEP S800000 42).

Set Pn52C to a value in accordance with the heat sink size and derating shown in the graph, so that an overload alarm can be detected at the best timing to protect the servomotor from overloading.

Note: For details, refer to *Overload Characteristics* listed in the section for the relevant servomotor in the Σ -V Series Product Catalog (Catalog No.: KAEP S800000 42).

Pn52C	Derating of Base Current at Detecting Overload of Motor				Classification
	Setting Range	Setting Unit	Factory Setting	When Enabled	
	10 to 100	1%	100	After restart	

4.4 Trial Operation

This section describes a trial operation using MECHATROLINK-II communications.

4.4.1 Inspection and Checking before Trial Operation

To ensure safe and correct trial operation, inspect and check the following items before starting trial operation.

(1) Servomotors

Inspect and check the following items, and take appropriate measures before performing trial operation if any problem exists.

- Are all wiring and connections correct?
- Are all nuts and bolts securely tightened?

Note: When performing trial operation on a servomotor that has been stored for a long period of time, perform the inspection according to the procedures described in *AC Servomotor Safety Precautions* (Manual No.: TOBP C230200 00).

(2) SERVOPACKs

Inspect and check the following items, and take appropriate measures before performing trial operation if any problem exists.

- Are all wiring and connections correct?
- Is the correct power supply voltage being supplied to the SERVOPACK?

4.4.2 Trial Operation via MECHATROLINK-II

The following table provides the procedures for trial operation via MECHATROLINK-II.

Step	Description	Reference
1	Confirm that the wiring is correct, and then connect the I/O signal connector (CN1 connector).	3 <i>Wiring and Connection</i>
2	Turn ON the power to the SERVOPACK. If the SERVOPACK is receiving power, the COM LED indicator on the SERVOPACK will light up. Note: If the COM LED does not turn ON, recheck the settings of MECHATROLINK-II setting switches (SW1, SW2) and then restart the SERVOPACK.	—
3	Send the CONNECT command. In the response data from the SERVOPACK, the alarm code "00" is cleared to show normal operation. The response data from the SERVOPACK may be confirmed with the SMON command.	<i>Σ-V Series User's Manual MECHATROLINK-II Commands (Manual No.: SIEP S800000 54)</i>
4	Check the product type using an ID_RD command. A reply showing the product type, such as SGD V-2R9E11A, is received from the SERVOPACK.	
5	Set the following items to the necessary settings for a trial operation. <ul style="list-style-type: none"> • Electronic gear settings • Rotational direction of servomotor • Overtravel 	4.4.3 <i>Electronic Gear</i> 4.3.2 <i>Overtravel</i> 4.3.2 <i>Overtravel</i>
6	Save these settings (step 5). If saving the settings in the controller, use the PRM_WR command. If saving the settings in the SERVOPACK, use the PPRM_WR command.	<i>Σ-V Series User's Manual MECHATROLINK-II Commands (Manual No.: SIEP S800000 54)</i>
7	Send the SV_ON command. A reply showing that the servomotor has switched to Drive status and that SVON=1 (servomotor power is ON) is received.	
8	Run the servomotor at low speed. <Example using a positioning command> Command used: POSING Command setting: Option = 0, Positioning position =10000 (If using the absolute encoder, add 10000 to the present position), rapid traverse speed= 400	—
9	Check the following points while running the servomotor at low speed (step 8). <ul style="list-style-type: none"> • Confirm that the rotational direction of the servomotor correctly coincides with the forward rotation or reverse rotation reference. If they do not coincide, reset the direction. • Confirm that no unusual vibrations, noises, or temperature rises occur. If any abnormalities are seen, correct the conditions. Note: Because the running-in of the load machine is not sufficient at the time of the trial operation, the servomotor may become overloaded.	4.3.1 <i>Servomotor Rotation Direction</i> 8.4 <i>Troubleshooting Malfunction Based on Operation and Conditions of the Servomotor</i>

4.4.3 Electronic Gear

The electronic gear enables the workpiece travel distance per reference unit input from the host controller. The minimum unit of the position data moving a load is called a reference unit.

The section indicates the difference between using and not using an electronic gear when a workpiece is moved 10 mm in the following configuration.

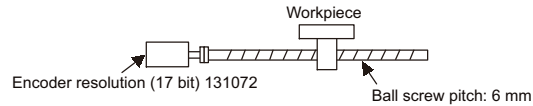

When the Electronic Gear is Not Used:

- ① Calculate the revolutions.
1 revolution is 6 mm. Therefore, $10/6$ revolutions.
- ② Calculate the required reference units.
131072 reference units is 1 revolution. Therefore, $10/6 \times 131072 = 218453.33\cdots$ reference units.
- ③ Input 218453 references as reference units.

Reference units must be calculated per reference. → complicated

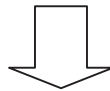

When the Electronic Gear is Used:

The reference unit is $1\ \mu\text{m}$. Therefore, to move the workpiece 10 mm ($10000\ \mu\text{m}$),
1 reference unit = $1\ \mu\text{m}$, so $10000 \div 1 = 10000$ reference units.
Input 10000 pulses as reference units.

Calculation of reference units per reference is not required. → simplified

(1) Electronic Gear Ratio

Set the electronic gear ratio using Pn20E and Pn210.

Pn20E	Electronic Gear Ratio (Numerator)				Position	Classification
	Setting Range	Setting Unit	Factory Setting	When Enabled		
	1 to 1073741824	1	4	After restart	Setup	
Pn210	Electronic Gear Ratio (Denominator)				Position	Classification
	Setting Range	Setting Unit	Factory Setting	When Enabled		
	1 to 1073741824	1	1	After restart	Setup	

If the gear ratio of the servomotor and the load shaft is given as n/m where m is the rotation of the servomotor and n is the rotation of the load shaft,

$$\text{Electronic gear ratio: } \frac{B}{A} = \frac{\text{Pn20E}}{\text{Pn210}} = \frac{\text{Encoder resolution}}{\text{Travel distance per load shaft revolution (reference units)}} \times \frac{m}{n}$$

Encoder Resolution

Encoder resolution can be checked with servomotor model designation.

SGMMV -□□□□□□□

Symbol	Specification	Encoder Resolutions
2	17-bit absolute	131072

IMPORTANT Electronic gear ratio setting range: $0.001 \leq \text{Electronic gear ratio (B/A)} \leq 4000$
If the electronic gear ratio is outside this range, a parameter setting error 1 (A.040) will be output.

(2) Electronic Gear Ratio Setting Examples

The following examples show electronic gear ratio settings for different load configurations.

Step	Operation	Load Configuration		
		Ball Screw	Disc Table	Belt and Pulley
		Reference unit: 0.001 mm Load shaft 17-bit encoder Ball screw pitch: 6 mm	Reference unit: 0.01° Load shaft 17-bit encoder Gear ratio: 1/100	Reference unit: 0.005 mm Load shaft 17-bit encoder Pulley diameter: 100 mm Gear ratio: 1/50
1	Check machine specifications.	<ul style="list-style-type: none"> Ball screw pitch: 6 mm Gear ratio: 1/1 	Rotation angle per revolution: 360° Gear ratio: 1/100	Pulley diameter: 100 mm (pulley circumference: 314 mm) <ul style="list-style-type: none"> Gear ratio: 1/50
2	Check the encoder resolution.	131072 (17-bit)	131072 (17-bit)	131072 (17-bit)
3	Determine the reference unit used.	Reference unit: 0.001 mm (1 μm)	Reference unit: 0.01°	Reference unit: 0.005 mm (5 μm)
4	Calculate the travel distance per load shaft revolution. (Reference unit)	6 mm/0.001 mm=6000	360°/0.01°=36000	314 mm/0.005 mm=62800
5	Calculate the electronic gear ratio.	$\frac{B}{A} = \frac{131072}{6000} \times \frac{1}{1}$	$\frac{B}{A} = \frac{131072}{36000} \times \frac{100}{1}$	$\frac{B}{A} = \frac{131072}{62800} \times \frac{50}{1}$
6	Set parameters.	Pn20E: 131072 Pn210: 6000	Pn20E: 13107200 Pn210: 36000	Pn20E: 6553600 Pn210: 62800

4.5 Test Without Motor Function

The test without a motor is used to check the operation of the host controller and peripheral devices by simulating the operation of the servomotor in the SERVOPACK, i.e., without actually operating a servomotor. This function enables you to check wiring, verify the system while debugging, and verify parameters, thus shortening the time required for setup work and preventing damage to the machine that may result from possible malfunctions. The operation of the motor can be checked during performing this function regardless of whether the motor is actually connected or not.

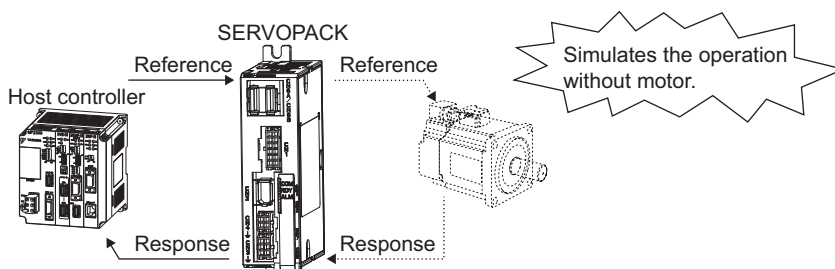

Use Pn00C.0 to enable or disable the test without a motor.

Parameter		Meaning	When Enabled	Classification
Pn00C	n.□□□0 [Factory setting]	Disables the test without a motor.	After restart	Setup
	n.□□□1	Enables the test without a motor.		

4.5.1 Motor Information

The motor information that is used for a test without a motor is given below.

(1) Motor Connected

If a motor is connected, the information from the connected motor is used for the motor and encoder information. The set values of Pn00C.1 and Pn00C.2 are not used.

(2) Motor Not Connected

The virtual motor information that is stored in the SERVOPACK is used. The set values of Pn00C.1 and Pn00C.2 are used for the encoder information.

■ Encoder Resolution

The encoder information for the motor is set in Pn00C.1.

Parameter		Meaning	When Enabled	Classification
Pn00C	n.□□0□ [Factory setting]	Sets 13 bits as encoder resolution for the test without a motor.	After restart	Setup
	n.□□1□	Sets 20 bits as encoder resolution for the test without a motor.		

■ Encoder Type

The encoder information for the motor is set in Pn00C.2.

Parameter		Meaning	When Enabled	Classification
Pn00C	n.□0□□ [Factory setting]	Sets an incremental encoder as encoder type for the test without a motor.	After restart	Setup
	n.□1□□	Sets an absolute encoder as encoder type for the test without a motor.		

■ Rated Motor Speed and Maximum Motor Speed

The values previously saved in the SERVOPACK will be used for the rated motor speed and maximum motor speed. Use the monitor displays (Un020: Motor rated speed and Un021: Motor maximum speed) to check the values.

4.5.2 Motor Position and Speed Responses

For the test without a motor, the following responses are simulated for references from the host controller according to the gain settings for position or speed control.

- Servomotor position
- Servomotor speed

However, the load model will be a rigid system with the moment of inertia ratio that is set in Pn103.

4.5.3 Limitations

The following functions cannot be used during the test without a motor.

- Brake output signal (The brake output signal can be checked with the I/O signal monitor function of the SigmaWin+.)
- Items marked with "×" in the following utility function table.

Fn No.	Contents	Can be used or not	
		Motor not connected	Motor connected
Fn000	Alarm history display	○	○
Fn002	JOG operation	○	○
Fn003	Origin search	○	○
Fn004	Program JOG operation	○	○
Fn005	Initializing parameter settings	○	○
Fn006	Clearing alarm history	○	○
Fn008	Absolute encoder multiturn reset and encoder alarm reset	×	○
Fn00C	Offset adjustment of analog monitor output	○	○
Fn00D	Gain adjustment of analog monitor output	○	○
Fn00E	Automatic offset-signal adjustment of the motor current detection signal	×	○
Fn00F	Manual offset-signal adjustment of the motor current detection signal	×	○
Fn010	Write prohibited setting	○	○
Fn011	Servomotor model display	○	○
Fn012	Software version display	○	○
Fn013	Multiturn limit value setting change when a multiturn limit disagreement alarm occurs	×	○
Fn01B	Vibration detection level initialization	×	×
Fn01E	Display of SERVOPACK and servomotor ID	○	○
Fn030	Software reset	○	○
Fn200	Tuning-less levels setting	×	×
Fn201	Advanced autotuning	×	×
Fn202	Advanced autotuning by reference	×	×
Fn203	One-parameter tuning	×	×
Fn204	Anti-resonance control adjustment function	×	×
Fn205	Vibration suppression function	×	×
Fn206	EasyFFT	×	×
Fn207	Online vibration monitor	×	×

Note: ○: Can be used
×: Cannot be used

4.6 Limiting Torque

The SERVOPACK provides the following four methods for limiting output torque to protect the machine.

Limiting Method	Description	Reference Section
Internal torque limit	Always limits torque by setting the parameter.	4.6.1
External torque limit	Limits torque by input signal from the host controller.	4.6.2
Torque limit with P_TLIM, N_TLIM commands *	Limits torque by using the P_TLIM and N_TLIM commands.	–
Torque limit with P_CL/ N_CL signals of OPTION Field and P_TLIM/N_TLIM commands *	Combines torque limit methods by using an external input and P_TLIM and N_TLIM commands.	–

* For details, refer to *ΣV Series User's Manual MECHATROLINK-II Commands* (Manual No.: SIEP S800000 54).
Note: The maximum torque of the servomotor is used when the set value exceeds the maximum torque.

4.6.1 Internal Torque Limit

This function always limits maximum output torque by setting values of following parameters.

Pn402	Forward Torque Limit [Speed] [Position] [Torque]				Classification
	Setting Range	Setting Unit	Factory Setting	When Enabled	
	0 to 800	1%	800	Immediately	Setup
Pn403	Reverse Torque Limit [Speed] [Position] [Torque]				Classification
	Setting Range	Setting Unit	Factory Setting	When Enabled	
	0 to 800	1%	800	Immediately	Setup

The setting unit is a percentage of the rated torque.

Note: If the settings of Pn402 and Pn403 are too low, the torque may be insufficient for acceleration or deceleration of the servomotor.

Torque waveform

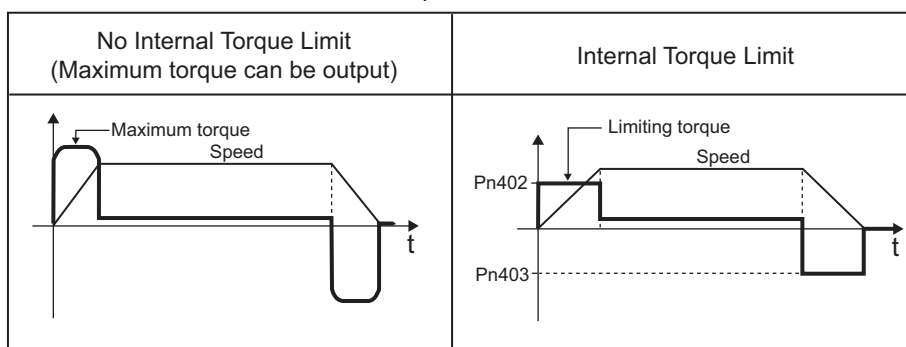

4.6.2 External Torque Limit

Use this function to limit torque by inputting a signal from the host controller at specific times during machine operation. For example, some pressure must continually be applied (but not enough to damage the workpiece) when the robot is holding a workpiece or when a device is stopping on contact.

(1) Input Signals

Use the following input signals to limit a torque by external torque limit.

Type	Signal Name	Connector Pin Number	Setting	Meaning	Limit value
Input	/P-CL	Must be allocated	ON (closed)	Forward external torque limit ON	The smaller value of these settings: Pn402 or Pn404
			OFF (open)	Forward external torque limit OFF	Pn402
Input	/N-CL	Must be allocated	ON (closed)	Reverse external torque limit ON	The smaller value of these settings: Pn403 or Pn405
			OFF (open)	Reverse external torque limit OFF	Pn403

Note: Use parameter Pn50B.2 and Pn50B.3 to allocate the /P-CL signal and the /N-CL signal for use. For details, refer to 3.3.1 *Input Signal Allocations*.

(2) Related Parameters

Set the following parameters for external torque limit.

Pn402	Forward Torque Limit [Speed] [Position] [Torque]				Classification
	Setting Range	Setting Unit	Factory Setting	When Enabled	
	0 to 800	1%	800	Immediately	Setup
Pn403	Reverse Torque Limit [Speed] [Position] [Torque]				Classification
	Setting Range	Setting Unit	Factory Setting	When Enabled	
	0 to 800	1%	800	Immediately	Setup
Pn404	Forward External Torque Limit [Speed] [Position] [Torque]				Classification
	Setting Range	Setting Unit	Factory Setting	When Enabled	
	0 to 800	1%	100	Immediately	Setup
Pn405	Reverse External Torque Limit [Speed] [Position] [Torque]				Classification
	Setting Range	Setting Unit	Factory Setting	When Enabled	
	0 to 800	1%	100	Immediately	Setup

The setting unit is a percentage of the rated torque.

Note: If the settings of Pn402, Pn403, Pn404, and Pn405 are too low, the torque may be insufficient for acceleration or deceleration of the servomotor.

(3) Changes in Output Torque during External Torque Limiting

The following diagrams show the change in output torque when the internal torque limit is set to 800%.

In this example, the servomotor rotation direction is Pn000.0 = 0 (Sets CCW as forward direction).

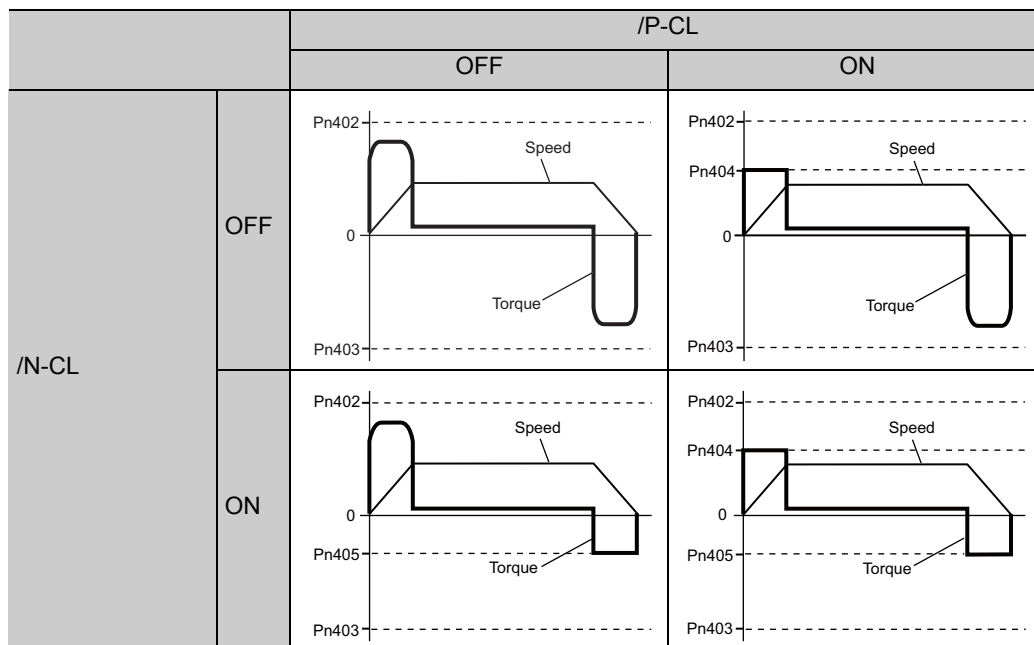

4.6.3 Checking Output Torque Limiting during Operation

The following signal can be output to indicate that the servomotor output torque is being limited.

Type	Signal Name	Connector Pin Number	Setting	Meaning
Output	/CLT	Must be allocated	ON (closed)	Servomotor output torque is being limited.
			OFF (open)	Servomotor output torque is not being limited.

Note: Use parameter Pn50F.0 to allocate the /CLT signal for use. For details, refer to 3.3.2 Output Signal Allocations.

4.7 Absolute Encoders

If using an absolute encoder, a system to detect the absolute position can be designed for use with the host controller. As a result, an operation can be performed without a zero point return operation immediately after the power is turned ON.

A battery case is required to save position data in the absolute encoder. The battery is attached to the battery case of the encoder cable.

Set Pn002.2 to 0 (factory setting) to use the absolute encoder.

Parameter	Meaning	When Enabled	Classification	
Pn002	n.□0□□ [Factory setting]	Uses the absolute encoder as an absolute encoder.	After restart	Setup
	n.□1□□	Uses the absolute encoder as an incremental encoder.		

The SEN signal and battery are not required when using the absolute encoder as an incremental encoder.

4.7.1 Connecting the Absolute Encoder

The following diagram shows the connection between a servomotor with an absolute encoder, the SERVOPACK, and the host controller.

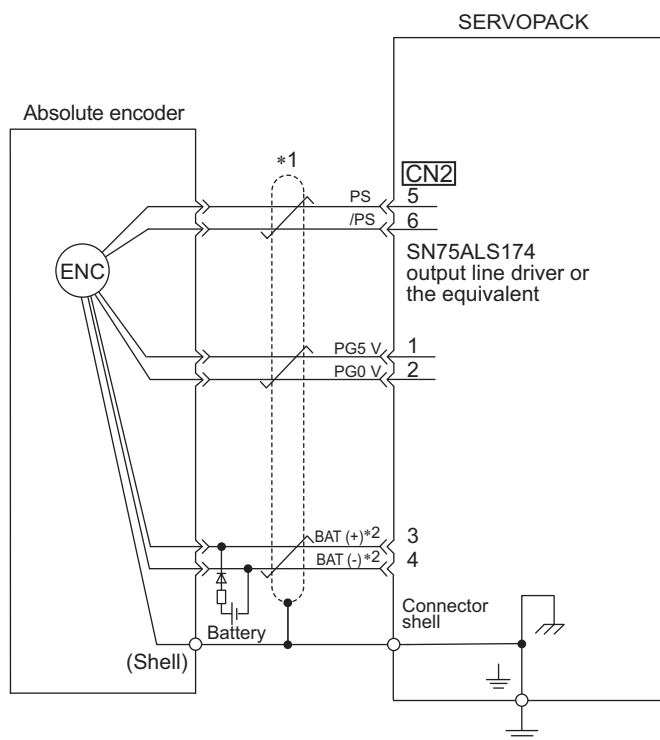

*1.  : represents shielded twisted-pair wires.

*2. When using an absolute encoder, provide power by installing an encoder cable with a JUSP-BA01-E Battery Case or install a battery on the host controller.



IMPORTANT

- When Installing a Battery on the Encoder Cable
Use the encoder cable with a battery case that is specified by Yaskawa.
For details, refer to the *Σ-V Series Product Catalog* (Catalog No.: KAEP S800000 42).
- When Installing a Battery on the Host Controller
Insert a diode near the battery to prevent reverse current flow.

Circuit Example

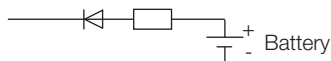

4.7.2 Absolute Data Request (SENS_ON Command)

The Turn Encoder Power Supply ON command (SENS_ON) must be sent to obtain absolute data as an output from the SERVOPACK.

The SENS_ON command is sent at the following timing.

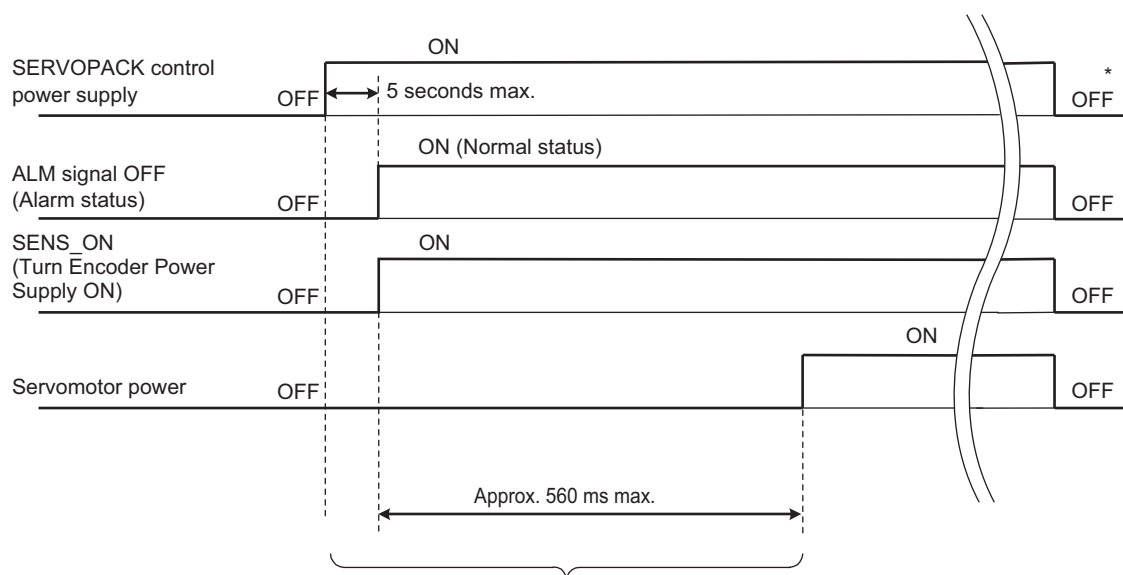

The servomotor will not be turned ON even if the SV_ON command is received during this interval.

- * Send the SENS_OFF command to turn OFF the control power supply.

4.7.3 Battery Replacement

If the battery voltage drops to approximately 2.7 V or less, an absolute encoder battery error alarm (A.830) or an absolute encoder battery error warning (A.930) will be displayed.

If this alarm or warning is displayed, replace the batteries using the following procedure.

Use Pn008.0 to set either an alarm (A.830) or a warning (A.930).

Parameter		Meaning	When Enabled	Classification
Pn008	n.□□□0 [Factory setting]	Outputs the alarm A.830 when the battery voltage drops.	After restart	Setup
	n.□□□1	Outputs the warning A.930 when the battery voltage drops.		

- If Pn008.0 is set to 0, alarm detection will be enabled for 4 seconds after the ALM signal outputs max. 5 seconds when the control power is turned ON. No battery-related alarm will be displayed even if the battery voltage drops below the specified value after these 4 seconds.
- If Pn008.0 is set to 1, alarm detection will be always enabled after the ALM signal outputs max. 5 seconds when the control power supply is turned ON.

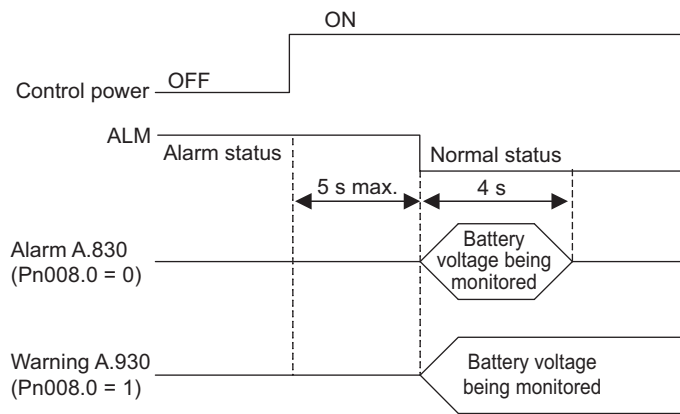

(1) Battery Replacement Procedure

1. Turn ON the control power supply of the SERVOPACK only.
2. Open the battery case cover.

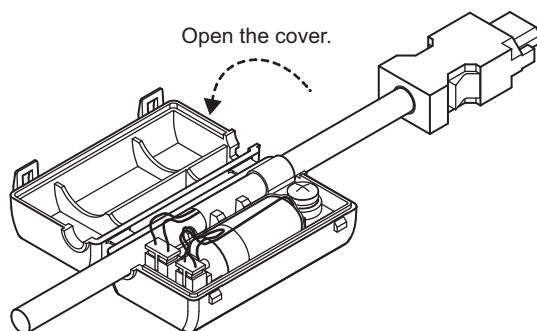

3. Remove the old battery and mount the new JZSP-BA01 battery as shown below.

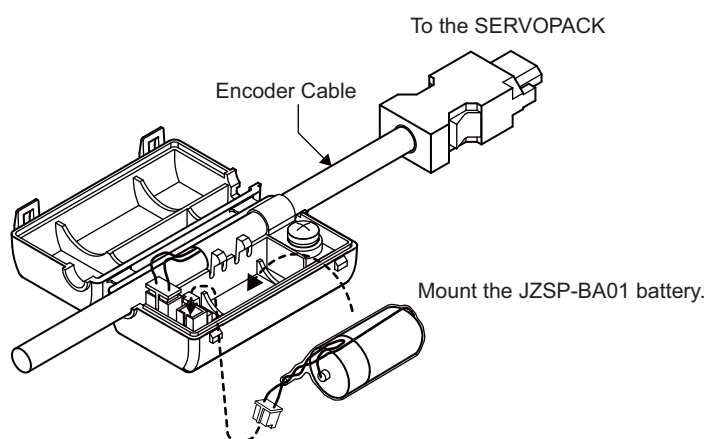

4. Close the battery case cover.

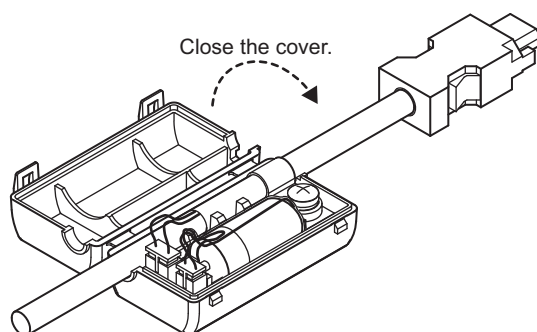

5. After replacing the battery, turn OFF the control power supply to clear the absolute encoder battery error alarm (A.830).
6. Turn ON the control power supply again.
7. Check that the alarm display has been cleared and that the SERVOPACK operates normally.



IMPORTANT

If the SERVOPACK control power supply is turned OFF and the battery is disconnected (which includes disconnecting the encoder cable), the absolute encoder data will be deleted.

4.7.4 Absolute Encoder Setup

CAUTION

- The rotational data will be a value between -2 and +2 rotations when the absolute encoder setup is executed. The reference position of the machine system will change. Set the reference position of the host controller to the position after setup.
If the machine is started without adjusting the position of the host controller, unexpected operation may cause injury or damage to the machine. Take sufficient care when operating the machine.

Setting up the absolute encoder is necessary in the following cases.

- When starting the machine for the first time
- When an encoder backup error alarm (A.810) is generated
- When an encoder checksum error alarm (A.820) is generated
- When initializing the rotational serial data of the absolute encoder

(1) Precautions on Setup

- If the following absolute encoder alarms are displayed, cancel the alarm by using the same method as the absolute encoder setup. They cannot be canceled with the SERVOPACK Clear Warning or Alarm command (ALM_CLR).
 - Encoder backup error alarm (A.810)
 - Encoder checksum error alarm (A.820)
- Any other alarms (A.8□□) that monitor the inside of the encoder should be canceled by turning OFF the power.

(2) Preparation

The following conditions must be met to setup the absolute encoder.

- The write prohibited setting parameter (Fn010) must be set to Write permitted (P.0000).
- The servomotor power must be OFF.

(3) Operating Procedure

Use the following procedure.

This setting can be performed using the adjustment command (ADJ). For details, refer to *Σ-V Series User's Manual MECHATROLINK-II Commands* (Manual No.: SIEP S800000 54).

1. Make sure that the motor power is OFF.
2. In the SigmaWin+ main window, click **Setup – Set Absolute Encoder – Reset Absolute Encoder**.

A warning message will appear confirming if you want to continue the processing.

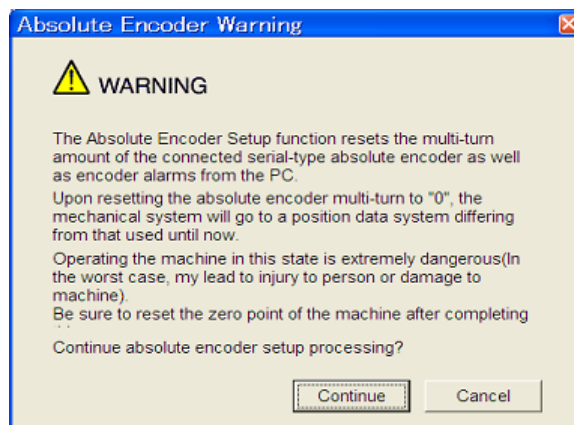

Click **Cancel** to return to the main window without resetting the absolute encoder.

3. Click **Continue.**

The Absolute encoder Setup box will appear.

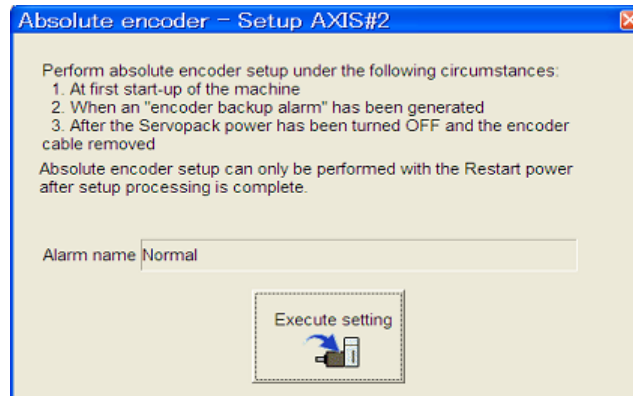

The Alarm Name box displays the code and name of the alarm that is occurring now.

4. Click **Execute setting.**

A verification message will appear confirming if you want to continue although the coordinate system will change.

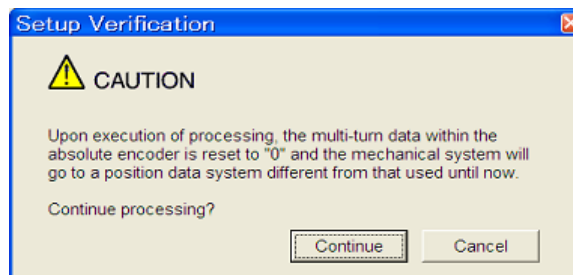

Click **Cancel** to return to the previous window without resetting the absolute encoder.

5. Click **Continue to set up the encoder.**

<If Setup is Unsuccessful>

If setting up is attempted with the servo ON, a reset conditions error occurs, and the processing is aborted.

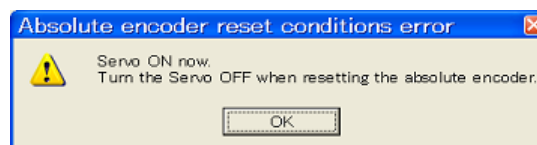

Click **OK** to return to the main window.

<If Setup Completes Normally>

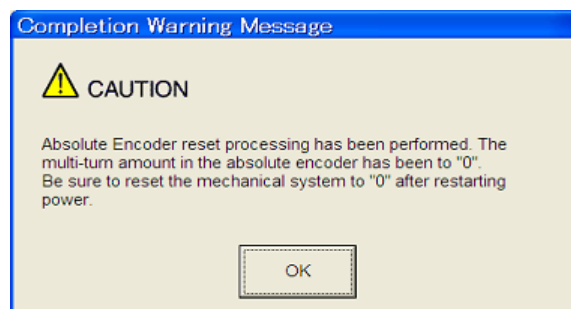

If the encoder is set up successfully, a warning message will appear reminding you that the coordinate system has changed and must also be reset.

6. Click **OK** to return to the main window.
7. To perform an origin search, restart the SERVOPACK.

4.7.5 Multiturn Limit Setting

The multiturn limit setting is used in position control applications for a turntable or other rotating device. For example, consider a machine that moves the turntable in the following diagram in only one direction.

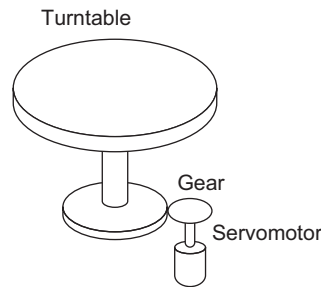

Because the turntable moves in only one direction, the upper limit for revolutions that can be counted by an absolute encoder will eventually be exceeded. The multiturn limit setting is used in cases like this to prevent fractions from being produced by the integral ratio of the motor revolutions and turntable revolutions.

For a machine with a gear ratio of $n:m$, as shown above, the value of m minus 1 will be the setting for the multiturn limit setting (Pn205).

Multiturn limit setting (Pn205) = $m-1$

The case in which the relationship between the turntable revolutions and motor revolutions is $m = 100$ and $n = 3$ is shown in the following graph.

Pn205 is set to 99.

$Pn205 = 100 - 1 = 99$

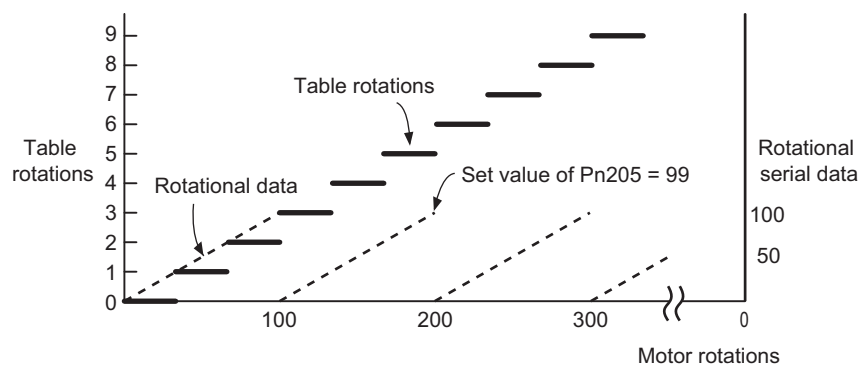

Pn205	Multiturn Limit Setting				Classification
	Setting Range	Setting Unit	Factory Setting	When Enabled	
	0 to 65535	1 Rev	65535	After restart	

Note: This parameter is valid when the absolute encoder is used.

The range of the data will vary when this parameter is set to anything other than the factory setting.

- When the motor rotates in the reverse direction with the rotational data at 0, the rotational data will change to the setting of Pn205.
- When the motor rotates in the forward direction with the rotational data at the Pn205 setting, the rotational data will change to 0.

Set the value, the desired rotational amount -1, to Pn205.

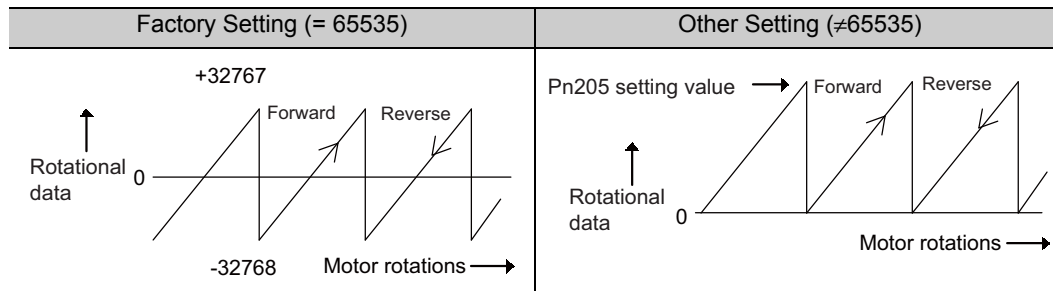

4.7.6 Multiturn Limit Disagreement Alarm (A.CC0)

When the multiturn limit set value is changed with parameter Pn205, a multiturn limit disagreement alarm (A.CC0) will be displayed because the value differs from that of the encoder.

Alarm Display	Alarm Name	Alarm Output	Meaning
A.CC0	Multiturn Limit Disagreement	OFF (H)	Different multiturn limits have been set in the encoder and SERVOPACK.

If this alarm is displayed, perform the procedure given in (2) *Operating Procedure* to change the multiturn limit value in the encoder to the value set in Pn205.

(1) Preparation

The following condition must be met to clear the alarm and change the multiturn limit value.

- The write prohibited setting parameter (Fn010) must be set to Write permitted (P.0000).

(2) Operating Procedure

Use the following procedure.

This setting can be performed with the adjustment command (ADJ).

For information the adjustment command (ADJ), refer to *ΣV Series User's Manual MECHATROLINK-II Commands* (Manual No.: SIEP S800000 54).

1. In the SigmaWin+ main window, click **Setup – Set Absolute Encoder – Multi-Turn Limit Setting**.

A verification message will appear confirming if you want to continue although the position data will change.

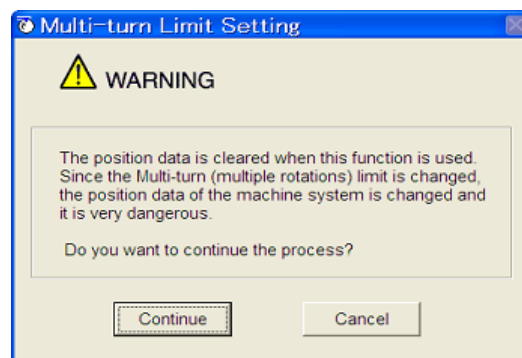

Click **Cancel** to return to the main window without setting the multi-turn limit.

2. Click **Continue**.

The Multi-Turn Limit Setting box will appear.

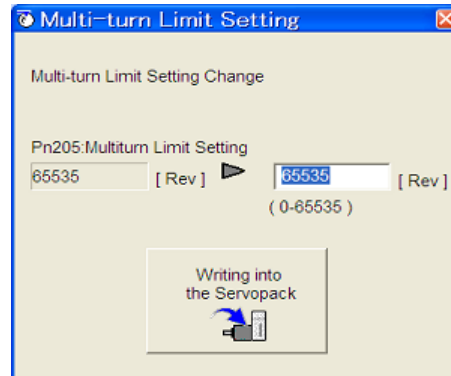

3. Change the setting to the desired number of revolutions.

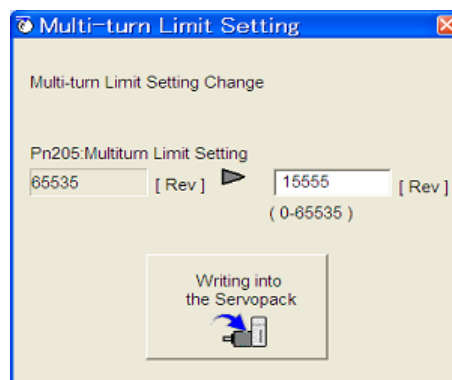

4. To save the settings, click **Writing into the Servopack**.

A warning message will appear.

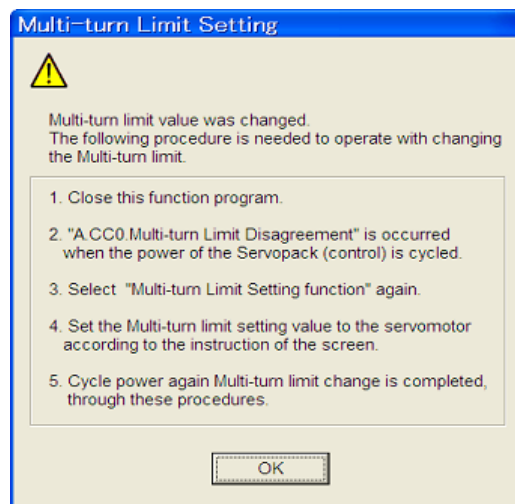

5. Click **OK** and the settings are changed to the new ones.

6. Restart the SERVOPACK.

Because only the settings for the SERVOPACK were made, the settings for the servomotor are still incomplete and an alarm occurs.

- Return to the SigmaWin+ main window. To make the settings for the servomotor, click **Setup – Multi-Turn Limit Setting** again.

A verification message will appear confirming if you want to continue although the position data will change.

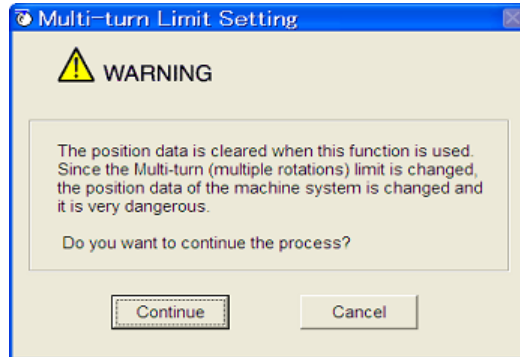

- Click **Continue**.

The Multi-Turn Limit Setting box will appear. To change the settings, click **Re-Change**.

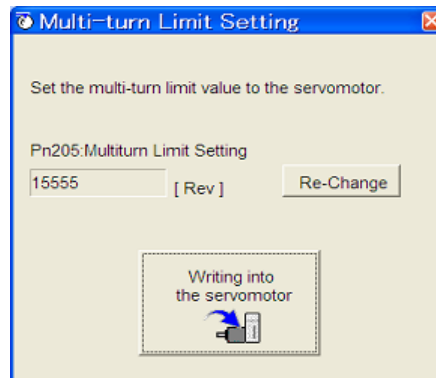

- To save the settings, click **Writing into the Motor**.

A warning message will appear.

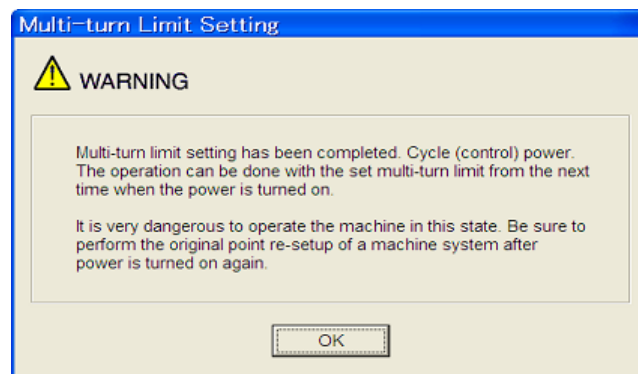

- Click **OK**.

4.7.7 Absolute Encoder Origin Offset

If using the absolute encoder, the positions of the encoder and the offset of the machine coordinate system (APOS) can be set. Use Pn808 to make the setting. After the SENS_ON command is received by MECHATROLINK communications, this parameter will be enabled.

Pn808	Absolute Encoder Origin Offset				Classification
	Setting Range	Setting Unit	Factory Setting	When Enabled	
	-1073741823 to 1073741823	1 reference unit	0	Immediately	Setup

<Example>

If the encoder position (X) is set at the origin of the machine coordinate system (0), Pn808 = X.

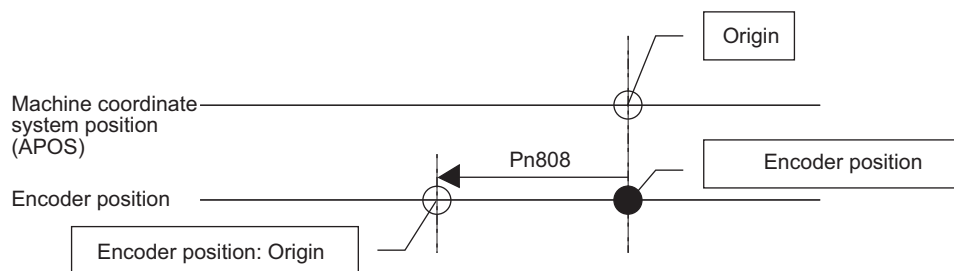

4.8 Other Output Signals

This section explains other output signals.

Use these signals according to the application needs, e.g., for machine protection.

4.8.1 Servo Alarm Output Signal (ALM)

This section describes signals that are output when the SERVOPACK detects errors and resetting methods.

(1) Servo Alarm Output Signal (ALM)

This signal is output when the SERVOPACK detects an error.

 IMPORTANT	<p>Configure an external circuit so that this alarm output turns OFF the main circuit power supply for the SERVOPACK whenever an error occurs.</p>
-------------------------------------------------------------------------------------------------------	----------------------------------------------------------------------------------------------------------------------------------------------------

Type	Signal Name	Connector Pin Number	Setting	Meaning
Output	ALM	CN1-4	ON (closed)	Normal SERVOPACK status
			OFF (open)	SERVOPACK alarm status

(2) Alarm Reset Method

If a servo alarm (ALM) occurs, use one of the following methods to reset the alarm after eliminating the cause of the alarm.

 IMPORTANT	<p>Be sure to eliminate the cause of the alarm before resetting it. If the alarm is reset and operation continued without eliminating the cause of the alarm, it may result in damage to the equipment or fire.</p>
---------------------------------------------------------------------------------------------------------	-------------------------------------------------------------------------------------------------------------------------------------------------------------------------------------------------------------------------

■ Resetting Alarms by Sending Clear Warning or Alarm Command (ALM_CLR)

For details, refer to *Σ-V Series User's Manual, MECHATROLINK-II Commands* (Manual No.: S1EP S800000 54).

4.8.2 Warning Output Signal (/WARN)

This signal is for a warning issued before the occurrence of an alarm.

Refer to 8.2.1 *List of Warnings*.

■ Signal Specifications

Type	Signal Name	Connector Pin Number	Setting	Meaning
Output	/WARN	Must be allocated	ON (closed)	Warning status
			OFF (open)	Normal status

Note: Use parameter Pn50F.3 to allocate the /WARN signal for use. For details, refer to 3.3.2 *Output Signal Allocations*.

4.8.3 Rotation Detection Output Signal (/TGON)

This output signal indicates that the servomotor is rotating at the speed set for Pn502 or a higher speed.

(1) Signal Specifications

Type	Signal Name	Connector Pin Number	Setting	Meaning
Output	/TGON	Must be allocated	ON (closed)	Servomotor is rotating with the motor speed above the setting in Pn502.
			OFF (open)	Servomotor is rotating with the motor speed below the setting in Pn502.

Note: Use parameter Pn50E.2 to allocate the /TGON signal for use. For details, refer to 3.3.2 *Output Signal Allocations*.

(2) Related Parameter

Set the range in which the /TGON signal is output using the following parameter.

Pn502	Rotation Detection Level				Classification
	Setting Range	Setting Unit	Factory Setting	When Enabled	
	1 to 10000	1 min ⁻¹	20	Immediately	

4.8.4 Servo Ready Output Signal (/S-RDY)

This signal is turned ON when the SERVOPACK is ready to accept the servo ON (SV_ON) command.

The /S-RDY signal is turned ON under the following conditions.

- The main circuit power supply is ON.
- No servo alarms
- The Turn Encoder Power Supply ON (SENS_ON) command is received. (When an absolute encoder is used.)
- If an absolute encoder is used, the output of absolute data to the host controller must have been completed when the SENS_ON command is received.

(1) Signal Specifications

Type	Signal Name	Connector Pin Number	Setting	Meaning
Output	/S-RDY	Must be allocated	ON (closed)	The SERVOPACK is ready to accept the SV_ON command.
			OFF (open)	The SERVOPACK is not ready to accept the SV_ON command.

Note: Use parameter Pn50E.3 to allocate the /S-RDY signal for use. For details, refer to 3.3.2 *Output Signal Allocations*.

4.8.5 Speed Coincidence Output Signal (/V-CMP)

The speed coincidence output signal (/V-CMP) is output when the actual servomotor speed is the same as the reference speed. The host controller uses the signal as an interlock. This signal is the output signal during speed control.

Type	Signal Name	Connector Pin Number	Setting	Meaning
Output	/V-CMP	Must be allocated	ON (closed)	Speed coincides.
			OFF (open)	Speed does not coincide.

Note: Use parameter Pn50E.1 to allocate the /V-CMP signal for use. Refer to 3.3.2 *Output Signal Allocations* for details.

Pn503	Speed Coincidence Signal Output Width				Classification
	Setting Range	Setting Unit	Factory Setting	When Enabled	
	0 to 100	1 min ⁻¹	10	Immediately	Setup

The /V-CMP signal is output when the difference between the reference speed and actual motor speed is below this setting.

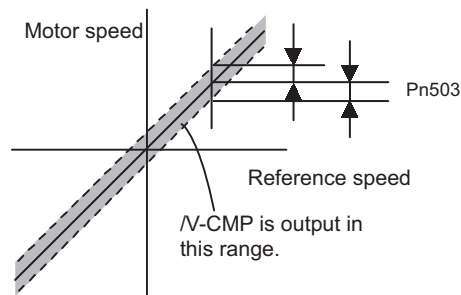

<Example>

The /V-CMP signal is output at 1900 to 2100 min⁻¹ if the Pn503 is set to 100 and the reference speed is 2000 min⁻¹.

4.8.6 Positioning Completed Output Signal (/COIN)

This signal indicates that servomotor movement has been completed during position control.

When the difference between the number of references output by the host controller and the travel distance of the servomotor (position error) drops below the set value in the parameter, the positioning completion signal will be output.

Use this signal to check the completion of positioning from the host controller.

Type	Signal Name	Connector Pin Number	Setting	Meaning
Output	/COIN	Must be allocated	ON (closed)	Positioning has been completed.
			OFF (open)	Positioning is not completed.

Note: Use parameter Pn50E.0 to allocate the /COIN signal for use. Refer to 3.3.2 *Output Signal Allocations* for details.

Pn522	Positioning Completed Width				Classification
	Setting Range	Setting Unit	Factory Setting	When Enabled	
	0 to 1073741824	1 reference unit	7	Immediately	

The positioning completed width setting has no effect on final positioning accuracy.

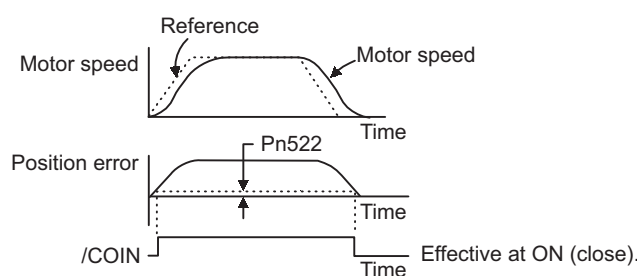

Note: If the parameter is set to a value that is too large, a positioning completed signal might be output if the position error is low during a low speed operation. This will cause the positioning completed signal to be output continuously. If this signal is output unexpectedly, reduce the set value until it is no longer output.

If the position error is kept to a minimum when the positioning completed width is small, use Pn207.3 to change output timing for the /COIN signal.

Parameter	Name	Meaning	When Enabled	Classification
Pn207	n.0□□□ [Factory setting]	When the absolute value of the position error is below the positioning completed width (Pn522).	After restart	Setup
	n.1□□□	When the absolute value of the position error is below the positioning completed width (Pn522), and the reference after applying the position reference filter is 0.		
	n.2□□□	When the absolute value of the position error is below the positioning completed width (Pn522), and the position reference input is 0.		

4.8.7 Positioning Near Output Signal (/NEAR)

Before confirming that the positioning completed signal has been received, the host controller first receives a positioning near signal and can prepare the operating sequence after positioning has been completed. The time required for this sequence after positioning can be shortened.

This signal is generally used in combination with the positioning completed output signal.

Type	Signal Name	Connector Pin Number	Setting	Meaning
Output	/NEAR	Must be allocated	ON (closed)	The servomotor has reached a point near to positioning completed.
			OFF (open)	The servomotor has not reached a point near to positioning completed.

Note: Use parameter Pn510.0 to allocate the /NEAR signal for use. Refer to 3.3.2 Output Signal Allocations for details.

Pn524	NEAR Signal Width				Classification
	Setting Range	Setting Unit	Factory Setting	When Enabled	
	1 to 1073741824	1 reference unit	1073741824	Immediately	

The positioning near signal (/NEAR) is output when the difference between the number of references output by the host controller and the travel distance of the servomotor (position error) is less than the set value.

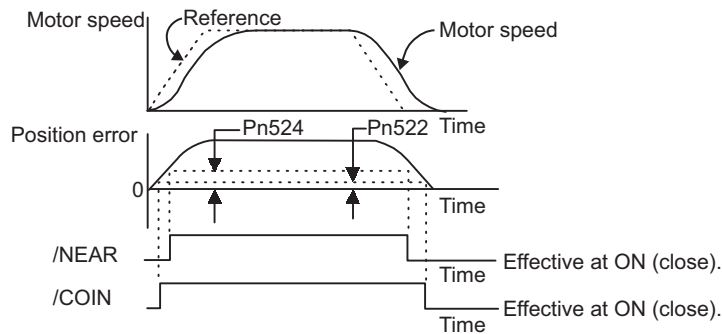

Note: Normally, the value of Pn524 should be larger than that for the positioning completed width (Pn522).

4.8.8 Speed Limit Detection Signal (/VLT)

This function limits the speed of the servomotor to protect the machine.

A servomotor in torque control is controlled to output the specified torque, but the motor speed is not controlled. Therefore, if an excessive reference torque is set for the load torque on the machinery side, the speed of the servomotor may increase greatly. If that may occur, use this function to limit the speed.

Note: The actual limit value of motor speed depends on the load conditions of the servomotor.

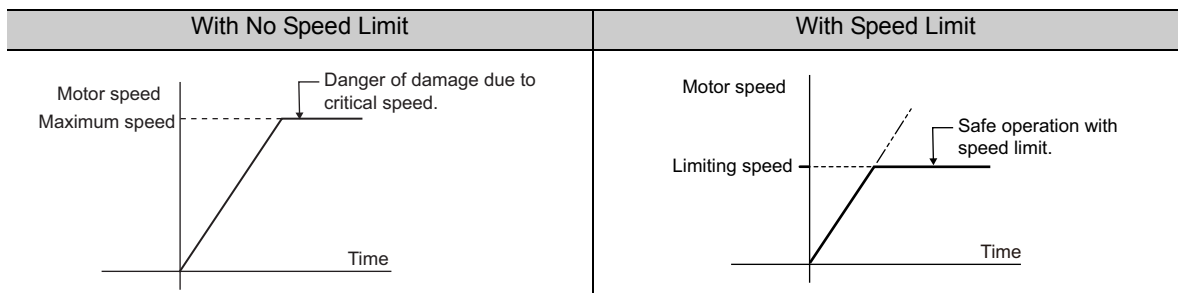

Refer to the following parameters for speed limit.

(1) Signals Output during Servomotor Speed Limit

The following signal is output when the motor speed reaches the limit speed.

Type	Signal Name	Connector Pin Number	Setting	Meaning
Output	/VLT	Must be allocated	ON (closed)	Servomotor speed limit being applied.
			OFF (open)	Servomotor speed limit not being applied.

Note: Use parameter Pn50F.1 to allocate the /VLT signal for use. For details, refer to 3.3.2 *Output Signal Allocations*.

(2) Speed Limit Setting

Select the speed limit mode with Pn002.1.

Parameter	Meaning	When Enabled	Classification
Pn002	n.□□0□ [Factory setting]	After restart	Setup
	n.□□1□		

■ Internal Speed Limit Function

If the internal speed limit function is selected in Pn002.1, set the limit of the maximum speed of the servomotor in Pn407. The limit of the speed in Pn408.1 can be either the maximum speed of the servomotor or the overspeed alarm detection speed. Select the overspeed alarm detection speed to limit the speed to the maximum speed of the servomotor or the equivalent.

Pn407	Speed Limit During Torque Control				Classification
	Setting Range	Setting Unit	Factory Setting	When Enabled	
	0 to 10000	1 min ⁻¹	10000	Immediately	Setup

Note: The servomotor's maximum speed or the overspeed alarm detection speed will be used when the setting in this parameter exceeds the maximum speed of the servomotor used.

Parameter	Meaning	When Enabled	Classification
Pn408	n.□□0□ [Factory setting]	After restart	Setup
	n.□□1□		

■ External Speed Limit Function

If the external speed limit function is selected in Pn002.1, the motor speed is controlled by the speed limit value (VLIM). For details, refer to *ΣV Series User's Manual, MECHATROLINK-II Commands* (Manual No.: SIEP S800000 54).

Adjustments

5.1 Type of Adjustments and Basic Adjustment Procedure	5-3
5.1.1 Adjustments	5-3
5.1.2 Basic Adjustment Procedure	5-4
5.1.3 Monitoring Operation during Adjustment	5-5
5.1.4 Safety Precautions on Adjustment of Servo Gains	5-8
5.2 Tuning-less Function	5-11
5.2.1 Tuning-less Function	5-11
5.2.2 Tuning-less Levels Setting (Fn200) Procedure	5-13
5.2.3 Related Parameters	5-17
5.3 Advanced Autotuning (Fn201)	5-18
5.3.1 Advanced Autotuning	5-18
5.3.2 Advanced Autotuning Procedure	5-21
5.3.3 Related Parameters	5-33
5.4 Advanced Autotuning by Reference (Fn202)	5-34
5.4.1 Advanced Autotuning by Reference	5-34
5.4.2 Advanced Autotuning by Reference Procedure	5-36
5.4.3 Related Parameters	5-42
5.5 One-parameter Tuning (Fn203)	5-43
5.5.1 One-parameter Tuning	5-43
5.5.2 One-parameter Tuning Procedure	5-43
5.5.3 One-parameter Tuning Example	5-52
5.5.4 Related Parameters	5-53
5.6 Anti-Resonance Control Adjustment Function (Fn204)	5-54
5.6.1 Anti-Resonance Control Adjustment Function	5-54
5.6.2 Anti-Resonance Control Adjustment Function Operating Procedure	5-55
5.6.3 Related Parameters	5-63
5.7 Vibration Suppression Function (Fn205)	5-64
5.7.1 Vibration Suppression Function	5-64
5.7.2 Vibration Suppression Function Operating Procedure	5-65
5.7.3 Related Parameters	5-70

5.8 Additional Adjustment Function	5-71
5.8.1 Switching Gain Settings	5-71
5.8.2 Manual Adjustment of Friction Compensation	5-75
5.8.3 Current Control Mode Selection Function	5-77
5.8.4 Current Gain Level Setting	5-77
5.8.5 Speed Detection Method Selection	5-77
5.8.6 Backlash Compensation Function	5-78
5.9 Compatible Adjustment Function	5-84
5.9.1 Feedforward Reference	5-84
5.9.2 Mode Switch (P/PI Switching)	5-85
5.9.3 Torque Reference Filter	5-87
5.9.4 Position Integral	5-89

5.1 Type of Adjustments and Basic Adjustment Procedure

This section describes type of adjustments and the basic adjustment procedure.

5.1.1 Adjustments

Adjustments (tuning) are performed to optimize the responsiveness of the SERVOPACK.

The responsiveness is determined by the servo gain that is set in the SERVOPACK.

The servo gain is set using a combination of parameters, such as speed loop gain, position loop gain, filters, friction compensation, and moment of inertia ratio. These parameters influence each other. Therefore, the servo gain must be set considering the balance between the set values.

Generally, the responsiveness of a machine with high rigidity can be improved by increasing the servo gain. If the servo gain of a machine with low rigidity is increased, however, the machine will vibrate and the responsiveness may not be improved. In such case, it is possible to suppress the vibration with a variety of vibration suppression functions in the SERVOPACK.

The servo gains are factory-set to appropriate values for stable operation. The following utility function can be used to adjust the servo gain to increase the responsiveness of the machine in accordance with the actual conditions. With this function, parameters related to adjustment above will be adjusted automatically and the need to adjust them individually will be eliminated.

This section describes the following utility adjustment functions. The SigmaWin+ is required to make adjustments.

Utility Function for Adjustment	Outline	Applicable Control Method
Tuning-less Levels Setting (Fn200)	This function is enabled when the factory settings are used. This function can be used to obtain a stable response regardless of the type of machine or changes in the load.	Speed and Position
Advanced Autotuning (Fn201)	The following parameters are automatically adjusted using internal references in the SERVOPACK during automatic operation. <ul style="list-style-type: none"> • Moment of inertia ratio • Gains (position loop gain, speed loop gain, etc.) • Filters (torque reference filter, notch filter) • Friction compensation • Anti-resonance control adjustment function • Vibration suppression function 	Speed and Position
Advanced Autotuning by Reference (Fn202)	The following parameters are automatically adjusted with the position reference input from the host controller while the machine is in operation. <ul style="list-style-type: none"> • Gains (position loop gain, speed loop gain, etc.) • Filters (torque reference filter, notch filter) • Friction compensation • Anti-resonance control adjustment function • Vibration suppression function 	Position
One-parameter Tuning (Fn203)	The following parameters are manually adjusted with the position or speed reference input from the host controller while the machine is in operation. <ul style="list-style-type: none"> • Gains (position loop gain, speed loop gain, etc.) • Filters (torque reference filter, notch filter) • Friction compensation • Anti-resonance control adjustment function 	Speed and Position
Anti-Resonance Control Adjustment Function (Fn204)	This function effectively suppresses continuous vibration.	Speed and Position
Vibration Suppression Function (Fn205)	This function effectively suppresses residual vibration if it occurs when positioning.	Position

5.1.2 Basic Adjustment Procedure

The basic adjustment procedure is shown in the following flowchart. Make suitable adjustments considering the conditions and operating requirements of the machine.

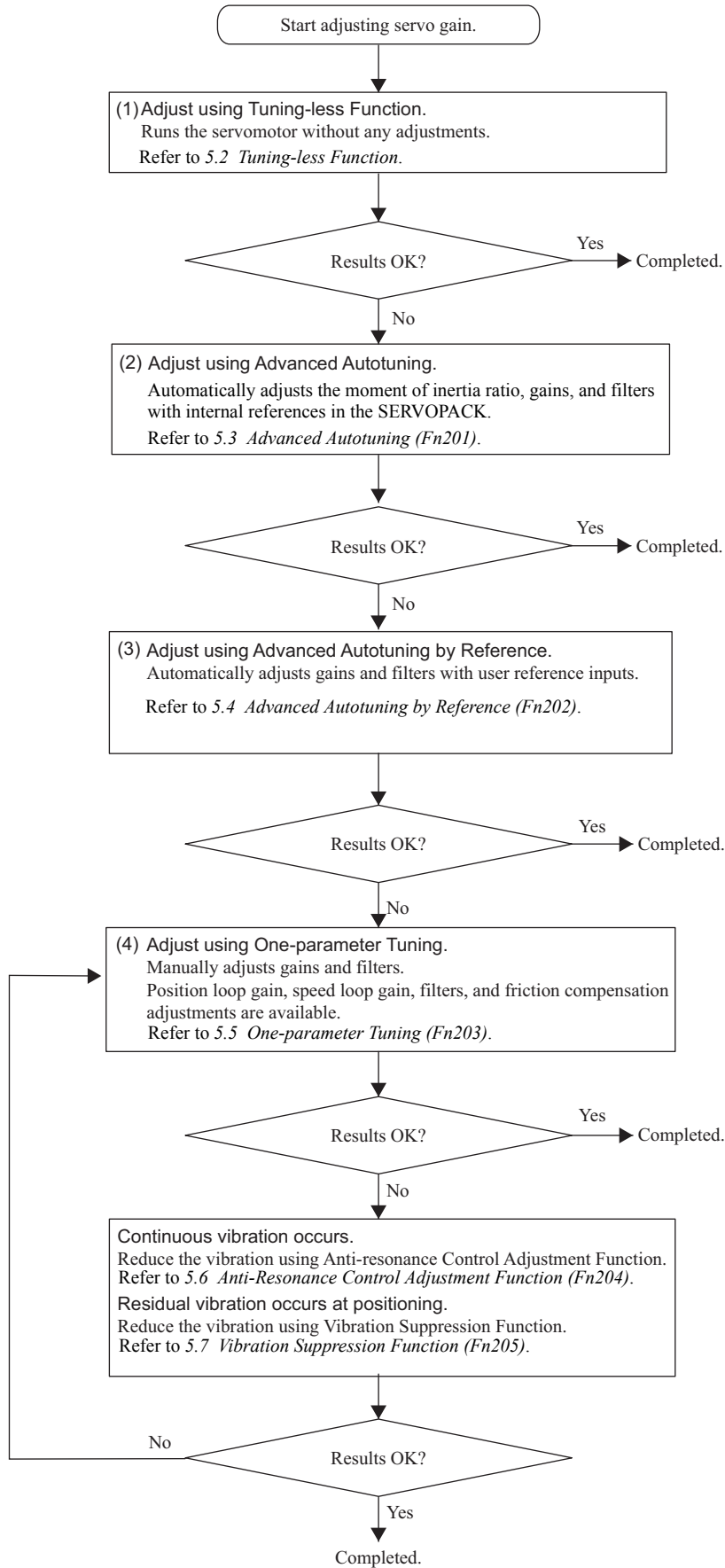

5.1.3 Monitoring Operation during Adjustment

While adjusting the servo gain, always monitor the operating status of the machine and the signal waveform. Connect a measurement instrument, such as a memory recorder, to the SERVOPACK to monitor the signal waveform.

The settings and parameters that are related to monitoring the analog signal are described in the following sections.

(1) Connecting the Measurement Instrument

Use the external monitor connector (CN5) on the SERVOPACK to connect the measurement instrument. The devices and cables that are required for connection are listed below.

- Analog monitor unit (model: JUSP-PC001-E)
- Analog monitor unit connection cable (model: JZSP-CF1S06-A3-E)
- Analog monitor cable (model: JZSP-CA01-E)

Connection examples are shown below.

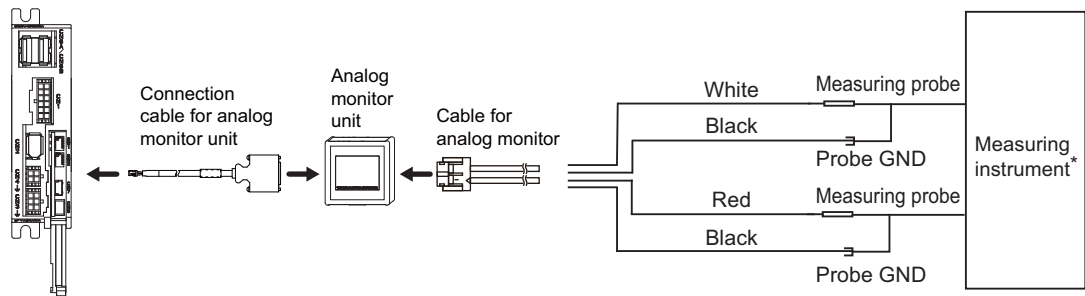

* Measuring instrument is not included.

Line Color	Signal Name	Factory Setting
White	Analog monitor 1	Torque reference: 1 V/100% rated torque
Red	Analog monitor 2	Motor speed: 1 V/1000 min ⁻¹
Black (2 lines)	GND	Analog monitor GND: 0 V

(2) Monitor Signal

The shaded parts in the following diagram indicate analog output signals that can be monitored.

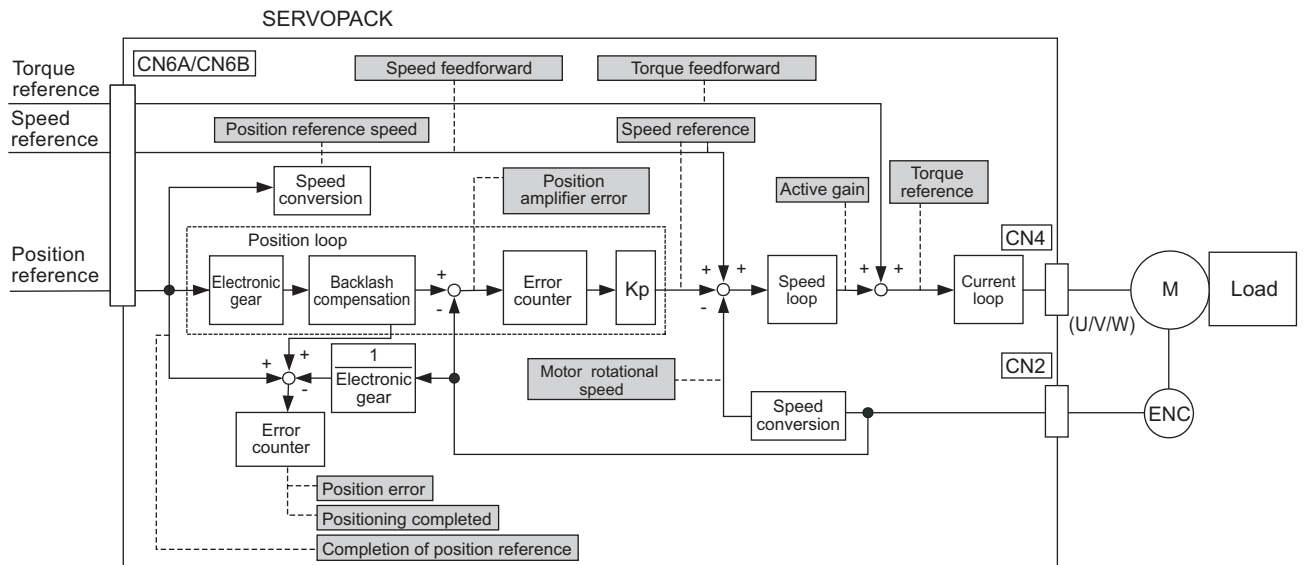

The following signals can be monitored by selecting functions with parameters Pn006 and Pn007. Pn006 is used for analog monitor 1 and Pn007 is used for analog monitor 2.

Parameter		Description		
		Monitor Signal	Unit	Remarks
Pn006 Pn007	n.□□00 [Pn007 Factory Setting]	Motor rotating speed	1 V/1000 min ⁻¹	–
	n.□□01	Speed reference	1 V/1000 min ⁻¹	–
	n.□□02 [Pn006 Factory Setting]	Torque reference	1 V/100% rated torque	–
	n.□□03	Position error	0.05 V/1 reference unit	0 V at speed/torque control
	n.□□04	Position amplifier error	0.05 V/1 encoder pulse unit	Position error after electronic gear conversion
	n.□□05	Position reference speed	1 V/1000 min ⁻¹	–
	n.□□06 n.□□07	Reserved (Do not change.)	–	–
	n.□□08	Positioning completed	Positioning completed: 5 V Positioning not completed: 0 V	Completion indicated by output voltage.
	n.□□09	Speed feedforward	1 V/1000 min ⁻¹	–
	n.□□0A	Torque feedforward	1 V/100% rated torque	–
	n.□□0B	Active gain *	1st gain: 1 V 2nd gain: 2 V	Gain type indicated by output voltage.
	n.□□0C	Completion of position reference	Completed: 5 V Not completed: 0 V	Completion indicated by output voltage.
	n.□□0D	Reserved (Do not change.)	–	–

* Refer to 5.8.1 *Switching Gain Settings* for details.

(3) Setting Monitor Factor

The output voltages on analog monitors 1 and 2 are calculated by the following equations.

$$\text{Analog monitor 1 output voltage} = (-1) \times \left(\begin{array}{l} \text{Signal selection} \times \text{Multiplier} + \text{Offset voltage [V]} \\ (\text{Pn006}=\text{n.00}\square\square) \quad (\text{Pn552}) \quad (\text{Pn550}) \end{array} \right)$$

$$\text{Analog monitor 2 output voltage} = (-1) \times \left(\begin{array}{l} \text{Signal selection} \times \text{Multiplier} + \text{Offset voltage [V]} \\ (\text{Pn007}=\text{n.00}\square\square) \quad (\text{Pn553}) \quad (\text{Pn551}) \end{array} \right)$$

<Example>

Analog monitor output at n.□□00 (motor rotating speed setting)

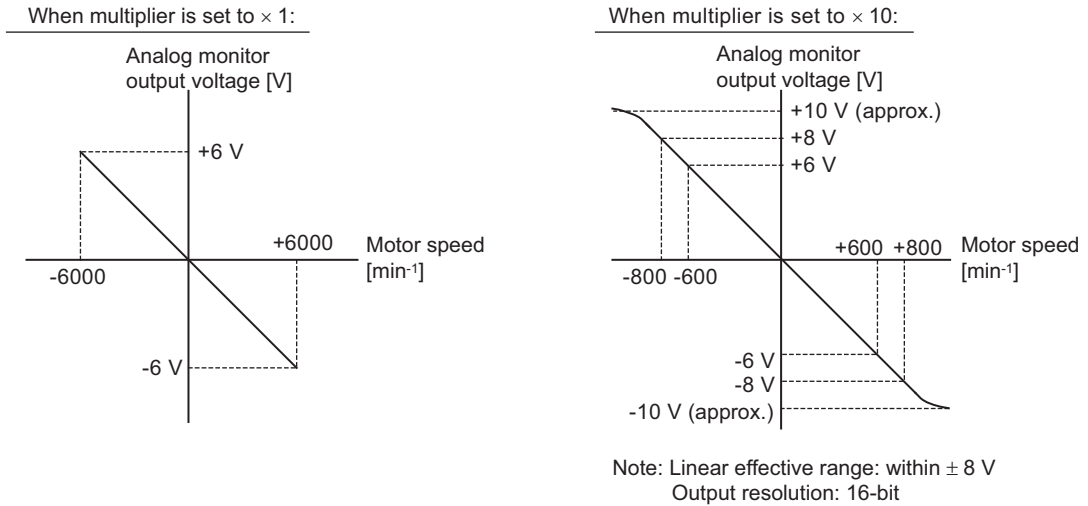

(4) Related Parameters

Use the following parameters to change the monitor factor and the offset.

Pn550	Analog Monitor 1 Offset Voltage [Speed] [Position] [Torque]				Classification
	Setting Range	Setting Unit	Factory Setting	When Enabled	
	-10000 to 10000	0.1 V	0	Immediately	
Pn551	Analog Monitor 2 Offset Voltage [Speed] [Position] [Torque]				Classification
	Setting Range	Setting Unit	Factory Setting	When Enabled	
	-10000 to 10000	0.1 V	0	Immediately	
Pn552	Analog Monitor Magnification (× 1) [Speed] [Position] [Torque]				Classification
	Setting Range	Setting Unit	Factory Setting	When Enabled	
	-10000 to 10000	× 0.01	100	Immediately	
Pn553	Analog Monitor Magnification (× 2) [Speed] [Position] [Torque]				Classification
	Setting Range	Setting Unit	Factory Setting	When Enabled	
	-10000 to 10000	× 0.01	100	Immediately	

5.1.4 Safety Precautions on Adjustment of Servo Gains



CAUTION

- If adjusting the servo gains, observe the following precautions.
 - Do not touch the rotating section of the servomotor while power is being supplied to the motor.
 - Before starting the servomotor, make sure that the SERVOPACK can come to an emergency stop at any time.
 - Make sure that a trial operation has been performed without any trouble.
 - Install a safety brake on the machine.

Set the following protective functions of the SERVOPACK to the correct settings before starting to adjust the servo gains.

(1) Overtravel Function

Set the overtravel function. For details on how to set the overtravel function, refer to 4.3.2 *Overtravel*.

(2) Torque Limit

The torque limit calculates the torque required to operate the machine and sets the torque limits so that the output torque will not be greater than required. Setting torque limits can reduce the amount of shock applied to the machine when troubles occur, such as collisions or interference. If a torque limit is set lower than the value that is needed for operation, overshooting or vibration can be occurred.

For details, refer to 4.6 *Limiting Torque*.

(3) Excessive Position Error Alarm Level

The excessive position error alarm is a protective function that will be enabled when the SERVOPACK is used in position control.

If this alarm level is set to a suitable value, the SERVOPACK will detect an excessive position error and will stop the servomotor if the servomotor does not operate according to the reference. The position error indicates the difference between the position reference value and the actual motor position.

The position error can be calculated from the position loop gain (Pn102) and the motor speed with the following equation.

$$\text{Position Error [reference unit]} = \frac{\text{Motor Speed [min}^{-1}\text{]}}{60} \times \frac{\text{Encoder Resolution}^{*1}}{\text{Pn102 [0.1/s]/10}^{*2}} \times \frac{\text{Pn210}}{\text{Pn20E}}$$

- Excessive Position Error Alarm Level (Pn520 [1 reference unit])

$$\text{Pn520} > \frac{\text{Max. Motor Speed [min}^{-1}\text{]}}{60} \times \frac{\text{Encoder Resolution}^{*1}}{\text{Pn102 [0.1/s]/10}^{*2}} \times \frac{\text{Pn210}}{\text{Pn20E}} \times \underline{(1.2 \text{ to } 2)}$$

*1. Refer to 4.4.3 *Electronic Gear*.

*2. To check the Pn102 setting, change the parameter display setting to display all parameters (Pn00B.0 = 1).

At the end of the equation, a coefficient is shown as "× (1.2 to 2)." This coefficient is used to add a margin that prevents a position error overflow alarm (A.d00) from occurring in actual operation of the servomotor.

Set the level to a value that satisfies these equations, and no position error overflow alarm (A.d00) will be generated during normal operation. The servomotor will be stopped, however, if it does not operate according to the reference and the SERVOPACK detects an excessive position error.

The following example outlines how the maximum limit for position deviation is calculated. These conditions apply.

- Maximum speed = 6000
- Encoder resolution = 131072 (17 bits)
- Pn102 = 400
- $\frac{\text{Pn210}}{\text{Pn20E}} = \frac{1}{1}$

Under these conditions, the following equation is used to calculate the maximum limit (Pn520).

$$\begin{aligned} \text{Pn520} &= \frac{6000}{60} \times \frac{131072}{400/10} \times \frac{1}{1} \times 2 \\ &= 327680 \times 2 \\ &= 655360 \end{aligned}$$

If the acceleration/deceleration of the position reference exceeds the capacity of the servomotor, the servomotor cannot perform at the requested speed, and the allowable level for position error will be increased as not to satisfy these equations. If so, lower the level of the acceleration/deceleration for the position reference so that the servomotor can perform at the requested speed or increase the excessive position error alarm level (Pn520).

■ Related Parameter

Pn520	Excessive Position Error Alarm Level Position				Classification
	Setting Range	Setting Unit	Factory Setting	When Enabled	
	1 to 1073741823	1 reference unit	5242880	Immediately	Setup

■ Related Alarm

Alarm Display	Alarm Name	Meaning
A.d00	Position Error Overflow	Position errors exceeded parameter Pn520.

(4) Vibration Detection Function

Set the vibration detection function to an appropriate value with the vibration detection level initialization (Fn01B). For details on how to set the vibration detection function, refer to *6.15 Vibration Detection Level Initialization (Fn01B)*.

(5) Excessive Position Error Alarm Level at Servo ON

If position errors remain in the error counter when turning ON the servomotor power, the servomotor will move and this movement will clear the counter of all position errors. Because the servomotor will move suddenly and unexpectedly, safety precautions are required. To prevent the servomotor from moving suddenly, select the appropriate level for the excessive position error alarm level at servo ON (Pn526) to restrict operation of the servomotor.

■ Related Parameters

Pn526	Excessive Position Error Alarm Level at Servo ON Position				Classification
	Setting Range	Setting Unit	Factory Setting	When Enabled	
	1 to 1073741823	1 reference unit	5242880	Immediately	Setup

Pn528	Excessive Position Error Warning Level at Servo ON Position				Classification
	Setting Range	Setting Unit	Factory Setting	When Enabled	
	10 to 100	1%	100	Immediately	Setup

Pn529	Speed Limit Level at Servo ON Position				Classification
	Setting Range	Setting Unit	Factory Setting	When Enabled	
	0 to 10000	1 min ⁻¹	10000	Immediately	Setup

■ Related Alarms

Alarm Display	Alarm Name	Meaning
A.d01	Position Error Overflow Alarm at Servo ON	This alarm occurs if the servomotor power is turned ON when the position error is greater than the set value of Pn526 while the servomotor power is OFF.
A.d02	Position Error Overflow Alarm by Speed Limit at Servo ON	When the position errors remain in the error counter, Pn529 limits the speed if the servomotor power is turned ON. If Pn529 limits the speed in such a state, this alarm occurs when position references are input and the number of position errors exceeds the value set for the excessive position error alarm level (Pn520).

When an alarm occurs, refer to *8 Troubleshooting* and take the corrective actions.

5.2 Tuning-less Function

The tuning-less function is enabled in the factory settings. If resonance is generated or excessive vibration occurs, refer to 5.2.2 *Tuning-less Levels Setting (Fn200) Procedure* and change the set value of Pn170.2 for the rigidity level and the set value in Pn170.3 for the load level.

CAUTION

- The tuning-less function is enabled in the factory settings. A sound may be heard for a moment when the SV_ON command is received for the first time after the servo drive is mounted to the machine. This sound does not indicate any problems; it means that the automatic notch filter was set. The sound will not be heard from the next time the SV_ON command is received. For details on the automatic notch filter, refer to (3) *Automatically Setting the Notch Filter* on the next page.
- The servomotor may vibrate if the load moment of inertia exceeds the allowable load value. If vibration occurs, set the load level to mode 2 in the Pn170 parameter or lower the rigidity level.

5.2.1 Tuning-less Function

The tuning-less function obtains a stable response without manual adjustment regardless of the type of machine or changes in the load.

(1) Enabling/Disabling Tuning-less Function

The following parameter is used to enable or disable the tuning-less function.

Parameter	Meaning	When Enabled	Classification
n.□□□0	Disables tuning-less function.	After restart	Setup
n.□□□1 [Factory setting]	Enables tuning-less function.		
n.□□0□ [Factory setting]	Used as speed control.		
n.□□1□	Used as speed control and host controller used as position control.		

(2) Application Restrictions

The tuning-less function can be used in position control or speed control. This function is not available in torque control. The following application restrictions apply to the tuning-less function.

Function	Availability	Remarks
Vibration detection level initialization (Fn01B)	Available	–
Advanced autotuning (Fn201)	Available (Some conditions apply)	<ul style="list-style-type: none"> • This function can be used when the moment of inertia is calculated. • While this function is being used, the tuning-less function cannot be used. After completion of the autotuning, it can be used again.
Advanced autotuning by reference (Fn202)	Not available	–
One-parameter tuning (Fn203)	Not available	–
Anti-resonance control adjustment function (Fn204)	Not available	–
Vibration suppression function (Fn205)	Not available	–
EasyFFT (Fn206)	Available	While this function is being used, the tuning-less function cannot be used. After completion of the EasyFFT, it can be used again.
Friction compensation	Not available	–
Gain switching	Not available	–

(cont'd)

Function	Availability	Remarks
Offline moment of inertia calculation *	Not available	Disable the tuning-less function by setting Pn170.0 to 0 before executing this function.
Mechanical analysis*	Available	While this function is being used, the tuning-less function cannot be used. After completion of the analysis, it can be used again.

* Operate using SigmaWin+.

(3) Automatically Setting the Notch Filter

Usually, set this function to Auto Setting. (The notch filter is factory-set to Auto Setting.)

If this function is set to Auto Setting, vibration will be detected automatically and the notch filter will be set when the tuning-less function is enabled.

Set this function to Not Auto Setting only if you do not change the notch filter setting before executing tuning-less function.

Parameter	Meaning	When Enabled	Classification	
Pn460	n.□0□□	Does not set the 2nd notch filter automatically with utility function.	Immediately	Tuning
	n.□1□□ [Factory setting]			

(4) Tuning-less Level Settings

Two tuning-less levels are available: the rigidity level and load level. Both levels can be set in the Pn170 parameter.

■ Rigidity Level

Parameter	Meaning	When Enabled	Classification	
Pn170	n.□0□□	Immediately	Setup	
	n.□1□□			Rigidity level 0 (Level 0)
	n.□2□□			Rigidity level 1 (Level 1)
	n.□3□□			Rigidity level 2 (Level 2)
	n.□4□□ [Factory setting]			Rigidity level 3 (Level 3)

■ Load Level

Parameter	Meaning	When Enabled	Classification	
Pn170	n.0□□□	Immediately	Setup	
	n.1□□□ [Factory setting]			Load level : Low (Mode 0)
	n.2□□□			Load level : Medium (Mode 1)

5.2.2 Tuning-less Levels Setting (Fn200) Procedure

CAUTION

- To ensure safety, perform the tuning-less function in a state where the SERVOPACK can come to an emergency stop at any time.

The procedure to use the tuning-less function is given below.

The SigmaWin+ is required to execute this function.

(1) Preparation

The following conditions must be met to perform the tuning-less function.

- The tuning-less function must be enabled (Pn170.0 = 1).
- The write prohibited setting parameter (Fn010) must be set to Write permitted (P.0000).
- The test without a motor function must be disabled. (Pn00C.0 = 0).

(2) Operating Procedure

Use the following procedure.

- In the SigmaWin+ main window, click **Parameters - Edit Parameters**.

The **Parameter Editing** dialog box will appear.

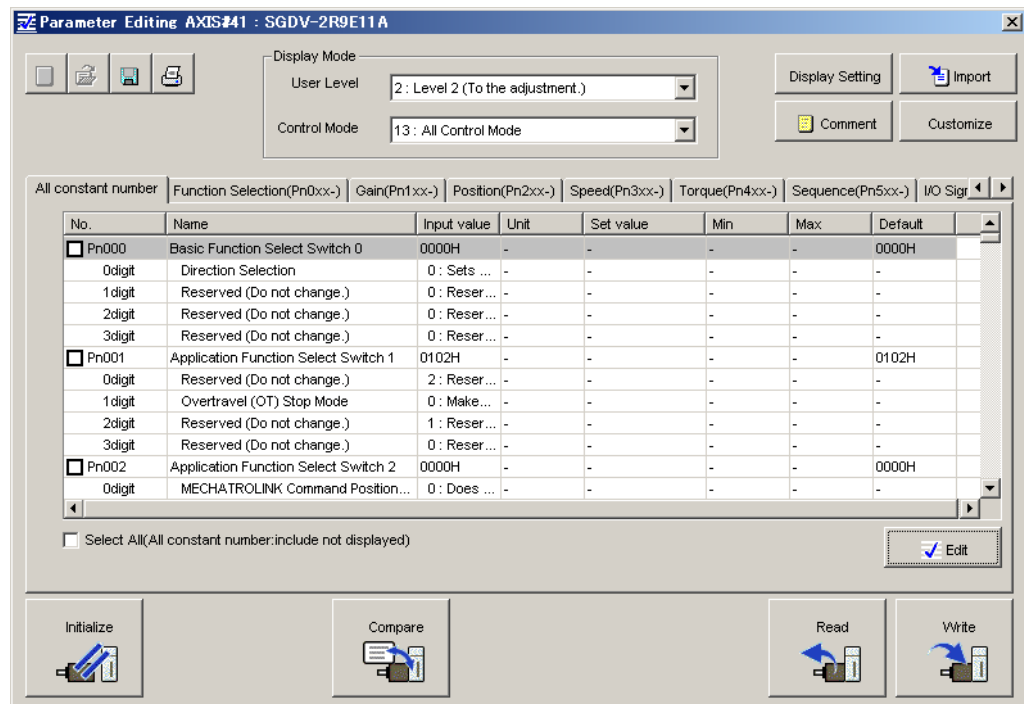

2. Select **Pn170** in the **Parameter Editing** dialog box.

If Pn170 cannot be seen in the **Parameter Editing** dialog box, click the arrows to view the parameter.

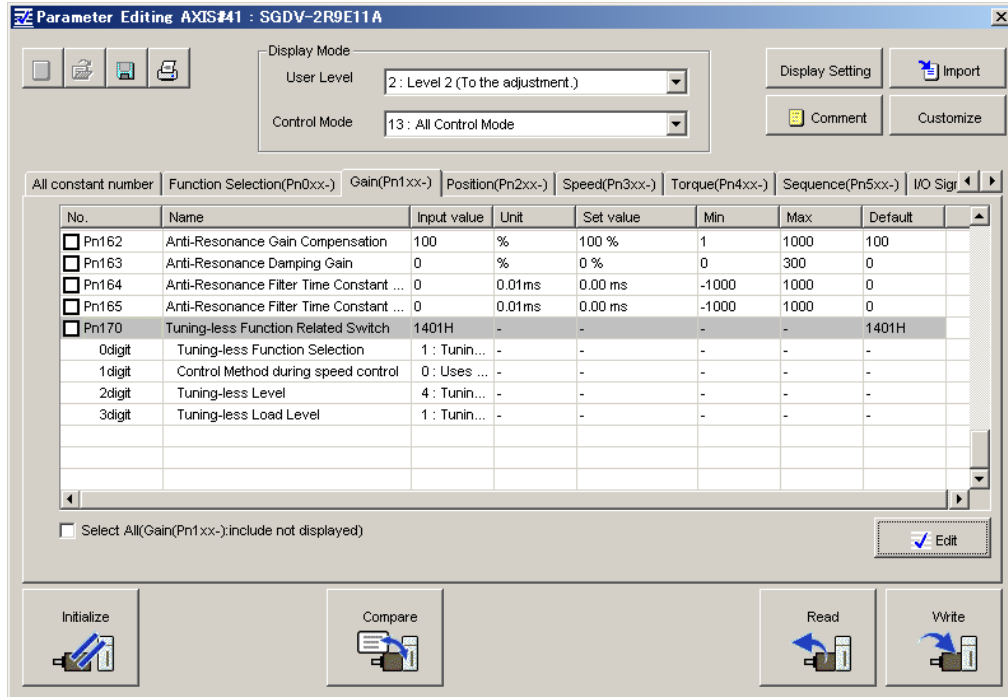

3. Click **Edit**.

The **Edit** box for Pn170 will appear.

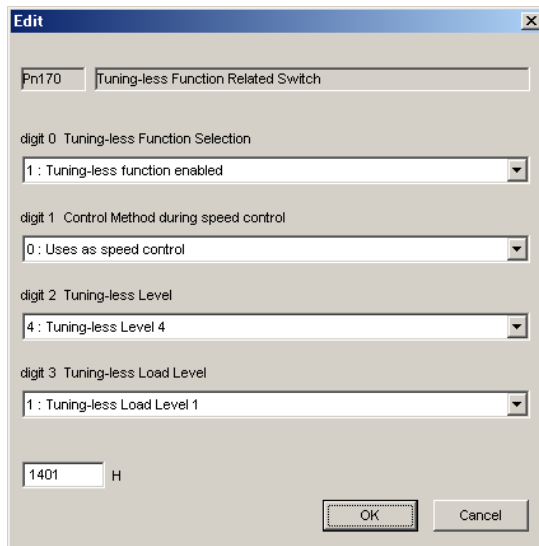

4. For 3rd digit, select one of the load levels in the **Tuning-less Load Level** list.
 - If the response waveform results in overshooting or if the load moment of inertia exceeds the allowable level, select **2: Tuning-less Load Level 2**. (If any damage caused when the load moment of inertia exceeds the allowable level, these conditions are regarded as being outside the scope of the warranty.)
 - If a high-frequency noise is heard, select **0: Tuning-less Load Level 0**.

The screenshot shows the 'Edit' dialog box for parameter Pn170, titled 'Tuning-less Function Related Switch'. The settings are as follows:

- digit 0 Tuning-less Function Selection: 1: Tuning-less function enabled
- digit 1 Control Method during speed control: 0: Uses as speed control
- digit 2 Tuning-less Level: 4: Tuning-less Level 4
- digit 3 Tuning-less Load Level: 2: Tuning-less Load Level 2

The address field is set to 2401 H. The OK and Cancel buttons are visible at the bottom.

5. For 2nd digit, select one of the tuning-less levels in the **Tuning-less Level** list. The higher the value of the level is, the higher the gain will be. A higher gain means better response.
 - Note 1. If the tuning-less level is too high, vibration might occur. Lower the level if vibration occurs.
 - Note 2. If the tuning-less level is changed, the automatically set notch filter will be canceled (disabled). If any vibration occurs, the notch filter will automatically be set again.

The screenshot shows the 'Edit' dialog box for parameter Pn170, titled 'Tuning-less Function Related Switch'. The settings are as follows:

- digit 0 Tuning-less Function Selection: 1: Tuning-less function enabled
- digit 1 Control Method during speed control: 0: Uses as speed control
- digit 2 Tuning-less Level: 2: Tuning-less Level 2
- digit 3 Tuning-less Load Level: 2: Tuning-less Load Level 2

The address field is set to 2201 H. The OK and Cancel buttons are visible at the bottom.

6. Click **OK**.
7. To enable the change in the setting, restart the SERVOPACK.

(3) Alarm and Corrective Actions

The autotuning alarm (A.521) will occur if resonance sound is generated or excessive vibration occurs during position control. In such case, take the following actions.

- Increase the setting of Pn170.3 or reduce the setting of Pn170.2.

(4) Parameters Disabled by Tuning-less Function

When the tuning-less function is enabled in the factory settings, the settings of these parameters are not available: Pn100, Pn101, Pn102, Pn103, Pn104, Pn105, Pn106, Pn160, Pn139, and Pn408. These gain-related parameters, however, may become effective depending on the executing conditions of the functions specified in the following table. For example, if EasyFFT is executed when the tuning-less function is enabled, the settings in Pn100, Pn104, Pn101, Pn105, Pn102, Pn106, and Pn103, as well as the manual gain switch setting, will be enabled, but the settings in Pn408.3, Pn160.0, and Pn139.0 will be not enabled.

Parameters Disabled by Tuning-less Function			Related Functions and Parameters*		
Item	Name	Pn Number	Torque Control	Easy FFT	Mechanical Analysis (Vertical Axis Mode)
Gain	Speed Loop Gain 2nd Speed Loop Gain	Pn100 Pn104	○	○	○
	Speed Loop Integral Time Constant 2nd Speed Loop Integral Time Constant	Pn101 Pn105	×	○	○
	Position Loop Gain 2nd Position Loop Gain	Pn102 Pn106	×	○	○
	Moment of Inertia Ratio	Pn103	○	○	○
Advanced Control	Friction Compensation Function Selection	Pn408.3	×	×	×
	Anti-resonance Control Adjustment Selection	Pn160.0	×	×	×
Gain Switching	Gain Switching Selection Switch	Pn139.0	×	×	×

- * ○: Parameter enabled
×: Parameter disabled

(5) Tuning-less Function Type

The following table shows the types of tuning-less functions.

Parameter	Meaning	When Enabled	Classification
Pn14F	n.□□0□	After restart	Tuning
	n.□□1□ [Factory setting]		

5.2.3 Related Parameters

The following table lists parameters related to this function and their possibility of being changed while executing this function or of being changed automatically after executing this function.

- Parameters related to this function

These are parameters that are used or referenced when executing this function.

- Allowed changes during execution of this function

Yes : Parameters can be changed using SigmaWin+ while this function is being executed.

No : Parameters cannot be changed using SigmaWin+ while this function is being executed.

- Automatic changes after execution of this function

Yes : Parameter set values are automatically set or adjusted after execution of this function.

No : Parameter set values are not automatically set or adjusted after execution of this function.

Parameter	Name	Mid-execution changes	Automatic changes
Pn170	Tuning-less Function Related Switch	No	Yes
Pn401	Torque Reference Filter Time Constant	No	Yes
Pn40C	2nd Notch Filter Frequency	No	Yes
Pn40D	2nd Notch Filter Q Value	No	Yes

5.3 Advanced Autotuning (Fn201)

This section describes the adjustment using advanced autotuning.



IMPORTANT

- Advanced autotuning starts adjustments based on the set speed loop gain (Pn100). Therefore, precise adjustments cannot be made if there is vibration when starting adjustments. In this case, make adjustments after lowering the speed loop gain (Pn100) until vibration is eliminated.
- Before performing advanced autotuning with the tuning-less function enabled (Pn170.0 = 1: Factory setting), always set Jcalc to ON to calculate the load moment of inertia. The tuning-less function will automatically be disabled, and the gain will be set by advanced autotuning.
With Jcalc set to OFF so the load moment of inertia is not calculated, "Error" will be displayed on the panel operator, and advanced autotuning will not be performed.
- If the operating conditions, such as the machine-load or drive system, are changed after advanced autotuning, then change the following related parameters to disable any values that were adjusted before performing advanced autotuning once again with the setting to calculate the moment of inertia (Jcalc = ON). If advanced autotuning is performed without changing the parameters, machine vibration may occur, resulting in damage to the machine.
Pn00B.0=1 (Displays all parameters.)
Pn140.0=0 (Does not use model following control.)
Pn160.0=0 (Does not use anti-resonance control.)
Pn408=n.00□0 (Does not use friction compensation, 1st notch filter, or 2nd notch filter.)

5.3.1 Advanced Autotuning

Advanced autotuning automatically operates the servo system (in reciprocating movement in the forward and reverse directions) within set limits and adjust the SERVOPACK automatically according to the mechanical characteristics while the servo system is operating.

Advanced autotuning can be performed without connecting the host controller. The following automatic operation specifications apply.

- Maximum speed: Rated motor speed \times 2/3
- Acceleration torque: Approximately 100% of rated motor torque
The acceleration torque varies with the influence of the moment of inertia ratio (Pn103), machine friction, and external disturbance.
- Travel distance: The travel distance can be set freely. The distance is factory-set to a value equivalent to 3 motor rotations.

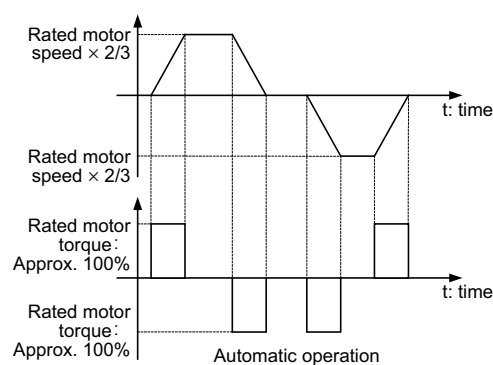
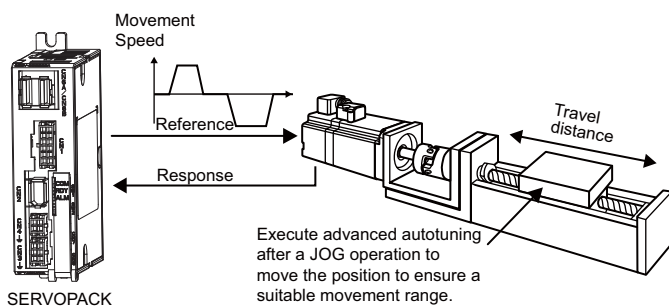

Advanced autotuning performs the following adjustments.

- Moment of inertia ratio
- Gains (e.g., position loop gain and speed loop gain)
- Filters (torque reference filter and notch filter)
- Friction compensation
- Anti-resonance control
- Vibration suppression (Mode = 2 or 3)

Refer to 5.3.3 *Related Parameters* for parameters used for adjustments.

CAUTION

- Because advanced autotuning adjusts the SERVOPACK during automatic operation, vibration or overshooting may occur. To ensure safety, perform advanced autotuning in a state where the SERVOPACK can come to an emergency stop at any time.

(1) Preparation

The following conditions must be met to perform advanced autotuning.

- The main circuit power supply must be ON.
- There must be no overtravel.
- The servomotor power must be OFF.
- The control method must not be set to torque control.
- The gain selection switch must be in manual switching mode (Pn139.0 = 0).
- Gain setting 1 must be selected.
- The test without a motor function must be disabled (Pn00C.0 = 0).
- All alarms and warning must be cleared.
- The write prohibited setting parameter (Fn010) must be set to Write permitted (P.0000).
- Jcalc must be set to ON to calculate the load moment of inertia when the tuning-less function is enabled (Pn170.0 = 1: factory setting) or the tuning-less function must be disabled (Pn170.0 = 0).

Note:

- If advanced autotuning is started while the SERVOPACK is in speed control, the mode will change to position control automatically to perform advanced autotuning. The mode will return to speed control after completing the adjustment. To perform advanced autotuning in speed control, set the mode to 1 (Mode = 1).

(2) When Advanced Autotuning Cannot Be Performed

Advanced autotuning cannot be performed normally under the following conditions. Refer to 5.4 *Advanced Autotuning by Reference (Fn202)* and 5.5 *One-parameter Tuning (Fn203)* for details.

- The machine system can work only in a single direction.
- The operating range is within 0.5 rotation.

(3) When Advanced Autotuning Cannot Be Performed Successfully

Advanced autotuning cannot be performed successfully under the following conditions. Refer to 5.4 *Advanced Autotuning by Reference (Fn202)* and 5.5 *One-parameter Tuning (Fn203)* for details.

- The operating range is not applicable.
- The moment of inertia changes within the set operating range.
- The machine has high friction.
- The rigidity of the machine is low and vibration occurs when positioning is performed.
- The position integration function is used.
- P control operation (proportional control) is used.

Note: If a setting is made for calculating the moment of inertia, an error will result when P control operation is selected using /V_PPI of OPTION field while the moment of inertia is being calculated.

- The mode switch is used.

Note: If a setting is made for calculating the moment of inertia, the mode switch function will be disabled while the moment of inertia is being calculated. At that time, PI control will be used. The mode switch function will be enabled after calculating the moment of inertia.

- Speed feedforward or torque feedforward is input.
- The positioning completed width (Pn522) is too small.



IMPORTANT

- Advanced autotuning makes adjustments by referring to the positioning completed width (Pn522). If the SERVOPACK is operated in position control (Pn000.1=1), set the electronic gear ratio (Pn20E/Pn210) and positioning completed width (Pn522) to the actual value during operation. If the SERVOPACK is operated in speed control (Pn000.1=0), set Mode to 1 to perform advanced autotuning.

Change only the overshoot detection level (Pn561) to finely adjust the amount of overshooting without changing the positioning completed width (Pn522). Because Pn561 is set by default to 100%, the allowable amount of overshooting is the same amount as that for the positioning completed width.

When Pn561 is set to 0%, the amount of overshooting can be adjusted to prevent overshooting the positioning completed width. If the setting of Pn561 is changed, however, the positioning time may be extended.

Pn561	Overshoot Detection Level				Classification	
	Setting Range	Setting Unit	Speed	Position		Torque
			Factory Setting	When Enabled		
	0 to 100	1%	100	Immediately		Setup

5.3.2 Advanced Autotuning Procedure

The following procedure is used for advanced autotuning.

The SigmaWin+ is required to execute this function.

CAUTION

- When using the SERVOPACK with Jcalc = OFF (load moment of inertia is not calculated), be sure to set a suitable value for the moment of inertia ratio (Pn103). If the setting greatly differs from the actual moment of inertia ratio, normal control of the SERVOPACK may not be possible, and vibration may result.
- When using the MP2000 Series with phase control, select the mode = 1 (standard level). If 2 or 3 is selected, phase control of the MP2000 Series may not be possible.

(1) Operating Procedure

Use the following procedure.

WARNING

Advanced autotuning involves motor operation, and it is therefore hazardous.

Refer to the SigmaWin+ Operation Manual before performing autotuning without reference input.

Be particularly careful of the following point.

- Ensure safety near all moving parts.
Vibration may occur during autotuning. Provide an emergency stop means to shut OFF the power supply during implementation. The motor will move in both directions within the movement range. Check the movement range and direction, and provide overtravel prevention means and other safety measures as required.

CAUTION

Two methods are available to stop advanced autotuning while the motor is running, and the motor will stop according to the method selected. Make sure to select the best method for the situation.

- If the SERVO OFF button is used, the motor will stop according to the stopping method after servo off specified by the parameters.
- If the CANCEL button is used, the motor will decelerate to a stop and then enter a zero clamp state.
Note: The CANCEL button may be invalid in some SERVOPACKs.

1. In the SigmaWin+ main window, click **Tuning – Tuning**.

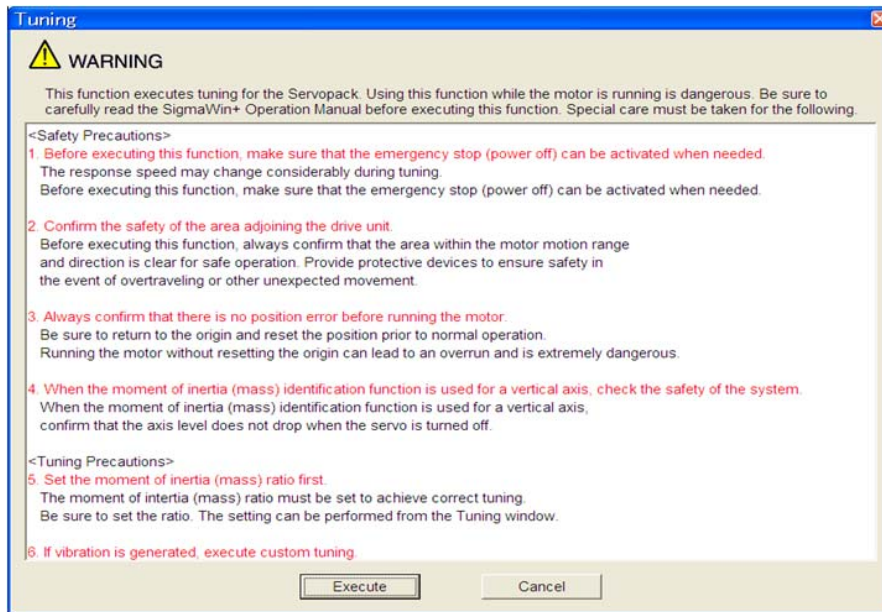

Click **Cancel** to return to the SigmaWin+ main window without executing tuning.

2. Click **Execute**.

The following window will appear.

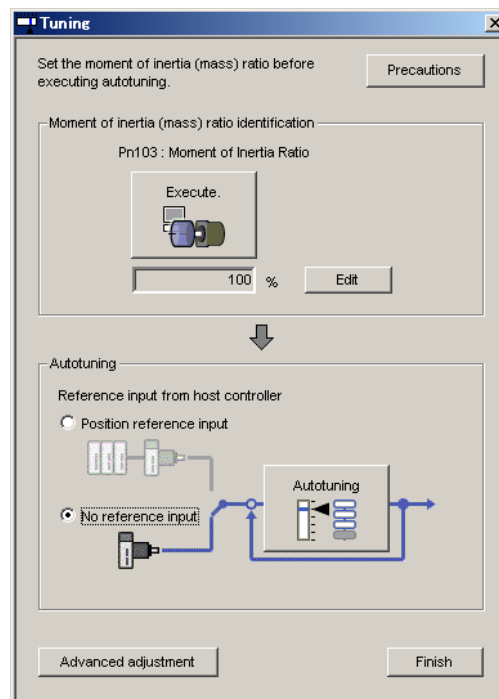

3. Click **Execute**.

The following window will appear.

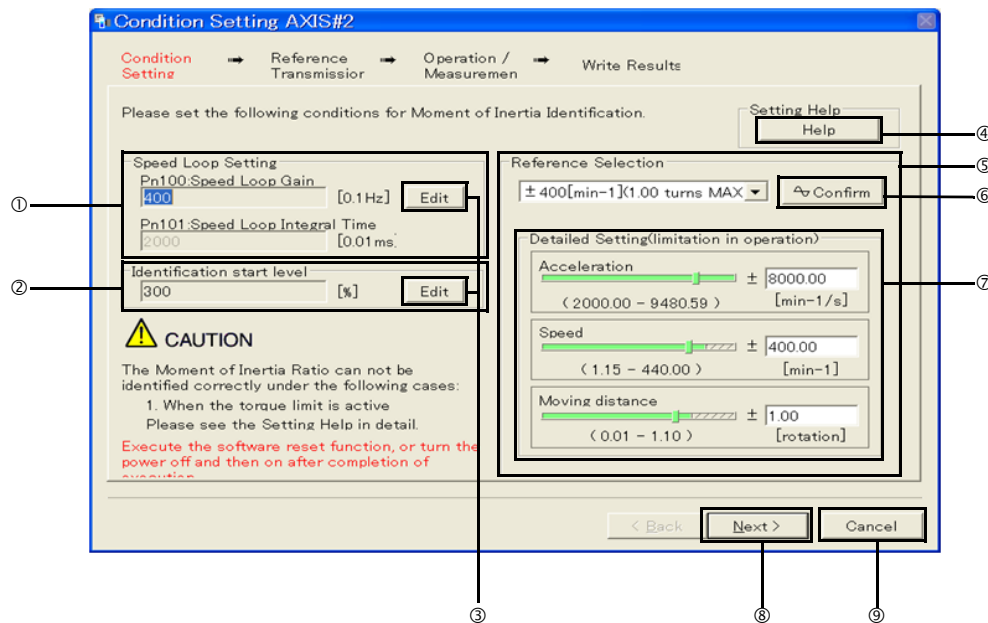

① Speed Loop Setting

Set the speed loop gain and integral time constant.

If the response of the speed loop is poor, the moment of inertia (mass) ratio cannot be measured accurately.

The speed loop setting to get the required response for the moment of inertia (mass) setting is already set to the default setting. Normally, this setting does not have to be changed.

If this speed loop gain is too high, and is causing excitation in the mechanism, lower the setting. However, do not set it to a value that is higher than the default setting.

② Identification Start Level

Set the moment of inertia (mass) identification start level.

With a heavy load or low-rigidity machine, torque limit may be applied and the moment of inertia identification may fail.

In this case, double the identification start level and execute identification again.

③ Edit

Click **Edit** to view the Speed Loop-Related Setting Change box or the Identification Start Level Setting Change box.

④ Help

Click **Help** to open the window for guidelines on the reference condition settings.

- Run the motor to measure the load's inertial moment (mass) of the machine to compare it with the rotor's inertial moment of the motor in the moment of inertia (mass) ratio.
- Set the driving mode, reference pattern (maximum acceleration, maximum speed, and maximum moving distance), and parameters related to the speed loop.
- Accurate measurement of the moment of inertia (mass) ratio depends on the settings. See the measurement results to determine the proper settings.

⑤ Reference Selection

Select a reference pattern from the Reference Selection box or create the reference pattern by directly entering the values.

As the setting for maximum acceleration increases, the accuracy of the inertia identification tends to improve.

Consider the pulley diameter or the speed reduction ratio such as the ball screw pitches, and set the maximum acceleration within the operable range.

⑥ Confirm

Click **Confirm** to view the driving pattern.

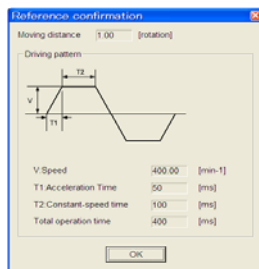

⑦ Detailed Setting

Create the reference pattern for setting the moment of inertia (mass) by changing the values with the slider or by directly entering the values.

⑧ Next

Click **Next** to view the Reference Transmission box.

⑨ Cancel

Click **Cancel** to return to the main window without changing the conditions.

⚠ CAUTION

- The amount of movement is the value for each operation (a forward run or a reverse run). After several operations, the operation starting position may have moved in either direction. Confirm the operable range before each measurement and operation.
- Certain settings for the parameters or inertia size of the mechanism may result in overshooting or undershooting, and cause the speed to temporarily exceed the maximum speed. Allow a margin when making the settings.

<If the moment of inertia (mass) ratio cannot be measured accurately>

If the torque (force) is limited, the moment of inertia (mass) ratio identification cannot be made correctly. Adjust the setting of the limit or decrease the acceleration in Reference Selection so that the torque (force) will not be limited.

4. Click **Next**.

The following window will appear.

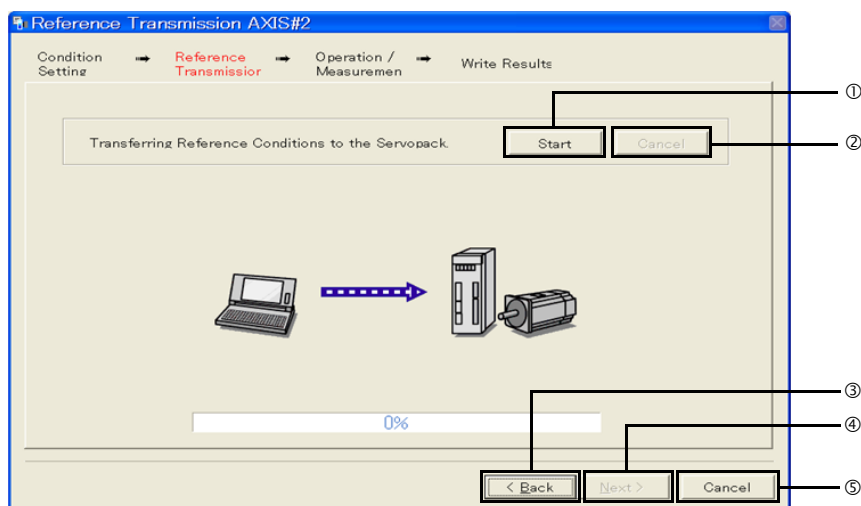

① Start

Click to **Start** to transfer the reference conditions to the SERVOPACK. A progress bar displays the progress status of the transfer.

② Cancel

The **Cancel** button is available only during the transfer to the SERVOPACK. After the transmission is finished, it is unavailable and cannot be selected.

③ Back

Click **Back** to return to the Condition Setting box. The **Back** button is unavailable during a data transfer.

④Next

The **Next** button is available if the data is transferred successfully. If an error occurs or if the transmission is interrupted, it is unavailable and cannot be selected.

Click **Next** to view the Operation/Measurement box.

⑤Cancel

Click **Cancel** to stop processing and return to the main window.

5. Click **Start** to transfer the reference conditions to the SERVOPACK.

6. Click **Next**.

The following window will appear.

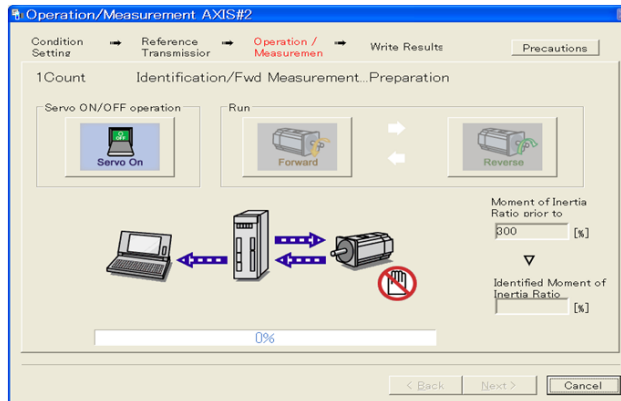

7. Click **Servo On**.

8. Click **Forward** to take measurements by turning (moving) the motor forward.

After the measurements and the data transmission are finished, the following window will appear.

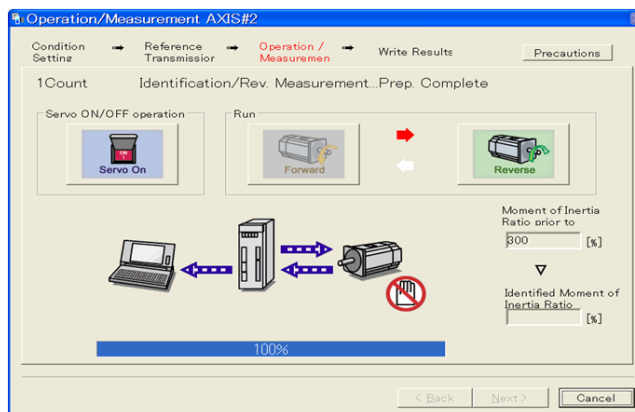

9. Click **Reverse** to take measurements by turning (moving) the motor in reverse.

After the measurements and the data transmission are finished, the following window will appear.

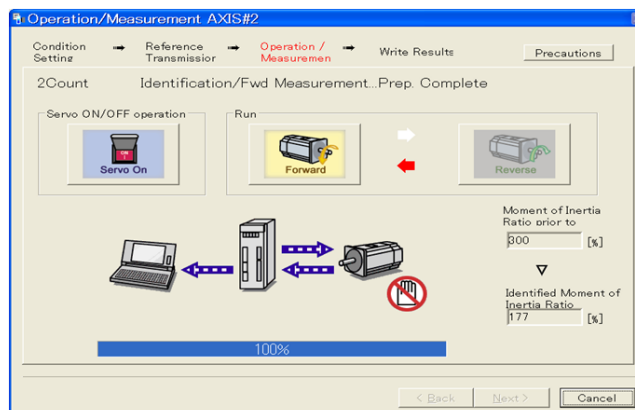

10. Repeat steps 7 through 9 until all the measurements have been taken.

Measurements will be made from two to seven times and then verification will be performed. The actual number of times the measurements have been taken is displayed in the upper left part on the screen. The progress bar displays the percentage of data that has been transferred.

11. After the measurement has been successfully completed, click **Servo ON** to turn to the servo OFF status.**12.** Click **Next**.

The following window will appear.

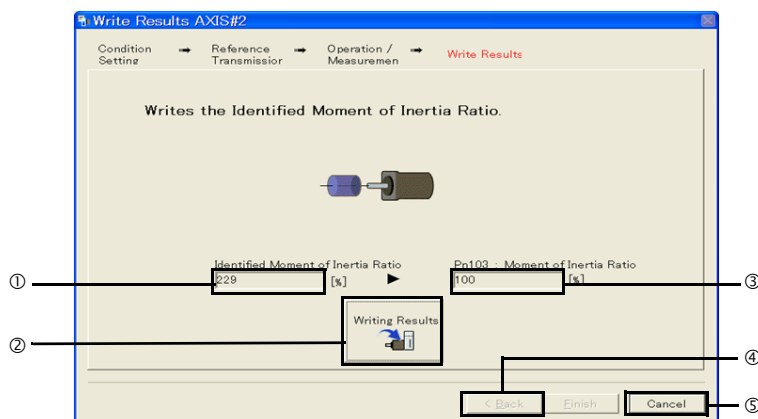

① Identified Moment of Inertia (Mass) Ratio

Displays the moment of inertia (mass) ratio calculated in the operation/measurement.

② Writing Results

Click **Writing Results** to assign the value displayed in the identified moment of inertia (mass) ratio to SERVOPACK parameter Pn103.

③ Pn103: Moment of Inertia (Mass) Ratio

Displays the value assigned to the parameter.

Click **Writing Results**, and the new ratio calculated from the operation/measurement will be displayed.

④ Back

The **Back** button is unavailable.

⑤ Cancel

Click **Cancel** to return to the main window.

<Supplement>

When **Next** is clicked without turning to the servo OFF status, the following message appears. Click **OK** to turn to the servo OFF status.

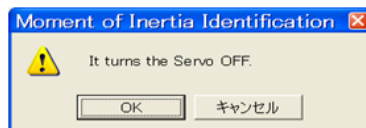
**13.** Click **Writing Results** to set the moment of inertia (mass) ratio calculated in the operation/measurement to the parameters.

14. After confirming that the value displayed in the identified moment of inertia (mass) ratio and the value displayed in the Pn103: Moment of Inertia Ratio are the same, click **Finish**.

The following window will appear.



15. Click **OK**.

The following window will appear.

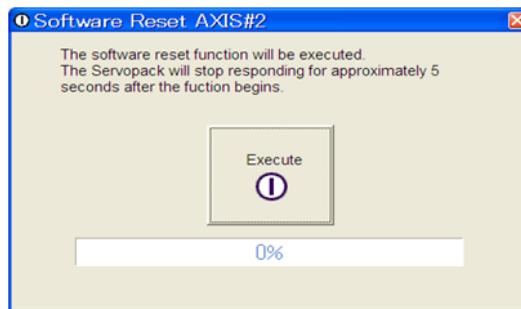

16. Click **Execute** to save the change of Pn103 (Moment of Inertia (Mass) Ratio) to SERVOPACK.

After the saving is finished, the tuning main window will appear.

17. Select the **No reference input** option under **Reference input from host controller** in the Tuning main window, and then click **Autotuning**.

The following window will appear.

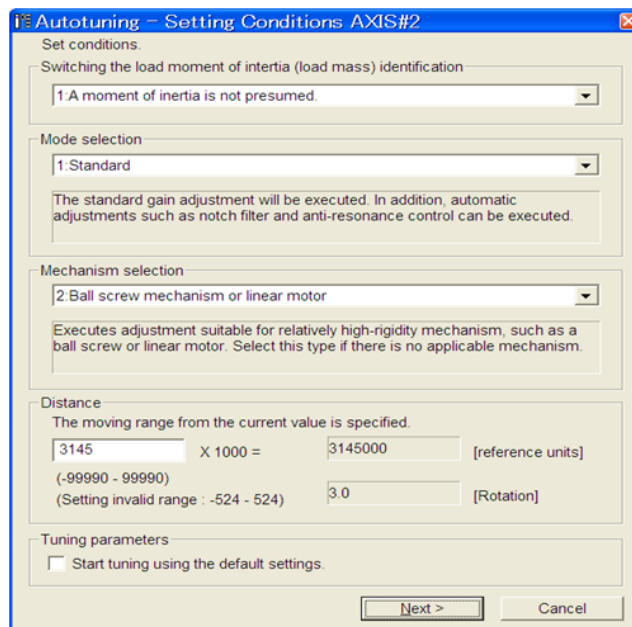

18. Select whether or not to use the load moment of inertia (load mass) identification from the **Switching the load moment of inertia (load mass) identification** box, the mode from the **Mode selection** box, the mechanism from the **Mechanism selection** box, and enter the moving distance. Then, click **Next**.

When the **Start tuning using the default settings**. check box is selected in the Autotuning-Setting Conditions box, tuning will be executed using the tuning parameters set to the default values.

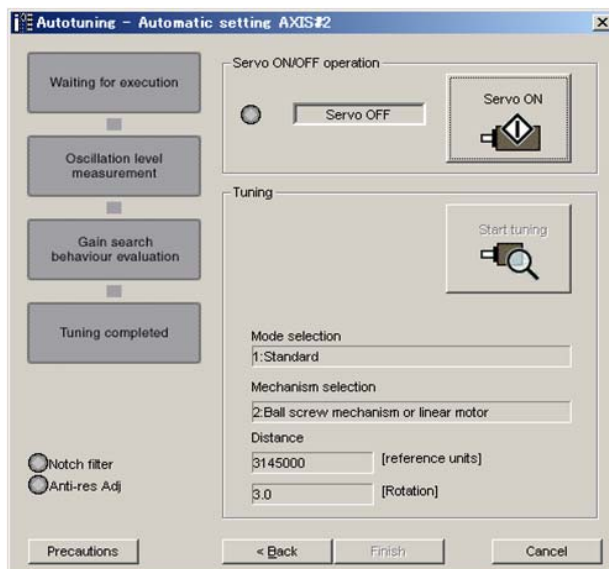

19. Click **Servo ON**.

The following window will appear.

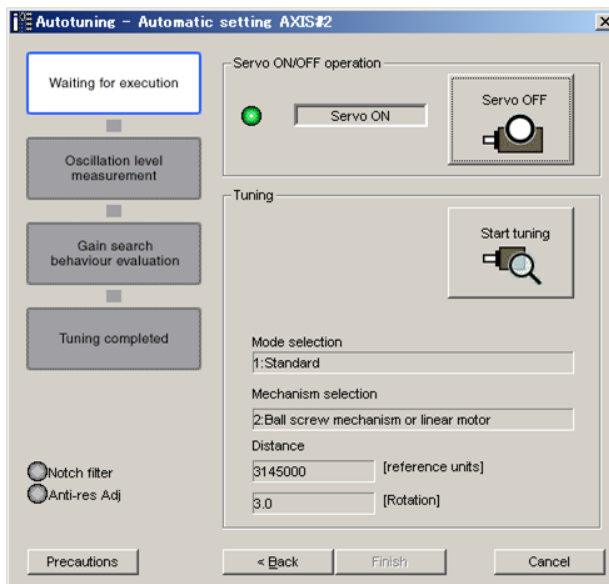

20. Click **Start tuning**.

The following box will appear.

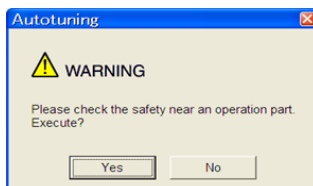

- 21.** After confirming the safety of the area adjoining the drive unit, click **Yes**.
The motor will start rotating and tuning will start.

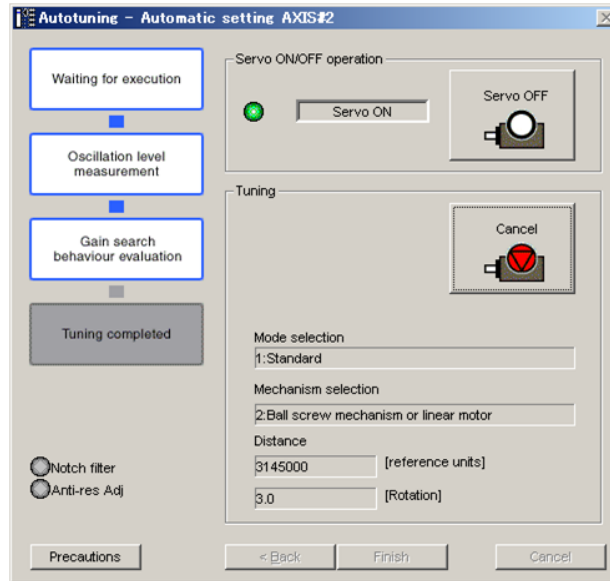

Vibration generated during tuning is automatically detected, and the optimum setting for the detected vibration will be made. When the setting is complete, the LED indicator lamps (bottom left of the box) of the functions used for the setting will light up.

- 22.** When tuning is completed, click **Finish** to return to the main window.
The results of tuning will be written in the parameters.

(2) Failure in Operation

■ When Operation Cannot be Performed

Probable Cause	Corrective Actions
The main circuit power supply was OFF.	Turn ON the main circuit power supply.
An alarm or warning occurred.	Remove the cause of the alarm or the warning.
Overtraveling occurred.	Remove the cause of the overtravel.
Gain setting 2 was selected by gain switching.	Disable the automatic gain switching.

■ When an Error Occurs

Error	Probable Cause	Corrective Actions
The gain adjustment was not successfully completed.	Machine vibration is occurring or the positioning completed signal (/COIN) is turning ON and OFF when the servomotor is stopped.	<ul style="list-style-type: none"> • Increase the set value for Pn522. • Change the mode from 2 to 3. • If machine vibration occurs, suppress the vibration with the anti-resonance control adjustment function and the vibration suppression function.
An error occurred during the calculation of the moment of inertia.	Refer to the following table ■ <i>When an Error Occurs during Calculation of Moment of Inertia</i> .	
Travel distance setting error	The travel distance is set to approximately 0.5 rotation or less, which is less than the minimum adjustable travel distance.	Increase the travel distance. It is recommended to set the number of motor rotations to around 3.
The positioning completed signal (/COIN) did not turn ON within approximately 10 seconds after positioning adjustment was completed.	The positioning completed width is too narrow or proportional control (P control) is being used.	<ul style="list-style-type: none"> • Increase the set value for Pn522. • Set 0 to V_PPI in the OPTION field.
The moment of inertia cannot be calculated when the tuning-less function was activated.	When the tuning-less function was activated, Jcalc was set to OFF so the moment of inertia was not calculated.	<ul style="list-style-type: none"> • Turn OFF the tuning-less function. • Set Jcalc to ON, so the moment of inertia will be calculated.

■ When an Error Occurs during Calculation of Moment of Inertia

The following table shows the probable causes of errors that may occur during the calculation of the moment of inertia with the Jcalc set to ON, along with corrective actions for the errors.

Probable Cause	Corrective Actions
The SERVOPACK started calculating the moment of inertia, but the calculation was not completed.	<ul style="list-style-type: none"> • Increase the speed loop gain (Pn100). • Increase the STROKE (travel distance).
The moment of inertia fluctuated greatly and did not converge within 10 tries.	Set the calculation value based on the machine specifications in Pn103 and execute the calculation with the Jcalc set to OFF.
Low-frequency vibration was detected.	Double the set value of the moment of inertia calculating start level (Pn324).
The torque limit was reached.	<ul style="list-style-type: none"> • When using the torque limit, increase the torque limit. • Double the set value of the moment of inertia calculating start level (Pn324).
While calculating the moment of inertia, the speed control was set to proportional control by setting 1 to V_PPI in the OPTION field.	Operate the SERVOPACK with PI control while calculating the moment of inertia.

(3) Related Functions on Advanced Autotuning

This section describes functions related to advanced tuning.

■ Notch Filter

Usually, set this function to Auto Setting. (The notch filter is factory-set to Auto Setting.)

If this function is set to Auto Setting, vibration will be detected automatically during advanced autotuning and the notch filter will be set.

Set this function to Not Auto Setting only if you do not change the notch filter setting before executing advanced autotuning.

Parameter		Function	When Enabled	Classification
Pn460	n.□□□0	Does not set the 1st notch filter automatically with the utility function.	Immediately	Tuning
	n.□□□1 [Factory setting]	Sets the 1st notch filter automatically with the utility function.		
	n.□0□□	Does not set the 2nd notch filter automatically with the utility function.		
	n.□1□□ [Factory setting]	Sets the 2nd notch filter automatically with the utility function.		

■ Anti-Resonance Control Adjustment

This function reduces low vibration frequency, which the notch filter does not detect.

Usually, set this function to Auto Setting. (The anti-resonance control is factory-set to Auto Setting.)

When this function is set to Auto Setting, vibration will be automatically detected during advanced autotuning and anti-resonance control will be automatically adjusted and set.

Parameter		Function	When Enabled	Classification
Pn160	n.□□0□	Does not use the anti-resonance control automatically with the utility function.	Immediately	Tuning
	n.□□1□ [Factory setting]	Uses the anti-resonance control automatically with the utility function.		

■ Vibration Suppression

The vibration suppression function suppresses transitional vibration at frequency as low as 1 to 100 Hz that is generated mainly when positioning if the machine stand vibrates.

Usually, set this function to Auto Setting. (The vibration suppression function is factory-set to Auto Setting.)

When this function is set to Auto Setting, vibration will be automatically detected during advanced autotuning and vibration suppression will be automatically adjusted and set.

Set this function to Not Auto Setting only if you do not change the setting for vibration suppression before executing advanced autotuning.

Note: This function uses model following control. Therefore, the function can be executed only if the mode is set to 2 or 3.

• Related Parameter

Parameter		Function	When Enabled	Classification
Pn140	n.□0□□	Does not use the vibration suppression function automatically with the utility function.	Immediately	Tuning
	n.□1□□ [Factory setting]	Uses the vibration suppression function automatically with the utility function.		

■ Friction Compensation

This function compensates for changes in the following conditions.

- Changes in the viscous resistance of the lubricant, such as the grease, on the sliding parts of the machine
- Changes in the friction resistance resulting from variations in the machine assembly
- Changes in the friction resistance due to aging

The conditions for applying friction compensation depend on the mode. The friction compensation setting in Pn408.3 applies when the Mode is 1. The friction compensation function is always enabled regardless of the friction compensation setting in Pn408.3 when the Mode is 2 or 3.

Friction Compensation Selecting		Mode = 1	Mode = 2	Mode = 3
Pn408	n.0□□□ [Factory setting]	Adjusted without the friction compensation function	Adjusted with the friction compensation function	Adjusted with the friction compensation function
	n.1□□□	Adjusted with the friction compensation function		

■ Feedforward

If Pn140 is set to the factory setting and the mode setting is changed to 2 or 3, the feedforward gain (Pn109), speed feedforward (VFF) input, and torque feedforward (TFF) input will be disabled.

Set Pn140.3 to 1 if model following control is used together with the speed feedforward (VFF) input and torque feedforward (TFF) input from the host controller.

Parameter		Function	When Enabled	Classification
Pn140	n.0□□□ [Factory setting]	Model following control is not used together with the speed/torque feedforward input.	Immediately	Tuning
	n.1□□□	Model following control is used together with the speed/torque feedforward input.		

Refer to *Σ-V Series User's Manual MECHATROLINK-II Commands* (Manual No.: SIEP S800000 54) for details.

 IMPORTANT	<ul style="list-style-type: none"> • Model following control is used to make optimum feedforward settings in the SERVO-PACK when model following control is used with the feedforward function. Therefore, model following control is not normally used together with either the speed feedforward (VFF) input or torque feedforward (TFF) input from the host controller. However, model following control can be used with the speed feedforward (VFF) input or torque feedforward (TFF) input if required. An improper feedforward input may result in overshooting.
---------------------------------------------------------------------------------------------------------	----------------------------------------------------------------------------------------------------------------------------------------------------------------------------------------------------------------------------------------------------------------------------------------------------------------------------------------------------------------------------------------------------------------------------------------------------------------------------------------------------------------------------------------------------------------------------------------

5.3.3 Related Parameters

The following table lists parameters related to this function and their possibility of being changed while executing this function or of being changed automatically after executing this function.

- Parameters related to this function

These are parameters that are used or referenced when executing this function.

- Allowed changes during execution of this function

Yes : Parameters can be changed using SigmaWin+ while this function is being executed.

No : Parameters cannot be changed using SigmaWin+ while this function is being executed.

- Automatic changes after execution of this function

Yes : Parameter set values are automatically set or adjusted after execution of this function.

No : Parameter set values are not automatically set or adjusted after execution of this function.

Parameter	Name	Mid-execution changes	Automatic changes
Pn100	Speed Loop Gain	No	Yes
Pn101	Speed Loop Integral Time Constant	No	Yes
Pn102	Position Loop Gain	No	Yes
Pn103	Moment of Inertia Ratio	No	No
Pn121	Friction Compensation Gain	No	Yes
Pn123	Friction Compensation Coefficient	No	Yes
Pn124	Friction Compensation Frequency Correction	No	No
Pn125	Friction Compensation Gain Correction	No	Yes
Pn401	Torque Reference Filter Time Constant	No	Yes
Pn408	Torque Related Function Switch	Yes	Yes
Pn409	1st Notch Filter Frequency	No	Yes
Pn40A	1st Notch Filter Q Value	No	Yes
Pn40C	2nd Notch Filter Frequency	No	Yes
Pn40D	2nd Notch Filter Q Value	No	Yes
Pn140	Model Following Control Related Switch	Yes	Yes
Pn141	Model Following Control Gain	No	Yes
Pn142	Model Following Control Gain Compensation	No	Yes
Pn143	Model Following Control Bias (Forward Direction)	No	Yes
Pn144	Model Following Control Bias (Reverse Direction)	No	Yes
Pn145	Vibration Suppression 1 Frequency A	No	Yes
Pn146	Vibration Suppression 1 Frequency B	No	Yes
Pn147	Model Following Control Speed Feedforward Compensation	No	Yes
Pn160	Anti-Resonance Control Related Switch	Yes	Yes
Pn161	Anti-Resonance Frequency	No	Yes
Pn163	Anti-Resonance Damping Gain	No	Yes
Pn531	Program JOG Movement Distance	No	No
Pn533	Program JOG Movement Speed	No	No
Pn534	Program JOG Acceleration/Deceleration Time	No	No
Pn535	Program JOG Waiting Time	No	No
Pn536	Number of Times of Program JOG Movement	No	No

5.4 Advanced Autotuning by Reference (Fn202)

Adjustments with advanced autotuning by reference are described below.

 IMPORTANT	<ul style="list-style-type: none"> Advanced autotuning by reference starts adjustments based on the set speed loop gain (Pn100). Therefore, precise adjustments cannot be made if there is vibration when starting adjustments. In this case, make adjustments after lowering the speed loop gain (Pn100) until vibration is eliminated.
-------------------------------------------------------------------------------------------------------	---------------------------------------------------------------------------------------------------------------------------------------------------------------------------------------------------------------------------------------------------------------------------------------------------------------------------------------------------------

5.4.1 Advanced Autotuning by Reference

Advanced autotuning by reference is used to automatically achieve optimum tuning of the SERVOPACK in response to the user reference inputs from the host controller.

Advanced autotuning by reference is performed generally to fine-tune the SERVOPACK after advanced autotuning of the SERVOPACK has been performed.

If the moment of inertia ratio is correctly set to Pn103, advanced autotuning by reference can be performed without performing advanced autotuning.

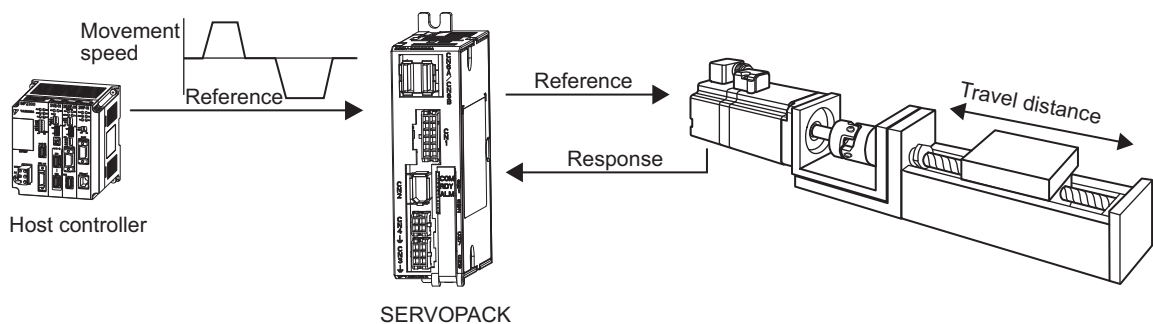

Advanced autotuning by reference performs the following adjustments.

- Gains (e.g., position loop gain and speed loop gain)
- Filters (torque reference filter and notch filter)
- Friction compensation
- Anti-resonance control
- Vibration suppression

Refer to 5.4.3 *Related Parameters* for parameters used for adjustments.

CAUTION

- Because advanced autotuning by reference adjusts the SERVOPACK during automatic operation, vibration or overshooting may occur. To ensure safety, perform advanced autotuning by reference in a state where the SERVOPACK can come to an emergency stop at any time.

(1) Preparation

The following conditions must be met to perform advanced autotuning by reference.

- The SERVOPACK must be in Servo Ready status (Refer to 4.8.4).
- There must be no overtravel.
- The servomotor power must be OFF.
- The position control must be selected when the servomotor power is ON.
- The gain selection switch must be in manual switching mode (Pn139.0 = 0).
- Gain setting 1 must be selected.
- The test without a motor function must be disabled. (Pn00C.0 = 0).
- All warnings must be cleared.
- The write prohibited setting parameter (Fn010) must be set to Write permitted (P.0000).
- The tuning-less function must be disabled (Pn170.0 = 0).

(2) When Advanced Autotuning by Reference Cannot Be Performed Successfully

Advanced autotuning by reference cannot be performed successfully under the following conditions. If the result of autotuning is not satisfactory, perform one-parameter tuning (Fn203). Refer to 5.5 *One-parameter Tuning (Fn203)* for details.

- The travel distance in response to references from the host controller is smaller than the set positioning completed width (Pn522).
- The motor speed in response to references from the host controller is smaller than the set rotation detection level (Pn502).
- The stopping time, i.e., the period while the positioning completed /COIN signal is OFF, is 10 ms or less.
- The rigidity of the machine is low and vibration occurs when positioning is performed.
- The position integration function is used.
- P control operation (proportional control) is performed.
- The mode switch is used.
- The positioning completed width (Pn522) is too small.



IMPORTANT

- Advanced autotuning by reference starts adjustments based on the positioning completed width (Pn522). Set the electronic gear ratio (Pn20E/Pn210) and positioning completed width (Pn522) to the actual value during operation.
- Unless the positioning completed signal (/COIN) is turned ON within approximately 3 seconds after positioning has been completed, "WAITING" will flash. Furthermore, unless the positioning completed signal (/COIN) is turned ON within approximately 10 seconds, "Error" will flash for 2 seconds and tuning will be aborted.

Change only the overshoot detection level (Pn561) to finely adjust the amount of overshooting without changing the positioning completed width (Pn522). Because Pn561 is set by default to 100%, the allowable amount of overshooting is the same amount as that for the positioning completed width.

When Pn561 is set to 0%, the amount of overshooting can be adjusted without any overshooting in the positioning completed width. If the setting of Pn561 is changed, however, the positioning time may be extended.

Pn561	Overshoot Detection Level				Classification	
	Setting Range	Setting Unit	Speed	Position		Torque
			Factory Setting	When Enabled		
0 to 100	1%	100	Immediately		Setup	

5.4.2 Advanced Autotuning by Reference Procedure

The following procedure is used for advanced autotuning by reference.

The SigmaWin+ is required to execute this function.

⚠ CAUTION

- When using the MP2000 Series with phase control, select the mode = 1 (standard level). If 2 or 3 is selected, phase control of the MP2000 Series may not be possible.

(1) Operating Procedure

Use the following procedure.

1. Confirm that the correct moment of inertia ratio in Pn103 is set by using the advanced autotuning.
2. In the SigmaWin+ main window, click **Tuning - Tuning**.

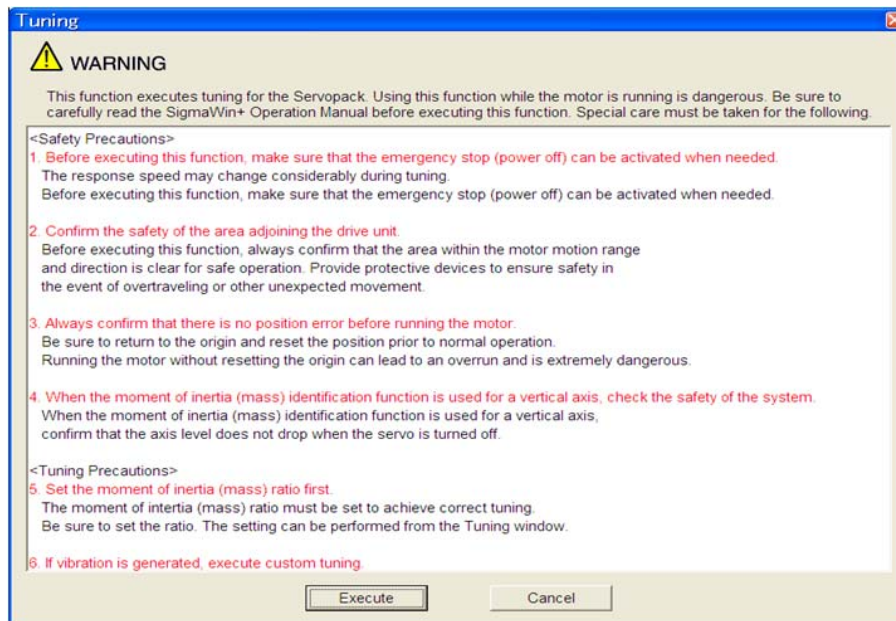

Click **Cancel** to return to the SigmaWin+ main window without executing tuning.

3. Click **Execute**.

The following window will appear.

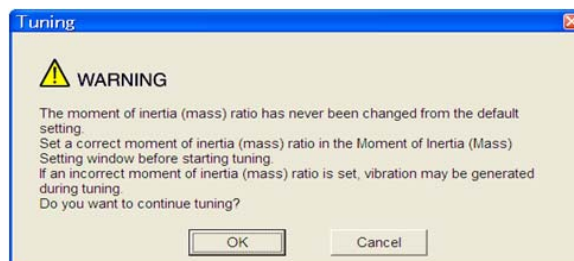

4. Click **OK**.

The following window will appear.

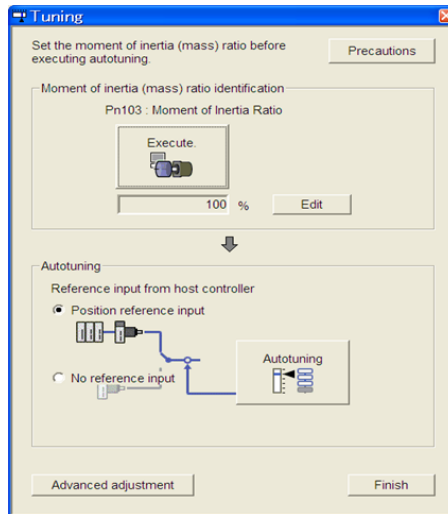

5. Select the **Position reference input** option under **Reference input from host controller** in the Tuning main window, and then click **Autotuning**.

The following window will appear.

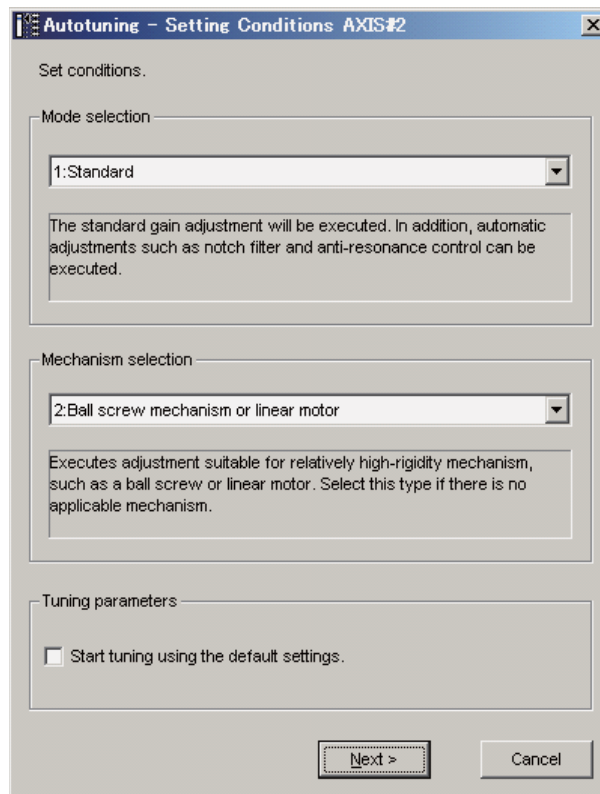

6. Select the mode from the **Mode selection** combo box and the mechanism from **Mechanism selection** combo box, and then click **Next**.

When the **Start tuning using the default settings**. check box is selected in the Autotuning-Setting Conditions box, tuning will be executed using tuning parameters set to the default value.

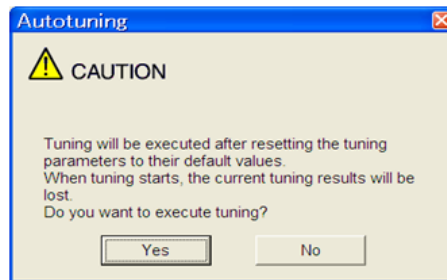

7. Click **Yes**.

The following box will appear.

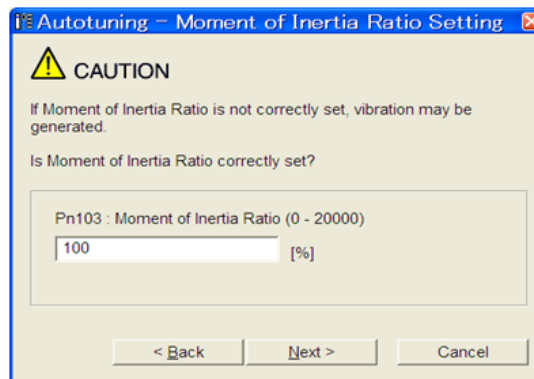

8. Enter the correct moment of inertia ratio and then click **Next**.

The following window will appear.

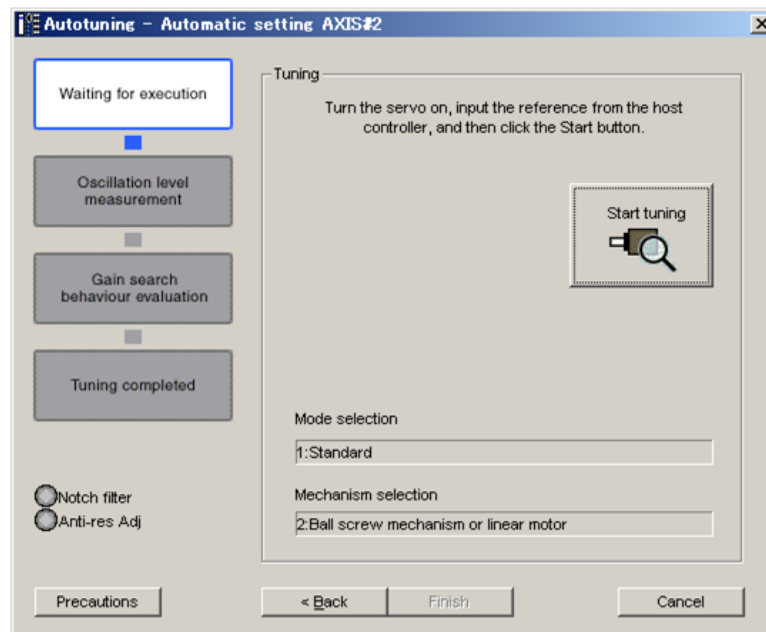

9. Turn the servo on and then input the reference from the host controller. Click **Start tuning**.

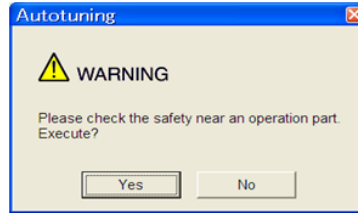

10. After confirming the safety of the area adjoining the drive unit, click **Yes**. The motor will start rotating and tuning will start.

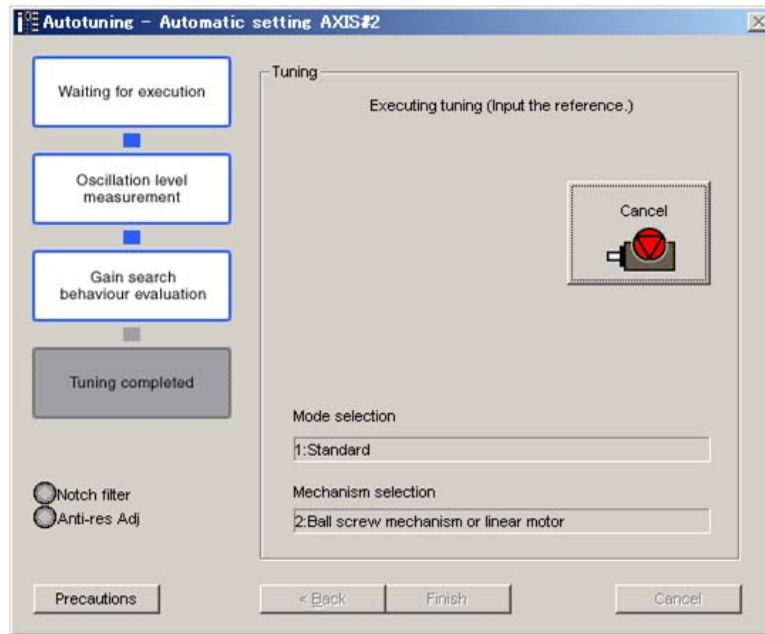

Vibration generated during tuning is automatically detected, and the optimum setting for the detected vibration will be made. When the setting is complete, the LED indicator lamps (bottom left of the box) of the functions used for the setting will light up.

11. When tuning is completed, click **Finish** to return to the main window. The results of tuning will be written in the parameters.

(2) Failure in Operation

■ When Operation Cannot be Performed

Probable Cause	Corrective Actions
The main circuit power supply was OFF.	Turn ON the main circuit power supply.
An alarm or warning occurred.	Remove the cause of the alarm or the warning.
Overtraveling occurred.	Remove the cause of the overtravel.
Gain setting 2 was selected by gain switching.	Disable the automatic gain switching.

■ When an Error Occurs

Error	Probable Cause	Corrective Actions
The gain adjustment was not successfully completed.	Machine vibration is occurring or the positioning completed signal (/COIN) is turning ON and OFF when the servomotor is stopped.	<ul style="list-style-type: none"> • Increase the set value for Pn522. • Change the mode from 2 to 3. • If machine vibration occurs, suppress the vibration with the anti-resonance control adjustment function and the vibration suppression function.
The positioning completed signal (/COIN) did not turn ON within approximately 10 seconds after positioning adjustment was completed.	The positioning completed width is too narrow or proportional control (P control) is being used.	<ul style="list-style-type: none"> • Increase the set value for Pn522. • Set 0 to V_PPI in the OPTION field.

(3) Related Functions on Advanced Autotuning by Reference

This section describes functions related to advanced autotuning by reference.

■ Notch Filter

Usually, set this function to Auto Setting. (The notch filter is factory-set to Auto Setting.)

If this function is set to Auto Setting, vibration will be detected automatically during advanced autotuning by reference, and the notch filter will be set.

Set this function to Not Auto Setting only if you do not change the notch filter setting before executing advanced autotuning by reference.

Parameter	Function	When Enabled	Classification	
Pn460	n.□□□0	Does not set the 1st notch filter automatically with the utility function.	Immediately	Tuning
	n.□□□1 [Factory setting]	Sets the 1st notch filter automatically with the utility function.		
	n.□0□□	Does not set the 2nd notch filter automatically with the utility function.		
	n.□1□□ [Factory setting]	Sets the 2nd notch filter automatically with the utility function.		

■ Anti-Resonance Control Adjustment

This function reduces low vibration frequency, which the notch filter does not detect.

Usually, set this function to Auto Setting. (The anti-resonance control is factory-set to Auto Setting.)

When this function is set to Auto Setting, vibration will be automatically detected during advanced autotuning by reference and anti-resonance control will be automatically adjusted and set.

Parameter	Function	When Enabled	Classification	
Pn160	n.□□0□	Does not use the anti-resonance control automatically with the utility function.	Immediately	Tuning
	n.□□1□ [Factory setting]	Uses the anti-resonance control automatically with the utility function.		

■ **Vibration Suppression**

The vibration suppression function suppresses transitional vibration at frequency as low as 1 to 100 Hz that is generated mainly when positioning if the machine stand vibrates.

Usually, set this function to Auto Setting. (The vibration suppression function is factory-set to Auto Setting.)

When this function is set to Auto Setting, vibration will be automatically detected during advanced autotuning by reference and vibration suppression will be automatically adjusted and set.

Set this function to Not Auto Setting only if you do not change the setting for vibration suppression before executing advanced autotuning by reference.

Note: This function uses model following control. Therefore, the function can be executed only if the mode is set to 2 or 3.

• **Related Parameters**

Parameter	Function	When Enabled	Classification
Pn140	n.0000	Immediately	Tuning
	n.1000 [Factory setting]		

■ **Friction Compensation**

This function compensates for changes in the following conditions.

- Changes in the viscous resistance of the lubricant, such as the grease, on the sliding parts of the machine
- Changes in the friction resistance resulting from variations in the machine assembly
- Changes in the friction resistance due to aging

Conditions to which friction compensation is applicable depend on the mode. The friction compensation setting in Pn408.3 applies when the mode is 1. Mode = 2 and Mode = 3 are adjusted with the friction compensation function regardless of the friction compensation setting in P408.3.

Friction Compensation Selecting		Mode = 1	Mode = 2	Mode = 3
Pn408	n.0000 [Factory setting]	Adjusted without the friction compensation function	Adjusted with the friction compensation function	Adjusted with the friction compensation function
	n.1000	Adjusted with the friction compensation function		

■ **Feedforward**

If Pn140 is set to the factory setting and the mode setting is changed to 2 or 3, the feedforward gain (Pn109), speed feedforward (VFF) input, and torque feedforward (TFF) input will be disabled.

Set Pn140.3 to 1 if model following control is used together with the speed feedforward (VFF) input and torque feedforward (TFF) input from the host controller.

Parameter	Function	When Enabled	Classification
Pn140	n.0000 [Factory setting]	Immediately	Tuning
	n.1000		

Refer to *Σ-V Series User's Manual MECHATROLINK-II Commands* (Manual No.: SIEP S800000 54) for details.

IMPORTANT

- Model following control is used to make optimum feedforward settings in the SERVO-PACK when model following control is used with the feedforward function. Therefore, model following control is not normally used together with either the speed feedforward (VFF) input or torque feedforward (TFF) input from the host controller. However, model following control can be used with the speed feedforward (VFF) input or torque feedforward (TFF) input if required. An improper feedforward input may result in overshooting.

5.4.3 Related Parameters

The following table lists parameters related to this function and their possibility of being changed while executing this function or of being changed automatically after executing this function.

- Parameters related to this function

These are parameters that are used or referenced when executing this function.

- Allowed changes during execution of this function

Yes : Parameters can be changed using SigmaWin+ while this function is being executed.

No : Parameters cannot be changed using SigmaWin+ while this function is being executed.

- Automatic changes after execution of this function

Yes : Parameter set values are automatically set or adjusted after execution of this function.

No : Parameter set values are not automatically set or adjusted after execution of this function.

Parameter	Name	Mid-execution changes	Automatic changes
Pn100	Speed Loop Gain	No	Yes
Pn101	Speed Loop Integral Time Constant	No	Yes
Pn102	Position Loop Gain	No	Yes
Pn103	Moment of Inertia Ratio	No	No
Pn121	Friction Compensation Gain	No	Yes
Pn123	Friction Compensation Coefficient	No	Yes
Pn124	Friction Compensation Frequency Correction	No	No
Pn125	Friction Compensation Gain Correction	No	Yes
Pn401	Torque Reference Filter Time Constant	No	Yes
Pn408	Torque Related Function Switch	Yes	Yes
Pn409	1st Notch Filter Frequency	No	Yes
Pn40A	1st Notch Filter Q Value	No	Yes
Pn40C	2nd Notch Filter Frequency	No	Yes
Pn40D	2nd Notch Filter Q Value	No	Yes
Pn140	Model Following Control Related Switch	Yes	Yes
Pn141	Model Following Control Gain	No	Yes
Pn142	Model Following Control Gain Compensation	No	Yes
Pn143	Model Following Control Bias (Forward Direction)	No	Yes
Pn144	Model Following Control Bias (Reverse Direction)	No	Yes
Pn145	Vibration Suppression 1 Frequency A	No	Yes
Pn146	Vibration Suppression 1 Frequency B	No	Yes
Pn147	Model Following Control Speed Feedforward Compensation	No	Yes
Pn160	Anti-Resonance Control Related Switch	Yes	Yes
Pn161	Anti-Resonance Frequency	No	Yes
Pn163	Anti-Resonance Damping Gain	No	Yes

5.5 One-parameter Tuning (Fn203)

Adjustments with one-parameter tuning are described below.

5.5.1 One-parameter Tuning

One-parameter tuning is used to manually make tuning level adjustments during operation with a position reference or speed reference input from the host controller.

One-parameter tuning enables automatically setting related servo gain settings to balanced conditions by adjusting one or two tuning levels.

One-parameter tuning performs the following adjustments.

- Gains (e.g., position loop gain and speed loop gain)
- Filters (torque reference filter and notch filter)
- Friction compensation
- Anti-resonance control

Refer to 5.5.4 *Related Parameters* for parameters used for adjustments.

Perform one-parameter tuning if satisfactory response characteristics is not obtained with advanced autotuning or advanced autotuning by reference.

To fine-tune each servo gain after one-parameter tuning, refer to 5.8 *Additional Adjustment Function*.

CAUTION

- Vibration or overshooting may occur during adjustment. To ensure safety, perform one-parameter tuning in a state where the SERVOPACK can come to an emergency stop at any time.

■ Preparation

The following conditions must be met to perform one-parameter tuning.

- The test without a motor function must be disabled (Pn00C.0 = 0).
- The write prohibited setting parameter (Fn010) must be set to Write permitted (P.0000).
- The tuning-less function must be disabled (Pn170.0 = 0).
- The tuning mode must be set to 0 or 1 when performing speed control.

5.5.2 One-parameter Tuning Procedure

The following procedure is used for one-parameter tuning.

There are the following two operation procedures depending on the tuning mode being used.

- When the tuning mode is set to 0 or 1, the model following control will be disabled and one-parameter tuning will be used as the tuning method for applications other than positioning.
- When the tuning mode is set to 2 or 3, the model following control will be enabled and it can be used for tuning for positioning.

The operating procedure that is provided here is for when the Tuning Mode is set to 0 to give priority to setting a servo gain for stability.

The SigmaWin+ is required to execute this function.

CAUTION

- When using the MP2000 Series with phase control, select the tuning mode = 0 or 1. If 2 or 3 is selected, phase control of the MP2000 Series may not be possible.

(1) Operating Procedure

 **WARNING**

Be sure to carefully read the SigmaWin+ Operation Manual before executing this function. Special care must be taken for the following.

- Before executing this function, make sure that the emergency stop (power off) can be activated when needed.

When tuning is initiated by this function, some parameters will be overwritten with the recommended values. As a result, the response speeds may change considerably. Before executing this function, make sure that the emergency stop (power off) can be activated when needed.

- Set a correct moment of inertia (mass) ratio to execute this function.
If not correctly set, vibration may be generated.
- Note the timing when the feedforward level setting is validated.
The set feedforward level will not be immediately validated, but will be validated after the Positioning Completion signal (/COIN) is output.

1. Confirm that the correct moment of inertia ratio in Pn103 is set by using the advanced autotuning.
2. In the SigmaWin+ main window, click **Tuning - Tuning**.

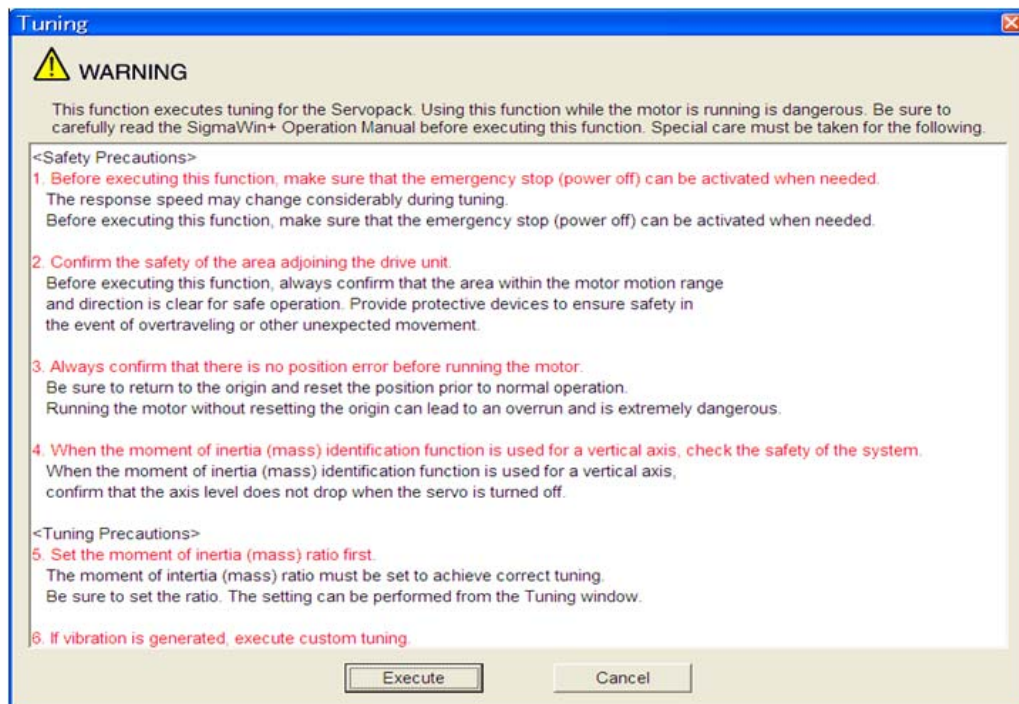

Click **Cancel** to return to the SigmaWin+ main window without executing tuning.

3. Click **Execute**.

The following window will appear.

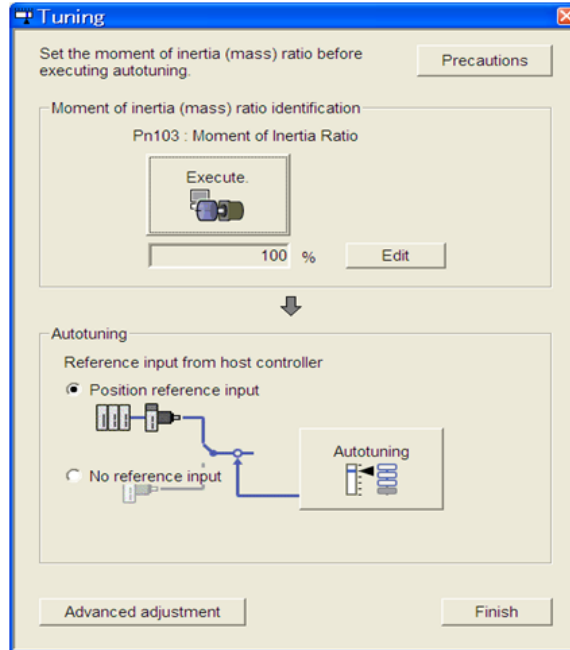

<Supplement>

If the following window will appear, click **OK** and confirm that the correct moment of inertia ratio in Pn103 is set by using the **Moment of Inertia (Mass) Setting** window.

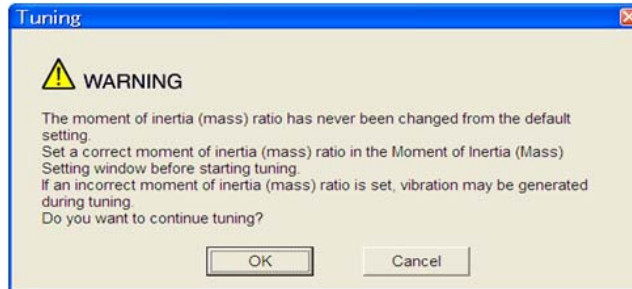

4. Click **Advanced adjustment**.

The following box will appear.

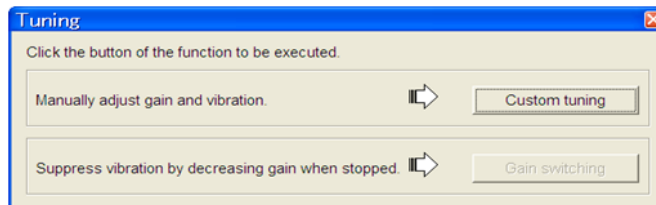

5. Click Custom tuning.

The following box will appear.

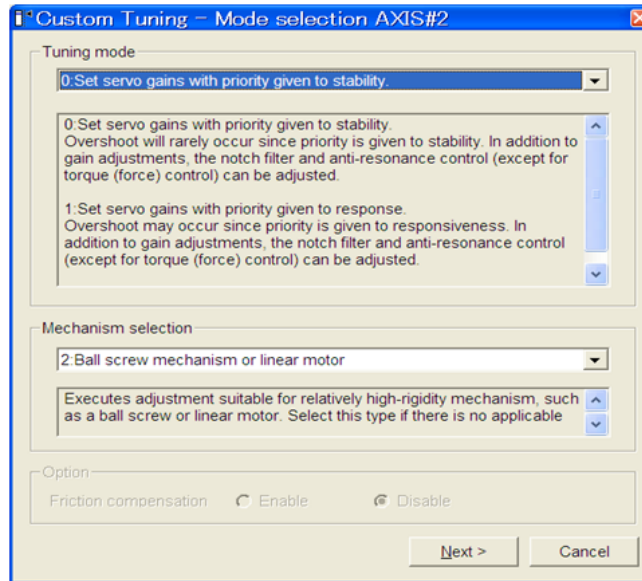

The tuning modes that can be selected will vary according to the SERVOPACK setting.

6. Select the tuning mode from the **Tuning mode box and the mechanism from the **Mechanism selection** box, and then click **Next**.**

The following box will appear.

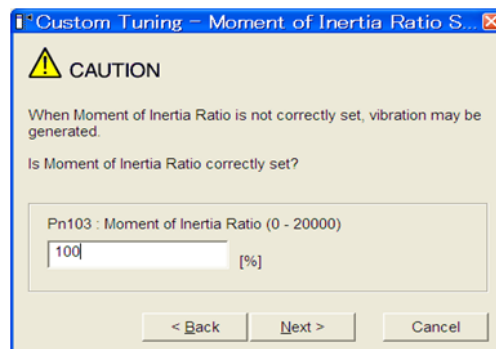

7. Enter the correct moment of inertia ratio and then click **Next**.
The following window will appear.

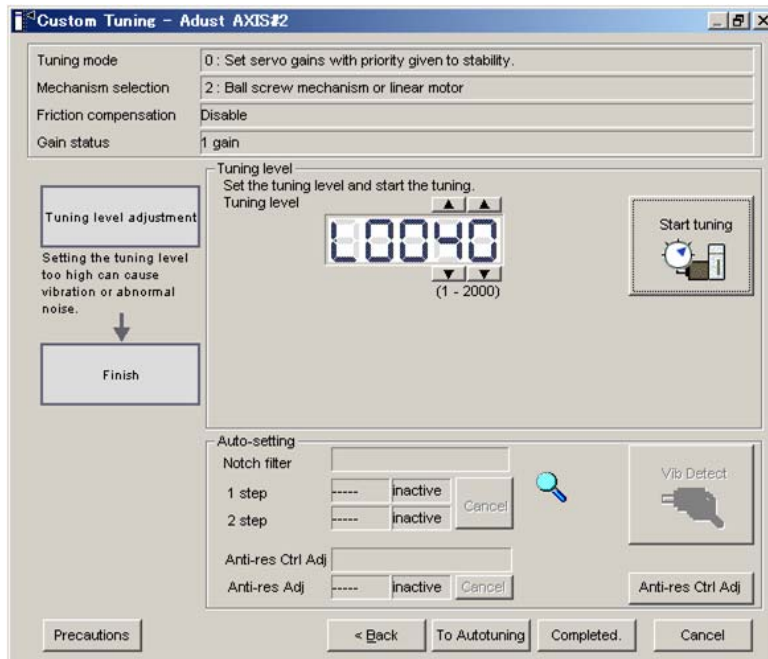

8. Turn the servo on and then input the reference from the host controller. Click **Start tuning**.

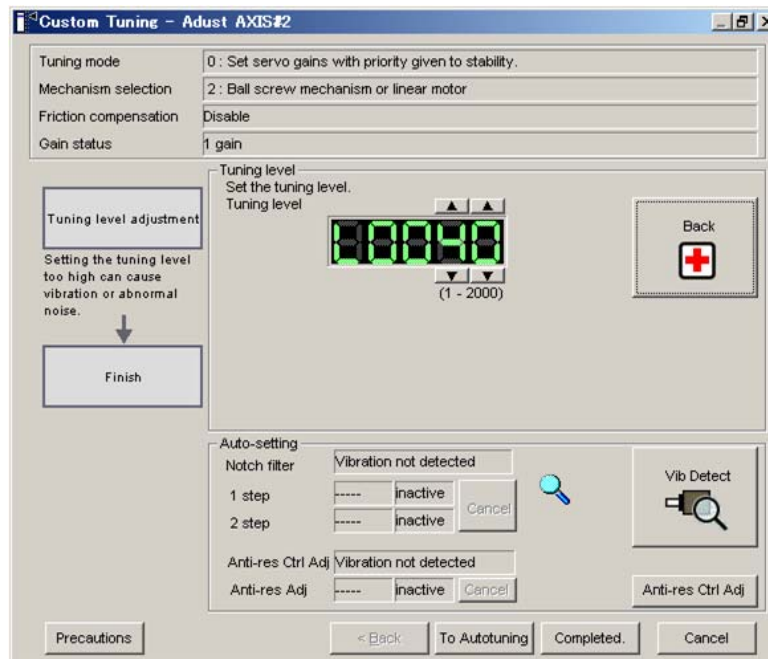

9. Change the tuning level by clicking the setting arrows. Continue to raise the level until an overshoot occurs.

Note: The set feedforward level will not be applied until the Positioning Completion signal (/COIN) is output.

The notch filter/anti-resonance control auto setting function, the anti-resonance control adjustment function, or autotuning with reference input can be used as required.

See ■ *Functions To Suppress Vibration* for details.

To reset to the original settings and status, click **Back**.

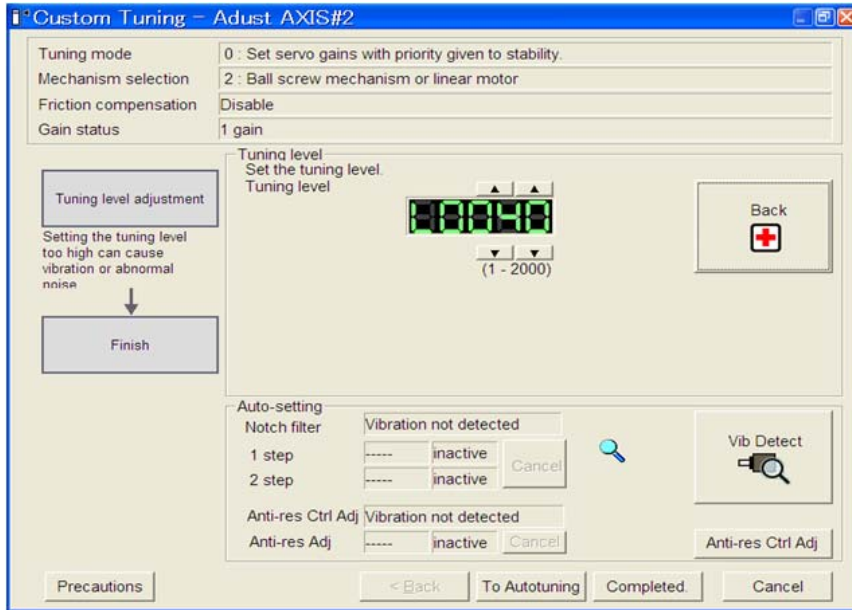

10. When tuning is complete, click **Completed** to return to the main window. The settings will be written in the SERVOPACK.

■ Functions To Suppress Vibration

• <Notch Filter/Anti-resonance Control Adjustment Auto Setting Function>

For vibration frequencies above 1,000 Hz when servo gains are increased, the notch filter auto setting function provides effective suppression. For vibration frequencies between 100 and 1,000 Hz, the anti-resonance control adjustment auto setting function is effective.

• Auto Setting

To use auto setting, enable the notch filter/anti-resonance control adjustment auto setting function by using parameters.

During tuning, the notch filter frequency (anti-resonance control frequency for the anti-resonance control adjustment auto setting function) effective for the detected vibration is automatically set and displayed in **1 step** or **2 step** (in **Anti-res Adj** when using the anti-resonance control adjustment auto setting function).

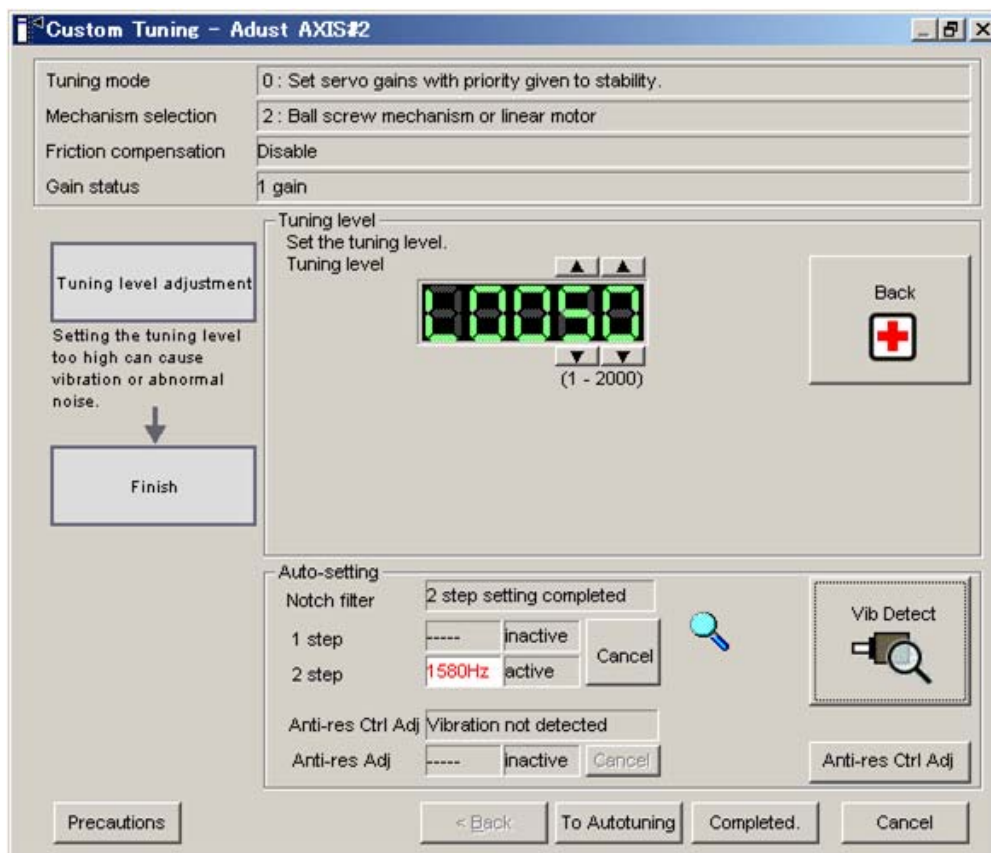

Window with Notch Filter Automatically Set

• Cancel

If the automatically set notch filter frequency (or anti-resonance control frequency) does not effectively suppress vibration, click **Cancel** to reset to the preceding frequency. When the frequency is reset, vibration detection will restart.

• Vib Detect (vibration detection)

While the notch filter/anti-resonance control adjustment auto setting function is enabled, click **Vib Detect** (vibration detection) to manually detect vibration. The SERVOPACK detects vibration at the moment **Vib Detect** (vibration detection) is clicked, and the notch filter frequency (or anti-resonance control frequency) effective for the detected vibration is set and displayed in **1 step** or **2 step** (or in **Anti-res Adj**). Manual vibration detection can also be executed when the SERVOPACK does not detect vibration.

• Anti-res Ctrl Adj (anti-resonance control)

Click **Anti-res Ctrl Adj** (anti-resonance control) to execute the anti-resonance control function if further adjustment is required. See 5.6 *Anti-Resonance Control Adjustment Function (Fn204)* for details.

• <Autotuning with Reference Input>

To Autotuning

Click **To Autotuning** to execute autotuning using reference inputs from the host controller. Refer to 5.4 *Advanced Autotuning by Reference (Fn202)* for details.

(2) Related Functions on One-parameter Tuning

This section describes functions related to one-parameter tuning.

■ Notch Filter

Usually, set this function to Auto Setting. (The notch filter is factory-set to Auto Setting.)

If this function is set to Auto Setting, vibration will be detected automatically during one-parameter tuning and the notch filter will be set.

Set this function to Not Auto Setting only if you do not change the notch filter setting before executing one-parameter tuning.

Parameter		Function	When Enabled	Classification
Pn460	n.□□□0	Does not set the 1st notch filter automatically with the utility function.	Immediately	Tuning
	n.□□□1 [Factory setting]	Sets the 1st notch filter automatically with the utility function.		
	n.□0□□	Does not set the 2nd notch filter automatically with the utility function.		
	n.□1□□ [Factory setting]	Sets the 2nd notch filter automatically with the utility function.		

■ Anti-Resonance Control Adjustment

This function reduces low vibration frequency, which the notch filter does not detect.

Usually, set this function to Auto Setting. (The anti-resonance control is factory-set to Auto Setting.)

When this function is set to Auto Setting, vibration will be automatically detected during one-parameter tuning and anti-resonance control will be automatically adjusted and set.

Parameter		Function	When Enabled	Classification
Pn160	n.□□0□	Does not use the anti-resonance control automatically with the utility function.	Immediately	Tuning
	n.□□1□ [Factory setting]	Uses the anti-resonance control automatically with the utility function.		

■ Friction Compensation

This function compensates for changes in the following conditions.

- Changes in the viscous resistance of the lubricant, such as the grease, on the sliding parts of the machine
- Changes in the friction resistance resulting from variations in the machine assembly
- Changes in the friction resistance due to aging

Conditions to which friction compensation is applicable depend on the tuning mode. The friction compensation setting in F408.3 applies when the mode is 0 or 1. Tuning Mode = 2 and Tuning Mode = 3 are adjusted with the friction compensation function regardless of the friction compensation setting in P408.3.

Friction Compensation Selecting		Mode			
		Tuning Mode = 0	Tuning Mode = 1	Tuning Mode = 2	Tuning Mode = 3
Pn408	n.0□□□ [Factory setting]	Adjusted without the friction compensation function	Adjusted without the friction compensation function	Adjusted with the friction compensation function	Adjusted with the friction compensation function
	n.1□□□	Adjusted with the friction compensation function	Adjusted with the friction compensation function		

■ Feedforward

If Pn140 is set to the factory setting and the tuning mode setting is changed to 2 or 3, the feedforward gain (Pn109), speed feedforward (VFF) input, and torque feedforward (TFF) input will be disabled.

Set Pn140.3 to 1 if model following control is used together with the speed feedforward (VFF) input and torque feedforward (TFF) input from the host controller.

Parameter	Function	When Enabled	Classification
Pn140	n.0□□□ [Factory setting]	Immediately	Tuning
	n.1□□□		

Refer to *Σ-V Series User's Manual MECHATROLINK-II Commands* (Manual No.: SIEP S800000 54) for details.



IMPORTANT

- Model following control is used to make optimum feedforward settings in the SERVO-PACK when model following control is used with the feedforward function. Therefore, model following control is not normally used together with either the speed feedforward (VFF) input or torque feedforward (TFF) input from the host controller. However, model following control can be used with the speed feedforward (VFF) input or torque feedforward (TFF) input if required. An improper feedforward input may result in overshooting.

5.5.3 One-parameter Tuning Example

The following procedure is used for one-parameter tuning on the condition that the tuning mode is set to 2 or 3. This mode is used to reduce positioning time.

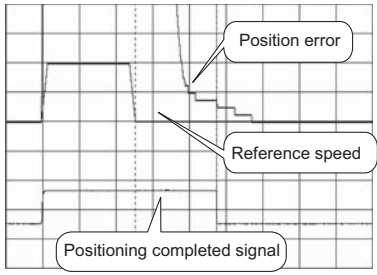
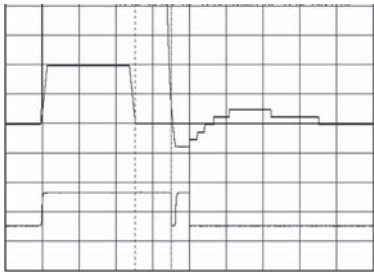
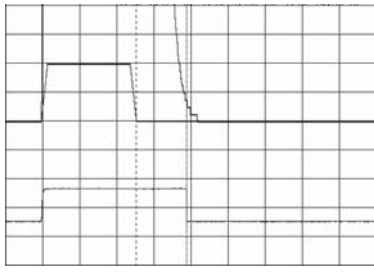
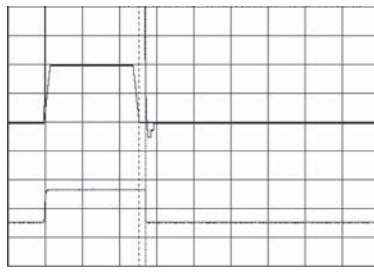
Step	Measuring Instrument Display Example	Operation
1	 <p>The graph shows three signals over time. The top signal is 'Position error', which starts at a constant level and then drops to zero at the end of the positioning pulse. The middle signal is 'Reference speed', which is a trapezoidal pulse. The bottom signal is 'Positioning completed signal', which is a step function that goes high at the start of the pulse and low at the end. A vertical dashed line marks the end of the positioning pulse.</p>	<p>Measure the positioning time after setting the moment of inertia ratio (Pn103) correctly. Tuning will be completed if the specifications are met here. The tuning results will be saved in the SERVOPACK.</p>
2	 <p>The graph shows the same three signals as in step 1, but the 'Positioning completed signal' goes high earlier, indicating a shorter positioning time. The 'Position error' signal also reaches zero earlier.</p>	<p>The positioning time will become shorter if the FF level is increased. The tuning will be completed if the specifications are met. The tuning results will be saved in the SERVOPACK. If overshooting occurs before the specifications are met, go to step 3.</p>
3	 <p>The graph shows the same three signals as in step 2, but the 'Positioning completed signal' goes high even earlier, and the 'Position error' signal reaches zero with less overshoot than in step 2.</p>	<p>Overshooting will be reduced if the FB level is increased. If the overshooting is eliminated, go to step 4.</p>
4	 <p>The graph shows the same three signals as in step 3, but the 'Positioning completed signal' goes high even earlier, and the 'Position error' signal reaches zero with significant overshoot.</p>	<p>The graph shows overshooting generated with the FF level increased after step 3. In this state, the overshooting occurs, but the positioning settling time is shorter. The tuning will be completed if the specifications are met. The adjustment results are saved in the SERVOPACK. If overshooting occurs before the specifications are met, repeat steps 3 and 4. If vibration occurs before the overshooting is eliminated, the vibration will be suppressed by the automatic notch filter and anti-resonance control.</p>
5		<p>The adjustment results are saved in the SERVOPACK.</p>

5.5.4 Related Parameters

The following table lists parameters related to this function and their possibility of being changed while executing this function or of being changed automatically after executing this function.

- Parameters related to this function

These are parameters that are used or referenced when executing this function.

- Allowed changes during execution of this function

Yes : Parameters can be changed using SigmaWin+ while this function is being executed.

No : Parameters cannot be changed using SigmaWin+ while this function is being executed.

- Automatic changes after execution of this function

Yes : Parameter set values are automatically set or adjusted after execution of this function.

No : Parameter set values are not automatically set or adjusted after execution of this function.

Parameter	Name	Mid-execution changes	Automatic changes
Pn100	Speed Loop Gain	No	Yes
Pn101	Speed Loop Integral Time Constant	No	Yes
Pn102	Position Loop Gain	No	Yes
Pn103	Moment of Inertia Ratio	No	No
Pn121	Friction Compensation Gain	No	Yes
Pn123	Friction Compensation Coefficient	No	Yes
Pn124	Friction Compensation Frequency Correction	No	No
Pn125	Friction Compensation Gain Correction	No	Yes
Pn401	Torque Reference Filter Time Constant	No	Yes
Pn408	Torque Related Function Switch	Yes	Yes
Pn409	1st Notch Filter Frequency	No	Yes
Pn40A	1st Notch Filter Q Value	No	Yes
Pn40C	2nd Notch Filter Frequency	No	Yes
Pn40D	2nd Notch Filter Q Value	No	Yes
Pn140	Model Following Control Related Switch	Yes	Yes
Pn141	Model Following Control Gain	No	Yes
Pn142	Model Following Control Gain Compensation	No	Yes
Pn143	Model Following Control Bias (Forward Direction)	No	Yes
Pn144	Model Following Control Bias (Reverse Direction)	No	Yes
Pn145	Vibration Suppression 1 Frequency A	No	No
Pn146	Vibration Suppression 1 Frequency B	No	No
Pn147	Model Following Control Speed Feedforward Compensation	No	Yes
Pn160	Anti-Resonance Control Related Switch	Yes	Yes
Pn161	Anti-Resonance Frequency	No	Yes
Pn163	Anti-Resonance Damping Gain	No	Yes

5.6 Anti-Resonance Control Adjustment Function (Fn204)

This section describes the anti-resonance control adjustment function.

5.6.1 Anti-Resonance Control Adjustment Function

The anti-resonance control adjustment function increases the effectiveness of the vibration suppression after one-parameter tuning. This function is effective in supporting anti-resonance control adjustment if the vibration frequencies are from 100 to 1000 Hz.

This function rarely needs to be used because it is automatically set by the advanced autotuning or advanced autotuning by reference input. Use this function only if fine-tuning is required, or vibration detection is failed and readjustment is required.

Perform one-parameter tuning (Fn203) or use another method to improve the response characteristics after performing this function. If the anti-resonance gain is increased with one-parameter tuning performed, vibration may result again. If that occurs, perform this function again to fine-tune the settings.

CAUTION

- If this function is executed, related parameters will be set automatically. Therefore, there will be a large response change after this function is executed. Enable the function in a state where the machine can come to an emergency stop at any time to ensure the safety operation of the machine.
- Be sure to set a suitable value for the moment of inertia ratio (Pn103) using advanced autotuning before executing the anti-resonance control adjustment function. If the setting greatly differs from the actual moment of inertia ratio, normal control of the machine may not be possible, and vibration may result.



IMPORTANT

- This function detects vibration between 100 and 1000 Hz. Vibration will not be detected for frequencies outside of this range, and instead, "F----" will be displayed. If that occurs, use one-parameter tuning with tuning mode 2 selected to automatically set a notch filter or use the vibration suppression function (Fn205).
- Vibration can be reduced more effectively by increasing the anti-resonance damping gain (Pn163). The amplitude of vibration may become larger if the damping gain is excessively high. Increase the damping gain from about 0% to 200% in 10% increments while checking the effect of vibration reduction. If the effect of vibration reduction is still insufficient at a gain of 200%, cancel the setting, and lower the control gain using a different method, such as one-parameter tuning.

■ Before Performing Anti-Resonance Control Adjustment Function

The following conditions must be met to perform anti-resonance control adjustment function.

- The tuning-less function must be disabled (Pn170.0 = 0).
- The test without a motor function must be disabled (Pn00C.0 = 0).
- The control must not be set to torque control.
- The write prohibited setting parameter (Fn010) must be set to Write permitted (P.0000).

5.6.2 Anti-Resonance Control Adjustment Function Operating Procedure

With this function, an operation reference is sent, and the function is executed while vibration is occurring.

The SigmaWin+ is required to execute this function.

The following methods can be used for the anti-resonance control adjustment function.

- With undetermined vibration frequency
- With determined vibration frequency

The following describes the operating procedures.



CAUTION

Be sure to carefully read the SigmaWin+ Operation Manual before executing this function.

Special care must be taken for the following.

- Before executing this function, make sure that the emergency stop (power off) can be activated when needed.
This function will automatically set parameters when used. As a result, the response speeds may change considerably after execution. Before executing this function, make sure that the emergency stop (power off) can be activated when needed.
- The moment of inertia (mass) must be correctly set to execute this function.
If it is not correctly set, satisfactory anti-resonance control cannot be achieved.
- If the frequency is changed while the anti-resonance control adjustment function is being used, the current anti-resonance control effect will be lost. Care must be taken when automatic frequency detection is executed in Auto Detect mode.
- If vibration cannot be suppressed by executing this function, cancel execution and reduce the servo gain by other methods such as custom tuning.
- Use an adjustment method such as custom tuning to improve response characteristics after executing this function.
When the servo gain is increased during an adjustment such as custom tuning, vibration may be generated again. In this case, execute the anti-resonance control adjustment function again for fine adjustment.

The anti-resonance control adjustment function supports the adjustment of anti-resonance control effective for vibration frequencies from 100 to 1,000 Hz when servo gain is increased. Vibration can be suppressed by setting vibration frequency by auto detection or by manual setting to adjust damping gain. Input a reference and execute this function when there is vibration.

(1) With Undetermined Vibration Frequency

1. In the SigmaWin+ main window, click **Tuning - Tuning**.

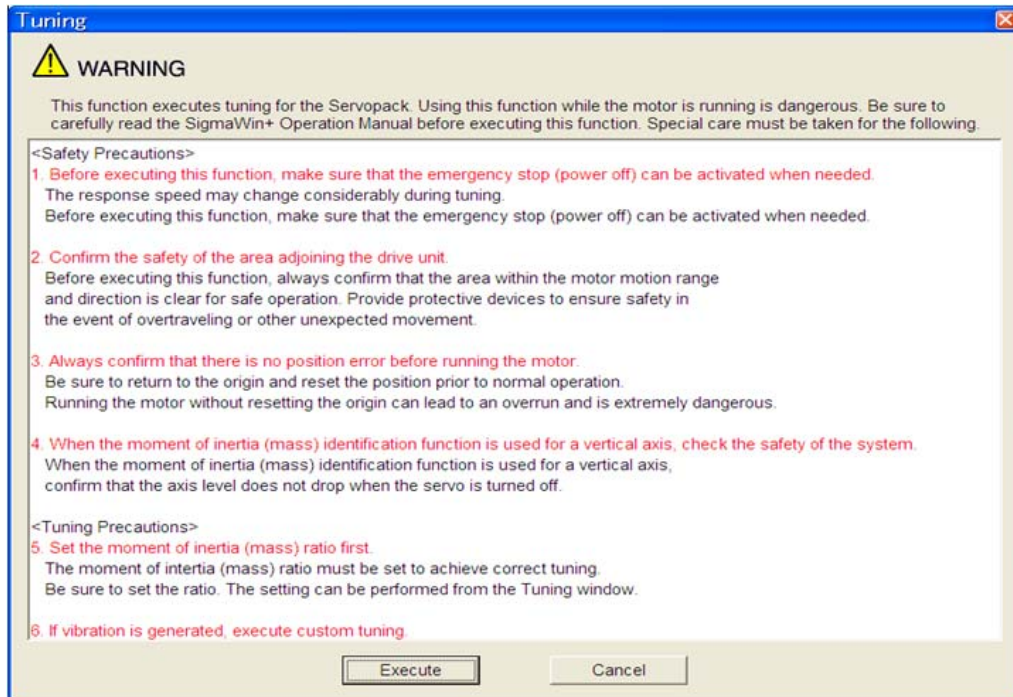

Click **Cancel** to return to the SigmaWin+ main window without executing tuning.

2. Click **Execute**.

The following window will appear.

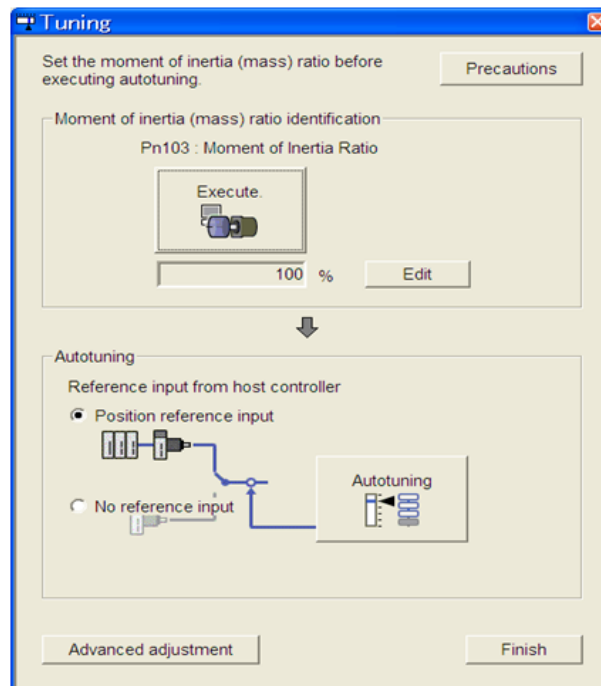

3. Click **Advanced adjustment**.

The following box will appear.

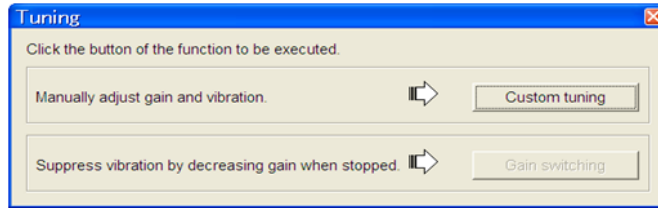

4. Click **Custom tuning**.

The following box will appear.

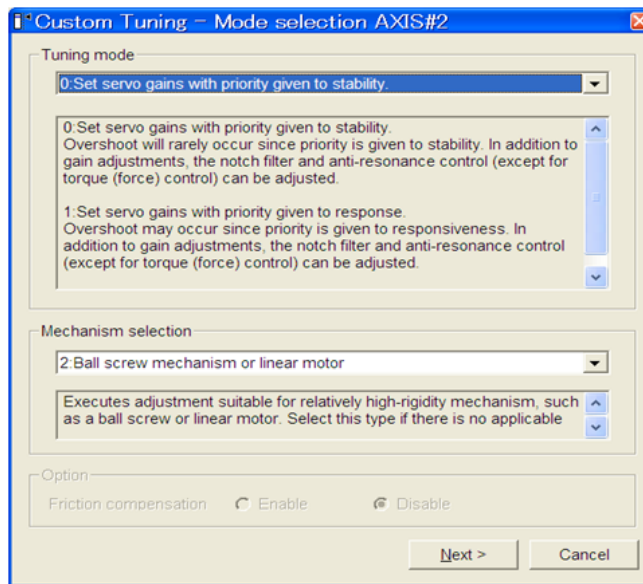

5. Select the tuning mode from the **Tuning mode** box and the mechanism from the **Mechanism selection** box, and then click **Next**.

The following box will appear.

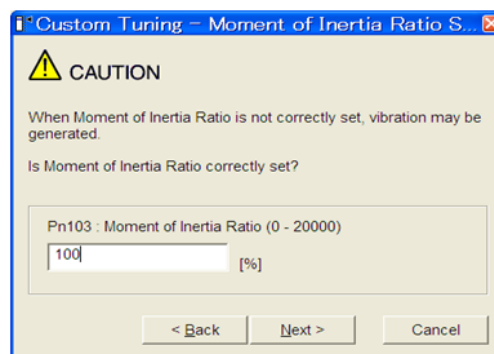

- Enter the correct moment of inertia ratio and then click **Next**.
The following window will appear.

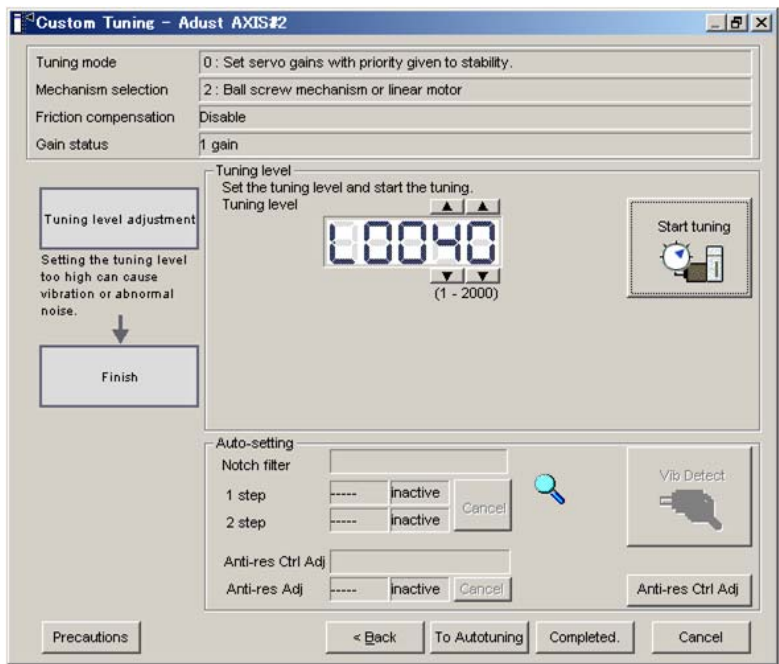

- Click **Anti-res Ctrl Adj**.
The following window will appear.

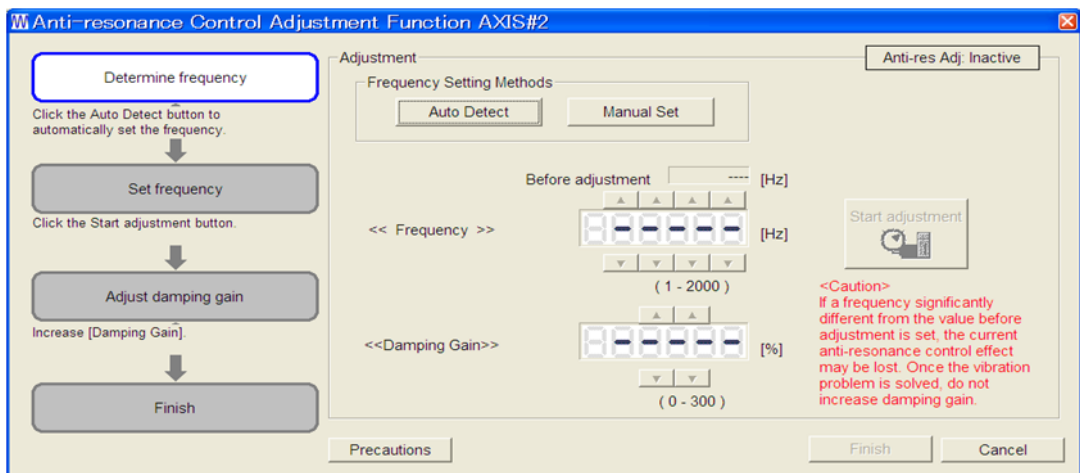

- Click **Auto Detect** to set the frequency and click **Start adjustment**.
The following window will appear.

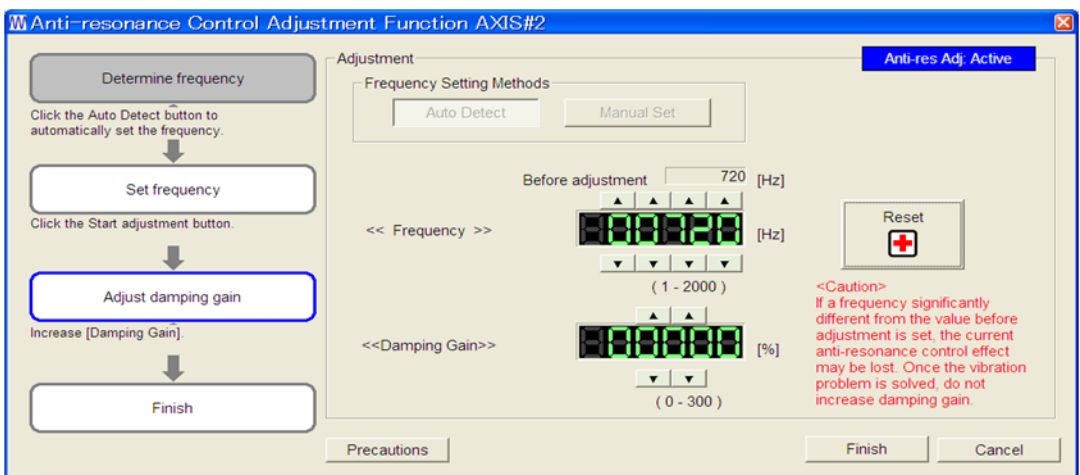

9. Adjust the damping gain by clicking the setting arrows.

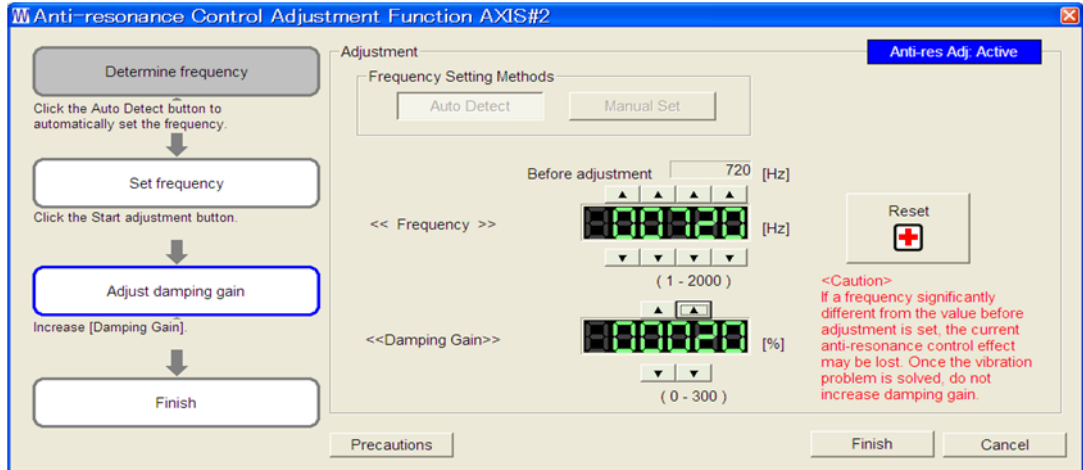

Click **Reset** to reset the settings to their original values during adjustment.

10. When the adjustment is complete, click **Finish** to return to the main window.

The set values will be written in the SERVOPACK.

(2) With Determined Vibration Frequency

1. In the SigmaWin+ main window, click **Tuning - Tuning**.

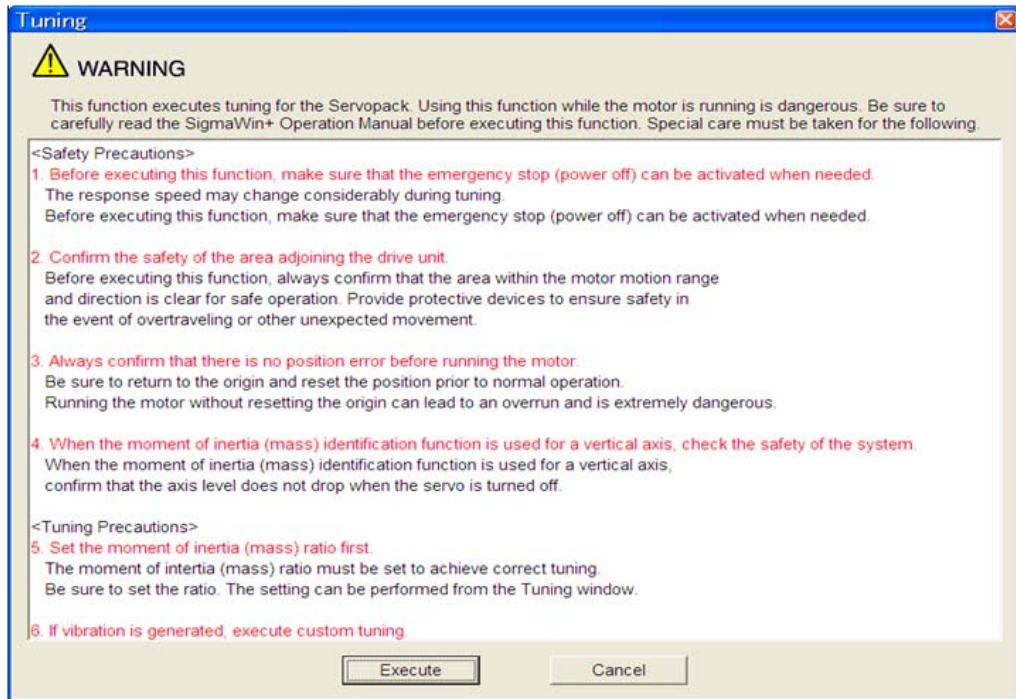

Click **Cancel** to return to the SigmaWin+ main window without executing tuning.

2. Click **Execute**.

The following window will appear.

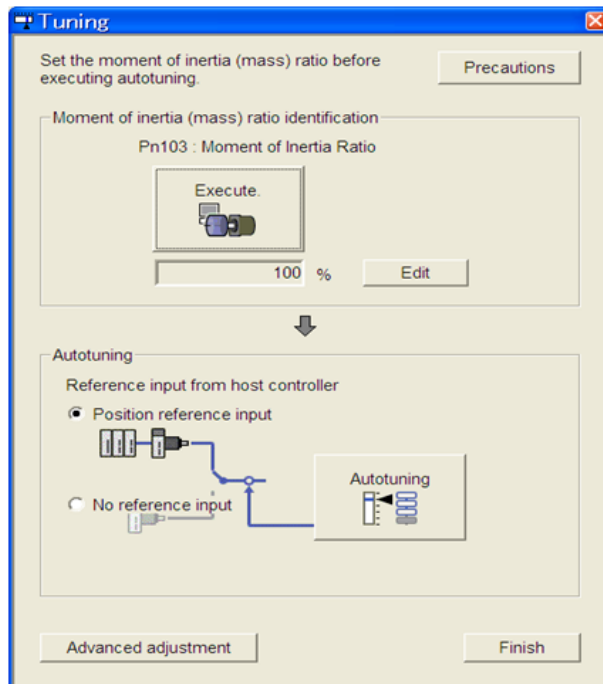

3. Click **Advanced adjustment**.

The following box will appear.

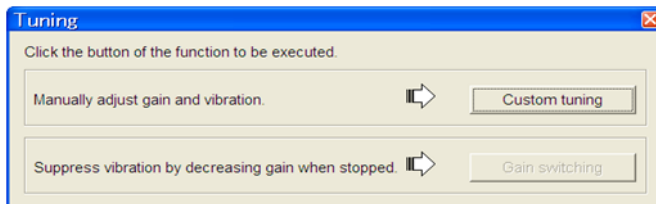

4. Click **Custom tuning**.

The following box will appear.

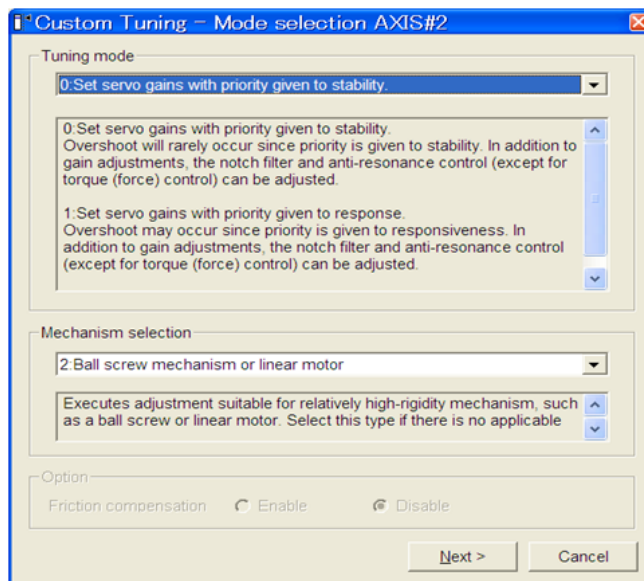

- Select the tuning mode from the **Tuning mode** box and the mechanism from the **Mechanism selection** box, and then click **Next**.

The following box will appear.

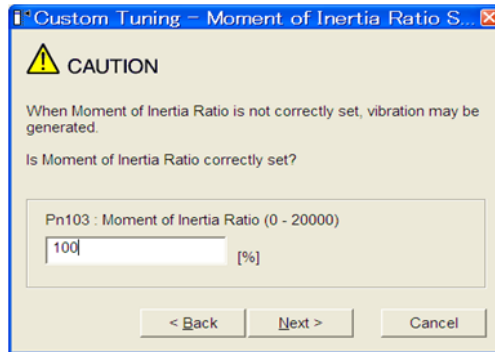

- Enter the correct moment of inertia ratio and then click **Next**.

The following window will appear.

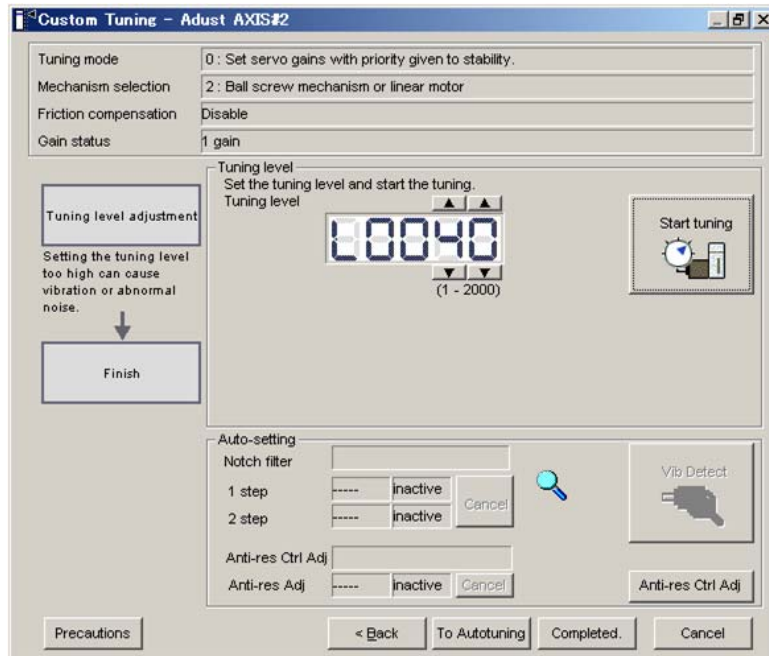

- Click **Anti-res Ctrl Adj**.

The following window will appear.

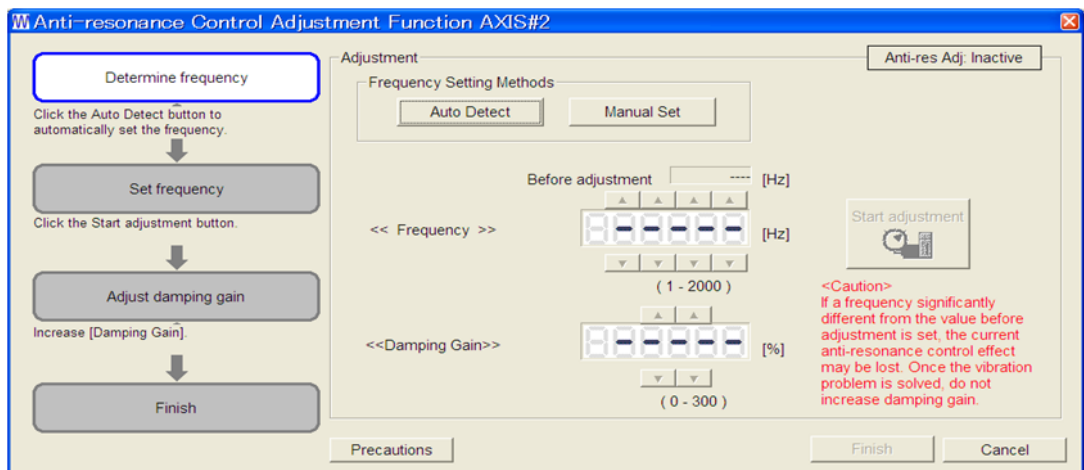

8. Click **Manual Set** to set the frequency and click **Start adjustment**.
The following window will appear.

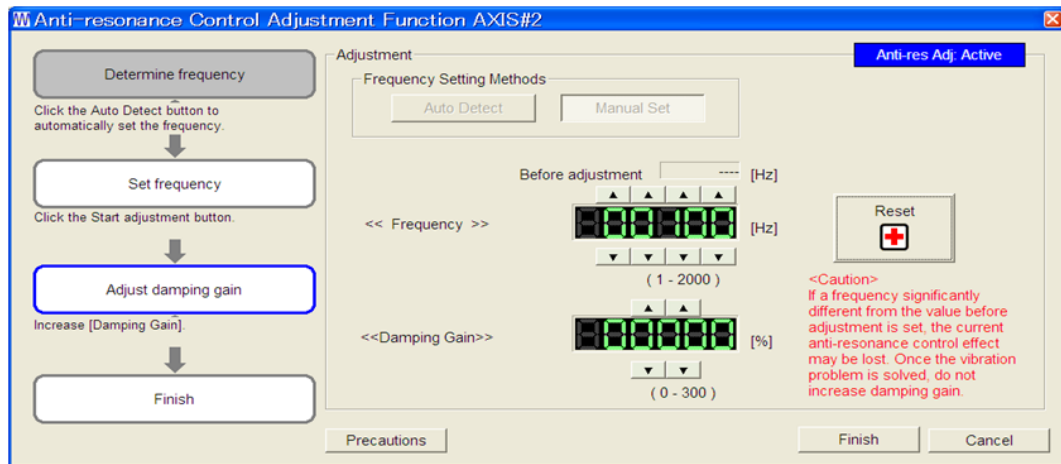

9. Adjust the frequency by clicking the setting arrows.

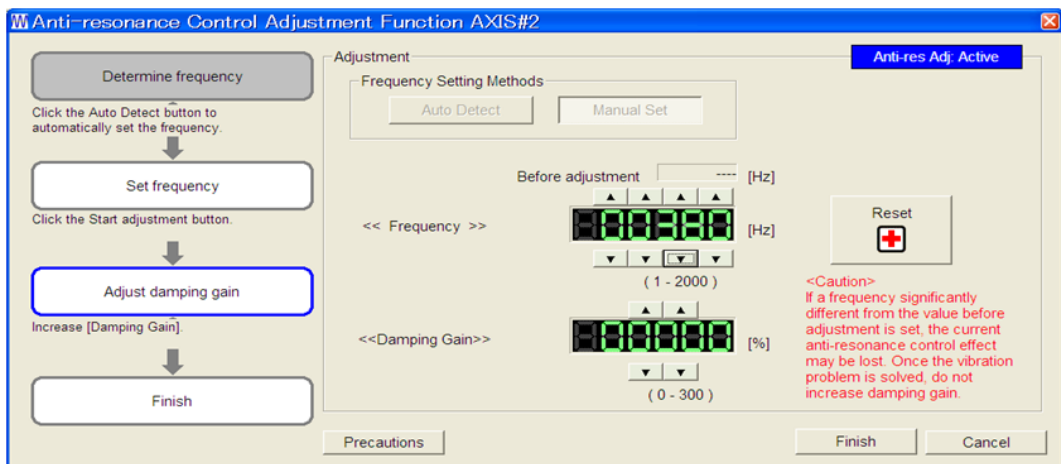

Click **Reset** to reset the settings to their original values during adjustment.

10. Adjust the damping gain by clicking the setting arrows.

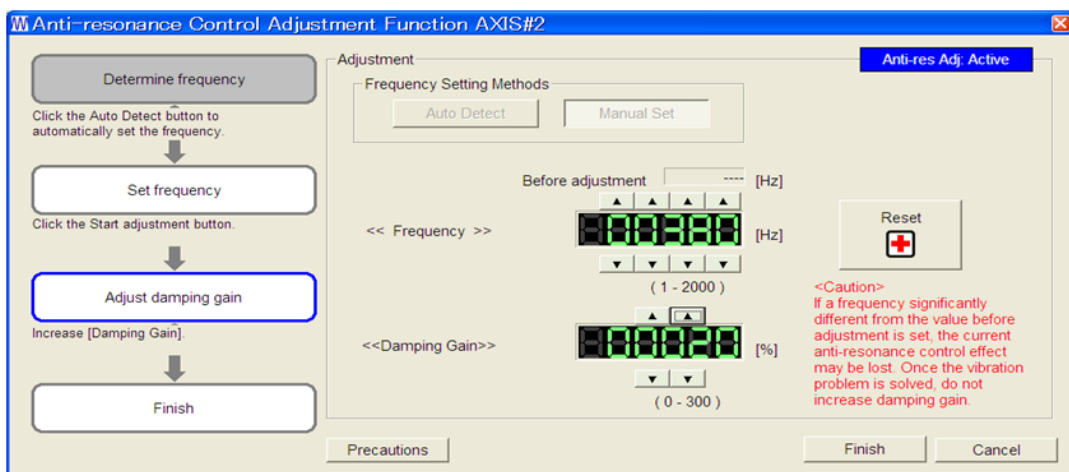

Click **Reset** to reset the settings to their original values during adjustment.

11. When the adjustment is complete, click **Finish** to return to the main window.
The set values will be written in the SERVOPACK.

5.6.3 Related Parameters

The following table lists parameters related to this function and their possibility of being changed while executing this function or of being changed automatically after executing this function.

- Parameters related to this function

These are parameters that are used or referenced when executing this function.

- Allowed changes during execution of this function

Yes : Parameters can be changed using SigmaWin+ while this function is being executed.

No : Parameters cannot be changed using SigmaWin+ while this function is being executed.

- Automatic changes after execution of this function

Yes : Parameter set values are automatically set or adjusted after execution of this function.

No : Parameter set values are not automatically set or adjusted after execution of this function.

Parameter	Name	Mid-execution changes	Automatic changes
Pn160	Anti-Resonance Control Related Switch	Yes	Yes
Pn161	Anti-Resonance Frequency	No	Yes
Pn162	Anti-Resonance Gain Compensation	Yes	No
Pn163	Anti-Resonance Damping Gain	No	Yes
Pn164	Anti-Resonance Filter Time Constant 1 Compensation	Yes	No
Pn165	Anti-Resonance Filter Time Constant 2 Compensation	Yes	No

5.7 Vibration Suppression Function (Fn205)

The vibration suppression function is described in this section.

5.7.1 Vibration Suppression Function

The vibration suppression function suppresses transitional vibration at frequency as low as 1 to 100 Hz that is generated mainly when positioning if the machine stand vibrates. This function is effective for vibration frequencies for which notch filter and anti-resonance control adjustment functions are not applicable.

This function is set automatically when advanced autotuning or advanced autotuning by reference is executed. In most cases, this function is not necessary. Use this function only if fine-tuning is required or readjustment is required as a result of a failure to detect vibration. Before executing this function, input an operation reference to create vibration.

Perform one-parameter tuning (Fn203) if required to improve the response characteristics after performing this function.

CAUTION

- If this function is executed, related parameters will be set automatically. Therefore, there will be a large response change after this function is enabled or disabled. Enable the function in a state where the machine can come to an emergency stop at any time to ensure the safety operation of the machine.
- If the parameter settings are changed while the motor is moving, the new settings will become valid after the /COIN signal is output.
- Be sure to set a suitable value for the moment of inertia ratio (Pn103) using advanced autotuning before executing the vibration suppression function. If the setting greatly differs from the actual moment of inertia ratio, normal control of the SERVOPACK may not be possible, and vibration may result.
- Phase control of the MP2000 Series may not be possible, if the vibration suppression function is performed when using the MP2000 Series with phase control.



IMPORTANT

- This function detects vibration frequency between 1 to 100 Hz. Vibration will not be detected for frequencies outside of this range, and instead, "F----" will be displayed.
- Frequency detection will not be performed if no vibration results from position error or the vibration frequencies are outside the range of detectable frequencies. If so, use a device, such as a displacement sensor or vibration sensor, to measure the vibration frequency.
- If vibration frequencies automatically detected are not suppressed, the actual frequency and the detected frequency may differ. Fine-tune the detected frequency if necessary.

(1) Preparation

The following conditions must be met to perform the vibration suppression function.

- The control must be set to position control.
- The tuning-less function must be disabled (Pn170.0 = 0).
- The test without a motor function must be disabled (Pn00C.0 = 0).
- The write prohibited setting parameter (Fn010) must be set to Write permitted (P.0000).

(2) Items Influencing Performance

If continuous vibration occurs when the servomotor is not rotating, the vibration suppression function cannot be used to suppress the vibration effectively. If the result is not satisfactory, perform anti-resonance control adjustment function (Fn204) or one-parameter tuning (Fn203).

(3) Detection of Vibration Frequencies

No frequency detection may be possible if the vibration does not appear as a position error or the vibration resulting from the position error is too small.

The detection sensitivity can be adjusted by changing the setting for the remained vibration detection width (Pn560) which is set as a percentage of the positioning completed width (Pn522). Perform the detection of vibration frequencies again after adjusting the remained vibration detection width (Pn560).

Pn560	Remained Vibration Detection Width Position				Classification
	Setting Range	Setting Unit	Factory Setting	When Enabled	
	1 to 3000	0.1%	400	Immediately	Setup

Note: As a guideline, change the setting 10% at a time. The smaller the set value is, the higher the detection sensitivity will be. If the value is too small, however, the vibration may not be detected accurately.

The vibration frequencies that are automatically detected may vary somewhat with each positioning operation. Perform positioning several times and make adjustments while checking the effect of vibration suppression.

5.7.2 Vibration Suppression Function Operating Procedure

The following procedure is used for vibration suppression function.

The SigmaWin+ is required to execute this function.

(1) Operating Procedure

1. In the SigmaWin+ main window, click **Tuning - Tuning**.

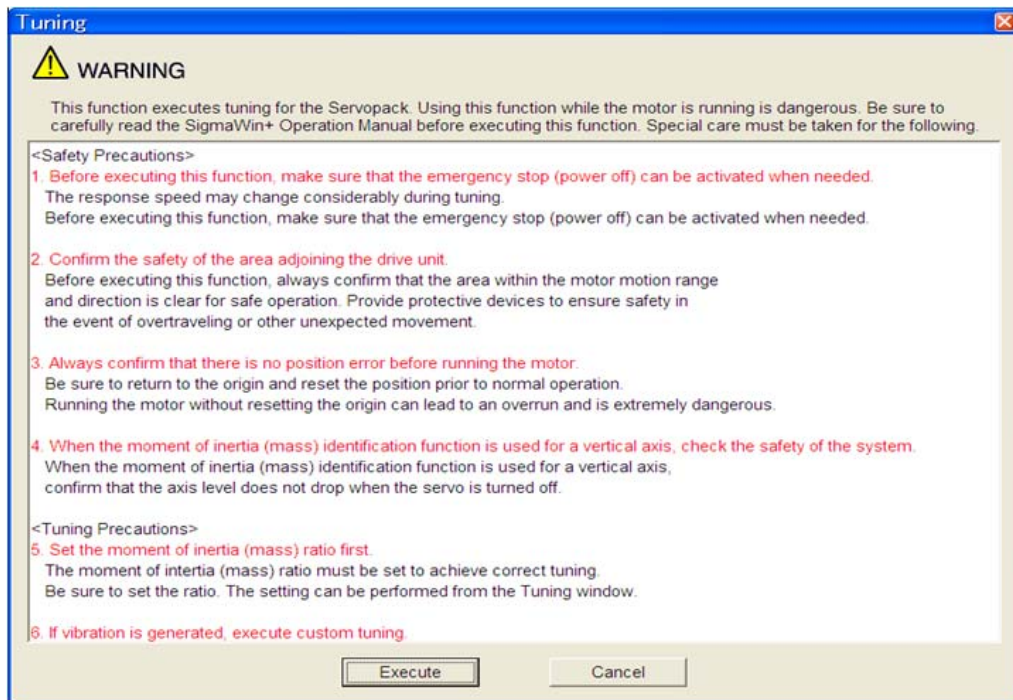

Click **Cancel** to return to the SigmaWin+ main window without executing tuning.

2. Click **Execute**.

The following window will appear.

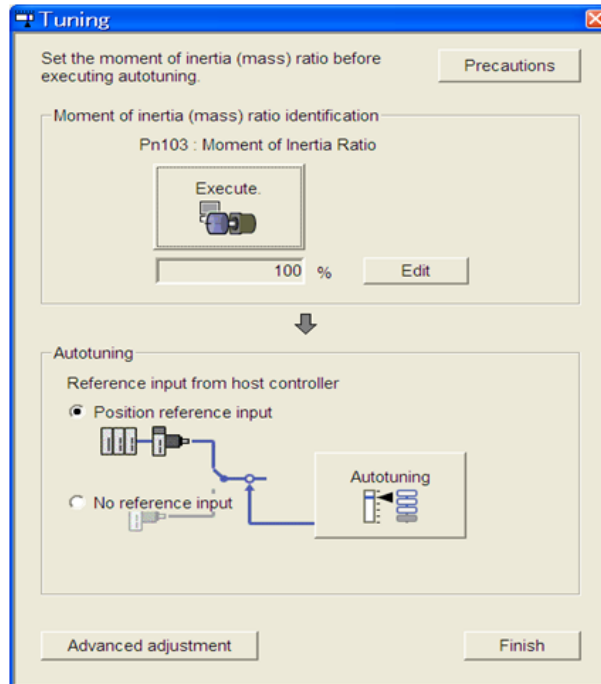

3. Click **Advanced adjustment**.

The following box will appear.

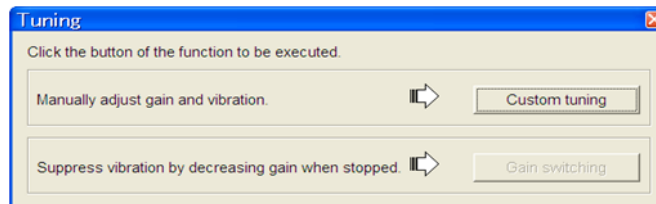

4. Click **Custom tuning**.

The following box will appear.

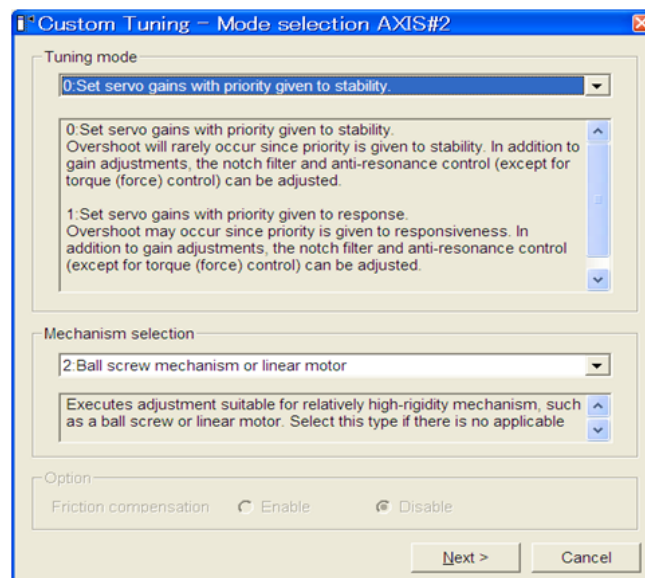

5. Select the **2** or **3** of tuning mode from the **Tuning mode** box and the mechanism from the **Mechanism selection** box, and then click **Next**.

The following box will appear.

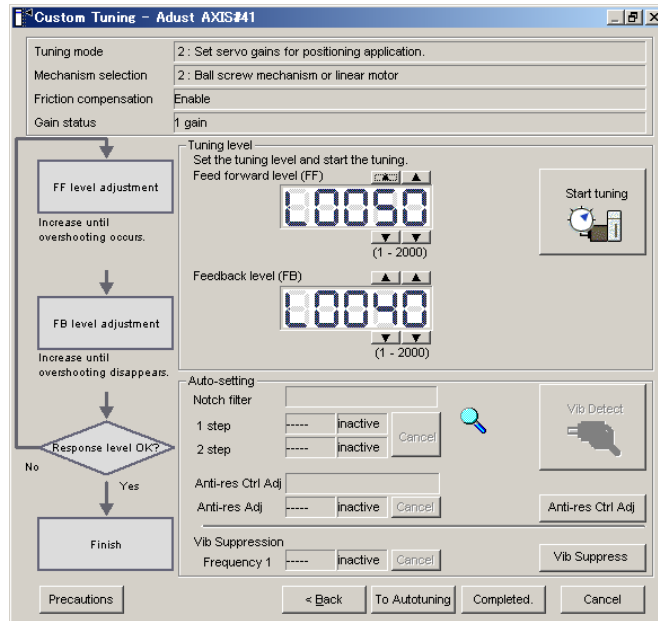

6. Click **Vib Suppress**.

The **Vibration suppression Function** box will appear.

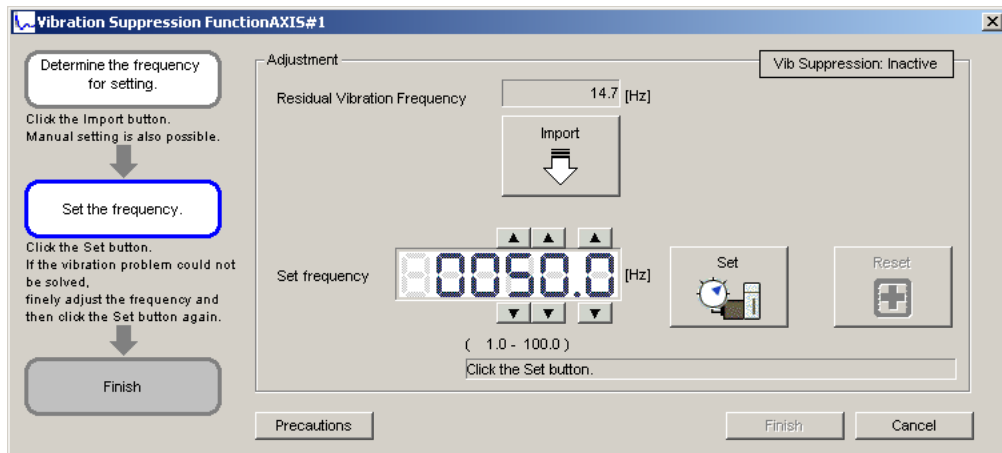

7. Set a frequency by using the **Import** function or by manually selecting the frequency. Click **Import**. The value of the residual vibration frequency being monitored will be imported to the **Set frequency** box. This function, however, is effective only when the residual vibration frequency is between 1.0 and 100.0.

The **Set frequency** can be manually selected by clicking the setting arrows.

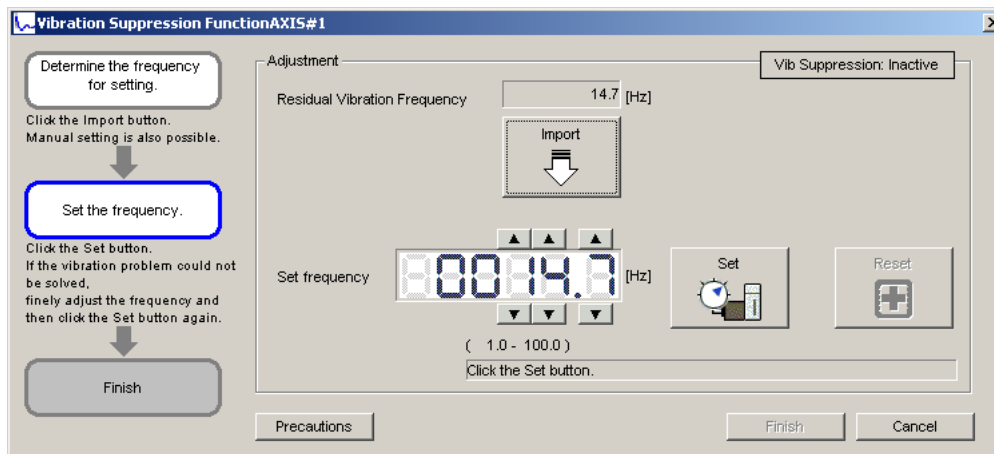

8. Click **Set**.

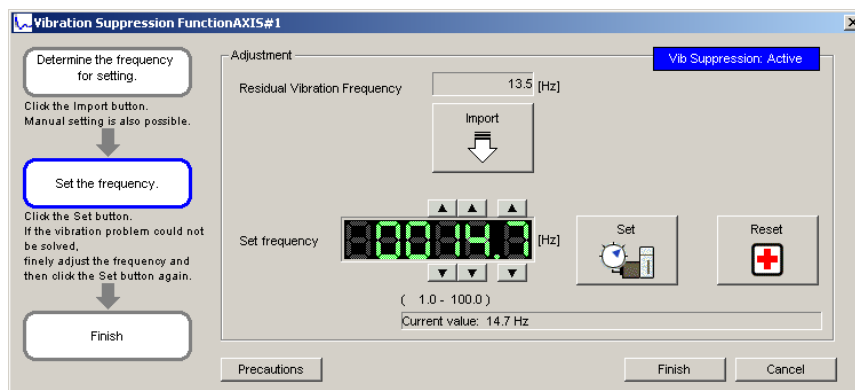

If any vibration still occurs, manually make fine adjustments to the **Set frequency**, and click **Set**.

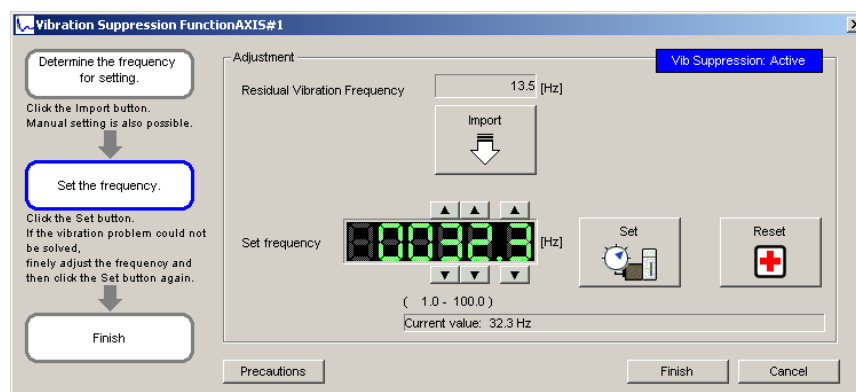

If you need to undo the change you made while making adjustments, click **Reset**. The setting will be restored to the original value.

9. After the vibration has been successfully suppressed, click **Finish**.

The value of the **Set frequency** will be transferred to and saved in the SERVOPACK.



IMPORTANT

No settings related to the vibration suppression function will be changed during operation.

If the servomotor does not stop approximately 10 seconds after the setting changes, a timeout error will result and the previous setting will be automatically enabled again.

The vibration suppression function will be enabled in step 9. The motor response, however, will change when the servomotor comes to a stop with no reference input.

(2) Related Function on Vibration Suppression Function

This section describes functions related to vibration suppression function.

■ **Feedforward**

The feedforward gain (Pn109), speed feedforward (VFF) input, and torque feedforward (TFF) input will be disabled in the factory setting.

Set Pn140.3 to 1 if model following control is used together with the speed feedforward (VFF) input and torque feedforward (TFF) input from the host controller.

Parameter		Function	When Enabled	Classification
Pn140	n.0□□□ [Factory setting]	Model following control is not used together with the speed/torque feedforward input.	Immediately	Tuning
	n.1□□□	Model following control is used together with the speed/torque feedforward input.		

Refer to *Σ-V Series User's Manual MECHATROLINK-II Commands* (Manual No.: SIEP S800000 54) for details.



IMPORTANT

- Model following control is used to make optimum feedforward settings in the SERVOPACK when model following control is used with the feedforward function. Therefore, model following control is not normally used together with either the speed feedforward (VFF) input or torque feedforward (TFF) input from the host controller. However, model following control can be used with the speed feedforward (VFF) input or torque feedforward (TFF) input if required. An improper feedforward input may result in overshooting.

5.7.3 Related Parameters

The following table lists parameters related to this function and their possibility of being changed while executing this function or of being changed automatically after executing this function.

- Parameters related to this function

These are parameters that are used or referenced when executing this function.

- Allowed changes during execution of this function

Yes : Parameters can be changed using SigmaWin+ while this function is being executed.

No : Parameters cannot be changed using SigmaWin+ while this function is being executed.

- Automatic changes after execution of this function

Yes : Parameter set values are automatically set or adjusted after execution of this function.

No : Parameter set values are not automatically set or adjusted after execution of this function.

Parameter	Name	Mid-execution changes	Automatic changes
Pn140	Model Following Control Related Switch	Yes	Yes
Pn141	Model Following Control Gain	No	Yes
Pn142	Model Following Control Gain Compensation	No	No
Pn143	Model Following Control Bias (Forward Direction)	No	No
Pn144	Model Following Control Bias (Reverse Direction)	No	No
Pn145	Vibration Suppression 1 Frequency A	No	Yes
Pn146	Vibration Suppression 1 Frequency B	No	Yes
Pn147	Model Following Control Speed Feedforward Compensation	No	No
Pn14A	Vibration Suppression 2 Frequency	No	No
Pn14B	Vibration Suppression 2 Compensation	No	No

5.8 Additional Adjustment Function

This section describes the functions that can be used for additional fine tuning after making adjustments with advanced autotuning, advanced autotuning by reference, or one-parameter tuning.

- Switching gain settings
- Friction compensation
- Current control mode selection
- Current gain level setting
- Speed detection method selection

5.8.1 Switching Gain Settings

Two gain switching functions are available, manual switching and automatic switching. The manual switching function uses an external input signal to switch gains, and the automatic switching function switches gains automatically.

By using the gain switching function, the positioning time can be shortened by increasing the gain during positioning and vibration can be suppressed by decreasing the gain while it is stopped.

Parameter		Function	When Enabled	Classification
Pn139	n.□□□0 [Factory setting]	Manual gain switching	Immediately	Tuning
	n.□□□2	Automatic gain switching		

Note: n.□□□1 is reserved. Do not use.

For the gain combinations for switching, refer to (1) *Gain Combinations for Switching*.

For the manual gain switching, refer to (2) *Manual Gain Switching*.

For the automatic gain switching, refer to (3) *Automatic Gain Switching*.

(1) Gain Combinations for Switching

Setting	Speed Loop Gain	Speed Loop Integral Time Constant	Position Loop Gain	Torque Reference Filter	Model Following Control Gain	Model Following Control Gain Compensation	Friction Compensation Gain
Gain Setting 1	Pn100 Speed Loop Gain	Pn101 Speed Loop Integral Time Constant	Pn102 Position Loop Gain	Pn401 Torque Reference Filter Time Constant	Pn141* Model Following Control Gain	Pn142* Model Following Control Gain Compensation	Pn121 Friction Compensation Gain
Gain Setting 2	Pn104 2nd Speed Loop Gain	Pn105 2nd Speed Loop Integral Time Constant	Pn106 2nd Position Loop Gain	Pn412 1st Step 2nd Torque Reference Filter Time Constant	Pn148* 2nd Model Following Control Gain	Pn149* 2nd Model Following Control Gain Compensation	Pn122 2nd Gain for Friction Compensation

* The switching gain settings for the model following control gain and the model following control gain compensation are available only for manual gain switching. To enable the gain switching of these parameters, a gain switching input signal must be sent, and the following conditions must be met.

- No command being executed.
- Motor having been completely stopped.

If these conditions are not satisfied, the applicable parameters will not be switched although the other parameters shown in this table will be switched.

(2) Manual Gain Switching

Manual gain switching uses G-SEL of OPTION field to switch between gain setting 1 and gain setting 2.

Type	Command Name	Setting	Meaning
Input	G-SEL of OPTION field	0	Switches to gain setting 1.
		1	Switches to gain setting 2.

(3) Automatic Gain Switching

Automatic gain switching is enabled only in position control. The switching conditions are specified using the following settings.

Parameter Setting	Switching Condition	Setting	Switching Wait Time	Switching Time	
Pn139	n.□□□2	Condition A satisfied.	Gain setting 1 to gain setting 2	Pn135 Gain Switching Waiting Time 1	Pn131 Gain Switching Time 1
		Condition A not satisfied.	Gain setting 2 to gain setting 1	Pn136 Gain Switching Waiting Time 2	Pn132 Gain Switching Time 2

Select one of the following settings for switching condition A.

Parameter	Switching Condition A for Position Control	For Other than Position Control (No Switching)	When Enabled	Classification	
Pn139	n.□□0□ [Factory setting]	Positioning completed signal (/COIN) ON	Fixed in gain setting 1	Immediately	Tuning
	n.□□1□	Positioning completed signal (/COIN) OFF	Fixed in gain setting 2		
	n.□□2□	Positioning near signal (/NEAR) ON	Fixed in gain setting 1		
	n.□□3□	Positioning near signal (/NEAR) OFF	Fixed in gain setting 2		
	n.□□4□	No output for position reference filter and position reference input OFF	Fixed in gain setting 1		
	n.□□5□	Position reference input ON	Fixed in gain setting 2		

Automatic switching pattern 1 (Pn139.0 = 2)

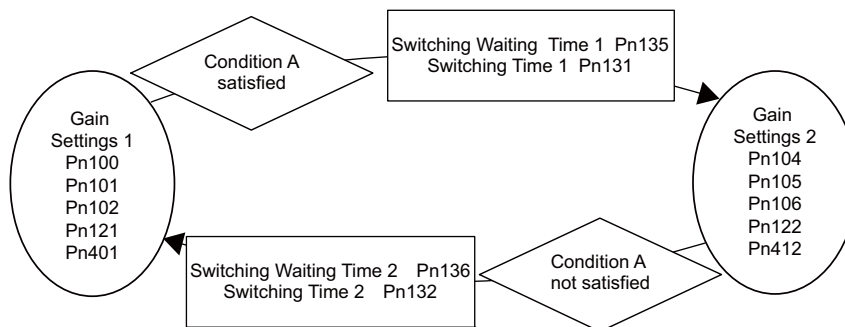

■ Relationship between the Waiting and Switching Times for Gain Switching

In this example, the "positioning completed signal (/COIN) ON" condition is set as condition A for automatic gain switching. The position loop gain is switched from the value in Pn102 (position loop gain) to the value in Pn106 (2nd position loop gain). When the /COIN signal goes ON, the switching operation begins after the waiting time set in Pn135. The switching operation changes the position loop gain linearly from Pn102 to Pn106 within the switching time set in Pn131.

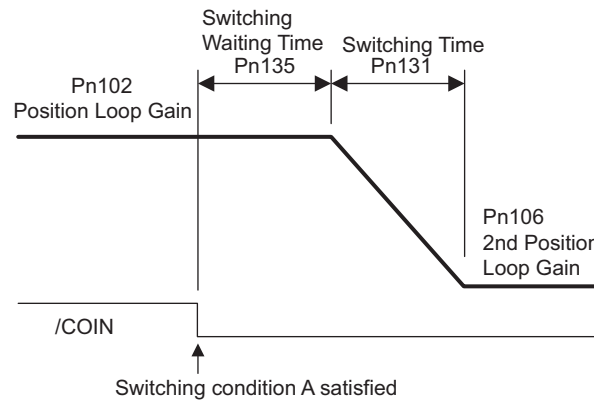

Note: Automatic gain switching is available in the PI and I-P controls (Pn10B).

(4) Related Parameters

Pn100	Speed Loop Gain [Speed] [Position]				Classification
	Setting Range	Setting Unit	Factory Setting	When Enabled	
	10 to 20000	0.1 Hz	400	Immediately	Tuning
Pn101	Speed Loop Integral Time Constant [Speed] [Position]				Classification
	Setting Range	Setting Unit	Factory Setting	When Enabled	
	15 to 51200	0.01 ms	2000	Immediately	Tuning
Pn102	Position Loop Gain [Position]				Classification
	Setting Range	Setting Unit	Factory Setting	When Enabled	
	10 to 20000	0.1/s	400	Immediately	Tuning
Pn401	Torque Reference Filter Time Constant [Speed] [Position] [Torque]				Classification
	Setting Range	Setting Unit	Factory Setting	When Enabled	
	0 to 65535	0.01 ms	100	Immediately	Tuning
Pn141	Model Following Control Gain [Position]				Classification
	Setting Range	Setting Unit	Factory Setting	When Enabled	
	10 to 20000	0.1/s	500	Immediately	Tuning
Pn142	Model Following Control Gain Compensation [Position]				Classification
	Setting Range	Setting Unit	Factory Setting	When Enabled	
	500 to 2000	0.1%	1000	Immediately	Tuning
Pn121	Friction Compensation Gain [Speed] [Position]				Classification
	Setting Range	Setting Unit	Factory Setting	When Enabled	
	10 to 1000	1%	100	Immediately	Tuning
Pn104	2nd Speed Loop Gain [Speed] [Position]				Classification
	Setting Range	Setting Unit	Factory Setting	When Enabled	
	10 to 20000	0.1 Hz	400	Immediately	Tuning

(cont'd)

Pn105	2nd Speed Loop Integral Time Constant				Speed	Position	Classification	
	Setting Range	Setting Unit	Factory Setting	When Enabled				
	15 to 51200	0.01 ms	2000	Immediately		Tuning		
Pn106	2nd Position Loop Gain					Position	Classification	
	Setting Range	Setting Unit	Factory Setting	When Enabled				
	10 to 20000	0.1/s	400	Immediately		Tuning		
Pn412	1st Step 2nd Torque Reference Filter Time Constant				Speed	Position	Torque	Classification
	Setting Range	Setting Unit	Factory Setting	When Enabled				
	0 to 65535	0.01 ms	100	Immediately		Tuning		
Pn148	2nd Model Following Control Gain					Position	Classification	
	Setting Range	Setting Unit	Factory Setting	When Enabled				
	10 to 20000	0.1/s	500	Immediately		Tuning		
Pn149	2nd Model Following Control Gain Compensation					Position	Classification	
	Setting Range	Setting Unit	Factory Setting	When Enabled				
	500 to 2000	0.1%	1000	Immediately		Tuning		
Pn122	2nd Gain for Friction Compensation				Speed	Position	Classification	
	Setting Range	Setting Unit	Factory Setting	When Enabled				
	10 to 1000	1%	100	Immediately		Tuning		

(5) Parameters for Automatic Gain Switching

Pn131	Gain Switching Time 1					Position	Classification
	Setting Range	Setting Unit	Factory Setting	When Enabled			
	0 to 65535	1 ms	0	Immediately		Tuning	
Pn132	Gain Switching Time 2					Position	Classification
	Setting Range	Setting Unit	Factory Setting	When Enabled			
	0 to 65535	1 ms	0	Immediately		Tuning	
Pn135	Gain Switching Waiting Time 1					Position	Classification
	Setting Range	Setting Unit	Factory Setting	When Enabled			
	0 to 65535	1 ms	0	Immediately		Tuning	
Pn136	Gain Switching Waiting Time 2					Position	Classification
	Setting Range	Setting Unit	Factory Setting	When Enabled			
	0 to 65535	1 ms	0	Immediately		Tuning	

(6) Related Monitor

Monitor No. (Un)	Name	Value	Remarks
Un014	Effective gain monitor	1	For gain setting 1
		2	For gain setting 2

Note: When using the tuning-less function, gain setting 1 is enabled.

Parameter No.	Analog Monitor	Name	Output Value	Remarks
Pn006 Pn007	n.□□0B	Effective gain monitor	1 V	Gain setting 1 is enabled.
			2 V	Gain setting 2 is enabled.

5.8.2 Manual Adjustment of Friction Compensation

Friction compensation rectifies the viscous friction change and regular load change.

The friction compensation function can be automatically adjusted with advanced autotuning (Fn201), advanced autotuning by reference input (Fn202), or one-parameter tuning (Fn203). This section describes the steps to follow if manual adjustment is required.

(1) Required Parameter Settings

The following parameter settings are required to use friction compensation.

Parameter		Function		When Enabled	Classification
Pn408	n.0□□□ [Factory setting]	Does not use friction compensation.		Immediately	Setup
	n.1□□□	Uses friction compensation.			
Pn121	Friction Compensation Gain			<input type="checkbox"/> Speed <input type="checkbox"/> Position	Classification
	Setting Range	Setting Unit	Factory Setting	When Enabled	
	10 to 1000	1%	100	Immediately	Tuning
Pn123	Friction Compensation Coefficient			<input type="checkbox"/> Speed <input type="checkbox"/> Position	Classification
	Setting Range	Setting Unit	Factory Setting	When Enabled	
	0 to 100	1%	0	Immediately	Tuning
Pn124	Friction Compensation Frequency Correction			<input type="checkbox"/> Speed <input type="checkbox"/> Position	Classification
	Setting Range	Setting Unit	Factory Setting	When Enabled	
	-10000 to 10000	0.1 Hz	0	Immediately	Tuning
Pn125	Friction Compensation Gain Correction			<input type="checkbox"/> Speed <input type="checkbox"/> Position	Classification
	Setting Range	Setting Unit	Factory Setting	When Enabled	
	1 to 1000	1%	100	Immediately	Tuning

(2) Operating Procedure for Friction Compensation

The following procedure is used for friction compensation.

CAUTION

- Before using friction compensation, set the moment of inertia ratio (Pn103) as accurately as possible. If the wrong moment of inertia ratio is set, vibration may result.

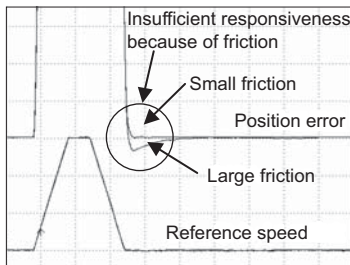
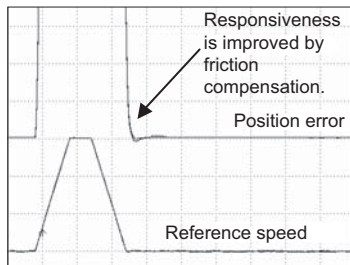
Step	Operation
1	<p>Set the following parameters for friction compensation to the factory setting as follows.</p> <p>Friction compensation gain (Pn121): 100 Friction compensation coefficient (Pn123): 0 Friction compensation frequency correction (Pn124): 0 Friction compensation gain correction (Pn125): 100</p> <p>Note: Always use the factory-set values for friction compensation frequency correction (Pn124) and friction compensation gain correction (Pn125).</p>
2	<p>To check the effect of friction compensation, gradually increase the friction compensation coefficient (Pn123). Note: Usually, set the friction compensation coefficient value to 95% or less. If the effect is insufficient, increase the friction compensation gain (Pn121) by 10% increments until it stops vibrating.</p> <p>Effect of Parameters for Adjustment</p> <p>Pn121: Friction Compensation Gain This parameter sets the responsiveness for external disturbance. The higher the set value is, the better the responsiveness will be. If the equipment has a resonance frequency, however, vibration may result if the set value is excessively high.</p> <p>Pn123: Friction Compensation Coefficient This parameter sets the effect of friction compensation. The higher the set value is, the more effective friction compensation will be. If the set value is excessively high, however, the vibration will occur easily. Usually, set the value to 95% or less.</p>
3	<p>Effect of Adjustment</p> <p>The following graph shows the responsiveness with and without proper adjustment.</p> <div style="display: flex; justify-content: space-around; align-items: flex-start;"> <div style="text-align: center;">  <p>Without friction compensation</p> </div> <div style="text-align: center;">  <p>With friction compensation</p> </div> </div>

5.8.3 Current Control Mode Selection Function

This function reduces high-frequency noises while the servomotor is being stopped. This function is enabled by default and set to be effective under different application conditions. Set Pn009.1 = 1 to use this function.

Parameter	Meaning	When Enabled	Classification
Pn009	n. □□0□	After restart	Tuning
	n. □□1□ [Factory setting]		



IMPORTANT

- If current control mode 2 is selected, the load ratio may increase while the servomotor is being stopped.

5.8.4 Current Gain Level Setting

This function reduces noises by adjusting the parameter value for current control inside the SERVOPACK according to the speed loop gain (Pn100). The noise level can be reduced by reducing the current gain level (Pn13D) from its factory setting of 2000% (disabled). If the set value of Pn13D is decreased, the level of noise will be lowered, but the response characteristics of the SERVOPACK will also be degraded. Adjust the current gain level within the allowable range at which SERVOPACK response characteristics can be secured.

Pn13D	Current Gain Level				Classification
	Setting Range	Setting Unit	Factory Setting	When Enabled	
	100 to 2000	1%	2000	Immediately	Tuning



IMPORTANT

- If the parameter setting of the current gain level is changed, the responses characteristics of the speed loop will also change. The SERVOPACK must, therefore, be readjusted again.

5.8.5 Speed Detection Method Selection

This function can ensure smooth movement of the servomotor while the servomotor is running. Set the value of Pn009.2 to 1 and select speed detection 2 to smooth the movement of the servomotor while the servomotor is running.

Parameter	Meaning	When Enabled	Classification
Pn009	n. □0□□ [Factory setting]	After restart	Tuning
	n. □1□□		



IMPORTANT

- If the speed detection method is changed, the response characteristics of the speed loop will change and the SERVOPACK must be readjusted again.

5.8.6 Backlash Compensation Function

(1) Overview

When driving a machine with backlash, there will be a deviation between the travel distance in the position reference that is managed by the host controller and the travel distance of the actual machine. Use backlash compensation function to add the backlash compensation value to the position reference and use the result to drive the servomotor. This means that the travel distance of the actual machine will be the same as the travel distance in the host controller.

- Note 1. This function is supported only for position control.
- Note 2. Software version 0023 or higher is required to use this function. The software version can be confirmed in Fn012. For details, refer to 6.14 Software Version Display (Fn012).

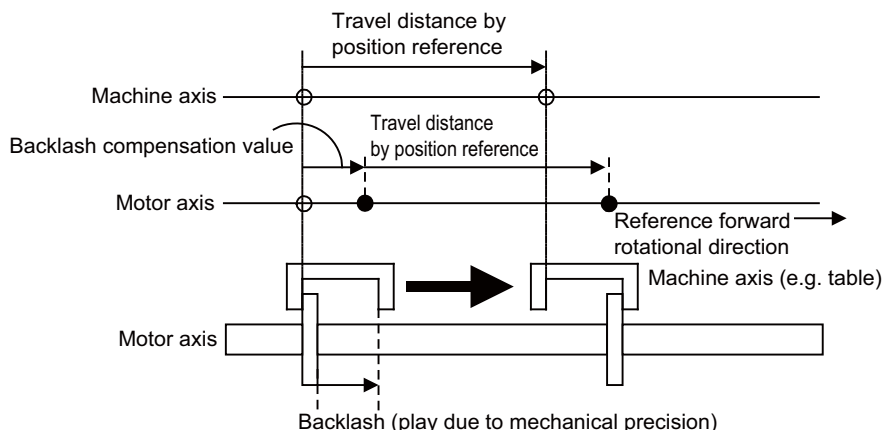

(2) Related Parameter

Set the following parameter to use backlash compensation.

■ Backlash Compensation Direction

Set the direction in which to apply backlash compensation.

Parameter	Function	When Enabled	Classification
Pn230	n. □□□0 [Factory setting]	After restart	Setup
	n. □□□1		

■ Backlash Compensation Value

Set the amount of backlash compensation to add to the position reference. The amount is set in increments of 0.1 reference unit. However, when the amount is converted to encoder pulses, it is rounded off at the decimal point.

Example: If Pn231 is set to 6,553.6 [reference unit] and the electronic gear ratio (Pn20E/Pn210) is set to 4/1, then the pulse equivalent is $6,553.6 \times 4 = 26,214.4$ [pulses].
 ⇒The backlash compensation value will be 26,214 encoder pulses.

Pn231	Backlash compensation value				Classification
	Setting Range	Setting Unit	Factory Setting	When Enabled	
	-500000 to +500000	0.1 reference unit	0	Immediately	Setup



IMPORTANT

- The backlash compensation value is restricted by the following formula. The specified compensation is not performed if this condition is not met.

$$Pn231 \leq \frac{Pn210}{Pn20E} \times \frac{\text{Maximum motor speed [min}^{-1}\text{]}}{60} \times \text{Encoder resolution}^* \times 0.00025$$

* For details, refer to 4.4.3 *Electronic Gear*.

Example:

If Pn20E is set to 4, Pn210 is set to 1, the maximum motor speed is 6,000 [min⁻¹], and the encoder resolution is 131,072 (17 bits),

$$1/4 \times 6000/60 \times 131072 \times 0.00025 = 819.2 \text{ [reference units]}$$

⇒ Therefore, the maximum backlash compensation value is 819.2 reference units.

- Do not exceed the upper limit of the backlash compensation value. The upper limit of the backlash compensation value can be confirmed in Un031.

■ Backlash Compensation Time Constant

Set a time constant for a first order lag filter to use when adding the backlash compensation value (Pn231) to the position reference.

If you set Pn233 to 0, the first order lag filter is disabled.

Pn233	Backlash compensation time constant				Classification
	Setting Range	Setting Unit	Position		
			Factory Setting	When Enabled	
	0 to 65535	0.01 ms	0	Immediately	Setup

Note: Changes to the set value are applied when there is no position reference input and the servomotor is stopped. The current operation is not affected if the set value is changed during servomotor operation.

(3) Related Monitor

The following monitoring parameters provide information on backlash compensation.

Un No.	Displayed Information	Unit
Un030	The current backlash compensation value	0.1 reference unit
Un031	Backlash compensation setting limit value	0.1 reference unit

(4) Compensation Operation

This section describes the operation that is performed for backlash compensation.

Note: The following figures are for when backlash compensation is applied for references in the forward direction (Pn230.0 = 0). The following monitoring information is provided in the figures: TPOS (target position in the reference coordinate system), POS (reference position in the reference coordinate system), and APOS (feedback position in the machine coordinate system). The monitoring information includes the feedback position in machine coordinate system (APOS) and other feedback information. The backlash compensation value is subtracted from the feedback positions in the monitoring information, so it is not necessary for the host controller to consider the backlash compensation value.

CAUTION

- The encoder dividing pulse output will output the number of encoder pulses for which driving was actually performed, including the backlash compensation value. If using the encoder dividing pulse output for position feedback at the host controller, must consider the backlash compensation value.

■ When Servo is ON

The backlash compensation value (Pn231) is added in the compensation direction when the servo is ON (i.e., the servomotor is powered) and a reference is input in the same direction as the backlash compensation direction (Pn230.0). If there is a reference input in the direction opposite to the backlash compensation direction, the backlash compensation value is not added (i.e., backlash compensation is not performed).

The relationship between APOS and the servomotor shaft position is as follows:

- If a reference is input in the compensation direction: $APOS = \text{Motor shaft position} - Pn231$
- If a reference is input in the direction opposite to the compensation direction: $APOS = \text{Motor shaft position}$

The following figure shows driving the servomotor in the forward direction from target position TPOS0 to TPOS1 and then to TPOS2, and then returning from TPOS2 to TPOS1 and then to TPOS0.

Backlash compensation is applied when moving from TPOS0 to TPOS1, but not when moving from TPOS2 to TPOS1.

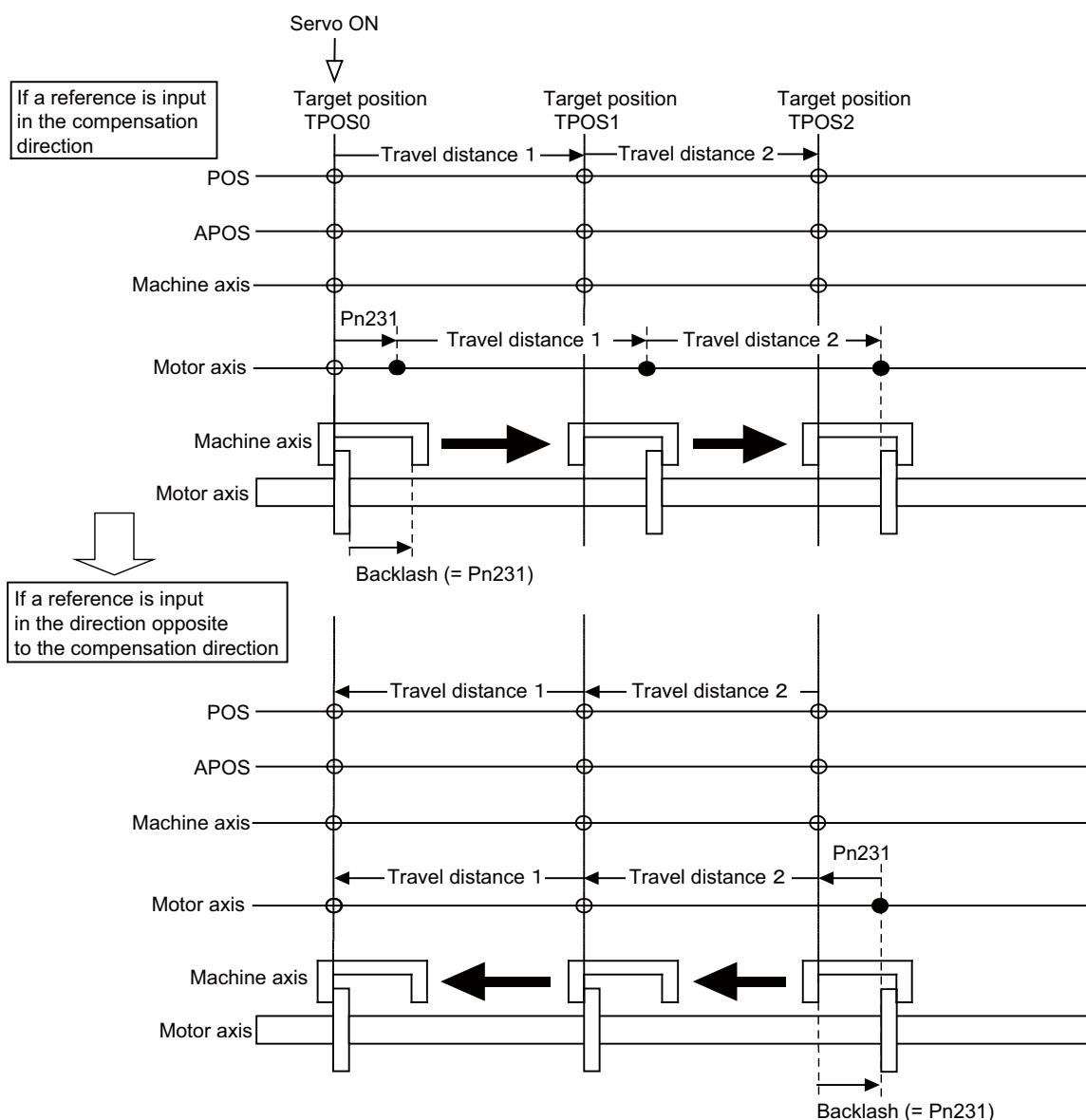

■ When Servo is OFF

Backlash compensation is not applied when the servo is OFF (i.e., when the servomotor is not powered). Therefore, the reference position POS moves by only the backlash compensation value.

The relationship between APOS and the servomotor shaft position is as follows:

- When servo is OFF: APOS = Servomotor shaft position

The following figure shows what happens when the servo is turned OFF after driving the servomotor in the forward direction from target position TPOS0 to TPOS1. Backlash compensation is not applied when the servo is OFF (i.e., the SERVOPACK manages the position data so that APOS and POS are the same).

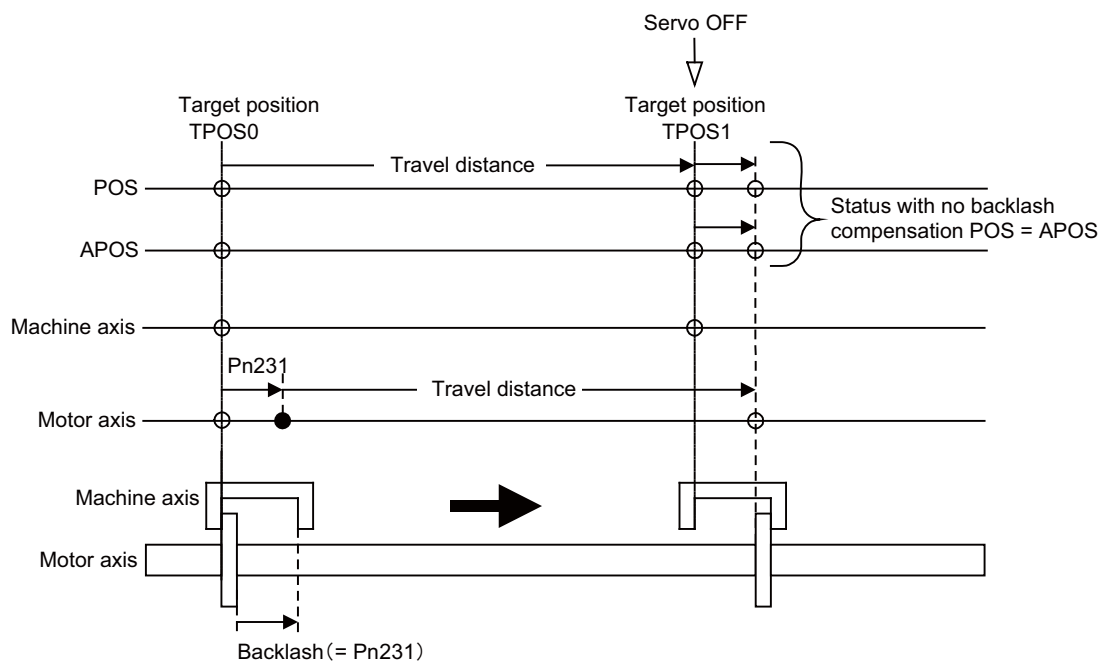

■ When There is Overtravel

When there is overtravel (i.e., when driving is prohibited due to an overtravel signal or software limit), the operation is the same as for ■ *When Servo is OFF*, i.e., backlash compensation is not applied.

■ When Control is Changed

Backlash compensation is performed only for position control.

Backlash compensation is not applied if changing from position control to any other type of control.

Backlash compensation is applied in the same way as ■ *When Servo is ON* if changing from any other type of control to position control.

(5) Monitor Functions (Un Monitoring)

Un No.	Displayed Information	Unit	Specification
Un007	Input reference speed	min ⁻¹	Indicates the input reference speed before backlash compensation.
Un008	Position error amount	Reference unit	Displays the position error with respect to the position reference after backlash compensation.
Un00C	Input reference counter	Reference unit	Displays the input reference counter before backlash compensation.
Un00D	Feedback pulse counter	Encoder pulse	Displays the pulse count of the actually driven motor encoder.
Un013	Feedback pulse counter	Reference unit	Displays the pulse count of the actually driven encoder in reference units.

(6) MECHATROLINK Monitor Information

This section describes the information that is set for the MECHATROLINK monitoring information (Monitor 1, Monitor 2, Monitor 3, and Monitor 4) and the backlash compensation operation.

Monitor Code	Designation	Meaning	Unit	Remarks
0	POS	Reference position in the reference coordinate system (after the position reference filter)	Reference unit	–
1	MPOS	Reference position	Reference unit	–
2	PERR	Position error	Reference unit	–
3	APOS	Feedback position in the machine coordinate system	Reference unit	Feedback position with the backlash compensation subtracted
4	LPOS	Feedback latch position in the machine coordinate system	Reference unit	Feedback position with the backlash compensation subtracted
5	IPOS	Reference position in the reference coordinate system (before the position reference filter)	Reference unit	–
6	TPOS	Target position in the reference coordinate system	Reference unit	–
E	OMN1	Option monitor 1 (selected with Pn824)	–	–
F	OMN2	Option monitor 2 (selected with Pn825)	–	–

Parameters	Monitor Information	Output Unit	Remarks	
Pn824 Pn825	0003H	Position error (lower 32 bits)	Reference unit	–
	0004H	Position error (upper 32 bits)	Reference unit	–
	000AH	Encoder count (lower 32 bits)	Reference unit	Count value of the actually driven motor encoder
	000BH	Encoder count (upper 32 bits)	Reference unit	
	000CH	Reserved	–	–
	000DH			
	0017H	Un007: Input reference speed	min ⁻¹	Same as monitor mode Un007
	0018H	Un008: Position error amount	Reference unit	Same as monitor mode Un008
	001CH	Un00C: Input reference counter	Reference unit	Same as monitor mode Un00C
	001DH	Un00D: Feedback pulse counter	Encoder pulse	Same as monitor mode Un00D
	0080H	Previous value of latched feedback position (LPOS)	Encoder pulse	Feedback position with the backlash compensation subtracted

■ Related Monitoring Diagrams

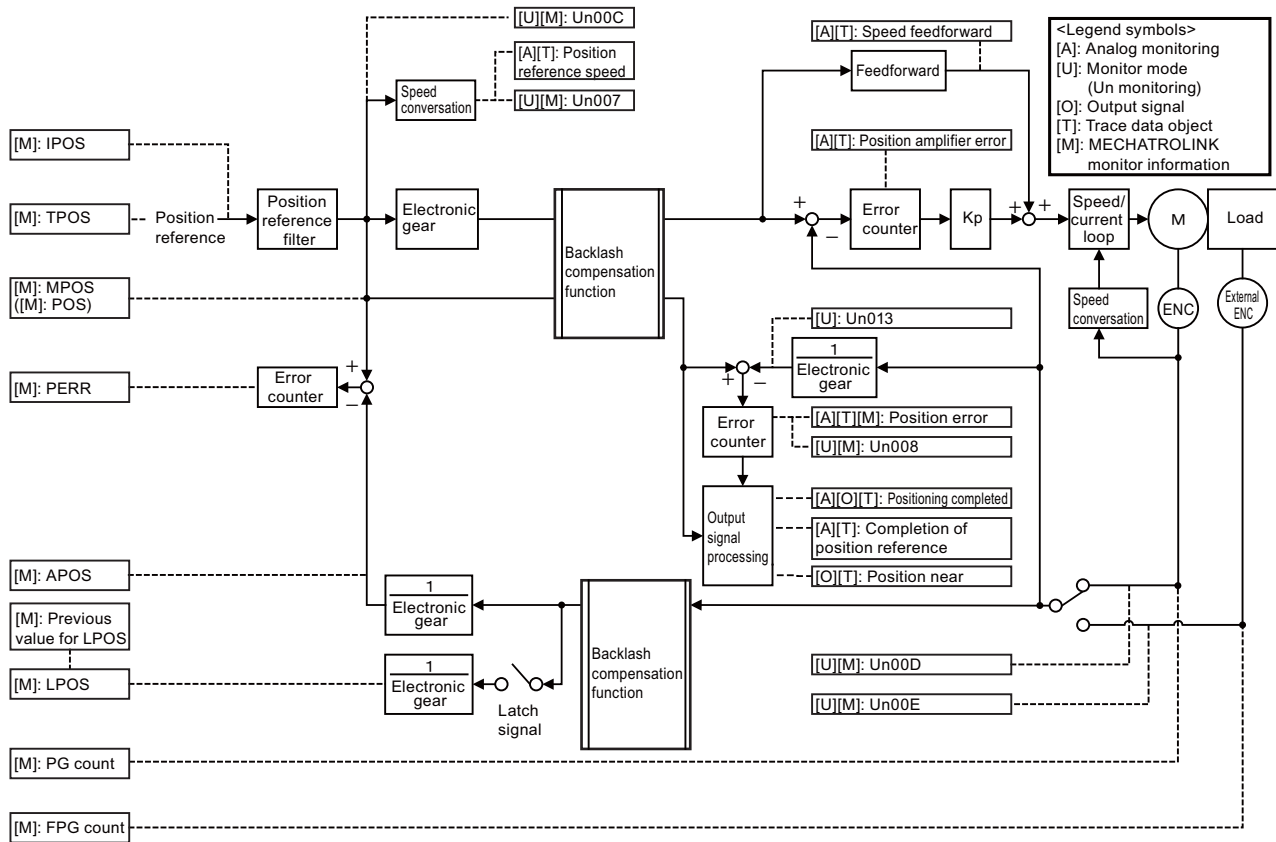

5.9 Compatible Adjustment Function

The DC Power Input Σ -V series SERVOPACKs have adjustment functions as explained in sections 5.1 to 5.8 to make machine adjustments.

This section explains compatible functions provided by earlier models, such as the Σ -III Series SERVOPACK.

5.9.1 Feedforward Reference

This function applies feedforward compensation to position control and shortens positioning time.

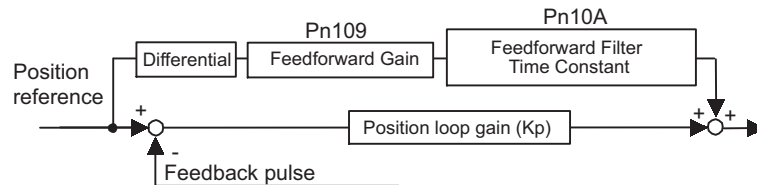

Pn109	Feedforward Gain Position				Classification
	Setting Range	Setting Unit	Factory Setting	When Enabled	
	0 to 100	1%	0	Immediately	Tuning
Pn10A	Feedforward Filter Time Constant Position				Classification
	Setting Range	Setting Unit	Factory Setting	When Enabled	
	0 to 6400	0.01 ms	0	Immediately	Tuning

Note: Too high value may cause the machine to vibrate. For ordinary machines, set 80% or less in this parameter.

5.9.2 Mode Switch (P/PI Switching)

The mode switch automatically switches between proportional and PI control. Set the switching condition with Pn10B.0 and set the level of detection points with Pn10C, Pn10D, Pn10E, and Pn10F.

Overshooting caused by acceleration and deceleration can be suppressed and the settling time can be reduced by setting the switching condition and detection points.

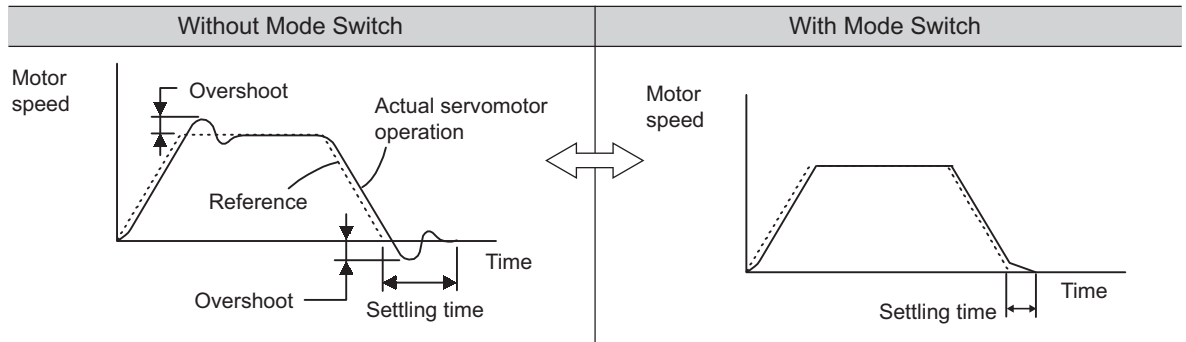

(1) Related Parameters

Select the switching condition of the mode switch with Pn10B.0.

Parameter	Mode Switch Selection	Parameter Containing Detection Point Setting	When Enabled	Classification
Pn10B	n.□□□0 [Factory setting]	Uses an internal torque reference level for the switching conditions.	Pn10C	Immediately Setup
	n.□□□1	Uses a speed reference level for the switching conditions.	Pn10D	
	n.□□□2	Uses an acceleration level for the switching conditions.	Pn10E	
	n.□□□3	Uses a position error level for the switching conditions.	Pn10F	
	n.□□□4	Does not use mode switch function.	–	

■ Parameters to Set the Level of Detection Points

Pn10C	Mode Switch (Torque Reference) [Speed] [Position]				Classification
	Setting Range	Setting Unit	Factory Setting	When Enabled	
	0 to 800	1%	200	Immediately	Tuning
Pn10D	Mode Switch (Speed Reference) [Speed] [Position]				Classification
	Setting Range	Setting Unit	Factory Setting	When Enabled	
	0 to 10000	1 min ⁻¹	0	Immediately	Tuning
Pn10E	Mode Switch (Acceleration) [Speed] [Position]				Classification
	Setting Range	Setting Unit	Factory Setting	When Enabled	
	0 to 30000	1 min ⁻¹ /s	0	Immediately	Tuning
Pn10F	Mode Switch (Position Error) [Position]				Classification
	Setting Range	Setting Unit	Factory Setting	When Enabled	
	0 to 10000	1 reference unit	0	Immediately	Tuning

(2) Operating Examples for Different Switching Conditions

■ Using the Torque Reference [Factory Setting]

With this setting, the speed loop is switched to P control when the value of torque reference input exceeds the torque set in Pn10C. The factory setting for the torque reference detection point is 200% of the rated torque.

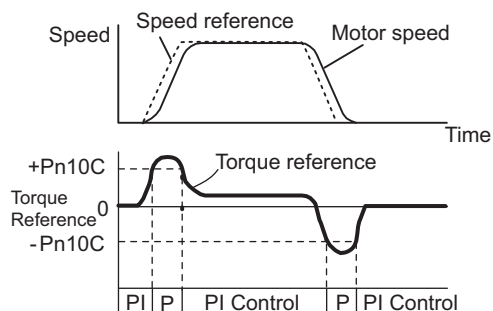

■ Using the Speed Reference

With this setting, the speed loop is switched to P control when the value of speed reference input exceeds the speed set in Pn10D.

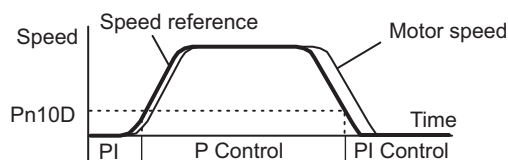

■ Using Acceleration

With this setting, the speed loop is switched to P control when the speed reference exceeds the acceleration set in Pn10E.

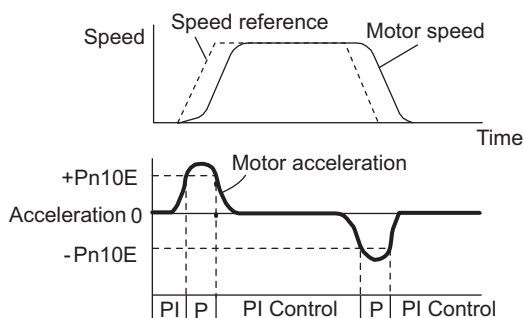

■ Using the Position Error

With this setting, the speed loop is switched to P control when the position error exceeds the value set in Pn10F.

This setting is effective with position control only.

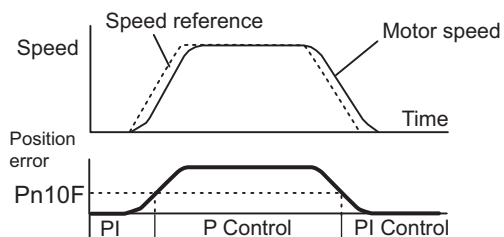

5.9.3 Torque Reference Filter

As shown in the following diagram, the torque reference filter contains first order lag filter and notch filters arrayed in series, and each filter operates independently. The notch filters can be enabled and disabled with the Pn408.

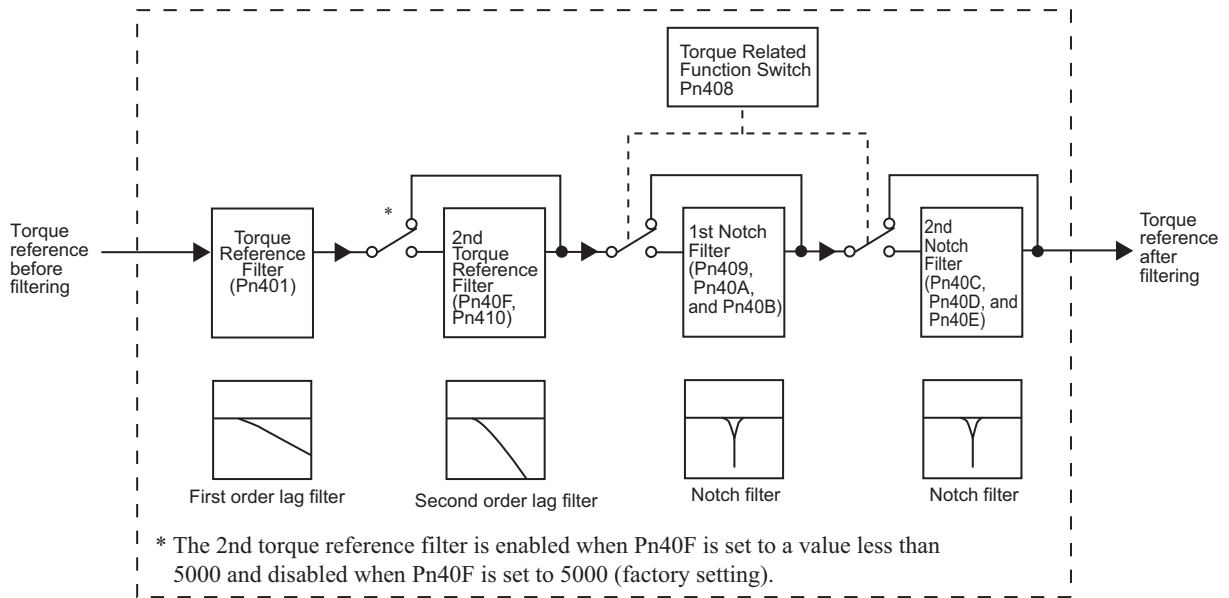

(1) Torque Reference Filter

If you suspect that machine vibration is being caused by the servo drive, try adjusting the filter time constants with Pn401. This may stop the vibration. The lower the value, the better the response will be, but there may be a limit that depends on the machine conditions.

Pn401	Torque Reference Filter Time Constant		<input type="checkbox"/> Speed	<input type="checkbox"/> Position	<input type="checkbox"/> Torque	Classification
	Setting Range	Setting Unit	Factory Setting	When Enabled		
	0 to 65535	0.01 ms	100	Immediately		Tuning

■ Torque Reference Filter Setting Guide

Use the speed loop gain (Pn100 [Hz]) and the torque filter time constant (Pn401 [ms]) to set the torque reference filter.

Adjusted value for stable control: $Pn401 [ms] \leq 1000 / (2\pi \times Pn100 [Hz] \times 4)$

Critical gains: $Pn401 [ms] < 1000 / (2\pi \times Pn100 [Hz] \times 1)$

Pn40F	2nd Step 2nd Torque Reference Filter Frequency		<input type="checkbox"/> Speed	<input type="checkbox"/> Position	<input type="checkbox"/> Torque	Classification
	Setting Range	Setting Unit	Factory Setting	When Enabled		
	100 to 5000	1 Hz	5000*	Immediately		Tuning
Pn410	2nd Step 2nd Torque Reference Filter Q Value		<input type="checkbox"/> Speed	<input type="checkbox"/> Position	<input type="checkbox"/> Torque	Classification
	Setting Range	Setting Unit	Factory Setting	When Enabled		
	50 to 100	0.01	50	Immediately		Tuning

* The filter is disabled if 5000 is set.

(2) Notch Filter

The notch filter can eliminate specific frequency elements generated by the vibration of sources such as resonance of the shaft of a ball screw. The notch filter puts a notch in the gain curve at the specific vibration frequency. The frequency characteristics near the notch can be reduced or removed with this filter. A higher Q value produces a sharper notch and phase delay.

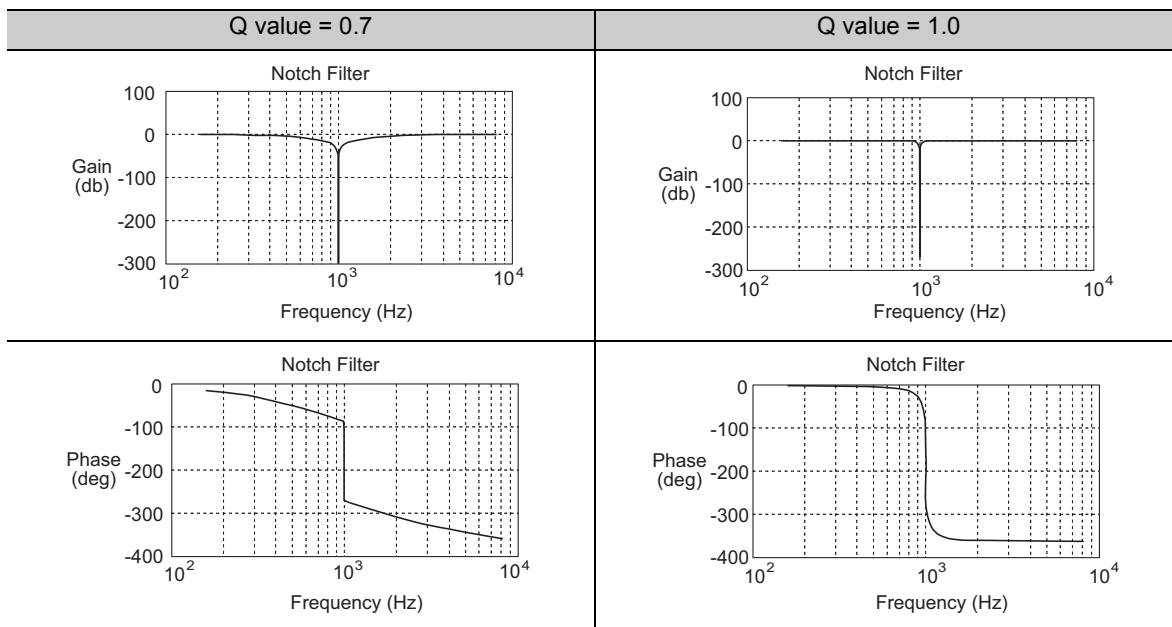

The notch filter can be enabled or disabled with Pn408.

Parameter	Meaning	When Enabled	Classification	
Pn408	n.□□□0 [Factory setting]	Disables 1st notch filter.	Immediately	Setup
	n.□□□1	Enables 1st notch filter.		
	n.□0□□ [Factory setting]	Disables 2nd notch filter.		
	n.□1□□	Enables 2nd notch filter.		

Set the machine's vibration frequency as a parameter of the notch filter.

Pn409	1st Notch Filter Frequency				Speed	Position	Torque	Classification
	Setting Range	Setting Unit	Factory Setting	When Enabled				
	50 to 5000	1 Hz	5000	Immediately				Tuning
Pn40A	1st Notch Filter Q Value				Speed	Position	Torque	Classification
	Setting Range	Setting Unit	Factory Setting	When Enabled				
	50 to 1000	0.01	70	Immediately				Tuning
Pn40B	1st Notch Filter Depth				Speed	Position	Torque	Classification
	Setting Range	Setting Unit	Factory Setting	When Enabled				
	0 to 1000	0.001	0	Immediately				Tuning
Pn40C	2nd Notch Filter Frequency				Speed	Position	Torque	Classification
	Setting Range	Setting Unit	Factory Setting	When Enabled				
	50 to 5000	1 Hz	5000	Immediately				Tuning
Pn40D	2nd Notch Filter Q Value				Speed	Position	Torque	Classification
	Setting Range	Setting Unit	Factory Setting	When Enabled				
	50 to 1000	0.01	70	Immediately				Tuning

(cont'd)

Pn40E	2nd Notch Filter Depth				Classification
	Setting Range	Setting Unit	Factory Setting	When Enabled	
	0 to 1000	0.001	0	Immediately	Tuning

**IMPORTANT**

- Sufficient precautions must be taken when setting the notch filter frequencies. Do not set the notch filter frequencies (Pn409 or Pn40C) that is close to the speed loop's response frequency. Set the frequencies at least four times higher than the speed loop's response frequency. Setting the notch filter frequency too close to the response frequency may cause vibration and damage the machine.
- Change the notch filter frequencies (Pn409 or Pn40C) only when the servomotor is stopped. Vibration may occur if the notch filter frequency is changed when the servomotor is rotating.

5.9.4 Position Integral

The position integral is the integral function of the position loop. It is used for the electronic cams and electronic shafts when using the SERVOPACK with YASKAWA MP900/2000 Machine Controllers.

Pn11F	Position Integral Time Constant				Classification
	Setting Range	Setting Unit	Factory Setting	When Enabled	
	0 to 50000	0.1 ms	0	Immediately	Tuning

Utility Functions (Fn□□□)

6.1 List of Utility Functions	6-2
6.2 Alarm History Display (Fn000)	6-3
6.3 JOG Operation (Fn002)	6-4
6.4 Origin Search (Fn003)	6-6
6.5 Program JOG Operation (Fn004)	6-9
6.6 Initializing Parameter Settings (Fn005)	6-16
6.7 Clearing Alarm History (Fn006)	6-19
6.8 Offset Adjustment of Analog Monitor Output (Fn00C)	6-20
6.9 Gain Adjustment of Analog Monitor Output (Fn00D)	6-22
6.10 Automatic Offset-Signal Adjustment of the Motor Current Detection Signal (Fn00E)	6-24
6.11 Manual Offset-Signal Adjustment of the Motor Current Detection Signal (Fn00F)	6-26
6.12 Write Prohibited Setting (Fn010)	6-28
6.13 Servomotor Model Display (Fn011)	6-30
6.14 Software Version Display (Fn012)	6-31
6.15 Vibration Detection Level Initialization (Fn01B)	6-32
6.16 Display of SERVOPACK and Servomotor ID (Fn01E)	6-35
6.17 Software Reset (Fn030)	6-36
6.18 EasyFFT (Fn206)	6-41
6.19 Online Vibration Monitor (Fn207)	6-45

6.1 List of Utility Functions

Utility functions are used to execute the functions related to servomotor operation and adjustment. Each utility function has a number starting with Fn.

The following table lists the utility functions and reference section.

Function No.	Function	Reference Section	Comment: SigmaWin+ function names
Fn000	Alarm history display	6.2	Alarm Display
Fn002	JOG operation	6.3	JOG Operation
Fn003	Origin search	6.4	Origin Search
Fn004	Program JOG operation	6.5	Program JOG Operation
Fn005	Initializing parameter settings	6.6	Editing Parameters
Fn006	Clearing alarm history	6.7	Alarm Display
Fn008	Absolute encoder multiturn reset and encoder alarm reset	4.7.4	Setting the Absolute Encoder
Fn00C	Offset adjustment of analog monitor output	6.8	Adjusting Analog Monitor Output
Fn00D	Gain adjustment of analog monitor output	6.9	Adjusting Analog Monitor Output
Fn00E	Automatic offset-signal adjustment of the motor current detection signal	6.10	Adjusting Motor Current Detection Offset
Fn00F	Manual offset-signal adjustment of the motor current detection signal	6.11	Adjusting Motor Current Detection Offset
Fn010	Write prohibited setting	6.12	Write Prohibited Setting
Fn011	Servomotor model display	6.13	Product Information
Fn012	Software version display	6.14	Product Information
Fn013	Multiturn limit value setting change when a multiturn limit disagreement alarm occurs	4.7.6	Setting the Multi-Turn Limit
Fn01B	Vibration detection level initialization	6.15	Initializing Vibration Detection Level
Fn01E	Display of SERVOPACK and servomotor ID	6.16	Product Information
Fn030	Software reset	6.17	Resetting the SERVOPACK by Software or MECHATROLINK Communication Reset
Fn200	Tuning-less levels setting	5.2.2	Editing Parameters
Fn201	Advanced autotuning	5.3.2	Tuning
Fn202	Advanced autotuning by reference	5.4.2	Tuning
Fn203	One-parameter tuning	5.5.2	Tuning
Fn204	Anti-resonance control adjustment function	5.6.2	Tuning
Fn205	Vibration suppression function	5.7.2	Tuning
Fn206	EasyFFT	6.18	EasyFFT
Fn207	Online vibration monitor	6.19	Online Vibration Monitor

Note: Execute the utility function with SigmaWin+.

6.2 Alarm History Display (Fn000)

This function displays the last ten alarms that have occurred in the SERVOPACK.

(1) Preparation

There are no tasks that must be performed before displaying the alarm history.

(2) Operating Procedure

Use the following procedure.

1. In the SigmaWin+ main window, click **Alarm - Display Alarm**.

The **Alarm Display** dialog box will appear.

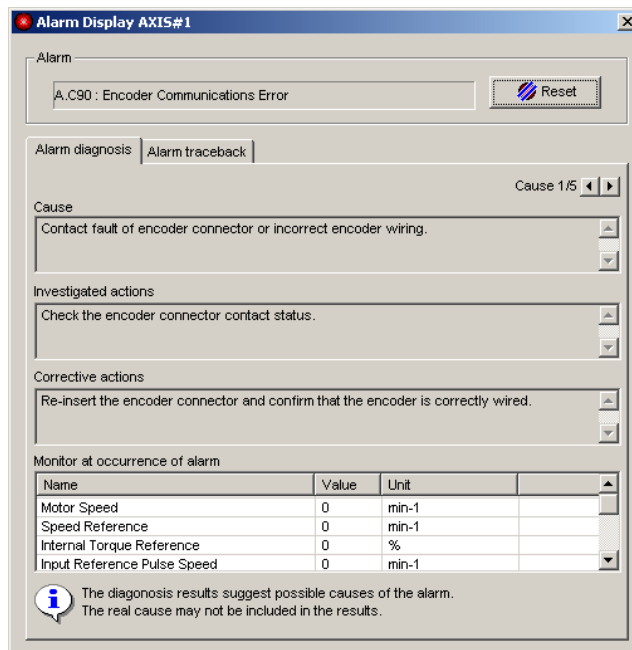

2. Click the **Alarm traceback** tab to view the alarm history.

A list of past alarms can be viewed.

No.	Name	Accumulated operation time
01	A.C90 : Encoder Communications Error	49:01:06.4
02	A.510 : Overspeed	49:00:36.7
03	Normal	0:00:00.0
04	Normal	0:00:00.0
05	Normal	0:00:00.0
06	Normal	0:00:00.0
07	Normal	0:00:00.0
08	Normal	0:00:00.0
09	Normal	0:00:00.0
10	Normal	0:00:00.0

Alarm number and Alarm name

Alarm history number
(The greater the number, the older the alarm is.)

Note:

- If the same alarm occurs after more than one hour, the alarm will be saved. If it occurs in less than one hour, it will not be saved.
- Delete the alarm history by clicking **Clear**. The alarm history is not cleared on alarm reset or when the SERVOPACK main circuit power is turned OFF.

6.3 JOG Operation (Fn002)

JOG operation is used to check the operation of the servomotor under speed control without connecting the SERVOPACK to the host controller.

 CAUTION
<ul style="list-style-type: none"> While the SERVOPACK is in JOG operation, the overtravel function will be disabled. Consider the operating range of the machine when performing JOG operation for the SERVOPACK.

(1) Preparation

The following conditions must be met to perform a jog operation.

- The write prohibited setting parameter (Fn010) must be set to Write permitted (P.0000).
- The main circuit power supply must be ON.
- All alarms must be cleared.
- The servomotor power must be OFF.
- The JOG speed must be set considering the operating range of the machine.
Set the jog speed in Pn304.

Pn304	Jog Speed				Speed	Position	Torque	Classification
	Setting Range	Setting Unit	Factory Setting	When Enabled				
	0 to 10000	1 min ⁻¹	500	Immediately		Setup		

(2) Operating Procedure

Use the following procedure. The following example is given when the rotating direction of servomotor is set as Pn000.0=0 (Forward rotation by forward reference).

1. In the SigmaWin+ main window, click **Test Run - JOG Operation**.

A warning message about possible dangers will appear and ask if you want to continue.

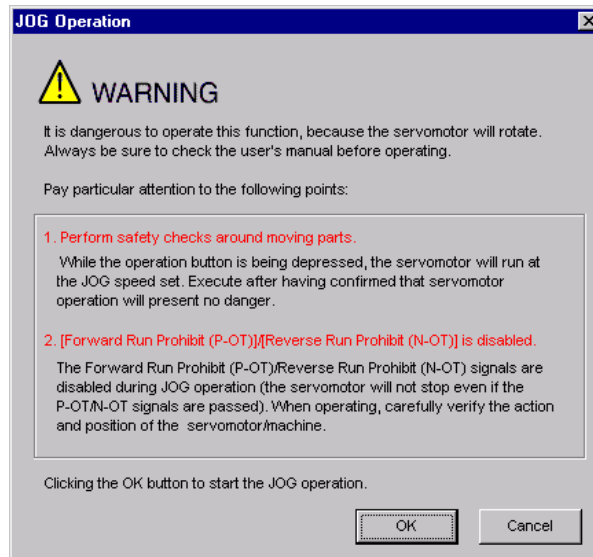

If these conditions are not acceptable and you do not want to continue, click **Cancel** to return to the main window without performing a JOG operation.

<When the Write Prohibited Setting Parameter (Fn010) is enabled.>

If writing is prohibited by the Fn010, the following message will appear and tell you to change the setting.

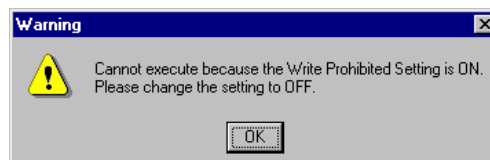

Click **OK** and then change the setting of the Fn010 to allow writing.
For details on how to change the setting, refer to 6.12 *Write Prohibited Setting (Fn010)*.

2. Click **OK.**

The **JOG Operation** box will appear.

If the power to the servomotor is on, an error message will appear. Make sure that the power to the servomotor is off.

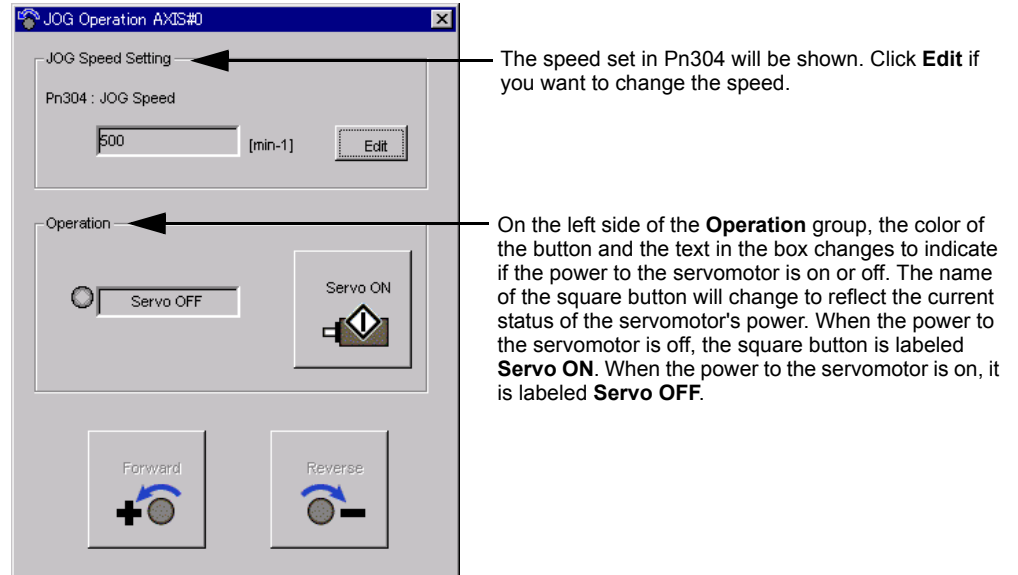

3. Click **Servo ON.**

The JOG Operation box will appear.

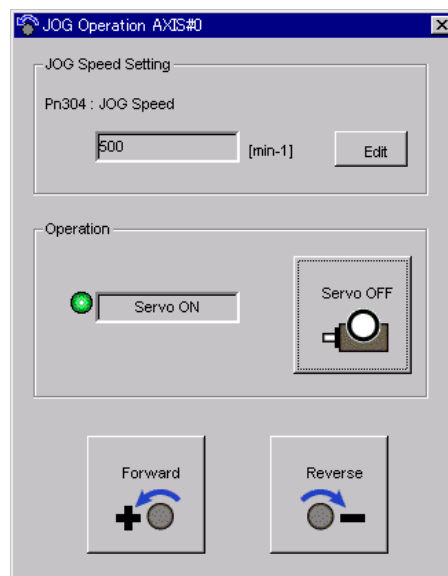

- 4. Press the **Forward** or **Reverse** and hold it down. A JOG operation is performed at the speed set at step 2 only while one of the buttons is pressed.**
- 5. After the JOG operation has been successfully completed, restart the SERVOPACK.**

6.4 Origin Search (Fn003)

The origin search is designed to position the origin pulse position of the incremental encoder (phase C) and to clamp at the position.

CAUTION

- Perform origin searches without connecting the coupling.
The forward run prohibited (P-OT) and reverse run prohibited (N-OT) signals are not effective in origin search mode.

This function is used when the motor shaft needs to be aligned to the machine.

Motor speed at the time of execution: 60 min⁻¹

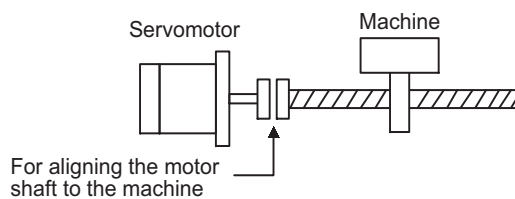

(1) Preparation

The following conditions must be met to perform the origin search.

- The write prohibited setting parameter (Fn010) must be set to Write permitted (P.0000).
- The main circuit power supply must be ON.
- All alarms must be cleared.
- The servomotor power must be OFF.

(2) Operating Procedure

Use the following procedure.

1. In the SigmaWin+ main window, click **Setup - Search Origin**.

A warning message about possible dangers will appear and ask if you want to continue.

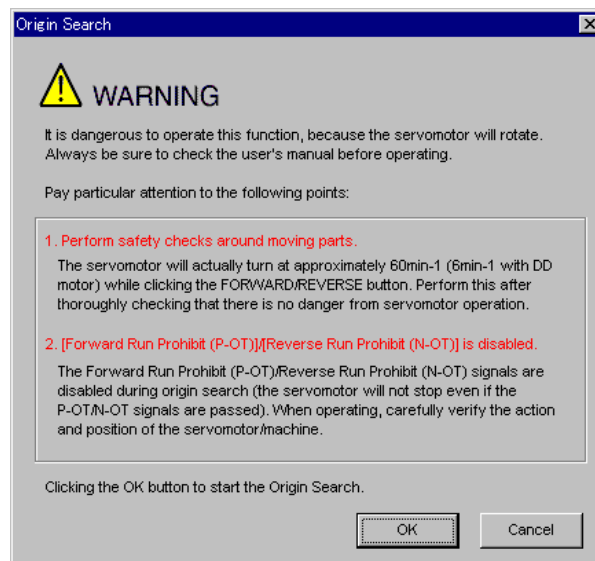

If these conditions are not acceptable and you do not want to continue, click **Cancel** to return to the main window without performing an origin search.

<When the Write Prohibited Setting Parameter (Fn010) is enabled.>

If writing is prohibited by the Fn010, the following message will appear and tell you to change the setting.

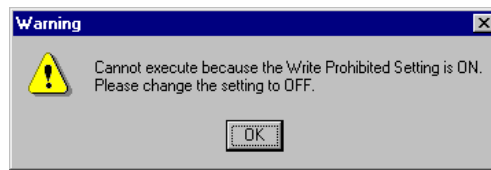

Click **OK** and then change the setting of the Fn010 to allow writing.

For details on how to change the setting, refer to 6.12 *Write Prohibited Setting (Fn010)*.

2. Click **OK**.

The **Origin Search** box will appear.

If the power to the servomotor is on, an error message will appear. Make sure that the power to the servomotor is off.

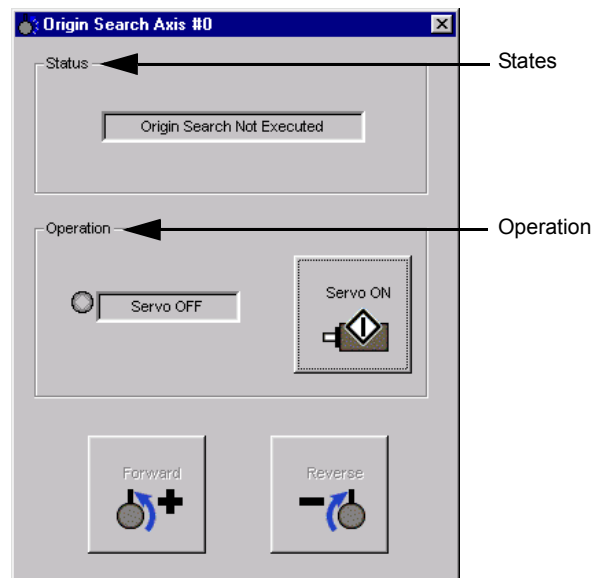

Status

This shows the run status of the servomotor.

Origin Search Not Executed: The motor did not turn.

Origin Search Executing: Searching for the origin by turning forward or in reverse.

Origin Search Stopped: The **Forward** or **Reverse** button was released during the origin search, so the motor stopped.

Origin Search Completed: The point of origin was found, and the motor was stopped (clamped) at the point.

Operation

On the left side of the **Operation** group, the color of the button and the text in the box changes to indicate if the power to the servomotor is on or off. The name of the square button will change to reflect the current status of the servomotor's power. When the power to the servomotor is off, the square button is labeled **Servo ON**. When the power to the servomotor is on, it is labeled **Servo OFF**.

3. Click **Servo ON**.
The **Origin Search** box will appear.

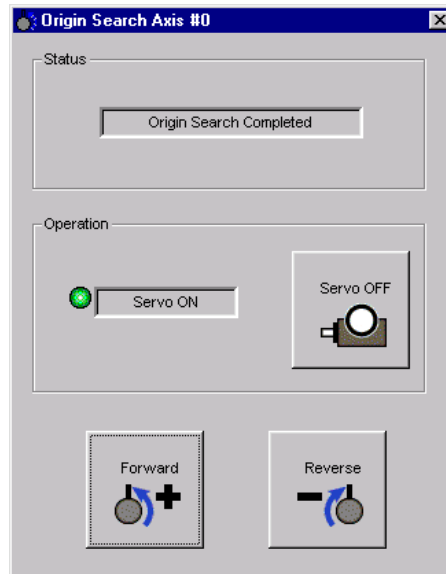

4. Press the **Forward** or **Reverse** and hold it down until the servomotor stops.
The servomotor will stop after the origin search has been successfully completed.
5. After the origin search has been successfully completed, restart the SERVOPACK.

6.5 Program JOG Operation (Fn004)

The program JOG operation is a utility function, that allows continuous operation determined by the preset operation pattern, movement distance, movement speed, acceleration/deceleration time, waiting time, and number of times of movement.

This function can be used to move the servomotor without it having to be connected to a host controller for the machine as a trial operation in JOG operation mode. Program JOG operation can be used to confirm the operation and for simple positioning operations.

(1) Preparation

The following conditions must be met to perform the program JOG operation.

- The write prohibited setting parameter (Fn010) must be set to Write permitted (P.0000).
- The main circuit power supply must be ON.
- All alarms must be cleared.
- The servomotor power must be OFF.
- The travel distance and speed must be set correctly considering the machine operation range and safe operation speed.
- There must be no overtravel.

(2) Additional Information

- The functions that are applicable for position control, such as position reference filter, can be used.
- The overtravel function is enabled in this function.

(3) Program JOG Operation Patterns

The following describes an example of program JOG operation pattern. The following example is given when the rotating direction of the servomotor is set as Pn000.0 = 0 (Forward rotation by forward reference).

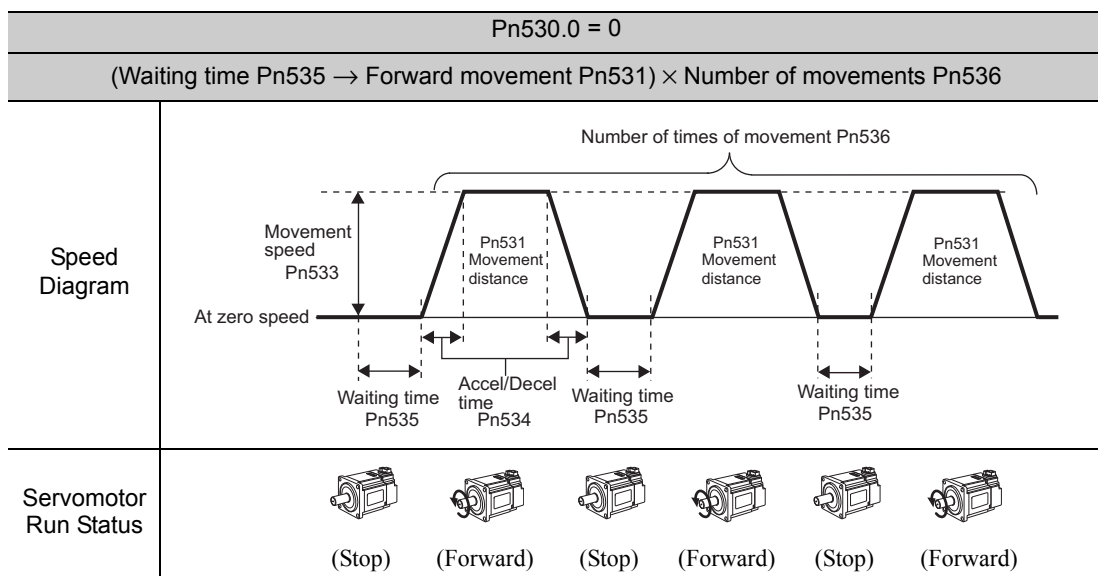

Note: When Pn536 (number of times of program JOG movement) is set to 0, infinite time operation is enabled. To stop infinite time operation, press the **cancel** or **Servo OFF** of program JOG operation dialog box to turn OFF the servomotor power.

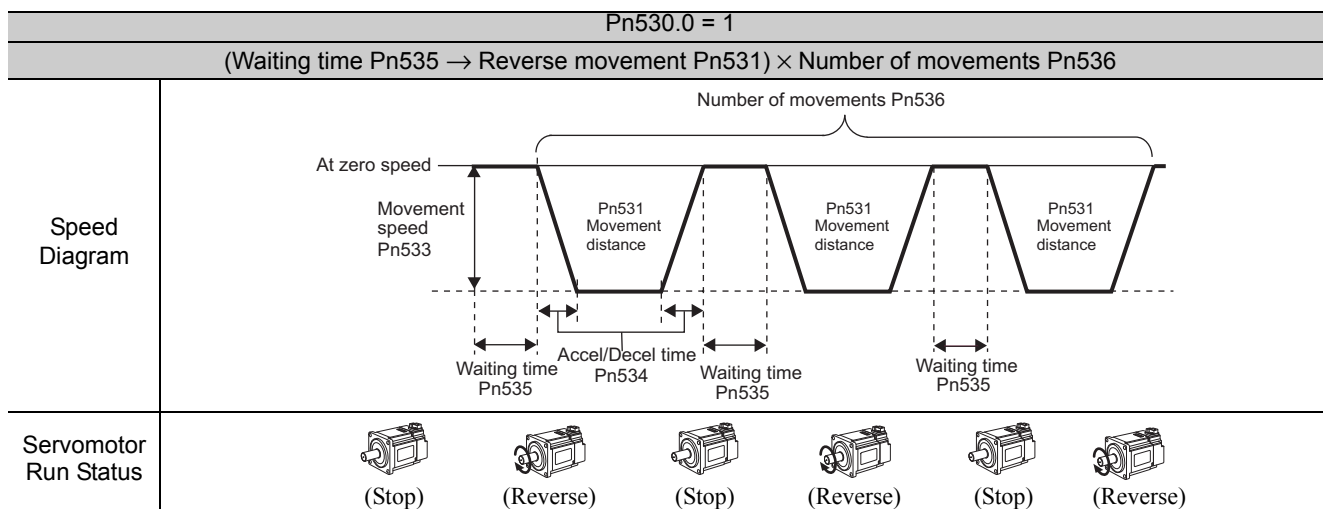

Note: When Pn536 (Number of Times of Program JOG Movement) is set to 0, infinite time operation is enabled. To stop infinite time operation, press the **cancel** or **Servo OFF** of program JOG operation dialog box to turn OFF the servomotor power.

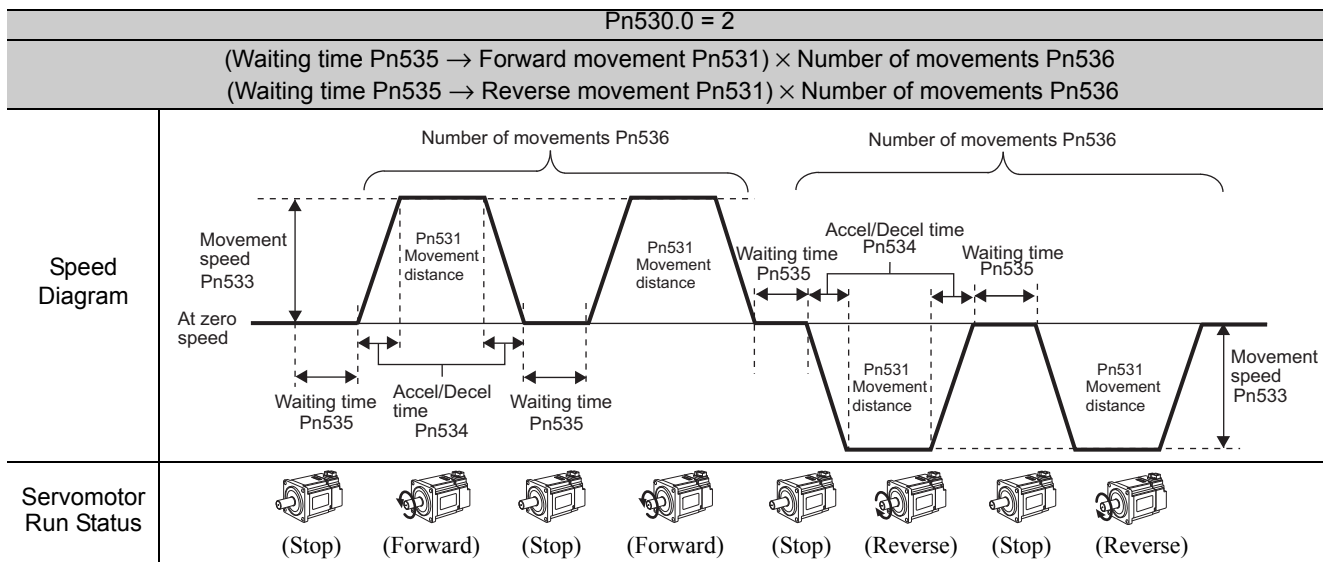

Note: When Pn530.0 is set to 2, infinite time operation is disabled.

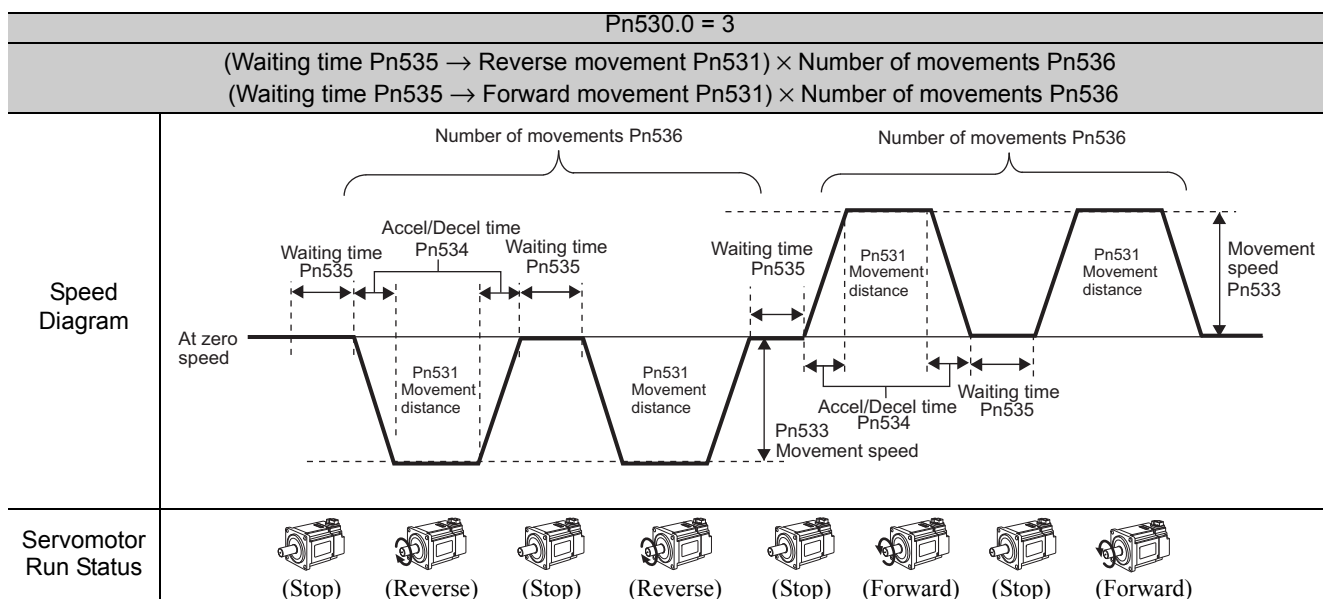

Note: When Pn530.0 is set to 3, infinite time operation is disabled.

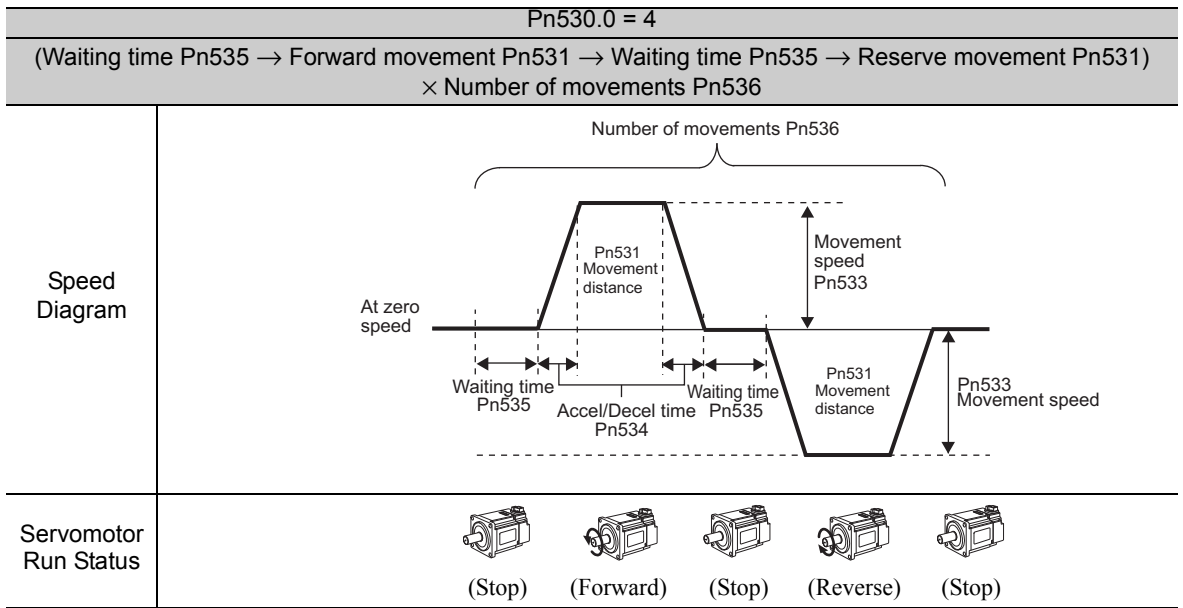

Note: When Pn536 (number of times of program JOG movement) is set to 0, infinite time operation is enabled. To stop infinite time operation, press the **cancel** or **Servo OFF** of program JOG operation dialog box to turn OFF the servomotor power.

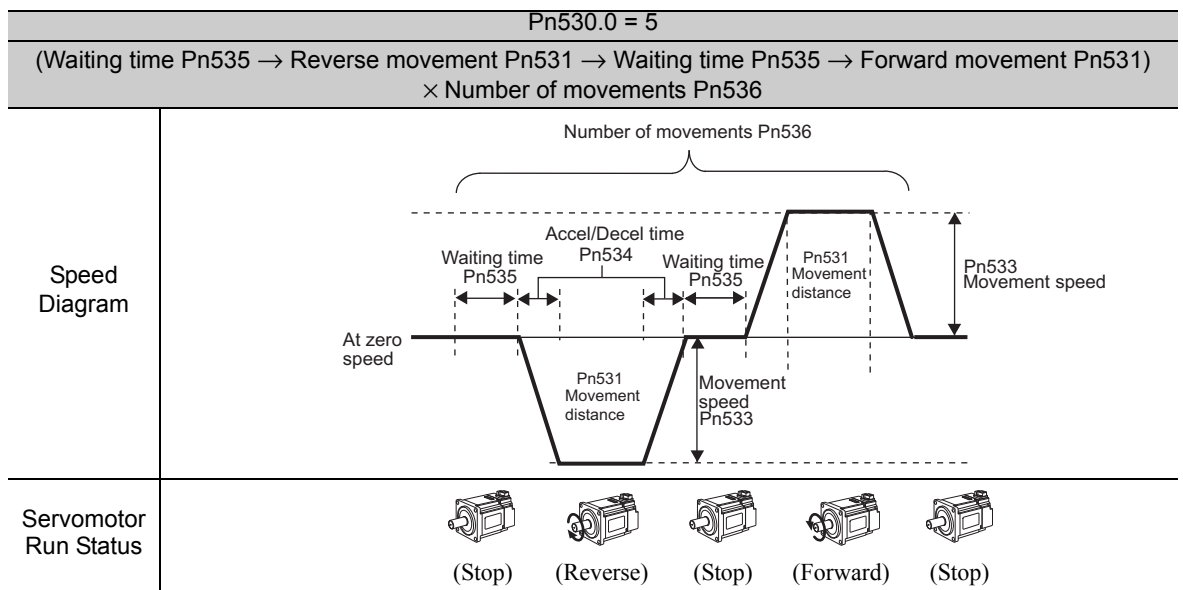

Note: When Pn536 (number of times of program JOG movement) is set to 0, infinite time operation is enabled. To stop infinite time operation, press the **cancel** or **Servo OFF** of program JOG operation dialog box to turn OFF the servomotor power.

(4) Related Parameters

The following parameters set the program JOG operation pattern. Do not change the settings while the program JOG operation is being executed.

Pn530	Program JOG Operation Related Switch [Speed] [Position] [Torque]				Classification
	Setting Range	Setting Unit	Factory Setting	When Enabled	
	0000 to 0005	–	0000	Immediately	Setup
Pn531	Program JOG Movement Distance [Speed] [Position] [Torque]				Classification
	Setting Range	Setting Unit	Factory Setting	When Enabled	
	1 to 1073741824	1 reference unit	32768	Immediately	Setup
Pn533	Program JOG Movement Speed [Speed] [Position] [Torque]				Classification
	Setting Range	Setting Unit	Factory Setting	When Enabled	
	1 to 10000	1 min ⁻¹	500	Immediately	Setup
Pn534	Program JOG Acceleration/Deceleration Time [Speed] [Position] [Torque]				Classification
	Setting Range	Setting Unit	Factory Setting	When Enabled	
	2 to 10000	1 ms	100	Immediately	Setup
Pn535	Program JOG Waiting Time [Speed] [Position] [Torque]				Classification
	Setting Range	Setting Unit	Factory Setting	When Enabled	
	0 to 10000	1 ms	100	Immediately	Setup
Pn536	Number of Times of Program JOG Movement [Speed] [Position] [Torque]				Classification
	Setting Range	Setting Unit	Factory Setting	When Enabled	
	0 to 1000	1 time	1	Immediately	Setup

(5) Operating Procedure

Use the following procedure to perform the program JOG operation after setting a program JOG operation pattern.

 CAUTION
<p>Two methods are available to interrupt a program JOG operation and stop the motor. The motor will stop according to the method selected. Make sure to select the best method for the situation.</p> <ul style="list-style-type: none"> • When using the Servo OFF button to turn off the power to the servomotor and stop the motor, the motor will coast to a stop. • When using the Cancel button to cancel the program JOG operation and stop the motor, the motor will decelerate to a stop and then be put in a zero clamp state. <p>Note: With some models of SERVOPACKs, the Cancel button cannot be used to stop the motor.</p>

1. In the SigmaWin+ main window, click **Test Run - Program JOG Operation**.

A warning message about possible dangers will appear and ask if you want to continue.

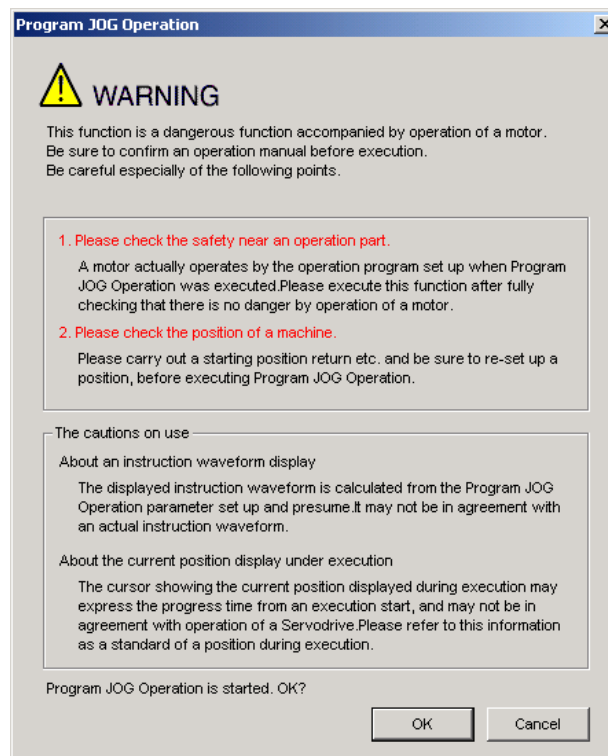

If these conditions are not acceptable and you do not want to continue, click **Cancel** to return to the main window without programming JOG operation.

2. Click **OK**.

The **Program JOG Operation** box will appear.

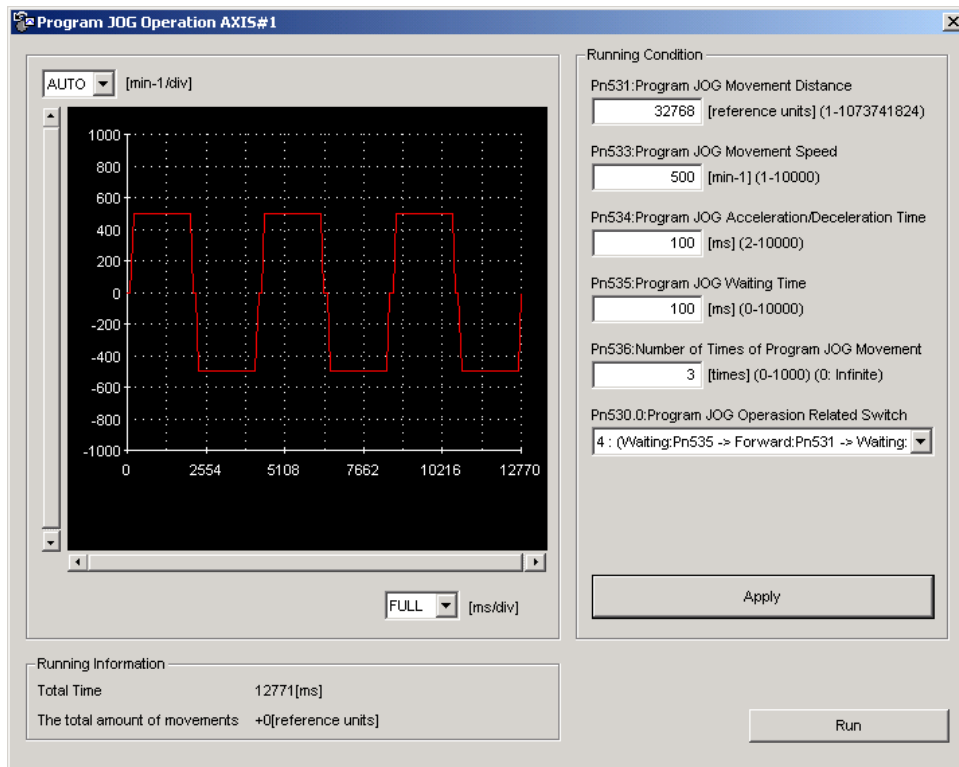

3. For each running condition in the **Program JOG Operation** box, enter or select the same value that have been used for the **Running Condition** group, and then click **Apply**.
The running pattern for the condition will be shown as a graph.

4. Click **Run**.

The contents of the **Program JOG Operation** box will change to the following display.

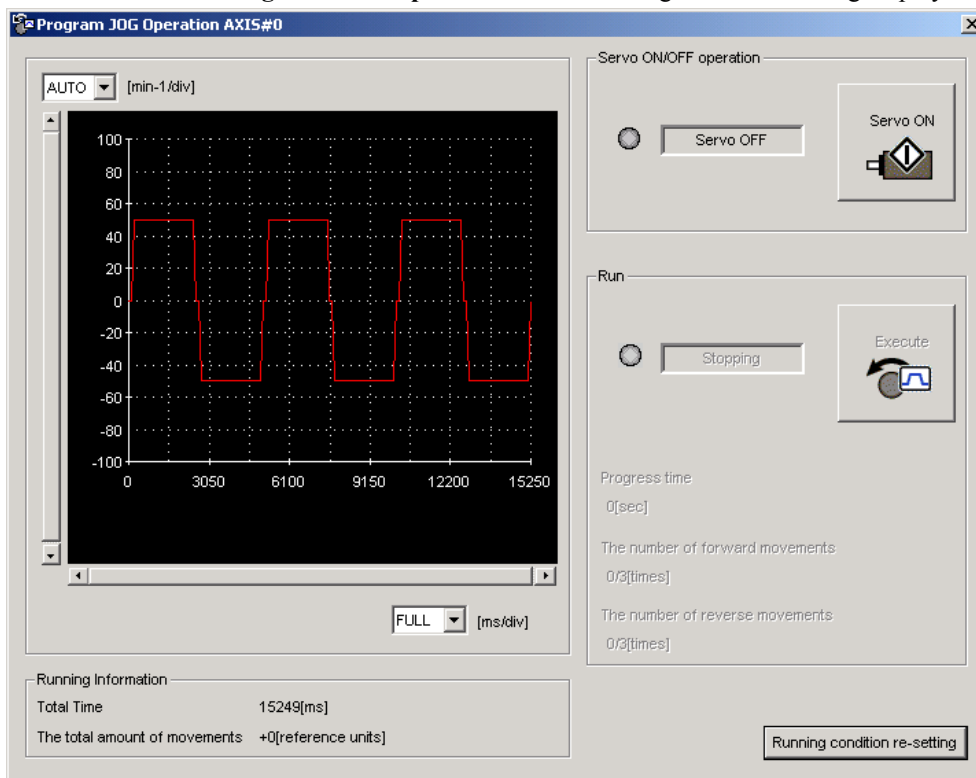

- Click **Servo ON** and then click **Execute**.

After the amount of time set in Pn535 has passed, the programmed JOG operation will start.

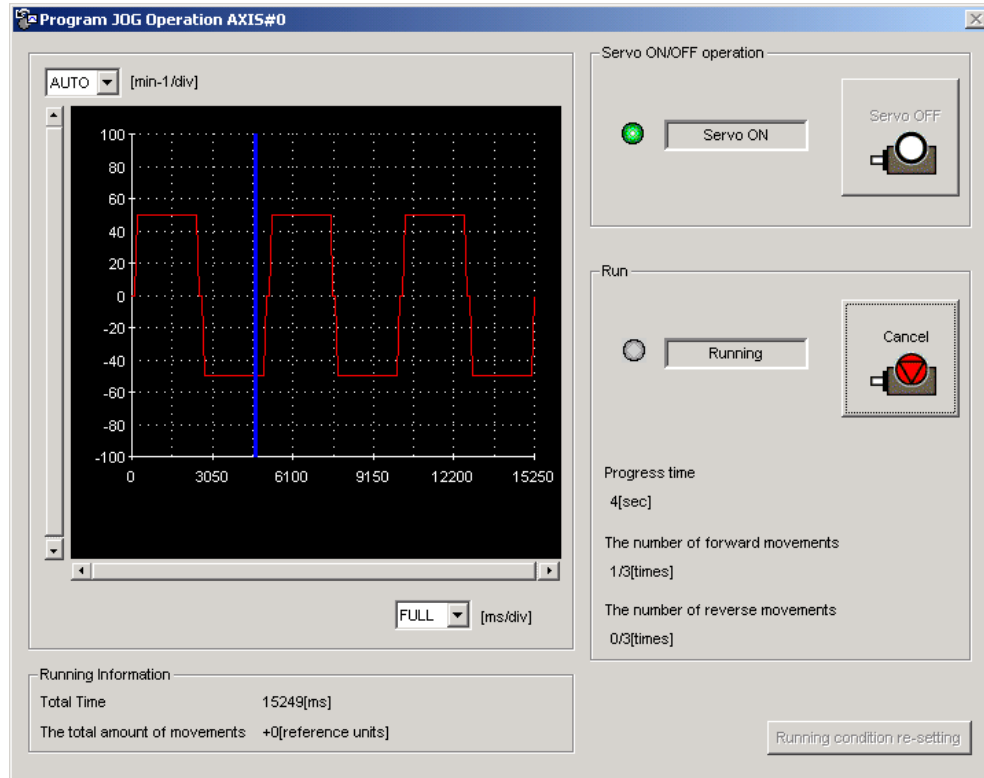

- After the programmed JOG operation has been successfully completed, restart the **SERVOPACK**.

6.6 Initializing Parameter Settings (Fn005)

This function is used when returning to the factory settings after changing parameter settings.



- Be sure to initialize the parameter settings while the servomotor power is OFF.
- After initialization, restart the SERVOPACK to validate the settings.

IMPORTANT

Note: Any value adjusted with Fn00C, Fn00D, Fn00E, and Fn00F cannot be initialized by Fn005.

(1) Preparation

The following conditions must be met to initialize the parameter values.

- The write prohibited setting parameter (Fn010) must be set to Write permitted (P.0000).
- The servomotor power must be OFF.

(2) Operating Procedure

Use the following procedure.

1. In the SigmaWin+ main window, click **Parameters - Edit Parameters**.

The **Parameter Editing** dialog box will appear.

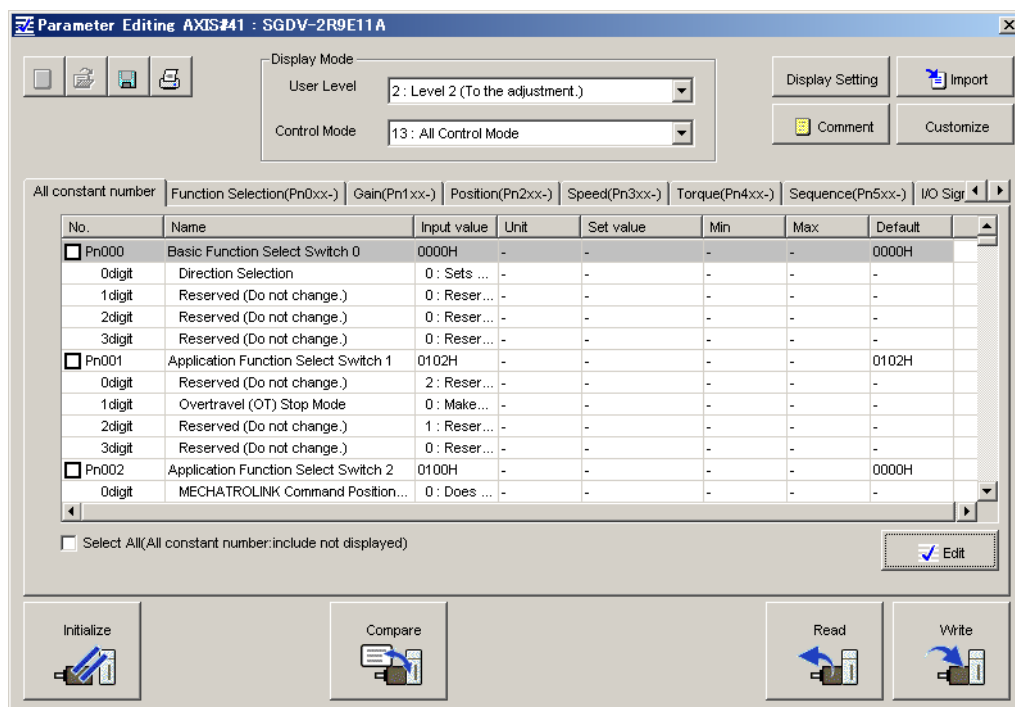

2. Click Initialize.

The **Verification** box will appear.

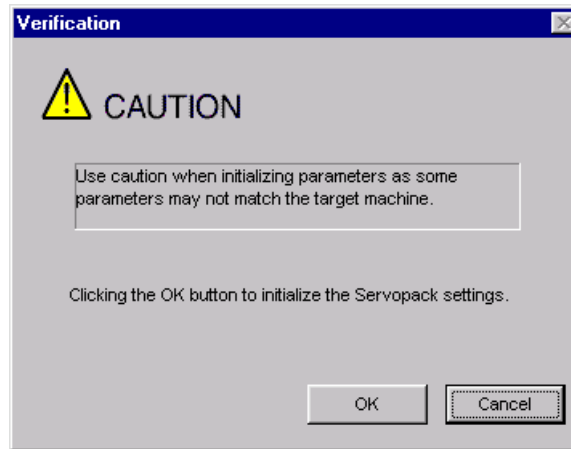

A message will appear as a warning to say that changes to settings might not correspond with other settings and it will then ask if you want to continue.

If these conditions are not acceptable and you do not want to continue, click **Cancel** to return to the **Parameter Editing** dialog box without initializing the parameter settings.

3. Click OK.

The Initialize the **Servopack** settings box will appear and ask if you want to continue.

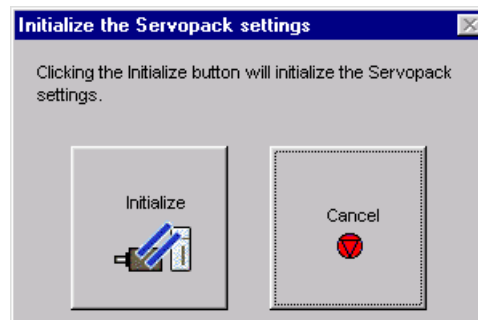

If you do not want to continue, click **Cancel** to return to the **Parameter Editing** dialog box without initializing the parameter settings.

4. Click **Initialize** to start initialization.

A progress indicator will show what percentage of the process has been completed.

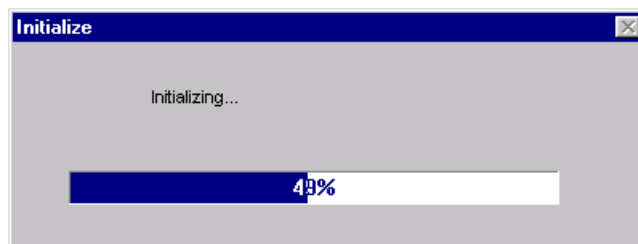

After the settings are successfully initialized, the following message will appear to prompt you to verify that all parameter settings are correct for the target machine.

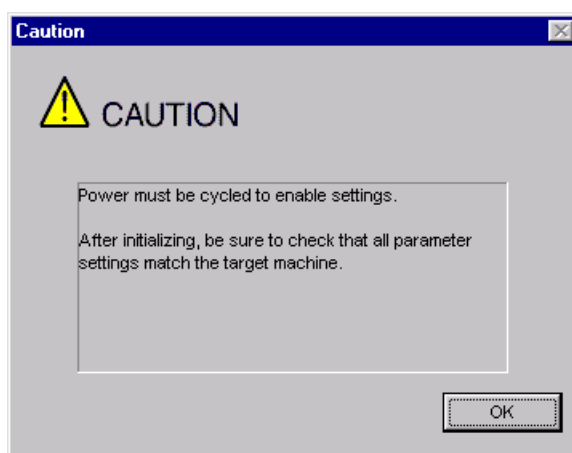

5. Click **OK**.
6. Restart the SERVOPACK.

6.7 Clearing Alarm History (Fn006)

The clear alarm history function deletes all of the alarm history recorded in the SERVOPACK.

Note: The alarm history is not deleted when the alarm reset is executed or the main circuit power supply of the SERVOPACK is turned OFF.

(1) Preparation

The follow conditions must be met to clear the alarm history.

- The write prohibited setting parameter (Fn010) must be set to Write permitted (P.0000).

(2) Operating Procedure

Use the following procedure.

1. In the SigmaWin+ main window, click **Alarm - Display Alarm**.

The **Alarm Display** box will appear.

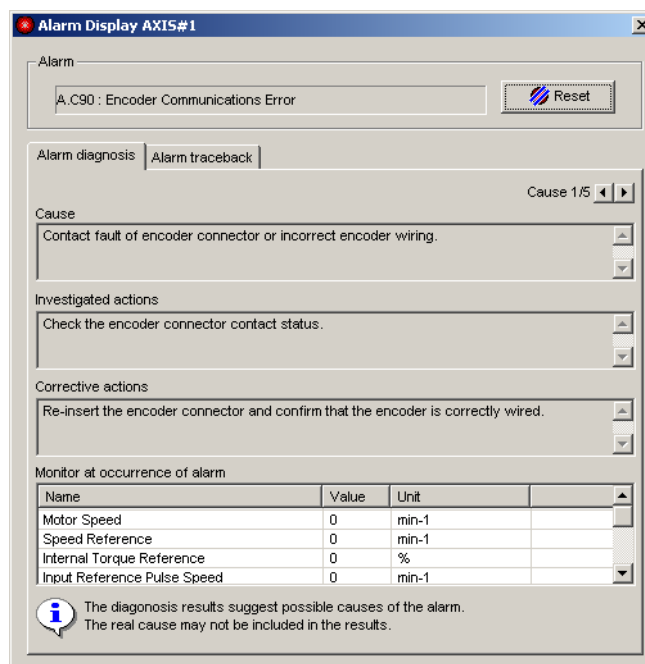

2. Click the **Alarm traceback** tab.

No.	Name	Accumulated operation time
01	A.C90 : Encoder Communications Error	49:01:06.4
02	A.S10 : Overspeed	49:00:36.7
03	Normal	0:00:00.0
04	Normal	0:00:00.0
05	Normal	0:00:00.0
06	Normal	0:00:00.0
07	Normal	0:00:00.0
08	Normal	0:00:00.0
09	Normal	0:00:00.0
10	Normal	0:00:00.0

3. Click **Clear**.

The alarm history will be cleared.

6.8 Offset Adjustment of Analog Monitor Output (Fn00C)

If connecting an analog monitor unit, the analog monitor signal output (factory setting: torque monitor or motor speed monitor) can be monitored. The offset is adjusted in the analog monitor unit at the factory. The user need not usually use this function. To adjust the offset manually, use this function.

(1) Adjustment Example

An example of offset adjustment to the motor speed monitor is shown below.

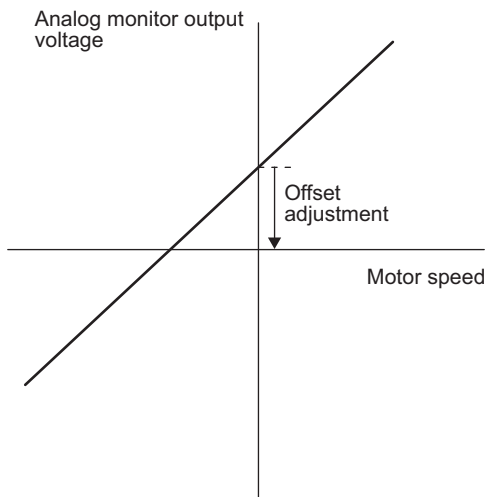

Item	Specifications
Offset Adjustment Range	-2.4 V to + 2.4 V
Adjustment Unit	18.9 mV/LSB

Note:

- The adjustment value will not be initialized when parameter settings are initialized using Fn005.
- Make offset adjustment with a measuring instrument connected, so that the analog monitor output is zero. An example of settings for a zero analog monitor output is shown below.
 - While the servomotor is not turned ON, set the monitor signal to the torque reference.
 - In speed control, set the monitor signal to the position error.

(2) Preparation

The following condition must be met to adjust the offsets of the analog monitor output.

- The write prohibited setting parameter (Fn010) must be set to Write permitted (P.0000).

(3) Operating Procedure

Use the following procedure.

1. Connect the measurement instrument.
For details, refer to 5.1.3 (1) *Connecting the Measurement Instrument*.
2. In the SigmaWin+ main window, click **Setup - Adjust Offset - Adjust the Analog Monitor Output**. The **Adjust the Analog Monitor Output** box will appear. Click **Zero Adjustment** tab.

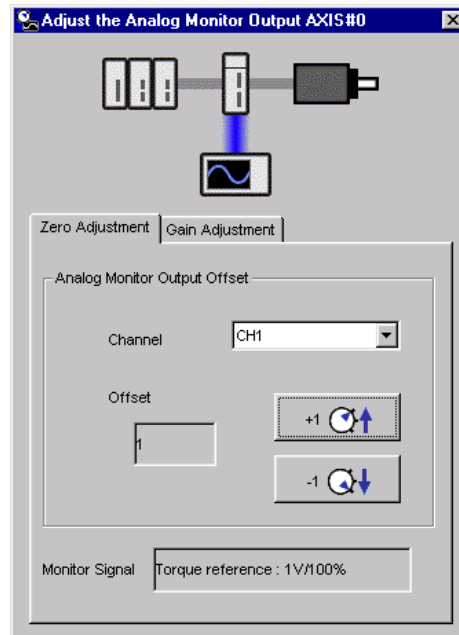

In the **Channel** box, either CH1 or CH2 can be selected.

3. To adjust the offset, click **+1** (increase) or **-1** (decrease) button while viewing the analog monitor to check the output level. Keep the output as close to zero as possible.

6.9 Gain Adjustment of Analog Monitor Output (Fn00D)

If connecting an analog monitor unit, the analog monitor signal output (factory setting: torque monitor or motor speed monitor) can be monitored. The gain is adjusted in the analog monitor unit at the factory. The user need not usually use this function. To adjust the gain manually, use this function.

(1) Adjustment Example

An example of gain adjustment to the motor rotating speed monitor is shown below.

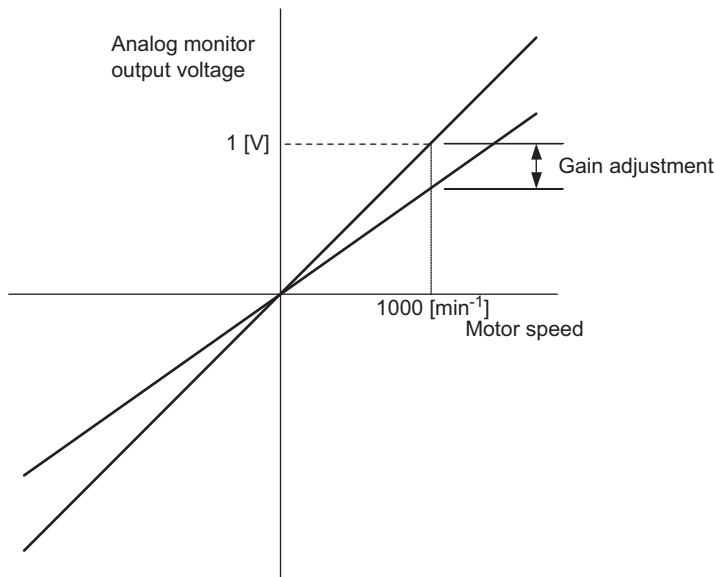

Item	Specifications
Gain-adjustment Range	100±50%
Adjustment Unit	0.4%/LSB

The gain adjustment range is made with a 100% output set as a center value (adjustment range: 50% to 150%). The following is a setting example.

<Setting the Set Value to -125>

$$100\% + (-125 \times 0.4) = 50\%$$

Therefore, the monitor output voltage is 0.5 time as high.

<Setting the Set Value to 125>

$$100\% + (125 \times 0.4) = 150\%$$

Therefore, the monitor output voltage is 1.5 times as high.

Note: The adjustment value will not be initialized when parameter settings are initialized using Fn005.

(2) Preparation

The following condition must be met to adjust the gain of the analog monitor output.

- The write prohibited setting parameter (Fn010) must be set to Write permitted (P.0000).

(3) Operating Procedure

Use the following procedure to perform the gain adjustment of analog monitor output.

1. In the SigmaWin+ main window, click **Setup - Adjust Offset - Adjust the Analog Monitor Output**. The **Adjust the Analog Monitor Output** box will appear. Click the **Gain Adjustment** tab.

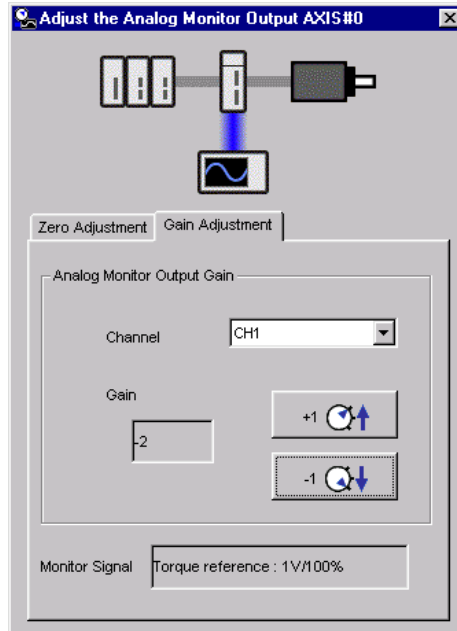

In the **Channel** box, either CH1 or CH2 can be selected.

2. To change the value of the gain adjustment, click **+1** (increase) or **-1** (decrease) button.

6.10 Automatic Offset-Signal Adjustment of the Motor Current Detection Signal (Fn00E)

Perform this adjustment only if highly accurate adjustment is required for reducing torque ripple caused by current offset. The user need not usually use this function.

 IMPORTANT	<ul style="list-style-type: none"> • Be sure to perform this function while the servomotor power is OFF. • Execute the automatic offset adjustment if the torque ripple is too big when compared with those of other SERVOPACKs.
-------------------------------------------------------------------------------------------------------	----------------------------------------------------------------------------------------------------------------------------------------------------------------------------------------------------------------------------------------------------------

Note: The adjusted value is not initialized by executing the Fn005 function (Initializing Parameter Settings).

(1) Preparation

The following conditions must be met to automatically adjust the offset of the motor current detection signal.

- The write prohibited setting parameter (Fn010) must be set to Write permitted (P.0000).
- The SERVOPACK must be in Servo Ready status (Refer to 4.8.4).
- The servomotor power must be OFF.

(2) Operating Procedure

Use the following procedure.

1. In the SigmaWin+ main window, click **Setup - Adjust Offset - Adjust the Motor Current Detection Offset**.

The following message will appear and ask if you want to continue. The message informs you that the offset is set to the factory settings and that the SERVOPACK's performance might be affected if these settings are changed.

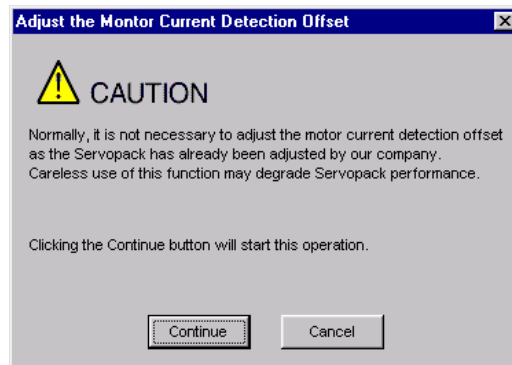

- Click **Continue** to adjust the motor detection offset. The **Adjust the Motor Current Detection Offset** box will appear. Click the **Automatic Adjustment** tab.

The settings for **Automatic Adjustment** will appear.

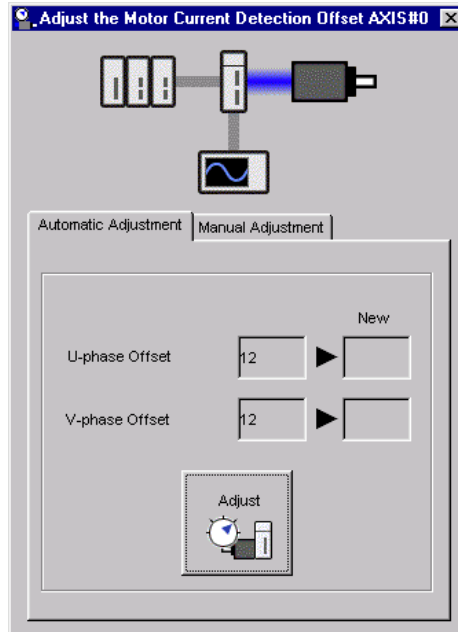

- Click **Adjust**.

The offset value automatically adjusted will be shown in the **New** box.

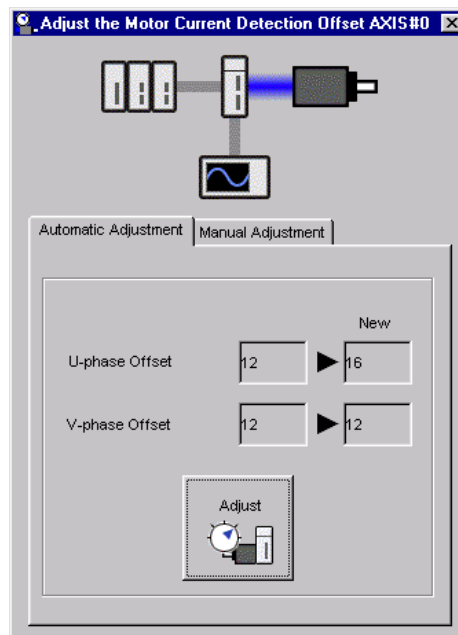

6.11 Manual Offset-Signal Adjustment of the Motor Current Detection Signal (Fn00F)

Use this function only if the torque ripple is still high after the automatic offset-signal adjustment of the motor current detection signal (Fn00E).

 IMPORTANT	<p>If offset is adjusted incorrectly and then executed using this function, characteristics of the servomotor performance could be affected.</p> <p>Observe the following precautions when performing manual servo tuning.</p> <ul style="list-style-type: none"> • Run the servomotor at a speed of approximately 100 min⁻¹. • Adjust the offset while monitoring the torque reference with the analog monitor until the ripple of torque reference monitor's waveform is minimized. • Adjust the phase-U and phase-V offset amounts alternately several times until these offsets are well balanced.
-------------------------------------------------------------------------------------------------------	----------------------------------------------------------------------------------------------------------------------------------------------------------------------------------------------------------------------------------------------------------------------------------------------------------------------------------------------------------------------------------------------------------------------------------------------------------------------------------------------------------------------------------------------------------------------------------------------------------------------------------------------------

Note: The adjusted value is not initialized by executing the Fn005 function (Initializing Parameter Settings).

(1) Preparation

The following condition must be met to manually adjust the offset of the motor current detection signal.

- The write prohibited setting parameter (Fn010) must be set to Write permitted (P.0000).

(2) Operating Procedure

Use the following procedure.

1. Turn the motor at 100 min⁻¹.
2. In the SigmaWin+ main window, click **Setup - Adjust Offset - Adjust the Motor Current Detection Offset**.

The following message will appear and ask if you want to continue. The message informs you that the offset is set to the factory settings and that the SERVOPACK's performance might be affected if these settings are changed.

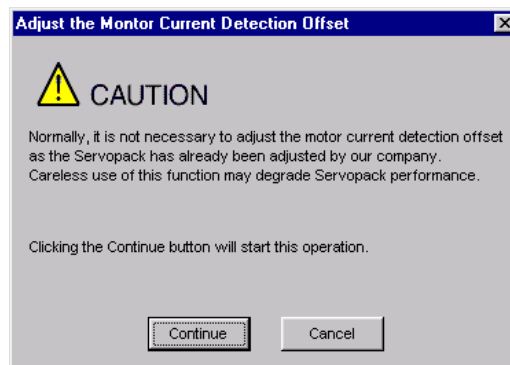

- Click **Continue**. **Adjust the Motor Current Detection Offset** box will appear. Click the **Manual Adjustment** tab.

The settings for **Manual Adjustment** will appear.

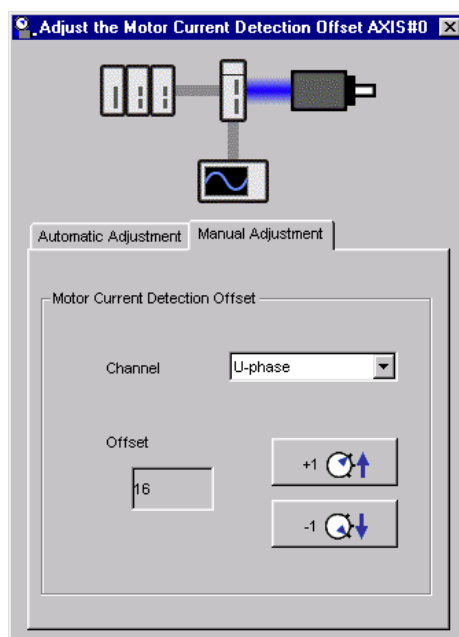

- Select **U-phase** in the **Channel** box.
- To adjust the offset of the phase U, click the **+1** button to increase the set value and click the **-1** button to decrease.
Increase or decrease the offset by increments of 10 to minimize torque ripple. The offset can be any value between -512 and +511.
- Select **V-phase** in the **Channel** box.
- To adjust the offset of the phase V, click the **+1** button to increase the set value and click the **-1** button to decrease.
Increase or decrease the offset by increments of 10 to minimize torque ripple.
- Repeat steps 4 to 7 alternating between the U and V phases until the torque ripple cannot be reduced any further.
- Then adjust the offsets further by repeating steps 4 to 7 but using a unit smaller than 10.

6.12 Write Prohibited Setting (Fn010)

This function prevents changing parameters by mistake and sets restrictions on the execution of the utility function.

Parameter changes and execution of the utility function become restricted in the following manner when Write prohibited (P.0001) is assigned to the write prohibited setting parameter (Fn010).

- Parameters: Parameters can be changed from the SigmaWin+.
- Utility Function: Some functions cannot be executed. (Refer to the following table.) If you attempt to execute these utility functions a warning dialog box will appear.

Parameter No.	Function	Write Prohibited Setting	Reference Section
Fn000	Alarm history display	Executable	6.2
Fn002	JOG operation	Cannot be executed	6.3
Fn003	Origin search	Cannot be executed	6.4
Fn004	Program JOG operation	Cannot be executed	6.5
Fn005	Initializing parameter settings	Cannot be executed	6.6
Fn006	Clearing alarm history	Cannot be executed	6.7
Fn008	Absolute encoder multiturn reset and encoder alarm reset	Cannot be executed	4.7.4
Fn00C	Offset adjustment of analog monitor output	Cannot be executed	6.8
Fn00D	Gain adjustment of analog monitor output	Cannot be executed	6.9
Fn00E	Automatic offset-signal adjustment of the motor current detection signal	Cannot be executed	6.10
Fn00F	Manual offset-signal adjustment of the motor current detection signal	Cannot be executed	6.11
Fn010	Write prohibited setting	–	6.12
Fn011	Servomotor model display	Executable	6.13
Fn012	Software version display	Executable	6.14
Fn013	Multiturn limit value setting change when a multiturn limit disagreement alarm occurs	Cannot be executed	4.7.6
Fn01B	Vibration detection level initialization	Cannot be executed	6.15
Fn01E	Display of SERVOPACK and servomotor ID	Executable	6.16
Fn030	Software reset	Executable	6.17
Fn200	Tuning-less levels setting	Cannot be executed	5.2.2
Fn201	Advanced autotuning	Cannot be executed	5.3.2
Fn202	Advanced autotuning by reference	Cannot be executed	5.4.2
Fn203	One-parameter tuning	Cannot be executed	5.5.2
Fn204	Anti-resonance control adjustment function	Cannot be executed	5.6.2
Fn205	Vibration suppression function	Cannot be executed	5.7.2
Fn206	EasyFFT	Cannot be executed	6.18
Fn207	Online vibration monitor	Cannot be executed	6.19

(1) Preparation

There are no tasks that must be performed before the execution.

(2) Operating Procedure

Follow the steps to set enable or disable writing.

Setting values are as follows:

- "P.0000": Write permitted (Releases write prohibited mode.) [Factory setting]
- "P.0001": Write prohibited (Parameters become write prohibited from the next power ON.)

1. In the SigmaWin+ main window, click **Setup - Write Prohibited Setting**.

The **Write Prohibited Setting** box will appear.

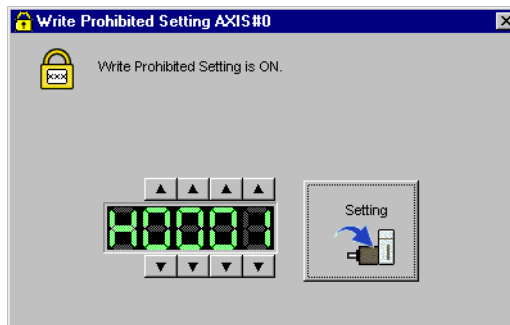

Set the parameter to enable or prohibit writing. Click the setting arrows to increase or decrease the number on the far right.

Writing enabled (factory setting): 0000

Writing prohibited: 0001

2. Click **Setting**.

The following message appears and informs you that the write prohibited setting has been changed and the new setting will become valid the next time the SERVOPACK is restarted.

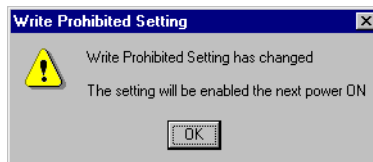

3. Click **OK**.

The new setting will be saved in the SERVOPACK.

4. To enable the change in the setting, restart the SERVOPACK.

6.13 Servomotor Model Display (Fn011)

This function is used to check the servomotor model, encoder type, and encoder resolution. If the SERVO-PACK has been custom-made, you can also check the specification codes of SERVOPACKs.

(1) Preparation

There are no tasks that must be performed before the execution.

(2) Operating Procedure

Use the following procedure.

1. In the SigmaWin+ main window, click **Monitor - Product Information**.

The **Product Information** box will appear.

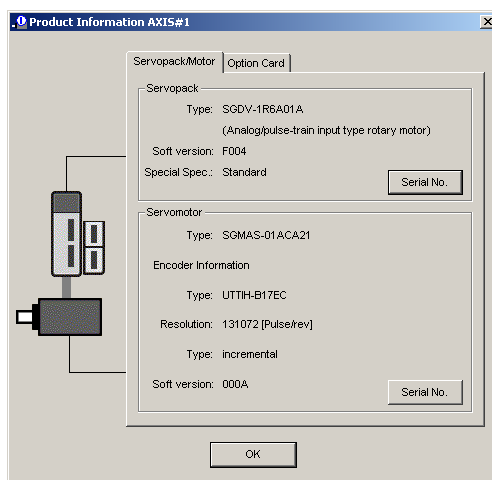

2. Click **OK**.

The SigmaWin+ main window will appear.

6.14 Software Version Display (Fn012)

Select Fn012 to check the SERVOPACK and encoder software version numbers.

(1) Preparation

There are no tasks that must be performed before the execution.

(2) Operating Procedure

Use the following procedure.

1. In the SigmaWin+ main window, click **Monitor - Product Information**.
The **Product Information** box will appear.

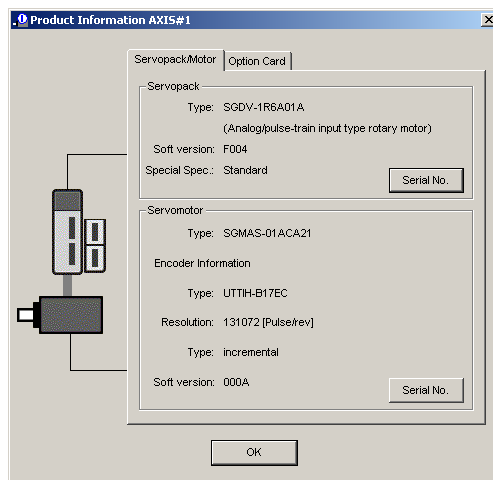

2. Click **OK**.
The SigmaWin+ main window will appear.

6.15 Vibration Detection Level Initialization (Fn01B)

This function detects vibration when servomotor is connected to a machine in operation and automatically adjusts the vibration detection level (Pn312) to output more exactly the vibration alarm (A.520) and the vibration warning (A.911).

The vibration detection function detects vibration elements according to the motor speed.

Parameter		Meaning	When Enabled	Classification
Pn310	n.□□□0 [Factory setting]	Does not detect vibration.	Immediately	Setup
	n.□□□1	Outputs the warning (A.911) when vibration is detected.		
	n.□□□2	Outputs the alarm (A.520) when vibration is detected.		

If the vibration exceeds the detection level calculated by the following formula, the alarm or warning will be output according to the setting of vibration detection switch (Pn310).

$$\text{Detection level} = \frac{\text{Vibration detection level (Pn312 [min}^{-1}\text{])} \times \text{Vibration detection sensitivity (Pn311 [\%])}}{100}$$

- Use this function if the vibration alarm (A.520) or the vibration warning (A.911) is not output correctly when a vibration at the factory setting of the vibration detection level (Pn312) is detected. In other cases, it is not necessary to use this function.
- The vibration alarm or warning detection sensibility differs depending on the machine conditions. In this case, fine-tune the setting of the vibration detection sensitivity (Pn311) using the above detection level formula as a guide.

Pn311	Vibration Detection Sensitivity				Classification
	Setting Range	Setting Unit	Factory Setting	When Enabled	
	50 to 500	1%	100	Immediately	Tuning



IMPORTANT

- The vibration may not be detected because of improper servo gains. Also, not all kinds of vibrations can be detected. Use the detection result as a guideline.
- Set a proper moment of inertia ratio (Pn103). Improper setting may result in the vibration alarm, warning misdetection, or non-detection.
- The references that are used to operate your system must be input to execute this function.
- Execute this function under the operating condition for which the vibration detection level should be set.
- Execute this function while the motor speed reaches at least 10% of its maximum.

(1) Preparation

The following conditions must be met to initialize the vibration detection level.

- The write prohibited setting parameter (Fn010) must be set to Write permitted (P.0000).
- The test without a motor function must be disabled (Pn00C.0 = 0).

(2) Operating Procedure

Use the following procedure.

1. In the SigmaWin+ main window, click **Setup - Initialize Vibration Detection Level**.

The **Initialize Vibration Detection Level** box will appear.

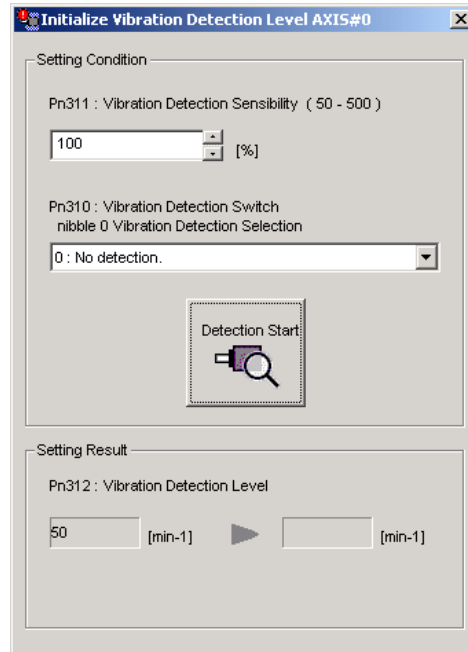

2. Select a percentage for **Pn311: Vibration Detection Sensibility** and one condition in **Pn310: Vibration Detection Switch**, and then click **Detection Start**.

The name of the button will change from **Detection Start** to **Execute** to indicate that detection is ready to be executed.

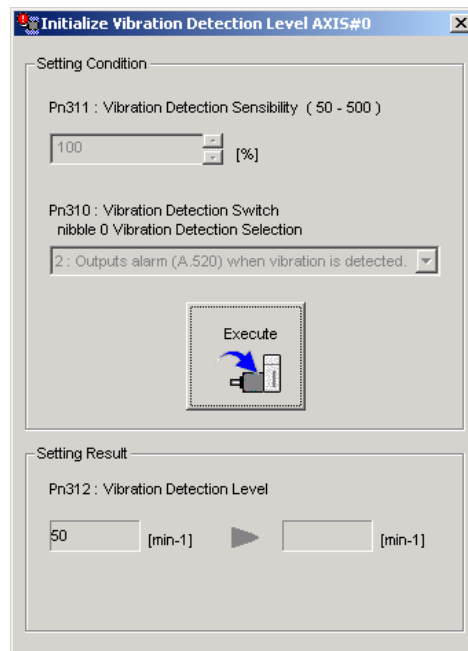

3. Click **Execute**.

The new settings for the vibration detection level will be shown in the boxes in lower section of the box. The new settings will be saved in the SERVOPACK.

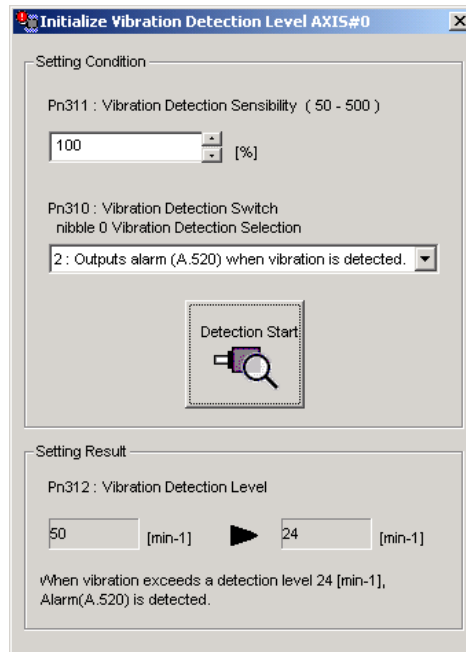

(3) Related Parameters

The following table lists parameters related to this function and their possibility of being changed while executing this function or of being changed automatically after executing this function.

- Parameters related to this function
 - These are parameters that are used or referenced when executing this function.
- Allowed changes during execution of this function
 - Yes : Parameters can be changed using SigmaWin+ while this function is being executed.
 - No : Parameters cannot be changed using SigmaWin+ while this function is being executed.
- Automatic changes after execution of this function
 - Yes : Parameter set values are automatically set or adjusted after execution of this function.
 - No : Parameter set values are not automatically set or adjusted after execution of this function.

Parameter	Name	Mid-execution changes	Automatic changes
Pn311	Vibration Detection Sensibility	Yes	No
Pn312	Vibration Detection Level	No	Yes

6.16 Display of SERVOPACK and Servomotor ID (Fn01E)

This function displays ID information for SERVOPACK, servomotor and encoder connected to the SERVOPACK.

The SigmaWin+ is required to perform this function.

The following items can be displayed.

ID	Items to be Displayed
SERVOPACK ID	<ul style="list-style-type: none"> • SERVOPACK model • SERVOPACK serial number • SERVOPACK manufacturing date
Servomotor ID	<ul style="list-style-type: none"> • Servomotor model • Servomotor serial number • Servomotor manufacturing date
Encoder ID	<ul style="list-style-type: none"> • Encoder model • Encoder serial number • Encoder manufacturing date • Encoder type/resolution

(1) Preparation

There are no tasks that must be performed before the execution.

(2) Operating Procedure

Use the following procedure.

1. In the SigmaWin+ main window, click **Monitor - Product Information**.

The **Product Information** box will appear.

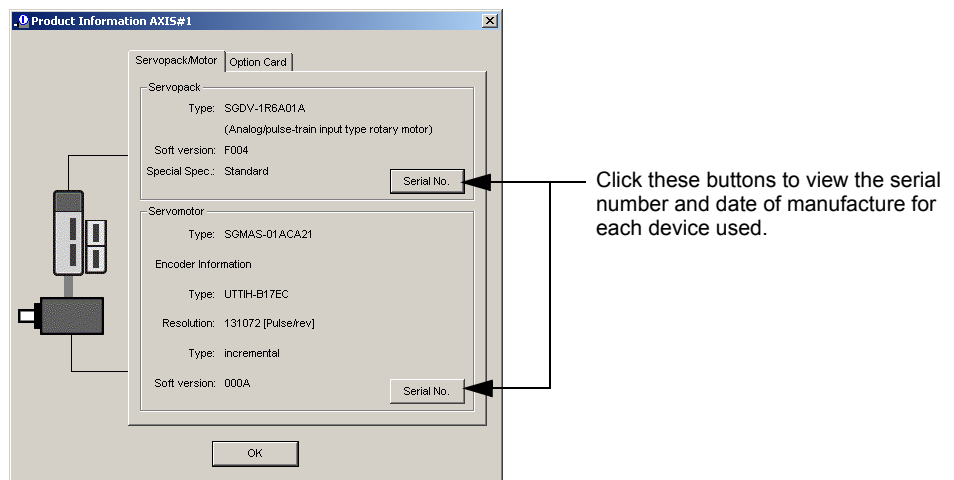

2. Click **OK**.

The SigmaWin+ main window will appear.

6.17 Software Reset (Fn030)

This function enables resetting the SERVOPACK internally from software. This function is used when resetting alarms and changing the settings of parameters that normally require restarting the SERVOPACK. This function can be used to change those parameters without restarting the SERVOPACK.

There are the following two types of software resets for SigmaWin+ connection status.

- Resetting for a conventional connection
- Resetting for a connection through a controller

 IMPORTANT	<ul style="list-style-type: none"> • Start software reset operation after the servomotor power is OFF. • This function resets the SERVOPACK independently of host controller. The SERVOPACK carries out the same processing as when the power supply is turned ON and outputs the ALM signal. The status of other output signals may be forcibly changed. • The SERVOPACK will not respond for 5 seconds after the reset begins. Always check the status of the SERVOPACK and motor before you execute a reset.
-------------------------------------------------------------------------------------------------------	------------------------------------------------------------------------------------------------------------------------------------------------------------------------------------------------------------------------------------------------------------------------------------------------------------------------------------------------------------------------------------------------------------------------------------------------------------------------------------------------------------------------------------------------------

(1) Preparation

The following condition must be met to perform a software reset.

- The servomotor power must be OFF.

(2) Operating Procedure

Use the following procedure.

■ Conventional connection

1. In the SigmaWin+ main window, click **Setup - Software Reset**.

The following message will appear and remind you to check the status of the SERVOPACK and the motor for safety reasons because the SERVOPACK will stop responding for about 5 seconds after the software reset has been executed.

Note: If the moment of inertia is calculated as described in 5.3 *Advanced Autotuning (Fn201)*, the **Software Reset** box shown in step 2 will appear.

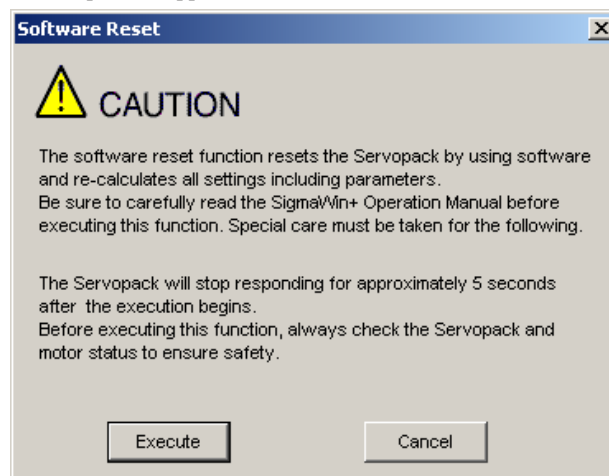

If you do not want to continue, click **Cancel**. The SigmaWin+ main window will appear.

2. Click **Execute**.

The **Software Reset** box will appear.

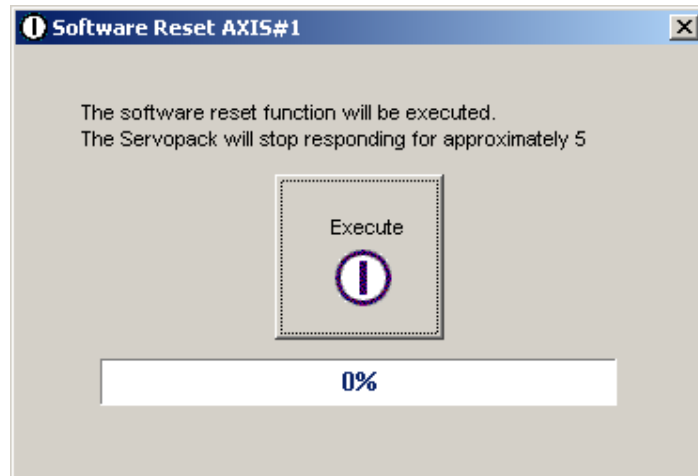

3. Click **Execute**.

After resetting of software has been completed, the following message will appear.

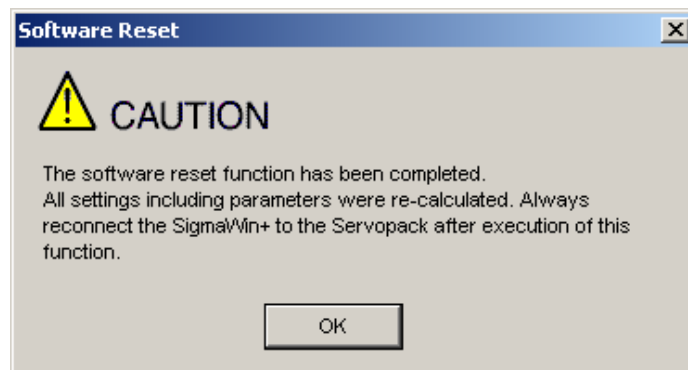

4. Click **OK** to close the **Software Reset** box.

All settings including parameters have been re-calculated. Disconnect the SigmaWin+ from the SERVO-PACK, and then reconnect to validate the new settings.

■ Connection through a controller

1. In the SigmaWin+ main window, click **Setup - Software Reset**.
The **Software Reset** box will appear.

Note: If the moment of inertia is calculated as described in 5.3 *Advanced Autotuning (Fn201)*, the **Software Reset** box shown in step 2 will appear.

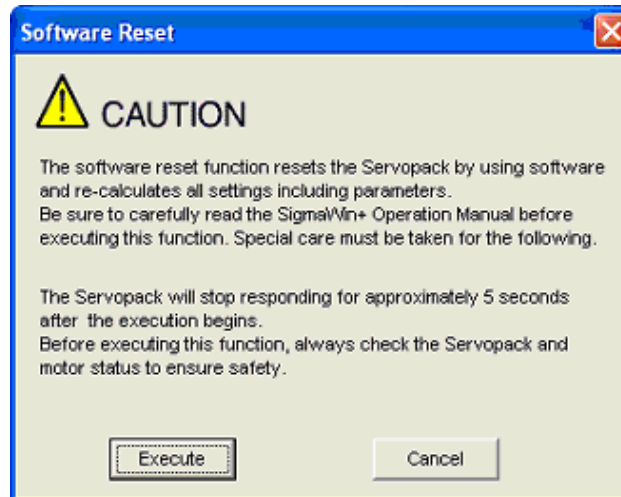

If you do not want to continue, click **Cancel**. The SigmaWin+ main window will appear.

2. Click **Execute**.

The **Software Reset** box will appear.

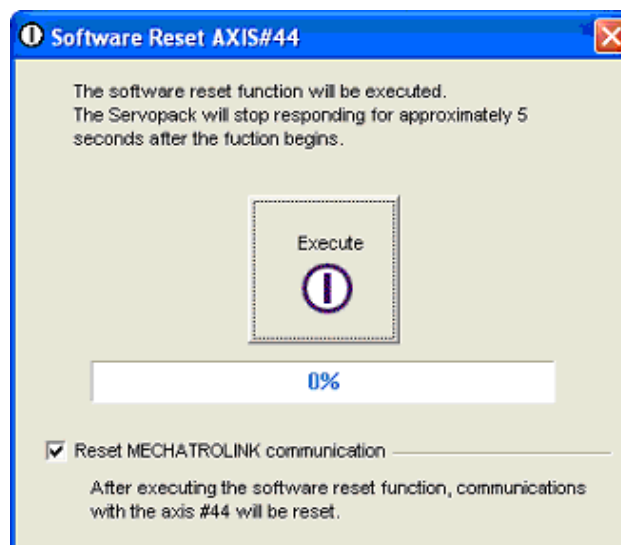

3. Select the **Reset MECHATROLINK communication**.
4. Click **Execute**.

 IMPORTANT	<p>If Software Reset is executed without resetting MECHATROLINK communications, communications between the controller and the SERVOPACK will be disabled and an error will be issued. Make sure to check the box for Reset MECHATROLINK communication to reset the MECHATROLINK communications.</p>
---------------------------------------------------------------------------------------------------------	-------------------------------------------------------------------------------------------------------------------------------------------------------------------------------------------------------------------------------------------------------------------------------------------------------------------

5. After the software reset has been completed, the following message will appear. The message will tell you to reconnect SigmaWin+ to the SERVOPACK after the reset has been completed.

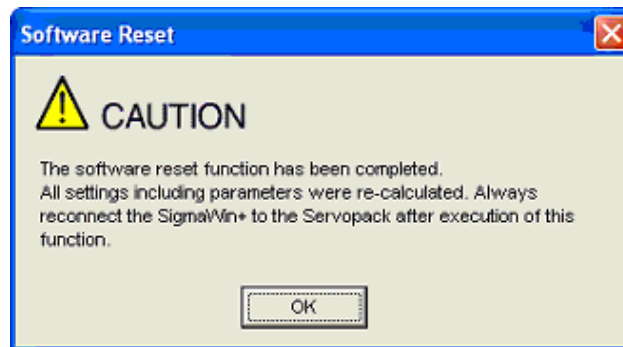

6. Click **OK** to close the **Software Reset** box. All settings including parameters have been re-calculated. Disconnect SigmaWin+ from the SERVOPACK, and then reconnect to validate the new settings.

- When resetting only MECHATROLINK communications
MECHATROLINK communications can be reset separately.

Communication between the controller and the SERVOPACK can be restored by clearing the error that occurred during communications between them.

1. In the SigmaWin+ main window, click **Setup - MECHATROLINK Communications Reset**.
The **MECHATROLINK Communications Reset** box will appear.

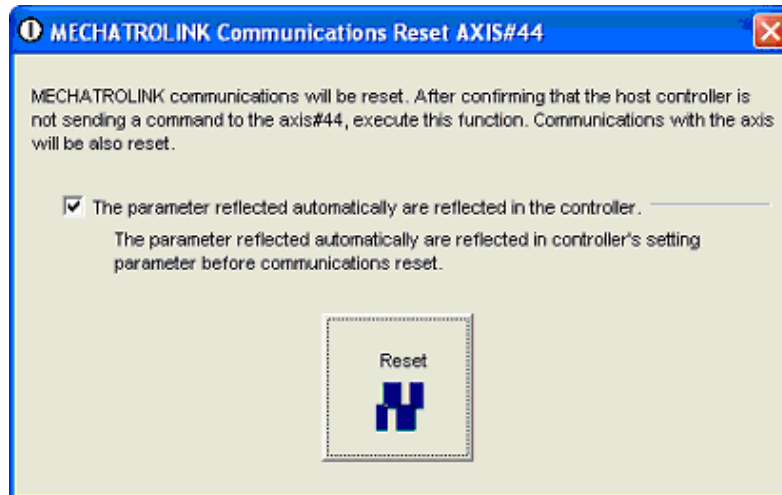

2. Click **Reset**.

A message will appear and inform you that the parameter settings to be saved in the controller will be cleared if the controller is restarted. You must use MPE720 to save the settings in the controller if you want to keep the settings. A list of parameters whose settings are to be saved is also shown.

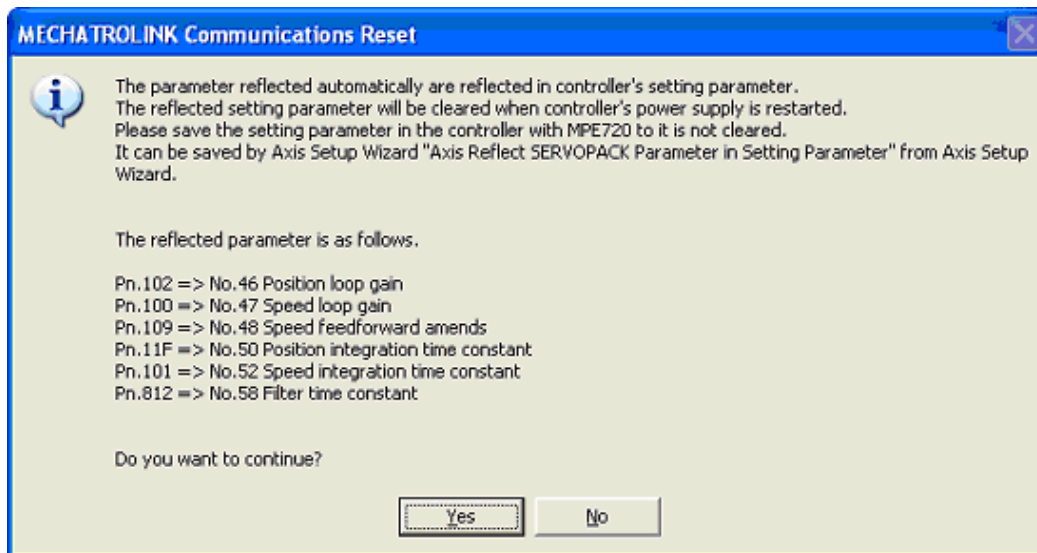

3. Click **Yes**.

The parameters that are set to be automatically saved will be reflected in the settings of parameters in the controller in the OW□□□□ register.

At the same time, the MECHATROLINK communications will be reset and the **MECHATROLINK Communications Reset** box will close.

6.18 EasyFFT (Fn206)

EasyFFT sends a frequency waveform reference from the SERVOPACK to the servomotor and slightly rotates the servomotor several times over a certain period, thus causing machine vibration. The SERVOPACK detects the resonance frequency from the generated vibration and makes notch filter settings according to the resonance frequency detection. The notch filter is effective for the elimination of high-frequency vibration and noise.

Execute this function after the servomotor power is turned OFF if operation of the SERVOPACK results in high-frequency noise and vibration.

⚠ WARNING

- The servomotor automatically will move less than a quarter of a turn several times in the specified direction when EasyFFT is executed. Do not touch the servomotor or machine during execution of EasyFFT, otherwise injury may result.

⚠ CAUTION

- Use the EasyFFT when the servo gain is low, such as in the initial stage of servo adjustment. If EasyFFT is executed after increasing the gain, the servo system may vibrate depending on the machine characteristics or gain balance.

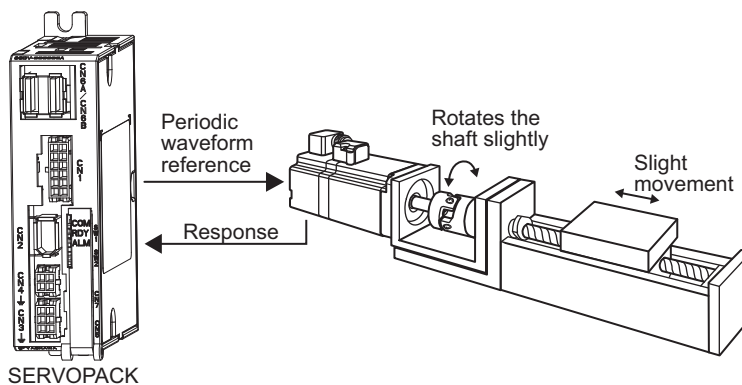

In addition to this function, online vibration monitor (Fn207) can be used to detect machine vibration and automatically make notch filter settings.

If a DC Power Input Σ -V Series SERVOPACK is used to make adjustments, it is recommended to use advanced autotuning. This built-in EasyFFT function is used to maintain interchangeability with previous models. There is normally no need to use it.

(1) Preparation

The following conditions must be met to perform EasyFFT.

- The write prohibited setting parameter (Fn010) must be set to Write permitted (P.0000).
- The main circuit power supply must be ON.
- All alarms must be cleared.
- The servomotor power must be OFF.
- There must be no overtravel.
- The test without a motor function must be disabled (Pn00C.0 = 0).
- An external reference must not be input.

(2) Operating Procedure

Use the following procedure.

1. In the SigmaWin+ main window, click **Setup - EasyFFT**.

A warning message will appear and remind you of possible dangers.

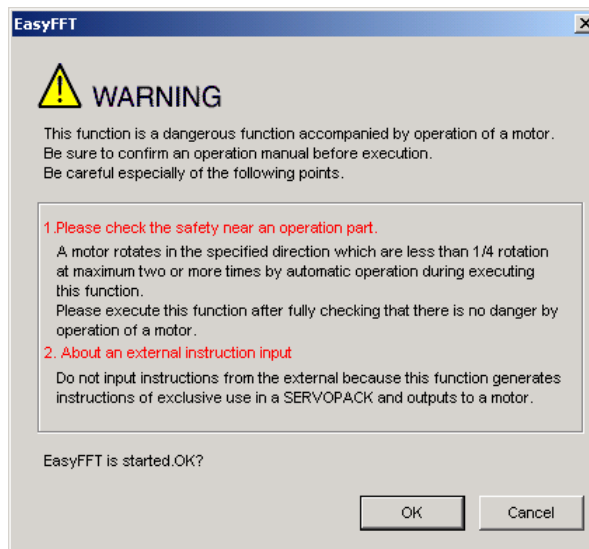

If you do not want to continue, click **Cancel**. The **SigmaWin+** main window will appear.

2. Click **OK**.

The **EasyFFT** box will appear.

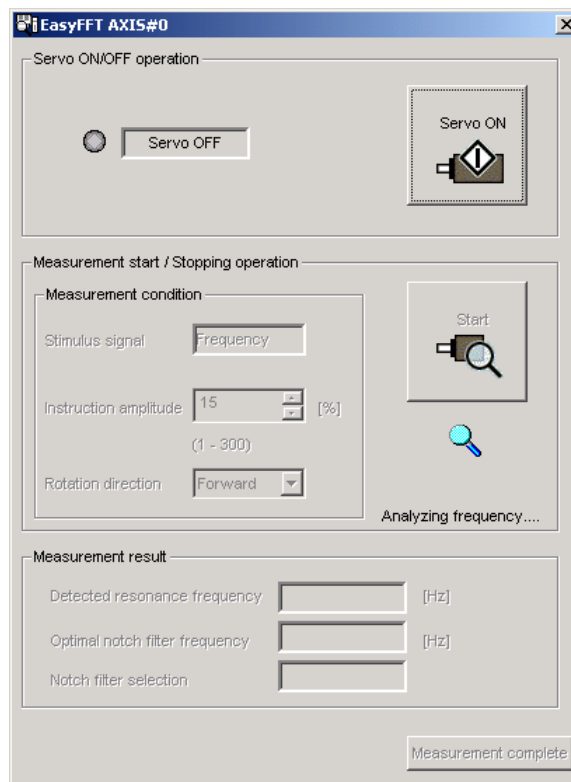

3. Click **Servo ON**.

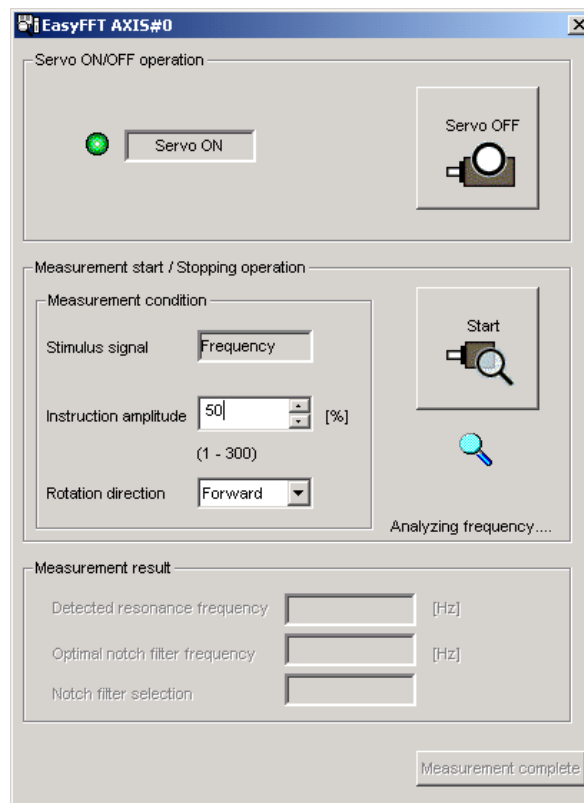

4. Select the percentage in the **Instruction amplitude** box and the rotational direction in the **Rotation direction**. Click **Start**.

The motor will begin to rotate, and the frequency will be measured. After the frequency has been measured, the results will be shown in the lower area of the box.

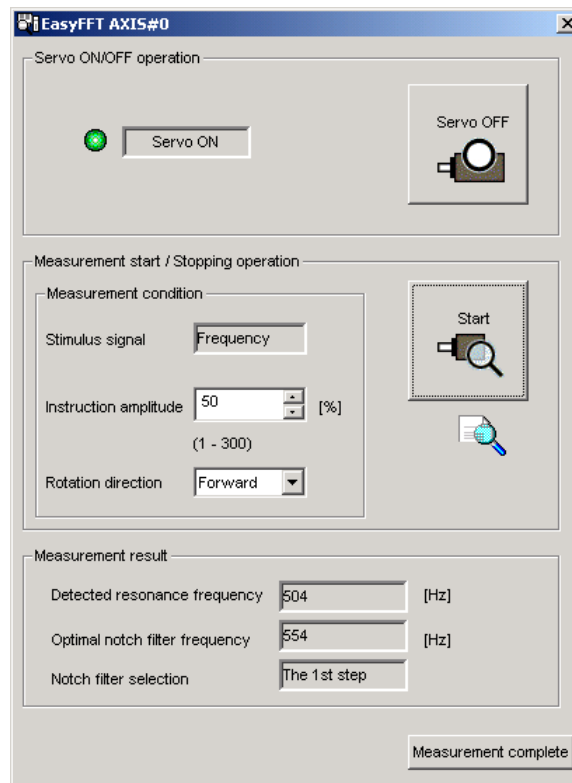

5. Click **Measurement complete**.

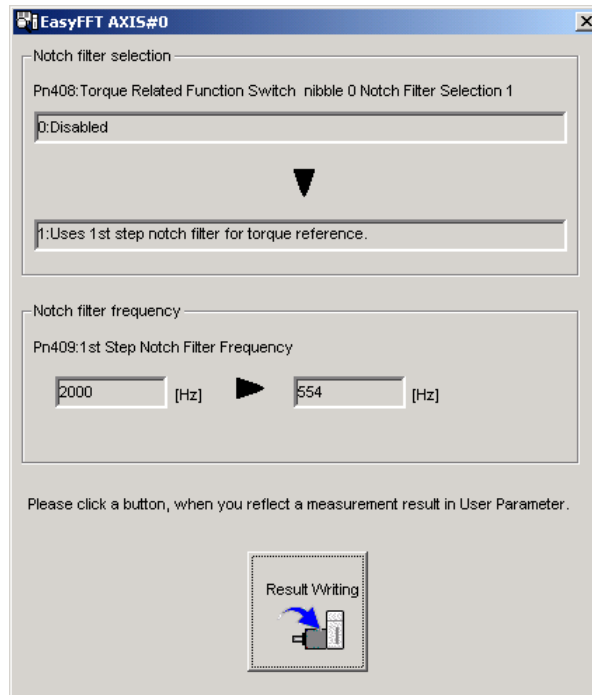

6. If setting the parameters to the values shown in the measurement results, click **Result Writing**.

(3) Related Parameters

The following table lists parameters related to this function and their possibility of being changed while executing this function or of being changed automatically after executing this function.

- Parameters related to this function
These are parameters that are used or referenced when executing this function.
- Allowed changes during execution of this function
Yes : Parameters can be changed using SigmaWin+ while this function is being executed.
No : Parameters cannot be changed using SigmaWin+ while this function is being executed.
- Automatic changes after execution of this function
Yes : Parameter set values are automatically set or adjusted after execution of this function.
No : Parameter set values are not automatically set or adjusted after execution of this function.

Parameter	Name	Mid-execution changes	Automatic changes
Pn408	Torque Related Function Switch	Yes	Yes
Pn409	1st Notch Filter Frequency	No	Yes
Pn40A	1st Notch Filter Q Value	No	No
Pn40C	2nd Notch Filter Frequency	No	Yes
Pn40D	2nd Notch Filter Q Value	No	No
Pn456	Sweep Torque Reference Amplitude	No	No

6.19 Online Vibration Monitor (Fn207)

If vibration is generated during operation and this function is executed while the servomotor power is still ON, the machine vibration can sometimes be suppressed by setting a notch filter or torque reference filter for the vibration frequencies.

When online, vibration frequency caused by machine resonance will be detected and the frequency that has the highest peak will be displayed on the panel operator. The effective torque reference filter or notch filter frequency for the vibration frequencies will be automatically selected and the related parameters will be automatically set.

In addition to this function, EasyFFT (Fn206) can be used to detect machine vibration and automatically make notch filter settings. Use the following flowchart to determine how these functions should be used.

If a DC Power Input Σ -V Series SERVOPACK is used to make adjustments, it is recommended that you use advanced autotuning. This built-in function is used to maintain interchangeability with previous models. There is normally no need to use it.

How to use EasyFFT (Fn206) and online vibration monitor (Fn207), when they are mainly used for servo gain adjustment.

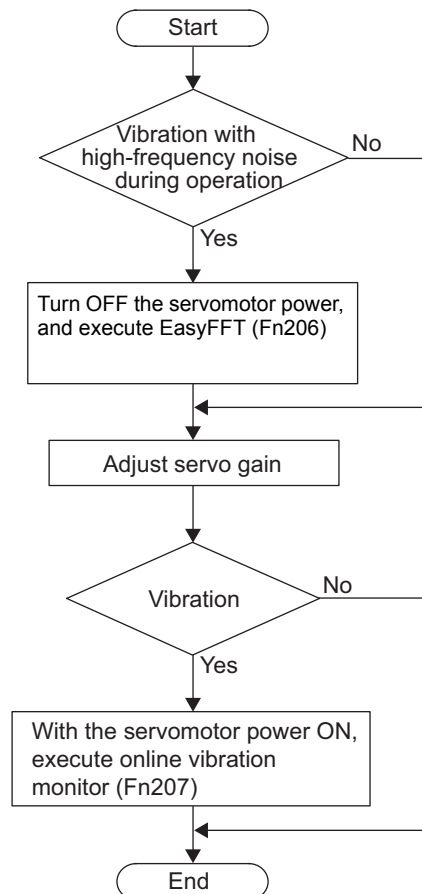

(1) Preparation

The following conditions must be met to perform online vibration monitoring.

- The write prohibited setting parameter (Fn010) must be set to Write permitted (P.0000).
- The servomotor power must be ON.
- There must be no overtravel.
- The correct moment of inertia (Pn103) must be set.
- The test without a motor function must be disabled (Pn00C.0 = 0).

(2) Operating Procedure

Use the following procedure.

1. In the SigmaWin+ main window, click **Monitor - Online Vibration Monitor**.

A message will appear as a warning to say that any changes to parameter settings might greatly affect the operation of the motor, and then ask if you want to continue.



2. Click **OK**.

The **Online Vibration Monitor** box will appear.

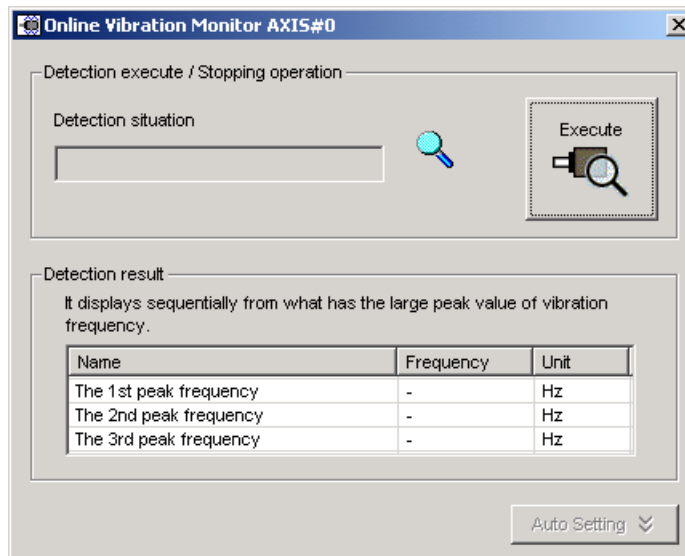

3. Click **Execute** to activate the vibration sensor.

The vibrations are detected, and the peak frequencies of the vibrations will be shown in the **Detection result** table.

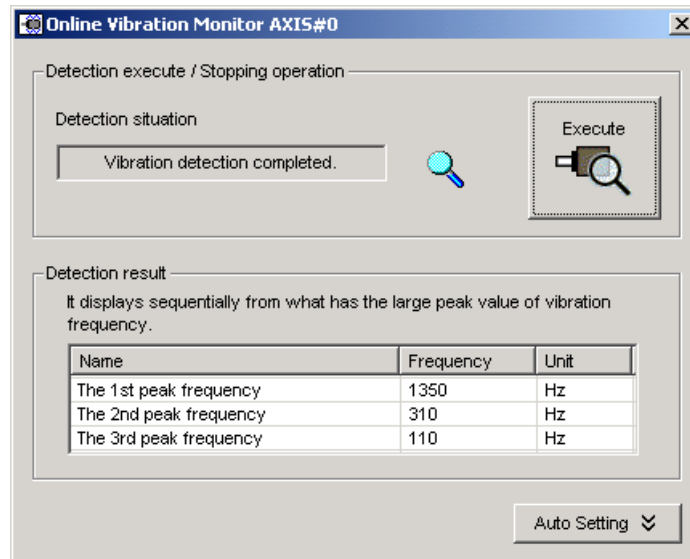

4. Click **Auto Setting**.

The pre-adjustment parameter settings will be shown in the **Previous** column in the **Write result** table.

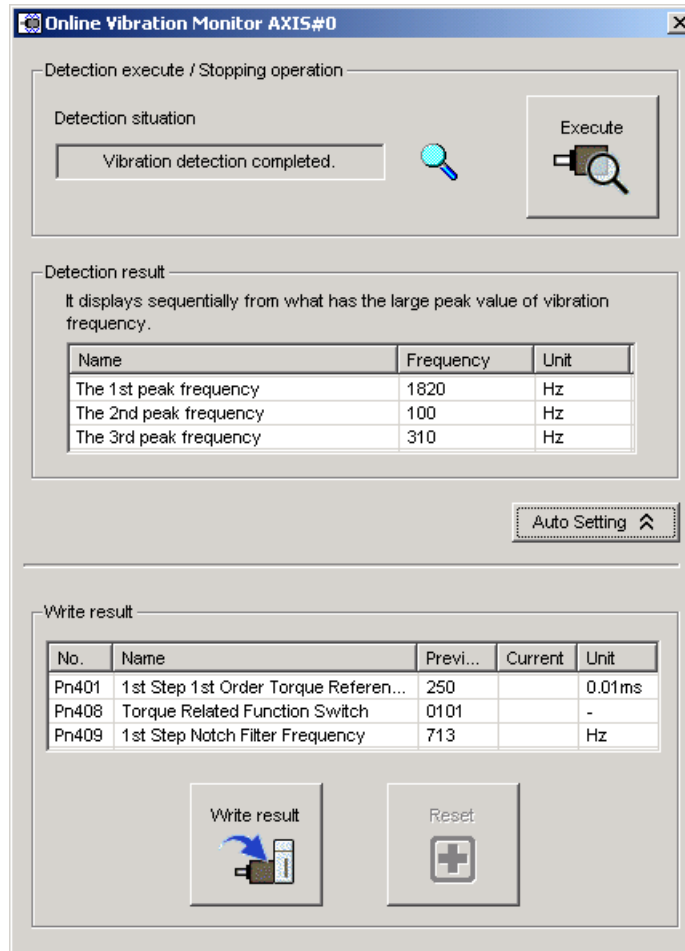

5. Click **Write result**.

The parameter values those are most effective for the measured frequencies will be shown in the **Current** column in the **Write result** table, and then saved in the SERVOPACK.

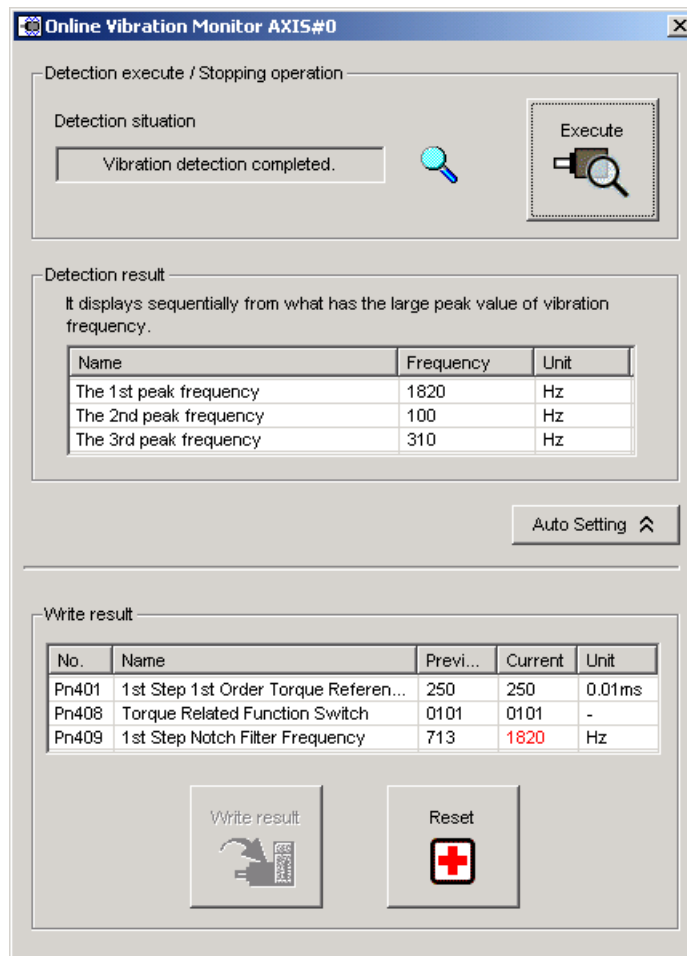

If you do not want to save the new parameter settings in the SERVOPACK, click **Reset**.

(3) Related Parameters

The following table lists parameters related to this function and their possibility of being changed while executing this function or of being changed automatically after executing this function.

- Parameters related to this function

These are parameters that are used or referenced when executing this function.

- Allowed changes during execution of this function

Yes : Parameters can be changed using SigmaWin+ while this function is being executed.

No : Parameters cannot be changed using SigmaWin+ while this function is being executed.

- Automatic changes after execution of this function

Yes : Parameter set values are automatically set or adjusted after execution of this function.

No : Parameter set values are not automatically set or adjusted after execution of this function.

Parameter	Name	Mid-execution changes	Automatic changes
Pn401	Torque Reference Filter Time Constant	No	Yes
Pn408	Torque Related Function Switch	Yes	Yes
Pn409	1st Notch Filter Frequency	No	Yes
Pn40A	1st Notch Filter Q Value	No	No
Pn40C	2nd Notch Filter Frequency	No	No
Pn40D	2nd Notch Filter Q Value	No	No

Monitor Displays (Un□□□)

7.1 List of Monitor Displays	7-2
7.2 Viewing Monitor Displays	7-3
7.2.1 System Monitor	7-3
7.2.2 Status Monitor	7-4
7.2.3 Motion Monitor	7-5
7.2.4 Input Signal Monitor	7-6
7.2.5 Output Signal Monitor	7-7

7.1 List of Monitor Displays

The monitor displays can be used for monitoring the I/O signal status, and SERVOPACK internal status.

Refer to the following table.

Parameter No.	Description	Unit
Un000	Motor rotating speed	min ⁻¹
Un001	Speed reference	min ⁻¹
Un002	Internal torque reference (in percentage to the rated torque)	%
Un003	Rotational angle 1 (encoder pulses from the phase-C origin: decimal display)	encoder pulse*
Un004	Rotational angle 2 (from polarity origin (electric angle))	deg
Un005	Input signal monitor	–
Un006	Output signal monitor	–
Un007	Input reference pulse speed (valid only in position control)	min ⁻¹
Un008	Position error amount (valid only in position control)	reference unit
Un009	Accumulated load ratio (in percentage to the rated torque: effective torque in cycle of 10 seconds)	%
Un00C	Input reference pulse counter	reference unit
Un00D	Feedback pulse counter	encoder pulse*
Un012	Total operation time	100 ms
Un013	Feedback pulse counter	reference unit
Un014	Effective gain monitor (gain settings 1 = 1, gain settings 2 = 2)	–
Un020	Motor rated speed	min ⁻¹
Un021	Motor maximum speed	min ⁻¹
Un030	The current backlash compensation value	0.1 reference unit
Un031	Backlash compensation setting limit value	0.1 reference unit

* For details, refer to 4.4.3 *Electronic Gear*.

7.2 Viewing Monitor Displays

Five types of SigmaWin+ monitor windows can be used.

- System Monitor
- Status Monitor
- Motion Monitor
- Input Signal Monitor
- Output Signal Monitor

The following sections describes how to open each monitor window.

7.2.1 System Monitor

To open the **System Monitor** box, in the SigmaWin+ main window, click **Monitor - Monitor - System Monitor**.

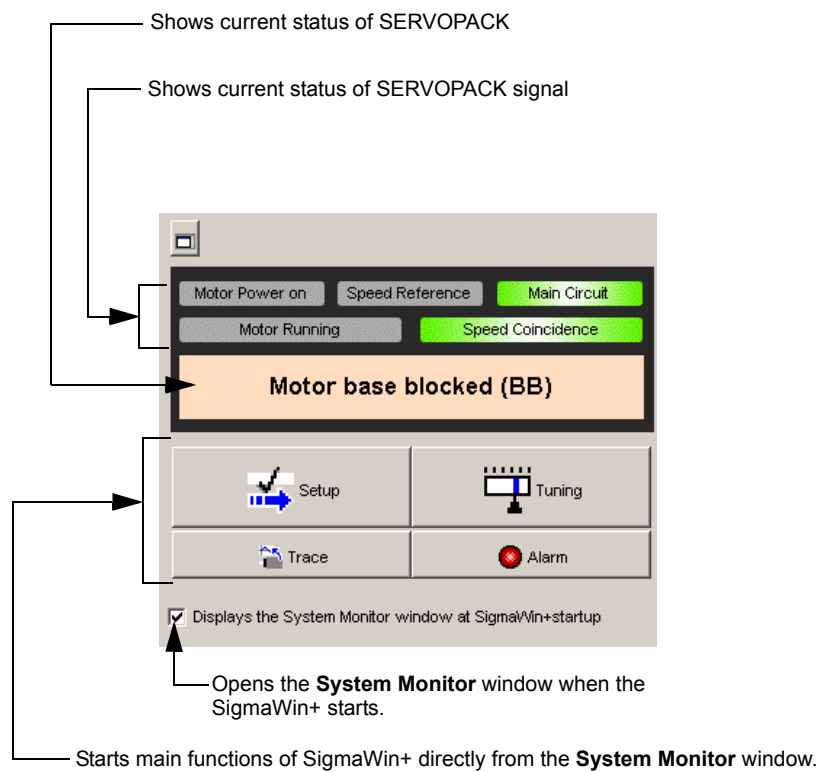

7.2.2 Status Monitor

To open the **Status Monitor** box, use the following procedure.

1. In the SigmaWin+ main window, click **Monitor - Monitor - Status Monitor**.

The **Status Monitor** box will appear.

Axis	Name	Value	
<input type="checkbox"/>	0 Main Circuit	-	
<input type="checkbox"/>	0 Encoder (PGRDY)	-	
<input type="checkbox"/>	0 Motor	-	
<input type="checkbox"/>	0 Dynamic Brake (DB)	-	
<input type="checkbox"/>	0 Rotation Direction	-	
<input type="checkbox"/>	0 Mode Switch	-	
<input type="checkbox"/>	0 Speed Reference (V-Ref)	-	
<input type="checkbox"/>	0 Torque Reference (T-Ref)	-	
<input type="checkbox"/>	0 Position Reference (PULS)	-	
<input type="checkbox"/>	0 Command Pulse Sign (SIGN)	-	
<input type="checkbox"/>	0 Clear (CLR)	-	

The items which can be monitored are listed.

2. Select the items to be monitored.

The current status of the selected item is shown in the **Value** column.

Axis	Name	Value	
<input checked="" type="checkbox"/>	0 Main Circuit	Main Circuit ON	
<input checked="" type="checkbox"/>	0 Encoder (PGRDY)	Encoder Prepar...	
<input checked="" type="checkbox"/>	0 Motor	No Motor Power	
<input type="checkbox"/>	0 Dynamic Brake (DB)	-	
<input type="checkbox"/>	0 Rotation Direction	-	
<input type="checkbox"/>	0 Mode Switch	-	
<input type="checkbox"/>	0 Speed Reference (V-Ref)	-	
<input type="checkbox"/>	0 Torque Reference (T-Ref)	-	
<input type="checkbox"/>	0 Position Reference (PULS)	-	
<input type="checkbox"/>	0 Command Pulse Sign (SIGN)	-	
<input type="checkbox"/>	0 Clear (CLR)	-	

7.2.3 Motion Monitor

To open the **Motion Monitor** box, use the following procedure.

1. In the SigmaWin+ main window, click **Monitor - Monitor - Motion Monitor**.
The **Motion Monitor** box will appear.

Axis	Name	Value	Unit
<input type="checkbox"/> 0	Alarm	-	
<input type="checkbox"/> 0	Speed Feedback	-	min-1
<input type="checkbox"/> 0	Torque Reference	-	%
<input type="checkbox"/> 0	Speed Reference	-	min-1
<input type="checkbox"/> 0	Command Pulse Speed	-	min-1
<input type="checkbox"/> 0	Deviation Counter	-	reference units
<input type="checkbox"/> 0	Angle of Rotation 1 (number of pulse...	-	pulse
<input type="checkbox"/> 0	Angle of Rotation 2 (number of degre...	-	deg
<input type="checkbox"/> 0	Cumulative Load	-	%

The items which can be monitored are listed.

2. Select the items to be monitored.
The current status of the selected item is shown in the **Value** column.

Axis	Name	Value	Unit
<input type="checkbox"/> 0	Alarm	-	
<input checked="" type="checkbox"/> 0	Speed Feedback	0	min-1
<input type="checkbox"/> 0	Torque Reference	-	%
<input checked="" type="checkbox"/> 0	Speed Reference	0	min-1
<input type="checkbox"/> 0	Command Pulse Speed	-	min-1
<input type="checkbox"/> 0	Deviation Counter	-	reference units
<input checked="" type="checkbox"/> 0	Angle of Rotation 1 (number of pulse...	371	pulse
<input checked="" type="checkbox"/> 0	Angle of Rotation 2 (number of degre...	0	deg
<input type="checkbox"/> 0	Cumulative Load	-	%

7.2.4 Input Signal Monitor

To open the **Input Signal Monitor** box, use the following procedure.

1. In the SigmaWin+ main window, click **Monitor - Monitor - Input Signal Monitor**.
The **Input Signal Monitor** box will appear.

Axis	Input Terminal Name	Signal Name	Value	
<input type="checkbox"/>	SI0 (CN1-40)	/S-ON	-	
<input type="checkbox"/>	SI1 (CN1-41)	/P-CON	-	
<input type="checkbox"/>	SI2 (CN1-42)	P-OT	-	
<input type="checkbox"/>	SI3 (CN1-43)	N-OT	-	
<input type="checkbox"/>	SI4 (CN1-44)	/ALM-RST	-	
<input type="checkbox"/>	SI5 (CN1-45)	/P-CL	-	
<input type="checkbox"/>	SI6 (CN1-46)	/N-CL	-	
<input type="checkbox"/>	SEN		-	

The items which can be monitored are listed.

2. Select the items to be monitored.
The current status of the selected item is shown in the **Value** column.

Axis	Input Terminal Name	Signal Name	Value	
<input checked="" type="checkbox"/>	SI0 (CN1-40)	/S-ON	Hi	
<input checked="" type="checkbox"/>	SI1 (CN1-41)	/P-CON	Hi	
<input checked="" type="checkbox"/>	SI2 (CN1-42)	P-OT	Hi	
<input type="checkbox"/>	SI3 (CN1-43)	N-OT	-	
<input type="checkbox"/>	SI4 (CN1-44)	/ALM-RST	-	
<input type="checkbox"/>	SI5 (CN1-45)	/P-CL	-	
<input type="checkbox"/>	SI6 (CN1-46)	/N-CL	-	
<input type="checkbox"/>	SEN		-	

Hi indicates that the input signal is off and **Lo** indicates that the input signal is on. When no input signal is allocated, **Lo** will be shown in the column.

7.2.5 Output Signal Monitor

To open the **Output Signal Monitor** box, use the following procedure.

1. In the SigmaWin+ main window, click **Monitor - Monitor - Output Signal Monitor**.
The **Output Signal Monitor** box will appear.

Axis	Output Terminal N...	Signal Name	Value
<input type="checkbox"/> 0	ALM		-
<input type="checkbox"/> 0	SO1 (CN1-25, 26)	/WARN	-
<input type="checkbox"/> 0	SO2 (CN1-27, 28)	/BK	-
<input type="checkbox"/> 0	SO3 (CN1-29, 30)	/S-RDY	-
<input type="checkbox"/> 0	ALO1		-
<input type="checkbox"/> 0	ALO2		-
<input type="checkbox"/> 0	ALO3		-

The items which can be monitored are listed.

2. Select the items to be monitored.
The current status of the selected item is shown in the **Value** column.

Axis	Output Terminal N...	Signal Name	Value
<input checked="" type="checkbox"/> 0	ALM		Hi
<input checked="" type="checkbox"/> 0	SO1 (CN1-25, 26)	/WARN	Hi
<input checked="" type="checkbox"/> 0	SO2 (CN1-27, 28)	/BK	Hi
<input type="checkbox"/> 0	SO3 (CN1-29, 30)	/S-RDY	-
<input type="checkbox"/> 0	ALO1		-
<input type="checkbox"/> 0	ALO2		-
<input type="checkbox"/> 0	ALO3		-

Hi indicates that the input signal is off and **Lo** indicates that the input signal is on. When no output signal is allocated, **Lo** will be shown in the column.

Troubleshooting

8.1 Alarm Displays	8-2
8.1.1 List of Alarms	8-2
8.1.2 Troubleshooting of Alarms	8-5
8.2 Warning Displays	8-15
8.2.1 List of Warnings	8-15
8.2.2 Troubleshooting of Warnings	8-16
8.3 Monitoring Communication Data on Occurrence of an Alarm or Warning	8-19
8.4 Troubleshooting Malfunction Based on Operation and Conditions of the Servomotor	8-20

8.1 Alarm Displays

The following sections describe troubleshooting in response to alarm displays.

The alarm name, alarm meaning, alarm stopping method, and alarm reset capability are listed in order of the alarm numbers in *8.1.1 List of Alarms*.

The causes of alarms and troubleshooting methods are provided in *8.1.2 Troubleshooting of Alarms*.

8.1.1 List of Alarms

This section provides list of alarms.

■ Servomotor Stopping Method

If an alarm occurs, the servomotor can be stopped by doing either of the following operations.

Gr.1: The servomotor coasts to a stop when an alarm occurs.

Gr.2: The servomotor is stopped according to the setting in Pn00B.1 if an alarm occurs. Pn00B.1 is factory-set to stop the servomotor by setting the speed reference to "0." The servomotor under torque control will always use the Gr.1 method to stop. By setting Pn00B.1 to 1, the servomotor stops using the same method as Gr.1. When coordinating a number of servomotors, use this stopping method to prevent machine damage that may result due to differences in the stop method.

■ Alarm Reset

Available: Removing the cause of alarm and then executing the alarm reset can clear the alarm.

N/A: Executing the alarm reset cannot clear the alarm.

Alarm Number	Alarm Name	Meaning	Servo-motor Stopping Method	Alarm Reset
A.020	Parameter Checksum Error 1	The data of the parameter in the SERVOPACK is incorrect.	Gr.1	N/A
A.021	Parameter Format Error 1	The data of the parameter in the SERVOPACK is incorrect.	Gr.1	N/A
A.022	System Checksum Error 1	The data of the parameter in the SERVOPACK is incorrect.	Gr.1	N/A
A.030	Main Circuit Detector Error	Detection data for main circuit is incorrect.	Gr.1	Available
A.040	Parameter Setting Error 1	The parameter setting is outside the setting range.	Gr.1	N/A
A.042	Parameter Combination Error	Combination of some parameters exceeds the setting range.	Gr.1	N/A
A.04A	Parameter Setting Error 2	Bank member/bank data setting is incorrect.	Gr.1	N/A
A.050	Combination Error	The SERVOPACK and the servomotor capacities do not match each other.	Gr.1	Available
A.051	Unsupported Device Alarm	The device unsupported was connected.	Gr.1	N/A
A.0b0	Cancelled Servo ON Command Alarm	The servo ON command (SV_ON) was sent from the host controller after executing a utility function that turns ON servomotor.	Gr.1	Available
A.100	Overcurrent or Heat Sink Overheated	An overcurrent flowed through the IGBT or the heat sink of the SERVOPACK was overheated.	Gr.1	N/A
A.400	Overvoltage	Main circuit DC voltage is excessively high.	Gr.1	Available
A.450	Main-Circuit Capacitor Overvoltage	The capacitor of the main circuit has deteriorated or is faulty.	Gr.1	N/A
A.510	Overspeed	The servomotor speed is above the maximum rotational speed.	Gr.1	Available
A.520	Vibration Alarm	Incorrect vibration at the motor speed was detected.	Gr.1	Available

(cont'd)

Alarm Number	Alarm Name	Meaning	Servo-motor Stopping Method	Alarm Reset
A.521	Autotuning Alarm	Vibration was detected while performing tuning-less function.	Gr.1	Available
A.710	Overload: High Load	The servomotor was operating for several seconds to several tens of seconds under a torque largely exceeding ratings.	Gr.2	Available
A.720	Overload: Low Load	The servomotor was operating continuously under a torque exceeding ratings.	Gr.1	Available
A.7A0	Heat Sink Overheated	The heat sink of the SERVOPACK exceeded 90°C.	Gr.2	Available
A.810	Encoder Backup Error	The power supplies to the encoder all failed and position data was lost.	Gr.1	N/A
A.820	Encoder Checksum Error	The checksum results of encoder memory is incorrect.	Gr.1	N/A
A.830	Absolute Encoder Battery Error	The battery voltage was lower than the specified value after the control power supply was turned ON.	Gr.1	Available
A.840	Encoder Data Error	Data in the encoder is incorrect.	Gr.1	N/A
A.850	Encoder Overspeed	The encoder was rotating at high speed when the power was turned ON.	Gr.1	N/A
A.860	Encoder Overheated	The internal temperature of encoder is too high.	Gr.1	N/A
A.b31	Current Detection Error 1	The current detection circuit for phase U is faulty.	Gr.1	N/A
A.b32	Current Detection Error 2	The current detection circuit for phase V is faulty.	Gr.1	N/A
A.b33	Current Detection Error 3	The detection circuit for the current is faulty.	Gr.1	N/A
A.b6A	MECHATROLINK Communications ASIC Error 1	ASIC error occurred in the MECHATROLINK communications.	Gr.1	N/A
A.b6b	MECHATROLINK Communications ASIC Error 2	ASIC error occurred in the MECHATROLINK communications.	Gr.2	N/A
A.bE0	Firmware Error	An internal program error occurred in the SERVOPACK.	Gr.1	N/A
A.bF0	System Alarm 0	"Internal program error 0" of the SERVOPACK occurred.	Gr.1	N/A
A.bF1	System Alarm 1	"Internal program error 1" of the SERVOPACK occurred.	Gr.1	N/A
A.bF2	System Alarm 2	"Internal program error 2" of the SERVOPACK occurred.	Gr.1	N/A
A.bF3	System Alarm 3	"Internal program error 3" of the SERVOPACK occurred.	Gr.1	N/A
A.bF4	System Alarm 4	"Internal program error 4" of the SERVOPACK occurred.	Gr.1	N/A
A.C10	Servo Overrun Detected	The servomotor ran out of control.	Gr.1	Available
A.C80	Absolute Encoder Clear Error and Multiturn Limit Setting Error	The multiturn for the absolute encoder was not properly cleared or set.	Gr.1	N/A
A.C90	Encoder Communications Error	Communications between the SERVOPACK and the encoder is not possible.	Gr.1	N/A
A.C91	Encoder Communications Position Data Error	An encoder position data calculation error occurred.	Gr.1	N/A

(cont'd)

Alarm Number	Alarm Name	Meaning	Servo-motor Stopping Method	Alarm Reset
A.C92	Encoder Communications Timer Error	An error occurs in the communications timer between the encoder and the SERVOPACK.	Gr.1	N/A
A.CA0	Encoder Parameter Error	Encoder parameters are faulty.	Gr.1	N/A
A.Cb0	Encoder Echoback Error	Contents of communications with encoder are incorrect.	Gr.1	N/A
A.CC0	Multiturn Limit Disagreement	Different multiturn limits have been set in the encoder and the SERVOPACK.	Gr.1	N/A
A.d00	Position Error Overflow	Position error exceeded the value of excessive position error alarm level (Pn520) when the servomotor power is ON.	Gr.1	Available
A.d01	Position Error Overflow Alarm at Servo ON	This alarm occurs if the servomotor power is turned ON when the position error is greater than the set value of Pn526 while the servomotor power is OFF.	Gr.1	Available
A.d02	Position Error Overflow Alarm by Speed Limit at Servo ON	When the position errors remain in the error counter, Pn529 limits the speed if the servomotor power is turned ON. If Pn529 limits the speed in such a state, this alarm occurs when position references are input and the number of position errors exceeds the value set for the excessive position error alarm level (Pn520).	Gr.2	Available
A.E02	MECHATROLINK Internal Synchronization Error 1	Synchronization error during MECHATROLINK communications with the SERVOPACK.	Gr.1	Available
A.E40	MECHATROLINK Transmission Cycle Setting Error	The setting of the MECHATROLINK transmission cycle is out of the allowable range.	Gr.2	Available
A.E50	MECHATROLINK Synchronization Error	A synchronization error occurs during MECHATROLINK communications.	Gr.2	Available
A.E51	MECHATROLINK Synchronization Failed	A synchronization failure occurs in MECHATROLINK communications.	Gr.2	Available
A.E60	MECHATROLINK Communications Error (Reception error)	A communications error occurs continuously during MECHATROLINK communications.	Gr.2	Available
A.E61	MECHATROLINK Transmission Cycle Error (Synchronization interval error)	The transmission cycle fluctuates during MECHATROLINK communications.	Gr.2	Available
A.EA2	DRV Alarm 2 (SERVOPACK WDC error)	A SERVOPACK DRV alarm 0 occurs.	Gr.2	Available
A.Ed1	Command Execution Timeout	A timeout error occurred when using a MECHATROLINK command.	Gr.2	Available
A.F50	Servomotor Main Circuit Cable Disconnection	The servomotor did not operate or power was not supplied to the servomotor even though the SV_ON (Servo ON) command was input when the servomotor was ready to receive it.	Gr.1	Available
A.--	Not an error	Normal operation status	—	—

8.1.2 Troubleshooting of Alarms

If an error occurs in the servo drive, the ALM signal will be output. The alarm that occurs can be checked on the **Alarm Display** dialog box of the SigmaWin+.

Refer to the following table to identify the cause of an alarm and the action to be taken.

Contact your Yaskawa representative if the problem cannot be solved by the described corrective action.

Alarm Number: Alarm Name (Alarm Description)	Cause	Investigative Actions	Corrective Actions
A.020: Parameter Checksum Error 1 (The parameter data in the SERVOPACK is incorrect.)	The power supply voltage suddenly dropped.	Measure the power supply voltage.	Set the power supply voltage within the specified range, and set Fn005 to initialize the parameter.
	The power supply went OFF while changing a parameter setting.	Check the circumstances when the power supply went OFF.	Set Fn005 to initialize the parameter and then set the parameter again.
	The number of times that parameters were written exceeded the limit.	Check to see if the parameters were frequently changed through the host controller.	The SERVOPACK may be faulty. Replace the SERVOPACK. Reconsider the method of writing parameters.
	Malfunction caused by noise from the AC power supply or grounding line, static electricity noise, etc.	Restart the SERVOPACK several times. If the alarm still occurs, there may be noise interference.	Take countermeasures against noise.
	Gas, water drops, or cutting oil entered the SERVOPACK and caused failure of the internal components.	Check the installation conditions.	The SERVOPACK may be faulty. Replace the SERVOPACK.
	A SERVOPACK fault occurred.	Restart the SERVOPACK several times. If the alarm still occurs, the SERVOPACK may be faulty.	The SERVOPACK may be faulty. Replace the SERVOPACK.
A.021: Parameter Format Error 1 (The parameter data in the SERVOPACK is incorrect.)	The software version of SERVOPACK that caused the alarm is older than that of the written parameter.	Check Fn012 to see if the set software version agrees with that of the SERVOPACK. If not, an alarm may occur.	Write the parameter of another SERVOPACK of the same model with the same software version. Restart the SERVOPACK.
	A SERVOPACK fault occurred.	–	The SERVOPACK may be faulty. Replace the SERVOPACK.
A.022: System Checksum Error 1 (The parameter data in the SERVOPACK is incorrect.)	The power supply voltage suddenly dropped.	Measure the power supply voltage.	The SERVOPACK may be faulty. Replace the SERVOPACK.
	The power supply went OFF while setting a utility function.	Check the circumstances when the power supply went OFF.	The SERVOPACK may be faulty. Replace the SERVOPACK.
	A SERVOPACK fault occurred.	Restart the SERVOPACK several times. If the alarm still occurs, the SERVOPACK may be faulty.	The SERVOPACK may be faulty. Replace the SERVOPACK.
A.030: Main Circuit Detector Error	A SERVOPACK fault occurred.	–	The SERVOPACK may be faulty. Replace the SERVOPACK.
A.040: Parameter Setting Error 1 (The parameter setting was out of the setting range.)	The SERVOPACK and servomotor capacities do not match each other.	Check the combination of SERVOPACK and servomotor capacities.	Select the proper combination of SERVOPACK and servomotor capacities.
	A SERVOPACK fault occurred.	–	The SERVOPACK may be faulty. Replace the SERVOPACK.
	The parameter setting is out of the setting range.	Check the setting ranges of the parameters that have been changed.	Set the parameter to a value within the setting range.
	The electronic gear ratio is out of the setting range.	Check the electronic gear ratio. The ratio must satisfy: $0.001 < (Pn20E/Pn210) < 4000$.	Set the electronic gear ratio in the range: $0.001 < (Pn20E/Pn210) < 4000$.

(cont'd)

Alarm Number: Alarm Name (Alarm Description)	Cause	Investigative Actions	Corrective Actions
A.042: Parameter Combination Error	The speed of program JOG operation (Fn004) is lower than the setting range after having changed the electronic gear ratio (Pn20E/Pn210) or the servomotor.	Check if the detection conditions *1 are satisfied.	Decrease the setting of the electronic gear ratio (Pn20E/Pn210).
	The speed of program JOG operation (Fn004) is lower than the setting range after having changed the setting of the program JOG movement speed (Pn533).	Check if the detection conditions *1 are satisfied.	Increase the setting of the program JOG movement speed (Pn533).
	The moving speed of advanced autotuning is lower than the setting range after having changed the electronic gear ratio (Pn20E/Pn210) or the servomotor.	Check if the detection conditions *2 are satisfied.	Decrease the setting of the electronic gear ratio (Pn20E/Pn210).
A.04A: Parameter Setting Error 2	For a 4-byte parameter bank, no registration in two consecutive bytes for two bank members.	–	Change the number of bytes for bank members to an appropriate value.
	The total amount of bank data exceeds 64. (Pn900 × Pn901 > 64)	–	Reduce the total amount of bank data to 64 or less.
A.050: Combination Error (The SERVOPACK and servomotor capacities do not correspond.)	The SERVOPACK and servomotor capacities do not match each other.	Check the capacities to see if they satisfy the following condition: $\frac{1}{4} \leq \frac{\text{Servomotor capacity}}{\text{SERVOPACK capacity}} \leq 4$	Select the proper combination of SERVOPACK and servomotor capacities.
	An encoder fault occurred.	Replace the servomotor and see if the alarm occurs again.	Replace the servomotor (encoder).
	A SERVOPACK fault occurred.	–	The SERVOPACK may be faulty. Replace the SERVOPACK.
A.051: Unsupported Device Alarm	An unsupported encoder is connected to the SERVOPACK.	Check the product specifications, and select the correct model.	Select the correct combination of units.
A.0b0: Cancelled Servo ON Command Alarm	After executing the utility function to turn ON the power to the motor, the servo ON command (SV_ON) was sent from the host controller.	–	Restart the SERVOPACK or execute a software reset.

*1. Detection conditions

If one of the following conditions detected, an alarm occurs.

- $\text{Pn533} [\text{min}^{-1}] \times \frac{\text{Encoder resolution}}{6 \times 10^5} \leq \frac{\text{Pn20E}}{\text{Pn210}}$
- $\text{Max Motor Speed} [\text{min}^{-1}] \times \frac{\text{Encoder resolution}}{\text{About } 3.66 \times 10^{12}} \geq \frac{\text{Pn20E}}{\text{Pn210}}$

*2. Detection conditions

If one of the following conditions detected, an alarm occurs.

- $\text{Rated Motor Speed} [\text{min}^{-1}] \times \frac{1}{3} \times \frac{\text{Encoder resolution}}{6 \times 10^5} \leq \frac{\text{Pn20E}}{\text{Pn210}}$
- $\text{Max Motor Speed} [\text{min}^{-1}] \times \frac{\text{Encoder resolution}}{\text{About } 3.66 \times 10^{12}} \geq \frac{\text{Pn20E}}{\text{Pn210}}$

(cont'd)

Alarm Number: Alarm Name (Alarm Description)	Cause	Investigative Actions	Corrective Actions
A.100: Overcurrent or Heat Sink Overheated (An overcurrent flowed through the IGBT or heat sink of SERVOPACK overheated.)	Incorrect wiring or contact fault of servomotor main circuit cables.	Check the wiring. Refer to <i>3.1 Main Circuit Wiring</i> .	Correct the wiring.
	Short-circuit or ground fault of servomotor main circuit cables.	Check for short-circuits across the servomotor terminal phases U, V, and W, or between the grounding and servomotor terminal phases U, V, or W. Refer to <i>3.1 Main Circuit Wiring</i> .	The cable may be short-circuited. Replace the cable.
	Short-circuit or ground fault inside the servomotor.	Check for short-circuits across the servomotor terminal phases U, V, and W, or between the grounding and servomotor terminal phases U, V, or W. Refer to <i>3.1 Main Circuit Wiring</i> .	The servomotor may be faulty. Replace the servomotor.
	Short-circuit or ground fault inside the SERVOPACK.	Check for short-circuits across the servomotor connection terminals U, V, and W on the SERVOPACK, or between the grounding and terminal U, V, or W. Refer to <i>3.1 Main Circuit Wiring</i> .	The SERVOPACK may be faulty. Replace the SERVOPACK.
	A heavy load was applied while the servomotor was stopped or running at a low speed.	Check to see if the operating conditions are outside servo drive specifications.	Reduce the load applied to the servomotor or increase the operating speed.
	Malfunction caused by noise interference.	Improve the wiring or installation environment, such as by reducing noise, and check to see if the alarm recurs.	Take countermeasures for noise, such as correct wiring of the FG. Use an FG wire size equivalent to the SERVOPACK main circuit wire size.
	A SERVOPACK fault occurred.	–	Restart the SERVOPACK. If the alarm still occurs, the SERVOPACK may be faulty. Replace the SERVOPACK.
A.400: Overvoltage (Detected in the SERVOPACK main circuit power supply section.)	The DC power supply voltage exceeded 60 V.	Measure the power supply voltage.	Set DC power supply voltage within the specified range.
	The power supply is unstable, or was influenced by a lightning surge.	Measure the power supply voltage.	Improve the power supply conditions by installing a surge absorber, etc. Then, restart the SERVOPACK. If the alarm still occurs, the SERVOPACK may be faulty. Replace the SERVOPACK.
	Voltage for DC power supply was too high during acceleration or deceleration.	Check the power supply voltage and the speed and torque during operation.	Set DC power supply voltage within the specified range.
	The moment of inertia ratio exceeded the allowable value.	Confirm that the moment of inertia ratio is within the allowable range.	Increase the deceleration time, or reduce the load.
	A SERVOPACK fault occurred.	–	Turn the control power OFF and then ON again while the main circuit power supply is OFF. If the alarm still occurs, the SERVOPACK may be faulty. Replace the SERVOPACK.
A.450: Main-Circuit Capacitor Overvoltage	A SERVOPACK fault occurred.	–	Replace the SERVOPACK.

(cont'd)

Alarm Number: Alarm Name (Alarm Description)	Cause	Investigative Actions	Corrective Actions
A.510: Overspeed (The servomotor speed exceeds the maximum.)	The order of phases U, V, and W in the servomotor wiring is incorrect.	Check the motor wiring.	Confirm that the servomotor is correctly wired.
	A reference value exceeding the overspeed detection level was input.	Check the input value.	Reduce the reference value or adjust the gain.
	The motor speed exceeded the maximum.	Check the motor speed waveform.	Reduce the speed reference input gain, adjust the servo gain, or reconsider the operating conditions.
	A SERVOPACK fault occurred.	–	The SERVOPACK may be faulty. Replace the SERVOPACK.
A.520: Vibration Alarm	Abnormal vibration was detected at the motor speed.	Check for abnormal noise from the servomotor, and check the speed and torque waveforms during operation.	Reduce the motor speed or reduce the speed loop gain (Pn100).
	The moment of inertia ratio (Pn103) value is greater than the actual value or is greatly changed.	Check the moment of inertia ratio.	Set the moment of inertia ratio (Pn103) to an appropriate value.
A.521: Autotuning Alarm (Vibration was detected while executing the one-parameter tuning, EasyFFT, or tuning-less function.)	The servomotor vibrated considerably while performing tuning-less function.	Check the motor speed waveform.	Reduce the load so that the moment of inertia ratio falls within the allowable value, or raise the load level using the tuning-less levels setting (Fn200) or reduce the rigidity level.
	The servomotor vibrated considerably during one-parameter tuning or EasyFFT.	Check the motor speed waveform.	Check the operation procedure of corresponding function and take a corrective action.
A.710: A.720: Overload A.710: High Load A.720: Low Load	Incorrect wiring or contact fault of servomotor and encoder.	Check the wiring.	Confirm that the servomotor and encoder are correctly wired.
	Operation beyond the overload protection characteristics.	Check the servomotor overload characteristics and executed run command.	Reconsider the load conditions and operating conditions. Or, increase the motor capacity.
	Excessive load was applied during operation because the servomotor was not driven due to mechanical problems.	Check the executed operation reference and motor speed.	Remove the mechanical problems.
	A SERVOPACK fault occurred.	–	The SERVOPACK may be faulty. Replace the SERVOPACK.
A.7A0: Heat Sink Overheated (Detected when the heat sink temperature exceeds 90°C.)	The surrounding air temperature is too high.	Check the surrounding air temperature using a thermostat.	Decrease the surrounding air temperature by improving the SERVOPACK installation conditions.
	The overload alarm has been reset by turning OFF the power too many times.	Check the alarm history display (Fn000) to see if the overload alarm was reported.	Change the method for resetting the alarm.
	Excessive load was applied during operation.	Check the accumulated load ratio (Un009) to see the load during operation.	Reconsider the load conditions and operating conditions.
	Incorrect SERVOPACK installation orientation or/and insufficient space around the SERVOPACK.	Check the SERVOPACK installation conditions.	Install the SERVOPACK correctly as specified.
	A SERVOPACK fault occurred.	–	The SERVOPACK may be faulty. Replace the SERVOPACK.

(cont'd)

Alarm Number: Alarm Name (Alarm Description)	Cause	Investigative Actions	Corrective Actions
A.810: Encoder Backup Error (Only when an absolute encoder is connected.) (Detected on the encoder side.)	Alarm occurred when the power to the absolute encoder was initially turned ON.	Check to see if the power was turned ON initially.	Set up the encoder (Fn008).
	The encoder cable disconnected, and connected again.	Check to see if the power was turned ON initially.	Confirm the connection and set up the encoder (Fn008).
	The power from both the control power supply (+5 V) from the SERVOPACK and the battery power supply is not being supplied.	Check the encoder connector battery or the connector contact status.	Replace the battery or take similar measures to supply power to the encoder, and set up the encoder (Fn008).
	An absolute encoder fault occurred.	—	If the alarm cannot be reset by setting up the encoder again, replace the servomotor.
	A SERVOPACK fault occurred.	—	The SERVOPACK may be faulty. Replace the SERVOPACK.
A.820: Encoder Checksum Error (Detected on the encoder side.)	An encoder fault occurred.	—	<ul style="list-style-type: none"> Absolute encoder Set up the encoder again using Fn008. If the alarm still occurs, the servomotor may be faulty. Replace the servomotor. One-turn absolute encoder or incremental encoder The servomotor may be faulty. Replace the servomotor.
	A SERVOPACK fault occurred.	—	The SERVOPACK may be faulty. Replace the SERVOPACK.
A.830: Absolute Encoder Battery Error (The absolute encoder battery voltage is lower than the specified value.)	The battery connection is incorrect.	Check the battery connection.	Reconnect the battery.
	The battery voltage is lower than the specified value 2.7 V.	Measure the battery voltage.	Replace the battery.
	A SERVOPACK fault occurred.	—	The SERVOPACK may be faulty. Replace the SERVOPACK.
A.840: Encoder Data Error (Detected on the encoder side.)	An encoder malfunctioned.	—	Restart the SERVOPACK. If the alarm still occurs, the servomotor may be faulty. Replace the servomotor.
	Malfunction of encoder because of noise interference, etc.	—	Correct the wiring around the encoder by separating the encoder cable from the servomotor main circuit cable or by checking the grounding and other wiring.
A.850: Encoder Overspeed (Detected when the control power supply was turned ON.) (Detected on the encoder side.)	The servomotor speed is higher than 200 min^{-1} when the control power supply was turned ON.	Check the motor rotating speed (Un000) to confirm the servomotor speed when the power is turned ON.	Reduce the servomotor speed to a value less than 200 min^{-1} , and turn ON the control power supply.
	An encoder fault occurred.	—	Restart the SERVOPACK. If the alarm still occurs, the servomotor may be faulty. Replace the servomotor.
	A SERVOPACK fault occurred.	—	Restart the SERVOPACK. If the alarm still occurs, the SERVOPACK may be faulty. Replace the SERVOPACK.

(cont'd)

Alarm Number: Alarm Name (Alarm Description)	Cause	Investigative Actions	Corrective Actions
A.860: Encoder Overheated (Only when an absolute encoder is connected.) (Detected on the encoder side.)	The ambient operating temperature around the servomotor is too high.	Measure the ambient operating temperature around the servomotor.	The ambient operating temperature must be 40°C or less.
	The motor load is greater than the rated load.	Check the accumulated load ratio (Un009) to see the load.	The motor load must be within the specified range.
	An encoder fault occurred.	—	Restart the SERVOPACK. If the alarm still occurs, the servomotor may be faulty. Replace the servomotor.
	A SERVOPACK fault occurred.	—	Restart the SERVOPACK. If the alarm still occurs, the SERVOPACK may be faulty. Replace the SERVOPACK.
A.b31: Current Detection Error 1	The current detection circuit for phase U is faulty.	—	Restart the SERVOPACK. If the alarm still occurs, the SERVOPACK may be faulty. Replace the SERVOPACK.
A.b32: Current Detection Error 2	The current detection circuit for phase V is faulty.	—	Restart the SERVOPACK. If the alarm still occurs, the SERVOPACK may be faulty. Replace the SERVOPACK.
A.b33: Current Detection Error 3	The detection circuit for the current is faulty.	—	Restart the SERVOPACK. If the alarm still occurs, the SERVOPACK may be faulty. Replace the SERVOPACK.
	The servomotor main circuit cable is disconnected.	Check for disconnection of the servomotor main circuit cable.	Correct the servomotor wiring.
A.b6A: MECHATROLINK Communications ASIC Error 1	SERVOPACK MECHATROLINK communication section fault.	—	Restart the SERVOPACK. If the alarm still occurs, the SERVOPACK may be faulty. Replace the SERVOPACK.
A.b6b: MECHATROLINK Communications ASIC Error 2	MECHATROLINK data reception error occurred due to noise interference.	—	Take measures against noise. Check the MECHATROLINK communications cable and FG wiring and take measures such as adding ferrite core on the MECHATROLINK communications cable.
	SERVOPACK MECHATROLINK communication section fault.	—	Restart the SERVOPACK. If the alarm still occurs, the SERVOPACK may be faulty. Replace the SERVOPACK.
A.bE0: Firmware Error	A SERVOPACK fault occurred.	—	Restart the SERVOPACK. If the alarm still occurs, the SERVOPACK may be faulty. Replace the SERVOPACK.
A.bF0: System Alarm 0	A SERVOPACK fault occurred.	—	Restart the SERVOPACK. If the alarm still occurs, the SERVOPACK may be faulty. Replace the SERVOPACK.
A.bF1: System Alarm 1	A SERVOPACK fault occurred.	—	Restart the SERVOPACK. If the alarm still occurs, the SERVOPACK may be faulty. Replace the SERVOPACK.
A.bF2: System Alarm 2	A SERVOPACK fault occurred.	—	Restart the SERVOPACK. If the alarm still occurs, the SERVOPACK may be faulty. Replace the SERVOPACK.

(cont'd)

Alarm Number: Alarm Name (Alarm Description)	Cause	Investigative Actions	Corrective Actions
A.bF3: System Alarm 3	A SERVOPACK fault occurred.	—	Restart the SERVOPACK. If the alarm still occurs, the SERVOPACK may be faulty. Replace the SERVOPACK.
A.bF4: System Alarm 4	A SERVOPACK fault occurred.	—	Restart the SERVOPACK. If the alarm still occurs, the SERVOPACK may be faulty. Replace the SERVOPACK.
A.C10: Servo Overrun Detected (Detected when the servomotor power is ON.)	The order of phases U, V, and W in the servomotor wiring is incorrect.	Check the motor wiring.	Confirm that the servomotor is correctly wired.
	An encoder fault occurred.	—	If the alarm still occurs after restarting the SERVOPACK, even though the servomotor is correctly wired, the servomotor may be faulty. Replace the servomotor.
	A SERVOPACK fault occurred.	—	Restart the SERVOPACK. If the alarm still occurs, the SERVOPACK may be faulty. Replace the SERVOPACK.
A.C80: Absolute Encoder Clear Error and Multi- turn Limit Setting Error	An encoder fault occurred.	—	Restart the SERVOPACK. If the alarm still occurs, the servomotor may be faulty. Replace the servomotor.
	A SERVOPACK fault occurred.	—	Restart the SERVOPACK. If the alarm still occurs, the SERVOPACK may be faulty. Replace the SERVOPACK.
A.C90: Encoder Communications Error	Contact fault of connector or incorrect wiring for encoder cable.	Check the connector contact status for encoder cable.	Re-insert the connectors and confirm that the encoder is correctly wired.
	Cable disconnection for encoder cable or short-circuit. Or, incorrect cable impedance.	Check the encoder cable.	Use the cables with the specified rating.
	Corrosion caused by improper temperature, humidity, or gas, short-circuit caused by intrusion of water drops or cutting oil, or connector contact fault caused by vibration.	Check the operating environment.	Improve the operating environmental conditions, and replace the cable. If the alarm still occurs, replace the SERVOPACK.
	Malfunction caused by noise interference.	—	Correct the wiring around the encoder by separating the encoder cable from the servomotor main circuit cable or by checking the grounding and other wiring.
	A SERVOPACK fault occurred.	—	Connect the servomotor to another SERVOPACK, and turn ON the control power. If no alarm occurs, the SERVOPACK may be faulty. Replace the SERVOPACK.

(cont'd)

Alarm Number: Alarm Name (Alarm Description)	Cause	Investigative Actions	Corrective Actions
A.C91: Encoder Communications Position Data Error	Noise interference occurred on the I/O signal line because the encoder cable is bent and the sheath is damaged.	Check the encoder cable and connector.	Confirm that there is no problem with the cable layout.
	The encoder cable is bundled with a high-current line or near a high-current line.	Check the cable layout for encoder cable.	Confirm that there is no surge voltage on the cables.
	The FG potential varies because of influence from machines on the servomotor side, such as the welder.	Check the cable layout for encoder cable.	Properly ground the machines to separate from the encoder FG.
A.C92: Encoder Communications Timer Error	Noise interference occurred on the I/O signal line from the encoder.	–	Take countermeasures against noise for the encoder wiring.
	Excessive vibration and shocks were applied to the encoder.	Check the operating environment.	Reduce the machine vibration or correctly install the servomotor.
	An encoder fault occurred.	–	Restart the SERVOPACK. If the alarm still occurs, the servomotor may be faulty. Replace the servomotor.
	A SERVOPACK fault occurred.	–	Restart the SERVOPACK. If the alarm still occurs, the SERVOPACK may be faulty. Replace the SERVOPACK.
A.CA0: Encoder Parameter Error	An encoder fault occurred.	–	Restart the SERVOPACK. If the alarm still occurs, the servomotor may be faulty. Replace the servomotor.
	A SERVOPACK fault occurred.	–	Restart the SERVOPACK. If the alarm still occurs, the SERVOPACK may be faulty. Replace the SERVOPACK.
A.Cb0: Encoder Echoback Error	The wiring and contact for encoder cable are incorrect.	Check the wiring.	Correct the wiring.
	Noise interference occurred due to incorrect cable specifications of encoder cable.	–	Use tinned annealed copper shielded twisted-pair or screened unshielded twisted-pair cable with a core of at least 0.12 mm ² .
	Noise interference occurred because the wiring distance for the encoder cable is too long.	–	The wiring distance must be 50 m max.
	The FG potential varies because of influence from machines on the servomotor side, such as the welder.	Check the cable layout for encoder cable.	Properly ground the machines to separate from encoder FG.
	Excessive vibration and shocks were applied to the encoder.	Check the operating environment.	Reduce the machine vibration or correctly install the servomotor.
	An encoder fault occurred.	–	Restart the SERVOPACK. If the alarm still occurs, the servomotor may be faulty. Replace the servomotor.
	A SERVOPACK fault occurred.	–	Restart the SERVOPACK. If the alarm still occurs, the SERVOPACK may be faulty. Replace the SERVOPACK.

(cont'd)

Alarm Number: Alarm Name (Alarm Description)	Cause	Investigative Actions	Corrective Actions
A.CC0: Multiturn Limit Disagreement	The multiturn limit value of the encoder is different from that of the SERVOPACK. Or, the multiturn limit value of the SERVOPACK has been changed.	Check the value of the Pn205 of the SERVOPACK.	Execute Fn013 at the occurrence of alarm.
	A SERVOPACK fault occurred.	—	Restart the SERVOPACK. If the alarm still occurs, the SERVOPACK may be faulty. Replace the SERVOPACK.
A.d00: Position Error Overflow (Position error exceeded the value set in the excessive position error alarm level (Pn520).)	The servomotor U, V, and W wirings is faulty.	Check the servomotor main circuit cable connection.	Confirm that there is no contact fault in the motor wiring or encoder wiring.
	The position reference speed is too high.	Reduce the reference speed, and operate the SERVOPACK.	Reduce the position reference speed or acceleration of position reference. Or, reconsider the electronic gear ratio.
	The acceleration of the position reference is too high.	Reduce the reference acceleration, and operate the SERVOPACK.	Reduce the reference acceleration of the position reference using a MECHATROLINK command, or smooth the acceleration of the position reference by selecting the position reference filter (ACCFIL) using a MECHATROLINK command.
	Setting of the excessive position error alarm level (Pn520) is low against the operating condition.	Check the alarm level (Pn520) to see if it is set to an appropriate value.	Set the Pn520 to proper value.
	A SERVOPACK fault occurred.	—	Restart the SERVOPACK. If the alarm still occurs, the SERVOPACK may be faulty. Replace the SERVOPACK.
A.d01: Position Error Overflow Alarm at Servo ON	This alarm occurs if the servomotor power is turned ON when the position error is greater than the set value of Pn526 while the servomotor power is OFF.	Check the position error amount (Un008) while the servomotor power is OFF.	Correct the excessive position error alarm level at servo ON (Pn526).
A.d02: Position Error Overflow Alarm by Speed Limit at Servo ON	When the position errors remain in the error counter, Pn529 limits the speed if the servomotor power is ON. If Pn529 limits the speed in such a state, this alarm occurs when position references are input and the number of position errors exceeds the value set for the excessive position error alarm level (Pn520).	—	Correct the excessive position error alarm level (Pn520). Or, adjust the speed limit level at servo ON (Pn529).
A.E02: MECHATROLINK Internal Synchronization Error 1	MECHATROLINK transmission cycle fluctuated.	—	Remove the cause of transmission cycle fluctuation at host controller.
	A SERVOPACK fault occurred.	—	Restart the SERVOPACK. If the alarm still occurs, the SERVOPACK may be faulty. Replace the SERVOPACK.
A.E40: MECHATROLINK Transmission Cycle Setting Error	Setting of MECHATROLINK transmission cycle is out of specifications range.	Check the MECHATROLINK transmission cycle setting.	Set the transmission cycle to the proper value.

(cont'd)

Alarm Number: Alarm Name (Alarm Description)	Cause	Investigative Actions	Corrective Actions
A.E50: MECHATROLINK Synchronization Error	WDT data of host controller was not updated correctly.	Check the WDT data updating for the host controller.	Update the WDT data at the host controller correctly.
	A SERVOPACK fault occurred.	–	Restart the SERVOPACK. If the alarm still occurs, the SERVOPACK may be faulty. Replace the SERVOPACK.
A.E51: MECHATROLINK Synchronization Failed	WDT data of host controller was not updated correctly at the synchronization communications start, and synchronization communications could not start.	Check the WDT data updating for the host controller.	Update the WDT data at the host controller correctly.
	A SERVOPACK fault occurred.	–	Restart the SERVOPACK. If the alarm still occurs, the SERVOPACK may be faulty. Replace the SERVOPACK.
A.E60: MECHATROLINK Communications error (Reception error)	MECHATROLINK wiring is incorrect.	Check the MECHATROLINK wirings.	Correct the MECHATROLINK wiring. Connect the terminator correctly.
	MECHATROLINK data reception error occurred due to noise interference.	–	Take measures against noise. Check the MECHATROLINK communications cable and FG wiring and take measures such as adding ferrite core on the MECHATROLINK communications cable.
	A SERVOPACK fault occurred.	–	Restart the SERVOPACK. If the alarm still occurs, the SERVOPACK may be faulty. Replace the SERVOPACK.
A.E61: MECHATROLINK Transmission Cycle Error (Synchronization interval error)	MECHATROLINK transmission cycle fluctuated.	Check the MECHATROLINK transmission cycle setting.	Remove the cause of transmission cycle fluctuation at host controller.
	A SERVOPACK fault occurred.	–	Restart the SERVOPACK. If the alarm still occurs, the SERVOPACK may be faulty. Replace the SERVOPACK.
A.EA2: DRV Alarm 2 (SERVOPACK WDT error)	MECHATROLINK transmission cycle fluctuated.	Check the MECHATROLINK transmission cycle setting.	Remove the cause of transmission cycle fluctuation at host controller.
	A SERVOPACK fault occurred.	–	Restart the SERVOPACK. If the alarm still occurs, the SERVOPACK may be faulty. Replace the SERVOPACK.
A.Ed1: Command Execution Timeout	A timeout error occurred when using an MECHATROLINK command.	Check the motor status when the command is executed.	Execute the SV_ON or SENS_ON command only when the motor is not running.
A.F50: Servomotor Main Circuit Cable Disconnection (The servomotor did not operate or power was not supplied to the servomotor even though the SV_ON (Servo ON) command was input when the servomotor was ready to receive it.)	A SERVOPACK fault occurred.	–	The SERVOPACK may have failed. Replace the SERVOPACK.
	The wiring is not correct or there is a faulty contact in the motor wiring.	Check the wiring.	Make sure that the servomotor is correctly wired.

8.2 Warning Displays

The following sections describe troubleshooting in response to warning displays.

The warning name and warning meaning are listed in order of the warning numbers in 8.2.1 *List of Warnings*.

The causes of warnings and troubleshooting methods are provided in 8.2.2 *Troubleshooting of Warnings*.

8.2.1 List of Warnings

This section provides list of warnings.

Warning Number	Warning Name	Meaning
A.900 ^{*1}	Position Error Overflow	Position error exceeded the parameter setting (Pn520×Pn51E/100).
A.901 ^{*1}	Position Error Overflow Alarm at Servo ON	When the servomotor power is ON, the position error exceeded the parameter setting (Pn526×Pn528/100).
A.910 ^{*1}	Overload	This warning occurs before the overload alarms (A.710 or A.720) occur. If the warning is ignored and operation continues, an overload alarm may occur.
A.911 ^{*1}	Vibration	Abnormal vibration at the motor speed was detected. The detection level is the same as A.520. Set whether to output an alarm or warning by the vibration detection switch (Pn310).
A.930 ^{*1}	Absolute Encoder Battery Error	This warning occurs when the voltage of absolute encoder's battery is lowered.
A.94A ^{*2}	Data Setting Warning 1 (Parameter Number Error)	Incorrect command parameter number was set.
A.94B ^{*2}	Data Setting Warning 2 (Out of Range)	Command input data is out of range.
A.94C ^{*2}	Data Setting Warning 3 (Calculation Error)	Calculation error was detected.
A.94D ^{*2}	Data Setting Warning 4 (Parameter Size)	Data size does not match.
A.94E ^{*2}	Data Setting Warning 5 (Latch Mode Error)	Latch mode error is detected.
A.95A ^{*2}	Command Warning 1 (Unsatisfying Command)	Command was sent although the conditions for sending a command were not satisfied.
A.95B ^{*2}	Command Warning 2 (Non-supported Command)	Unsupported command was sent.
A.95D ^{*2}	Command Warning 4 (Command Interference)	Command, especially latch command, interferes.
A.95E ^{*2}	Command Warning 5 (Subcommand Disable)	Subcommand and main command interfere.
A.95F ^{*2}	Command Warning 6 (Undefined Command)	Undefined command was sent.
A.960 ^{*2}	MECHATROLINK Communications Warning	Communications error occurred during MECHATROLINK communications.
A.9A0 ^{*1}	Overtravel	Overtravel is detected while the servomotor power is ON.

*1. Use Pn008.2 to activate or not the warning detection.

*2. Use Pn800.1 to activate or not the warning detection.

8.2.2 Troubleshooting of Warnings

Refer to the following table to identify the cause of a warning and the action to be taken. Contact your Yaskawa representative if the problem cannot be solved by the described corrective action.

Warning Number: Warning Name (Warning Description)	Cause	Investigative Actions	Corrective Actions
A.900: Position Error Overflow	The servomotor U, V, and W wirings is faulty.	Check the servomotor main circuit cable connection.	Confirm that there is no contact fault in the motor wiring or encoder wiring.
	The SERVOPACK gain is too low.	Check the SERVOPACK gain.	Increase the servo gain by using the function such as advanced autotuning.
	The acceleration of the position reference is too high.	Reduce the reference acceleration, and operate the SERVOPACK.	Reduce the reference acceleration of the position reference using a MECHATROLINK command, or smooth the acceleration of the position reference by selecting the position reference filter (ACCFIL) using a MECHATROLINK command.
	Setting of the excessive position error alarm level (Pn520) is low against the operating condition.	Check the alarm level (Pn520) to see if it is set to an appropriate value.	Set the Pn520 to proper value.
	A SERVOPACK fault occurred.	—	Restart the SERVOPACK. If the alarm still occurs, the SERVOPACK may be faulty. Replace the SERVOPACK.
A.901: Position Error Overflow Alarm at Servo ON	When the servomotor power is ON, the position error exceeded the parameter setting (Pn526×Pn528/100).	—	Set an appropriate value for the excessive position error warning level at servo ON (Pn528).
A.910: Overload (Warning before alarm A.710 or A.720 occurs)	Incorrect wiring or contact fault of servomotor and encoder.	Check the wiring.	Confirm that the servomotor and encoder are correctly wired.
	Operation beyond the overload protection characteristics.	Check the motor overload characteristics and executed run command.	Reconsider the load conditions and operating conditions. Or, increase the motor capacity.
	Excessive load was applied during operation because the servomotor was not driven due to mechanical problems.	Check the executed operation reference and motor speed.	Remove the mechanical problems.
	A SERVOPACK fault occurred.	—	The SERVOPACK may be faulty. Replace the SERVOPACK.

(cont'd)

Warning Number: Warning Name (Warning Description)	Cause	Investigative Actions	Corrective Actions
A.911: Vibration	Abnormal vibration was detected at the motor speed.	Check for abnormal noise from the servomotor, and check the speed and torque waveforms during operation.	Reduce the motor speed or reduce the servo gain by using the function such as one-parameter tuning.
	The moment of inertia ratio (Pn103) value is greater than the actual value or is greatly changed.	Check the moment of inertia ratio.	Set the moment of inertia ratio (Pn103) to an appropriate value.
A.930: Absolute Encoder Battery Error (The absolute encoder battery voltage is lower than the specified value.) (Only when an absolute encoder is connected.)	The battery connection is incorrect.	Check the battery connection.	Reconnect the battery.
	The battery voltage is lower than the specified value 2.7 V.	Measure the battery voltage.	Replace the battery.
	A SERVOPACK fault occurred.	–	The SERVOPACK may be faulty. Replace the SERVOPACK.
A.94A Data Setting Warning 1 (Parameter Number Error)	Disabled parameter number was used.	Refer to 8.3 <i>Monitoring Communication Data on Occurrence of an Alarm or Warning</i> to determine which command was the cause of the warning.	Use the correct parameter number.
A.94B Data Setting Warning 2 (Out of Range)	Attempted to send values outside the range to the command data.	Refer to 8.3 <i>Monitoring Communication Data on Occurrence of an Alarm or Warning</i> to determine which command was the cause of the warning.	Set the value of the parameter within the allowable range.
A.94C Data Setting Warning 3 (Calculation Error)	Calculation result of set value is incorrect.	Refer to 8.3 <i>Monitoring Communication Data on Occurrence of an Alarm or Warning</i> to determine which command was the cause of the warning.	Set the value of the parameter within the allowable range.
A.94D Data Setting Warning 4 (Parameter Size)	Parameter size set in command is incorrect.	Refer to 8.3 <i>Monitoring Communication Data on Occurrence of an Alarm or Warning</i> to determine which command was the cause of the warning.	Use the correct parameter size.
A.94E Data Setting Warning 5 (Latch mode error)	Latch mode error is detected.	Refer to 8.3 <i>Monitoring Communication Data on Occurrence of an Alarm or Warning</i> to determine which command was the cause of the warning.	Change the setting value of Pn850 or the LT_MOD data for the LTMOD_ON command sent by the host controller to the proper value.
A.95A Command Warning 1 (Unsatisfying Command)	Command sending condition is not satisfied.	Refer to 8.3 <i>Monitoring Communication Data on Occurrence of an Alarm or Warning</i> to determine which command was the cause of the warning.	Send a command after command sending condition is satisfied.
A.95B Command Warning 2 (Non-supported Command)	SERVOPACK received unsupported command.	Refer to 8.3 <i>Monitoring Communication Data on Occurrence of an Alarm or Warning</i> to determine which command was the cause of the warning.	Do not sent an unsupported command.

(cont'd)

Warning Number: Warning Name (Warning Description)	Cause	Investigative Actions	Corrective Actions
A.95D Command Warning 4 (Command Interference)	Command sending condition for latch-related commands is not satisfied.	Refer to 8.3 <i>Monitoring Communication Data on Occurrence of an Alarm or Warning</i> to determine which command was the cause of the warning.	Send a command after command sending condition is satisfied.
A.95E Command Warning 5 (Subcommand Disable)	Subcommand sending condition is not satisfied.	Refer to 8.3 <i>Monitoring Communication Data on Occurrence of an Alarm or Warning</i> to determine which command was the cause of the warning.	Send a command after command sending condition is satisfied.
A.95F Command Warning 6 (Undefined Command)	Undefined command was sent.	Refer to 8.3 <i>Monitoring Communication Data on Occurrence of an Alarm or Warning</i> to determine which command was the cause of the warning.	Do not use an undefined command.
A.960 MECHATROLINK Communications Warning	MECHATROLINK wiring is incorrect.	Confirm the wiring.	Correct the MECHATROLINK wiring. Or, connect a terminal to the terminal station.
	MECHATROLINK data reception error occurred due to noise interference.	Confirm the installation conditions.	Take measures against noise. Check the MECHATROLINK communications cable and FG wiring and take measures such as adding ferrite core on the MECHATROLINK communications cable.
	A SERVOPACK fault occurred.	—	A fault occurred in the SERVOPACK. Replace the SERVOPACK.
A.9A0: Overtravel (Overtravel status is detected.)	When the servomotor power is ON, overtravel status is detected.	Check the input signal monitor (Un005) to check the status of the overtravel signals.	Refer to 8.4 <i>Troubleshooting Malfunction Based on Operation and Conditions of the Servomotor</i> . Even if overtravel signals were not shown by the input signal monitor (Un005), momentary overtravel may have been detected. Take the following precautions. <ul style="list-style-type: none"> • Do not specify movements that would cause overtravel from the host controller. • Check the wiring of the overtravel signals. • Take countermeasures for noise.

8.3 Monitoring Communication Data on Occurrence of an Alarm or Warning

The command data received on occurrence of an alarm or warning, such as a data setting warning (A.94□) or a command warning (A.95□) can be monitored using the following parameters. The following is an example of the data when an alarm/warning has occurred in the normal state.

Command Data Monitor at Alarm/Warning Occurrence:Pn890 to Pn89E
Response Data Monitor at Alarm/Warning Occurrence:Pn8A0 to Pn8AE

Command Byte Order	Command Data Storage at Alarm/Warning Occurrence	
	CMD	RSP
1	Pn890.1 to 0	Pn8A0.1 to 0
2	Pn890.3 to 2	Pn8A0.3 to 2
3	Pn890.5 to 4	Pn8A0.5 to 4
4	Pn890.7 to 6	Pn8A0.7 to 6
5 to 8	Pn892	Pn8A2
9 to 12	Pn894	Pn8A4
13 to 16	Pn896	Pn8A6
17 to 20	Pn898	Pn8A8
21 to 24	Pn89A	Pn8AA
25 to 28	Pn89C	Pn8AC
29 to 32	Pn89E	Pn8AE

Example: Pn8A0 = 87 65 43 21

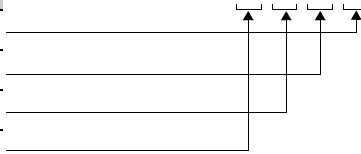

- Note 1. Data is stored in little endian byte order and displayed in the hexadecimal format.
2. For details on commands, refer to *ΣV Series User's Manual MECHATROLINK-II Commands* (Manual No.: SIEP S800000 54).

8.4 Troubleshooting Malfunction Based on Operation and Conditions of the Servomotor

Troubleshooting for the malfunctions based on the operation and conditions of the servomotor is provided in this section.

Be sure to turn OFF the servo system before troubleshooting items shown in bold lines in the table.

Problem	Probable Cause	Investigative Actions	Corrective Actions
Servomotor Does Not Start	The control power supply is not ON.	Check voltage between control power input terminals.	Correct the wiring.
	The main circuit power supply is not ON.	Check the voltage between main circuit power input terminals.	Correct the wiring.
	Wiring of I/O signal connector CN1 is faulty or disconnected.	Check if the connector CN1 is properly inserted and connected.	Correct the connector CN1 connection.
	Wiring for servomotor main circuit cable or encoder cable is disconnected.	Check the wiring.	Correct the wiring.
	Overloaded	Run under no load and check the load status.	Reduce load or replace with larger capacity servomotor.
	Encoder type differs from parameter setting (Pn002.2).	Check the settings for parameter Pn002.2.	Set parameter Pn002.2 to the encoder type being used.
	Settings for the input signal selections (Pn50A, Pn50B and Pn511) is incorrect.	Check the settings for parameters Pn50A, Pn50B and Pn511.	Correct the settings for parameter Pn50A, Pn50B and Pn511.
	SV_ON command is not sent.	Check the command sent from the host controller.	Send the SV_ON command.
	SENS_ON command is not sent.	Check the command sent from the host controller.	Send the command in the correct SERVOPACK sequence.
	The forward run prohibited (P-OT) and reverse run prohibited (N-OT) input signals are turned OFF.	Check P-OT or N-OT input signal.	Turn P-OT or N-OT input signal ON.
A SERVOPACK fault occurred.	–	Replace the SERVOPACK.	
Servomotor Moves Instantaneously, and then Stops	Servomotor wiring is incorrect.	Check the wiring.	Correct the wiring.
	Encoder wiring is incorrect.	Check the wiring.	Correct the wiring.
The SERVOPACK suddenly entered baseblock status during servomotor operation.	The main circuit power supply voltage is 13 V or lower.	Check voltage between main circuit power input terminals during operation.	Set the power supply voltage to within the specified range. Increase the capacity of the main circuit AC/DC power supply.
	The fuse in the SERVOPACK is blown.	–	Replace the SERVOPACK.
	A SERVOPACK fault occurred.	–	A fault occurred in the SERVOPACK. Replace the SERVOPACK.
Servomotor Speed Unstable	Wiring connection to servomotor is defective.	Check connections of power line (phases U, V, and W) and encoder connectors.	Tighten any loose terminals or connectors and correct the wiring.
Servomotor Rotates Without Reference Input	A SERVOPACK fault occurred.	–	Replace the SERVOPACK.

(cont'd)

Problem	Probable Cause	Investigative Actions	Corrective Actions
Abnormal Noise from Servomotor	The servomotor largely vibrated during execution of tuning-less function.	Check the motor speed waveform.	Reduce the load so that the moment of inertia ratio becomes within the allowable value, or increase the load level or lower the tuning level for the tuning-less levels setting (Fn200).
	Mounting is not secured.	Check if there are any loose mounting screws.	Tighten the mounting screws.
		Check if there is misalignment of couplings.	Align the couplings.
		Check if there are unbalanced couplings.	Balance the couplings.
	Bearings are defective.	Check for noise and vibration around the bearings.	Replace the servomotor.
	Vibration source at the driven machine.	Check for any foreign matter, damage, or deformations on the machinery's movable parts.	Contact the machine manufacturer.
	Noise interference due to incorrect I/O signal cable specifications.	The I/O signal cable must be tinned annealed copper shielded twisted-pair or screened unshielded twisted-pair cable with a core of 0.12 mm ² min.	Use the specified I/O signal cable.
	Noise interference due to length of I/O signal cable.	Check the length of the I/O signal cable.	The I/O signal cable length must be no more than 3 m.
	Noise interference due to incorrect cable specifications of encoder cable.	The encoder cable must be tinned annealed copper shielded twisted-pair or screened unshielded twisted-pair cable with a core of 0.12 mm ² min.	Use the specified encoder cable.
	Noise interference due to length of encoder cable.	Check the length of the encoder cable.	The encoder cable must be no more than 50 m.
	Noise interference due to damaged encoder cable.	Check if the encoder cable is bent and the sheath is damaged.	Replace the encoder cable and correct the cable layout.
	Excessive noise to the encoder cable.	Check if the encoder cable is bundled with a high-current line or near a high-current line.	Correct the cable layout so that no surge is applied.
	The FG potential varies because of influence from machines on the servomotor side, such as the welder.	Check if the machines are correctly grounded.	Properly ground the machines to separate from the encoder FG.
	SERVOPACK pulse counting error due to noise interference	Check if there is noise interference on the I/O signal line from the encoder.	Take measures against noise in the encoder wiring.
Excessive vibration and shock to the encoder	Check if vibration from the machine occurred or servomotor installation is incorrect (mounting surface accuracy, fixing, alignment, etc.).	Reduce vibration from the machine, or secure the servomotor installation.	
An encoder fault occurred.	—	Replace the servomotor.	

(cont'd)

Problem	Probable Cause	Investigative Actions	Corrective Actions
Servomotor Vibrates at Frequency of Approx. 200 to 400 Hz.	Unbalanced servo gains	Check to see if the servo gains have been correctly adjusted.	Execute the advanced autotuning.
	Speed loop gain value (Pn100) too high.	Check the speed loop gain (Pn100). Factory setting: $K_v = 40.0$ Hz	Reduce the speed loop gain (Pn100).
	Position loop gain value (Pn102) too high.	Check the position loop gain (Pn102). Factory setting: $K_p = 40.0/s$	Reduce the position loop gain (Pn102).
	Incorrect speed loop integral time constant (Pn101)	Check the speed loop integral time constant (Pn101). Factory setting: $T_i = 20.0$ ms	Correct the speed loop integral time constant (Pn101).
	Incorrect moment of inertia ratio (Pn103)	Check the moment of inertia ratio (Pn103).	Correct the moment of inertia ratio (Pn103).
High Motor Speed Overshoot on Starting and Stopping	Unbalanced servo gains	Check to see if the servo gains have been correctly adjusted.	Execute the advanced autotuning.
	Speed loop gain value (Pn100) too high	Check the speed loop gain (Pn100). Factory setting: $K_v = 40.0$ Hz	Reduce the speed loop gain (Pn100).
	Position loop gain value (Pn102) too high	Check the position loop gain (Pn102). Factory setting: $K_p = 40.0/s$	Reduce the position loop gain (Pn102).
	Incorrect speed loop integral time constant (Pn101)	Check the speed loop integral time constant (Pn101). Factory setting: $T_i = 20.0$ ms	Correct the speed loop integral time constant (Pn101).
	Incorrect moment of inertia ratio data (Pn103)	Check the moment of inertia ratio (Pn103).	Correct the moment of inertia ratio (Pn103).
Absolute Encoder Position Difference Error (The position saved in the host controller when the power was turned OFF is different from the position when the power was next turned ON.)	Noise interference due to incorrect cable specifications of encoder cable.	The encoder cable must be tinned annealed copper shielded twisted-pair or screened unshielded twisted-pair cable with a core of 0.12 mm^2 min.	Use the specified encoder cable.
	Noise interference due to length of encoder cable.	Check the length of the encoder cable.	The encoder cable must be no more than 50 m.
	Noise interference due to damaged encoder cable.	Check if the encoder cable is bent and the sheath is damaged.	Replace the encoder cable and correct the cable layout.
	Excessive noise to the encoder cable.	Check if the encoder cable is bundled with a high-current line or near a high-current line.	Correct the cable layout so that no surge is applied.
	FG potential varies because of influence of machines such as welders at the servomotor.	Check if the machines are correctly grounded.	Ground machines correctly, and prevent diversion to the FG on the encoder side.
	SERVOPACK pulse counting error due to noise interference	Check if there is noise interference on the I/O signal line from the encoder.	Take measures against noise in the encoder wiring.
	Excessive vibration and shock to the encoder	Check if vibration from the machine occurred or servomotor installation is incorrect (mounting surface accuracy, fixing, alignment, etc.).	Reduce vibration from the machine, or secure the servomotor installation.
	An encoder fault occurred.	–	Replace the servomotor.
	A SERVOPACK fault occurred. (The pulse count does not change.)	–	Replace the SERVOPACK.
	Host controller multiturn data reading error	Check the error detection section of the host controller.	Correct the error detection section of the host controller.
Check if the host controller is executing data parity checks.		Execute a multiturn data parity check.	
Check noise in the cable between the SERVOPACK and the host controller.		Take measures against noise, and again execute a multiturn data parity check.	

(cont'd)

Problem	Probable Cause	Investigative Actions	Corrective Actions
Overtravel (OT)	Forward or reverse run prohibited signal is input.	Check the external power supply (+24 V) voltage for the input signal.	Correct the external power supply (+24 V) voltage.
		Check if the overtravel limit switch operates properly.	Correct the overtravel limit switch.
		Check if the overtravel limit switch is wired correctly.	Correct the overtravel limit switch wiring.
		Check the settings for parameters Pn50A and Pn50B.	Correct the settings for parameters Pn50A and Pn50B.
	Forward or reverse run prohibited signal malfunctioning.	Check the fluctuation of the external power supply (+24 V) voltage for the input signal.	Stabilize the external power supply (+24 V) voltage.
		Check if the overtravel limit switch operates correctly.	Correct the overtravel limit switch.
		Check if the overtravel limit switch wiring is correct. (check for damaged cables or loose screws.)	Correct the overtravel limit switch wiring.
	Incorrect forward or reverse run prohibited signal (P-OT/N-OT) allocation (parameters Pn50A.3, Pn50B.0)	Check if the P-OT signal is allocated in Pn50A.3.	If another signal is allocated in Pn50A.3, allocate P-OT.
		Check if the N-OT signal is allocated in Pn50B.0.	If another signal is allocated in Pn50B.0, allocate N-OT.
Improper Stop Position by Overtravel (OT) Signal	Improper limit switch position and dog length	–	Install the limit switch at the appropriate position.
	The overtravel limit switch position is too short for the coasting distance.	–	Install the overtravel limit switch at the appropriate position.

(cont'd)

Problem	Probable Cause	Investigative Actions	Corrective Actions
Position Error (Without Alarm)	Noise interference due to incorrect encoder cable specifications	The encoder cable must be tinned annealed copper shielded twisted-pair or screened unshielded twisted-pair cable with a core of 0.12 mm ² min.	Use the specified encoder cable.
	Noise interference due to length of encoder cable.	Check the length of the encoder cable.	The encoder cable must be no more than 50 m.
	Noise influence due to damaged encoder cable.	Check if the encoder cable is bent and the sheath is damaged.	Replace the encoder cable and modify the cable layout.
	Excessive noise to encoder cable.	Check if the encoder cable is bundled with a high-current line or near a high-current line.	Change the cable layout so that no surge is applied.
	The FG potential varies because of influence from machines on the servomotor side such as the welder.	Check if the machines are correctly grounded.	Properly ground the machines encoder FG.
	SERVOPACK pulse count error due to noise	Check if the I/O signal line from the encoder is influenced by noise.	Take measures against noise in the encoder wiring.
	Excessive vibration and shock to the encoder	Check if vibration from the machine occurred or servomotor installation is incorrect (mounting surface accuracy, fixing, alignment, etc.).	Reduce the machine vibration or mount the servomotor securely.
	Unsecured coupling between machine and servomotor	Check if a position error occurs at the coupling between machine and servomotor.	Secure the coupling between the machine and servomotor.
	Noise interference due to improper I/O signal cable specifications	The I/O signal cable must be tinned annealed copper shielded twisted-pair or screened unshielded twisted-pair cable with a core of 0.12 mm ² min.	Use input signal cable with the specified specifications.
	Noise interference due to length of I/O signal cable	Check the I/O signal cable length.	The I/O signal cable length must be no more than 3 m.
	An encoder fault occurred. (The pulse count does not change.)	–	Replace the servomotor.
A SERVOPACK fault occurred.	–	Replace the SERVOPACK.	
Servomotor Overheated	Ambient operating temperature too high	Measure the servomotor ambient operating temperature.	Reduce the ambient operating temperature to 40°C or less.
	Servomotor surface dirty	Visually check the surface.	Clean dust and oil from the surface.
	Servomotor overloaded	Check the load status with monitor.	If overloaded, reduce load or replace with larger capacity SERVOPACK and servomotor.

Appendix

9.1 List of Parameters	9-2
9.1.1 Utility Functions	9-2
9.1.2 Parameters	9-3
9.2 List of Monitor Displays	9-30
9.3 Parameter Recording Table	9-31

9.1 List of Parameters

9.1.1 Utility Functions

The following list shows the available utility functions.

Parameter No.	Function	Reference Section	Comment: SigmaWin+ function names
Fn000	Alarm history display	6.2	Alarm Display
Fn002	JOG operation	6.3	JOG Operation
Fn003	Origin search	6.4	Origin Search
Fn004	Program JOG operation	6.5	Program JOG Operation
Fn005	Initializing parameter settings	6.6	Editing Parameters
Fn006	Clearing alarm history	6.7	Alarm Display
Fn008	Absolute encoder multiturn reset and encoder alarm reset	4.7.4	Setting the Absolute Encoder
Fn00C	Offset adjustment of analog monitor output	6.8	Adjusting Analog Monitor Output
Fn00D	Gain adjustment of analog monitor output	6.9	Adjusting Analog Monitor Output
Fn00E	Automatic offset-signal adjustment of the motor current detection signal	6.10	Adjusting Motor Current Detection Offset
Fn00F	Manual offset-signal adjustment of the motor current detection signal	6.11	Adjusting Motor Current Detection Offset
Fn010	Write prohibited setting	6.12	Write Prohibited Setting
Fn011	Servomotor model display	6.13	Product Information
Fn012	Software version display	6.14	Product Information
Fn013	Multiturn limit value setting change when a multiturn limit disagreement alarm occurs	4.7.6	Setting the Multi-Turn Limit
Fn01B	Vibration detection level initialization	6.15	Initializing Vibration Detection Level
Fn01E	Display of SERVOPACK and servomotor ID	6.16	Product Information
Fn030	Software reset	6.17	Resetting the SERVOPACK by Software or MECHATROLINK Communication Reset
Fn200	Tuning-less levels setting	5.2.2	Editing Parameters
Fn201	Advanced autotuning	5.3.2	Tuning
Fn202	Advanced autotuning by reference	5.4.2	Tuning
Fn203	One-parameter tuning	5.5.2	Tuning
Fn204	Anti-resonance control adjustment function	5.6.2	Tuning
Fn205	Vibration suppression function	5.7.2	Tuning
Fn206	EasyFFT	6.18	EasyFFT
Fn207	Online vibration monitor	6.19	Online Vibration Monitor

Note: Execute the utility function with SigmaWin+.

9.1.2 Parameters

The following table lists the parameters. Do not change any reserved parameters or any parameters that are not given in this manual from their default settings. Also, do not use any settings that are reserved.

Parameter No.	Size	Name	Setting Range	Units	Factory Setting	When Enabled	Classification	Reference Section																				
Pn000	2	Basic Function Select Switch 0	0000 to 00B3	–	0000	After restart	Setup	–																				
	4th digit 3rd digit 2nd digit 1st digit n. <input type="checkbox"/> <input type="checkbox"/> <input type="checkbox"/> <input type="checkbox"/>		<table border="1"> <thead> <tr> <th colspan="2">Direction Selection</th> <th>Reference Section</th> </tr> </thead> <tbody> <tr> <td>0</td> <td>Sets CCW as forward direction.</td> <td rowspan="3">4.3.1</td> </tr> <tr> <td>1</td> <td>Sets CW as forward direction. (Reverse Rotation Mode)</td> </tr> <tr> <td>2 and 3</td> <td>Reserved (Do not use.)</td> </tr> <tr> <td colspan="3">Reserved (Do not change.)</td> </tr> <tr> <td colspan="3">Reserved (Do not change.)</td> </tr> <tr> <td colspan="3">Reserved (Do not change.)</td> </tr> </tbody> </table>						Direction Selection		Reference Section	0	Sets CCW as forward direction.	4.3.1	1	Sets CW as forward direction. (Reverse Rotation Mode)	2 and 3	Reserved (Do not use.)	Reserved (Do not change.)			Reserved (Do not change.)			Reserved (Do not change.)			
	Direction Selection		Reference Section																									
	0	Sets CCW as forward direction.	4.3.1																									
	1	Sets CW as forward direction. (Reverse Rotation Mode)																										
	2 and 3	Reserved (Do not use.)																										
	Reserved (Do not change.)																											
	Reserved (Do not change.)																											
	Reserved (Do not change.)																											
	Pn001	2	Application Function Select Switch 1	0000 to 1122	–	0000	After restart	Setup	–																			
4th digit 3rd digit 2nd digit 1st digit n. <input type="checkbox"/> <input type="checkbox"/> <input type="checkbox"/> <input type="checkbox"/>		<table border="1"> <tbody> <tr> <td colspan="3">Reserved (Do not change.)</td> </tr> <tr> <th colspan="2">Overtravel (OT) Stop Mode</th> <th>Reference Section</th> </tr> <tr> <td>0</td> <td>Stops the motor by coasting.</td> <td rowspan="3">4.3.2</td> </tr> <tr> <td>1</td> <td>Sets the torque of Pn406 to the maximum value, decelerates the servomotor to a stop, and then sets it to servolock state.</td> </tr> <tr> <td>2</td> <td>Sets the torque of Pn406 to the maximum value, decelerates the servomotor to a stop, and then sets it to coasting state.</td> </tr> <tr> <td colspan="3">Reserved (Do not change.)</td> </tr> <tr> <td colspan="3">Reserved (Do not change.)</td> </tr> </tbody> </table>						Reserved (Do not change.)			Overtravel (OT) Stop Mode		Reference Section	0	Stops the motor by coasting.	4.3.2	1	Sets the torque of Pn406 to the maximum value, decelerates the servomotor to a stop, and then sets it to servolock state.	2	Sets the torque of Pn406 to the maximum value, decelerates the servomotor to a stop, and then sets it to coasting state.	Reserved (Do not change.)			Reserved (Do not change.)				
Reserved (Do not change.)																												
Overtravel (OT) Stop Mode		Reference Section																										
0		Stops the motor by coasting.	4.3.2																									
1		Sets the torque of Pn406 to the maximum value, decelerates the servomotor to a stop, and then sets it to servolock state.																										
2		Sets the torque of Pn406 to the maximum value, decelerates the servomotor to a stop, and then sets it to coasting state.																										
Reserved (Do not change.)																												
Reserved (Do not change.)																												

(cont'd)

Parameter No.	Size	Name	Setting Range	Units	Factory Setting	When Enabled	Classification	Reference Section	
Pn002	2	Application Function Select Switch 2	0000 to 4113	–	0000	After restart	Setup	–	
	<div style="display: flex; justify-content: space-around;"> 4th digit 3rd digit 2nd digit 1st digit </div> <div style="display: flex; justify-content: space-around;"> <input type="checkbox"/> <input type="checkbox"/> <input type="checkbox"/> <input type="checkbox"/> </div>								Reference Section
			MECHATROLINK Command Position and Speed Control Option						*1
			0	The set value of P_TLIM, NTLIM, and TFF are ignored.					
			1	P_TLIM and NTLIM operate as the torque limit values.					
			2	TFF operates as the torque feed forward.					
			3	When P-CL and N-CL in the OPTION field are available, P_TLIM and NTLIM operate as the torque limit value.					
			Torque Control Option						Reference Section
			0	V_LIM is not available.					–
			1	V_LIM operates as the speed limit value.					–
			Absolute Encoder Usage						Reference Section
			0	Uses absolute encoder as an absolute encoder.					4.7
			1	Uses absolute encoder as an incremental encoder.					
			Reserved (Do not change.)						
	Pn006	2	Application Function Select Switch 6	0000 to 005F	–	0002	Immediately	Setup	5.1.3
<div style="display: flex; justify-content: space-around;"> 4th digit 3rd digit 2nd digit 1st digit </div> <div style="display: flex; justify-content: space-around;"> <input type="checkbox"/> <input type="checkbox"/> <input type="checkbox"/> <input type="checkbox"/> </div>									
		Analog Monitor 1 Signal Selection							
		00	Motor rotating speed (1 V / 1000 min ⁻¹)						
		01	Speed reference (1 V / 1000 min ⁻¹)						
		02	Torque reference (1 V/100% rated torque)						
		03	Position error (0.05 V/1 reference unit)						
		04	Position amplifier error (after electronic gears) (0.05 V/ 1 encoder pulse unit)						
		05	Position reference speed (1 V / 1000 min ⁻¹)						
		06	Reserved (Do not use.)						
		07	Reserved (Do not use.)						
		08	Positioning completion (positioning completed: 5 V, positioning not completed: 0 V)						
		09	Reserved (Do not use.)						
		0A	Torque feedforward (1 V/100% rated torque)						
		0B	Active gain (1st gain: 1 V, 2nd gain: 2 V)						
		0C	Completion of position reference (completed: 5 V, not completed: 0 V)						
		0D	Reserved (Do not use.)						
		Reserved (Do not change.)							
		Reserved (Do not change.)							

*1. For details, refer to *Σ-V Series User's Manual MECHATROLINK-II Commands* (Manual No.: SIEP S800000 54).

(cont'd)

Parameter No.	Size	Name	Setting Range	Units	Factory Setting	When Enabled	Classification	Reference Section	
Pn007	2	Application Function Select Switch 7	0000 to 005F	–	0000	Immediately	Setup	5.1.3	
	<div style="display: flex; justify-content: space-around; align-items: flex-start;"> <div style="text-align: center;"> <p>4th digit</p><input type="checkbox"/></div> <div style="text-align: center;"> <p>3rd digit</p><input type="checkbox"/></div> <div style="text-align: center;"> <p>2nd digit</p><input type="checkbox"/></div> <div style="text-align: center;"> <p>1st digit</p><input type="checkbox"/></div> </div>								
			Analog Monitor 2 Signal Selection						
			00	Motor rotating speed (1 V / 1000 min ⁻¹)					
			01	Speed reference (1 V / 1000 min ⁻¹)					
			02	Torque reference (1 V/100% rated torque)					
			03	Position error (0.05 V/1 reference unit)					
			04	Position amplifier error (after electronic gears) (0.05 V/ 1 encoder pulse unit)					
			05	Position reference speed (1 V / 1000 min ⁻¹)					
			06	Reserved (Do not use.)					
			07	Reserved (Do not use.)					
			08	Positioning completion (positioning completed: 5 V, positioning not completed: 0 V)					
			09	Reserved (Do not use.)					
			0A	Torque feedforward (1 V/100% rated torque)					
			0B	Active gain (1st gain: 1 V, 2nd gain: 2 V)					
			0C	Completion of position reference (completed: 5 V not completed: 0 V)					
			0D	Reserved (Do not use.)					
		Reserved (Do not change.)							
		Reserved (Do not change.)							
Pn008	2	Application Function Select Switch 8	0000 to 7121	–	4000	After restart	Setup	–	
	<div style="display: flex; justify-content: space-around; align-items: flex-start;"> <div style="text-align: center;"> <p>4th digit</p><input type="checkbox"/></div> <div style="text-align: center;"> <p>3rd digit</p><input type="checkbox"/></div> <div style="text-align: center;"> <p>2nd digit</p><input type="checkbox"/></div> <div style="text-align: center;"> <p>1st digit</p><input type="checkbox"/></div> </div>								
			Lowered Battery Voltage Alarm/Warning Selection						Reference Section
			0	Outputs alarm (A.830) for lowered battery voltage.					4.7.3
			1	Outputs warning (A.930) for lowered battery voltage.					
			Reserved (Do not change.)						
			Reserved (Do not change.)						
			Warning Detection Selection						Reference Section
			0	Detects warning.					8.2.1
			1	Does not detect warning.					

(cont'd)

Parameter No.	Size	Name	Setting Range	Units	Factory Setting	When Enabled	Classification	Reference Section		
Pn009	2	Application Function Select Switch 9	0000 to 0111	–	0010	After restart	Tuning	–		
	<div style="display: flex; justify-content: space-around;"> 4th digit 3rd digit 2nd digit 1st digit </div> <div style="display: flex; justify-content: space-around;"> <input type="checkbox"/> <input type="checkbox"/> <input type="checkbox"/> <input type="checkbox"/> </div>									
			Reserved (Do not change.)							
			Current Control Method Selection							Reference Section
			0	Current control method 1					5.8.3	
			1	Current control method 2						
			Speed Detection Method Selection							Reference Section
			0	Speed detection 1					5.8.5	
			1	Speed detection 2						
			Reserved (Do not change.)							
Pn00B	2	Application Function Select Switch B	0000 to 1111	–	0000	After restart	Setup	–		
	<div style="display: flex; justify-content: space-around;"> 4th digit 3rd digit 2nd digit 1st digit </div> <div style="display: flex; justify-content: space-around;"> <input type="checkbox"/> <input type="checkbox"/> <input type="checkbox"/> <input type="checkbox"/> </div>									
			Parameter Display Selection							Reference Section
			0	Setup parameters					2.5.1	
			1	All parameters						
			Alarm Gr.2 Stop Method Selection							Reference Section
			0	Stops the motor by setting the speed reference to "0".					4.3.5	
			1	Stops the motor by coasting.						
			Reserved (Do not change.)							
			Reserved (Do not change.)							

(cont'd)

Parameter No.	Size	Name	Setting Range	Units	Factory Setting	When Enabled	Classification	Reference Section	
Pn00C	2	Application Function Select Switch C	0000 to 0111	–	0000	After restart	Setup	4.5	
	<div style="display: flex; justify-content: space-around;"> 4th digit 3rd digit 2nd digit 1st digit </div> <div style="display: flex; justify-content: space-around;"> <input type="checkbox"/> <input type="checkbox"/> <input type="checkbox"/> <input type="checkbox"/> </div>								
			Selection of Test without a Motor						
			0	Disables test without a motor.					
			1	Enables test without a motor.					
			Encoder Resolution for Test without a Motor						
			0	13 bits					
			1	20 bits					
			Encoder Type for Test without a Motor						
			0	Incremental encoder					
		1	Absolute encoder						
		Reserved (Do not change.)							
Pn00D	2	Application Function Select Switch D	0000 to 1001	–	0000	Immediately	Setup	–	
	<div style="display: flex; justify-content: space-around;"> 4th digit 3rd digit 2nd digit 1st digit </div> <div style="display: flex; justify-content: space-around;"> <input type="checkbox"/> <input type="checkbox"/> <input type="checkbox"/> <input type="checkbox"/> </div>								
			Reserved (Do not change.)						
			Reserved (Do not change.)						
			Reserved (Do not change.)						
			Overtravel Warning Detection Selection						
		0	Does not detect overtravel warning.						Reference Section 4.3.2
		1	Detects overtravel warning.						
Pn100	2	Speed Loop Gain	10 to 20000	0.1 Hz	400	Immediately	Tuning	5.8.1	
Pn101	2	Speed Loop Integral Time Constant	15 to 51200	0.01 ms	2000	Immediately	Tuning	5.8.1	
Pn102	2	Position Loop Gain	10 to 20000	0.1/s	400	Immediately	Tuning	5.8.1	
Pn103	2	Moment of Inertia Ratio	0 to 20000	1%	100	Immediately	Tuning	5.8.1	
Pn104	2	2nd Speed Loop Gain	10 to 20000	0.1 Hz	400	Immediately	Tuning	5.8.1	
Pn105	2	2nd Speed Loop Integral Time Constant	15 to 51200	0.01 ms	2000	Immediately	Tuning	5.8.1	
Pn106	2	2nd Position Loop Gain	10 to 20000	0.1/s	400	Immediately	Tuning	5.8.1	
Pn109	2	Feedforward Gain	0 to 100	1%	0	Immediately	Tuning	5.9.1	
Pn10A	2	Feedforward Filter Time Constant	0 to 6400	0.01 ms	0	Immediately	Tuning	5.9.1	

(cont'd)

Parameter No.	Size	Name	Setting Range	Units	Factory Setting	When Enabled	Classification	Reference Section		
Pn10B	2	Application Function for Gain Select Switch	0000 to 5334	–	0000	–	–	–		
		4th digit □ 3rd digit □ 2nd digit □ 1st digit □ n. □								
			Mode Switch Selection				When Enabled	Classification	Reference Section	
			0	Uses internal torque reference as the condition (Level setting: Pn10C).			Immediately	Setup	5.9.2	
			1	Uses speed reference as the condition (Level setting: Pn10D).						
			2	Uses acceleration as the condition (Level setting: Pn10E).						
			3	Uses position error as the condition (Level setting: Pn10F).						
			4	No mode switch function available.						
				Speed Loop Control Method			When Enabled	Classification	Reference Section	
			0	PI control			After restart	Setup	–	
		1	I-P control							
		2 and 3	Reserved (Do not use.)							
			Reserved (Do not change.)							
			Reserved (Do not change.)							
Pn10C	2	Mode Switch (torque reference)	0 to 800	1%	200	Immediately	Tuning	5.9.2		
Pn10D	2	Mode Switch (speed reference)	0 to 10000	1 min ⁻¹	0	Immediately	Tuning	5.9.2		
Pn10E	2	Mode Switch (acceleration)	0 to 30000	1 min ⁻¹ /s	0	Immediately	Tuning	5.9.2		
Pn10F	2	Mode Switch (position error)	0 to 10000	1 reference unit	0	Immediately	Tuning	5.9.2		
Pn11F	2	Position Integral Time Constant	0 to 50000	0.1 ms	0	Immediately	Tuning	5.9.4		
Pn121	2	Friction Compensation Gain	10 to 1000	1%	100	Immediately	Tuning	5.8.2		
Pn122	2	2nd Gain for Friction Compensation	10 to 1000	1%	100	Immediately	Tuning	5.8.2		
Pn123	2	Friction Compensation Coefficient	0 to 100	1%	0	Immediately	Tuning	5.8.2		
Pn124	2	Friction Compensation Frequency Correction	-10000 to 10000	0.1 Hz	0	Immediately	Tuning	5.8.2		
Pn125	2	Friction Compensation Gain Correction	1 to 1000	1%	100	Immediately	Tuning	5.8.2		
Pn131	2	Gain Switching Time 1	0 to 65535	1 ms	0	Immediately	Tuning	5.8.1		
Pn132	2	Gain Switching Time 2	0 to 65535	1 ms	0	Immediately	Tuning	5.8.1		
Pn135	2	Gain Switching Waiting Time 1	0 to 65535	1 ms	0	Immediately	Tuning	5.8.1		
Pn136	2	Gain Switching Waiting Time 2	0 to 65535	1 ms	0	Immediately	Tuning	5.8.1		

(cont'd)

Parameter No.	Size	Name	Setting Range	Units	Factory Setting	When Enabled	Classification	Reference Section															
Pn139	2	Automatic Gain Changeover Related Switch 1	0000 to 0052	–	0000	Immediately	Tuning	5.8.1															
	4th digit <input type="checkbox"/> 3rd digit <input type="checkbox"/> 2nd digit <input type="checkbox"/> 1st digit <input type="checkbox"/> n. <input type="checkbox"/>		<table border="1"> <tr> <th colspan="2">Gain Switching Selection Switch</th> </tr> <tr> <td>0</td> <td>Manual gain switching Changes gain manually using G-SEL of OPTION field.</td> </tr> <tr> <td>1</td> <td>Reserved (Do not use.)</td> </tr> <tr> <td>2</td> <td>Automatic gain switching pattern 1 Changes automatically 1st gain to 2nd gain when the switching condition A is satisfied. Changes automatically 2nd gain to 1st gain when the switching condition A is not satisfied.</td> </tr> </table>							Gain Switching Selection Switch		0	Manual gain switching Changes gain manually using G-SEL of OPTION field.	1	Reserved (Do not use.)	2	Automatic gain switching pattern 1 Changes automatically 1st gain to 2nd gain when the switching condition A is satisfied. Changes automatically 2nd gain to 1st gain when the switching condition A is not satisfied.						
	Gain Switching Selection Switch																						
	0	Manual gain switching Changes gain manually using G-SEL of OPTION field.																					
	1	Reserved (Do not use.)																					
	2	Automatic gain switching pattern 1 Changes automatically 1st gain to 2nd gain when the switching condition A is satisfied. Changes automatically 2nd gain to 1st gain when the switching condition A is not satisfied.																					
			<table border="1"> <tr> <th colspan="2">Gain Switching Condition A</th> </tr> <tr> <td>0</td> <td>Positioning completion signal (/COIN) ON</td> </tr> <tr> <td>1</td> <td>Positioning completion signal (/COIN) OFF</td> </tr> <tr> <td>2</td> <td>Positioning near signal (/NEAR) ON</td> </tr> <tr> <td>3</td> <td>Positioning near signal (/NEAR) OFF</td> </tr> <tr> <td>4</td> <td>Position reference filter output = 0 and position reference input OFF</td> </tr> <tr> <td>5</td> <td>Position reference input ON</td> </tr> </table>							Gain Switching Condition A		0	Positioning completion signal (/COIN) ON	1	Positioning completion signal (/COIN) OFF	2	Positioning near signal (/NEAR) ON	3	Positioning near signal (/NEAR) OFF	4	Position reference filter output = 0 and position reference input OFF	5	Position reference input ON
	Gain Switching Condition A																						
	0	Positioning completion signal (/COIN) ON																					
	1	Positioning completion signal (/COIN) OFF																					
2	Positioning near signal (/NEAR) ON																						
3	Positioning near signal (/NEAR) OFF																						
4	Position reference filter output = 0 and position reference input OFF																						
5	Position reference input ON																						
		Reserved (Do not change.)																					
		Reserved (Do not change.)																					
Pn13D	2	Current Gain Level	100 to 2000	1%	2000	Immediately	Tuning	5.8.4															
Pn140	2	Model Following Control Related Switch	0000 to 1121	–	0100	Immediately	Tuning	–															
	4th digit <input type="checkbox"/> 3rd digit <input type="checkbox"/> 2nd digit <input type="checkbox"/> 1st digit <input type="checkbox"/> n. <input type="checkbox"/>		<table border="1"> <tr> <th colspan="2">Model Following Control Selection</th> </tr> <tr> <td>0</td> <td>Does not use model following control.</td> </tr> <tr> <td>1</td> <td>Uses model following control.</td> </tr> </table>							Model Following Control Selection		0	Does not use model following control.	1	Uses model following control.								
	Model Following Control Selection																						
	0	Does not use model following control.																					
	1	Uses model following control.																					
			<table border="1"> <tr> <th colspan="2">Vibration Suppression Selection</th> </tr> <tr> <td>0</td> <td>Does not perform vibration suppression.</td> </tr> <tr> <td>1</td> <td>Performs vibration suppression over the specified frequency.</td> </tr> <tr> <td>2</td> <td>Performs vibration suppression over two different kinds of frequencies.</td> </tr> </table>							Vibration Suppression Selection		0	Does not perform vibration suppression.	1	Performs vibration suppression over the specified frequency.	2	Performs vibration suppression over two different kinds of frequencies.						
	Vibration Suppression Selection																						
	0	Does not perform vibration suppression.																					
	1	Performs vibration suppression over the specified frequency.																					
	2	Performs vibration suppression over two different kinds of frequencies.																					
		<table border="1"> <tr> <th colspan="2">Vibration Suppression Adjustment Selection</th> <th>Reference Section</th> </tr> <tr> <td>0</td> <td>Does not adjust vibration suppression automatically using utility function.</td> <td rowspan="2">5.3.1, 5.4.1, 5.5.1, 5.7.1</td> </tr> <tr> <td>1</td> <td>Adjusts vibration suppression automatically using utility function.</td> </tr> </table>							Vibration Suppression Adjustment Selection		Reference Section	0	Does not adjust vibration suppression automatically using utility function.	5.3.1, 5.4.1, 5.5.1, 5.7.1	1	Adjusts vibration suppression automatically using utility function.							
Vibration Suppression Adjustment Selection		Reference Section																					
0	Does not adjust vibration suppression automatically using utility function.	5.3.1, 5.4.1, 5.5.1, 5.7.1																					
1	Adjusts vibration suppression automatically using utility function.																						
		<table border="1"> <tr> <th colspan="2">Selection of Speed Feedforward (VFF) / Torque Feedforward (TFF)</th> <th>Reference Section</th> </tr> <tr> <td>0</td> <td>Does not use model following control and speed/torque feedforward together.</td> <td rowspan="2">5.3.1, 5.4.1</td> </tr> <tr> <td>1</td> <td>Uses model following control and speed/torque feedforward together.</td> </tr> </table>							Selection of Speed Feedforward (VFF) / Torque Feedforward (TFF)		Reference Section	0	Does not use model following control and speed/torque feedforward together.	5.3.1, 5.4.1	1	Uses model following control and speed/torque feedforward together.							
Selection of Speed Feedforward (VFF) / Torque Feedforward (TFF)		Reference Section																					
0	Does not use model following control and speed/torque feedforward together.	5.3.1, 5.4.1																					
1	Uses model following control and speed/torque feedforward together.																						
Pn141	2	Model Following Control Gain	10 to 20000	0.1/s	500	Immediately	Tuning	–															
Pn142	2	Model Following Control Gain Compensation	500 to 2000	0.1%	1000	Immediately	Tuning	–															

(cont'd)

Parameter No.	Size	Name	Setting Range	Units	Factory Setting	When Enabled	Classification	Reference Section								
Pn143	2	Model Following Control Bias (Forward Direction)	0 to 10000	0.1%	1000	Immediately	Tuning	–								
Pn144	2	Model Following Control Bias (Reverse Direction)	0 to 10000	0.1%	1000	Immediately	Tuning	–								
Pn145	2	Vibration Suppression 1 Frequency A	10 to 2500	0.1 Hz	500	Immediately	Tuning	–								
Pn146	2	Vibration Suppression 1 Frequency B	10 to 2500	0.1 Hz	700	Immediately	Tuning	–								
Pn147	2	Model Following Control Speed Feedforward Compensation	0 to 10000	0.1%	1000	Immediately	Tuning	–								
Pn148	2	2nd Model Following Control Gain	10 to 20000	0.1/s	500	Immediately	Tuning	–								
Pn149	2	2nd Model Following Control Gain Compensation	500 to 2000	0.1%	1000	Immediately	Tuning	–								
Pn14A	2	Vibration Suppression 2 Frequency	10 to 2000	0.1 Hz	800	Immediately	Tuning	–								
Pn14B	2	Vibration Suppression 2 Compensation	10 to 1000	1%	100	Immediately	Tuning	–								
Pn14F	2	Control Related Switch	0000 to 0011	–	0011	After restart	Tuning	–								
	<table border="1"> <thead> <tr> <th colspan="2">Model Following Control Type Selection</th> <th>Reference Section</th> </tr> </thead> <tbody> <tr> <td>0</td> <td>Model Following Control 1</td> <td rowspan="2">5.3.1, 5.4.1, 5.5.1</td> </tr> <tr> <td>1</td> <td>Model Following Control 2</td> </tr> </tbody> </table>								Model Following Control Type Selection		Reference Section	0	Model Following Control 1	5.3.1, 5.4.1, 5.5.1	1	Model Following Control 2
	Model Following Control Type Selection		Reference Section													
	0	Model Following Control 1	5.3.1, 5.4.1, 5.5.1													
1	Model Following Control 2															
<table border="1"> <thead> <tr> <th colspan="2">Tuning-less Type Selection</th> <th>Reference Section</th> </tr> </thead> <tbody> <tr> <td>0</td> <td>Tuning-less type 1</td> <td rowspan="2">5.2.2</td> </tr> <tr> <td>1</td> <td>Tuning-less type 2</td> </tr> </tbody> </table>								Tuning-less Type Selection		Reference Section	0	Tuning-less type 1	5.2.2	1	Tuning-less type 2	
Tuning-less Type Selection		Reference Section														
0	Tuning-less type 1	5.2.2														
1	Tuning-less type 2															
Reserved (Do not change.)																
Reserved (Do not change.)																

(cont'd)

Parameter No.	Size	Name	Setting Range	Units	Factory Setting	When Enabled	Classification	Reference Section																																													
Pn160	2	Anti-Resonance Control Related Switch	0000 to 0011	–	0010	Immediately	Tuning	5.3.1, 5.4.1, 5.5.1, 5.7.1																																													
		<div style="display: flex; justify-content: space-around; font-size: small;"> 4th digit 3rd digit 2nd digit 1st digit </div> <div style="display: flex; justify-content: space-around; margin-top: 5px;"> n. <input type="checkbox"/> <input type="checkbox"/> <input type="checkbox"/> <input type="checkbox"/> </div>	<table border="1" style="width: 100%; border-collapse: collapse;"> <tr> <th colspan="2">Anti-Resonance Control Selection</th> <th>When Enabled</th> <th>Classification</th> <th>Reference Section</th> </tr> <tr> <td style="width: 20px;">0</td> <td>Does not use anti-resonance control.</td> <td rowspan="2">After restart</td> <td rowspan="2">Setup</td> <td rowspan="2">5.2</td> </tr> <tr> <td>1</td> <td>Uses anti-resonance control.</td> </tr> <tr> <th colspan="2">Anti-Resonance Control Adjustment Selection</th> <th>When Enabled</th> <th>Classification</th> <th>Reference Section</th> </tr> <tr> <td>0</td> <td>Does not adjust anti-resonance control automatically using utility function.</td> <td rowspan="2">After restart</td> <td rowspan="2">Setup</td> <td rowspan="2">5.2</td> </tr> <tr> <td>1</td> <td>Adjusts anti-resonance control automatically using utility function.</td> </tr> <tr> <td colspan="5">Reserved (Do not change.)</td> </tr> <tr> <td colspan="5">Reserved (Do not change.)</td> </tr> </table>							Anti-Resonance Control Selection		When Enabled	Classification	Reference Section	0	Does not use anti-resonance control.	After restart	Setup	5.2	1	Uses anti-resonance control.	Anti-Resonance Control Adjustment Selection		When Enabled	Classification	Reference Section	0	Does not adjust anti-resonance control automatically using utility function.	After restart	Setup	5.2	1	Adjusts anti-resonance control automatically using utility function.	Reserved (Do not change.)					Reserved (Do not change.)														
	Anti-Resonance Control Selection		When Enabled	Classification	Reference Section																																																
	0	Does not use anti-resonance control.	After restart	Setup	5.2																																																
	1	Uses anti-resonance control.																																																			
	Anti-Resonance Control Adjustment Selection		When Enabled	Classification	Reference Section																																																
	0	Does not adjust anti-resonance control automatically using utility function.	After restart	Setup	5.2																																																
	1	Adjusts anti-resonance control automatically using utility function.																																																			
	Reserved (Do not change.)																																																				
	Reserved (Do not change.)																																																				
Pn161	2	Anti-Resonance Frequency	10 to 20000	0.1 Hz	1000	Immediately	Tuning	–																																													
Pn162	2	Anti-Resonance Gain Compensation	1 to 1000	1%	100	Immediately	Tuning	–																																													
Pn163	2	Anti-Resonance Damping Gain	0 to 300	1%	0	Immediately	Tuning	–																																													
Pn164	2	Anti-Resonance Filter Time Constant 1 Compensation	-1000 to 1000	0.01 ms	0	Immediately	Tuning	–																																													
Pn165	2	Anti-Resonance Filter Time Constant 2 Compensation	-1000 to 1000	0.01 ms	0	Immediately	Tuning	–																																													
Pn170	2	Tuning-less Function Related Switch	0000 to 2411	–	1401	–	–	–																																													
		<div style="display: flex; justify-content: space-around; font-size: small;"> 4th digit 3rd digit 2nd digit 1st digit </div> <div style="display: flex; justify-content: space-around; margin-top: 5px;"> n. <input type="checkbox"/> <input type="checkbox"/> <input type="checkbox"/> <input type="checkbox"/> </div>	<table border="1" style="width: 100%; border-collapse: collapse;"> <tr> <th colspan="2">Tuning-less Function Selection</th> <th>When Enabled</th> <th>Classification</th> <th>Reference Section</th> </tr> <tr> <td style="width: 20px;">0</td> <td>Disables tuning-less function.</td> <td rowspan="2">After restart</td> <td rowspan="2">Setup</td> <td rowspan="2">5.2</td> </tr> <tr> <td>1</td> <td>Enables tuning-less function.</td> </tr> <tr> <th colspan="2">Control Method during Speed Control</th> <th>When Enabled</th> <th>Classification</th> <th>Reference Section</th> </tr> <tr> <td>0</td> <td>Uses as speed control.</td> <td rowspan="2">After restart</td> <td rowspan="2">Setup</td> <td rowspan="2">5.2</td> </tr> <tr> <td>1</td> <td>Uses as speed control and uses the host controller for position control.</td> </tr> <tr> <th colspan="2">Tuning-less Tuning Level</th> <th>When Enabled</th> <th>Classification</th> <th>Reference Section</th> </tr> <tr> <td>0 to 4</td> <td>Sets tuning-less tuning level.</td> <td>Immediately</td> <td>Setup</td> <td>5.2</td> </tr> <tr> <th colspan="2">Tuning-less Load Level</th> <th>When Enabled</th> <th>Classification</th> <th>Reference Section</th> </tr> <tr> <td>0 to 2</td> <td>Sets tuning-less load level.</td> <td>Immediately</td> <td>Setup</td> <td>5.2</td> </tr> </table>							Tuning-less Function Selection		When Enabled	Classification	Reference Section	0	Disables tuning-less function.	After restart	Setup	5.2	1	Enables tuning-less function.	Control Method during Speed Control		When Enabled	Classification	Reference Section	0	Uses as speed control.	After restart	Setup	5.2	1	Uses as speed control and uses the host controller for position control.	Tuning-less Tuning Level		When Enabled	Classification	Reference Section	0 to 4	Sets tuning-less tuning level.	Immediately	Setup	5.2	Tuning-less Load Level		When Enabled	Classification	Reference Section	0 to 2	Sets tuning-less load level.	Immediately	Setup	5.2
	Tuning-less Function Selection		When Enabled	Classification	Reference Section																																																
	0	Disables tuning-less function.	After restart	Setup	5.2																																																
	1	Enables tuning-less function.																																																			
	Control Method during Speed Control		When Enabled	Classification	Reference Section																																																
	0	Uses as speed control.	After restart	Setup	5.2																																																
	1	Uses as speed control and uses the host controller for position control.																																																			
	Tuning-less Tuning Level		When Enabled	Classification	Reference Section																																																
	0 to 4	Sets tuning-less tuning level.	Immediately	Setup	5.2																																																
Tuning-less Load Level		When Enabled	Classification	Reference Section																																																	
0 to 2	Sets tuning-less load level.	Immediately	Setup	5.2																																																	
Pn205	2	Multiturn Limit Setting	0 to 65535	1 rev	65535	After restart	Setup	4.7.5																																													

(cont'd)

Parameter No.	Size	Name	Setting Range	Units	Factory Setting	When Enabled	Classification	Reference Section	
Pn207	2	Position Control Function Switch	0000 to 2210	–	0010	After restart	Setup	–	
	4th digit 3rd digit 2nd digit 1st digit n. <input type="checkbox"/> <input type="checkbox"/> <input type="checkbox"/> <input type="checkbox"/>		Reserved (Do not change.)						Reference Section 4.8.6
	Reserved (Do not change.)								
	Reserved (Do not change.)								
	/COIN Output Timing								
0	Outputs when the position error absolute value is the same or less than the positioning completed width (Pn522).								
1	Outputs when the position error absolute value is the same or less than the positioning completed width (Pn522), and the reference after position reference filtering is 0.								
2	Outputs when the position error absolute value is the same or less than the positioning completed width (Pn522), and the position reference input is 0.								
Pn20A	4	Reserved (Do not change.)	–	–	32768	–	–	–	
Pn20E	4	Electronic Gear Ratio (Numerator)	1 to 1073741824	1	4	After restart	Setup	4.4.3	
Pn210	4	Electronic Gear Ratio (Denominator)	1 to 1073741824	1	1	After restart	Setup	4.4.3	
Pn22A	2	Reserved (Do not change.)	–	–	0000	–	–	–	
Pn230	2	Position Control Expanded Function Switch	0000 to 0001	–	0000	After reset	Setup	5.8.6	
	4th digit 3rd digit 2nd digit 1st digit n. <input type="checkbox"/> <input type="checkbox"/> <input type="checkbox"/> <input type="checkbox"/>		Backlash Compensation Direction						
	0	Compensates with a reference in the forward direction.							
	1	Compensates with a reference in the reverse direction.							
	Reserved (Do not change.)								
Reserved (Do not change.)									
Reserved (Do not change.)									
Pn231	4	Backlash Compensation Value	-50000 to 50000	0.1 reference unit	0	Immediately	Setup	5.8.6	
Pn233	2	Backlash Compensation Time Constant	0 to 65536	0.01 ms	0	Immediately	Setup	5.8.6	
Pn281	2	Reserved (Do not change.)	–	–	20	–	–	–	
Pn304	2	JOG Speed	0 to 10000	1 min ⁻¹	500	Immediately	Setup	6.3	
Pn305	2	Soft Start Acceleration Time	0 to 10000	1 ms	0	Immediately	Setup	*1	
Pn306	2	Soft Start Deceleration Time	0 to 10000	1 ms	0	Immediately	Setup	*1	

*1. For details, refer to Σ -V Series User's Manual MECHATROLINK-II Commands (Manual No.: S1EP S800000 54).

(cont'd)

Parameter No.	Size	Name	Setting Range	Units	Factory Setting	When Enabled	Classification	Reference Section																					
Pn310	2	Vibration Detection Switch	0000 to 0002	–	0000	Immediately	Setup	–																					
		4th digit <input type="checkbox"/> 3rd digit <input type="checkbox"/> 2nd digit <input type="checkbox"/> 1st digit <input type="checkbox"/> n. <input type="checkbox"/>	<table border="1"> <thead> <tr> <th colspan="2">Vibration Detection Selection</th> <th>Reference Section</th> </tr> </thead> <tbody> <tr> <td>0</td> <td>Does not detect vibration.</td> <td rowspan="3">6.15</td> </tr> <tr> <td>1</td> <td>Outputs warning (A.911) when vibration is detected.</td> </tr> <tr> <td>2</td> <td>Outputs alarm (A.520) when vibration is detected.</td> </tr> <tr> <td colspan="3">Reserved (Do not change.)</td> </tr> <tr> <td colspan="3">Reserved (Do not change.)</td> </tr> <tr> <td colspan="3">Reserved (Do not change.)</td> </tr> </tbody> </table>						Vibration Detection Selection		Reference Section	0	Does not detect vibration.	6.15	1	Outputs warning (A.911) when vibration is detected.	2	Outputs alarm (A.520) when vibration is detected.	Reserved (Do not change.)			Reserved (Do not change.)			Reserved (Do not change.)				
	Vibration Detection Selection		Reference Section																										
	0	Does not detect vibration.	6.15																										
	1	Outputs warning (A.911) when vibration is detected.																											
	2	Outputs alarm (A.520) when vibration is detected.																											
Reserved (Do not change.)																													
Reserved (Do not change.)																													
Reserved (Do not change.)																													
Pn311	2	Vibration Detection Sensibility	50 to 500	1%	100	Immediately	Tuning	6.15																					
Pn312	2	Vibration Detection Level	0 to 5000	1 min ⁻¹	50	Immediately	Tuning	6.15																					
Pn324	2	Moment of Inertia Calculating Start Level	0 to 20000	1%	300	Immediately	Setup	5.3.2																					
Pn401	2	Torque Reference Filter Time Constant	0 to 65535	0.01 ms	100	Immediately	Tuning	5.9.3																					
Pn402	2	Forward Torque Limit	0 to 800	1%	800	Immediately	Setup	4.6.1																					
Pn403	2	Reverse Torque Limit	0 to 800	1%	800	Immediately	Setup	4.6.1																					
Pn404	2	Forward External Torque Limit	0 to 800	1%	100	Immediately	Setup	4.6.2																					
Pn405	2	Reverse External Torque Limit	0 to 800	1%	100	Immediately	Setup	4.6.2																					
Pn406	2	Emergency Stop Torque	0 to 800	1%	800	Immediately	Setup	4.3.2																					
Pn407	2	Speed Limit during Torque Control	0 to 10000	1 min ⁻¹	10000	Immediately	Setup	4.8.8																					

(cont'd)

Parameter No.	Size	Name	Setting Range	Units	Factory Setting	When Enabled	Classification	Reference Section	
Pn408	2	Torque Related Function Switch	0000 to 1111	–	0000	–	–	–	
		<div style="display: flex; justify-content: space-around; align-items: flex-start;"> <div style="text-align: center;"> 4th digit n. <input type="checkbox"/> </div> <div style="text-align: center;"> 3rd digit <input type="checkbox"/> </div> <div style="text-align: center;"> 2nd digit <input type="checkbox"/> </div> <div style="text-align: center;"> 1st digit <input type="checkbox"/> </div> </div>							
			1st Step Notch Filter Selection				When Enabled	Classification	Reference Section
			0	N/A			Immediately	Setup	5.9.3
			1	Uses 1st step notch filter for torque reference.					
			Speed Limit Selection				When Enabled	Classification	Reference Section
			0	Uses the smaller of the maximum motor speed and the value of Pn407 as the speed limit value.			After restart	Setup	4.8.8
			1	Uses the smaller of the overspeed detection speed and the value of Pn407 as the speed limit value.					
			2nd Step Notch Filter Selection				When Enabled	Classification	Reference Section
			0	N/A			Immediately	Setup	5.9.3
			1	Uses 2nd step notch filter for torque reference.					
			Friction Compensation Function Selection				When Enabled	Classification	Reference Section
			0	Disables friction compensation function.			Immediately	Setup	5.8.2
			1	Enables friction compensation function.					
	Pn409	2	1st Notch Filter Frequency	50 to 5000	1 Hz	5000	Immediately	Tuning	5.9.3
Pn40A	2	1st Notch Filter Q Value	50 to 1000	0.01	70	Immediately	Tuning	5.9.3	
Pn40B	2	1st Notch Filter Depth	0 to 1000	0.001	0	Immediately	Tuning	5.9.3	
Pn40C	2	2nd Notch Filter Frequency	50 to 5000	1 Hz	5000	Immediately	Tuning	5.9.3	
Pn40D	2	2nd Notch Filter Q Value	50 to 1000	0.01	70	Immediately	Tuning	5.9.3	
Pn40E	2	2nd Notch Filter Depth	0 to 1000	0.001	0	Immediately	Tuning	5.9.3	
Pn40F	2	2nd Step 2nd Torque Reference Filter Frequency	100 to 5000	1 Hz	5000	Immediately	Tuning	5.9.3	
Pn410	2	2nd Step 2nd Torque Reference Filter Q Value	50 to 100	0.01	50	Immediately	Tuning	5.9.3	
Pn412	2	1st Step 2nd Torque Reference Filter Time Constant	0 to 65535	0.01 ms	100	Immediately	Tuning	5.8.1	
Pn424	2	Reserved (Do not change.)	–	–	50	–	–	–	
Pn425	2	Reserved (Do not change.)	–	–	100	–	–	–	
Pn456	2	Sweep Torque Reference Amplitude	1 to 800	1%	15	Immediately	Tuning	6.18	

(cont'd)

Parameter No.	Size	Name	Setting Range	Units	Factory Setting	When Enabled	Classification	Reference Section																									
Pn460	2	Notch Filter Adjustment Switch	0000 to 0101	–	0101	Immediately	Tuning	5.2.1, 5.3.1, 5.5.1																									
	<div style="display: flex; justify-content: space-around; align-items: flex-start;"> <div style="text-align: center;"> 4th digit n. <input type="checkbox"/> </div> <div style="text-align: center;"> 3rd digit <input type="checkbox"/> </div> <div style="text-align: center;"> 2nd digit <input type="checkbox"/> </div> <div style="text-align: center;"> 1st digit <input type="checkbox"/> </div> </div>		<table border="1" style="width: 100%; border-collapse: collapse;"> <tr style="background-color: #cccccc;"> <th colspan="2">Notch Filter Adjustment Selection 1</th> </tr> <tr> <td style="text-align: center;">0</td> <td>Does not adjust 1st step notch filter automatically using utility function.</td> </tr> <tr> <td style="text-align: center;">1</td> <td>Adjust 1st step notch filter automatically using utility function.</td> </tr> <tr style="background-color: #cccccc;"> <th colspan="2">Reserved (Do not change.)</th> </tr> <tr style="background-color: #cccccc;"> <th colspan="2">Notch Filter Adjustment Selection 2</th> </tr> <tr> <td style="text-align: center;">0</td> <td>Does not adjust 2nd step notch filter automatically using utility function.</td> </tr> <tr> <td style="text-align: center;">1</td> <td>Adjust 2nd step notch filter automatically using utility function.</td> </tr> <tr style="background-color: #cccccc;"> <th colspan="2">Reserved (Do not change.)</th> </tr> </table>							Notch Filter Adjustment Selection 1		0	Does not adjust 1st step notch filter automatically using utility function.	1	Adjust 1st step notch filter automatically using utility function.	Reserved (Do not change.)		Notch Filter Adjustment Selection 2		0	Does not adjust 2nd step notch filter automatically using utility function.	1	Adjust 2nd step notch filter automatically using utility function.	Reserved (Do not change.)									
	Notch Filter Adjustment Selection 1																																
	0	Does not adjust 1st step notch filter automatically using utility function.																															
	1	Adjust 1st step notch filter automatically using utility function.																															
	Reserved (Do not change.)																																
	Notch Filter Adjustment Selection 2																																
	0	Does not adjust 2nd step notch filter automatically using utility function.																															
	1	Adjust 2nd step notch filter automatically using utility function.																															
	Reserved (Do not change.)																																
Pn501	2	Zero Clamp Level	0 to 10000	1 min ⁻¹	10	Immediately	Setup	–																									
Pn502	2	Rotation Detection Level	1 to 10000	1 min ⁻¹	20	Immediately	Setup	4.8.3																									
Pn503	2	Speed Coincidence Signal Output Width	0 to 100	1 min ⁻¹	10	Immediately	Setup	4.8.5																									
Pn506	2	Brake Reference - Servo OFF Delay Time	0 to 50	10 ms	0	Immediately	Setup	4.3.4																									
Pn507	2	Brake Reference Output Speed Level	0 to 10000	1 min ⁻¹	100	Immediately	Setup	4.3.4																									
Pn508	2	Waiting Time for Brake Signal When Motor Running	10 to 100	10 ms	50	Immediately	Setup	4.3.4																									
Pn509	2	Reserved (Do not change.)	–	–	20	–	–	–																									
Pn50A	2	Input Signal Selection 1	0000 to FFF1	–	1881	After restart	Setup	–																									
	<div style="display: flex; justify-content: space-around; align-items: flex-start;"> <div style="text-align: center;"> 4th digit n. <input type="checkbox"/> </div> <div style="text-align: center;"> 3rd digit <input type="checkbox"/> </div> <div style="text-align: center;"> 2nd digit <input type="checkbox"/> </div> <div style="text-align: center;"> 1st digit <input type="checkbox"/> </div> </div>		<table border="1" style="width: 100%; border-collapse: collapse;"> <tr style="background-color: #cccccc;"> <th colspan="2">Reserved (Do not change.)</th> </tr> <tr style="background-color: #cccccc;"> <th colspan="2">Reserved (Do not change.)</th> </tr> <tr style="background-color: #cccccc;"> <th colspan="2">Reserved (Do not change.)</th> </tr> <tr style="background-color: #cccccc;"> <th colspan="2">P-OT Signal Mapping (Forward run prohibited when OFF (H-level))</th> </tr> <tr> <td style="text-align: center;">0</td> <td>Forward run allowed when CN1-7 input signal is ON (L-level).</td> </tr> <tr> <td style="text-align: center;">1</td> <td>Forward run allowed when CN1-3 input signal is ON (L-level).</td> </tr> <tr> <td style="text-align: center;">2 to 6</td> <td>Forward run allowed when CN1-8 input signal is ON (L-level).</td> </tr> <tr> <td style="text-align: center;">7</td> <td>Forward run prohibited.</td> </tr> <tr> <td style="text-align: center;">8</td> <td>Forward run allowed.</td> </tr> <tr> <td style="text-align: center;">9</td> <td>Forward run allowed when CN1-7 input signal is OFF (H-level).</td> </tr> <tr> <td style="text-align: center;">A</td> <td>Forward run allowed when CN1-3 input signal is OFF (H-level).</td> </tr> <tr> <td style="text-align: center;">B to F</td> <td>Forward run allowed when CN1-8 input signal is OFF (H-level).</td> </tr> </table>							Reserved (Do not change.)		Reserved (Do not change.)		Reserved (Do not change.)		P-OT Signal Mapping (Forward run prohibited when OFF (H-level))		0	Forward run allowed when CN1-7 input signal is ON (L-level).	1	Forward run allowed when CN1-3 input signal is ON (L-level).	2 to 6	Forward run allowed when CN1-8 input signal is ON (L-level).	7	Forward run prohibited.	8	Forward run allowed.	9	Forward run allowed when CN1-7 input signal is OFF (H-level).	A	Forward run allowed when CN1-3 input signal is OFF (H-level).	B to F	Forward run allowed when CN1-8 input signal is OFF (H-level).
	Reserved (Do not change.)																																
	Reserved (Do not change.)																																
	Reserved (Do not change.)																																
	P-OT Signal Mapping (Forward run prohibited when OFF (H-level))																																
	0	Forward run allowed when CN1-7 input signal is ON (L-level).																															
	1	Forward run allowed when CN1-3 input signal is ON (L-level).																															
	2 to 6	Forward run allowed when CN1-8 input signal is ON (L-level).																															
	7	Forward run prohibited.																															
8	Forward run allowed.																																
9	Forward run allowed when CN1-7 input signal is OFF (H-level).																																
A	Forward run allowed when CN1-3 input signal is OFF (H-level).																																
B to F	Forward run allowed when CN1-8 input signal is OFF (H-level).																																
								4.3.2																									

(cont'd)

Parameter No.	Size	Name	Setting Range	Units	Factory Setting	When Enabled	Classification	Reference Section		
Pn50B	2	Input Signal Selection 2	0000 to FFFF	–	8882	After restart	Setup	–		
	<div style="display: flex; justify-content: space-around; align-items: flex-start;"> <div style="text-align: center;"> 4th digit n. <input type="checkbox"/> </div> <div style="text-align: center;"> 3rd digit <input type="checkbox"/> </div> <div style="text-align: center;"> 2nd digit <input type="checkbox"/> </div> <div style="text-align: center;"> 1st digit <input type="checkbox"/> </div> </div>									
			N-OT Signal Mapping (Reverse run prohibited when OFF (H-level))						Reference Section	
			0	Reverse run allowed when CN1-7 input signal is ON (L-level).						4.3.2
			1	Reverse run allowed when CN1-3 input signal is ON (L-level).						
			2 to 6	Reverse run allowed when CN1-8 input signal is ON (L-level).						
			7	Forward run prohibited.						
			8	Forward run allowed.						
			9	Reverse run allowed when CN1-7 input signal is OFF (H-level).						
			A	Reverse run allowed when CN1-3 input signal is OFF (H-level).						
			B to F	Reverse run allowed when CN1-8 input signal is OFF (H-level).						
			Reserved (Do not change.)							
			/P-CL Signal Mapping (Torque Limit when ON (L-level))						Reference Section	
			0	ON when CN1-7 input signal is ON (L-level)						4.6.2
			1	ON when CN1-3 input signal is ON (L-level)						
			2 to 6	ON when CN1-8 input signal is ON (L-level)						
			7	Always active (fixed).						
			8	Not active (fixed).						
		9	OFF when CN1-7 input signal is OFF (H-level)							
		A	OFF when CN1-3 input signal is OFF (H-level)							
		B to F	OFF when CN1-8 input signal is OFF (H-level)							
		/N-CL Signal Mapping (Torque Limit when ON (L-level))						Reference Section		
		0 to F	Same as /P-CL signal mapping						4.6.2	
Pn50E	2	Output Signal Selection 1	0000 to 3333	–	0000	After restart	Setup	–		
	<div style="display: flex; justify-content: space-around; align-items: flex-start;"> <div style="text-align: center;"> 4th digit n. <input type="checkbox"/> </div> <div style="text-align: center;"> 3rd digit <input type="checkbox"/> </div> <div style="text-align: center;"> 2nd digit <input type="checkbox"/> </div> <div style="text-align: center;"> 1st digit <input type="checkbox"/> </div> </div>									
			Positioning Completion Signal Mapping (/COIN)						Reference Section	
			0	Disabled (the above signal is not used.)						4.8.6
			1	Outputs the signal from CN1-11 output terminal.						
			2	Outputs the signal from CN1-10 output terminal.						
			3	Outputs the signal from CN1-9 output terminal.						
			Speed Coincidence Detection Signal Mapping (/V-CMP)						Reference Section	
			0 to 3	Same as /COIN Signal Mapping.						4.8.5
			Servomotor Rotation Detection Signal Mapping (/TGON)						Reference Section	
		0 to 3	Same as /COIN Signal Mapping.						4.8.3	
		Servo Ready Signal Mapping (/S-RDY)						Reference Section		
		0 to 3	Same as /COIN Signal Mapping.						4.8.4	

(cont'd)

Parameter No.	Size	Name	Setting Range	Units	Factory Setting	When Enabled	Classification	Reference Section		
Pn50F	2	Output Signal Selection 2	0000 to 3333	–	0100	After restart	Setup	–		
	<div style="display: flex; justify-content: space-around; align-items: flex-start;"> <div style="text-align: center;"> 4th digit <input type="checkbox"/> </div> <div style="text-align: center;"> 3rd digit <input type="checkbox"/> </div> <div style="text-align: center;"> 2nd digit <input type="checkbox"/> </div> <div style="text-align: center;"> 1st digit <input type="checkbox"/> </div> </div>									
			Torque Limit Detection Signal Mapping (/CLT)						Reference Section	
			0	Disabled (the above signal is not used.)					4.6.3	
			1	Outputs the signal from CN1-11 output terminal.						
			2	Outputs the signal from CN1-10 output terminal.						
			3	Outputs the signal from CN1-9 output terminal.						
			Speed Limit Detection Signal Mapping (/VLT)						Reference Section	
			0 to 3	Same as /CLT Signal Mapping.					4.8.8	
			Brake Signal Mapping (/BK)						Reference Section	
			0 to 3	Same as /CLT Signal Mapping.					4.3.4	
			Warning Signal Mapping (/WARN)						Reference Section	
			0 to 3	Same as /CLT Signal Mapping.					4.8.2	
	Pn510	2	Output Signal Selection 3	0000 to 0333	–	0000	After restart	Setup	–	
		<div style="display: flex; justify-content: space-around; align-items: flex-start;"> <div style="text-align: center;"> 4th digit <input type="checkbox"/> </div> <div style="text-align: center;"> 3rd digit <input type="checkbox"/> </div> <div style="text-align: center;"> 2nd digit <input type="checkbox"/> </div> <div style="text-align: center;"> 1st digit <input type="checkbox"/> </div> </div>								
		Near Signal Mapping (/NEAR)						Reference Section		
		0	Disabled (the above signal is not used.)					4.8.7		
		1	Outputs the signal from CN1-11 terminal.							
		2	Outputs the signal from CN1-10 terminal.							
		3	Outputs the signal from CN1-9 terminal.							
		Reserved (Do not change.)								
		Reserved (Do not change.)								
		Reserved (Do not change.)								

(cont'd)

Parameter No.	Size	Name	Setting Range	Units	Factory Setting	When Enabled	Classification	Reference Section																																	
Pn511	2	Input Signal Selection 5	0000 to FFFF	–	8880	After restart	Setup	3.3.1																																	
	<div style="display: flex; justify-content: space-around; align-items: flex-start;"> <div style="text-align: center;"> <p>4th digit</p> <p>n. <input type="checkbox"/></p> </div> <div style="text-align: center;"> <p>3rd digit</p> <p><input type="checkbox"/></p> </div> <div style="text-align: center;"> <p>2nd digit</p> <p><input type="checkbox"/></p> </div> <div style="text-align: center;"> <p>1st digit</p> <p><input type="checkbox"/></p> </div> </div>		<table border="1" style="width: 100%; border-collapse: collapse;"> <thead> <tr style="background-color: #cccccc;"> <th colspan="2">Homing Deceleration Switch Signal Mapping (/DEC)</th> </tr> </thead> <tbody> <tr> <td style="width: 20px;">0</td> <td>Inputs the signal from CN1-7 input terminal.</td> </tr> <tr> <td>1</td> <td>Inputs the signal from CN1-3 input terminal.</td> </tr> <tr> <td>2 to 6</td> <td>Inputs the signal from CN1-8 input terminal.</td> </tr> <tr> <td>7</td> <td>Always active (fixed).</td> </tr> <tr> <td>8</td> <td>Not active (fixed).</td> </tr> <tr> <td>9</td> <td>Inputs the reversal signal from CN1-7 input terminal.</td> </tr> <tr> <td>A</td> <td>Inputs the reversal signal from CN1-3 input terminal.</td> </tr> <tr> <td>B to F</td> <td>Inputs the reversal signal from CN1-8 input terminal.</td> </tr> </tbody> </table> <table border="1" style="width: 100%; border-collapse: collapse;"> <thead> <tr style="background-color: #cccccc;"> <th colspan="2">External Latch Signal Mapping (/EXT1)</th> </tr> </thead> <tbody> <tr> <td style="width: 20px;">0 to 6</td> <td>Inputs the reversal signal from CN1-7 input terminal.</td> </tr> <tr> <td>7</td> <td>Always active (fixed).</td> </tr> <tr> <td>8</td> <td>Not active (fixed).</td> </tr> <tr> <td>9 to F</td> <td>Inputs the signal from CN1-7 input terminal.</td> </tr> </tbody> </table> <table border="1" style="width: 100%; border-collapse: collapse;"> <tbody> <tr style="background-color: #cccccc;"> <td colspan="2">Reserved (Do not change.)</td> </tr> <tr style="background-color: #cccccc;"> <td colspan="2">Reserved (Do not change.)</td> </tr> </tbody> </table>							Homing Deceleration Switch Signal Mapping (/DEC)		0	Inputs the signal from CN1-7 input terminal.	1	Inputs the signal from CN1-3 input terminal.	2 to 6	Inputs the signal from CN1-8 input terminal.	7	Always active (fixed).	8	Not active (fixed).	9	Inputs the reversal signal from CN1-7 input terminal.	A	Inputs the reversal signal from CN1-3 input terminal.	B to F	Inputs the reversal signal from CN1-8 input terminal.	External Latch Signal Mapping (/EXT1)		0 to 6	Inputs the reversal signal from CN1-7 input terminal.	7	Always active (fixed).	8	Not active (fixed).	9 to F	Inputs the signal from CN1-7 input terminal.	Reserved (Do not change.)		Reserved (Do not change.)	
	Homing Deceleration Switch Signal Mapping (/DEC)																																								
	0	Inputs the signal from CN1-7 input terminal.																																							
	1	Inputs the signal from CN1-3 input terminal.																																							
	2 to 6	Inputs the signal from CN1-8 input terminal.																																							
	7	Always active (fixed).																																							
	8	Not active (fixed).																																							
	9	Inputs the reversal signal from CN1-7 input terminal.																																							
	A	Inputs the reversal signal from CN1-3 input terminal.																																							
B to F	Inputs the reversal signal from CN1-8 input terminal.																																								
External Latch Signal Mapping (/EXT1)																																									
0 to 6	Inputs the reversal signal from CN1-7 input terminal.																																								
7	Always active (fixed).																																								
8	Not active (fixed).																																								
9 to F	Inputs the signal from CN1-7 input terminal.																																								
Reserved (Do not change.)																																									
Reserved (Do not change.)																																									
Pn512	2	Output Signal Inverse Setting	0000 to 0111	–	0000	After restart	Setup	3.3.2																																	
	<div style="display: flex; justify-content: space-around; align-items: flex-start;"> <div style="text-align: center;"> <p>4th digit</p> <p>n. <input type="checkbox"/></p> </div> <div style="text-align: center;"> <p>3rd digit</p> <p><input type="checkbox"/></p> </div> <div style="text-align: center;"> <p>2nd digit</p> <p><input type="checkbox"/></p> </div> <div style="text-align: center;"> <p>1st digit</p> <p><input type="checkbox"/></p> </div> </div>		<table border="1" style="width: 100%; border-collapse: collapse;"> <thead> <tr style="background-color: #cccccc;"> <th colspan="2">Output Signal Inversion for CN1-11 Terminal</th> </tr> </thead> <tbody> <tr> <td style="width: 20px;">0</td> <td>Does not invert outputs.</td> </tr> <tr> <td>1</td> <td>Inverts outputs.</td> </tr> </tbody> </table> <table border="1" style="width: 100%; border-collapse: collapse;"> <thead> <tr style="background-color: #cccccc;"> <th colspan="2">Output Signal Inversion for CN1-10 Terminal</th> </tr> </thead> <tbody> <tr> <td style="width: 20px;">0</td> <td>Does not invert outputs.</td> </tr> <tr> <td>1</td> <td>Inverts outputs.</td> </tr> </tbody> </table> <table border="1" style="width: 100%; border-collapse: collapse;"> <thead> <tr style="background-color: #cccccc;"> <th colspan="2">Output Signal Inversion for CN1-9 Terminal</th> </tr> </thead> <tbody> <tr> <td style="width: 20px;">0</td> <td>Does not invert outputs.</td> </tr> <tr> <td>1</td> <td>Inverts outputs.</td> </tr> </tbody> </table> <table border="1" style="width: 100%; border-collapse: collapse;"> <tbody> <tr style="background-color: #cccccc;"> <td colspan="2">Reserved (Do not change.)</td> </tr> </tbody> </table>							Output Signal Inversion for CN1-11 Terminal		0	Does not invert outputs.	1	Inverts outputs.	Output Signal Inversion for CN1-10 Terminal		0	Does not invert outputs.	1	Inverts outputs.	Output Signal Inversion for CN1-9 Terminal		0	Does not invert outputs.	1	Inverts outputs.	Reserved (Do not change.)													
	Output Signal Inversion for CN1-11 Terminal																																								
	0	Does not invert outputs.																																							
	1	Inverts outputs.																																							
	Output Signal Inversion for CN1-10 Terminal																																								
	0	Does not invert outputs.																																							
1	Inverts outputs.																																								
Output Signal Inversion for CN1-9 Terminal																																									
0	Does not invert outputs.																																								
1	Inverts outputs.																																								
Reserved (Do not change.)																																									
Pn517	2	Reserved (Do not change.)	–	–	0000	–	–	–																																	
Pn51B	4	Reserved (Do not change.)	–	–	1000	–	–	–																																	
Pn51E	2	Excessive Position Error Warning Level	10 to 100	1%	100	Immediately	Setup	8.2.1																																	
Pn520	4	Excessive Position Error Alarm Level	1 to 1073741823	1 reference unit	5242880	Immediately	Setup	5.1.4, 8.1.1																																	
Pn522	4	Positioning Completed Width	0 to 1073741824	1 reference unit	7	Immediately	Setup	4.8.6																																	

(cont'd)

Parameter No.	Size	Name	Setting Range	Units	Factory Setting	When Enabled	Classification	Reference Section																					
Pn524	4	NEAR Signal Width	1 to 1073741824	1 reference unit	1073741824	Immediately	Setup	4.8.7																					
Pn526	4	Excessive Position Error Alarm Level at Servo ON	1 to 1073741823	1 reference unit	5242880	Immediately	Setup	5.1.4																					
Pn528	2	Excessive Position Error Warning Level at Servo ON	10 to 100	1%	100	Immediately	Setup	5.1.4																					
Pn529	2	Speed Limit Level at Servo ON	0 to 10000	1 min ⁻¹	10000	Immediately	Setup	5.1.4																					
Pn52A	2	Reserved (Do not change.)	–	–	20	–	–	–																					
Pn52B	2	Overload Warning Level	1 to 100	1%	20	Immediately	Setup	4.3.6																					
Pn52C	2	Derating of Base Current at Detecting Overload of Motor	10 to 100	1%	100	After restart	Setup	4.3.6																					
Pn52D	2	Reserved (Do not change.)	–	–	50	–	–	–																					
Pn52F	2	Reserved (Do not change.)	–	–	0FFF	–	–	–																					
Pn530	2	Program JOG Operation Related Switch	0000 to 0005	–	0000	Immediately	Setup	6.5																					
	4th digit 3rd digit 2nd digit 1st digit n. <input type="checkbox"/> <input type="checkbox"/> <input type="checkbox"/> <input type="checkbox"/>		<table border="1"> <thead> <tr> <th colspan="2">Program JOG Operation Switch</th> </tr> </thead> <tbody> <tr> <td>0</td> <td>(Waiting time Pn535 → Forward movement Pn531) × Number of movements Pn536</td> </tr> <tr> <td>1</td> <td>(Waiting time Pn535 → Reverse movement Pn531) × Number of movements Pn536</td> </tr> <tr> <td>2</td> <td>(Waiting time Pn535 → Forward movement Pn531) × Number of movements Pn536 (Waiting time Pn535 → Reverse movement Pn531) × Number of movements Pn536</td> </tr> <tr> <td>3</td> <td>(Waiting time Pn535 → Reverse movement Pn531) × Number of movements Pn536 (Waiting time Pn535 → Forward movement Pn531) × Number of movements Pn536</td> </tr> <tr> <td>4</td> <td>(Waiting time Pn535 → Forward movement Pn531 → Waiting time Pn535 → Reverse movement Pn531) × Number of movements Pn536</td> </tr> <tr> <td>5</td> <td>(Waiting time Pn535 → Reverse movement Pn531 → Waiting time Pn535 → Forward movement Pn531) × Number of movements Pn536</td> </tr> <tr> <td colspan="2">Reserved (Do not change.)</td> </tr> <tr> <td colspan="2">Reserved (Do not change.)</td> </tr> <tr> <td colspan="2">Reserved (Do not change.)</td> </tr> </tbody> </table>							Program JOG Operation Switch		0	(Waiting time Pn535 → Forward movement Pn531) × Number of movements Pn536	1	(Waiting time Pn535 → Reverse movement Pn531) × Number of movements Pn536	2	(Waiting time Pn535 → Forward movement Pn531) × Number of movements Pn536 (Waiting time Pn535 → Reverse movement Pn531) × Number of movements Pn536	3	(Waiting time Pn535 → Reverse movement Pn531) × Number of movements Pn536 (Waiting time Pn535 → Forward movement Pn531) × Number of movements Pn536	4	(Waiting time Pn535 → Forward movement Pn531 → Waiting time Pn535 → Reverse movement Pn531) × Number of movements Pn536	5	(Waiting time Pn535 → Reverse movement Pn531 → Waiting time Pn535 → Forward movement Pn531) × Number of movements Pn536	Reserved (Do not change.)		Reserved (Do not change.)		Reserved (Do not change.)	
	Program JOG Operation Switch																												
	0	(Waiting time Pn535 → Forward movement Pn531) × Number of movements Pn536																											
	1	(Waiting time Pn535 → Reverse movement Pn531) × Number of movements Pn536																											
	2	(Waiting time Pn535 → Forward movement Pn531) × Number of movements Pn536 (Waiting time Pn535 → Reverse movement Pn531) × Number of movements Pn536																											
	3	(Waiting time Pn535 → Reverse movement Pn531) × Number of movements Pn536 (Waiting time Pn535 → Forward movement Pn531) × Number of movements Pn536																											
	4	(Waiting time Pn535 → Forward movement Pn531 → Waiting time Pn535 → Reverse movement Pn531) × Number of movements Pn536																											
	5	(Waiting time Pn535 → Reverse movement Pn531 → Waiting time Pn535 → Forward movement Pn531) × Number of movements Pn536																											
	Reserved (Do not change.)																												
Reserved (Do not change.)																													
Reserved (Do not change.)																													
Pn531	4	Program JOG Movement Distance	1 to 1073741824	1 reference unit	32768	Immediately	Setup	6.5																					
Pn533	2	Program JOG Movement Speed	1 to 10000	1 min ⁻¹	500	Immediately	Setup	6.5																					
Pn534	2	Program JOG Acceleration/Deceleration Time	2 to 10000	1 ms	100	Immediately	Setup	6.5																					
Pn535	2	Program JOG Waiting Time	0 to 10000	1 ms	100	Immediately	Setup	6.5																					
Pn536	2	Number of Times of Program JOG Movement	0 to 1000	1 time	1	Immediately	Setup	6.5																					
Pn550	2	Analog Monitor 1 Offset Voltage	-10000 to 10000	0.1 V	0	Immediately	Setup	5.1.3																					
Pn551	2	Analog Monitor 2 Offset Voltage	-10000 to 10000	0.1 V	0	Immediately	Setup	5.1.3																					

(cont'd)

Parameter No.	Size	Name	Setting Range	Units	Factory Setting	When Enabled	Classification	Reference Section																													
Pn552	2	Analog Monitor Magnification (×1)	-10000 to 10000	×0.01	100	Immediately	Setup	5.1.3																													
Pn553	2	Analog Monitor Magnification (×2)	-10000 to 10000	×0.01	100	Immediately	Setup	5.1.3																													
Pn560	2	Remained Vibration Detection Width	1 to 3000	0.1%	400	Immediately	Setup	5.7.1																													
Pn561	2	Overshoot Detection Level	0 to 100	1%	100	Immediately	Setup	5.3.1, 5.4.1																													
Pn600	2	Reserved (Do not change.)	–	–	0	–	–	–																													
Pn601	2	Reserved (Do not change.)	–	–	0	–	–	–																													
Pn800	2	Communications Control	–	–	0040	Immediately	Setup	*1																													
		4th digit <input type="checkbox"/> 3rd digit <input type="checkbox"/> 2nd digit <input type="checkbox"/> 1st digit <input type="checkbox"/> n. <input type="checkbox"/>	<table border="1"> <thead> <tr> <th colspan="2">MECHATROLINK-II Communications Check Mask (for debug)</th> </tr> </thead> <tbody> <tr> <td>0</td> <td>No mask</td> </tr> <tr> <td>1</td> <td>Ignores MECHATROLINK communications error (A.E60).</td> </tr> <tr> <td>2</td> <td>Ignores WDT error (A.E50).</td> </tr> <tr> <td>3</td> <td>Ignores both MECHATROLINK communications error (A.E60) and WDT error (A.E50).</td> </tr> </tbody> </table> <table border="1"> <thead> <tr> <th colspan="2">Warning Check Mask</th> </tr> </thead> <tbody> <tr> <td>0</td> <td>No mask</td> </tr> <tr> <td>1</td> <td>Ignores data setting warning (A.94□).</td> </tr> <tr> <td>2</td> <td>Ignores command warning (A.95□).</td> </tr> <tr> <td>3</td> <td>Ignores both data setting warning (A.94□) and command warning (A.95□).</td> </tr> <tr> <td>4</td> <td>Ignores communications warning (A.96□).</td> </tr> <tr> <td>5</td> <td>Ignores both data setting warning (A.94□) and communications warning (A.96□).</td> </tr> <tr> <td>6</td> <td>Ignores both command warning (A.95□) and communications warning (A.96□).</td> </tr> <tr> <td>7</td> <td>Ignores data setting warning (A.94□), command warning (A.95□) and communications warning (A.96□).</td> </tr> </tbody> </table>							MECHATROLINK-II Communications Check Mask (for debug)		0	No mask	1	Ignores MECHATROLINK communications error (A.E60).	2	Ignores WDT error (A.E50).	3	Ignores both MECHATROLINK communications error (A.E60) and WDT error (A.E50).	Warning Check Mask		0	No mask	1	Ignores data setting warning (A.94□).	2	Ignores command warning (A.95□).	3	Ignores both data setting warning (A.94□) and command warning (A.95□).	4	Ignores communications warning (A.96□).	5	Ignores both data setting warning (A.94□) and communications warning (A.96□).	6	Ignores both command warning (A.95□) and communications warning (A.96□).	7	Ignores data setting warning (A.94□), command warning (A.95□) and communications warning (A.96□).
	MECHATROLINK-II Communications Check Mask (for debug)																																				
	0	No mask																																			
	1	Ignores MECHATROLINK communications error (A.E60).																																			
	2	Ignores WDT error (A.E50).																																			
3	Ignores both MECHATROLINK communications error (A.E60) and WDT error (A.E50).																																				
Warning Check Mask																																					
0	No mask																																				
1	Ignores data setting warning (A.94□).																																				
2	Ignores command warning (A.95□).																																				
3	Ignores both data setting warning (A.94□) and command warning (A.95□).																																				
4	Ignores communications warning (A.96□).																																				
5	Ignores both data setting warning (A.94□) and communications warning (A.96□).																																				
6	Ignores both command warning (A.95□) and communications warning (A.96□).																																				
7	Ignores data setting warning (A.94□), command warning (A.95□) and communications warning (A.96□).																																				
		Reserved (Do not change.)																																			
		Reserved (Do not change.)																																			

*1. For details, refer to *Σ-V Series User's Manual MECHATROLINK-II Commands* (Manual No.: S1EP S800000 54).

(cont'd)

Parameter No.	Size	Name	Setting Range	Units	Factory Setting	When Enabled	Classification	Reference Section																					
Pn801	2	Application Function Select 6 (Software LS)	–	–	0003	Immediately	Setup	4.3.3																					
	4th digit <input type="checkbox"/> 3rd digit <input type="checkbox"/> 2nd digit <input type="checkbox"/> 1st digit <input type="checkbox"/> n. <input type="checkbox"/>		<table border="1"> <tr> <th colspan="2">Software Limit Function</th> </tr> <tr> <td>0</td> <td>Enables forward and reverse software limit.</td> </tr> <tr> <td>1</td> <td>Disables forward software limit.</td> </tr> <tr> <td>2</td> <td>Disables reverse software limit.</td> </tr> <tr> <td>3</td> <td>Disables software limit in both directions.</td> </tr> <tr> <th colspan="2">Reserved (Do not change.)</th> </tr> <tr> <th colspan="2">Software Limit for Reference</th> </tr> <tr> <td>0</td> <td>Disables software limit for reference.</td> </tr> <tr> <td>1</td> <td>Enables software limit for reference.</td> </tr> <tr> <th colspan="2">Reserved (Do not change.)</th> </tr> </table>							Software Limit Function		0	Enables forward and reverse software limit.	1	Disables forward software limit.	2	Disables reverse software limit.	3	Disables software limit in both directions.	Reserved (Do not change.)		Software Limit for Reference		0	Disables software limit for reference.	1	Enables software limit for reference.	Reserved (Do not change.)	
	Software Limit Function																												
	0	Enables forward and reverse software limit.																											
	1	Disables forward software limit.																											
	2	Disables reverse software limit.																											
	3	Disables software limit in both directions.																											
	Reserved (Do not change.)																												
	Software Limit for Reference																												
	0	Disables software limit for reference.																											
1	Enables software limit for reference.																												
Reserved (Do not change.)																													
Pn803	2	Origin Range	0 to 250	1 reference unit	10	Immediately	Setup	*1																					
Pn804	4	Forward Software Limit	-1073741823 to 1073741823	1 reference unit	1073741823	Immediately	Setup	4.3.3																					
Pn806	4	Reverse Software Limit	-1073741823 to 1073741823	1 reference unit	-1073741823	Immediately	Setup	4.3.3																					
Pn808	4	Absolute Encoder Origin Offset	-1073741823 to 1073741823	1 reference unit	0	Immediately*2	Setup	4.7.7																					
Pn80A	2	1st Linear Acceleration Constant	1 to 65535	10000 reference unit/s ²	100	Immediately*3	Setup	*1																					
Pn80B	2	2nd Linear Acceleration Constant	1 to 65535	10000 reference unit/s ²	100	Immediately*3	Setup	*1																					
Pn80C	2	Acceleration Constant Switching Speed	0 to 65535	100 reference unit/s	0	Immediately*3	Setup	*1																					
Pn80D	2	1st Linear Deceleration Constant	1 to 65535	10000 reference unit/s ²	100	Immediately*3	Setup	*1																					
Pn80E	2	2nd Linear Deceleration Constant	1 to 65535	10000 reference unit/s ²	100	Immediately*3	Setup	*1																					
Pn80F	2	Deceleration Constant Switching Speed	0 to 65535	100 reference unit/s	0	Immediately*3	Setup	*1																					

*1. For details, refer to *Σ-V Series User's Manual MECHATROLINK-II Commands* (Manual No.: SIEP S800000 54).
 *2. Available after the SENS_ON command is input.
 *3. Change the setting when the reference is stopped (DEN is set to 1), because the change will affect the output during operation.

(cont'd)

Parameter No.	Size	Name	Setting Range	Units	Factory Setting	When Enabled	Classification	Reference Section				
Pn810	2	Exponential Function Acceleration/Deceleration Bias	0 to 65535	100 reference unit/s	0	Immediately*4	Setup	*1				
Pn811	2	Exponential Function Acceleration/Deceleration Time Constant	0 to 5100	0.1 ms	0	Immediately*4	Setup	*1				
Pn812	2	Movement Average Time	0 to 5100	0.1 ms	0	Immediately*4	Setup	*1				
Pn814	4	Final Travel Distance for External Positioning	-1073741823 to 1073741823	1 reference unit	100	Immediately	Setup	*1				
Pn816	2	Homing Mode Setting	–	–	0000	Immediately	Setup	*1				
	<p>4th digit 3rd digit 2nd digit 1st digit</p> <p>n. <input type="checkbox"/> <input type="checkbox"/> <input type="checkbox"/> <input type="checkbox"/></p> <p>Software Limit Function</p> <table border="1"> <tr> <td>0</td> <td>Forward</td> </tr> <tr> <td>1</td> <td>Reverse</td> </tr> </table> <p>Reserved (Do not change.)</p> <p>Reserved (Do not change.)</p> <p>Reserved (Do not change.)</p>								0	Forward	1	Reverse
	0	Forward										
	1	Reverse										
	Pn817 *5	2	Homing Approach Speed 1	0 to 65535	100 reference unit/s	50	Immediately*3	Setup	*1			
Pn818 *6	2	Homing Approach Speed 2	0 to 65535	100 reference unit/s	5	Immediately*3	Setup	*1				
Pn819	4	Final Travel Distance for Homing	-1073741823 to 1073741823	1 reference unit	100	Immediately	Setup	*1				

- *1. For details, refer to *ΣV Series User's Manual MECHATROLINK-II Commands* (Manual No.: S1EP S800000 54).
- *3. Change the setting when the reference is stopped (DEN is set to 1), because the change will affect the output during operation.
- *4. The settings are updated only if the sending of the reference has been stopped (DEN is set to 1).
- *5. The set value of Pn842 is valid when the set value of Pn817 is 0. Software version 0023 or higher is required to use Pn842.
- *6. The set value of Pn844 is valid when the set value of Pn818 is 0. Software version 0023 or higher is required to use Pn844.

(cont'd)

Parameter No.	Size	Name	Setting Range	Units	Factory Setting	When Enabled	Classification	Reference Section																														
Pn81E	2	Input Signal Monitor Selection	—	—	0000	Immediately	Setup	*1																														
	<div style="display: flex; align-items: flex-start;"> <div style="margin-right: 20px;"> <p>4th digit</p> <p>3rd digit</p> <p>2nd digit</p> <p>1st digit</p> <p>n. <input type="checkbox"/> <input type="checkbox"/> <input type="checkbox"/> <input type="checkbox"/></p> </div> <div> <table border="1" style="width: 100%; border-collapse: collapse;"> <tr style="background-color: #cccccc;"> <th colspan="2">IO12 Signal Mapping</th> </tr> <tr><td>0</td><td>No mapping</td></tr> <tr><td>1</td><td>Monitors CN1-13 input terminal.</td></tr> <tr><td>2</td><td>Monitors CN1-7 input terminal.</td></tr> <tr><td>3</td><td>Monitors CN1-8 input terminal.</td></tr> <tr><td>4</td><td>Monitors CN1-9 input terminal.</td></tr> <tr><td>5</td><td>Monitors CN1-10 input terminal.</td></tr> <tr><td>6</td><td>Monitors CN1-11 input terminal.</td></tr> <tr><td>7</td><td>Monitors CN1-12 input terminal.</td></tr> </table> <table border="1" style="width: 100%; border-collapse: collapse;"> <tr style="background-color: #cccccc;"> <th colspan="2">IO13 Signal Mapping</th> </tr> <tr><td>0 to 7</td><td>Same as IO2 signal mapping.</td></tr> </table> <table border="1" style="width: 100%; border-collapse: collapse;"> <tr style="background-color: #cccccc;"> <th colspan="2">IO14 Signal Mapping</th> </tr> <tr><td>0 to 7</td><td>Same as IO2 signal mapping.</td></tr> </table> <table border="1" style="width: 100%; border-collapse: collapse;"> <tr style="background-color: #cccccc;"> <th colspan="2">IO15 Signal Mapping</th> </tr> <tr><td>0 to 7</td><td>Same as IO2 signal mapping.</td></tr> </table> </div> </div>								IO12 Signal Mapping		0	No mapping	1	Monitors CN1-13 input terminal.	2	Monitors CN1-7 input terminal.	3	Monitors CN1-8 input terminal.	4	Monitors CN1-9 input terminal.	5	Monitors CN1-10 input terminal.	6	Monitors CN1-11 input terminal.	7	Monitors CN1-12 input terminal.	IO13 Signal Mapping		0 to 7	Same as IO2 signal mapping.	IO14 Signal Mapping		0 to 7	Same as IO2 signal mapping.	IO15 Signal Mapping		0 to 7	Same as IO2 signal mapping.
	IO12 Signal Mapping																																					
	0	No mapping																																				
	1	Monitors CN1-13 input terminal.																																				
2	Monitors CN1-7 input terminal.																																					
3	Monitors CN1-8 input terminal.																																					
4	Monitors CN1-9 input terminal.																																					
5	Monitors CN1-10 input terminal.																																					
6	Monitors CN1-11 input terminal.																																					
7	Monitors CN1-12 input terminal.																																					
IO13 Signal Mapping																																						
0 to 7	Same as IO2 signal mapping.																																					
IO14 Signal Mapping																																						
0 to 7	Same as IO2 signal mapping.																																					
IO15 Signal Mapping																																						
0 to 7	Same as IO2 signal mapping.																																					
Pn81F	2	Command Data Allocation	—	—	0000	After restart	Setup	*1																														
	<div style="display: flex; align-items: flex-start;"> <div style="margin-right: 20px;"> <p>4th digit</p> <p>3rd digit</p> <p>2nd digit</p> <p>1st digit</p> <p>n. <input type="checkbox"/> <input type="checkbox"/> <input type="checkbox"/> <input type="checkbox"/></p> </div> <div> <table border="1" style="width: 100%; border-collapse: collapse;"> <tr style="background-color: #cccccc;"> <th colspan="2">Option Field Allocation</th> </tr> <tr><td>0</td><td>Disables OPTION bit allocation.</td></tr> <tr><td>1</td><td>Enables OPTION bit allocation.</td></tr> </table> <table border="1" style="width: 100%; border-collapse: collapse;"> <tr style="background-color: #cccccc;"> <th colspan="2">Software Limit Function</th> </tr> <tr><td>0</td><td>Disables allocation.</td></tr> <tr><td>1</td><td>Enables allocation.</td></tr> </table> <table border="1" style="width: 100%; border-collapse: collapse;"> <tr style="background-color: #cccccc;"> <th colspan="2">Reserved (Do not change.)</th> </tr> </table> <table border="1" style="width: 100%; border-collapse: collapse;"> <tr style="background-color: #cccccc;"> <th colspan="2">Reserved (Do not change.)</th> </tr> </table> </div> </div>								Option Field Allocation		0	Disables OPTION bit allocation.	1	Enables OPTION bit allocation.	Software Limit Function		0	Disables allocation.	1	Enables allocation.	Reserved (Do not change.)		Reserved (Do not change.)															
	Option Field Allocation																																					
	0	Disables OPTION bit allocation.																																				
	1	Enables OPTION bit allocation.																																				
Software Limit Function																																						
0	Disables allocation.																																					
1	Enables allocation.																																					
Reserved (Do not change.)																																						
Reserved (Do not change.)																																						
Pn820	4	Forward Latching Allowable Area	-2147483648 to 2147483647	1 reference unit	0	Immediately	Setup	*1																														
Pn822	4	Reverse Latching Allowable Area	-2147483648 to 2147483647	1 reference unit	0	Immediately	Setup	*1																														

*1. For details, refer to *Σ-V Series User's Manual MECHATROLINK-II Commands* (Manual No.: SIEP S800000 54).

(cont'd)

Parameter No.	Size	Name	Setting Range	Units	Factory Setting	When Enabled	Classification	Reference Section
Pn824	2	Option Monitor 1 Selection	–	–	0000	Immediately	Setup	*1
		0000H	Motor rotating speed [1000000H/overspeed detection position]					
		0001H	Speed reference [1000000H/overspeed detection position]					
		0002H	Torque [1000000H/max. torque]					
		0003H	Position error (lower 32 bits) [reference unit]					
		0004H	Position error (upper 32 bits) [reference unit]					
		0005H	System reserved					
		0006H	System reserved					
		000AH	Encoder count (lower 32 bits) [reference unit]					
		000BH	Encoder count (upper 32 bits) [reference unit]					
		000CH	System reserved					
		000DH	System reserved					
		0010H	Un000: Motor rotating speed [min^{-1}]					
		0011H	Un001: Speed reference [min^{-1}]					
		0012H	Un002: Torque reference [%]					
		0013H	Un003: Rotational angle 1 (encoder pulses from the phase-C origin: decimal display)					
		0014H	Un004: Rotational angle 2 [deg]					
		0015H	Un005: Input signal monitor					
		0016H	Un006: Output signal monitor					
		0017H	Un007: Input reference pulse speed [min^{-1}]					
		0018H	Un008: Position error [reference unit]					
		0019H	Un009: Accumulated load ratio [%]					
		001AH	System reserved					
		001BH	System reserved					
		001CH	Un00C: Input reference pulse counter [reference unit]					
		001DH	Un00D: Feedback pulse counter [encoder pulse]					
		001EH	System reserved					
		001FH	System reserved					
		0023H	Primary multi-turn data [Rev]					
0024H	Primary incremental data [pulse]							
0027H	System reserved							
0080H	Previous value of latched feedback position (LPOS) [encoder pulse]							
Pn825	2	Option Monitor 2 Selection	–	–	0000	Immediately	Setup	*1
		0000H to 0080H	Same as Option Monitor 1 Selection.					

*1. For details, refer to Σ -V Series User's Manual MECHATROLINK-II Commands (Manual No.: S1EP S800000 54).

(cont'd)

Parameter No.	Size	Name	Setting Range	Units	Factory Setting	When Enabled	Classification	Reference Section											
Pn827	2	Linear Deceleration Constant 1 for Stopping	1 to 65535	10000 reference unit/s ²	100	Immediately ^{*3}	Setup	*1											
Pn829	2	SVOFF Waiting Time (SVOFF at deceleration to stop)	0 to 65535	10 ms	0	Immediately ^{*3}	Setup	*1											
Pn82A	2	Option Field Allocation 1	0000 to 1E1E	–	1813	After restart	Setup	*1											
	<p>4th digit 3rd digit 2nd digit 1st digit n. <input type="checkbox"/> <input type="checkbox"/> <input type="checkbox"/> <input type="checkbox"/></p> <table border="1"> <tr> <td>0 to E</td> <td>ACCFIL bit position</td> </tr> <tr> <td>0</td> <td>Disables ACCFIL bit allocation.</td> </tr> <tr> <td>1</td> <td>Enables ACCFIL bit allocation.</td> </tr> <tr> <td>0 to E</td> <td>GSEL bit position</td> </tr> <tr> <td>0</td> <td>Disables GSEL bit allocation.</td> </tr> <tr> <td>1</td> <td>Enables GSEL bit allocation.</td> </tr> </table>								0 to E	ACCFIL bit position	0	Disables ACCFIL bit allocation.	1	Enables ACCFIL bit allocation.	0 to E	GSEL bit position	0	Disables GSEL bit allocation.	1
0 to E	ACCFIL bit position																		
0	Disables ACCFIL bit allocation.																		
1	Enables ACCFIL bit allocation.																		
0 to E	GSEL bit position																		
0	Disables GSEL bit allocation.																		
1	Enables GSEL bit allocation.																		
Pn82B	2	Option Field Allocation 2	0000 to 1F1F	–	1D1C	After restart	Setup	*1											
	<p>4th digit 3rd digit 2nd digit 1st digit n. <input type="checkbox"/> <input type="checkbox"/> <input type="checkbox"/> <input type="checkbox"/></p> <table border="1"> <tr> <td>0 to F</td> <td>V_PPI bit position</td> </tr> <tr> <td>0</td> <td>Disables V_PPI bit allocation.</td> </tr> <tr> <td>1</td> <td>Enables V_PPI bit allocation.</td> </tr> <tr> <td>0 to F</td> <td>P_PI_CLR bit position</td> </tr> <tr> <td>0</td> <td>Disables P_PI_CLR bit allocation.</td> </tr> <tr> <td>1</td> <td>Enables P_PI_CLR bit allocation.</td> </tr> </table>								0 to F	V_PPI bit position	0	Disables V_PPI bit allocation.	1	Enables V_PPI bit allocation.	0 to F	P_PI_CLR bit position	0	Disables P_PI_CLR bit allocation.	1
0 to F	V_PPI bit position																		
0	Disables V_PPI bit allocation.																		
1	Enables V_PPI bit allocation.																		
0 to F	P_PI_CLR bit position																		
0	Disables P_PI_CLR bit allocation.																		
1	Enables P_PI_CLR bit allocation.																		

*1. For details, refer to *Σ-V Series User's Manual MECHATROLINK-II Commands* (Manual No.: SIEP S800000 54).
 *3. Change the setting when the reference is stopped (DEN is set to 1), because the change will affect the output during operation.

(cont'd)

Parameter No.	Size	Name	Setting Range	Units	Factory Setting	When Enabled	Classification	Reference Section			
Pn82C	2	Option Field Allocation 3	0000 to 1F1F	–	1F1E	After restart	Setup	*1			
	<p>4th digit 3rd digit 2nd digit 1st digit</p> <p>n. <input type="checkbox"/> <input type="checkbox"/> <input type="checkbox"/> <input type="checkbox"/></p> <p>0 to F P_CL bit position</p> <p>0 Disables P_CL bit allocation.</p> <p>1 Enables P_CL bit allocation.</p> <p>0 to F N_CL bit position</p> <p>0 Disables N_CL bit allocation.</p> <p>1 Enables N_CL bit allocation.</p>										
	Pn82D	2	Option Field Allocation 4	0000 to 1F1C	–	0000	After restart	Setup	*1		
		<p>4th digit 3rd digit 2nd digit 1st digit</p> <p>n. <input type="checkbox"/> <input type="checkbox"/> <input type="checkbox"/> <input type="checkbox"/></p> <p>0 to C BANK_SEL1 bit position</p> <p>0 Disables BANK_SEL1 bit allocation.</p> <p>1 Enables BANK_SEL1 bit allocation.</p> <p>0 to F LT_DISABLE bit position</p> <p>0 Disables LT_DISABLE bit allocation.</p> <p>1 Enables LT_DISABLE bit allocation.</p>									
		Pn82E	2	Option Field Allocation 5	0000 to 1D1F	–	0000	After restart	Setup	*1	
			<p>4th digit 3rd digit 2nd digit 1st digit</p> <p>n. <input type="checkbox"/> <input type="checkbox"/> <input type="checkbox"/> <input type="checkbox"/></p> <p>Reserved (Do not change.)</p> <p>Reserved (Do not change.)</p> <p>0 to D OUT_SIGNAL bit position</p> <p>0 Disables OUT_SIGNAL bit allocation.</p> <p>1 Enables OUT_SIGNAL bit allocation.</p>								

*1. For details, refer to *ΣV Series User's Manual MECHATROLINK-II Commands* (Manual No.: SIEP S800000 54).

(cont'd)

Parameter No.	Size	Name	Setting Range	Units	Factory Setting	When Enabled	Classification	Reference Section													
Pn833	2	Motion Setting	0000 to 0001	–	0000	After restart	Setup	*1													
		4th digit <input type="checkbox"/> 3rd digit <input type="checkbox"/> 2nd digit <input type="checkbox"/> 1st digit <input type="checkbox"/> n. <input type="checkbox"/>	<table border="1"> <thead> <tr> <th colspan="2">Linear Accel/Decel Constant Selection</th> </tr> </thead> <tbody> <tr> <td>0</td> <td>Uses Pn80A to Pn80F and Pn827. (Setting of Pn834 to Pn840 disabled)</td> </tr> <tr> <td>1</td> <td>Uses Pn834 to Pn840. (Setting of Pn80A to Pn80F and Pn827 disabled)</td> </tr> <tr> <td colspan="2">Reserved (Do not change.)</td> </tr> <tr> <td colspan="2">Reserved (Do not change.)</td> </tr> <tr> <td colspan="2">Reserved (Do not change.)</td> </tr> </tbody> </table>							Linear Accel/Decel Constant Selection		0	Uses Pn80A to Pn80F and Pn827. (Setting of Pn834 to Pn840 disabled)	1	Uses Pn834 to Pn840. (Setting of Pn80A to Pn80F and Pn827 disabled)	Reserved (Do not change.)		Reserved (Do not change.)		Reserved (Do not change.)	
	Linear Accel/Decel Constant Selection																				
	0	Uses Pn80A to Pn80F and Pn827. (Setting of Pn834 to Pn840 disabled)																			
	1	Uses Pn834 to Pn840. (Setting of Pn80A to Pn80F and Pn827 disabled)																			
	Reserved (Do not change.)																				
Reserved (Do not change.)																					
Reserved (Do not change.)																					
Pn834	4	1st Linear Acceleration Constant 2	1 to 20971520	10000 reference unit/s ²	100	Immediately *3	Setup	*1													
Pn836	4	2nd Linear Acceleration Constant 2	1 to 20971520	10000 reference unit/s	100	Immediately *3	Setup	*1													
Pn838	4	Acceleration Constant Switching Speed 2	0 to 2097152000	1 reference unit/s	0	Immediately *3	Setup	*1													
Pn83A	4	1st Linear Deceleration Constant 2	1 to 20971520	10000 reference unit/s ²	100	Immediately *3	Setup	*1													
Pn83C	4	2nd Linear Deceleration Constant 2	1 to 20971520	10000 reference unit/s ²	100	Immediately *3	Setup	*1													
Pn83E	4	Deceleration Constant Switching Speed 2	0 to 2097152000	1 reference unit/s	0	Immediately *3	Setup	*1													
Pn840	4	Linear Deceleration Constant 2 for Stopping	1 to 20971520	10000 reference unit/s ²	100	Immediately *3	Setup	*1													
Pn842 ^{*5}	4	Homing Approach Speed 12	0 to 20971520	100 reference unit/s	0	Immediately *3	Setup	*1													
Pn850	2	Latch Sequence Number	0 to 8	–	0	Immediately	Setup	*1													
Pn851	2	Continuous Latch Count	0 to 255	–	0	Immediately	Setup	*1													

*1. For details, refer to *Σ-V Series User's Manual MECHATROLINK-II Commands* (Manual No.: SIEP S80000 54).

*3. Change the setting when the reference is stopped (DEN is set to 1), because the change will affect the output during operation.

*5. The set value of Pn842 is valid when the set value of Pn817 is 0. Software version 0023 or higher is required to use Pn842.

(cont'd)

Parameter No.	Size	Name	Setting Range	Units	Factory Setting	When Enabled	Classification	Reference Section										
Pn852	2	Latch Sequence Signal 1 to 4 Setting	0000 to 3333	–	0000	Immediately	Setup	*1										
	<div style="display: flex; justify-content: space-around;"> 4th digit 3rd digit 2nd digit 1st digit </div> <div style="display: flex; justify-content: space-around;"> <input type="checkbox"/> <input type="checkbox"/> <input type="checkbox"/> <input type="checkbox"/> </div> <div style="display: flex; justify-content: space-around;"> n. </div>		<table border="1" style="width: 100%; border-collapse: collapse;"> <tr> <td colspan="2">Latch sequence 1 signal selection.</td> </tr> <tr> <td style="width: 20px; text-align: center;">0</td> <td>Phase C</td> </tr> <tr> <td style="text-align: center;">1</td> <td>EXT1 signal</td> </tr> <tr> <td style="text-align: center;">2</td> <td>Reserved (Do not use.)</td> </tr> <tr> <td style="text-align: center;">3</td> <td>Reserved (Do not use.)</td> </tr> </table>						Latch sequence 1 signal selection.		0	Phase C	1	EXT1 signal	2	Reserved (Do not use.)	3	Reserved (Do not use.)
	Latch sequence 1 signal selection.																	
	0	Phase C																
	1	EXT1 signal																
	2	Reserved (Do not use.)																
	3	Reserved (Do not use.)																
			<table border="1" style="width: 100%; border-collapse: collapse;"> <tr> <td colspan="2">Latch sequence 2 signal selection.</td> </tr> <tr> <td style="width: 20px; text-align: center;">0 to 3</td> <td>Same as latch sequence 1 signal selection.</td> </tr> </table>						Latch sequence 2 signal selection.		0 to 3	Same as latch sequence 1 signal selection.						
	Latch sequence 2 signal selection.																	
	0 to 3	Same as latch sequence 1 signal selection.																
		<table border="1" style="width: 100%; border-collapse: collapse;"> <tr> <td colspan="2">Latch sequence 3 signal selection.</td> </tr> <tr> <td style="width: 20px; text-align: center;">0 to 3</td> <td>Same as latch sequence 1 signal selection.</td> </tr> </table>						Latch sequence 3 signal selection.		0 to 3	Same as latch sequence 1 signal selection.							
Latch sequence 3 signal selection.																		
0 to 3	Same as latch sequence 1 signal selection.																	
		<table border="1" style="width: 100%; border-collapse: collapse;"> <tr> <td colspan="2">Latch sequence 4 signal selection.</td> </tr> <tr> <td style="width: 20px; text-align: center;">0 to 3</td> <td>Same as latch sequence 1 signal selection.</td> </tr> </table>						Latch sequence 4 signal selection.		0 to 3	Same as latch sequence 1 signal selection.							
Latch sequence 4 signal selection.																		
0 to 3	Same as latch sequence 1 signal selection.																	
Pn853	2	Latch Sequence Signal 5 to 8 Setting	0000 to 3333	–	0000	Immediately	Setup	*1										
	<div style="display: flex; justify-content: space-around;"> 4th digit 3rd digit 2nd digit 1st digit </div> <div style="display: flex; justify-content: space-around;"> <input type="checkbox"/> <input type="checkbox"/> <input type="checkbox"/> <input type="checkbox"/> </div> <div style="display: flex; justify-content: space-around;"> n. </div>		<table border="1" style="width: 100%; border-collapse: collapse;"> <tr> <td colspan="2">Latch sequence 5 signal selection.</td> </tr> <tr> <td style="width: 20px; text-align: center;">0</td> <td>Phase C</td> </tr> <tr> <td style="text-align: center;">1</td> <td>EXT1 signal</td> </tr> <tr> <td style="text-align: center;">2</td> <td>Reserved (Do not use.)</td> </tr> <tr> <td style="text-align: center;">3</td> <td>Reserved (Do not use.)</td> </tr> </table>						Latch sequence 5 signal selection.		0	Phase C	1	EXT1 signal	2	Reserved (Do not use.)	3	Reserved (Do not use.)
	Latch sequence 5 signal selection.																	
	0	Phase C																
	1	EXT1 signal																
	2	Reserved (Do not use.)																
	3	Reserved (Do not use.)																
			<table border="1" style="width: 100%; border-collapse: collapse;"> <tr> <td colspan="2">Latch sequence 6 signal selection.</td> </tr> <tr> <td style="width: 20px; text-align: center;">0 to 3</td> <td>Same as latch sequence 5 signal selection.</td> </tr> </table>						Latch sequence 6 signal selection.		0 to 3	Same as latch sequence 5 signal selection.						
	Latch sequence 6 signal selection.																	
	0 to 3	Same as latch sequence 5 signal selection.																
		<table border="1" style="width: 100%; border-collapse: collapse;"> <tr> <td colspan="2">Latch sequence 7 signal selection.</td> </tr> <tr> <td style="width: 20px; text-align: center;">0 to 3</td> <td>Same as latch sequence 5 signal selection.</td> </tr> </table>						Latch sequence 7 signal selection.		0 to 3	Same as latch sequence 5 signal selection.							
Latch sequence 7 signal selection.																		
0 to 3	Same as latch sequence 5 signal selection.																	
		<table border="1" style="width: 100%; border-collapse: collapse;"> <tr> <td colspan="2">Latch sequence 8 signal selection.</td> </tr> <tr> <td style="width: 20px; text-align: center;">0 to 3</td> <td>Same as latch sequence 5 signal selection.</td> </tr> </table>						Latch sequence 8 signal selection.		0 to 3	Same as latch sequence 5 signal selection.							
Latch sequence 8 signal selection.																		
0 to 3	Same as latch sequence 5 signal selection.																	
Pn880	2	Station Address Monitor (for maintenance, read only)	40 to 5FH	–	0	Immediately	Setup	–										
Pn881	2	Setting Transmission Byte Monitor [byte] (for maintenance, read only)	17, 32	–	0	Immediately	Setup	–										
Pn882	2	Transmission Cycle Setting Monitor [0.25 μs] (for maintenance, read only)	0 to FFFFH	–	0	Immediately	Setup	–										
Pn883	2	Communications Cycle Setting Monitor [x transmission cycle] (for maintenance, read only)	0 to 32	–	0	Immediately	Setup	–										

*1. For details, refer to *Σ-V Series User's Manual MECHATROLINK-II Commands* (Manual No.: S1EP S800000 54).

(cont'd)

Parameter No.	Size	Name	Setting Range	Units	Factory Setting	When Enabled	Classification	Reference Section												
Pn884	2	Communications Control 2	0000 to 0001	–	0000	Immediately	Setup	–												
	<div style="display: flex; justify-content: space-around; align-items: flex-start;"> <div style="text-align: center;"> 4th digit n. <input type="checkbox"/> </div> <div style="text-align: center;"> 3rd digit <input type="checkbox"/> </div> <div style="text-align: center;"> 2nd digit <input type="checkbox"/> </div> <div style="text-align: center;"> 1st digit <input type="checkbox"/> </div> </div>		<table border="1" style="width: 100%; border-collapse: collapse;"> <tr style="background-color: #cccccc;"> <td colspan="2" style="text-align: center;">Holding Brake Signal Status at MECHATROLINK Communications Error</td> </tr> <tr> <td style="text-align: center; width: 50px;">0</td> <td>Maintains the status set by the BRK_ON or BRK_OFF command when a MECHATROLINK communications error occurs.</td> </tr> <tr> <td style="text-align: center;">1</td> <td>Applies the holding brake when a MECHATROLINK communications error occurs.</td> </tr> <tr style="background-color: #cccccc;"> <td colspan="2" style="text-align: center;">Reserved (Do not change.)</td> </tr> <tr style="background-color: #cccccc;"> <td colspan="2" style="text-align: center;">Reserved (Do not change.)</td> </tr> <tr style="background-color: #cccccc;"> <td colspan="2" style="text-align: center;">Reserved (Do not change.)</td> </tr> </table>						Holding Brake Signal Status at MECHATROLINK Communications Error		0	Maintains the status set by the BRK_ON or BRK_OFF command when a MECHATROLINK communications error occurs.	1	Applies the holding brake when a MECHATROLINK communications error occurs.	Reserved (Do not change.)		Reserved (Do not change.)		Reserved (Do not change.)	
	Holding Brake Signal Status at MECHATROLINK Communications Error																			
	0	Maintains the status set by the BRK_ON or BRK_OFF command when a MECHATROLINK communications error occurs.																		
	1	Applies the holding brake when a MECHATROLINK communications error occurs.																		
Reserved (Do not change.)																				
Reserved (Do not change.)																				
Reserved (Do not change.)																				
Pn88A	2	MECHATROLINK Receive Error Counter Monitor (for maintenance, read only)	0 to 65535	–	0	Immediately	Setup	–												
Pn890 to Pn89E	4	Command Data Monitor at Alarm/Warning Occurs (for maintenance, read only)	0 to FFFFFFFFH	–	0	Immediately	Setup	*1												
Pn8A0 to Pn8AE	4	Response Data Monitor at Alarm/Warning Occurs (for maintenance, read only)	0 to FFFFFFFFH	–	0	Immediately	Setup	*1												
Pn900	2	Parameter Bank Number	0 to 16	–	0	After restart	Setup	*1												
Pn901	2	Parameter Bank Member Number	0 to 15	–	0	After restart	Setup	*1												
Pn902 to Pn910	2	Parameter Bank Member Definition	0000H to 08FFH	–	0	After restart	Setup	*1												
Pn920 to Pn95F	2	Parameter Bank Data (non-volatile memory save disabled)	0000H to FFFFH	–	0	Immediately	Setup	*1												

*1. For details, refer to *Σ-V Series User's Manual MECHATROLINK-II Commands* (Manual No.: SIEP S80000 54).

9.2 List of Monitor Displays

The following list shows the available monitor displays.

Parameter No.	Description	Unit
Un000	Motor rotating speed	min ⁻¹
Un001	Speed reference	min ⁻¹
Un002	Internal torque reference (in percentage to the rated torque)	%
Un003	Rotational angle 1 (encoder pulses from the phase-C origin: decimal display)	encoder pulse*
Un004	Rotational angle 2 (from polarity origin (electric angle))	deg
Un005	Input signal monitor	–
Un006	Output signal monitor	–
Un007	Input reference pulse speed (valid only in position control)	min ⁻¹
Un008	Position error amount (valid only in position control)	reference unit
Un009	Accumulated load ratio (in percentage to the rated torque: effective torque in cycle of 10 seconds)	%
Un00C	Input reference pulse counter	reference unit
Un00D	Feedback pulse counter	encoder pulse*
Un012	Total operation time	100 ms
Un013	Feedback pulse counter	reference unit
Un014	Effective gain monitor (gain settings 1 = 1, gain settings 2 = 2)	–
Un020	Motor rated speed	min ⁻¹
Un021	Motor maximum speed	min ⁻¹
Un030	The current backlash compensation value	0.1 reference unit
Un031	Backlash compensation setting limit value	0.1 reference unit

* For details, refer to 4.4.3 *Electronic Gear*.

9.3 Parameter Recording Table

Use the following table for recording parameters.

Note: Pn10B, Pn170, and Pn408 have two kinds of digits: the digit which does not need the restart after changing the settings and the digit which needs the restart. The underlined digits of the factory setting in the following table show the digit which needs the restart.

Parameter	Factory Setting						Name	When Enabled
Pn000	0000						Basic Function Select Switch 0	After restart
Pn001	0102						Application Function Select Switch 1	After restart
Pn002	0000						Application Function Select Switch 2	After restart
Pn006	0002						Application Function Select Switch 6	Immediately
Pn007	0000						Application Function Select Switch 7	Immediately
Pn008	4000						Application Function Select Switch 8	After restart
Pn009	0010						Application Function Select Switch 9	After restart
Pn00B	0000						Application Function Select Switch B	After restart
Pn00C	0000						Application Function Select Switch C	After restart
Pn00D	0000						Application Function Select Switch D	After restart
Pn100	400						Speed Loop Gain	Immediately
Pn101	2000						Speed Loop Integral Time Constant	Immediately
Pn102	400						Position Loop Gain	Immediately
Pn103	100						Moment of Inertia Ratio	Immediately
Pn104	400						2nd Speed Loop Gain	Immediately
Pn105	2000						2nd Speed Loop Integral Time Constant	Immediately
Pn106	400						2nd Position Loop Gain	Immediately
Pn109	0						Feedforward Gain	Immediately
Pn10A	0						Feedforward Filter Time Constant	Immediately
Pn10B	<u>0000</u>						Application Function for Gain Select Switch	—
Pn10C	200						Mode Switch (torque reference)	Immediately
Pn10D	0						Mode Switch (speed reference)	Immediately
Pn10E	0						Mode Switch (acceleration)	Immediately
Pn10F	0						Mode Switch (position error)	Immediately
Pn11F	0						Position Integral Time Constant	Immediately
Pn121	100						Friction Compensation Gain	Immediately
Pn122	100						2nd Gain for Friction Compensation	Immediately
Pn123	0						Friction Compensation Coefficient	Immediately
Pn124	0						Friction Compensation Frequency Correction	Immediately
Pn125	100						Friction Compensation Gain Correction	Immediately
Pn131	0						Gain Switching Time 1	Immediately
Pn132	0						Gain Switching Time 2	Immediately
Pn135	0						Gain Switching Waiting Time 1	Immediately
Pn136	0						Gain Switching Waiting Time 2	Immediately
Pn139	0000						Automatic Gain Changeover Related Switch 1	Immediately
Pn13D	2000						Current Gain Level	Immediately

(cont'd)

Parameter	Factory Setting					Name	When Enabled
Pn140	0100					Model Following Control Related Switch	Immediately
Pn141	500					Model Following Control Gain	Immediately
Pn142	1000					Model Following Control Gain Compensation	Immediately
Pn143	1000					Model Following Control Bias (Forward Direction)	Immediately
Pn144	1000					Model Following Control Bias (Reverse Direction)	Immediately
Pn145	500					Vibration Suppression 1 Frequency A	Immediately
Pn146	700					Vibration Suppression 1 Frequency B	Immediately
Pn147	1000					Model Following Control Speed Feedforward Compensation	Immediately
Pn148	500					2nd Model Following Control Gain	Immediately
Pn149	1000					2nd Model Following Control Gain Compensation	Immediately
Pn14A	800					Vibration Suppression 2 Frequency	Immediately
Pn14B	100					Vibration Suppression 2 Compensation	Immediately
Pn14F	0011					Control Related Switch	After restart
Pn160	0010					Anti-Resonance Control Related Switch	Immediately
Pn161	1000					Anti-Resonance Frequency	Immediately
Pn162	100					Anti-Resonance Gain Compensation	Immediately
Pn163	0					Anti-Resonance Damping Gain	Immediately
Pn164	0					Anti-Resonance Filter Time Constant 1 Compensation	Immediately
Pn165	0					Anti-Resonance Filter Time Constant 2 Compensation	Immediately
Pn170	1401					Tuning-less Function Related Switch	–
Pn205	65535					Multiturn Limit Setting	After restart
Pn207	0010					Position Control Function Switch	After restart
Pn20A	32768					Reserved	–
Pn20E	4					Electronic Gear Ratio (Numerator)	After restart
Pn210	1					Electronic Gear Ratio (Denominator)	After restart
Pn22A	0000					Reserved	–
Pn230	0000					Position Control Expanded Function Switch	After reset
Pn231	0					Backlash Compensation Value	Immediately
Pn233	0					Backlash Compensation Time Constant	Immediately
Pn281	20					Reserved	–
Pn304	500					JOG Speed	Immediately
Pn305	0					Soft Start Acceleration Time	Immediately
Pn306	0					Soft Start Deceleration Time	Immediately
Pn310	0000					Vibration Detection Switch	Immediately
Pn311	100					Vibration Detection Sensibility	Immediately
Pn312	50					Vibration Detection Level	Immediately

(cont'd)

Parameter	Factory Setting					Name	When Enabled
Pn324	300					Moment of Inertia Calculating Start Level	Immediately
Pn401	100					Torque Reference Filter Time Constant	Immediately
Pn402	800					Forward Torque Limit	Immediately
Pn403	800					Reverse Torque Limit	Immediately
Pn404	100					Forward External Torque Limit	Immediately
Pn405	100					Reverse External Torque Limit	Immediately
Pn406	800					Emergency Stop Torque	Immediately
Pn407	10000					Speed Limit during Torque Control	Immediately
Pn408	0000					Torque Related Function Switch	–
Pn409	5000					1st Notch Filter Frequency	Immediately
Pn40A	70					1st Notch Filter Q Value	Immediately
Pn40B	0					1st Notch Filter Depth	Immediately
Pn40C	5000					2nd Notch Filter Frequency	Immediately
Pn40D	70					2nd Notch Filter Q Value	Immediately
Pn40E	0					2nd Notch Filter Depth	Immediately
Pn40F	5000					2nd Step 2nd Torque Reference Filter Frequency	Immediately
Pn410	50					2nd Step 2nd Torque Reference Filter Q Value	Immediately
Pn412	100					1st Step 2nd Torque Reference Filter Time Constant	Immediately
Pn424	50					Reserved	–
Pn425	100					Reserved	–
Pn456	15					Sweep Torque Reference Amplitude	Immediately
Pn460	0101					Notch Filter Adjustment Switch	Immediately
Pn501	10					Zero Clamp Level	Immediately
Pn502	20					Rotation Detection Level	Immediately
Pn503	10					Speed Coincidence Signal Output Width	Immediately
Pn506	0					Brake Reference - Servo OFF Delay Time	Immediately
Pn507	100					Brake Reference Output Speed Level	Immediately
Pn508	50					Waiting Time for Brake Signal When Motor Running	Immediately
Pn509	20					Reserved	–
Pn50A	1881					Input Signal Selection 1	After restart
Pn50B	8882					Input Signal Selection 2	After restart
Pn50E	0000					Output Signal Selection 1	After restart
Pn50F	0100					Output Signal Selection 2	After restart
Pn510	0000					Output Signal Selection 3	After restart
Pn511	8880					Input Signal Selection 5	After restart
Pn512	0000					Output Signal Inverse Setting	After restart
Pn517	0000					Reserved	–
Pn51B	1000					Reserved	–
Pn51E	100					Excessive Position Error Warning Level	Immediately

(cont'd)

Parameter	Factory Setting					Name	When Enabled
Pn520	5242880					Excessive Position Error Alarm Level	Immediately
Pn522	7					Positioning Completed Width	Immediately
Pn524	1073741824					NEAR Signal Width	Immediately
Pn526	5242880					Excessive Position Error Alarm Level at Servo ON	Immediately
Pn528	100					Excessive Position Error Warning Level at Servo ON	Immediately
Pn529	10000					Speed Limit Level at Servo ON	Immediately
Pn52A	20					Reserved	–
Pn52B	20					Overload Warning Level	Immediately
Pn52C	100					Derating of Base Current at Detecting Overload of Motor	After restart
Pn52D	50					Reserved	–
Pn52F	0FFF					Reserved	–
Pn530	0000					Program JOG Operation Related Switch	Immediately
Pn531	32768					Program JOG Movement Distance	Immediately
Pn533	500					Program JOG Movement Speed	Immediately
Pn534	100					Program JOG Acceleration/Deceleration Time	Immediately
Pn535	100					Program JOG Waiting Time	Immediately
Pn536	1					Number of Times of Program JOG Movement	Immediately
Pn550	0					Analog Monitor 1 Offset Voltage	Immediately
Pn551	0					Analog Monitor 2 Offset Voltage	Immediately
Pn552	100					Analog Monitor Magnification (×1)	Immediately
Pn553	100					Analog Monitor Magnification (×2)	Immediately
Pn560	400					Remained Vibration Detection Width	Immediately
Pn561	100					Overshoot Detection Level	Immediately
Pn600	0					Reserved	–
Pn601	0					Reserved	–
Pn800	0040					Communications Control	Immediately
Pn801	0003					Application Function Select 6 (Software LS)	Immediately
Pn803	10					Origin Range	Immediately
Pn804	1073741823					Forward Software Limit	Immediately
Pn806	-1073741823					Reverse Software Limit	Immediately
Pn808	0					Absolute Encoder Origin Offset	Immediately *1
Pn80A	100					1st Linear Acceleration Constant	Immediately *2
Pn80B	100					2nd Linear Acceleration Constant	Immediately *2
Pn80C	0					Acceleration Constant Switching Speed	Immediately *2

*1. Enabled after the SENS_ON command is input.

*2. Change the setting when the reference is stopped (DEN is set to 1), because the change will affect the output during operation.

(cont'd)

Parameter	Factory Setting					Name	When Enabled
Pn80D	100					1st Linear Deceleration Constant	Immediately *2
Pn80E	100					2nd Linear Deceleration Constant	Immediately *2
Pn80F	0					Deceleration Constant Switching Speed	Immediately *2
Pn810	0					Exponential Function Acceleration/Deceleration Bias	Immediately *2
Pn811	0					Exponential Function Acceleration/Deceleration Time Constant	Immediately *2
Pn812	0					Movement Average Time	Immediately *2
Pn814	100					Final Travel Distance for External Positioning	Immediately *2
Pn816	0000					Homing Mode Setting	Immediately *2
Pn817	50					Homing Approach Speed 1	Immediately *2
Pn818	5					Homing Approach Speed 2	Immediately *2
Pn819	100					Final Travel Distance for Homing	Immediately *2
Pn81E	0000					Input Signal Monitor Selection	Immediately
Pn81F	0000					Command Data Allocation	After restart
Pn820	0					Forward Latching Allowable Area	Immediately
Pn822	0					Reverse Latching Allowable Area	Immediately
Pn824	0000					Option Monitor 1 Selection	Immediately
Pn825	0000					Option Monitor 2 Selection	Immediately
Pn827	100					Linear Deceleration Constant 1 for Stopping	Immediately *2
Pn829	0					SVOFF Waiting Time (SVOFF at deceleration to stop)	Immediately
Pn82A	1813					Option Field Allocation 1	After restart
Pn82B	1D1C					Option Field Allocation 2	After restart
Pn82C	1F1E					Option Field Allocation 3	After restart
Pn82D	0000					Option Field Allocation 4	After restart
Pn82E	0000					Option Field Allocation 5	After restart
Pn833	0000					Motion Setting	After restart
Pn834	100					1st Linear Acceleration Constant 2	Immediately *2
Pn836	100					2nd Linear Acceleration Constant 2	Immediately *2
Pn838	0					Acceleration Constant Switching Speed 2	Immediately *2
Pn83A	100					1st Linear Deceleration Constant 2	Immediately *2
Pn83C	100					2nd Linear Deceleration Constant 2	Immediately *2

*2. Change the setting when the reference is stopped (DEN is set to 1), because the change will affect the output during operation.

(cont'd)

Parameter	Factory Setting						Name	When Enabled
Pn83E	0						Deceleration Constant Switching Speed 2	Immediately *2
Pn840	100						Linear Deceleration Constant 2 for Stopping	Immediately *2
Pn842	0						Homing Approach Speed 12	Immediately *2
Pn850	0						Latch Sequence Number	Immediately
Pn851	0						Continuous Latch Count	Immediately
Pn852	0000						Latch Sequence Signal 1 to 4 Setting	Immediately
Pn853	0000						Latch Sequence Signal 5 to 8 Setting	Immediately
Pn880	0						Station Address Monitor (for maintenance, read only)	Immediately
Pn881	0						Setting Transmission Byte Monitor [byte] (for maintenance, read only)	Immediately
Pn882	0						Transmission Cycle Setting Monitor [0.25 μ s] (for maintenance, read only)	Immediately
Pn883	0						Communications Cycle Setting Monitor [x transmission cycle] (for maintenance, read only)	Immediately
Pn884	0000						Communications Control 2	Immediately
Pn88A	0						MECHATROLINK Receive Error Counter Monitor (for maintenance, read only)	Immediately
Pn890 to Pn89E	0						Command Data Monitor at Alarm/Warning Occurs (for maintenance, read only)	Immediately
Pn8A0 to Pn8AE	0						Response Data Monitor at Alarm/Warning Occurs (for maintenance, read only)	Immediately
Pn900	0						Parameter Bank Number	After restart
Pn901	0						Parameter Bank Member Number	After restart
Pn902 to Pn910	0						Parameter Bank Member Definition	After restart
Pn920 to Pn95F	0						Parameter Bank Data (nonvolatile memory save disabled)	Immediately

*2. Change the setting when the reference is stopped (DEN is set to 1), because the change will affect the output during operation.

Index

Symbols

/BK	4-12
/CLT	4-27
/COIN	4-43
/N-CL	4-26
/NEAR	4-44
/P-CL	4-26
/S-RDY	4-41
/TGON	4-41
/V-CMP	4-42
/VLT	4-45
/WARN	4-40

A

absolute data request (SENS_ON)	4-29
absolute encoder battery alarm (A.830)	4-30
absolute encoder origin offset	4-39
absolute encoders	4-28
connection	4-28
set up (initializing)	4-32
additional adjustment function	5-71
advanced autotuning (Fn201)	5-18
anti-resonance control adjustment function	5-31
feedforward	5-32
friction compensation	5-32
notch filter	5-31
vibration suppression	5-31
advanced autotuning by reference (Fn202)	5-34
anti-resonance control adjustment function	5-40
feedforward	5-41
friction compensation	5-41
notch filter	5-40
vibration suppression	5-41
alarm history display (Fn000)	6-3
alarm reset	8-2
alarm reset method	4-40
ALM	4-40
ambient/storage humidity	1-4
anti-resonance control adjustment function (Fn204)	5-54
automatic gain switching	5-72
automatic offset-signal adjustment of the motor current detection signal (Fn00E)	6-24
automatically setting the notch filter	5-12

B

backlash compensation function	5-78
battery	
battery case	4-28
battery replacement	4-30
baud rate	1-6
BB	iii
brake signals	4-12

C

CCW	4-5
CE	xiv
changing detection timing of overload (low load) alarm (A.720)	4-17
changing detection timing of overload warning (A.910)	4-16
checking output torque limiting during operation	4-27

clearing alarm history (Fn006)	6-19
CN1	3-9
CN2	3-24
CN3	1-2
CN6A	1-2
CN6B	1-2
CN7	1-2
coast to a stop	4-7
communication protocol	1-6
compatible adjustment function	5-84
connecting the measurement instrument	5-5
connection to host controller (interface)	
sequence input circuit	3-21
sequence output circuit	3-22
current control mode selection	5-77
current gain level setting	5-77
CW	4-5

D

decelerate to stop	4-7
delay time in brake operation	4-10
DIP switch	1-2
setting	4-3
display of SERVOPACK and servomotor ID (Fn01E)	6-35

E

EasyFFT (Fn206)	6-41
electronic gear	4-20
electronic gear ratio	4-21
encoder signal (CN2) names and functions	3-24
european directives	xiv
examples of encoder connection	3-24
external torque limit	4-26

F

feedforward	5-84
feedforward compensation	5-84
FG	3-9, 3-10
forward external torque limit	4-26
friction compensation	5-75

G

gain adjustment of analog monitor output (Fn00D)	6-22
Gr.1 alarm	4-15
Gr.2 alarm	4-15
grounding	3-27
G-SEL of OPTION field	5-72

H

harmonized standards	xiv, 1-4
holding brakes	4-10

I

initializing parameter settings (Fn005)	6-16
input signal (CN1)	
allocations	3-11
monitoring	7-6
names and functions	3-9
internal block diagrams	1-7
internal torque limit	4-25

J

JOG operation (Fn002)	6-4
-----------------------	-----

L

LED (ALM)	1-2
-----------	-----

LED (COM)	1-2
LED (RDY)	1-2
limit switches	4-6
limiting torque	4-25
list of alarms	8-2
list of monitor displays	7-2
list of warnings	8-15

M

main circuit terminals	3-2
main circuit wires	3-3
main circuit wiring examples	3-4
manual gain switching	5-72
manual offset-signal adjustment of the motor current detection signal (Fn00F)	6-26
MECHATROLINK-II communications connector	1-2
molded-case circuit breaker	3-5
monitor displays (Un□□□□)	7-2, 9-30
monitor factor	5-7
multiturn limit disagreement alarm (A.CC0)	4-36
multiturn limit setting	4-35

N

noise filter	3-27
N-OT	4-6
notch filter	5-89

O

offset adjustment of analog monitor output (Fn00C)	6-20
one-parameter tuning (Fn203)	5-43
anti-resonance control adjustment function	5-50
feedforward	5-51
friction compensation	5-50
notch filter	5-50
one-parameter tuning example	5-52
online vibration monitor (Fn207)	6-45
origin search (Fn003)	6-6
output signal (CN1)	
allocations	3-17
monitoring	7-7
names and functions	3-9
overtravel (OT)	4-6
overtravel warning function	4-8

P

parameter	
classification	2-5
parameters for numeric settings	iv, 2-5
parameters for selecting functions	iv, 2-5
tuning parameters	2-5
parameter recording table	9-31
parameters	9-3
position integral	5-89
positioning completed signal	4-43
positioning near signal	4-44
P-OT	4-6
power supply capacities and power losses	3-5
precautions for wiring	3-7
precautions on connecting noise filter	3-28
program JOG operation (Fn004)	6-9
protection class/pollution degree	1-4

R

reference unit	4-20
reverse external torque limit	4-26
rotation detection output signal	4-41

S

safety precautions on adjustment of servo gains	5-8
servo alarm output signal	4-40
servo gains	5-3
servo ready output signal	4-41
servomotor model display (Fn011)	6-30
servomotor rotation direction	4-5
SERVOPACK	
basic specifications	1-4
inspection and maintenance	1-10
MECHATROLINK-II function specifications	1-6
model designation	1-9
part names	1-2
precautions when using more than one SERVOPACK	3-6
ratings	1-3
setting motor overload detection level	4-16
signal allocations	3-11
soft start time setting	1-4
software limit settings	4-9
software reset (Fn030)	6-36
software version display (Fn012)	6-31
speed coincidence signal	4-42
speed control range	1-4
speed detection method selection	5-77
speed regulation	1-4
station address	1-6
stopping method for servomotor after SV_OFF command is received	4-15
stopping method for servomotor when an alarm occurs	8-2
storage temperature	1-4
surrounding air temperature	1-4
SW1	1-2
SW2	1-2, 4-3
switching condition A	5-72
switching gain settings	5-71

T

terminator	3-23
test without motor function	4-22
torque control tolerance	1-4
torque reference filter	5-87
transmission cycle	1-6
trial operation	
inspection and checking before trial operation	4-18
trial operation via MECHATROLINK-II	4-19
troubleshooting	
alarms	8-5
warnings	8-16
troubleshooting malfunction based on operation and conditions of the servomotor	8-20
tuning parameters	2-5
tuning-less function	5-11
tuning-less level settings (Fn200)	5-12

U

UL	xiv
using the mode switch (P/PI switching)	5-85
utility functions (Fn□□□□)	6-2, 9-2

V

vibration detection level initialization (Fn01B)	6-32
vibration suppression function (Fn205)	5-64
vibration/shock resistance	1-4
viewing monitor displays	7-3

W

warning output signal	4-40
wiring examples	3-4
wiring for noise control	3-26
wiring MECHATROLINK-II communications	3-23
write prohibited setting (Fn010)	6-28

Z

zero clamp mode	4-7
-----------------	-----

Revision History

The revision dates and numbers of the revised manuals are given on the bottom of the back cover.

MANUAL NO. SIEP S800000 82A <0>-1
 Published in Japan April 2012

┌─── WEB revision number
 └─── Revision number
 └─── Date of publication

Date of Publication	Rev. No.	WEB Rev. No.	Section	Revised Content
December 2016	<1>	1	3.1.7	Addition: Precaution when wiring a magnetic contactor on the DC side of the main circuit power supply
			Back cover	Revision: Address
June 2015	<0>	0	–	Same revisions made as Web version SIEP S800000 82A<0>-1.
			3.6.2, 4.7.1	Revision: Information on battery for encoder
			4.3.3 (3)	Revision: Factory settings of parameters
			4.5.1 (2)	Addition: Information on rated motor speed and maximum motor speed
			8.1.1, 8.1.2	Addition: Information on A.bE0 and A.F50
			9.1.2	Revision: Information on reserved parameters
			9.1.2, 9.3	Addition: Information on Pn52D and Pn884
			Front cover	Revision: Format
			Back cover	Revision: Address, format
April 2012	<0>	1	3.1.4, 3.1.5	Revision: Values of power supply capacity and input current capacity
			8.1.2	Revision: Detection conditions calculation formula
			Back cover	Revision: Address
November 2011	–	–	–	First edition

AC Servo Drives

DC Power Input Σ -V Series

USER'S MANUAL

Design and Maintenance

Rotational Motor

MECHATROLINK-II Communications Reference

IRUMA BUSINESS CENTER (SOLUTION CENTER)

480, Kamifujisawa, Iruma, Saitama, 358-8555, Japan
Phone 81-4-2962-5151 Fax 81-4-2962-6138
<http://www.yaskawa.co.jp>

YASKAWA AMERICA, INC.

2121, Norman Drive South, Waukegan, IL 60085, U.S.A.
Phone 1-800-YASKAWA (927-5292) or 1-847-887-7000 Fax 1-847-887-7310
<http://www.yaskawa.com>

YASKAWA ELÉTRICO DO BRASIL LTDA.

777, Avenida Piraporinha, Diadema, São Paulo, 09950-000, Brasil
Phone 55-11-3585-1100 Fax 55-11-3585-1187
<http://www.yaskawa.com.br>

YASKAWA EUROPE GmbH

185, Hauptstraße, Eschborn, 65760, Germany
Phone 49-6196-569-300 Fax 49-6196-569-398
<http://www.yaskawa.eu.com>

YASKAWA ELECTRIC KOREA CORPORATION

9F, Kyobo Securities Bldg. 26-4, Yeouido-dong, Yeongdeungpo-gu, Seoul, 150-737, Korea
Phone 82-2-784-7844 Fax 82-2-784-8495
<http://www.yaskawa.co.kr>

YASKAWA ELECTRIC (SINGAPORE) PTE. LTD.

151, Lorong Chuan, #04-02A, New Tech Park, 556741, Singapore
Phone 65-6282-3003 Fax 65-6289-3003
<http://www.yaskawa.com.sg>

YASKAWA ELECTRIC (THAILAND) CO., LTD.

59, 1st-5th Floor, Flourish Building, Soi Ratchadapisek 18, Ratchadapisek Road, Huaykwang, Bangkok, 10310, Thailand
Phone 66-2-017-0099 Fax 66-2-017-0799
<http://www.yaskawa.co.th>

YASKAWA ELECTRIC (CHINA) CO., LTD.

22F, One Corporate Avenue, No.222, Hubin Road, Shanghai, 200021, China
Phone 86-21-5385-2200 Fax 86-21-5385-3299
<http://www.yaskawa.com.cn>

YASKAWA ELECTRIC (CHINA) CO., LTD. BEIJING OFFICE

Room 1011, Tower W3 Oriental Plaza, No.1, East Chang An Ave.,
Dong Cheng District, Beijing, 100738, China
Phone 86-10-8518-4086 Fax 86-10-8518-4082

YASKAWA ELECTRIC TAIWAN CORPORATION

9F, 16, Nanking E. Rd., Sec. 3, Taipei, 104, Taiwan
Phone 886-2-2502-5003 Fax 886-2-2505-1280

YASKAWA

YASKAWA ELECTRIC CORPORATION

In the event that the end user of this product is to be the military and said product is to be employed in any weapons systems or the manufacture thereof, the export will fall under the relevant regulations as stipulated in the Foreign Exchange and Foreign Trade Regulations. Therefore, be sure to follow all procedures and submit all relevant documentation according to any and all rules, regulations and laws that may apply. Specifications are subject to change without notice for ongoing product modifications and improvements.

© 2011-2016 YASKAWA ELECTRIC CORPORATION

MANUAL NO. SIEP S800000 82B <1>-1

Published in Japan December 2016
15-8-11

Original instructions