



The following procedure is a supplement to other documentation supplied with this equipment and will guide the user in properly wiring the P1000 and motor. It will also show the user how to configure the P1000 for a general purpose application.

DANGER!
Improper wiring can and will cause bodily harm as well as damage to the equipment.

When installing the system, be sure to follow good wiring practices and all applicable codes. Ensure that the mounting of components is secure and that the environment, such as extreme dampness, poor ventilation, etc. will not cause system degradation.

Please read this cheat sheet and other documentation provided with the P1000 thoroughly before attempting any installation.

Step 1 P1000 Model Identification and Mounting

To make sure you received the correct model, it is essential to verify the P1000 nameplate with your order and make sure the P1000 has the correct rating so it can be used with your motor. Please check the nameplate information as shown in the example below.

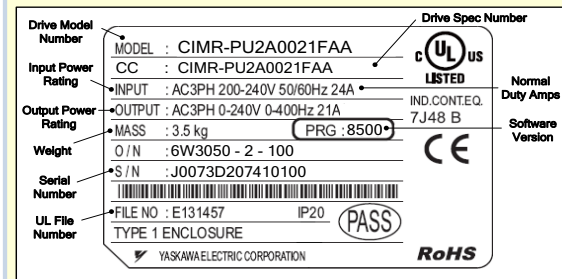

- Check that the available power will meet the *input power* requirements.
- Ensure that the *output power* from the P1000 is compatible with the motor requirements.
- In the case of systems with more than one P1000, follow the above procedure for each P1000 and motor.

Mounting the P1000

The mounting of the P1000 is extremely important regarding environment and accessibility. Depending on your system, there are various models available and the mounting dimensions (footprint) may be different. Because the mounting procedure is fairly extensive, it is beyond the scope of this document; the user is referred to the P1000 Quick Start Guide (Document No. TOEP YAIP1U 01) received with the P1000, Section 2.2, Mechanical Installation. Match the model that you received and follow the procedure described in the manual to ensure a safe and functional installation. In cases where the system has more than one P1000, refer to the proper clearances required for adequate ventilation. Please pay particular attention to:

- The clearances to be maintained around the enclosure for adequate ventilation.
- The environmental specifications such as avoiding excessive dampness, extreme temperatures, chemical exposure, corrosive areas, etc. to avoid damage to the equipment and to maintain safety.

Removing and Attaching the Terminal Cover

Improper removal of the P1000 terminal cover as well as front cover can cause extensive damage to the P1000. To avoid damage to these items, please pay particular attention to the P1000 Quick Start Guide, Document No. TOEP YAIP1U 01, Section 3.5, Removing and Attaching the Terminal Cover.

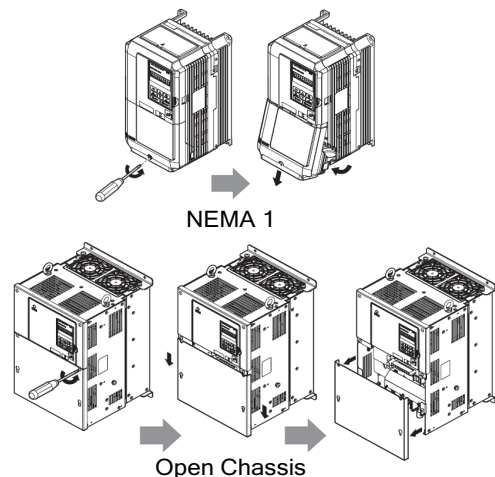

Step 2 Connect Motor and Line Power

Fig. 1 & 2 below show the electrical connections for the input power and motor terminals for various P1000 models. Select the proper diagram for the model you are installing (see Step 1). WITH POWER OFF make the appropriate connections. Make sure to follow good wiring practices and all applicable codes. Ensure that the equipment is grounded properly as shown in fig. 1

DANGER; LETHAL VOLTAGES ARE PRESENT- Before applying power to the P1000, ensure that the terminal cover is fastened and all wiring connections are secure. After the power has been turned OFF, wait at least five minutes until the charge indicator extinguishes completely before touching any wiring, circuit boards or components.

WARNING DO NOT CONNECT ANY OF THE FOLLOWING TERMINALS TO EARTH GROUND

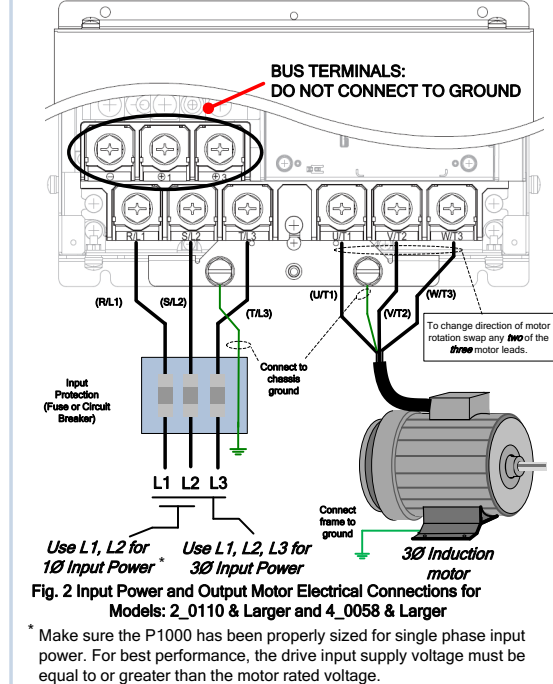
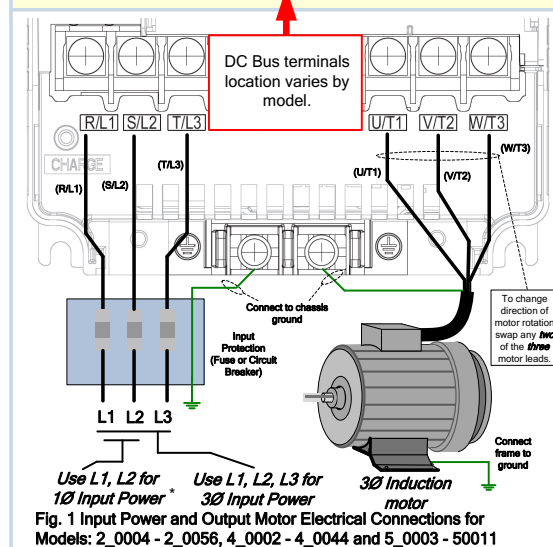
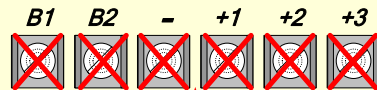

Step 3 Real-time Clock Setup

This step shows how to setup the P1000 real-time clock for first use.

Power up the drive and set the real-time Clock. The real-time Clock setup screen will appear at first power up.

Note: after the real-time clock is set this screen will not show again unless parameter o4-17 is set to "Set".

Real-time Clock Setup Screen

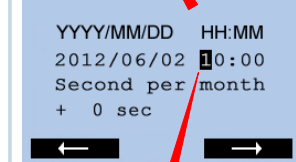
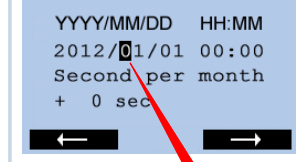
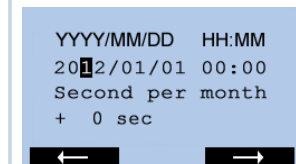

Press **RESET** to select the digit you would like to change and use **UP** / **DOWN** to adjust.

When date and time are set press **ENTER** to save.

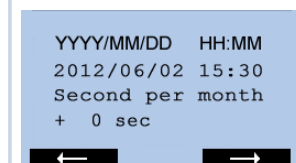

Example: Jun 2nd 2012, 3:30pm

Note: Do NOT adjust sec per month.

IMPORTANT

If no key is pressed within 30 sec. the operator will revert back to the main menu showing a "TIM" alarm (Alarm not set).

To set the real-time clock again disconnect and reconnect the operator.

Step 4 Selecting Start/Stop and Speed Method

This step shows how to setup the sequence and reference method of the P1000. The sequence method determines how the P1000 drive receives its start and stop command and the reference method determines how the speed of the motor is controlled. Make sure all protective covers have been re-attached and power is turned on. **DO NOT RUN THE MOTOR. This section may require you to change one or more P1000 parameters. Please refer to Step 5 for a detailed explanation on how to change parameters.**

SELECT SPEED METHOD b1-01

1. Adjust motor speed / frequency from the Digital Operator

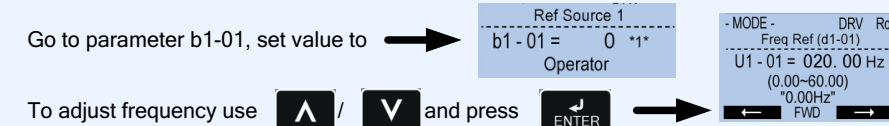

2. Adjust motor speed / frequency from external terminals (0 - 10V / 4 - 20mA Signal)

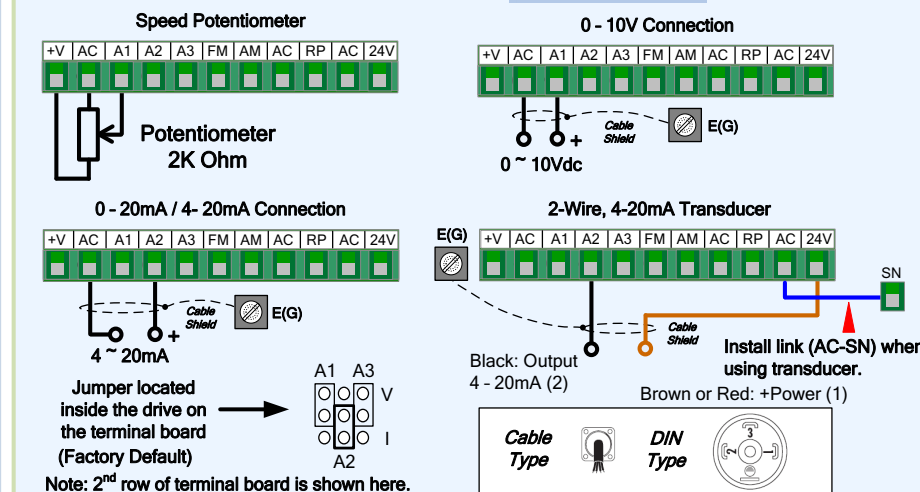
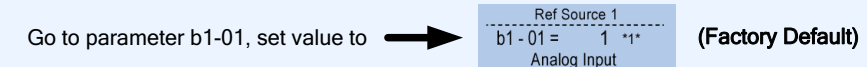

SELECT START / STOP CONTROL METHOD b1-02

1. Start / Stop Control from Digital Operator

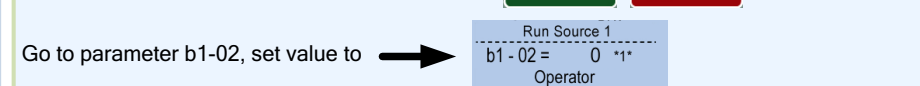

2. Start / Stop Control from external terminals (switch or relay contact)

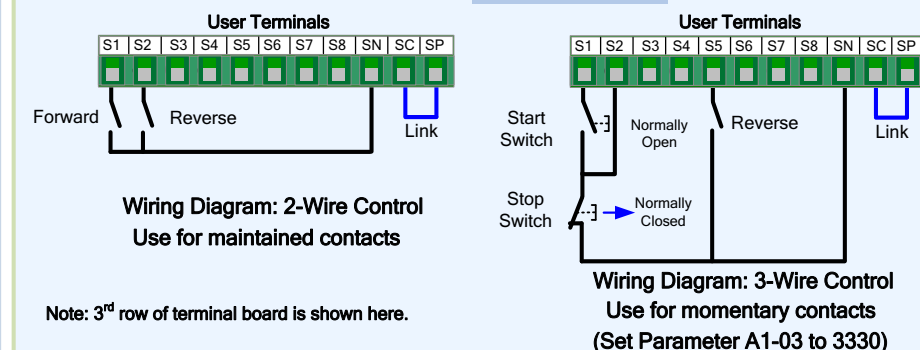
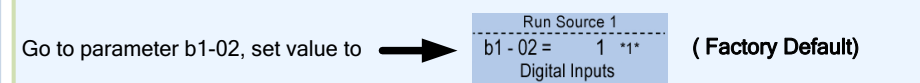

NOTE: It is beyond the scope of this document to program the P1000 drive for network communication control. Please refer to the refer to the P1000 Technical Manual, (Document No. SIEP YAIP1U 01) for this selection.



Step 5 Changing Parameters and Monitoring the P1000

This step shows how to access and modify a P1000 parameter as well as how to monitor P1000 signals such as output frequency and motor current.

Make sure all protective covers have been re-attached and power is turned on. **DO NOT RUN THE MOTOR.**

Access Parameter Menu and Change Parameter Value

Press **V** two times until the digital operator shows the parameter menu.

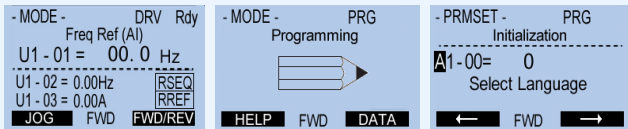

2X **V** → **ENTER** → **RESET** Select Digit

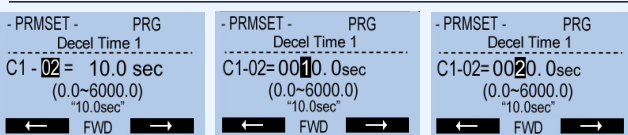

ENTER → **V** → **ENTER**
Switch to Edit Mode Modify Value Save New Value

Hold **ESC** button for 3 sec. to go back to the main menu.

Monitor Motor Frequency and Motor Current

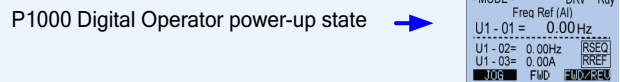

Output Frequency and Motor Current can be monitored simultaneously.

To monitor output frequency and motor current or other signals

individually, press **V** once, then press **ENTER**

Next press **RESET** to select monitor

Use **V** to select monitor signal. Digits Flashing

U1-02 Output Frequency

Please refer to the P1000 Quick Start Manual, (Document No. TOEP YAIP1U 01) on how to access other drive monitors.

Step 6 Application Setup

This step shows how to configure the P1000 for dedicated fan or pump applications.

Make sure all protective covers have been re-attached and power is turned on. **DO NOT RUN THE MOTOR.**

Available P1000 Application Macro's:

- Pump without Automatic Regulation
- Pump with PI Control (Automatic pressure/flow regulation with transducer)
- Fan without Automatic Regulation
- Fan with PI Control (Automatic pressure/flow regulation with transducer)

Select Application

Press **V** two times until the digital operator shows the parameter menu.

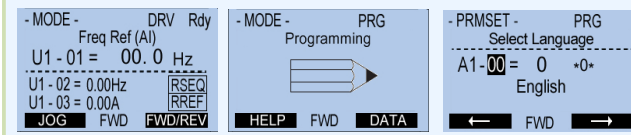

2X **V** → **ENTER** → 2X **RESET** Select Digit

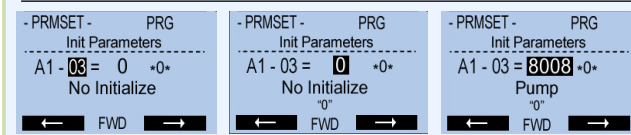

V → **ENTER** → **V**
Inc./Dec. Selection Switch to Edit Mode Select Application

Press **ENTER** to Select

Enter Application Parameters

Hold **ESC** button for 3 sec. to go back to the main menu.

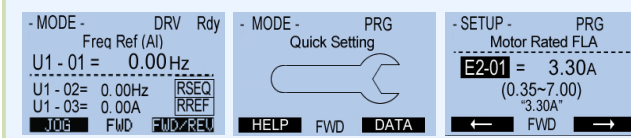

3X **V** → **ENTER** → **V** → **ENTER** Select Parameter

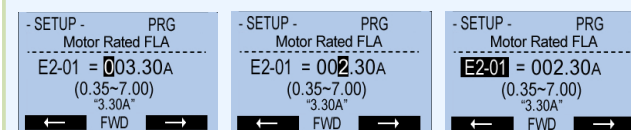

ENTER → **V** → **ENTER**
Switch to Edit Mode Modify Value Save New Value

Go Back to Main Menu

Hold **ESC** button for 3 sec. to go back to the main menu.

Step 7 Check Motor Direction (Motor uncoupled from Load)

In this step the motor is checked for proper direction and operation. This test is to be performed solely from the digital operator. Apply power to the P1000 after all the electrical connections have been made and protective covers have been re-attached. At this point, **DO NOT RUN THE MOTOR**, the Digital Operator should display as shown in **Fig. 3**.

Motor Rotation Test

Fig. 3

Press **LO RE**



Green LED turns on. Green RUN LED turns on.

Next, press and **hold F1** on the Digital Operator.

The motor should now be operating at low speed (6.00 Hz)

running in the correct forward (clockwise) direction.

Next, release **F1** on the Digital Operator.

If motor rotation is not correct, power down the drive, wait five minutes and swap 2 motor leads at the drive output terminals.

DANGER

After the power has been turned OFF, wait at least five minutes until the charge indicator extinguishes completely before touching any wiring, circuit boards or components.

Digital Operator turned off.



Use precaution, and refer to **Fig. 1 or 2**, swap any **two** of the **three** output leads to the motor (U/T1, V/T2 and W/T3). After the wiring change, repeat **Step 7** and recheck motor direction.

Application Parameters / Frequently Asked Questions

Parameter	Description	General	Pump	Pump+PI	Fan	Fan+PI
A1-03	Initialization Mode =	2222	8008	8009	8010	8011
A1-06	Application Preset Selection	✓	✓	✓	✓	✓
E2-01	Motor Rated Current	✓	✓	✓	✓	✓
b1-01	Frequency Reference Selection	✓	✓		✓	
b1-02	Run Command Selection	✓	✓	✓	✓	✓
b1-03	Stopping Method	✓	✓	✓	✓	✓
b1-04	Reverse Operation Selection	✓	✓	✓	✓	✓
b5-12	PI Feedback Loss Detection Selection					✓
b5-19	PID Setpoint Value			✓		✓
b5-38	PID Setpoint User Display			✓		✓
b5-39	PID Setpoint Display Digits			✓		✓
b5-46	PID Unit Selection			✓		✓
b5-90	EZ Sleep Unit			✓		✓
b5-91	EZ Minimum Speed			✓		✓
b5-92	EZ Sleep Level			✓		✓
b5-94	EZ Wake-up Level			✓		✓
C1-01	Acceleration Time 1	✓	✓	✓	✓	✓
C1-02	Deceleration Time 1	✓	✓	✓	✓	✓
d1-01	Frequency Reference 1	✓	✓		✓	
d2-01	Frequency Reference Upper Limit	✓			✓	
d2-02	Frequency Reference Lower Limit	✓			✓	
H3-09	Terminal A2 Signal Level Selection			✓		✓
L2-01	Momentary Power Loss operation Selection	✓	✓			
L5-01	Number of Auto Restart Attempts	✓	✓	✓	✓	✓
L5-04	Fault reset interval Time		✓	✓	✓	✓
L6-01	Torque Detection 1 Selection	✓				
L6-02	Torque Detection 1 Level	✓				
L6-03	Torque Detection 1 Time	✓				
o1-06	User Monitor Selection Mode	✓	✓		✓	✓
o1-07	Second line Monitor Selection	✓	✓	✓	✓	✓
o1-08	Third line Monitor Selection	✓	✓	✓	✓	✓

FREQUENTLY ASKED QUESTIONS

Question: How do I reset the drive back to factory default settings?

Answer: Go to parameter A1-03 and set value **2220** for 2 wire control or **3330** for 3 wire control (Please refer to Step 3 for wiring diagram) or see step 6: Application setup.

Question: How can I change the speed reference or start / stop control source?

Answer: Set parameter b1-01 for speed reference or b1-02 for start/stop selection.

Question: How can I make the motor coast when a stop command is activated?

Answer: Set parameter b1-03 Stopping Method to "1" Coast to Stop

Question: How do I adjust the time it takes the motor to speed up or slow down?

Answer: Adjust the acceleration time parameter C1-01 and deceleration time C1-02.

Question: How do I set the maximum or minimum frequency?

Answer: Set d2-01 = maximum upper frequency and d2-02 = minimum frequency. **Example:** d2-01 set for 90% = 54 Hz maximum frequency (0.9 x 60Hz)

Question: How do I prevent my drive from tripping on an **OV** fault (overvoltage) while my motor is ramping down?

Answer: Increase deceleration time parameter C1-02.

Question: How do I prevent my drive from tripping on an **OL1** fault (overload) while my motor is ramping down?

Answer: Verify motor rated current parameter E2-01 and motor overload parameter settings L1-01 Motor overload selection, L1-02 Motor overload protection time.

Question: I want to run my motor above the nominal motor speed?

Answer: Increase the value of parameter E1-04 Maximum Frequency **WARNING!** Verify that the motor and system allow for this.