



The following procedure is a supplement to other documentation supplied with this equipment and will guide the user in properly wiring the Z1000 and motor. It will also show the user how to configure the Z1000 for a Hand and Auto operation.

**DANGER!** Improper wiring can and will cause bodily harm as well as damage to the equipment.

When installing the system be sure to follow good wiring practices and all applicable codes. Ensure that the mounting of the various components are secure and that the environment, such as extreme dampness, poor ventilation etc. will not cause system degradation.

Please read this procedure and the Z1000 User Manual (TOEP C710616 45) provided with the Z1000 thoroughly before attempting any installation.

## Step 1 Z1000 Model Identification and Mounting

To make sure you received the correct model, it is essential to verify the Z1000 nameplate with your order and make sure the Z1000 has the correct rating so it can be used with your motor. Please check the nameplate information as shown in the example below.

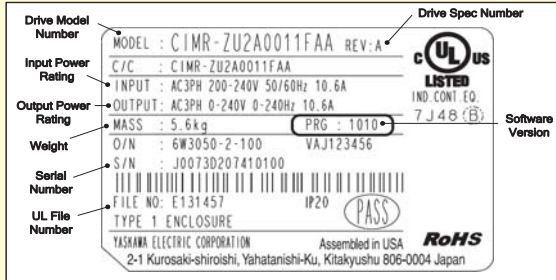

- Check that the available power will meet the *input power* requirements.
- Ensure that the *output power* from the Z1000 is compatible with the motor requirements.
- In the case of systems with more than one Z1000, follow the above procedure for each Z1000 and motor.

### Mounting the Z1000

The mounting of the Z1000 is extremely important regarding environment and accessibility. Depending on your system, there are various models available and the mounting dimensions (footprint) may be different. Because the mounting procedure is fairly extensive, it is beyond the scope of this document; the user is referred to the Z1000 User Manual (Document No. TOEP C710616 45) received with the Z1000, **Section 2.2 Mechanical Installation**. Match the model that you received and follow the procedure described in the manual to ensure a safe and functional installation. In cases where the system has more than one Z1000, refer to the proper clearances required for adequate ventilation. Please pay particular attention to:

- The clearances to be maintained around the enclosure for adequate ventilation.
- The environmental specifications such as avoiding excessive dampness, extreme temperatures, chemical exposure, corrosive areas, etc. to avoid damage to the equipment and to maintain safety.

### Removing and Attaching the Terminal Cover

Improper removal of the Z1000 terminal cover as well as front cover can cause extensive damage to the Z1000. To avoid damage to these items, please pay particular attention to the Z1000 User Manual, Document No. TOEP C710616 45, Section 3.5, **Removing and Attaching the Terminal Cover**.

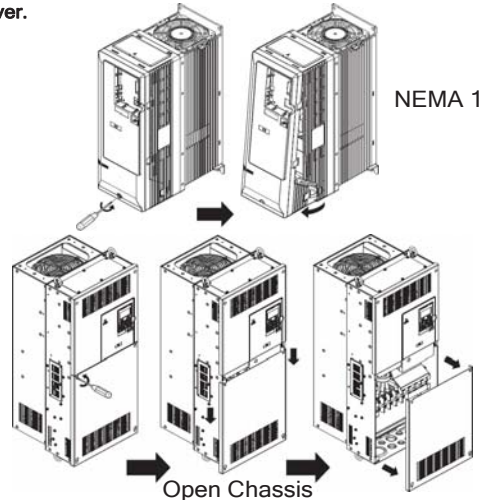

## Step 2 Connect Motor and Line Power

Fig. 1 & 2 below show the electrical connections for the input power and motor terminals for various Z1000 models. Select the proper diagram for the model you are installing (see Step 1). **WITH POWER OFF** make the appropriate connections. Make sure to follow good wiring practices and all applicable codes. Ensure that the equipment is grounded properly as shown in fig. 1

**DANGER; LETHAL VOLTAGES ARE PRESENT-** Before applying power to the Z1000, ensure that the terminal cover is fastened and all wiring connections are secure. After the power has been turned OFF, wait at least five minutes until the charge indicator extinguishes completely before touching any wiring, circuit boards or components.

**WARNING DO NOT CONNECT ANY OF THE FOLLOWING TERMINALS TO EARTH GROUND**

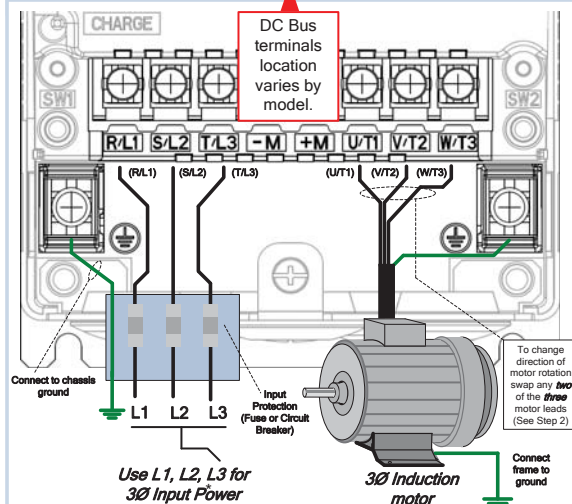
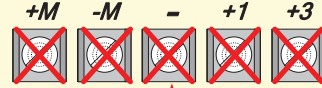

Fig. 1 Input Power and Output Motor Electrical Connections for Models: 2\_0011 - 2\_0273, 4\_0005 - 4\_0302

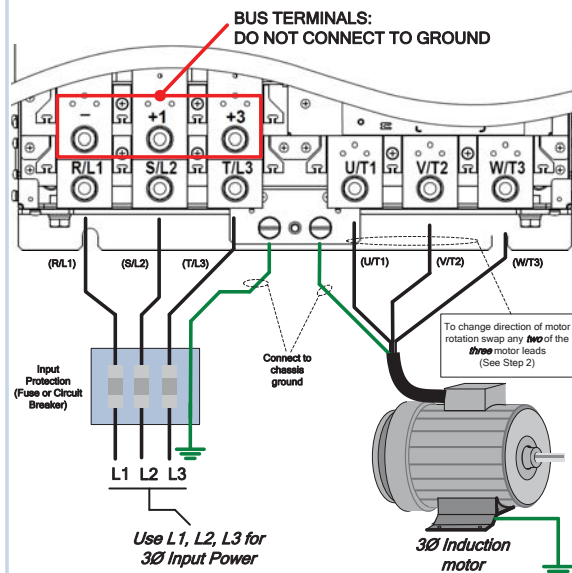

Fig. 2 Input Power and Output Motor Electrical Connections for Models: 2\_0343 & Larger and 4\_0361 & Larger

For best performance, the drive input supply voltage must be at least equal to or greater than the motor rated voltage.

## Step 3 Z1000 Control Wiring

This step shows how to set up the sequence and reference method of the Z1000. The sequence method determines how the Z1000 drive receives its start and stop command and the reference method determines how the speed of the motor is controlled. Make sure all protective covers have been re-attached and power is turned on. **DO NOT RUN THE MOTOR.**

This section may require you to change one or more Z1000 parameters. Please refer to Step 5 for a detailed explanation on how to change parameters.

### SELECT SPEED METHOD

b1-01

#### 1. Adjust motor speed / frequency from the Digital Operator

Go to parameter b1-01, set value to  $b1-01 = 0 \cdot 1^*$  Operator

To adjust frequency press **ENTER** from the operation screen and use **▲** / **▼** to change frequency and press **ENTER**.

#### 2. Adjust motor speed / frequency from external terminals (0 - 10V / 4 - 20mA Signal)

Go to parameter b1-01, set value to  $b1-01 = 1 \cdot 1^*$  (Factory Default) Analog Input

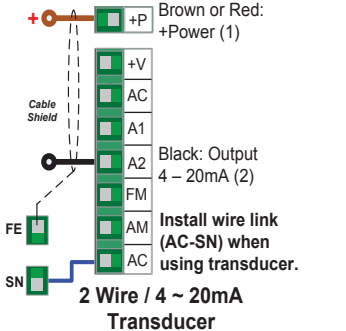
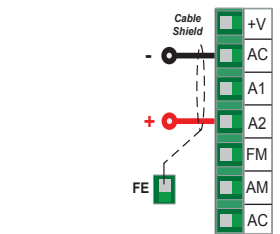
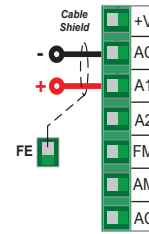
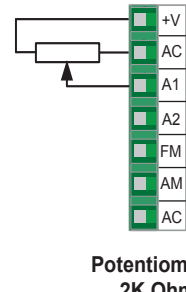

### SELECT START / STOP CONTROL METHOD

b1-02

1. Start / Stop Control from Digital Operator, use **HAND** / **OFF** See step 6 Hand / Auto Mode Operation

2. Start / Stop Control from external terminals (switch or relay contact) Go to parameter b1-02, set value to  $b1-02 = 1 \cdot 1^*$  Digital Inputs

### Wiring Diagram: 2-Wire Control (Factory Default)

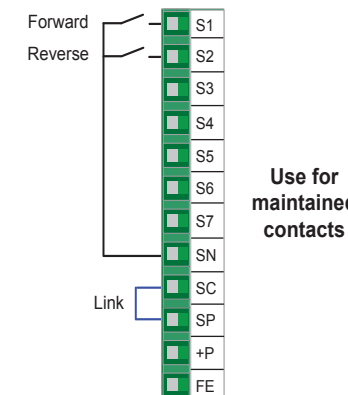

### Wiring Diagram: 3-Wire Control

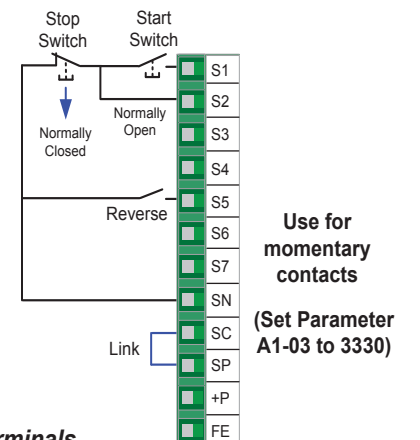

**NOTE:** It is beyond the scope of this document to program the Z1000 drive for network communication control. Please refer to the Z1000 Technical Manual, (Document No. SIEP C710616 45) for this selection.



## Step 4

### Z1000 Quick Setup

This step shows how to set up the most important parameters using the Z1000 Quick Setup function. Apply power to the Z1000 after all the electrical connections have been made and the terminal cover has been re-attached. At this point **DO NOT RUN THE MOTOR**. The digital operator should be reading as shown in **Fig. 3** to the right.

- Press **V** three times until the digital operator shows the Quick Setting menu.
- Press **ENTER** to start the Quick Setup.
- Select Application  
Press **ENTER** and use **▲** **▼** to switch between applications. Press **ENTER** to select.



- Available Applications:**
- 0: General: Basic Drive Operation
  - 1: Fan General: Fan Application without PI Control
  - 2: Fan Application with PI Control
  - 3: Return Fan with PI Control
  - 4: Cooling Tower Fan without PI Control
  - 5: Cooling Tower Fan with PI Control
  - 6: Pump (Secondary) without PI Control
  - 7: Pump with PI Control

After selecting the Application the Z1000 Quick Setup will display the dedicated application parameters to set up your Z1000

Drive for the selected application. Press **ENTER** to access a parameter, and use **▶** **◀** to select the digit and use **▲** **▼** to change the parameter value.

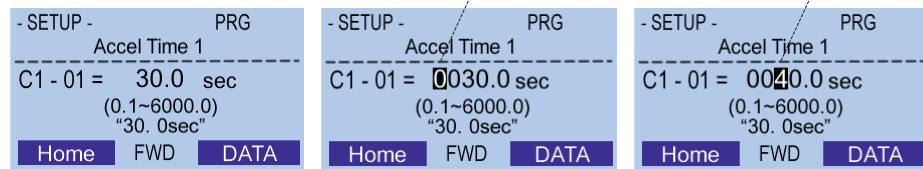

Press **ENTER** to save the value.

Press **▲** to go to the next parameter to continue the Quick Setup programming.

When Quick Setup is completed press **(F1)** "Home" to exit the Quick Setup menu and go to operation.

#### Frequently Used Parameters

Parameter	Default Value	Description	Comments
A1-06	0	Application Selection	See Application list under step 4.
b1-01	1	Reference Source 1 Speed Control Method	0 = Digital Operator (Adjust Motor Speed from keypad) 1 = Terminals (Speed Pot. / 0 - 10V / 4-20mA)
b1-02	1	Run Source 1 / Start/Stop Control Method	1 = Terminals (Start/Stop using external contact / switch) 3 = Communication
b1-03	1	Stop Method Selection	0 = Ramp to stop (Motor ramps down at stop command) 1 = Coast to stop (Motor freewheels at stop command)
b5-01	0	PI Mode Selection	0 = Disabled, 1 = Enabled, 3 = Fref + PI
b5-02	2.00	PI Proportional Gain Setting	Only active when b5-01 is set to value greater than 0
b5-03	0.5 sec.	PI Integral Time Setting	Only active when b5-01 is set to value greater than 0
b5-20	1	PI Setpoint Scaling	0 = Hz, 1 = %, 2 = rpm, 3 = custom (use b5-38, b5-39 and b5-41)
C1-01	30.0 sec.	Acceleration Time	The time it takes to ramp up from 0 to maximum motor speed.
C1-02	30.0 sec.	Deceleration Time	The time it takes to ramp down from maximum motor speed to 0.
d2-01	100.0 %	Frequency Reference Upper Limit	Maximum motor speed allowed (e.g. 100 % = Max rpm)
d2-02	0.0 %	Frequency Reference Lower Limit	Minimum motor speed allowed (e.g. 100 % = Max rpm)
E1-01	*	Input Voltage Setting	Motor nameplate voltage
E2-01	*	Motor Rated Current	Motor nameplate current
H3-09	1	Terminal A2 Signal Level Selection	0 = 0 to 10V, 1 = -10 to 10V, 2 = 4 to 20mA, 3 = 0 to 20mA
H3-10	1	Terminal A2 Function Selection	Predefined signals, see Z1000 User Manual

## Step 5

### Check Motor Rotation and Direction

In this step the motor is checked for proper direction and operation. This test is to be performed solely from the digital operator. Apply power to the Z1000 after all the electrical connections have been made and protective covers have been re-attached. At this point, **DO NOT RUN THE MOTOR**, the Digital Operator should display as shown in **Fig. 3**.

Fig. 3: Digital Operator

#### Motor Rotation Test



Press **HAND** Green LED is blinking. First Digit Flashing

Next, press **▶** to move the cursor one position to the right and **▲** to increase the frequency reference (d1-01) to 10.00 Hz.

Press **ENTER** to save freq. reference. 10.00 Hz

The motor should now be operating at low speed running in the correct forward (clockwise) direction.

Next, press **OFF** on the Digital Operator.

*If motor rotation is not correct, power down the drive, wait five minutes and swap two motor leads at the drive output terminals.*

#### ⚠ DANGER

*After the power has been turned OFF, wait at least five minutes until the charge indicator extinguishes completely before touching any wiring, circuit boards or components.*

Use precaution, and refer to **Fig. 1 or 2**, swap any **two** of the **three** output leads to the motor (U/T1, V/T2 and W/T3). After the wiring change, repeat **Step 5** and recheck motor direction.

Digital Operator turned off.



## Step 6

### Hand / Auto Mode Operation

#### HAND MODE

The Z1000 can be operated in HAND mode when the following actions have been performed:

- All parameters are programmed
- Motor direction has been checked

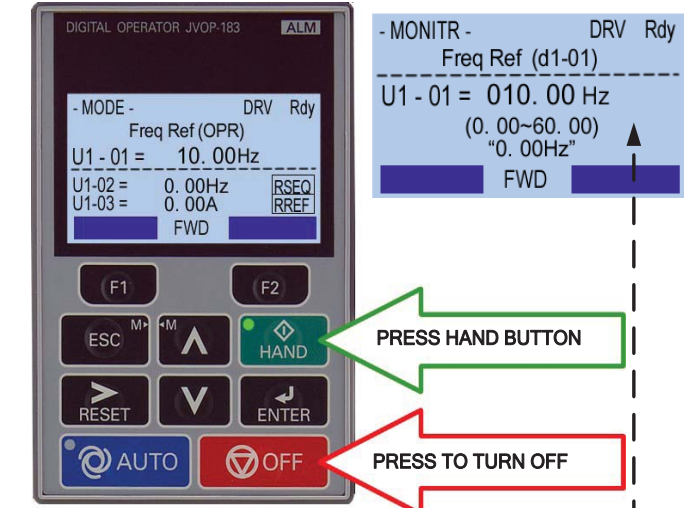

Press **ENTER** to access Hand Speed. Use **▲** **▼** **▶** **◀** to change Hand Speed value. Press **ENTER** to save value.

#### AUTO MODE

The Z1000 can be operated in AUTO mode when the following actions have been performed:

- All parameters are programmed
- Motor direction has been checked
- Auto Mode: Reference source selected in parameter b1-01 (See step 3)
- Auto Mode: Run source selected in parameter b1-02 (See Step 3)

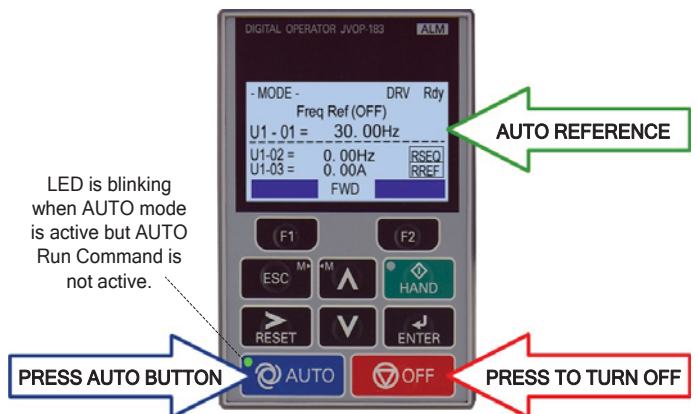

LED is blinking when AUTO mode is active but AUTO Run Command is not active.

Press the **AUTO** button to put the Z1000 into AUTO mode.

In AUTO mode the Z1000 is capable of starting or stopping based on the Run Source Selection setting parameter b1-02. (See Step 3 Select Start/Stop Control Method)

The Speed Command used in AUTO mode is based on the Reference Source Selection setting parameter b1-01. (See Step 3 Select Speed Method)