

YASKAWA

OUTPERFORM

THE ADVANTAGE IN ADVANCED MANUFACTURING

IT'S PERSONAL



Rout. Mill. Grind. Cut. Turn. Print. Bend.

IN A WORLD OF OPEN COMPETITION

BETTER IS THE ONLY OPTION.



In today's competitive market for machining and fabrication equipment, machine builders need extra performance and productivity to stand out from the crowd.

OPEN NETWORKING: A GOLDEN OPPORTUNITY

The popularity of EtherCAT, MECHATROLINK and other open source automation networks has opened the doors to new possibilities in motion control. Manufacturers are now free to choose the industry's best servo systems, drives and robots, regardless of who provides the control software or hardware.

The result is a major improvement in machine performance, price and productivity.

YASKAWA

MASTERS OF ETHERCAT

Look inside the machines of industry leaders, and you'll find plenty of Yaskawa logos. The best machine builders know that Yaskawa motion components deliver the highest speed, precision, throughput and performance in the EtherCAT universe. They also know... through 100+ years of experience... that nobody tops Yaskawa in reliability.

EtherCAT®



STRENGTH AFTER THE SALE: YASKAWA SUPPORT

Machine builders have learned to trust Yaskawa support at every step in the machine development process, from design concept through end-user assistance. We can help from start to finish or at individual steps as needed.

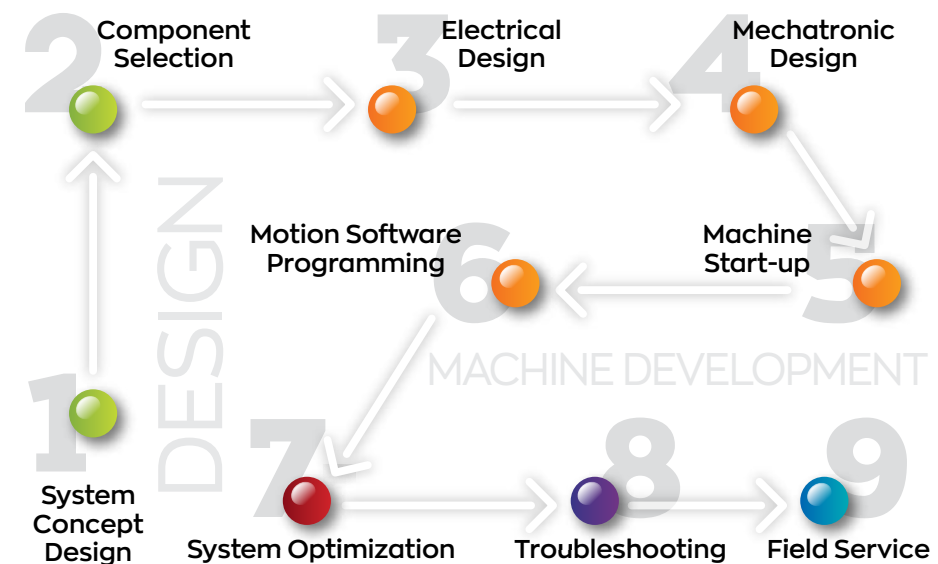

YASKAWA EXPERIENCE MAKES THE CUT

The Yaskawa name is well known in all types of machining, cutting and fabricating applications for metals, wood, plastics and composites.

- VMC/HMC machining centers
- Turning centers and CNC lathes
- Grinding and abrasive cutting
- Laser and plasma shape cutting
- Waterjet cutting
- Pipe and tube bending
- 3D printing / additive manufacturing
- Press feeding and coil handling equipment
- CNC routing

OPEN ARCHITECTURE.

For advanced manufacturing applications.

APPLICATION 1

VERTICAL MACHINING CENTER

- X,Y,Z axis
- Tool changer axis
- Spindle tilt A axis
- Spindle tilt B axis
- Rotary table axis
- Rotary table tilt axis

YOU GAIN Higher cutting speeds, better surface finish, higher chip to chip times and EtherCAT compatibility with all components.

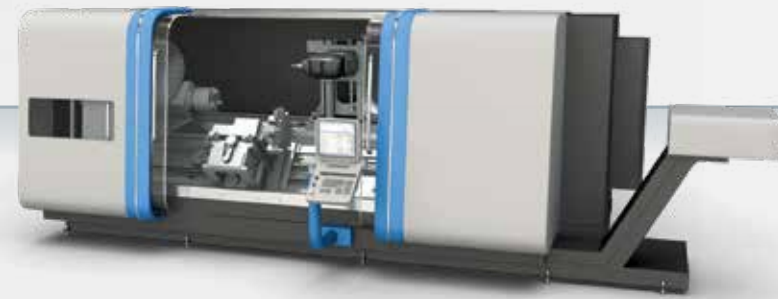

APPLICATION 2

LASER, PLASMA OR WATERJET CUTTING AND ROUTING

- X,X',Y,Z axis
- Bevel tilt A or B axis
- Linear motors

YOU GAIN Gantry systems that are lighter, faster and easier to run. Lightning fast speeds. Micron-level precision. Incredibly smooth cuts.



APPLICATION 3

3D PRINTER

- X,X',Y,Z axis gantry
- Linear motors

YOU GAIN Dramatically reduced part production time, better surface finish, more consistent material properties, significantly larger build envelope.

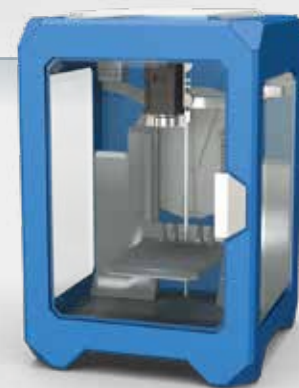

SOLID HARDWARE.

Proven performance PLUS power of versatility.

Today's machine builders are no longer locked into CNC component choices. You're free to choose the best possible products. For a growing number of machine builders this means Yaskawa. Design and build for performance with ease of use and versatility

in mind. Industry leader for Ethercat Servo, Spindle and VFD products. G-code Motion Controller mechatronic ready for Cartesian, 5 Axes and Yaskawa robotic arms. Powerful core processor adaptive to your machine eco system.

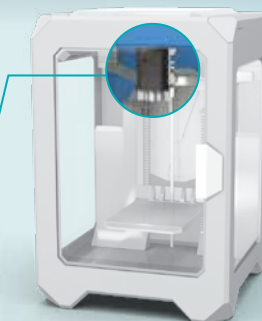
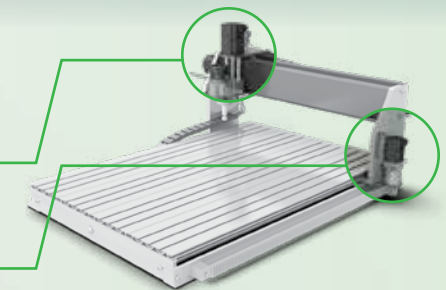
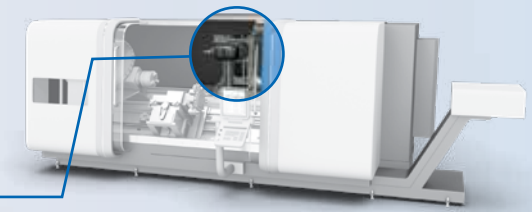
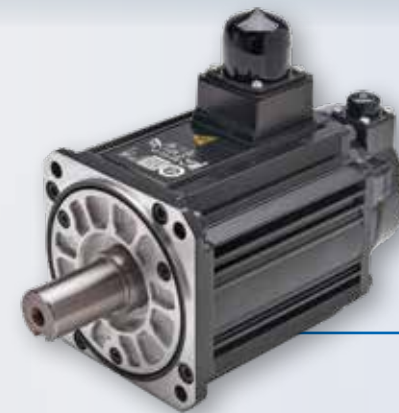

HARDWARE FEATURES

FEATURES THAT SET YOUR MACHINE APART.

Improvements boost an end user's bottom line.



MP3300IEC: HYBRID READY

A single MP3300iec machine controller can operate multiple part systems, including gantries, robots, servo axes and G-code machining equipment for both additive and subtractive processes.

MP3300iec provides up to 62 axes of motion, multi-axis synchronization, 5-axis simultaneous control and custom kinematic capabilities. A built-in web server lets you check status and diagnose through a standard web browser. Intelligent network solutions gain more data and connectivity to machine I/O, sensors and auxiliaries.



SIGMA-7 SERVO: HIGH SPEED, HIGH PRECISION, COMPACT AND EFFECTIVE

Yaskawa makes it an easy choice. Sigma-7 superior servo performance and reliability remains consistent with more torque, higher responsiveness and greater precision in a compact frame. Choose from an extensive servo product portfolio.

200 V and 400 V models, 24-bit high resolution battery-less encoders, 3.1 kHz frequency response, thermal sensors, functional safety, regenerative power sharing, dual axis drives, and network options, including Modbus TCP, EtherNet/IP, MECHATROLINK-III and EtherCAT.

MAXIMUM PERFORMANCE FOR EVERY PROCESS

Yaskawa Robots provide versatility in subtractive and additive applications while enhancing overall product throughput. With ease of programming in G-code, IEC-61131-3 or native robot language, the Yaskawa Robot portfolio is scalable and diversified ranging from 0.5 kg up to 800 kg payload. Applications include machine tending, milling, laser cladding, 3D printing, grinding/deburring, part nesting, bin picking and more.

SUPERIOR SPINDLE PERFORMANCE

Sigma-SD spindle motors are designed specifically for machine tool applications.

- Power to 45 kW, output 200% of continuous rating.
- Line regenerative power supply for energy savings
- EtherCAT or analog interface
- Spindle orient and winding change standard
- Suitable for in-line spindle configurations

SPINDLE-FRIENDLY VFD DESIGN

The performance and usability of Yaskawa's G800 variable speed drive make it an attractive alternative for machine tool spindle applications.

- Range of outputs up to 600 HP
- Spindle orientation, networking via EtherCAT, EtherNet IP, Analog, others
- Output to 590 Hz, 1 kHz or more by request
- Closed loop vector option
- Bluetooth and DriveWizard Mobile for convenient and easy interaction

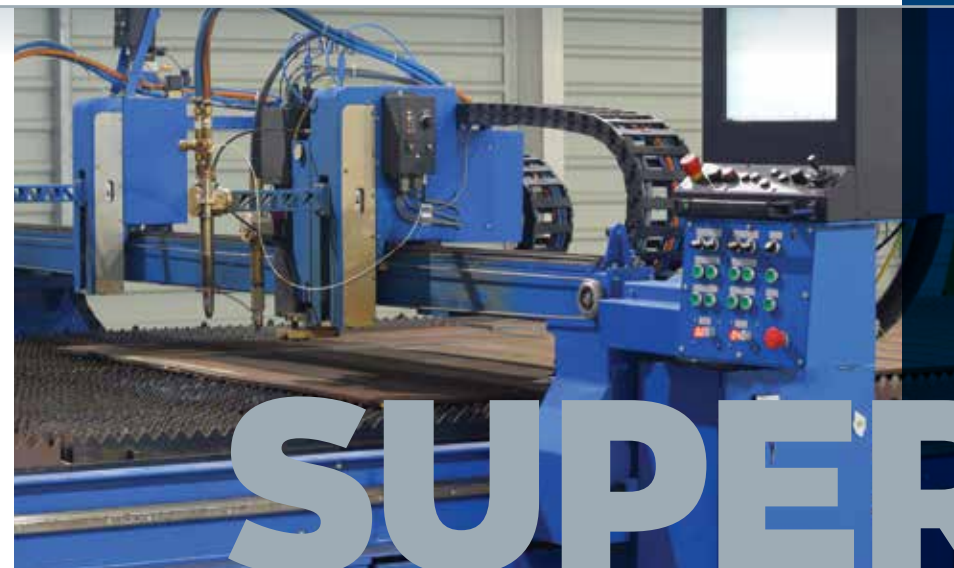

- Safe Torque Off (STO)
- SS1 (Safe Stop 1)
- SS2 (Safe Stop 2)
- Safe Limited Speed (SLS)

FUNCTIONAL SAFETY

Prevent personal injury and meet US OSHA and European CE requirements with a set of built-in functional safety features.

Yaskawa's safety options also reduce wiring time and component count by eliminating the need for contactors in the safety circuit.

PERFORMANCE ENHANCEMENTS

EASY-TO-USE TOOLS FOR VISIBILITY & OPTIMIZATION.

Software development can be exhausting and time critical. Today, machine builders need speed to market approach to stay competitive.



YASKAWA COMPASS™

Yaskawa Compass your CNC navigator, a graphical user software package for 3D printing, shape cutting, machine tool and robotics. Machine manufactures can simply customize with no C# programming or software development kits required. Easily configure your screen, choose from a list of plug-ins or create your own, change colors, add auxiliaries, and optimize your screen for a richer user experience.

Key features of Yaskawa Compass include:

- Landscape or portrait mode
- Machine configurator
- Screen configurator
- Prebuilt plugins
- OEMs branding with company colors and graphics
- Axis configurator
- Auto, MDI and manual mode
- Pop-up NC editor and messaging
- Alarm history
- Tool manager
- Part cycle time measurement tools
- Part viewer with live TCP updates

To supplement the use of Compass with MPiec controllers, Yaskawa has added advanced motion control features to its MotionWorks IEC library. Some of these include bed leveling compensation, extruder pressure advance control, tangential control and ability to create custom G-codes and kinematics.

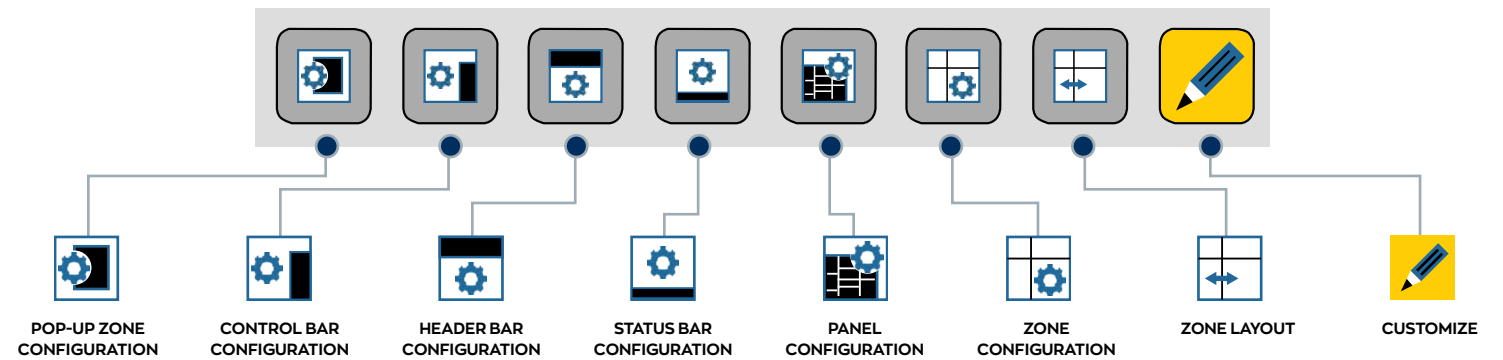
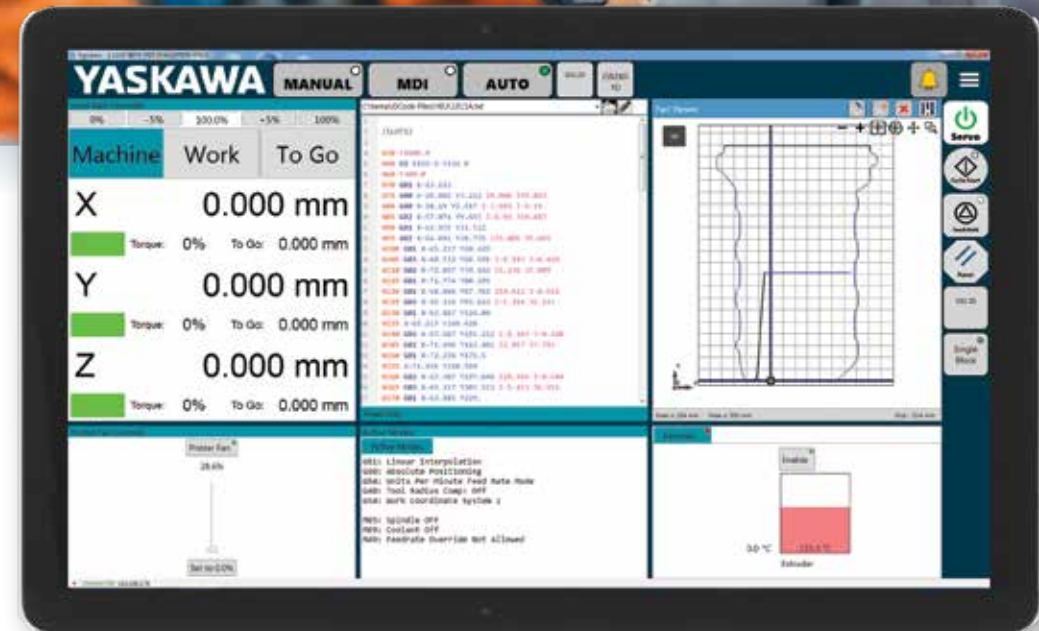

PERFORMANCE ENHANCEMENTS

SPEED UP RESULTS.

Programmers familiar with the conventions of the IEC 61131-1-3 environment will instantly be at home using MotionWorks IEC. It was created to be as fast as it is familiar, with time-saving features.

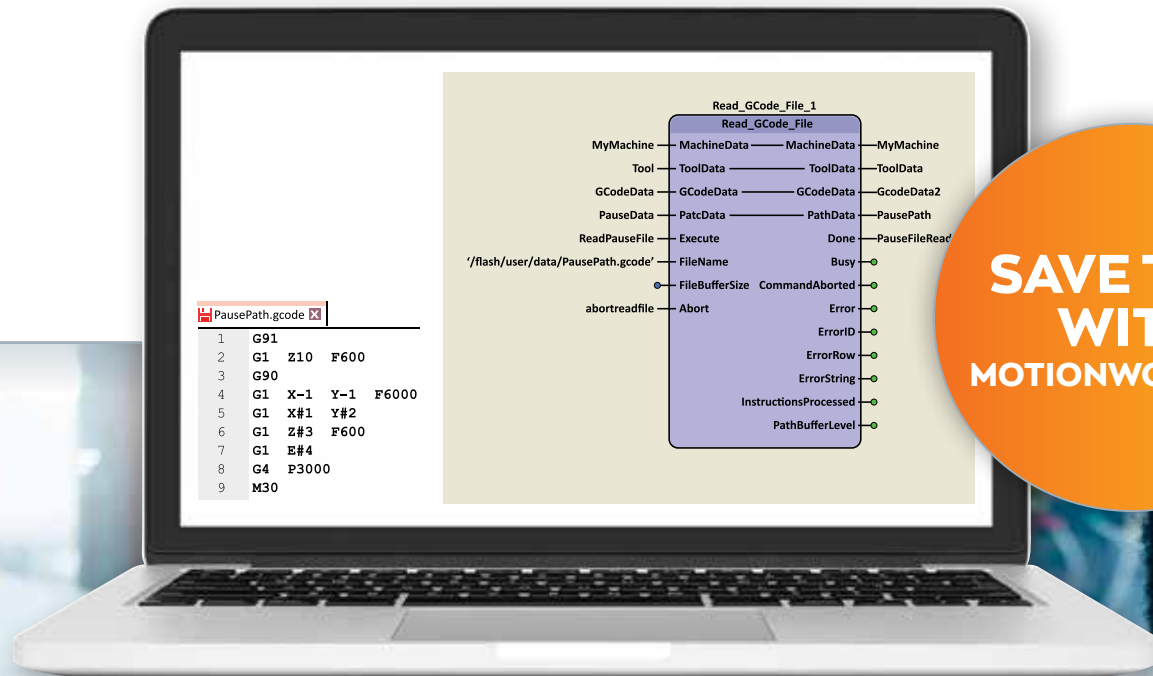

SAVE TIME WITH MOTIONWORKS IEC

MotionWorks[®] IEC PROFESSIONAL

IEC61131-3 STANDARDIZED PROGRAMMING

MotionWorks IEC was built on the conventional tools that automation professionals already know and trust:

- G-code execution
- Custom kinematics
- Sequential function charts
- Function block diagram
- Structured text
- Ladder diagram
- PLCopen function blocks, including part 1, 2, 4 and 5

APPLICATION CODE TOOLBOXES

Yaskawa Toolboxes use application code for higher level automation tasks, created by Yaskawa experts in application programming.

The range of tasks includes:

- Reusable motion code libraries to cut down the time and tedium of standard operations
- A built-in cam editor with ten powerful camming function blocks

EMBEDDED FUNCTIONS

Growing list of ready-made Motion IEC tools:

- Bed leveling surface compensation
- Extruder pressure advance control
- Temperature control
- Stepper control
- Tangential control
- Multi extruder and spindle control
- Registration offset
- Tool changer

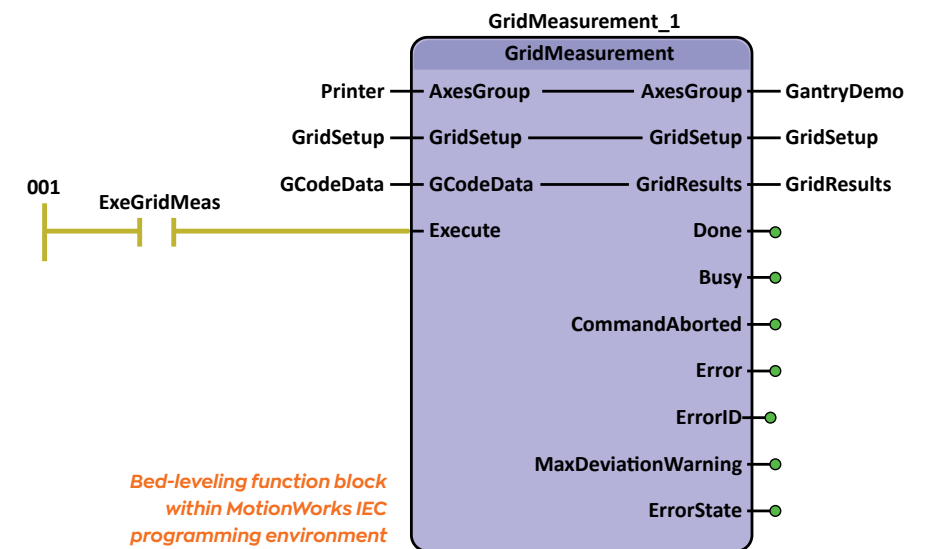

EFFICIENT

PERFORMANCE ENHANCEMENTS

SERVO SYSTEM SOFTWARE THAT TUNES YOUR MACHINE.

Performance-robbing mechanical effects are gone, with no effort on your part.



THE INDUSTRY'S BEST TUNING SUITE WORKS AUTOMATICALLY FROM DAY ONE

A suite of Yaskawa tuning algorithms eliminates the need for servo tuning from the moment of installation, to make machine commissioning easier than ever.



VIBRATION SUPPRESSION

Yaskawa vibration suppression algorithm is the best in the business at compensating for mechanical resonances and component movement. It works automatically, requiring no operator effort.

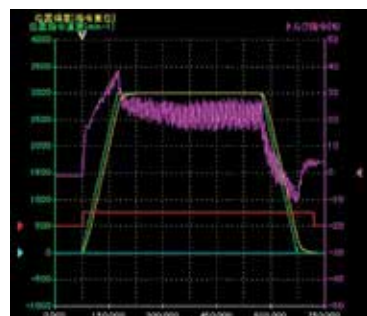

VIBRATIONSUPPRESSION OFF

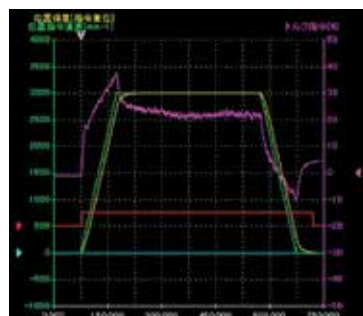

VIBRATIONSUPPRESSION ON

TUNING-LESS MODE

Automatically tunes each servo to the machine's function, with no need for operator intervention

INERTIA COMPENSATION

Counteracts the effects of changes in load-to-motor inertia, up to an industry-leading 30 to 1

ONGOING OPERATION

Servos continually adjust themselves to prevent detuning over time

COGGING ELIMINATION

At slow speeds, motor cogging creates output ripples that cause jagged cuts or wavy surfaces. Yaskawa's ripple compensation minimizes this effect, for a finished product that conforms more precisely to specifications.

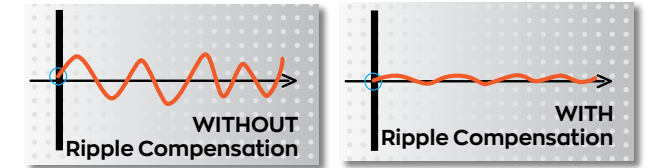

TRACKING ACCURACY

Backlash and lost motion in a gearbox or rack-and-pinion system can lead to a loss of precision, as well as path error caused by positioning response delays. Yaskawa servo amplifiers offer built-in model following and less deviation control for superior tracking capability.

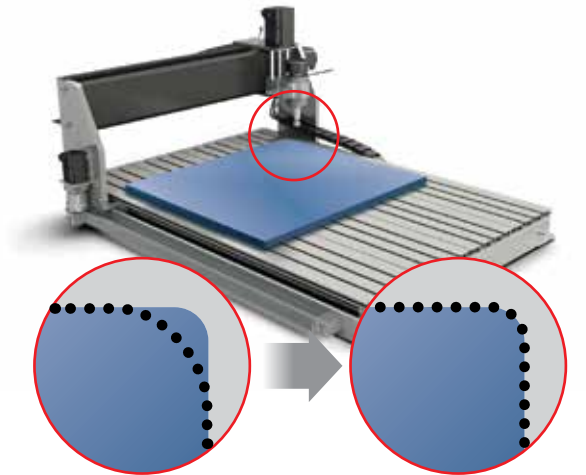

FRICITION COMPENSATION

Yaskawa's exclusive friction compensation software delivers consistently smooth machine starts and transitions, even with the stresses of machining operations and gradual long-term wear of machine components. The Yaskawa algorithms compensate for both coulomb friction between dry surfaces and viscosity friction between dry and wet surfaces.

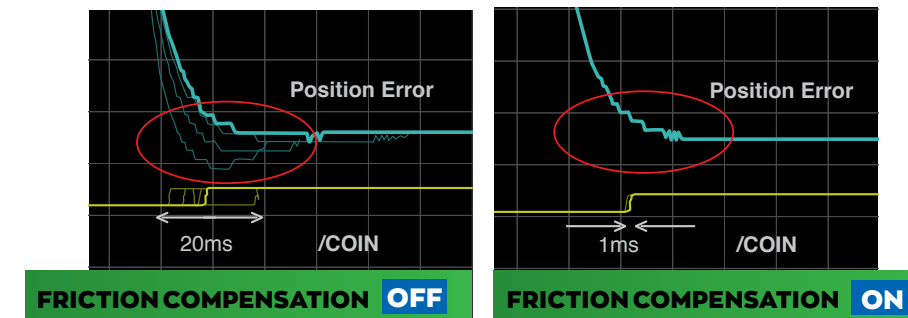

Position completed **20ms EARLIER** in grinding operation

EMI CANCELLATION

We've increased the number of interference filters by **225%**, counteracting loss of data from drop-outs, factory EMI interference and artifacts caused by long cable runs.

225%

ACCURATE

A COMPANY YOU CAN COUNT ON.

The numbers support Yaskawa's status as a preferred provider of machine motion control.

A 25+ YEAR PRODUCT LIFE CYCLE

The original Sigma series servo was introduced in 1992 and remained in production until 2009 with another 10 years of service and repair. That adds up to a product life cycle of over a quarter century! Our latest Sigma-7 product is scheduled to stay in full production until 2028, with years of support afterward.

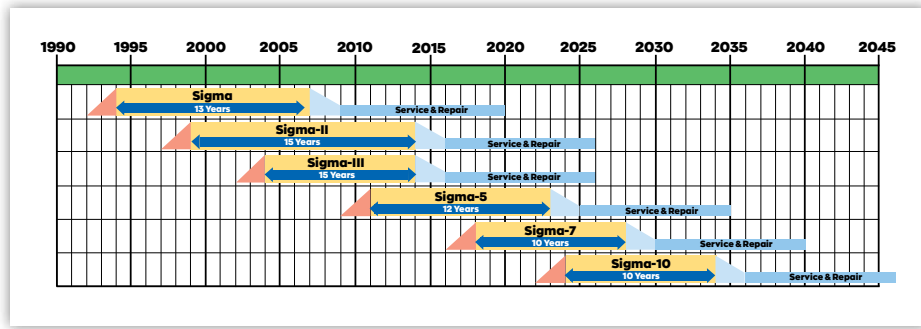

YOU GAIN
the confidence that your end users can easily obtain the components you specify for decades to come.

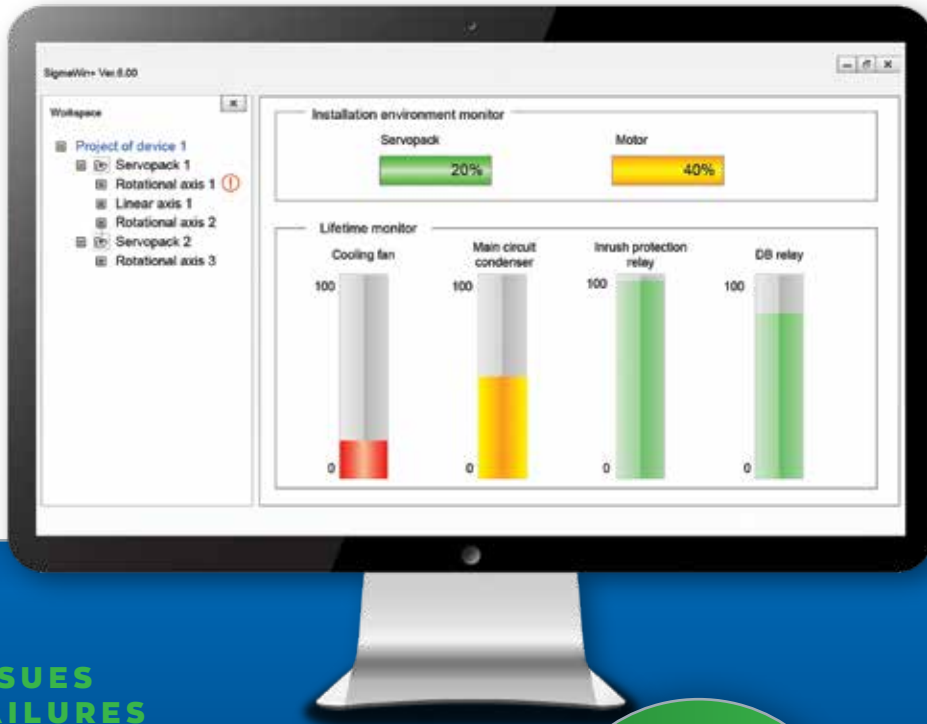

YOU GAIN
Early warning on potential problems and immediate info to address emergency system failures.

DETECT MAINTENANCE ISSUES BEFORE THEY BECOME FAILURES

Service life monitoring software is built into capacitors, cooling fans, dynamic brake relays and other key components. The data is constantly assessed, and an alarm is sent when safe thresholds are exceeded. Info on key operating parameters is also available via MECHATROLINK or EtherCAT.

YASKAWA: A GLOBAL POWERHOUSE IN INDUSTRIAL AUTOMATION



COUNTRIES WITH YASKAWA SALES, SERVICE & MANUFACTURING LOCATIONS



12,800+
WORLDWIDE ASSOCIATES

\$4.6B
in global sales

Since 1915, Yaskawa has produced

18M SERVO AXES	30M AC DRIVES	436K ROBOTS
1.12M SERVO AXES	2.1M AC DRIVES	40K ROBOTS

PER YEAR

YOU GAIN

- Global brand acceptance by your machine's end users
- The expertise to provide breakthrough performance, and to continue providing it for the long run
- Breadth of product technology that meets your needs now, and will expand to meet it in years to come
- A long term legacy of quality, durability, reliability and the lowest possible long-term cost of ownership



Highest mean time between failures in the motion control industry

25+

Typical product lifespan: 25+ years in field service



Standard repair turnaround: 7-10 days, with many levels of expedited service available



The industry's largest stock of exchange inventory



\$15 million of servo products in stock, ready for overnight delivery



No charge for complete technical support to designers, machine builders and end users



80% of support issues are resolved on the first call

YOU GAIN
Superior confidence that Yaskawa components will maximize end user satisfaction with your machine's performance.

YASKAWA.COM



Yaskawa is the leading global manufacturer of low and medium voltage variable frequency drives, servo systems, machine controllers and industrial robots. Our standard products, as well as tailor-made solutions, are well known and have a high reputation for outstanding quality and reliability.

YASKAWA

Yaskawa America, Inc. | Drives & Motion Division

1-800-YASKAWA | Email: info@yaskawa.com | yaskawa.com

Document No. BL.YAI.10 | 02/03/2021 | © 2020 Yaskawa America, Inc.