

Detail A  
Top mounting hole dimensions  
Scale 1:1

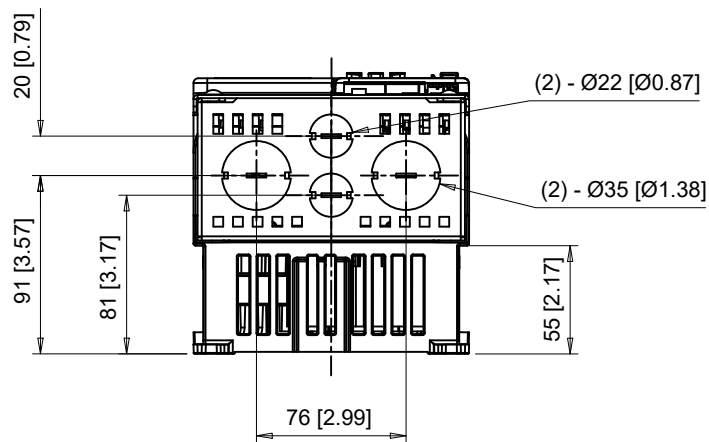

The dimensions shown are for an IP20 drive that has been converted to a UL Type 1 drive by adding the parts from UL Type 1 kit part number ZBAA-GA50V5-1

C/C: GA50□	INPUT VOLTAGE (VAC)	WEIGHT Kg (lb)	COOLING FANS
2030□□□	200 TO 240	4.0 (8.9)	1
2042□□□	3-PHASE	4.2 (9.3)	2
4018□□□	380 TO 480	3.6 (8.0)	1
4023□□□	3-PHASE	3.8 (8.4)	1

□ denotes A-Z

**YASKAWA**



UNITS MM [IN]  
SCALE 1:4

DRWN. J. MATTAS 10-22-19  
 CHKD. J. PIOTROWSKI 11-4-19  
 TECH. L. UDDIN 11-18-19  
 APRV. J. CAIRO 11-19-19

TITLE  
 GA500 DIMENSION DRAWING  
 FRAME SIZE 5  
 UL TYPE 1 ENCLOSURE

SIZE A  
 PAGE 1 OF 4  
 DWG.NO.  
 DD.GA50.FR5.T1

REV  
0

# Terminal and Wiring Information for GA50□2030, GA50□4018 and GA50□4023

**FRONT VIEW**

**BOTTOM VIEW**

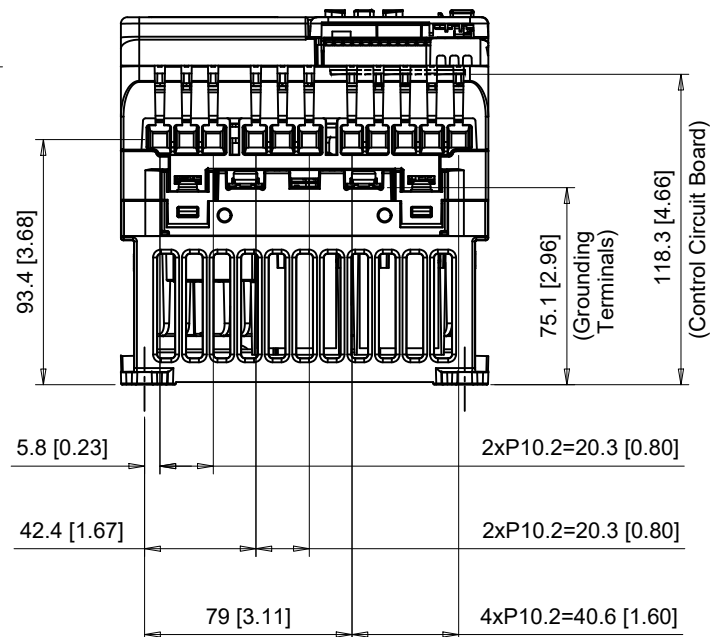
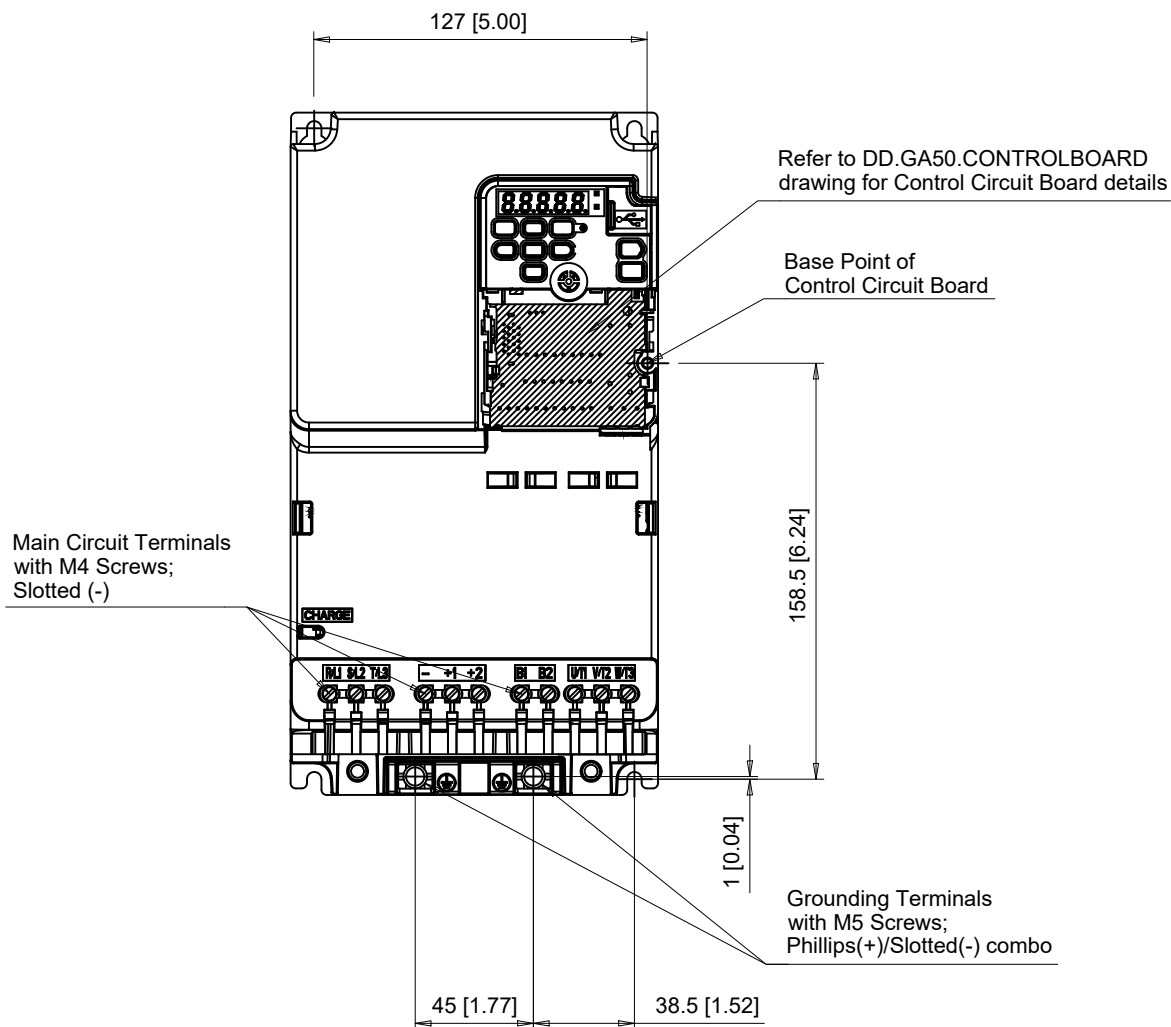

C/C:	TERMINAL SYMBOL	WIRE RANGE AWG (mm <sup>2</sup> )	TERMINAL SCREW	CLAMPING TORQUE N.m. (lb.in.)
GA50□	R/L1, S/L2, T/L3	14 - 6 (2.5 - 16)	M4	1.7 (15)
2030□□□	U/T1, V/T2, W/T3	14 - 6 (2.5 - 16)	M4	1.7 (15)
4018□□□	-, +1, +2	14 - 6 (2.5 - 16)	M4	1.7 (15)
4023□□□	B1, B2	14 - 6 (2.5 - 16)	M4	1.7 (15)
	⊕	10 - 6 (6 - 16)	M5	2.0 - 2.5 (18 - 22)

□ Denotes A-Z

Note: Refer to applicable codes and standards for proper wire type and size.

**YASKAWA**



UNITS MM [IN]

SCALE 1:3

DRWN.	J. MATTAS	10-22-19
CHKD.	J. PIOTROWSKI	11-4-19
TECH.	L. UDDIN	11-18-19
APRV.	J. CAIRO	11-19-19

TITLE  
GA500 DIMENSION DRAWING  
FRAME SIZE 5  
UL TYPE 1 ENCLOSURE

SIZE A PAGE 2 OF 4  
DWG.NO.  
DD.GA50.FR5.T1

REV  
0

# Terminal and Wiring Information for GA50□2042

FRONT VIEW

BOTTOM VIEW

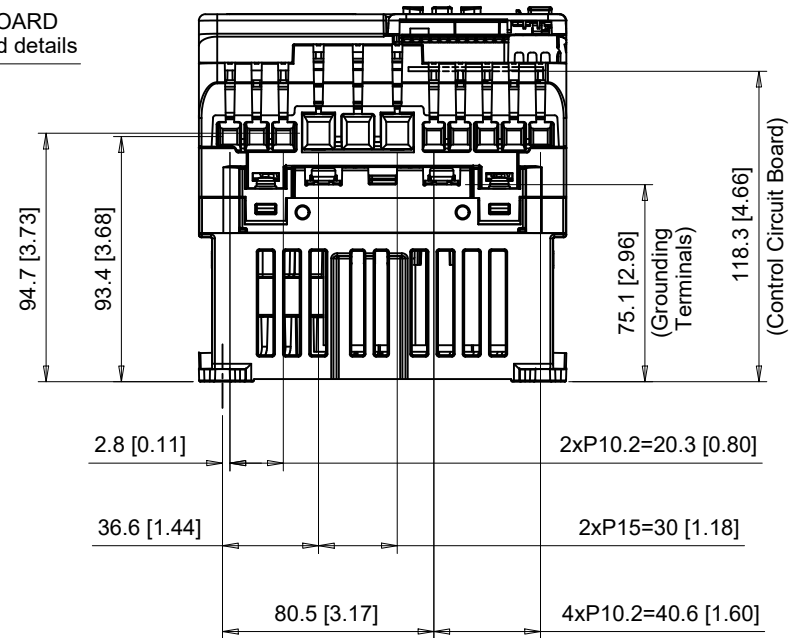
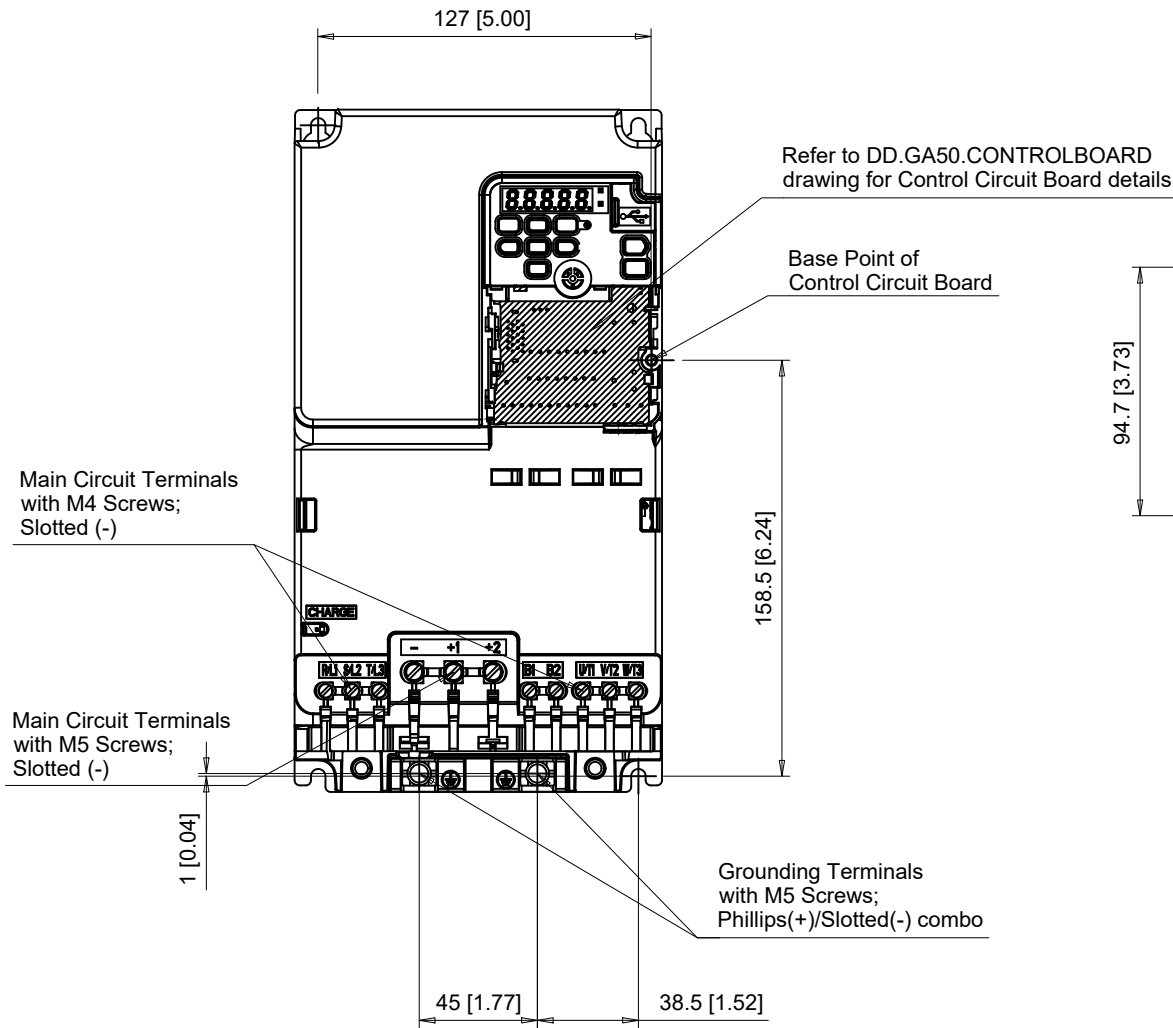

C/C:	TERMINAL SYMBOL	WIRE RANGE AWG (mm <sup>2</sup> )	TERMINAL SCREW	CLAMPING TORQUE N.m. (lb.in.)
GA50□	R/L1, S/L2, T/L3	14 - 6 (2.5 - 16)	M4	1.7 (15)
	U/T1, V/T2, W/T3	14 - 6 (2.5 - 16)	M4	1.7 (15)
2042□□□	-, +1, +2	8 - 2 (10 - 35)	M5	4.5 (40)
	B1, B2	14 - 6 (2.5 - 16)	M4	1.7 (15)
	⊕	10 - 6 (6 - 16)	M5	2.0 - 2.5 (18 - 22)

□ Denotes A-Z

Note: Refer to applicable codes and standards for proper wire type and size.

**YASKAWA**

UNITS MM [IN]  
SCALE 1:3

DRWN. J. MATTAS 10-22-19  
CHKD. J. PIOTROWSKI 11-4-19  
TECH. L. UDDIN 11-18-19  
APRV. J. CAIRO 11-19-19

TITLE  
GA500 DIMENSION DRAWING  
FRAME SIZE 5  
UL TYPE 1 ENCLOSURE

SIZE A PAGE 3 OF 4  
DWG.NO. DD.GA50.FR5.T1

REV 0

Minimum Installation Clearances

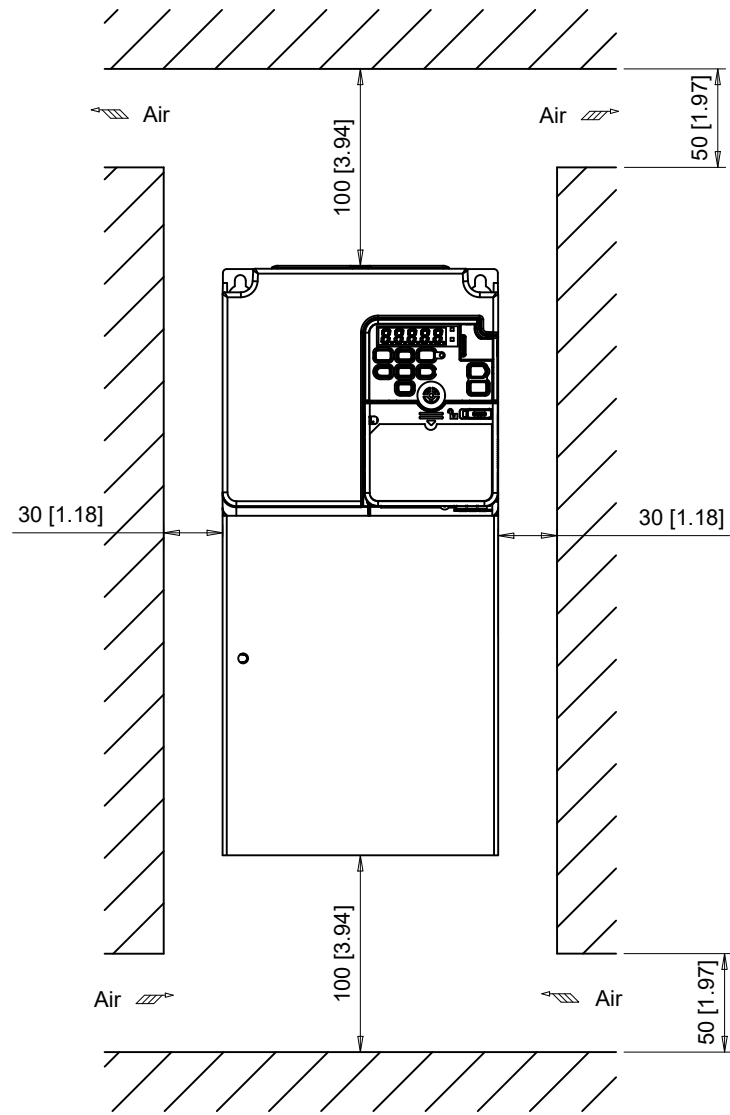

Note:  
For alternate mounting configurations, consult manual.

**YASKAWA**

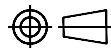

UNITS MM [IN]

SCALE 1:4

DRWN.	J. MATTAS	10-22-19
CHKD.	J. PIOTROWSKI	11-4-19
TECH.	L. UDDIN	11-18-19
APRV.	J. CAIRO	11-19-19

TITLE  
GA500 DIMENSION DRAWING  
FRAME SIZE 5  
UL TYPE 1 ENCLOSURE

SIZE A PAGE 4 OF 4

DWG.NO.  
DD.GA50.FR5.T1

REV

0