

* - INDICATES COMPONENTS NOT SUPPLIED BY YASKAWA.
 - INDICATES CUSTOMER WIRING.
 - CONNECTED TO THE CABINET OR PANEL.
 SEE SHEET 2 FOR NOTES.
 SEE DRAWING UDE00493 FOR DRIVE PARAMETER SETTINGS.

REVISIONS				
REV.	DESCRIPTION	ECO #	DRAWN BY	DATE
07	ADDED TB5 TO DRIVE	11187	NSL	3/19/21
06	UPDATED DRIVE BLOCK	11109	NSL	1/25/21
05	ADDED NOTE 10	8368	NSL	1/24/18

YASKAWA		DRAWN BY: D.R. CMELAK	DATE: 5/15/15	TITLE: SCHEMATIC DIAGRAM
		CHECKED: N. LAWS	DATE: 5/15/15	Z1000U ELECTRONIC BYPASS
		TECH: K. FLIERL	DATE: 5/15/15	SIZE: D
		APPROVED: D.R. CMELAK	DATE: 5/15/15	REVISION: 07
		ORIGINAL DESIGN: D.R. CMELAK	DATE: 5/15/15	PAGE: 1 of 2
				DRAWING #: DS.Z1D3.18

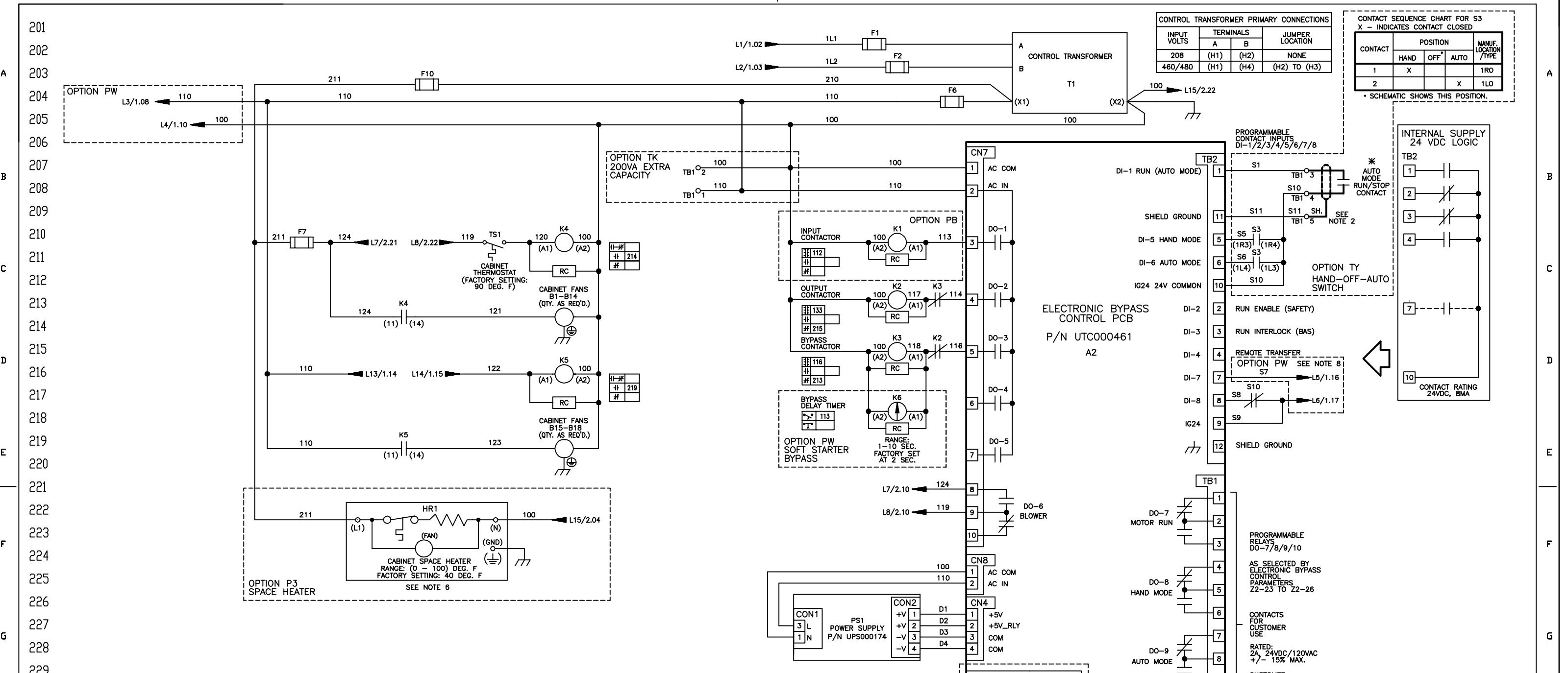

CONTROL TRANSFORMER PRIMARY CONNECTIONS

INPUT VOLTS	TERMINALS		JUMPER LOCATION
	A	B	
208	(H1)	(H2)	NONE
460/480	(H1)	(H4)	(H2) TO (H3)

CONTACT SEQUENCE CHART FOR S3
X - INDICATES CONTACT CLOSED

CONTACT	POSITION			MANUF. LOCATION / TYPE
	HAND	OFF	AUTO	
1	X			1R0
2			X	1L0

* SCHEMATIC SHOWS THIS POSITION.

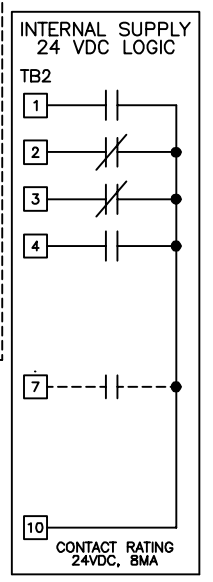

ELECTRONIC BYPASS CONTROL PCB
P/N UTC000461
A2

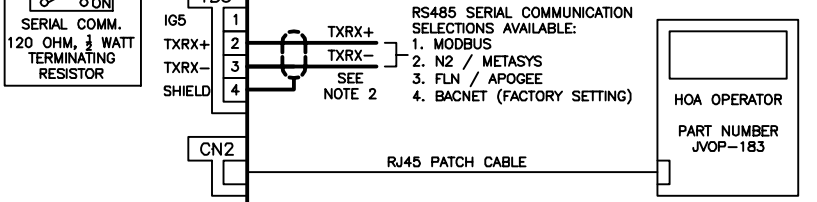
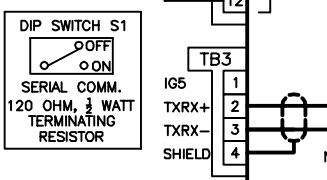
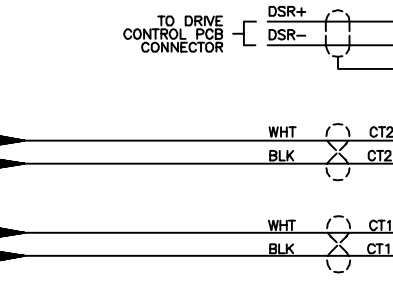
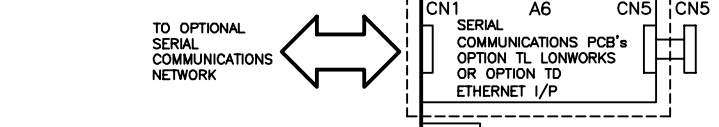
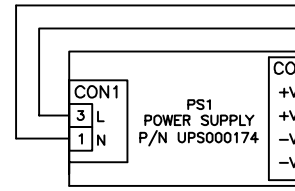
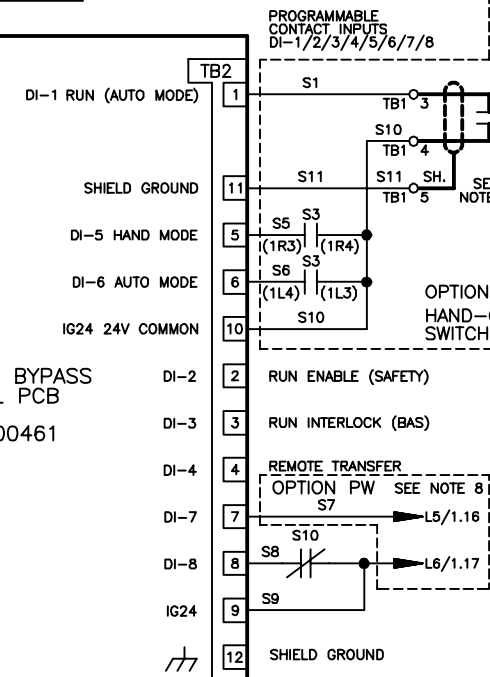

* - INDICATES COMPONENTS NOT SUPPLIED BY YASKAWA.
- - - INDICATES CUSTOMER WIRING.
- - - CONNECTED TO THE CABINET OR PANEL.

- NOTES:**
1. CONNECTED TO THE CABINET. CUSTOMER TO CONNECT THE CABINET GROUND LUGS TO EARTH GROUND AND UTILITY GROUND.
 2. INSULATED TWISTED SHIELDED WIRE IS REQUIRED. SHIELD TO CONNECT TO PROPER TERMINAL AS SHOWN. CONNECT THE SHIELD ONLY AT THIS END. STUB AND ISOLATE THE OTHER END. DO NOT RUN THESE WIRES IN THE SAME CONDUIT AS THE AC POWER AND THE AC CONTROL WIRES.
 3. CHANGING Z1-01 TO "1" WILL PROGRAM THE DRIVE AND BYPASS PARAMETERS TO THEIR FACTORY DEFAULT SETTINGS.
 4. FOR 208VAC APPLICATIONS, SET Z1000U DRIVE PARAMETER E1-05 TO 208.
 5. THE MOTOR OVERLOAD RELAY IS FACTORY SET FOR MANUAL RESET. CUSTOMER TO ADJUST THE MOTOR OVERLOAD RELAY TRIP SETTING FOR THE ACTUAL AC MOTOR'S FULL LOAD AMPS.
 6. CUSTOMER TO ADJUST THE THERMOSTAT ON THE SPACE HEATER HR1 FOR THE MINIMUM DESIRED TEMPERATURE INSIDE THE DRIVE CABINET. THIS SET TEMPERATURE IS NORMALLY SELECTED TO BE SLIGHTLY HIGHER THAN THE MINIMUM AMBIENT TEMPERATURE OF THE AIR SURROUNDING THE CABINET. AND IS THE TEMPERATURE AT WHICH THE SPACE HEATER HR1 WILL SHUT OFF.
 7. CONDUIT FITTINGS/HUBS SHALL COMPLY WITH THE 'STANDARD FOR CONDUIT, TUBING, AND CABLE FITTINGS, UL 514B'. OR CONDUIT FITTINGS HAVING THE SAME ENVIRONMENTAL RATING AS THE ENCLOSURE SHALL BE USED.
 8. FOR APPLICATIONS WITH SOFT STARTER BYPASS OPTION PW, SET PARAMETERS Z2-07 TO 36, Z2-15 TO 1, AND Z1-42 TO 1. THIS WILL CAUSE THE Z1000U DRIVE KEYPAD TO EXHIBIT AN "EFB" FAULT WHEN THE SOFT STARTER FAILS, AND THE AC MOTOR COASTS TO A STOP. CUSTOMER TO ALSO SET SOFT STARTER PARAMETER In (IN THE SETTINGS MENU) FOR THE ACTUAL AC MOTOR'S FULL LOAD AMPS.
 9. THE SOFT STARTER R1A-R1C FAULT CONTACT IS A FAIL-SAFE CONTACT. THE SCHEMATIC SHOWS IT IN ITS DE-ENERGIZED STATE. CONTACT STATUS IS:
A. OPEN WITH NO POWER APPLIED TO THE LINE SIDE OF THE SOFT STARTER.
B. CLOSED WITH POWER APPLIED TO THE LINE SIDE OF THE SOFT STARTER AND NO FAULT PRESENT.
C. OPEN WITH POWER APPLIED TO THE LINE SIDE OF THE SOFT STARTER AND A FAULT IS PRESENT.
 10. FOR APPLICATIONS WITH SPEED POT R1, SET PARAMETERS Z1-41 TO 1 & H3-06 TO 1F.

YASKAWA

THIS DOCUMENT AND INFORMATION CONTAINED IN IT ARE CONFIDENTIAL, AND CANNOT BE COPIED OR DISCLOSED IN WHOLE OR IN PART WITHOUT THE EXPRESS WRITTEN CONSENT OF YASKAWA AMERICA INC.

DRAWN BY: D.R. CMELAK	CHECKED: N. LAWS	DATE: 5/15/15	TITLE: SCHEMATIC DIAGRAM Z1000U ELECTRONIC BYPASS
APPROVED: K. FLIERL	DATE: 5/15/15	DATE: 5/15/15	DATE: 5/15/15
ORIGINAL DESIGN: D.R. CMELAK	DATE: 5/15/15	DATE: 5/15/15	DATE: 5/15/15

SIZE: D REVISION: 07 PAGE: 2 of 2
DRAWING #: DS.Z1D3.18