



SIE-C815-14 • 5
DESCRIPTIVE
INFORMATION

PROGRAMMABLE CONTROLLER

Memocon™-SC GL60S

USER'S MANUAL

COMM COMMAND

This manual describes specifications and applications of Memocon-SC GL60 communication command. Operators must be familiar with the functions and performance described in this manual. For further details, refer to the following publications.

- SIE-C815-14.1 Memocon-SC GL60 USER'S MANUAL NO. 1 DESIGN AND MAINTENANCE
- SIE-C815-14.2 Memocon-SC GL60 USER'S MANUAL NO. 2 P150 PROGRAMMING PANEL BASIC INFORMATION
- SIE-C815-14.3 Memocon-SC GL60 USER'S MANUAL NO. 3 P150 PROGRAMMING PANEL SFC INFORMATION
- SIE-C815-7.60C MEMOBUS INDUSTRIAL COMMUNICATION SYSTEM

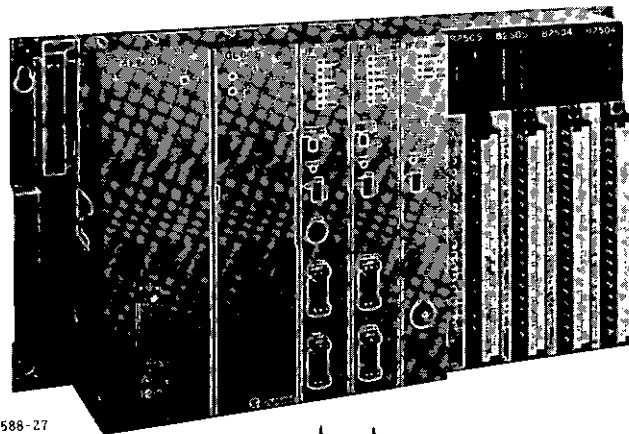

588-27

Expanding Communication
Module (COMM)

I/O Processor Module
(IOP)

CONTENTS

1. FEATURES AND SYSTEM CONFIGURATION	3
1.1 FEATURES	3
1.2 SYSTEM CONFIGURATION	3
2. SPECIFICATIONS	4
2.1 TRANSMISSION SPECIFICATIONS	4
2.2 REQUIRED TIME FOR SIGNAL TRANSMISSION	4
3. COMMUNICATION MODES	7
3.1 SETTING COMMUNICATION MODES	7
3.2 SETTING COMMUNICATION PARAMETERS	8
3.3 TRANSPARENT MODE	8
3.4 MEMOBUS MODE	9
4. COMMAND	10
4.1 FUNCTION BLOCK	10
4.2 TOP ELEMENT	10
4.3 MIDDLE ELEMENT	11
4.4 BOTTOM ELEMENT	12
4.5 CONTROL BLOCK	13
4.6 DEFINITION OF INPUT/OUTPUT	15
5. APPLICATION EXAMPLE	17
5.1 MEMOBUS MASTER	17
5.2 TRANSMISSION TO ASCII DEVICES	19
6. PRECAUTIONS FOR USE	21
7. CABLES	22

1. FEATURES AND SYSTEM CONFIGURATION

1.1 FEATURES

With COMM command, communication can be activated from the GL60S side. Communication can be performed via I/O processor module (IOP) or expanding communication module (COMM) RS-232C communication port as MEMOBUS master unit. When ASCII I/F is used, a query message specifying the format is normally required. However it is not needed for MEMOBUS master functions.

Communication at the same level is possible among three units of GL60S by using four communication ports of IOP or COMM.

Communication with other devices using different protocol from MEMOBUS is also possible by application program.

1.2 SYSTEM CONFIGURATION

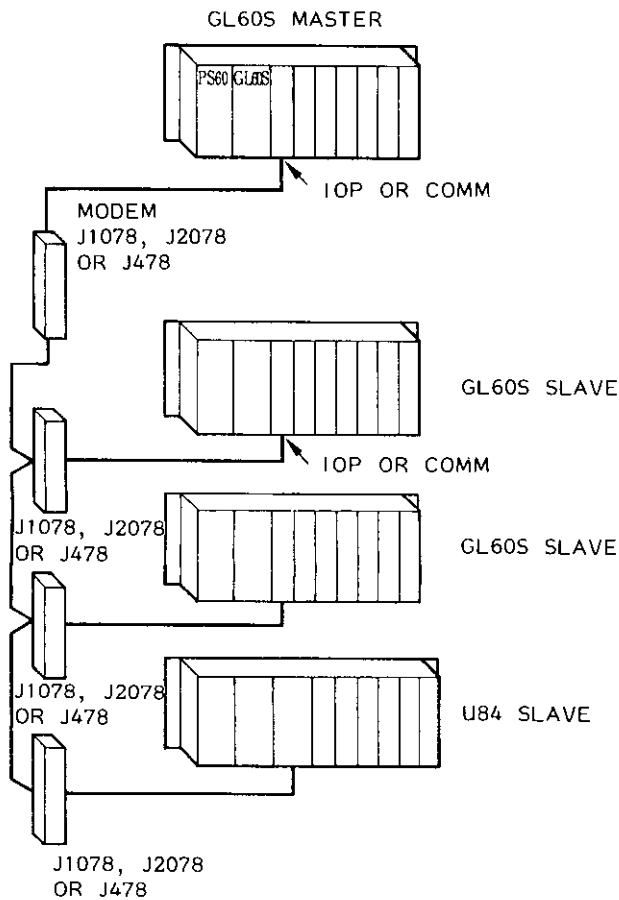

Fig. 1.1 GL60S MEMOBUS Master Unit

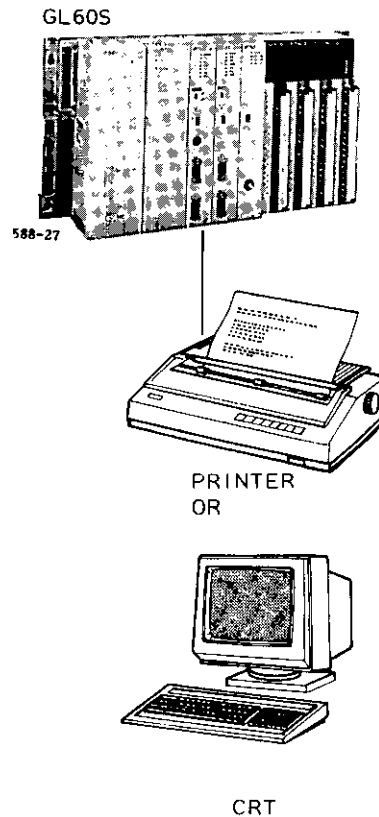

Fig. 1.2 Connection with Other Devices

2. SPECIFICATIONS

2.1 TRANSMISSION SPECIFICATIONS

IOP or COMM board specifications are shown below as transmission specifications.

Table 2.1 Transmission Specifications

Item	Specification
Standards	Conform to EIA RS-232C.
Synchronization	Half-duplex asynchronous
Transmission Speed	19200/9600/4800/2400/1200/600/300/150 baud
Quantity of Characters	RTU (Remote Terminal Unit): 8 bits, ASCII: 7 bits
Stop Bit	1 or 2 bits
Parity Check	Even, odd or no parity
Connector	Mini D-sub 9-pin connector

2.2 REQUIRED TIME FOR SIGNAL TRANSMISSION

Required time for a signal transmission by using COMM command can be calculated from the following seven related times. If more than one slave is connected to the same port on the master, calculate the required time for a signal transmission for each slave and add the results.

(1) Query Message Transmission Processing Time by Master

This time interval comprises the time during which the master constructs a query message and then prepares it at a communication port after COMM command is activated. The time interval depends on the scan time of each master.

Note that only the first COMM command to be read is in execution to the same port though more than one COMM command is possible to be activated simultaneously. The other commands are in waiting status. After execution, the next command is executed. Therefore, the value is given when only one command is activated.

(2) Delay Time of Modem (Master Side)

This time interval comprises the time from the modem receiving RTS (request to send) from the master to the time when the modem sends CTS (clear to send) to the master. With modems J478, J1078 and J2078 (YASKAWA's standard modems) the delay time is up to 5 ms.

In a system not using any modem, this time is not included in the calculation.

(3) Query Message Transmission Time

To calculate the time, use the equation below. Number of bits per character is the sum of the number of data bits (7 or 8 bits), start bits (1 bit), stop bits (1 or 2 bits), and parity bits (0 or 1 bit).

$$\text{Transmission Time} = \frac{\text{Number of characters of query message} \times \text{Number of bits per character} \times 1000}{\text{Baud rate}} \quad (\text{ms})$$

(4) Slave Processing Time

This time interval comprises the time from a slave receiving and processing a query message sent from the master to the time when the slave prepares a response message to the master at the communication port.

The slave processing time for MEMOBUS is shown as follows.

Table 2.2 Maximum Quantity to be Processed by One Scan

Function Code (Decimal)	Function	U84 584	R84H-M GL20	GL60S
1	Coil state read-out	64	32	2000**
2	Input relay state read-out	64	32	2000**
3	Holding register content read-out	64	16	125
4	Input register content read-out	32	16	125
5***	Single-coil state change	1*	1*	1*
6	Write-in to single holding register	1	1	1
7	Particular coil state read-out	8	8	8
8	Loopback test	-	-	-
15***	Multi-coil state change	64*	-	800
16***	Write-in to holding register	32	-	100
18	Specified link relay state read-out	-	-	1024
19	Constant register content read-out	-	-	125
20	Step passed time content read-out	-	-	125
21	Link register content read-out	-	-	125
22	Extension register content read-out	-	-	125
23	Step state read-out	-	-	512
25***	Specified link relay state change	-	-	1*
26***	Write-in to specified constant register	-	-	1
27***	Write-in to specified link register	-	-	1
28***	Write-in to specified extension register	-	-	1
29***	Multi-link relay state change	-	-	1024*
30***	Write-in to multi-constant register	-	-	123
31***	Write-in to multi-link register	-	-	123
32***	Write-in to multi extension register	-	-	123

* Two scans are required.

** Scan will be 10 ms longer for the maximum value.

*** "0" can be specified as slave address.

The following processing times are not necessary when only transmission is performed.

2.2 REQUIRED TIME FOR SIGNAL TRANSMISSION (Cont'd)

(5) Delay Time of Modem (Slave Side)

This time interval consists of the time from the modem receiving RTS from a slave to the time when the modem returns CTS to the slave. In the case of J478, J1078 and J2078 modems the delay time is up to 5 ms.

In a system not using any modems, this time is not included in the calculation.

(6) Response Message Transmission Time

The following equation, which is the same as that of the calculation of query message transmission time, should be used.

Transmission Time =

$$\frac{\text{Number of characters of query message} \times \text{Number of bits per character} \times 1000}{\text{Baud rate}} \quad (\text{ms})$$

(7) Response Message Processing Time by Master

1 to 2 scans

This time interval is required when master GL60S receives response message from the slave and process is performed to complete the COMM commands.

3. COMMUNICATION MODES

3.1 SETTING COMMUNICATION MODES

There are two units between the master and slave units: MEMOBUS and transparent modes (see par. 3.3). Communication modes are set by dip switch (1SW) of IOP or COMM. Table 3.1 shows a list of settings.

These settings are valid only when COMM commands are used for communication.

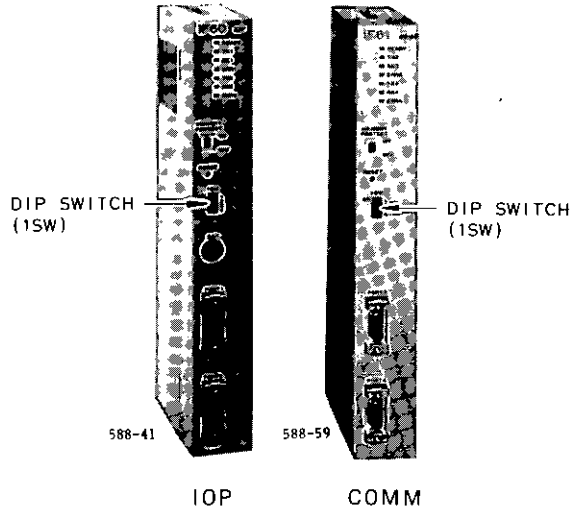

Fig. 3.1 Dip Switch (1SW)

(a) IOP

1SW	Port No.	Setting	Communication Mode
2	1	ON	Transparent mode
		OFF	MEMOBUS mode
3	2	ON	Transparent mode
		OFF	MEMOBUS mode

(b) COMM

1SW	Port No.	Setting	Communication Mode
2	3	ON	Transparent mode
		OFF	MEMOBUS mode
3	4	ON	Transparent mode
		OFF	MEMOBUS mode

3.2 SETTING COMMUNICATION PARAMETERS

Set the communication parameters with RAP (register access panel) or programming (P150). The communication parameters set when GL60S system is activated are used. Change can be possible at any time.

Table 3.2 Communication Parameters

Baud Rate	150, 300, 600, 1200, 4800, 9600, or 19200
Parity	Parity check disabled, even parity or odd parity
Stop Bit	1 or 2
Communication Mode	RTU or ASCII

3.3 TRANSPARENT MODE

In this mode, transmission data prepared in the holding register are sent without being processed and received data from the port are stored in the holding register. Accordingly, no communication protocol is specified so that flexible communication is available by application programs. However, BCC (binary check code) or CRC (cycle redundancy check) or LRC (longitudinal redundancy check) is not made automatically by IOP or COMM: it must be made and added by application programs.

There are some differences between RTU mode and ASCII mode as follows.

(1) RTU Mode (8-bit Mode)

At transmission, the holding register data specified by command are sent from the port. Upon reception, the received data are input in the specified holding register.

Completion of query message at transmission/receiving is performed by timer (24-bit time).

(2) ASCII Mode (7-bit Mode)

At transmission, the holding register data specified by command are sent from the port without changing codes. In case of ASCII mode, the number of data bits is 7. MSB is not sent out.

Upon reception, there are some definitions of query message formats from the remote station. An identifier is needed for completion of the query message. All transmission data including the identifier for completion are input in the holding registers specified by the command.

3.4 MEMOBUS MODE

This mode is used when GI.60S is used as MEMOBUS master unit.

At transmission, the data applicable to MEMOBUS protocol are prepared as transmission data in the holding register specified by the command. BCC is added by IOP or COMM. Therefore, the received data other than BCC are input in the specified holding registers.

(1) RTU Mode

At transmission, the holding register data specified by the command are sent from the port. Upon reception, the received data are input in the specified holding registers.

Completion of the query message at transmission/receiving is performed by timer (24-bit time). The number of receiving data items does not include BCC (in this case, BCC of CRC).

(2) ASCII Mode

At transmission, the holding register data specified by command are changed to 8-bit ASCII code. The number of transmission data is 7.

A start identifier ":" and a completion identifier "CR, LF" of the query message are added automatically by IOP or COMM at transmission.

Upon reception, the start and completion identifiers are removed automatically and remaining data are stored in the holding register specified by the command as received data. At this time, the data are reversed from ASCII code.

The number of received data items does not include BCC (in this case, BCC of LRC).

Fig. 3.2 shows the relation of register data and actual transmission/receiving data for the ASCII mode.

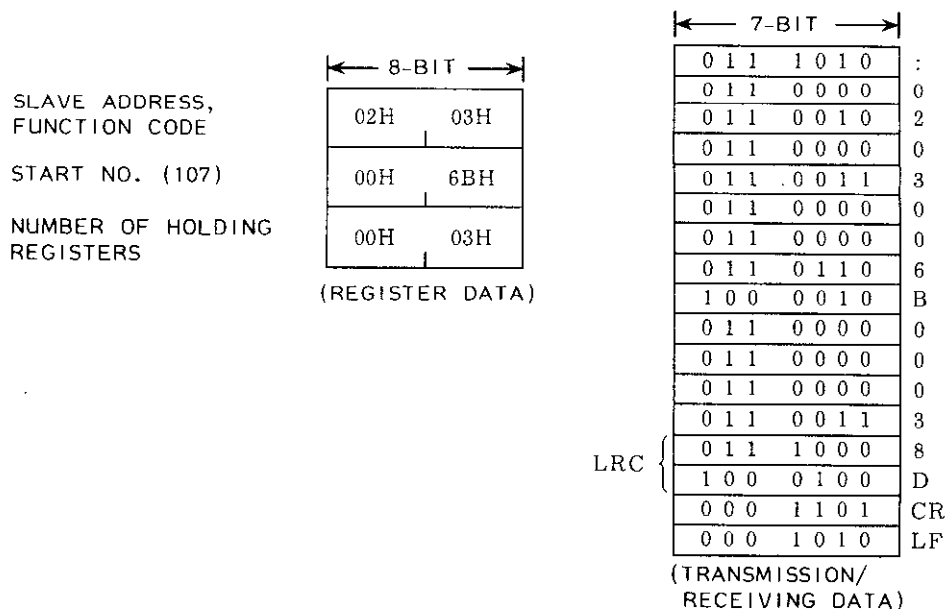
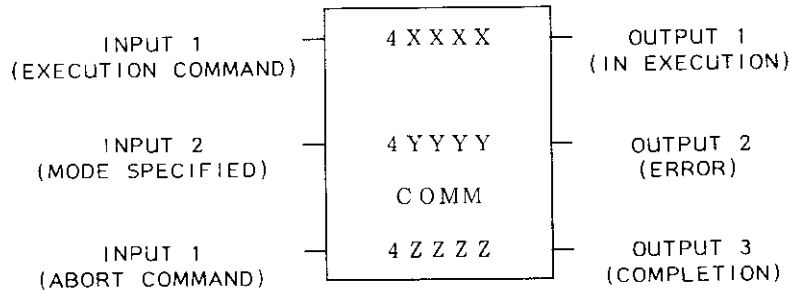

Fig. 3.2 Register Data and Transmission/Receiving Data

4. COMMAND

In COMM commands, the message does not have to be made, being different from READ/WRIT commands for ASCII. Therefore no format for register data is specified. All transmission query messages are prepared and received query messages are stored in the holding registers.

4.1 FUNCTION BLOCK



4.2 TOP ELEMENT

The top element uses four holding registers from 4XXXX, in which data to control COMM commands are stored.

Port Nos. to be used or the number of transmission data items is specified. It is also used to indicate the number of received data items or operation condition.

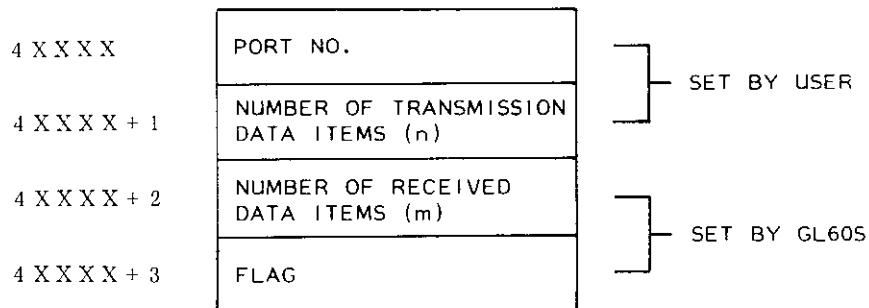

4.3 MIDDLE ELEMENT

The middle element uses n (refer to the figures below) pieces of holding registers from $4YYYY$ as a transmission buffer. It indicates the head reference of register block storing transmission data. The size of the transmission buffer depends on the number n of transmission data items. Before activating command, transmission data must be set.

The data to be sent out is according to the small numbers beside TXD (transmission data) in the figures below.

I) $n = \text{even numbers}$

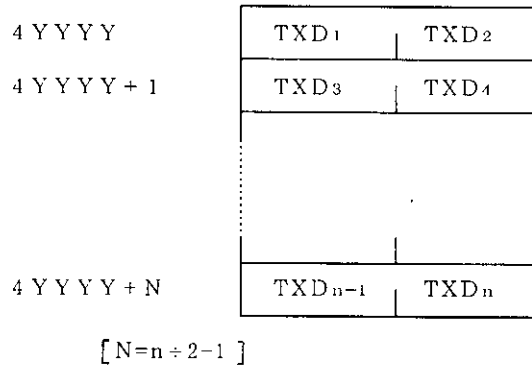

II) $n = \text{odd numbers}$

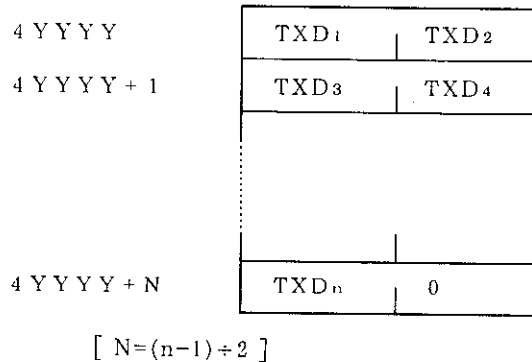

4.4 BOTTOM ELEMENT

The bottom element uses m (refer to the figures below) pieces of holding registers from 4ZZZZ as receiving buffer. The size of the receiving buffer depends on the number m of received data items. Therefore, the maximum number of received data items must be considered beforehand to keep the buffer. Do not use the register area for other applications since that area is kept for the receiving buffer.

This register area can not be cleared with command activation.

The data to be received is according to the small numbers beside TXD in the figures below.

I) $m = \text{even numbers}$

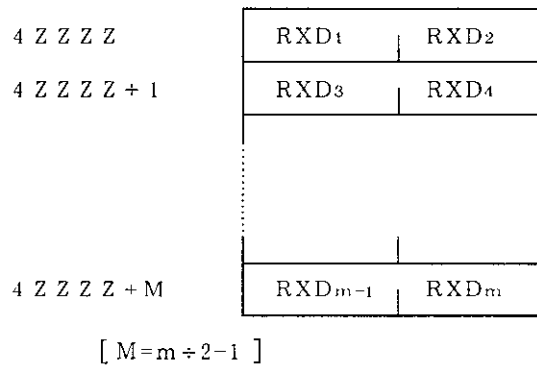

II) $m = \text{odd numbers}$

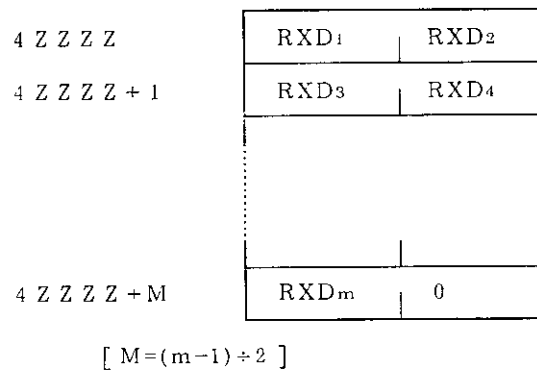

4.5 CONTROL BLOCK

(1) Port No. (4XXXX)

Communication port of IOP or COMM is specified by the lower 4 bits of 4XXXX. Communication with external remote devices can be performed via the specified communication port and the status after execution is indicated by the upper bits 4 to 15.

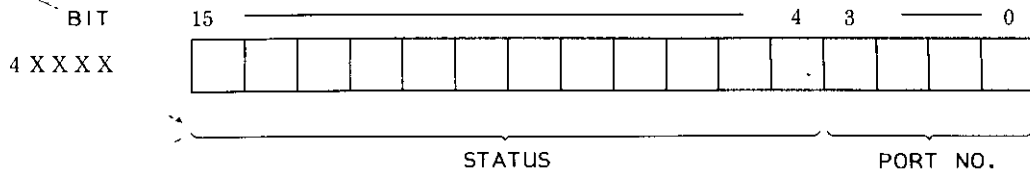

Table 4.1 Allocation of 4XXXX Bits

Bit No.	Contents		
15	BCC (CRC, LRC) error occurs only in MEMOBUS mode.		
14	Transmission cannot be performed from the specified port. Hardware malfunction is possible.		
13	No allocation		
12	Receiving buffer overrun. The number of received data items exceeds 512 bytes.		
11	The number of transmission data items is not correct. The number of 4XXXX+1 exceeds 512.		
10	Remote devices are not connected to the specified port. DSR (data set ready) on the specified port is not turned off.		
9	Port No. is not correct. Port No. other than 1 to 4 is specified.		
8	IOP or COMM on the specified port is defective.		
7	Received response address and function code are not proper for transmission query message. (It occurs only in MEMOBUS mode.)		
6	No allocation		
5*	P150 is connected to the specified port. This is when data is received from PP at command execution.		
4	No allocation		
3	Port No.	1	IOP, upper port
2		2	IOP, lower port
1		3	COMM, upper port
0		4	COMM, lower port

Note: Bits 4 to 15 excluding 5 are modified at every command execution.

* The error must be forced to clear before command execution when bit 5 is set. Otherwise the command will not be executed when execution command is ON. This bit is set when the port is connected with master unit such as P150. Therefore, do not connect the port for activating COMM command with P150.

4.5 CONTROL BLOCK (Cont'd)

(2) Number of Transmission Data Items (4XXXX + 1)

The number of bytes (number of characters) of query message to be transmitted is specified. The range of n is from 1 to 512 (10).

n	Number of Transmission Buffer Registers
Even	n/2 registers
Odd	(n+1)/2 registers

When command is activated by setting a value out of the specified range, an error occurs immediately and the command is not executed.

(3) Number of Received Data Items (4XXXX + 1)

The number of bytes (number of characters) of the query message to be transmitted is specified and the number is set by CPU (control panel unit) with normal completion after the command execution. The range of m value to be written in the register is from 0 to 512 (10). When the command is activated, the number of received data items is cleared to 0.

n	Number of Transmission Buffer Registers
Even	m/2 registers
Odd	(m+1)/2 registers

(4) Flag (4XXXX + 3)

Command execution status is indicated.

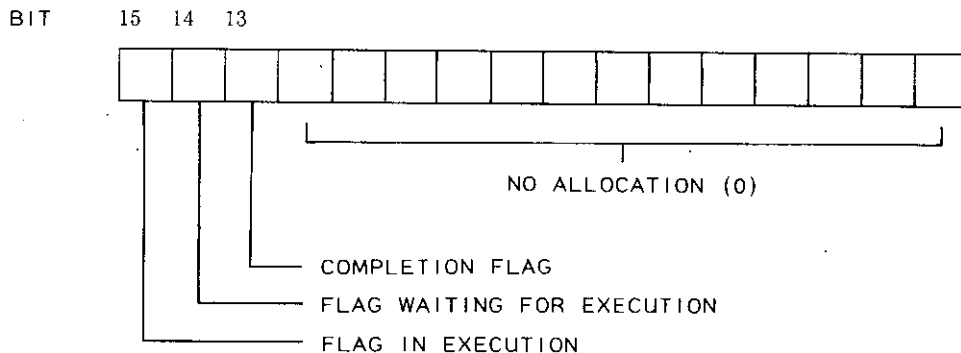

Table 4.2 Allocation of 4XXXX + 3 Bit

Bit No.	Contents
15	This bit becomes 1 during execution. However, it does not become 1 when the execution is not activated though input 1 is accepted, since it is interlocked with output 1.
14	1 is set when the command has been activated but not executed yet. Waiting status is indicated when more than one COMM command is activated.
13	Completion of command execution is indicated. 1 is set to 1 scan by either normal completion or forced completion with error.
12 to 0	No allocation, always set at 0.

More than two bits from 13 to 15 can not be set at 1.

4.6 DEFINITION OF INPUT/OUTPUT

(1) Input 1: execution command

COMM command execution is instructed by input 1: ON, and input 3: OFF. Output 1 becomes ON when input 1 is accepted and the execution is started.

Note that differential contact must be used for input 1. COMM command execution is started again if this input is ON at completion of operation.

(2) Input 2: mode designation

Either transmission/receiving mode or transmission mode can be specified by input 2.

ON Transmission mode
 OFF ... Transmission/receiving mode

In transmission mode, only transmission is performed and response from the remote unit is not required. The transmission mode is used when the remote unit is a printer, etc.

In transmission/receiving mode transmission from port is performed and then a response is waited from the remote unit. If a response is not obtained from the remote unit, waiting status will be provided and the command is completed; perform time-out process by application.

This input is checked when COMM command is activated.

4.6 DEFINITION OF INPUT/OUTPUT (Cont'd)

(3) Input 3: command abort

COMM command during execution is aborted. When this input is ON, three inputs become OFF and have priority over other inputs.

It is used for aborting command of time-out process in transmission/receiving mode. Status error bits, excluding bit 5, are all cleared (see Fig. 4.1).

Note that differential contact must be used for the input in normal operation. Even if input 1 is ON, the COMM command is not executed while input 3 is ON.

* Command execution conditions

- Input 1 goes ON from OFF.
- Input 3 is OFF. (The specified port is not operating.)

(4) Output 1: during execution

When input 1 is accepted and COMM command execution is started, output 1 is ON. When the operation is completed or aborted, it goes OFF.

It will be OFF when an error occurs during COMM command execution.

(5) Output 2: error

Only 1 scan is ON when COMM command execution is completed by an error. Error bits of status contains their own contents as shown in Table 4.1.

(6) Output 3: operation completion

Only 1 scan is ON when the operation is completed normally by COMM command. All status error bits become 0.

5. APPLICATION EXAMPLE

5.1 MEMOBUS MASTER

A message example that reads out the contents of the holding register with GL60S as MEMOBUS master unit is shown. At this time, transmission is set in MEMOBUS mode.

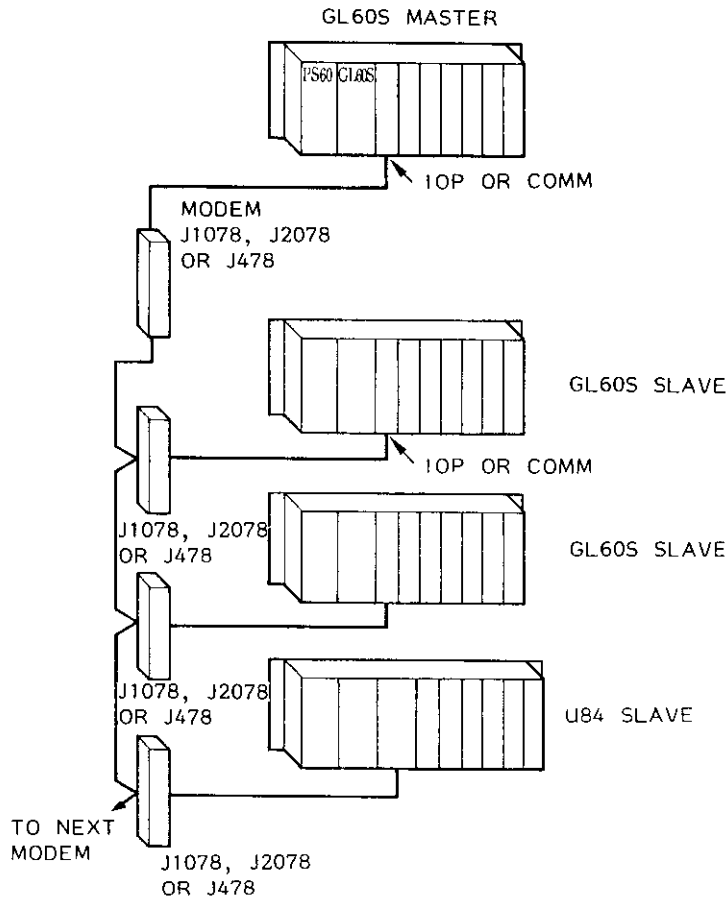

Fig. 5.1 GL60S Master Unit Configuration

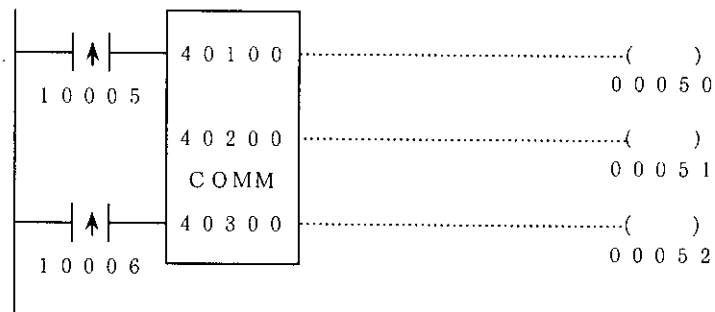

Fig. 5.2 Example of Communication Circuit

The data to be stored in each register in this example are shown below.

5.1 MEMOBUS MASTER (Cont'd)

(1) Control Block

40100	0002 (Port No.)
40101	0006 (Number of transmission data items)

The values are in decimal.

No value is set to register 40102 for the number of received data items and register 40103 for flag. Communication is performed on the IOP lower port since the port No. is 2. The number of transmission data items is 6. This value depends on the command message to be stored in the transmission buffer.

(2) Transmission Buffer

The number of registers required as a transmission buffer is 3 since the number of transmission data items is 6. Accordingly, registers 40200 to 40202 are used as transmission buffers.

In this example, the contents of GL60S holding registers 40108 to 40110 are read out by slave address.

CRC is not needed since IOP is added automatically.

40200	02H (Slave address)	03H (Function code)	
40201	00H	6BH	... START NO. (107)
40202	00H	03H	... NUMBER OF HOLD- ING REGISTERS (3)

The values are in hexadecimal.

When the slave is U84, U84S or 584, register reference to be read out is any of 40108 to 40110 as GL60S. For R84H-M or GL20, it is 4108 to 4110.

(3) Receiving Buffer

Response messages from the slave are stored in registers 40300 to 40304. When there are nine received data items, the content of register 40102 for the number of received data items becomes 9.

However, the lower 8 bits of the last register 40304 are not received data; the number becomes 0. (See Fig. 4.4.)

40300	02H	03H
40301	06H	02H
40302	2BH	00H
40303	00H	00H
40304	63H	00H

The values are in hexadecimal.

(4) Operation

- ① 10005 goes OFF from ON. At this time, coil 50 is ON and communication to the specified slave unit are performed unless the COMM command to the same port is not operating.
- ② One scan of coil 52 is ON when response message receiving is completed.

5.2 TRANSMISSION TO ASCII DEVICES

Data transmission to ASCII devices (a printer in this example) is described here. Suppose the character lines in Fig. 5.4 are to be printed.

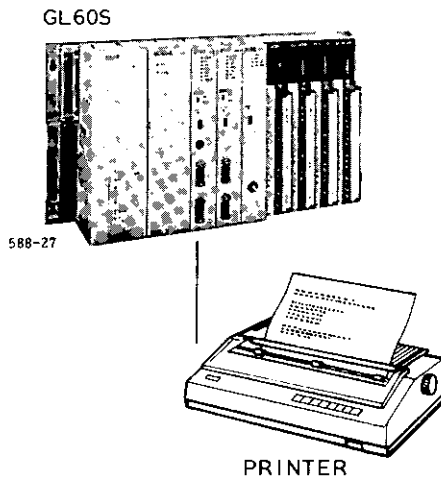

Fig. 5.3 Connection with Printer

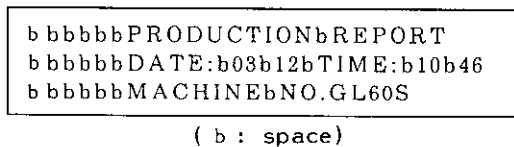

Fig. 5.4 Example of Printing

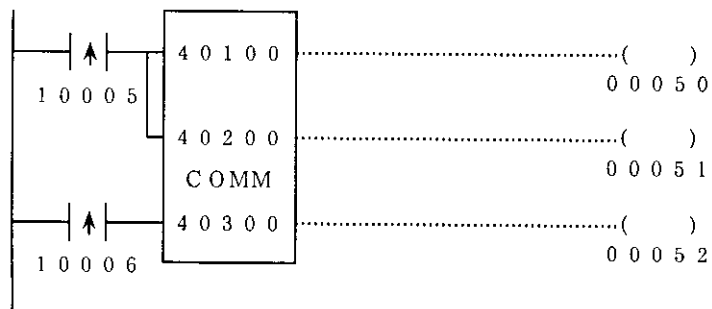

Fig. 5.5 Example of Communication Circuit

The following shows data to be stored in each register in this example.

5.2 TRANSMISSION TO ASCII DEVICES (Cont'd)

(1) Control Block

40100	0003 (Port No.)
40101	0077 (Number of transmission data items)

The values are in decimal.

No value is set to register 40103 for flag and register 40102. The number of transmission data items includes "CR" and "LF" in each line.

(2) Transmission Buffer

The number of registers required as a transmission buffer is 39 since the number of transmission data items is 77. Accordingly, registers 40200 to 40238 are used as transmission buffers.

40200	20H	20H
40201	20H	20H
40202	20H	50H (P)
40203	52H (R)	4FH (O)
40204	44H (D)	55H (U)
40205	43H (C)	54H (T)
40206	49H (I)	4FH (O)
40207	4EH (N)	20H
40208	52H (R)	45H (E)
40209	50H (P)	4FH (O)
40210	52H (R)	54H (T)
40211	0DH (CR)	0AH (LF)
40212	20H	20H
40213	20H	20H
40214	20H	44H (D)
40215	41H (A)	54H (T)
40216	45H (E)	3AH (:)
40217	20H	30H (0)
40218	33H (3)	20H
40219	31H (1)	32H (2)
40220	20H	54H (T)
40221	49H (I)	4DH (M)
40222	45H (E)	3AH (:)
40223	20H	31H (1)
40224	30H (0)	20H
40225	34H (4)	36H (6)
40226	0DH (CR)	0AH (LF)
40227	20H	20H
40228	20H	20H
40229	20H	4DH (M)
40230	41H (A)	43H (C)
40231	48H (H)	49H (I)
40232	4EH (N)	45H (E)
40233	20H	4EH (N)
40234	4FH (O)	2EH (.)
40235	20H	47H (G)
40236	4CH (L)	36H (6)
40237	30H (0)	53H (S)
40238	0DH (CR)	0AH (LF)

The values are in hexadecimal.

(3) Receiving Buffer

There is no received data. Therefore, a receiving buffer is not necessary in this case. However, in COMM command, temporary designation is performed in the bottom element. Register 40300 in this example is not used in actual COMM command.

(4) Operation

- ① 10005 goes OFF from ON. At this time, coil 50 is ON and the printing in Fig. 5.4 is performed unless COMM command to the same port is not operating.
- ② One scan of coil 52 is ON when printing is completed.

6. PRECAUTIONS FOR USE

For communication by using COMM command, follow the precautions below.

- ① In transmission/receiving mode, response waiting status is provided when no response returns from the remote unit. The waiting status can be released by input 3.
- ② After command activation, if any of the following occurs, the COMM command execution is aborted.
 - Transmission data are changed.
 - Register contents of control block are changed.
 - Network including activated COMM command are skipped.
 - Activated COMM command is changed from P150.
- ③ When input goes ON from OFF, the command execution is started. However, if the port has COMM command in execution, a command executed later is in the waiting status and then executed when the former COMM command is completed.
- ④ Control input for command activation is by differential signals.
- ⑤ When data required in the specified COMM command are set to registers by arithmetic operation command, etc., it must be performed with differential signals before COMM command is activated. If using level signals, trouble, such as change of unexpected register (contents) not prepared in item ② above may occur.
- ⑥ When data are sent to the slave unit by simultaneous MEMOBUS broadcasting, communication is performed in the transmission mode. At this time do not activate more than one COMM command simultaneously to the port. The slave side cannot receive the data properly since the MEMOBUS command interval becomes shorter than the specified value.
- ⑦ When more than one COMM command is activated and one is aborted during execution, the same error as ⑥ may occur.
- ⑧ Do not connect any master unit such as P150 with the port used as the master port; the port may hang up. Should this happen, stop the COMM command activating the port by using RAP, etc.

7. CABLES

Connect IOP or COMM and the remote unit after carefully checking the connection specifications of the remote unit. The following are cables meeting YASKAWA standards. Other cables to be used are supplied by the customers.

(1) SC Connection Cables

Connection cables for communication with GL60S or with U84 or U84S are as follows.

Note: In Tables 7.1 to 7.7, the meanings of abbreviations are as follows:

1	PGND	protection ground	5	CTS	clear to send
2	TXD	transmission data	6	DSR	data set ready
3	RXD	received data	7	SGND	signal ground
4	RTS	request to send	8	CD	carrier detection
			9, 20	DTR	data terminal ready

Cable Type	Length
JZMSZ-W1019-1	5 m
JZMSZ-W1019-2	15 m

Table 7.1 Connection of JZMSZ-W1019





Pin No.	Signal Name	Direction	Pin No.	Signal Name	Color
1	PGND	↔	1	PGND	Brown
2	TXD	→	3	RXD	Orange/red
3	RXD	←	2	TXD	Red/orange
4	RTS		4	RTS	
5	CTS		5	CTS	
6	DSR	→	9	DTR	White/blue
9	DTR	←	6	DSR	Blue/white
7	SGND	↔	7	SGND	Black

(2) ASCII Device Connection Cables

Standard cable JZMSZ-W1018 is provided for connection with ASCII devices.

Cable Type	Length
JZMSZ-W1018-1	5 m
JZMSZ-W1018-2	15 m

Table 7.2 Connection of JZMSZ-W1018

IOP, COMM Side		Direction	ASCII Device Side		Color
Pin No.	Signal Name		Pin No.	Signal Name	
1	PGND	↔	1	PGND	Brown
2	TXD	→	3	RXD	Red
3	RXD	←	2	TXD	Orange
			4	RTS	
			5	CTS	
5	CTS	↔	6	DSR	Green
			20	DTR	
6	DSR	←			
9	DTR				
7	SGND	↔	7	SGND	Black

7. CABLES (Cont'd)

(3) Modem Connection Cables

When the connection distance of the communication circuit exceeds 15 m, or when more than one slave unit is used in MEMOBUS system, modem is required.

Table 7.3 Modem Connection Cables

Cable Type JZMSZ-	Application	Modem	Length
W1007-1	For ASCII device	DISCT-J478	5 m
W1007-T1	For ASCII device	DISCT-J1078	5 m
W1008-1	For ASCII device	DISCT-J478	5 m
W1008-T1	For ASCII device	DISCT-J1078	5 m
W1017-1	For MEMOBUS	DISCT-J478	5 m
W1017-2	For MEMOBUS	DISCT-J478	15 m
W1017-T1	For MEMOBUS	DISCT-J1078	5 m
W1017-T2	For MEMOBUS	DISCT-J1078	15 m
W2020-1	For MEMOBUS	DISCT-J2078	2.5 m
W2020-2	For MEMOBUS	DISCT-J2078	5 m
W2020-3	For MEMOBUS	DISCT-J2078	10 m
W2020-4	For MEMOBUS	DISCT-J2078	15 m

Table 7.4 JZMSZ-W1007 Connection

IOP, COMM Side		Direction	ASCII Device Side		Color
Pin No.	Signal Name		Pin No.	Signal Name	
1	PGND	↔	1	PGND	Brown
2	TXD	→	2	TXD	Red
3	RXD	←	3	RXD	Orange
4	RTS	→	4	RTS	Yellow
9	DTR	→	20	DTR	White
5	CTS	←	8	CD	Green
6	DSR	←	6	DSR	Blue
7	SGND	↔	7	SGND	Black

Table 7.5 JZMSZ-W1008 Connection

IOP, COMM Side		Direction	ASCII Device Side		Color
Pin No.	Signal Name		Pin No.	Signal Name	
1	PGND	↔	1	PGND	
2	TXD	→	2	TXD	Red
3	RXD	←	3	RXD	Orange
		↪	4	RTS	
			5	CTS	
4	RTS	↪			
20	DTR	↪	20	DTR	Brown
6	DSR	→	6	DSR	Blue
7	SGND	↔	7	SGND	White

Table 7.6 JZMSZ-W1017 Connection

IOP, COMM Side		Direction	ASCII Device Side		Color
Pin No.	Signal Name		Pin No.	Signal Name	
1	PGND	↔	1	PGND	Brown
2	TXD	→	2	TXD	Red
3	RXD	←	3	RXD	Orange
4	RTS	→	4	RTS	Yellow
5	CTS	←	5	CTS	Green
6	DSR	←	6	DSR	Blue
9	DTR	→	20	DTR	White
7	SGND	↔	7	SGND	Black

Table 7.7 JZMSZ-W2020 Connection

IOP, COMM Side		Direction	Modem Side		Color
Pin No.	Signal Name		Pin No.	Signal Name	
1	PGND	↔	1	PGND	Brown
2	TXD	→	2	TXD	Red
3	RXD	←	3	RXD	Orange
4	RTS	→	4	RTS	Yellow
5	CTS	←	5	CTS	Green
6	DSR	←	6	DSR	Blue
9	DTR	→	9	DTR	White
7	SGND	↔	7	SGND	Black

(4) Modem-to-modem Connection Cables

For modem-to-modem (DISCT-J478, DISCT-J1078, DISCT-J2078) connection, two-core twisted cables (RG-108/U or equivalent) must be used.



A Better Tomorrow for Industry through Automation

YASKAWA Electric Mfg. Co., Ltd.

TOKYO OFFICE Ohtemachi Bldg. 1-6-1 Ohtemachi, Chiyoda-ku, Tokyo, 100 Japan
Phone (03) 284-9111, -9145 Telex YASKAWA J33530 Fax (03) 284-9034

SEOUL OFFICE Sepul Center Bldg., 91-1, So Kong-Dong, Chung-Ku, Seoul, Korea
Phone (02) 776-7844 Fax (02) 753-2639

SINGAPORE OFFICE CPF Bldg., 79 Robinson Road No. 24-03, Singapore 0106
Phone 2217530 Telex (87) 24890 YASKAWA RS Fax (65) 224-5854

TAIPEI OFFICE Union Commercial Bldg., 137, Nanking East Road, Sec. 2, Taipei, Taiwan
Phone (02) 507-7065, -7732 Fax (02) 506-3837

YASKAWA ELECTRIC AMERICA, INC.: SUBSIDIARY

Chicago Office (Head Office) 3160 MacArthur Blvd., Northbrook, Illinois 60062-1917, U.S.A.
Phone (312) 291-2340 Telex (230) 270197 YSKW YSNC NBRK Fax (312) 498-2430

Los Angeles Office 7341 Lincoln Way, Garden Grove, California 92641, U.S.A.
Phone (714) 894-5911 Telex (230) 678396 YASKAWAUS TSTN Fax (714) 894-3258

New Jersey Office 30 Two Bridges Road, Fairfield, New Jersey 07006, U.S.A.
Phone (201) 575-5940 Fax (201) 575-5947

YASKAWA ELECTRIC EUROPE GmbH: SUBSIDIARY

Monschauerstrasse 1, 4000 Düsseldorf 11, West Germany
Phone (0211) 501127 Telex (41) 8588673 YASD D Fax (0211) 507737

YASKAWA ELÉTRICO DO BRASIL COMÉRCIO LTDA.: SUBSIDIARY

Av. Brig. Faria Lima, 1664-cj. 721/724, Pinheiros, São Paulo-SP, Brasil CEP-01452
Phone (011) 813-3933, 813-3694 Telex (011) 39881 TAFE-BR

Due to ongoing product modification/improvement, data subject to change without notice.