

Machine Controller MP900 Series MPLoader (Server) USER'S MANUAL

FOR SERVER

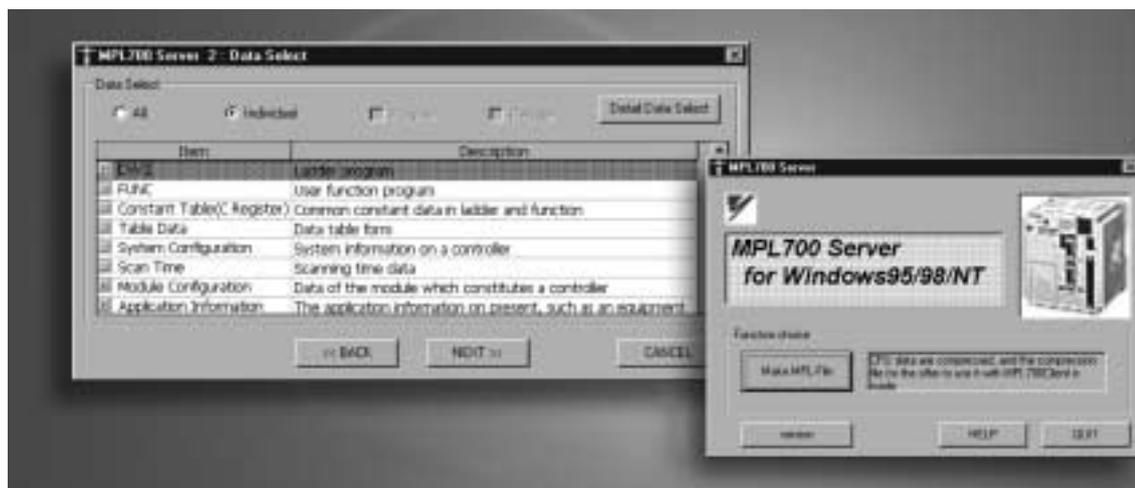

YASKAWA

MANUAL NO. SIEZ-C887-12.1

CONTENTS

About This Manual	iii
About The Software	iv
Visual Aids	iv
Related Manuals	v
1 OVERVIEW	
1.1 Overview of MPLoader Products	1-2
1.1.1 Products	1-2
1.1.2 Operating Environment	1-2
1.1.3 Applicable Models and Communications Format	1-2
1.1.4 Product Configuration	1-3
1.2 Overview of MPL700 Functions	1-4
1.2.1 Functions	1-4
1.2.2 Overall Flow	1-4
1.2.3 Connection Methods	1-5
1.2.4 Software Functions	1-6
2 INSTALLATION	
2.1 Installation Procedure	2-2
2.2 Uninstallation Procedure	2-7
3 STARTING AND SCREEN OPERATIONS	
3.1 Startup and Operating Procedure	3-2
3.2 Main Window	3-4
3.3 CPU Selection Window	3-6
3.4 Data Selection Window	3-10
3.5 Option Window	3-13
3.6 Save As Window	3-17
3.7 Completion Notification Dialog Box	3-19
APPENDIX A	
A.1 List of Errors	A-2

Overview

1.1 Overview of MPLoader Products	1-2
1.1.1 Products	1-2
1.1.2 Operating Environment	1-2
1.1.3 Applicable Models and Communications Format	1-2
1.1.4 Product Configuration	1-3
1.2 Overview of MPL700 Functions	1-4
1.2.1 Functions	1-4
1.2.2 Overall Flow	1-4
1.2.3 Connection Methods	1-5
1.2.4 Software Functions	1-6

1.1 Overview of MPLoader Products

1.1.1 Products

MPLoader is a software package for easily making changes to definition files, application programs, and register data for MP900-series Machine Controllers, without using the CP-717.

MPLoader consists of 2 software products. Use the appropriate software for the purpose. The names and applications of the products are given below.

Product Name	Application
MPL700Server	Software for creating compressed files from files created in the CP-717 environment. (See note.)
MPL700Client	Software for loading compressed files created with the MPL700Server to a CPU Module. CP-717 data can also be loaded to CPU Modules in PLC (CPU) folder units.

Note: The compressed files created with the MPL700Server are used with the MPL700Client.

1.1.2 Operating Environment

MPLoader can be used on computers that have Windows 95, Windows 98, or Windows NT4.0 installed and satisfy the following conditions.

Item	Specification
CPU	Pentium 133 MHz or better
RAM	32 Mbytes min.
Hard disk	The following disk space is required for installation. <ul style="list-style-type: none"> • MPL700Server Software installation: 20 Mbytes • MPL700Client Software installation: 20 Mbytes
Resolution	640 × 480 min.

1.1.3 Applicable Models and Communications Format

The MPLoader supports the following models and communications formats:

- Models: MP900-series Controllers (not including MP910)
- Communications: Serial communications, Ethernet (not including relay or duplex)

1.1.4 Product Configuration

MPLoader consists of 2 software applications.

The contents of the CD-ROM for each application are as follows.

■ MPL700Server

- MPL700Server Setup Software (Japanese)
- MPL700Server Setup Software (English)
- Japanese User's Manual (PDF)
- English User's Manual (PDF)

■ MPL700Client

- MPL700Client Setup Software (Japanese)
- MPL700Client Setup Software (English)
- Japanese User's Manual (PDF)
- English User's Manual (PDF)

1.2 Overview of MPL700 Functions

1.2.1 Functions

This software is a tool for smooth, easy loading of updated application programs to the end-user environment without using the CP-717. It does not have the CP-717 functions for system definitions, programming, and monitoring.

The application provider sends the application to the end user as a compressed file. The end user can load the application to the required Controller from the MPL700 Software by specifying the compressed file received.

1.2.2 Overall Flow

The flow of data is shown below up to the point where the updated application program is loaded to the end-user environment (CPU Module) using the MPL700 (MPL700Server or MPL700Client).

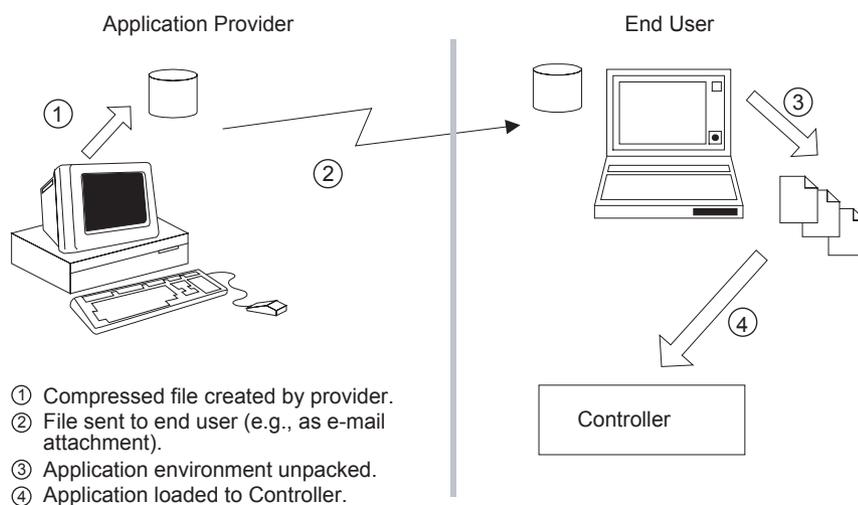

Fig. 1.1 Overall Flow

The MPL700 supports stages 1, 3, and 4 in Figure 1.1.

MPL700Server is used to create compressed files at the provider end in stage 1.

MPL700Client is used in stages 3 and 4.



The file transfer in stage 2 is performed, for example, via a network or using a removable disk and is not supported by the MPL700 Software.

1.2.3 Connection Methods

MP900-series Machine Controllers can be connected to a computer in the ways shown below.

■ One-to-one Serial Connection

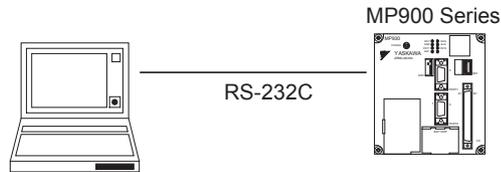

■ One-to-N Serial Connection

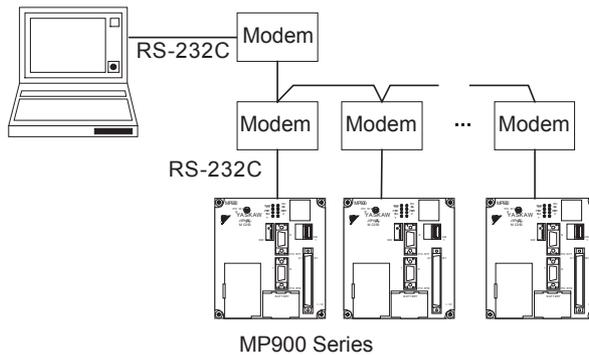

■ Ethernet Connection

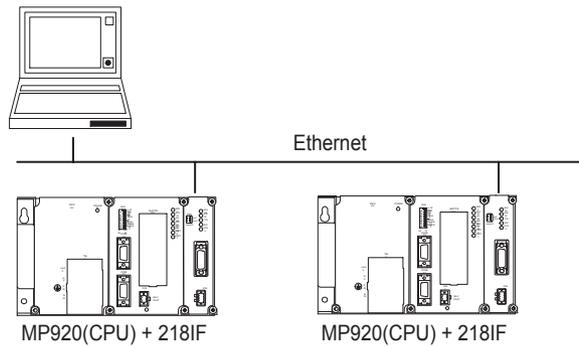

1.2.4 Software Functions

The software functions of the MPL700Server and the MPL700Client are explained below.

■ List of MPL700Server Functions

Function	Details
Environment specification	Specify the PLC environment created with the CP-717.
Log-on information specification	Input a user name and password.
Optional settings	Make settings for the loading operation.
Index file creation	Create files containing information about the range (e.g., diagram "H" only) loaded to the target Controller.
Compressed file creation	Compress the environment and index files. (Extension for loaded files: .MPL)

IMPORTANT

The PLC environment created with the CP-717 must be on the hard disk where the MPL700Server Software is used.

■ List of MPL700Client Functions

Function	Details
Environment unpacking	Unpack the files (.MPL) created with the MPL700Server and create an environment for loading to the Controller.
Loading information display	Display the files to be loaded as a list based on the index file.
Load ^{*1}	Perform transfer processing for the files specified with the index file.
Backup	Dump and back up the Controller environment prior to loading.
Log-on	Automatically log on using the information specified at the server.
PLC type check	Checks the loading environments and the types of PLC connected.
PLC selection	Select the target PLC if there is more than one PLC connected.
Communications format selection	Select either serial or Ethernet.
CPU operation	Send a command to stop the CPU when loading.
Writing to flash	Write to flash memory.
CPU folder data transfer ^{*2}	Function for transferring all data from CPU folders together.

* 1. The CP-717 does not have to be installed in the environment where the MPL700Client Software is used.

* 2. The data loading methods for the MPL700Client are as follows.

Method	Provider	File Provided	Transfer Method	Functional Restrictions
1	MPL700Server	Compressed files created from the CP-717 PLC environment (.MPL)	All/individual	---
2	CP-717	PLC folder transferred from hard disk to floppy disk with CP-717, or another media device to which the whole PLC folder is copied.	All	No display of transfer data information

The server-client transfer methods and the flow of data are shown in the diagram below.

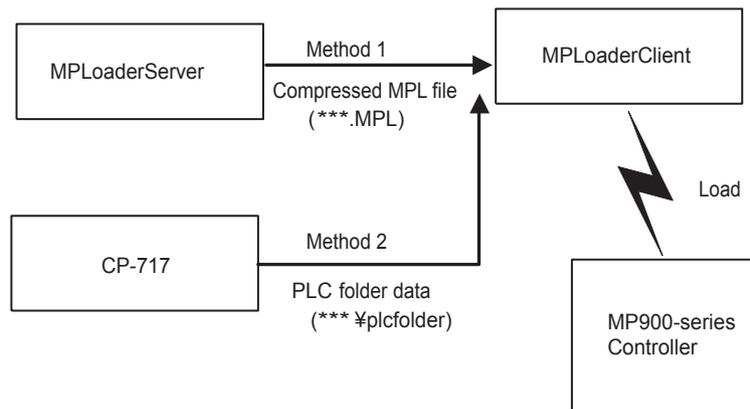

Fig. 1.2 Server-Client Transfer Methods and Flow of Data

2



Installation

This chapter explains how to install the MPL700Server.

2.1 Installation Procedure	-----2-2
2.2 Uninstallation Procedure	-----2-7

2.1 Installation Procedure

Insert the MPL700Server's CD-ROM into the computer's CD-ROM drive and follow the procedure given below.

1. Start up **SETUP.EXE** from the installation disk.

The window shown below will be displayed along with the MPL700Server logo. Wait while the progress bar fills up.

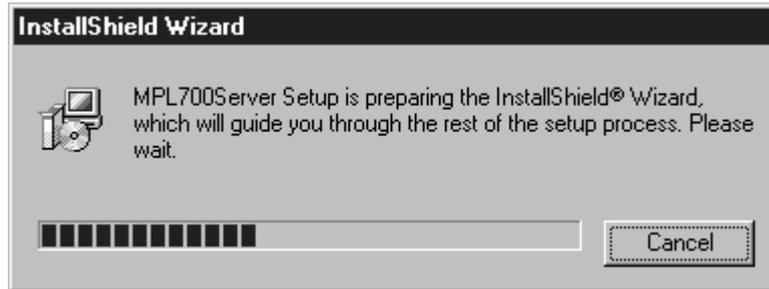

2. When the following window is displayed, click the **NEXT** Button.



Click the **Cancel** Button to terminate installation. If the **Cancel** Button is clicked, a dialog box confirming termination is displayed.

3. A window for selecting the installation destination is displayed as shown below. Select the installation destination. After making the selection, click the **NEXT** Button.

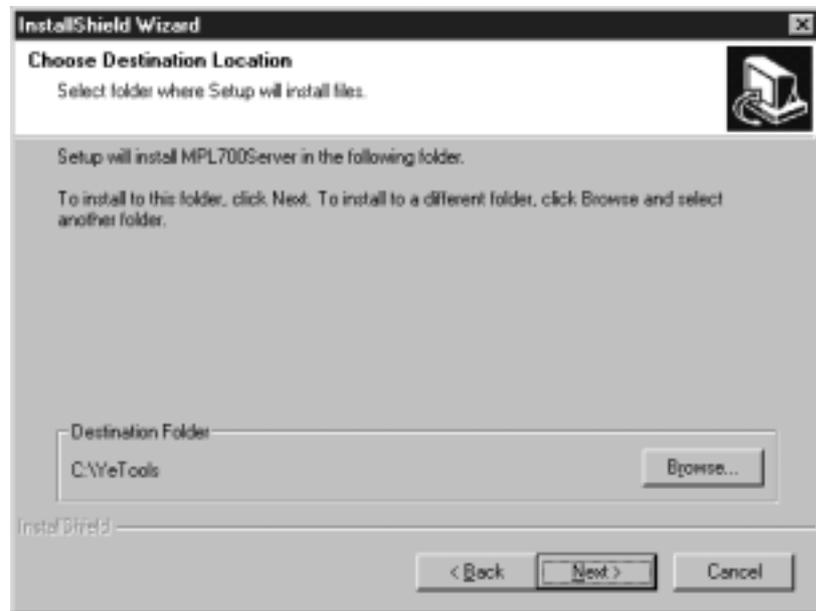

- If the **Browse** Button is clicked, a dialog box for selecting the installation destination path is displayed.

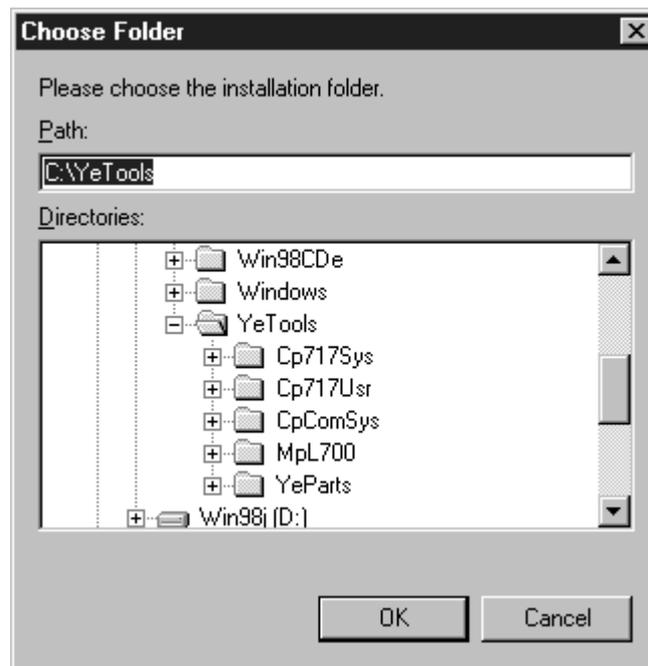

Note: After inputting an installation path, click the **OK** Button to return to the previous window. Clicking the **Cancel** Button will clear the input path. If the required folder in the tree display section is clicked, the path to that folder will be set automatically.

- Click the **Back** Button to return to the previous window. Click the **Cancel** Button to terminate installation.
- If the **Cancel** Button is clicked, a dialog box confirming termination is displayed. After selecting the installation destination, click the **NEXT** Button.

4. When the following window is displayed, select the program folder. Either create a new folder or use an existing folder. The default selection is *YE_Applications*. Perform installation processing after selecting the program folder. After making the selection, click the **NEXT** Button.

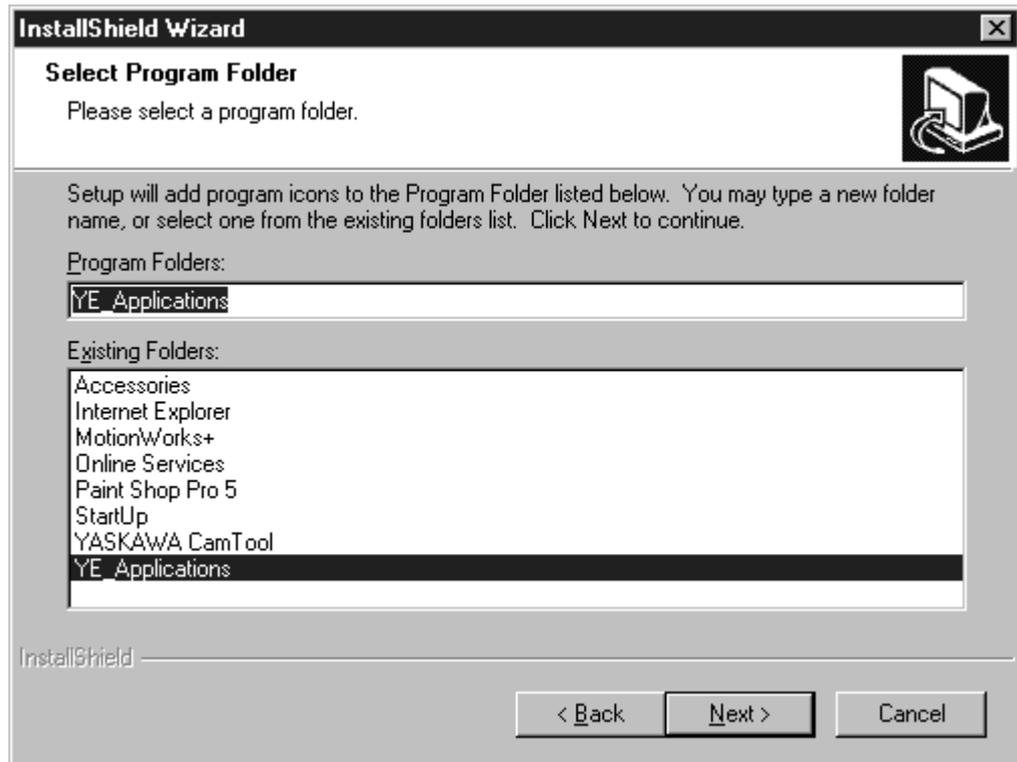

- Click the **Back** Button to return to the previous window.
- Click the **Cancel** Button to terminate installation. If the **Cancel** Button is clicked, a dialog box confirming termination is displayed.

5. Installation is executed. The window displayed during installation is shown below. It shows the installation progress. When the progress bar is full, installation has been completed.

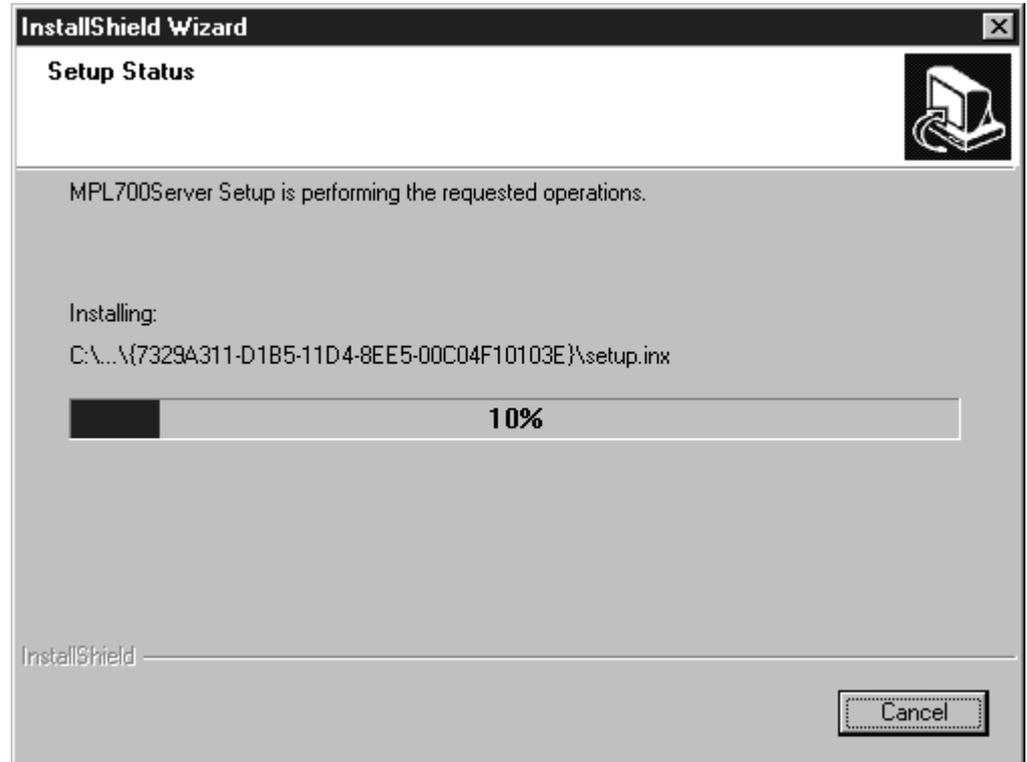

- Before the window shown above is displayed, the window shown below is displayed briefly. This window does not indicate that the program has stopped. The window will soon be replaced with the one shown above.

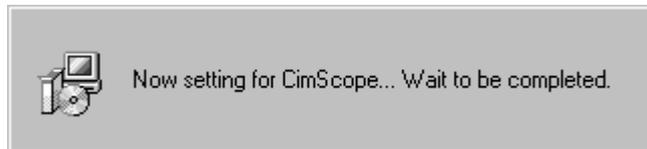

- Click the **Cancel** Button to terminate installation. If the **Cancel** Button is clicked, a dialog box confirming termination is displayed.

6. A window indicating that installation has been completed is displayed. Click the **Finish** Button to complete the installation procedure.

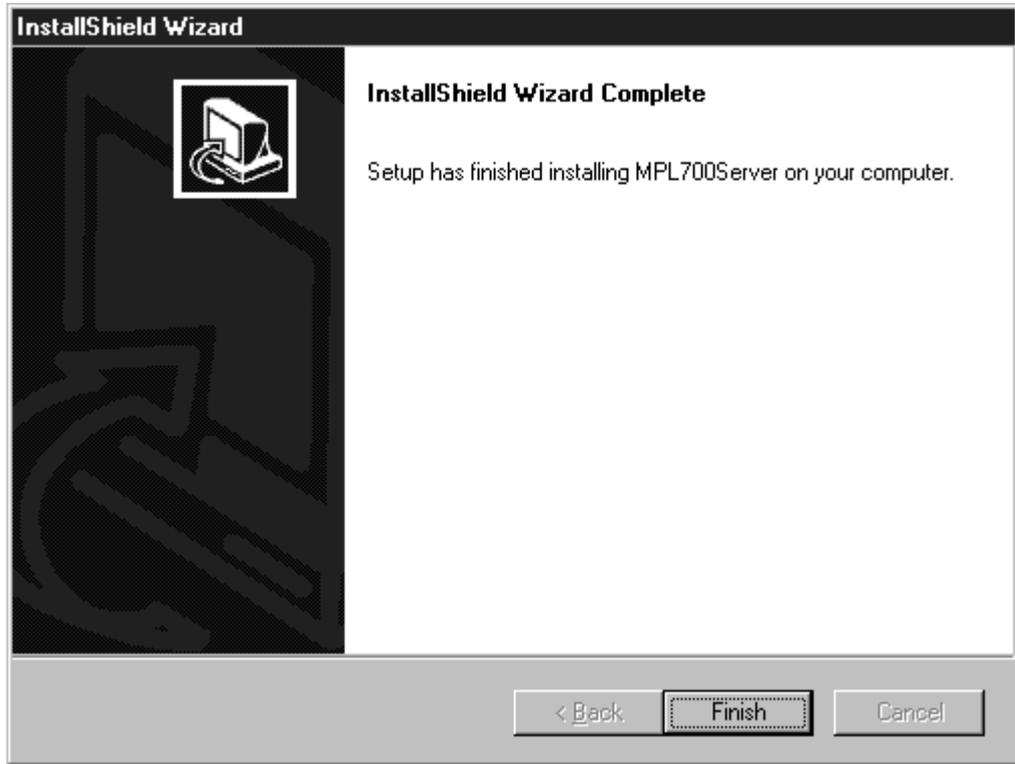

- Before the window shown above is displayed, the window shown below, advising the user to install Acrobat Reader, may be displayed. If it is, after completing the MPL700Server installation program, install Acrobat Reader from the MPL700Server installation disk.

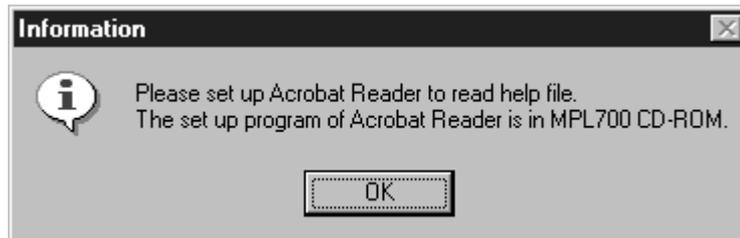

- For Acrobat Reader installation, double-click **Ar405eng.exe** in the Manual-Reader folder of the MPL700Server's CD-ROM, on the Windows Explorer.
- For details on how to use Acrobat Reader, refer to the Acrobat Reader's online help.

2.2 Uninstallation Procedure

Insert the MPL700Server's CD-ROM into the CD-ROM drive of the computer with MPL700Server installed and follow the procedure given below.

1. Start up **SETUPEXE** from the installation disk.

The window shown below will be displayed along with the MPL700Server logo. Wait while the progress bar fills up.

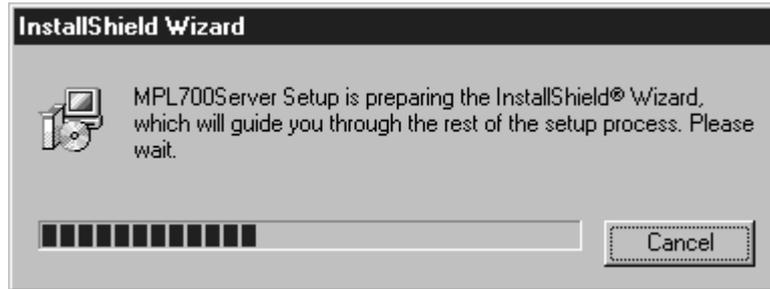

2. When the following window is displayed, click the **NEXT** Button.

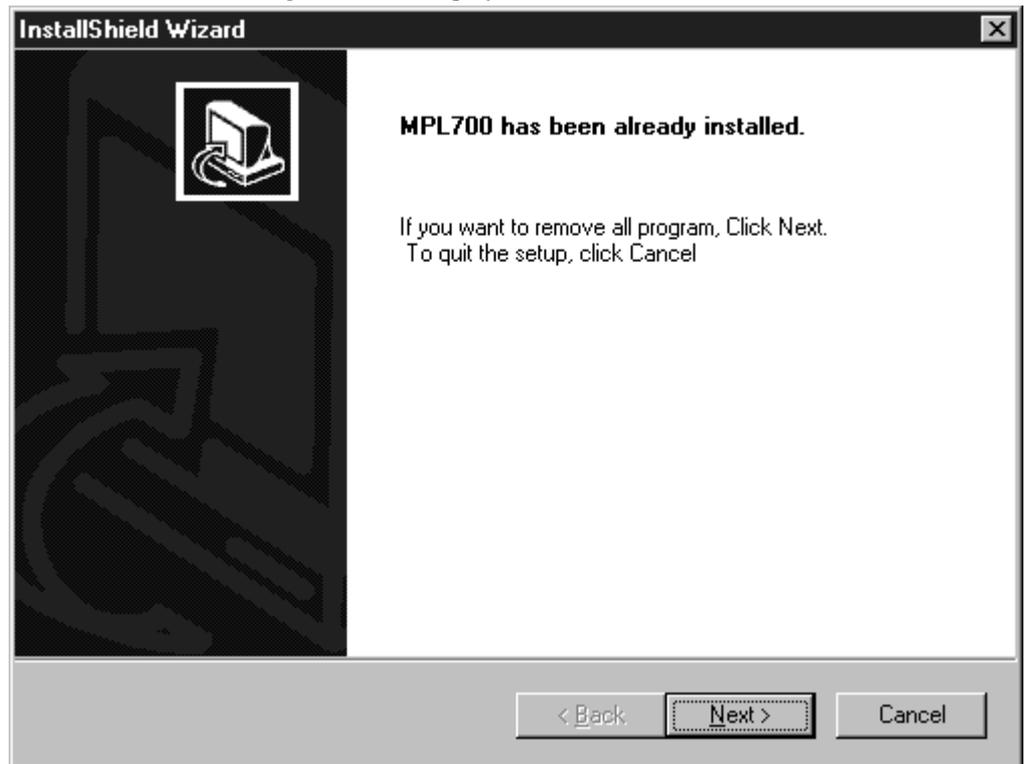

Click the **Cancel** Button to terminate the uninstallation procedure. If the **Cancel** Button is clicked, a dialog box confirming termination is displayed.

3. The window shown below is displayed and uninstallation is executed. The state of progress of uninstallation is displayed in the progress bar.

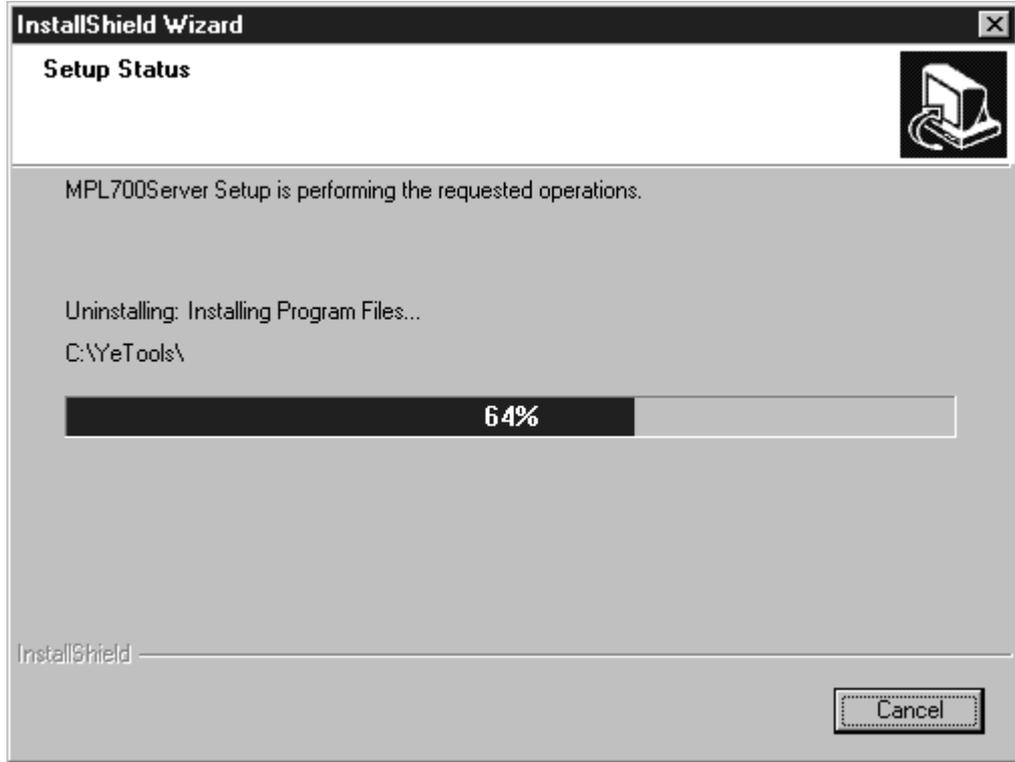

Click the **Cancel** Button to cancel the uninstallation procedure. If the **Cancel** Button is clicked, a dialog box confirming termination is displayed.

IMPORTANT

If the uninstallation procedure is cancelled before completion, the MPL700Server icon may remain in the program folder. MPL700Server operation, however, cannot be guaranteed in this state. To use MPL700Server, repeat the uninstallation procedure until completion, and then re-install the MPL700Server.

4. A window indicating completion of the uninstallation procedure is displayed. Click the **Finish** Button to complete the uninstallation procedure.

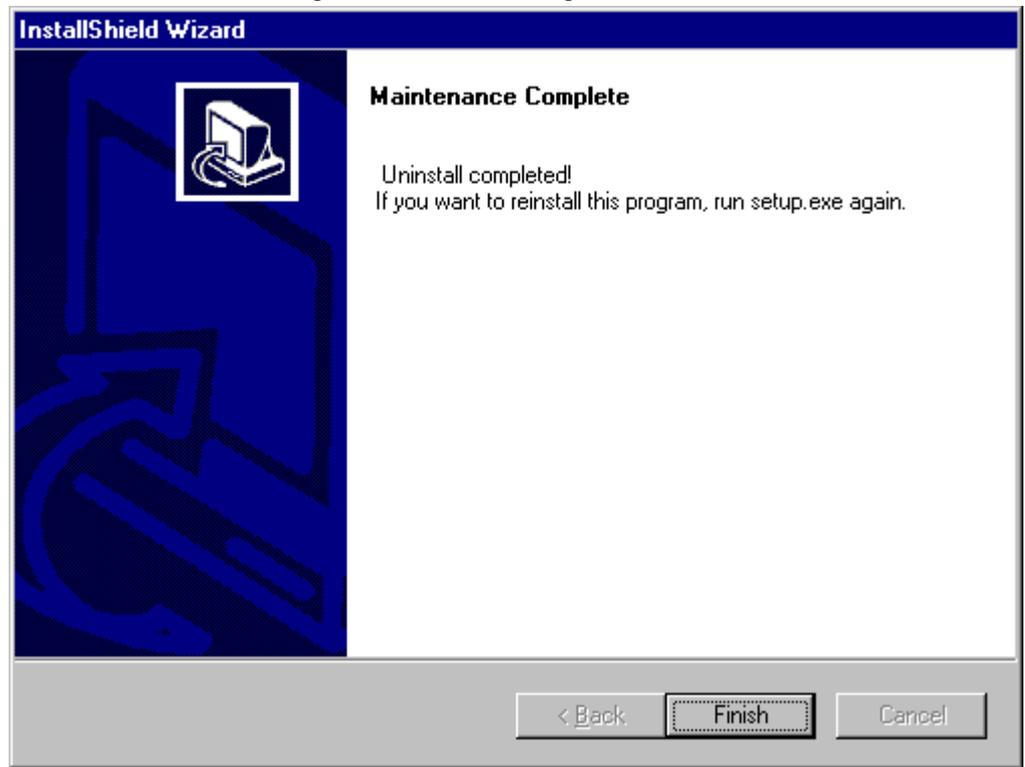

Starting and Screen Operations

This chapter explains how to start up the MPL700Server and perform screen operations.

3.1 Startup and Operating Procedure	3-2
3.2 Main Window	3-4
3.3 CPU Selection Window	3-6
3.4 Data Selection Window	3-10
3.5 Option Window	3-13
3.6 Save As Window	3-17
3.7 Completion Notification Dialog Box	3-19

3.1 Startup and Operating Procedure

The procedures required to go from MPL700Server startup to the creation of compressed files are explained below.

The operating procedure is shown below.

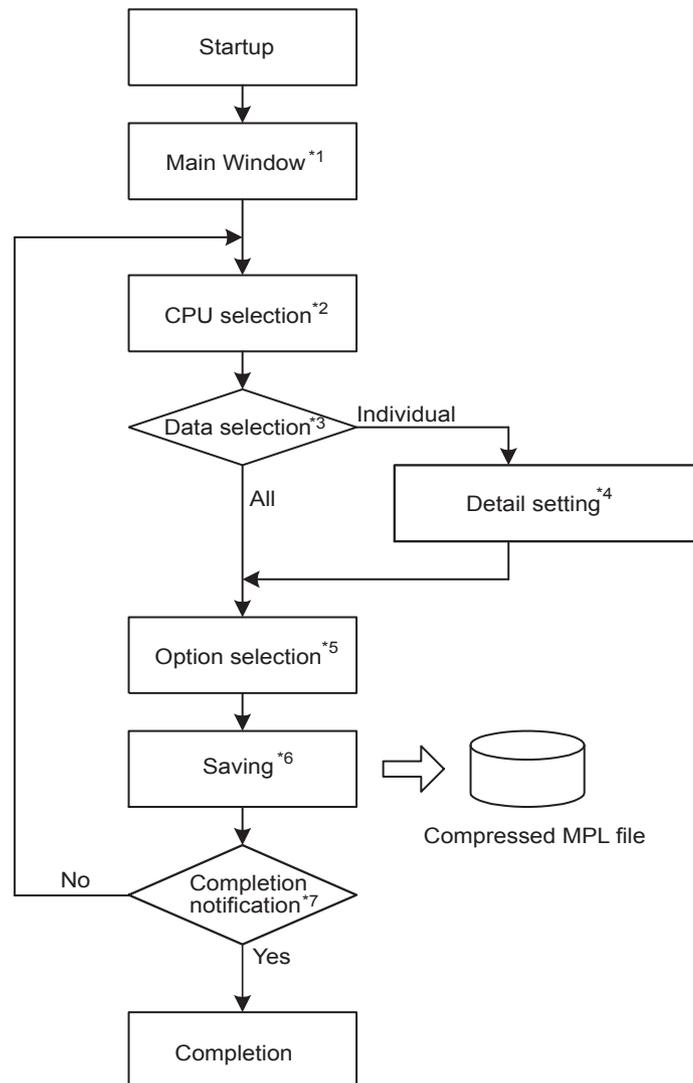

* 1. The Main Window is displayed after the MPL700Server is started up. For details, refer to 3.2 *Main Window*.

* 2. Click the **Make MPL File** Button from the Main Window to display the CPU Selection Window. For details, refer to 3.3 *CPU Selection Window*.

* 3. After selecting the required CPU environment in the CPU Selection Window, click the **NEXT** Button to display the Data Selection Window. For details, refer to 3.4 *Data Selection Window*.

* 4. Click the **Detail Data Select** Button in the Data Selection Window to display the Detail Setting Dialog Box. For details, refer to *Detail Setting Dialog Box* on page 3-12.

* 5. Click the **NEXT** Button in the Data Selection Window to display the Option Window. For details, refer to 3.5 *Option Window*.

- * 6. Click the **Make MPL File** Button in the Final Confirmation Dialog Box displayed after completing the settings for the Option Window to display the Save As Window. For details, refer to *3.6 Save As Window*.
- * 7. Completion notification is displayed if the file is saved successfully after clicking the **Save** Button in the Save As Window. For details, refer to *3.7 Completion Notification Dialog Box*.
- * 8. Click the **Yes** Button to complete the procedure in the Completion Notification Dialog Box. Click the **No** Button to return to the CPU Selection Window.

Details on the operating procedures for each window are explained on the following pages.

3.2 Main Window

The Main Window is explained below. This window is displayed when the MPL700Server is started up.

IMPORTANT

The MPLServer cannot be started up unless there is at least 10 Mbytes of memory available on the computer's hard disk.

■ Display Procedure

Use the following procedure to display the Main Window.

1. Open the Windows **Start** Menu.
2. Select *YE_Application/MPL700Server* from the **Start** Menu.
3. The MPL700Server's Main Window is displayed.

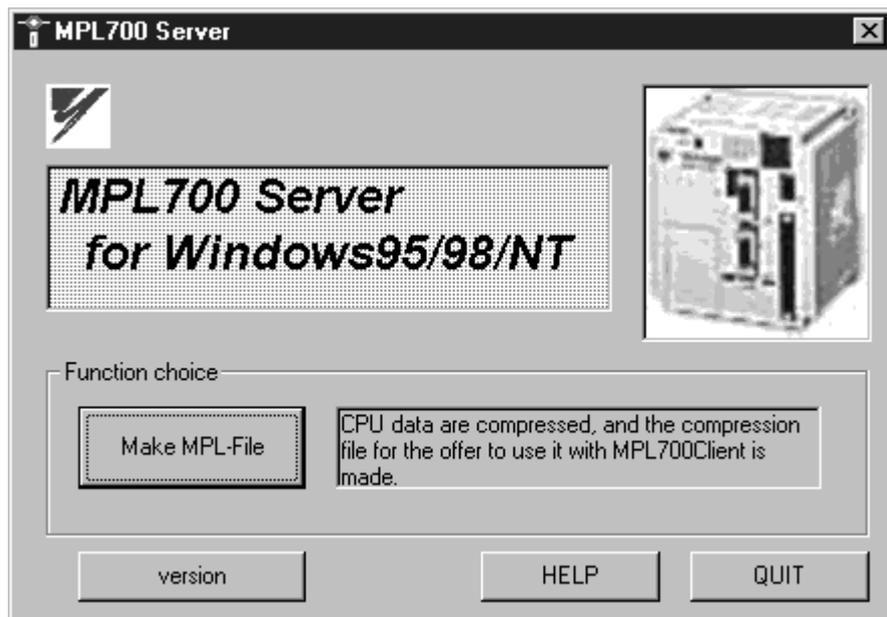

Click the buttons displayed in the window to perform the corresponding operation.

Details on the functions of the buttons are given below.

■ Functions of the Buttons

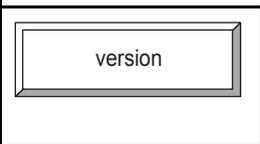
	Click the Make MPL File Button to display the CPU Selection Window and start the procedure for creating files. (For details, refer to 3.3 <i>CPU Selection Window</i> .)
	Click the version Button to display the MPL700Server's Version Dialog Box.* ¹ Click the OK Button to close the dialog box. No other button operations are possible until the OK Button is clicked.
	Click the HELP Button to display the online help manual (HELP file).* ² Acrobat Reader must be installed on the computer to read the help manual.
	Click the QUIT Button to close the MPL700Server.

- * 1. The Version Dialog Box is displayed by clicking the **version** Button. The version of the MPL700Server Software is displayed. Click the **OK** Button to return to the Main Window.

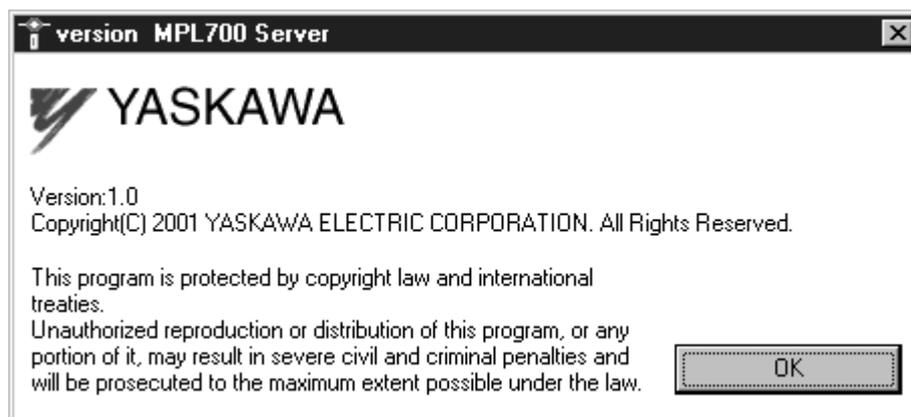

- * 2. To view the HELP file, Acrobat Reader must already be installed on the computer. If required, Acrobat Reader can be installed from the MPL700Server's installation CD-ROM. If Acrobat Reader is not installed, the dialog box shown below will be displayed. Click the **OK** Button of this dialog box to return to the Main Window.

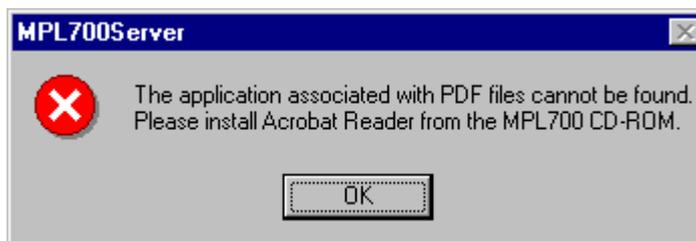

3.3 CPU Selection Window

Details on the CPU Selection Window are given below. This window is displayed by switching the Main Window. The procedure for displaying this window is given below. Select the CPU with the required transfer data from this window.

■ Display Procedure

Use the following procedure to display the CPU Selection Window.

1. Start up the MPL700Server and display the Main Window.
2. Click the **Make MPL File** Button from the Main Window.
3. The following CPU Selection Window is displayed.

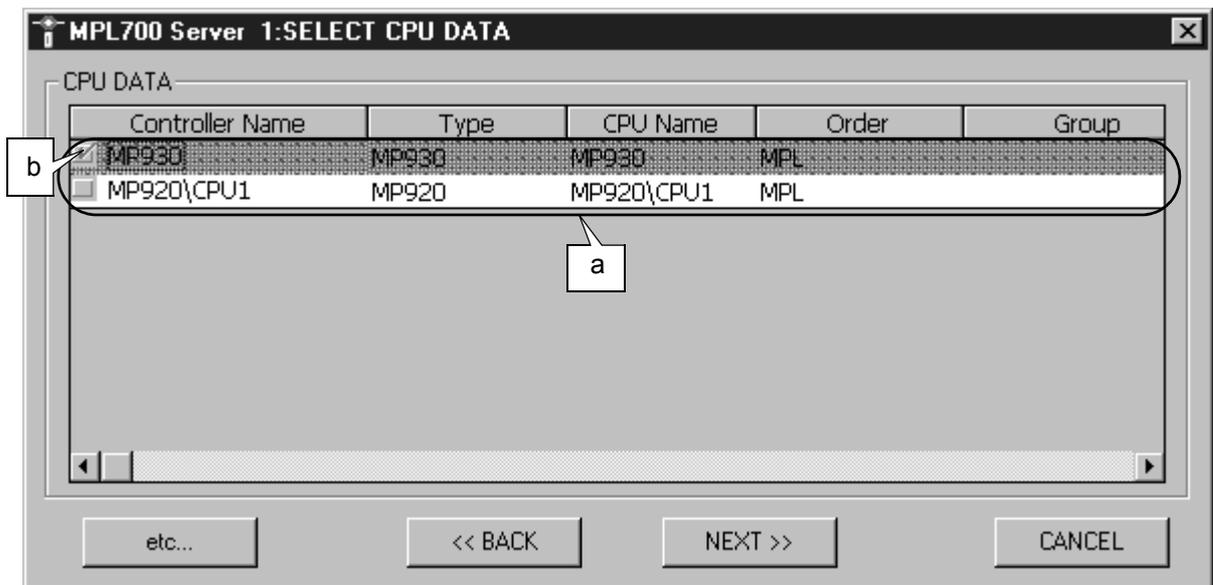

Fig. 3.1 CPU Selection Window

Click the buttons displayed in this window to perform the corresponding operation. The display contents and the functions of the buttons are explained below.

■ Display Contents

Contents and operations for the places indicated in the window as *a* and *b* are explained below.

Symbol	Details
a	When the display switches to the CPU Selection Window, a search for the CP-717 folder on the current hard disk is automatically performed*, and all CP-717 data saved on the disk is displayed in list format. (If there is more than one CP717 PLC folder, data for all folders is displayed.) The following data items are displayed: controller name, type, CPU name, order, group, and application.
b	Folders are selected by checking the boxes on the left of the displayed list. When a folder is selected, the row for that folder is displayed in reverse video and the NEXT Button at the bottom of the window is enabled.

* Automatic search is performed only if CP-717 was installed with the default settings and the CP-717 data was created in the same environment. If the CP-717 was installed on another drive or the folder name was changed, click the **etc...** Button and specify the folder to be compressed.

■ Functions of the Buttons

	If the required CP-717 data is not in the default CP-717 installation folder, click the etc... Button to display the Drive Specification Dialog Box. The Drive Specification Dialog Box is shown in <i>Fig. 3.2</i> and <i>Fig. 3.3</i> . For details, refer to <i>Drive Specification Dialog Box</i> below.
	Click the BACK Button to return to the Main Window.
	If the required data has been selected (see <i>b</i> in <i>Fig. 3.1</i>), the NEXT Button is enabled. Click this button after selecting the required data to display the Data Selection Window. For details, refer to <i>3.4 Data Selection Window</i> .
	Click the CANCEL Button to close the MPL700Server.

■ Drive Specification Dialog Box

To read CPU and environment data for the CPU Selection Window from another drive, or if there is no data in the CP-717 default folder, click the **etc...** Button to display the Drive Specification Dialog Box.

The message displayed in the Drive Specification Dialog Box is different for the case where there is no data in the default folder and the case where another drive is to be specified.

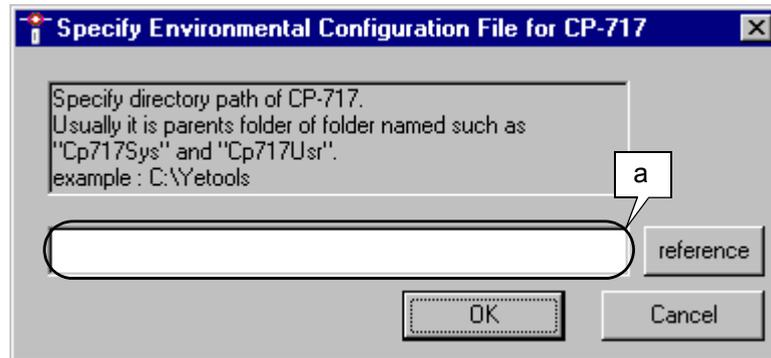

Fig. 3.2 Dialog box displayed when there is no data in the default folder

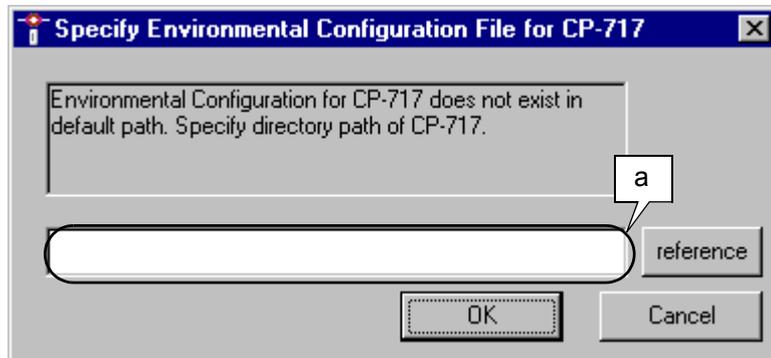

Fig. 3.3 Dialog box displayed when specifying another drive as the data source

■ Display Contents

- The path for the folder to be read is displayed/specified at *a* in the figures.
- Click the **reference** Button to display the Folder Specification Dialog Box (*Fig. 3.4*).
- When the **OK** Button is clicked after specifying a folder, an automatic search for CP-717 data files is performed, and the display returns to the CPU Selection Window.
- Click the **Cancel** Button to return to the CPU Selection Window.

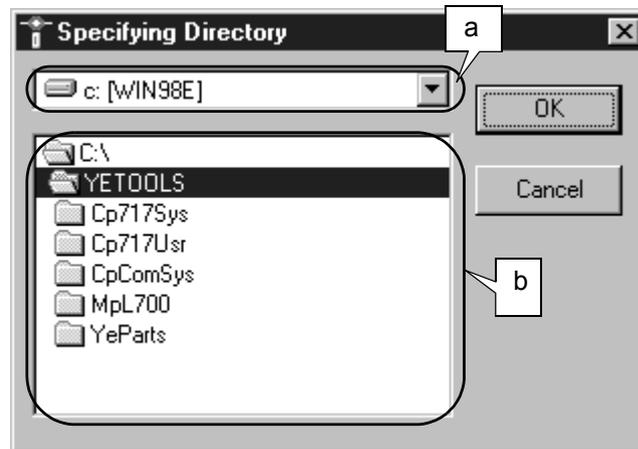

Fig. 3.4 Folder Specification Dialog Box

- Specify the drive in *a* in the figure.
- Specify the folder in *b* in the figure.
- Click the **OK** Button to set the currently specified drive and folder, and return to the previous window.
- Click the **Cancel** Button to return to the Drive Specification Dialog Box. (The drive is not changed.)

3.4 Data Selection Window

Details on the Data Selection Window are given below. This window is displayed by switching the CPU Selection Window after selecting the data to be transferred. Select the data type and other details from this window.

■ Display Procedure

Use the following procedure to display the Data Selection Window.

1. Click the **Make MTP File** Button from the Main Window.
2. The display will switch to the CPU Selection Window. Specify a file.
3. With a file selected, click the **NEXT** Button.
4. The following Data Selection Window is displayed.

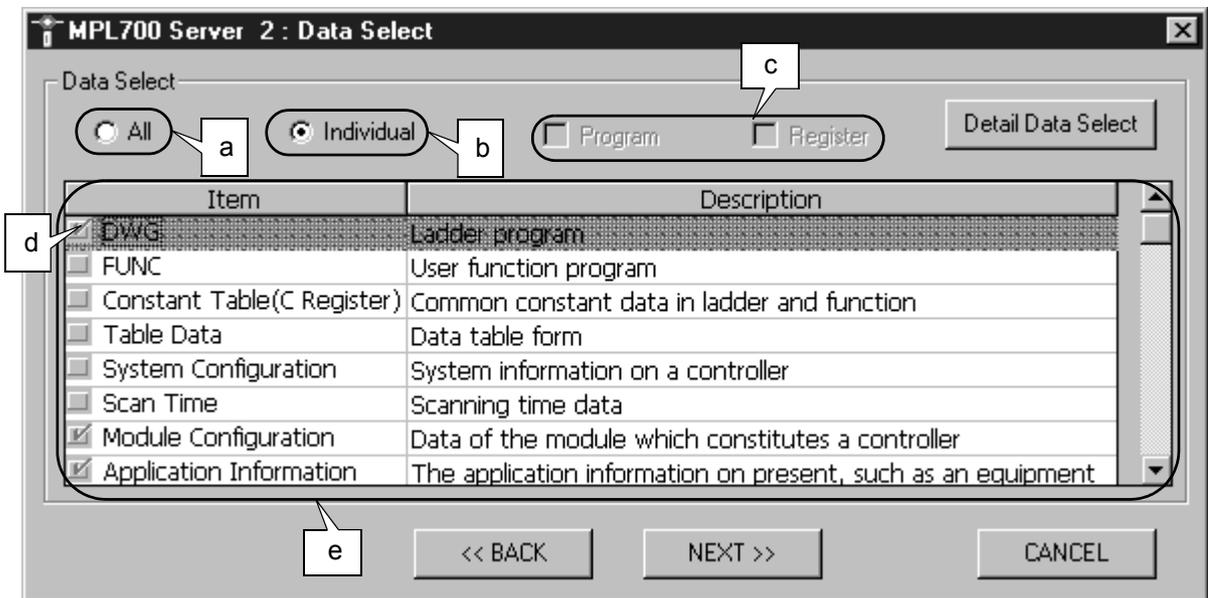

Click the buttons displayed in the window to perform the corresponding operation. The display contents and the functions of the buttons are explained below.

■ Display Contents

Contents and operations for the places indicated in the window are explained below.

Symbol	Details
a	Select <i>All</i> * ¹ to specify all the files displayed in <i>e</i> .
b	Select <i>Individual</i> * ² to enable individual selection of the file types displayed in <i>e</i> .
c	If <i>All</i> is selected, it is possible to select whether register data and/or program data are included in the files.
d	If <i>Individual</i> is selected, the Detail Data Select Button is enabled when any file type is specified (by checking a box).
e	The types of file that can be provided are displayed in list format.

* 1. Checking the *All* checkbox will clear the check in the *Individual* checkbox.

* 2. Checking the *Individual* checkbox will clear the check in the *All* checkbox. The individual data file selection in *d* is then enabled.

■ Functions of the Buttons

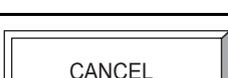
	Click the Detail Data Select Button to display the Detail Setting Dialog Box for selecting the type of data transferred and other details. For details, refer to <i>Detail Setting Dialog Box</i> below.
	Click the BACK Button to return to the CPU Selection Window.
	Click the NEXT Button to hold the current settings and switch to the Option Window.
	Click the CANCEL Button to close the MPL700Server after displaying a confirmation message.

■ Detail Setting Dialog Box

Details on the Detail Setting Dialog Box are given below. This dialog box is displayed by clicking the **Detail Data Select** Button in the Data Selection Window.

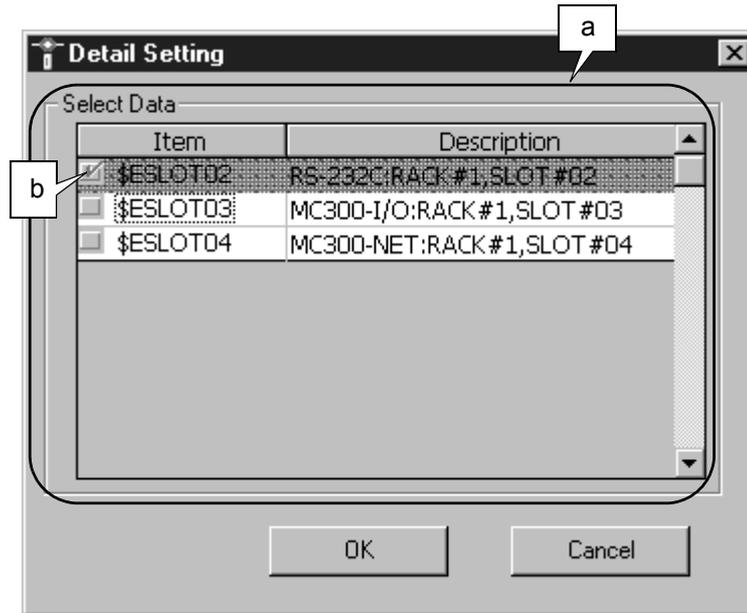

- In *a* in the figure, data types for each individual file are displayed.
- Click the checkboxes on the left of the list to select individual files according to data type. When a line is selected, that line is displayed in reverse video and a check is displayed in the checkbox for that line.
- Click the **OK** Button to save the settings made in the Detail Setting Dialog Box and return to the Data Selection Window.
- Click the **Cancel** Button to clear the settings made in the Detail Setting Dialog Box and return to the Data Selection Window.

3.5 Option Window

Details on the Option Window are given below. This window is used to make settings for downloading files to the transfer destination.

■ Display Procedure

Use the following procedure to display the Option Window.

1. Click the **Make MTP File** Button from the Main Window.
2. The display will switch to the CPU Selection Window. Specify a file.
3. With a file selected, click the **NEXT** Button.
4. The display will switch to the Data Selection Window. Specify the required type of data and click the **NEXT** Button.
5. The following display will switch to the Option Window.

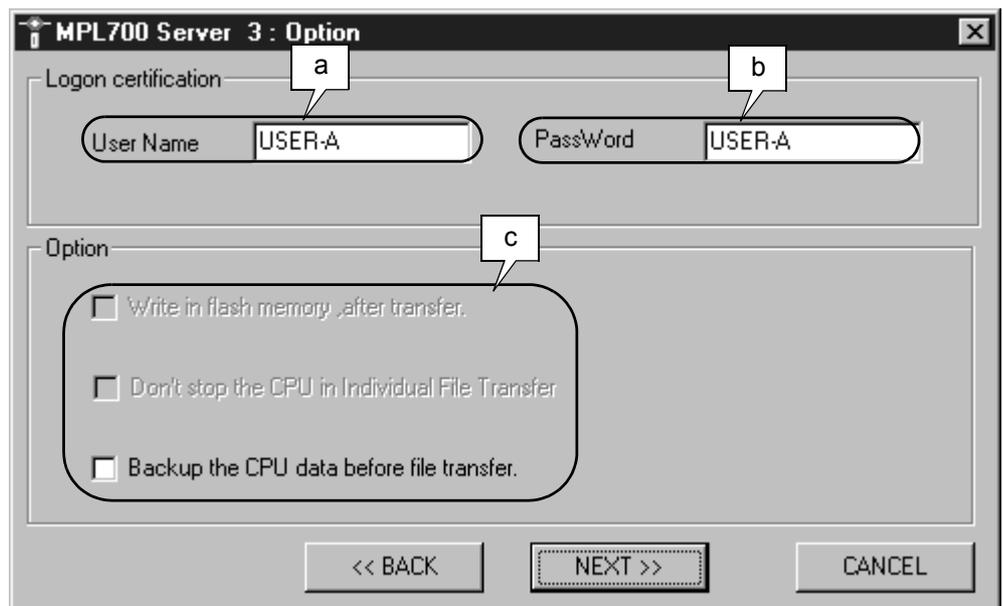

Click the buttons displayed in the window to perform the corresponding operation. The display contents and the functions of the buttons are explained below.

■ Display Contents

Contents and operations for the places indicated in the window are explained below.

Symbol	Details
a	Specify the user name* used to log on when loading files to the Controller specified as the transfer destination.
b	Specify the password* corresponding to the user name used to log on when loading files to the Controller specified as the transfer destination.
c	<p>Specify optional operations performed when loading files to the Controller specified as the transfer destination. There are 3 optional settings. Their functions and enabled conditions are as follows.</p> <ul style="list-style-type: none"> • Write in flash memory after transfer Specifies whether or not MPL files are written to flash memory. Check ON: Written to flash. Check OFF: Not written to flash (default setting). This optional setting is available for MP920-series models (e.g., MP920 and MP920-02). • Don't stop the CPU in Individual File Transfer This setting can be selected when loading files individually. Check ON: CPU not stopped during loading. Check OFF: CPU stopped during loading (default setting). • Backup the CPU data before file transfer Specifies whether or not CPU data is backed up before loading. Check ON: Data backed up. Check OFF: Data not backed up (default setting).

* If these items are left blank, a warning message will be displayed when the **Make MPL File** Button is clicked, and it will not be possible to proceed to the next stage.

■ Functions of the Buttons

	Click the BACK Button to return to the Data Selection Window.
	Click the NEXT Button to display the Final Confirmation Dialog Box. For details, refer to <i>Final Confirmation Dialog Box</i> below. This button is not enabled until the user name and password used for logging on have been input.
	Click the CANCEL Button to close the MPL700Server after displaying a confirmation message.

■ Final Confirmation Dialog Box

After specifying the user name and password used for logging on and the required options in the Option Window, click the **NEXT** Button to display the Final Confirmation Dialog Box showing the all the settings for file creation. The contents of the Final Confirmation Dialog Box vary depending on whether *All* or *Individual* was selected in the Data Selection Window. When *All* is selected, the window in Fig. 3.5 will be displayed. When *Individual* is selected, the window in Fig. 3.6 will be displayed.

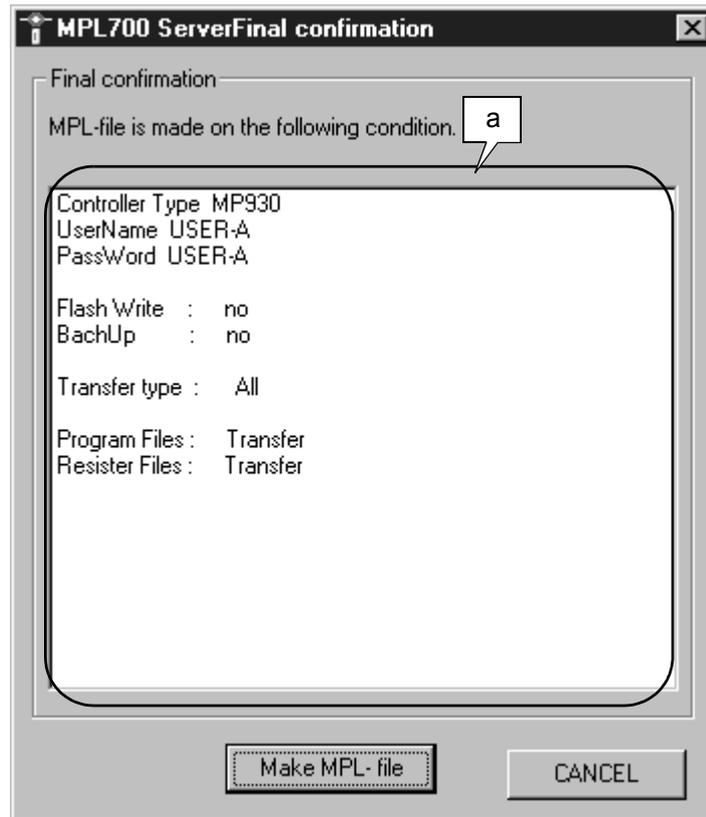

Fig. 3.5 Final Confirmation Dialog Box when *All* is selected

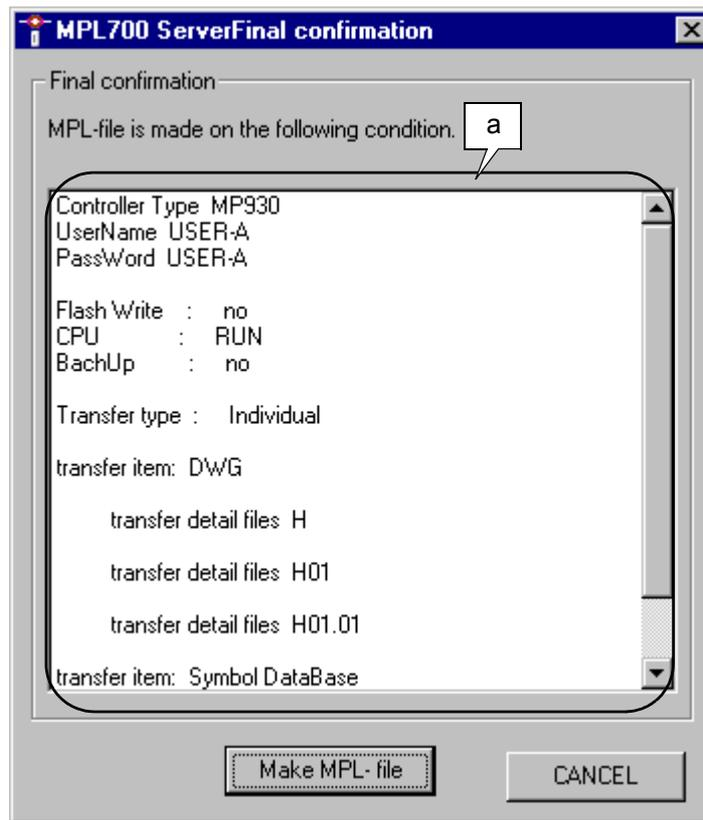

Fig. 3.6 Final Confirmation Dialog Box when *Individual* is selected

■ Display Contents

- The settings for file creation are listed in *a*.
- The log-on information (user name and password) and optional settings for loading specified in the Option Window are displayed, and below this the transfer type (*All* or *Individual*) is displayed and the transfer items are listed.
- After checking conditions, click the **Make MPL File** Button to switch to the Save As Window.

3.6 Save As Window

This window is used to specify files names and where files are saved.

■ Display Procedure

Use the following procedure to display the Save As Window.

1. Click the **Make MTP File** Button from the Main Window.
2. The display will switch to the CPU Selection Window. Specify a file.
3. With a file selected, click the **NEXT** Button.
4. The display will switch to the Data Selection Window. Specify the required types of data and click the **NEXT** Button.
5. The display will switch to the Option Window. Set the load conditions and click the **NEXT** Button.
6. The Final Confirmation Dialog Box will be displayed. Click the **Make MTP File** Button.
7. The following display will switch to the Save As Window.

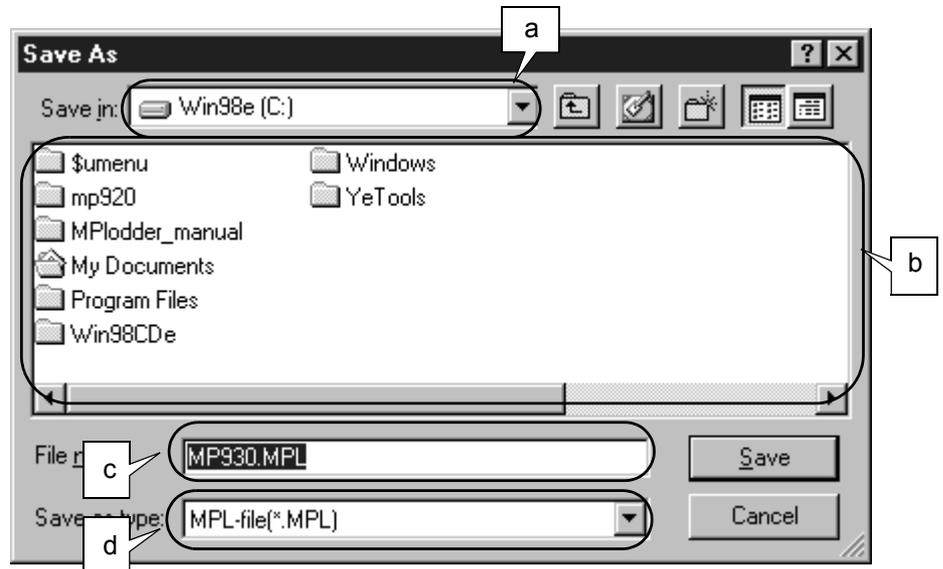

The above window is the window displayed when using the MPL700Server on Windows 98. Parts of the window will vary depending on the operating system. The display contents, however, will be the same.

Click the buttons displayed in the window to perform the corresponding operation. The display contents and the functions of the buttons are explained below.

■ Display Contents

Contents and operations for the places indicated in the window are explained below.

Symbol	Details
a	Used to display or select the drive and folder name of the save destination.
b	Displays the contents of the drive or folder specified in <i>a</i> . Folders and files* ¹ can also be selected from this section.
c	Used to display or set the file name.
d	Displays the selected type of file.* ²

* 1. Only files that can be provided to the end user (i.e., .MPL files) are displayed.

* 2. Only MPLoader files (.MPL) are displayed.

■ Functions of the Buttons

	Click the Save Button to create the file (.MPL file) specified in <i>c</i> at the save destination specified in <i>a</i> .
	Click the Cancel Button to switch the display to the Final Confirmation Dialog Box. (File creation is interrupted.)

3.7 Completion Notification Dialog Box

This dialog box is for notification of successful file creation. The display conditions for this dialog box are given below. Use the buttons in the dialog box to either close the MPL700Server or create a file.

■ Display Procedure

The Completion Notification Dialog Box is displayed at the end of the following procedure.

1. Click the **Make MTP File** Button from the Main Window.
2. The display will switch to the CPU Selection Window. Specify a file.
3. With a file selected, click the **NEXT** Button.
4. The display will switch to the Data Selection Window. Specify the required types of data and click the **NEXT** Button.
5. The display will switch to the Option Window. Set the load conditions and click the **NEXT** Button.
6. The Final Confirmation Dialog Box will be displayed. Click the **Make MTP File** Button.
7. The display will switch to the Save As Window. Save the file.
8. If the file is saved successfully, the following Completion Notification Dialog Box is displayed.

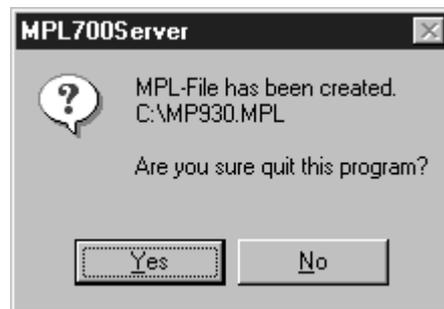

Click the buttons displayed in the dialog box to perform the corresponding operation. The functions of the buttons are explained below.

■ Functions of the Buttons

	Click the Yes Button to close the MPL700Server.
	Click the No Button to return to the CPU Selection Window.

Appendix A

List of Errors

A.1 List of Errors	-----A-2
--------------------	----------

A.1 List of Errors

This appendix provides a list of errors that may occur with the MPL700Server. It also provides appropriate countermeasures.

Error Message	Cause	Countermeasure
Environmental Configuration for CP-717 does not exist in default path.	Displayed if the installation location of the CP-717 cannot be found after searching the drive on which the MPL700Server is installed, the C drive, and the system drive in order.	Specify the drive where the CP-717 is installed.
Failure in compression!	Displayed if a file cannot be saved because of, for example, insufficient disk space or memory.	<ul style="list-style-type: none"> • Ensure that there is at least 10 Mbytes of space available on the disk on which the MPL file is to be created. • Close any other applications.
Missed Controller Folder!	Displayed if there is no PLC folder created using the CP-717.	Create a PLC folder with the CP-717.
Environmental Configuration File for CP717 isn't found in the place of the designation.	Displayed if no configuration files can be found at the CP-717 installation location.	<ul style="list-style-type: none"> • Specify the path (drive and folder name) of the location where the CP-717 is installed. • Reinstall the CP-717.
Help File for MPL700Server doesn't exist in your system. So can't open it.	Displayed if the HELP file is not in the correct folder or if it has been corrupted.	Reinstall the MPL700Server.
You can't use manual in English edition.	Displayed if Acrobat Reader is not installed.	Install Acrobat Reader.
Failure in reading help file!	Displayed if the HELP file is corrupted.	Reinstall the MPL700Server.
It can't save in folder you selected, because of being protected from saving file. Please select another directory path.	Displayed if an attempt is made to save an MPL file in the MPL700Server work folder.	Change the path to which the file is saved to a different folder.
Insert disk please.	Displayed if an external storage device, such as the floppy disk drive, is specified as the save destination but there is no disk inserted.	Insert a disk in the drive specified as the save destination for the MPL file.
Data source to transfer doesn't exist in your choice. Please select some data sources.	Displayed if there is no actual data in the selected folder, or if an attempt is made to create an MPL file without selecting a data file.	Perform the data selection procedure again.
Select some data sources.	Displayed if an attempt is made to proceed from the Data Selection Window without any data selected.	Specify the data items to be saved to the MPL file in the Data Selection Window before proceeding to the next step.
Failed in initializing for work folder.	Displayed if the MPL700Server work folder cannot be cleared properly.	Reinstall the MPL700Server.
Input error!	Displayed if a user name containing invalid characters is set.	Set the user name using valid characters.
Input error!	Displayed if a password containing invalid characters is set.	Set the password using valid characters.
Available disk space is not enough for loading of MPL700Server.	Displayed if an attempt is made to start up the MPL700Server with less than 10 Mbytes of available disk space.	Ensure that there is at least 10 Mbytes of space available on the drive on which the MPL700Server is installed.

(cont'd)

Error Message	Cause	Countermeasure
No supported controller type.	Displayed if an attempt is made to create an MPL file with an invalid PLC model specification.	Create the MPL file after specifying a valid PLC model.
Can't create the environment.	Displayed if there is insufficient space on the hard disk or there is a hardware error.	<ul style="list-style-type: none"> • Ensure that there is at least 10 Mbytes of space available on the hard disk. • Use another drive.
No such directory.	Displayed if there is no valid PLC folder created using the CP-717.	<ul style="list-style-type: none"> • Create the PLC folder with the CP-717 again. • Reinstall the CP-717. • Reinstall the MPL700Server.
No configuration file.	Displayed if there is no CP-717 environment configuration file.	Reinstall the CP-717.
Can't find the configuration file.	Displayed if there is no CP-717 environment configuration file.	Reinstall the CP-717.

Machine Controller MP900 Series MPLoader (Server) USER'S MANUAL

TOKYO OFFICE

New Pier Takeshiba South Tower, 1-16-1, Kaigan, Minatoku, Tokyo 105-6891 Japan
Phone 81-3-5402-4511 Fax 81-3-5402-4580

YASKAWA ELECTRIC AMERICA, INC.

2121 Norman Drive South, Waukegan, IL 60085, U.S.A.
Phone 1-847-887-7000 Fax 1-847-887-7370

MOTOMAN INC. HEADQUARTERS

805 Liberty Lane West Carrollton, OH 45449, U.S.A.
Phone 1-937-847-6200 Fax 1-937-847-6277

YASKAWA ELÉTRICO DO BRASIL COMÉRCIO LTDA.

Avenida Fagundes Filho, 620 Bairro Saude-Sao Paulo-SP, Brazil CEP: 04304-000
Phone 55-11-5071-2552 Fax 55-11-5581-8795

YASKAWA ELECTRIC EUROPE GmbH

Am Kronberger Hang 2, 65824 Schwalbach, Germany
Phone 49-6196-569-300 Fax 49-6196-888-301

Motoman Robotics Europe AB

Box 504 S38525 Torsås, Sweden
Phone 46-486-48800 Fax 46-486-41410

Motoman Robotec GmbH

Kammerfeldstraße 1, 85391 Allershausen, Germany
Phone 49-8166-900 Fax 49-8166-9039

YASKAWA ELECTRIC UK LTD.

1 Hunt Hill Orchardton Woods Cumbernauld, G68 9LF, United Kingdom
Phone 44-1236-735000 Fax 44-1236-458182

YASKAWA ELECTRIC KOREA CORPORATION

Kipa Bldg #1201, 35-4 Youido-dong, Yeongdungpo-Ku, Seoul 150-010, Korea
Phone 82-2-784-7844 Fax 82-2-784-8495

YASKAWA ELECTRIC (SINGAPORE) PTE. LTD.

151 Lorong Chuan, #04-01, New Tech Park Singapore 556741, Singapore
Phone 65-282-3003 Fax 65-289-3003

YASKAWA ELECTRIC (SHANGHAI) CO., LTD.

4F No.18 Aona Road, Waigaoqiao Free Trade Zone, Pudong New Area, Shanghai 200131, China
Phone 86-21-5866-3470 Fax 86-21-5866-3869

YATEC ENGINEERING CORPORATION

Shen Hsiang Tang Sung Chiang Building 10F 146 Sung Chiang Road, Taipei, Taiwan
Phone 886-2-2563-0010 Fax 886-2-2567-4677

YASKAWA ELECTRIC (HK) COMPANY LIMITED

Rm. 2909-10, Hong Kong Plaza, 186-191 Connaught Road West, Hong Kong
Phone 852-2803-2385 Fax 852-2547-5773

BEIJING OFFICE

Room No. 301 Office Building of Beijing International Club, 21
Jianguomenwai Avenue, Beijing 100020, China
Phone 86-10-6532-1850 Fax 86-10-6532-1851

TAIPEI OFFICE

Shen Hsiang Tang Sung Chiang Building 10F 146 Sung Chiang Road, Taipei, Taiwan
Phone 886-2-2563-0010 Fax 886-2-2567-4677

SHANGHAI YASKAWA-TONGJI M & E CO., LTD.

27 Hui He Road Shanghai China 200437
Phone 86-21-6531-4242 Fax 86-21-6553-6060

BEIJING YASKAWA BEIKE AUTOMATION ENGINEERING CO., LTD.

30 Xue Yuan Road, Haidian, Beijing P.R. China Post Code: 100083
Phone 86-10-6233-2782 Fax 86-10-6232-1536

SHOUGANG MOTOMAN ROBOT CO., LTD.

7, Yongchang-North Street, Beijing Economic Technological Investment & Development Area,
Beijing 100076, P.R. China
Phone 86-10-6788-0551 Fax 86-10-6788-2878



YASKAWA

YASKAWA ELECTRIC CORPORATION