

# V7 PROFIBUS-DP<sup>®</sup> Option Technical Manual

*This Manual  
also available on  
[www.drives.com](http://www.drives.com)*



Models: CIMR-V7\*

Document Number TM.V7.12





# Warnings and Cautions

---

*This Section provides warnings and cautions pertinent to this product, that if not heeded, may result in personal injury, fatality, or equipment damage. Yaskawa is not responsible for consequences of ignoring these instructions.*

## **WARNING**

YASKAWA manufactures component parts that can be used in a wide variety of industrial applications. The selection and application of YASKAWA products remain the responsibility of the equipment designer or end user. YASKAWA accepts no responsibility for the way its products are incorporated into the final system design. Under no circumstances should any YASKAWA product be incorporated into any product or design as the exclusive or sole safety control. Without exception, all controls should be designed to detect faults dynamically and to fail safely under all circumstances. All products designed to incorporate a component part manufactured by YASKAWA must be supplied to the end user with appropriate warnings and instructions as to that part's safe use and operation. Any warnings provided by YASKAWA must be promptly provided to the end user. YASKAWA offers an express warranty only as to the quality of its products in conforming to standards and specifications published in the YASKAWA manual. **NO OTHER WARRANTY, EXPRESS OR IMPLIED, IS OFFERED.** YASKAWA assumes no liability for any personal injury, property damage, losses, or claims arising from misapplication of its products.

## **WARNING**

- Read and understand this manual before installing, operating, or servicing this drive. All warnings, cautions, and instructions must be followed. All activity must be performed by qualified personnel. The drive must be installed according to this manual and local codes.
- Do not connect or disconnect wiring while the power is on. Do not remove covers or touch circuit boards while the power is on. Do not remove or insert the digital operator while power is on.
- Before servicing, disconnect all power to the equipment. The internal capacitor remains charged even after the power supply is turned off. Status indicator LEDs and Digital Operator display will be extinguished when the DC bus voltage is below 50 VDC. To prevent electric shock, wait at least 5 minutes after all indicators are OFF and measure DC bus voltage and verify that it is at a safe level.
- Do not perform a withstand voltage test on any part of the unit. This equipment uses sensitive devices and may be damaged by high voltage.
- The drive is not suitable for circuits capable of delivering more than the specified RMS symmetrical amperes. Install adequate branch short circuit protection per applicable codes. Refer to the specification. Failure to do so may result in equipment damage and/or personal injury.
- Do not connect unapproved LC or RC interference suppression filters, capacitors, or over voltage protection devices to the output of the drive. Capacitors may generate peak currents that exceed drive specifications.
- To avoid unnecessary fault displays, caused by contactors or output switches placed between drive and motor, auxiliary contacts must be properly integrated into the control logic circuit.
- YASKAWA is not responsible for any modification of the product made by the user, doing so will void the warranty. This product must not be modified.
- Verify that the rated voltage of the drive matches the voltage of the incoming power supply before applying power.
- To meet CE directives, proper line filters and proper installation are required.
- Some drawings in this manual may be shown with protective covers or shields removed, to describe details. These must be replaced before operation.
- Observe Electrostatic Discharge Procedures when handling the drive and drive components to prevent ESD damage.
- The attached equipment may start unexpectedly upon application of power to the drive. Clear all personnel from the drive, motor and machine area prior to applying power. Secure covers, couplings, shaft keys, machine beds and all safety equipment before energizing the drive.
- Do not attempt to disassemble this unit. There are no user serviceable parts. Disassembling this unit will void any and all warranties.

# Introduction

---

This manual explains the specifications and handling of the Yaskawa *V7 PROFIBUS-DP Option* for the Yaskawa model V7 drive. The *V7 PROFIBUS-DP Option* connects the drive to a PROFIBUS-DP network and facilitates the exchange of data.

This document pertains to the V7 drive. However, this document is equally applicable to drives identified as GPD 315, GPD 315/V7, GPD 315/V74X, and V74X. Additionally, in this document, the word “inverter”, “ac drive” and “drive” may be used interchangeably.

To ensure proper operation of this product, read and understand this manual. For details on installation and operation of the V7 drive, refer to the *V7 Technical Manual*. For details on specific V7 parameters, refer to the *V7 MODBUS<sup>®</sup> Technical Manual*. All technical manuals and support files are available on the CD that came with the drive, CD.4005, and are available for download at [www.drives.com](http://www.drives.com).

For information on PROFIBUS-DP contact the PROFIBUS Organization at [www.profibus.org](http://www.profibus.org).

*V7 Technical Manual* document reference **TM.V7.01**

*V7 MODBUS<sup>®</sup> Technical Manual* document reference **TM.V7.11**

*V7 PROFIBUS-DP Technical Manual* document reference **TM.V7.12**

GPD is a trademark of Yaskawa, Inc.

MODBUS<sup>®</sup> is a registered trademark of Schneider Automation, Inc.

PROFIBUS<sup>®</sup> and PROFIBUS-DP<sup>®</sup> are registered trademarks of PROFIBUS Nutzerorganisation e.V.

All trademarks are the property of their respective owners.

# Table of Contents

---

<b>Chapter 1 Installation</b> .....	<b>1-1</b>
Installation Check Sheet.....	1-3
Unpack and Inspect.....	1-5
Installation and Wiring.....	1-6
Option LEDs.....	1-11
Drive Faults.....	1-13
Parameter Settings.....	1-14
<b>Chapter 2 Network Configuration</b> .....	<b>2-1</b>
Configuration.....	2-3
GSD File.....	2-6
<b>Chapter 3 Network Communications</b> .....	<b>3-1</b>
16 Word Input/Output Message.....	3-3
6 Word Input/Output Message.....	3-7
3 Word I/Os Message.....	3-10
Parameter Access Error Messages.....	3-12
Handshaking.....	3-13
<b>Appendix A Product Specification</b> .....	<b>1</b>
<b>Appendix B Parameter Access</b> .....	<b>1</b>
Parameter Access Overview.....	3
Read Drive Data Example.....	5
Read Drive Data Error Example.....	6
Write Drive Data Example.....	7
Write Drive Data Error Example.....	8
<b>Appendix C Troubleshooting</b> .....	<b>1</b>
Troubleshooting Check List.....	3
Installation Troubleshooting.....	5
Wiring And Cabling.....	8
PROFIBUS-DP Configuration.....	11
V7 PROFIBUS-DP Option Diagnostics.....	12

This page intentionally left blank.

# Chapter 1 Installation

---

*This chapter describes how to install and setup the V7 PROFIBUS-DP Option*

<b>Installation Check Sheet .....</b>	<b>1 - 3</b>
<b>Unpack &amp; Inspect .....</b>	<b>1 - 5</b>
<b>Installation And Wiring.....</b>	<b>1 - 6</b>
<b>Option LEDs.....</b>	<b>1 - 11</b>
<b>Drive Faults.....</b>	<b>1 – 13</b>
<b>Parameter Settings.....</b>	<b>1 - 14</b>

This page intentionally left blank



# Installation Check Sheet

The following is a quick reference guide to install and configure the *V7 PROFIBUS-DP Option*. Make a copy of this page and check-off each item as it is completed. For detailed information please refer to the detailed sections that follow.

- 1:** Unpack the *V7 PROFIBUS-DP Option* and verify that all components are present and undamaged. Refer to **Figure 1.1 – V7PROFIBUS-DP Option, Table 1.1 – Product Parts List** .
- 2:** Connect power to the drive and verify that the drive functions correctly. This includes running the drive from the operator keypad. Refer to the *V7 Technical Manual* for information on connecting and operating the drive.
- 3:** Remove power from the drive and wait for the charge lamp to be completely extinguished. Wait at least five additional minutes for the drive to be completely discharged. Measure the DC bus voltage and verify that it is at a safe level.
- 4:** Install the *V7 PROFIBUS-DP Option* on the drive.
  - 4.1:** Remove the V7 operator keypad and terminal cover.
  - 4.2:** Remove the plastic protective cover from over the CN2 connector. Refer to **Figure 1.2 –Remove CN2 Cover and Install Option Mounting Bracket**.
  - 4.3:** Install the option mounting bracket provided on to the drive. Refer to **Figure 1.2 – Remove CN2 Cover and Install Option Mounting Bracket**.
  - 4.4:** Connect the ground wire provided to the ground connector on the back of the *V7 PROFIBUS-DP Option*. Refer to **Table 1.2 – Ground Cables & Drive Models** and to **Figure 1.3 – Mount the V7 Option**.
  - 4.5:** Mount the *V7 PROFIBUS-DP Option* onto the drive. Refer to **Figure 1.3 – Mount the V7 Option**.
- 5:** Connect the V7 to the PROFIBUS-DP communication network. Refer to **Figure 1.4 – V7 PROFIBUS-DP Option Connections** and **Table 1.3 - PROFIBUS-DP Cable Connections**
- 6:** Set the node address for the drive. Refer to **Figure 1.5 – Setting the V7 PROFIBUS-DP Option Node Address**.
- 7:** If this unit is either the first or the last device on the network, including PLCs and PROFIBUS-DP Masters, and active termination is not used, set the termination resistor switch to ON. If this device is not the first or last device on the network or active termination is used, set the termination resistor switch to OFF. Refer to **Figure 1.6 – Termination Switch**.
- 8:** Secure the *V7 PROFIBUS-DP Option* to the drive.
- 9:** Configure the PROFIBUS network for the drive. Refer to the documentation included with the PROFIBUS configuration utility supplied with the PROFIBUS-DP Master controller.
- 10:** Apply power to the drive. And verify that the diagnostic LEDs on the front of the *V7 PROFIBUS-DP Option* are in their correct state. Refer to **Table 1.4 –Diagnostic LED Status**.
- 11:** Remove power from the drive and wait for the charge lamp to be completely extinguished. Wait at least five additional minutes for the drive to be completely discharged. Measure the DC bus voltage level to confirm that it is at a safe level.
- 12:** Reinstall the operator keypad and terminal cover.
- 13:** Set parameters n003, n004 and n035 to their appropriate values. Refer to **Table 1.5 – Option Specific Parameter Settings**.

This page intentionally left blank.

# Unpack and Inspect

Prior to unpacking, check the package label and verify that the product received matches the product ordered. Unpack the option and verify that the following items are included in the product package and are undamaged.

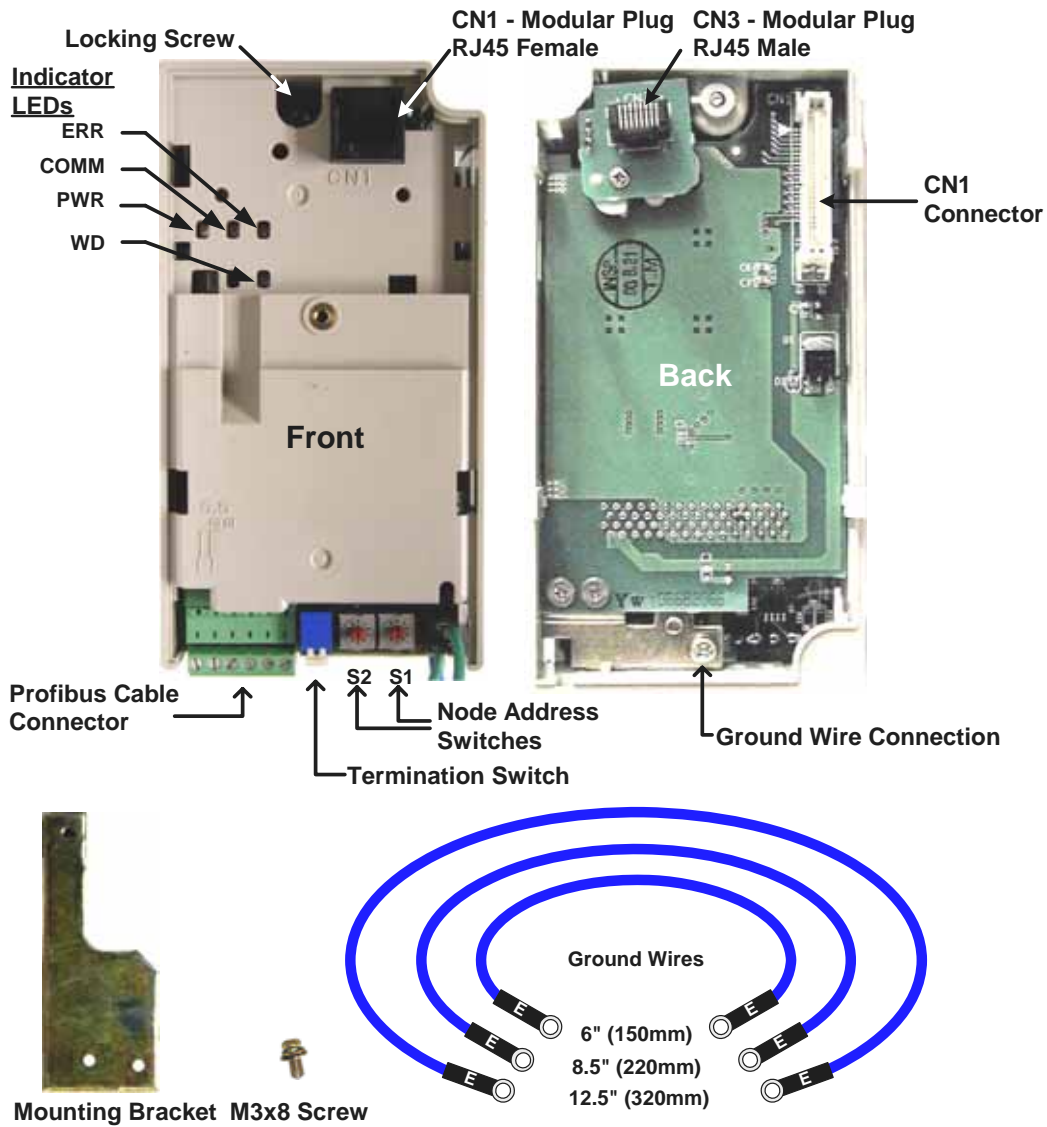

Figure 1.1 – V7 PROFIBUS-DP Option

Table 1.1 – Product Parts List	
Part	Qty.
V7 PROFIBUS-DP Option	1
Mounting Bracket	1
M3x8 Screw	1
6" Ground Wire (150mm)	1
8.5" Ground Wire (220mm)	1
12.5" Ground Wire (320mm)	1
Quick Start Installation Guide	1

# Installation and Wiring

The following describes the installation and configuration of the *V7 PROFIBUS-DP Option*. For detailed information please refer to the appropriate sections of this manual or the *V7 Technical Manual*.

## ◆ Verify Drive Operation

- Connect power to the drive and verify that the drive functions properly. This includes running the drive from the operator keypad. Refer to the *V7 Technical Manual*, for information on connecting and operating the drive.
- Remove power from the drive and wait for the charge lamp to be completely extinguished. Wait at least five additional minutes for the drive to be completely discharged. Measure DC bus voltage and verify that it is at a safe level.
- Remove the operator keypad and terminal cover.

## ◆ Remove CN2 Protective Cover and Install Mounting Bracket

Remove the plastic protective cover from the CN2 connector on the drive by cutting the three tabs as shown below. Install the option mounting bracket and secure it to the drive with the M3x8 screw provided.

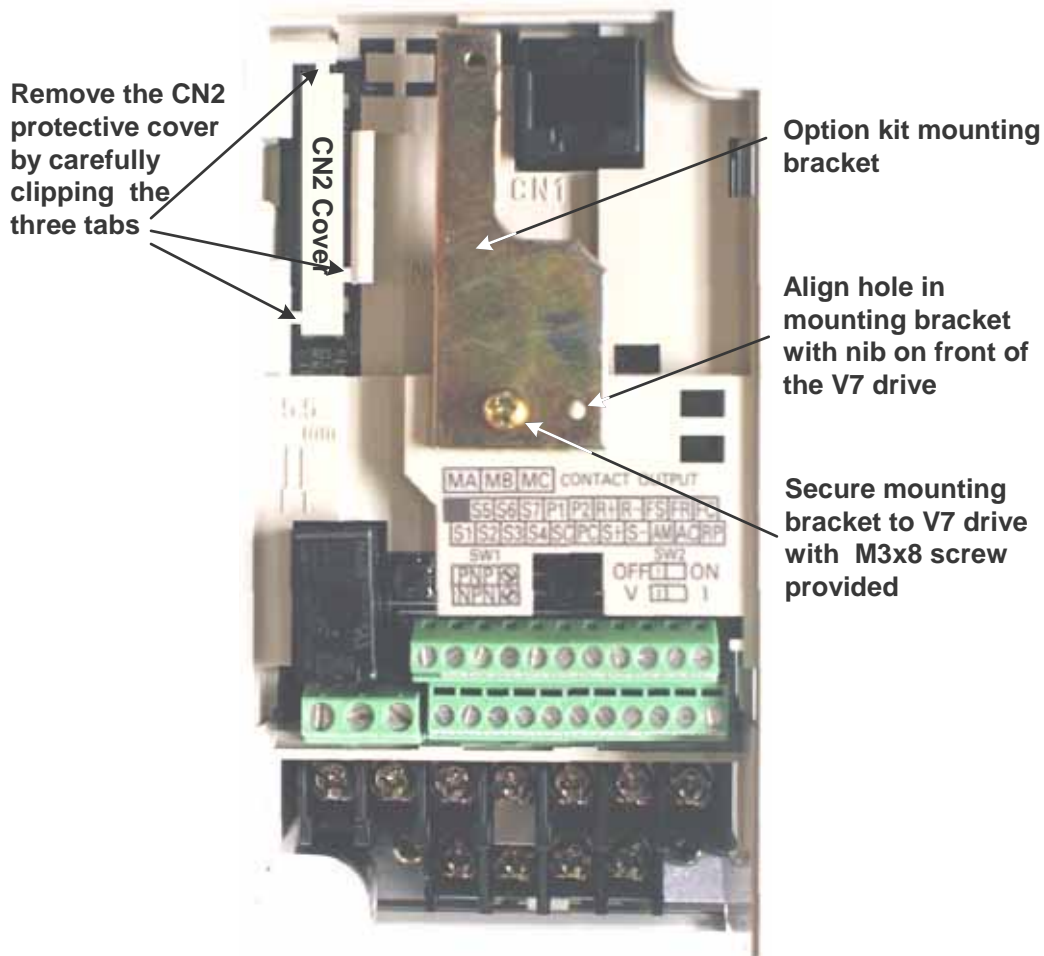

Figure 1.2 – Remove CN2 Cover and Install Option Mounting Bracket

## ◆ Connect Ground Wire

Connect the ground wire to the ground connector on the back of the *V7 PROFIBUS-DP Option*. Select the wire of the appropriate length based on drive model.

Table 1.2 – Ground Cable & Drive Models	
Cable Length	Drive Models
6" (150mm)	20P1, 20P2, 40P2
8.5" (220mm)	20P4, 20P7, 21P5, 22P2, 23P7, 40P4, 40P7, 43P7, 41P5, 42P2
12.5" (320mm)	25P5, 27P5, 47P5

## ◆ Mount the V7 PROFIBUS-DP Option

Mount the *V7 PROFIBUS-DP Option* onto the drive by following the instructions below.

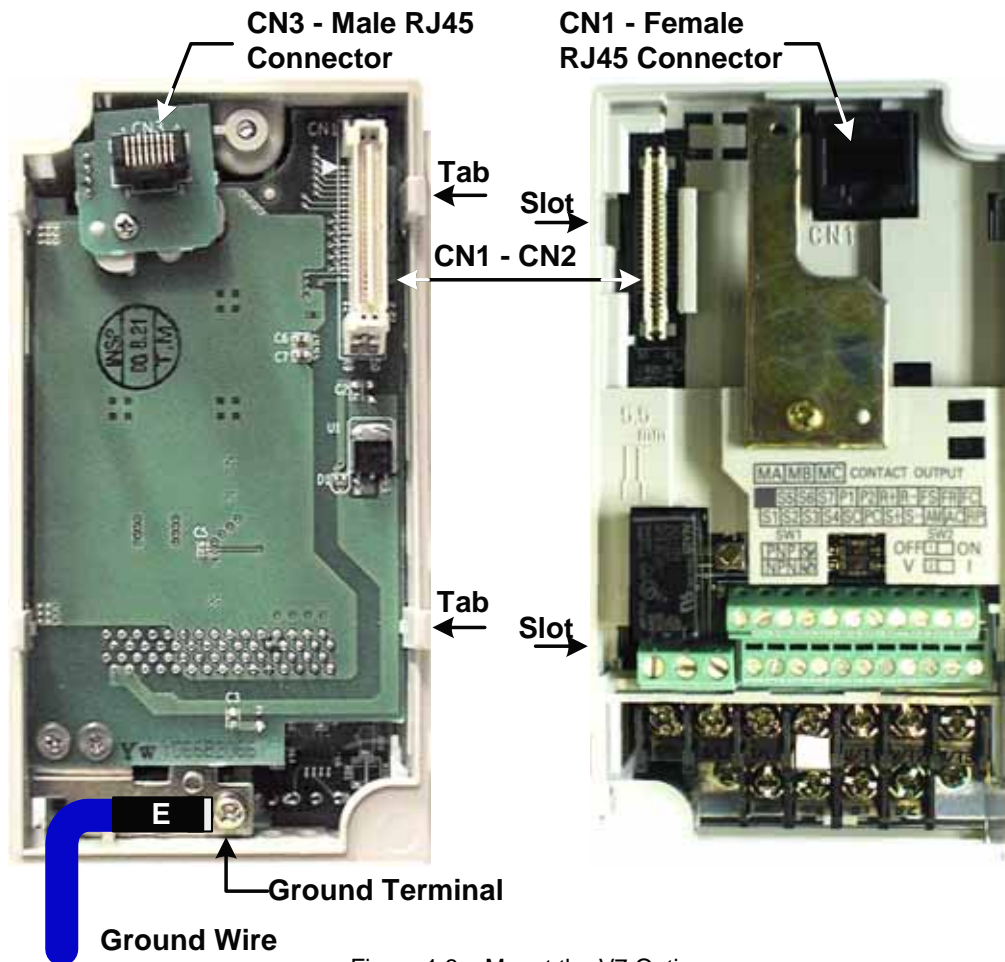

Figure 1.3 – Mount the V7 Option

- Align the CN1 connector on the back of the option with its mating CN2 connector on the front of the drive.
- Simultaneously align the CN3 connector, the male RJ45 connector, on the back of the option with the CN1 connector, the female RJ45 connector, on the front of the drive.
- Align the tabs on the option with their corresponding slots on the front of the drive.
- Press the option and the drive together until the tabs lock into their associated slots.
- Secure the option to the V7 drive by tightening the locking screw at the top-center on the front of the option.
- Connect the ground wire from the *V7 PROFIBUS-DP Option* to the ground terminal on the V7 drive.

## ◆ Connect The V7 To The PROFIBUS-DP Communications Network.

- Determine the type of connector on the V7 PROFIBUS-DP Option. Connector Style A is a modified Phoenix pluggable connector. The modification can be seen on the back of the connector as a small circuit board. Connector Style B is a standard Phoenix pluggable connector without modification.
- Connect the PROFIBUS-DP network cable to the V7 PROFIBUS-DP Option. Refer to the appropriate connection drawing in Figure 1.4 below for your connector style.
- Use standard PROFIBUS-DP cable as specified by the PROFIBUS Organization [www.profibus.org](http://www.profibus.org). Refer to *Appendix C Troubleshooting* for more information on network cabling.

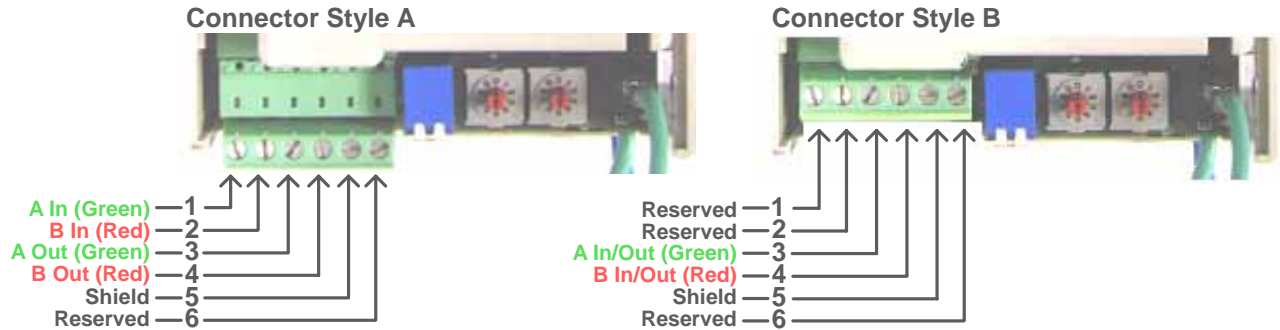

Figure 1.4 – V7 PROFIBUS-DP Option Connections

Table 1.3 – PROFIBUS-DP Cable Connections		
Connector Style A		
Pin	Name	Function
1	A In-(Green)	Negative Input RxD/TxD (Connected from the previous device)
2	B-In (Red)	Positive Input RxD/TxD (Connected from the previous device)
3	A Out-(Green)	Negative Output RxD/TxD (Connect to the next device)
4	B-Out (Red)	Positive Output RxD/TxD (Connect to the next device)
5	Shield	BUS cable shield (Connected to PE internally on the communication option)
6	Reserved	
Connector Style B		
Pin	Name	Function
1	Reserved	
2	Reserved	
3	A In/ Out-(Green)	Negative Input/Output RxD/TxD
4	B-In/Out (Red)	Positive Input/Output RxD/TxD
5	Shield	BUS cable shield (Connected to PE internally on the communication option)
6	Reserved	

## ◆ Set Node Address

Set the node address for the drive setting the 10's digit with S2 and the 1's digit with S1. All devices on the network must have unique node addresses. Check the network layout to verify that the node address selected is unique, matches the master configuration for that device and falls between 3 – 99.

$$\text{Address} = (\text{Switch 2} \times 10) + (\text{Switch 1} \times 1)$$

Example: Set node address to 15

Set address switch 2 to "1"

Set address switch 1 to "5"

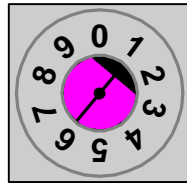

S2

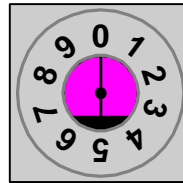

S1

Figure 1.5 – Setting the V7 PROFIBUS-DP Option Node Address

---

## ◆ Set Network Termination

If this unit is either the first or the last device on the network, including any PLC and/or PROFIBUS-DP Master, and active termination is not used, set the termination resistor switch to ON. If this device is not the first or last device on the network or active termination is used, set the termination resistor switch to OFF. Active termination is the recommended termination method and is required for networks operating above 1.5Mbps. Active termination will eliminate the possibility of network failure due to the removal of a terminated device. The Siemens Active terminator Module part number is 6ES7 972-0DA00-0AA0.

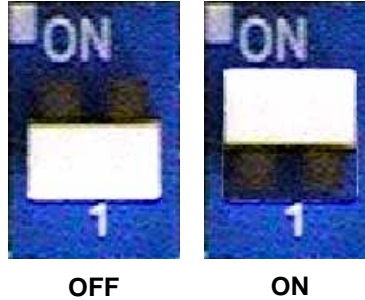

Figure 1.6 – Termination Switch

## ◆ Verify V7 PROFIBUS-DP Option Operation

- Apply power to the drive.
- Verify that the diagnostic LEDs on the front of the *V7 PROFIBUS-DP Option* are in their correct state.

LED Display				Content	Cause
PWR	COM	ERR	WD		
Solid Green	Solid Green	OFF	Flashing Green	Normal	Normal communication possible.

- Remove power from the drive and wait for the charge lamp to be completely extinguished. Wait at least five additional minutes for the drive to be completely discharged. Measure the DC bus voltage and verify that it is at a safe level.
- Secure the communication option to the drive, aligning the recessed screw at the top-center of the option with the threaded hole in the mounting bracket.
- Install the operator keypad and terminal cover.
- Set drive parameters n003, n004 and n035 to appropriate values.

Addr	Param	Function	Data	+/- Limits - Description	Default
103h	n003	Operation Method Selection	0	Operator keypad	1
			1	Terminal	
			2	Serial Communication	
			3	<b>Option Card (PROFIBUS-DP Option)</b>	
104h	n004	Reference Selection	0	Operator keypad Pot	2
			1	Operator keypad	
			2	Voltage Reference (0-10v)	
			3	Current Reference (4-20 Ma)	
			4	Current Reference (0-20 Ma)	
			5	Pulse Train Reference	
			6	Serial Communication	
			7	Multi-Function Analog Input (0-10vdc)	
			8	Multi-Function Analog Input(4-20ma)	
			9	<b>Option Card (PROFIBUS-DP Option)</b>	
123h	n035	Frequency Reference Unit Selection	0	0.01 Hz (< 100hz), 0.1hz (100 Hz >=100hz)	0
			1	0.1%	
			2-39	Rpm	
			40-3999	User Setting	



# Option LEDs

The PROFIBUS-DP Option Unit is equipped with four indication LEDs for module and PROFIBUS-DP status indication. The LEDs are located on the unit according to the figure's below.

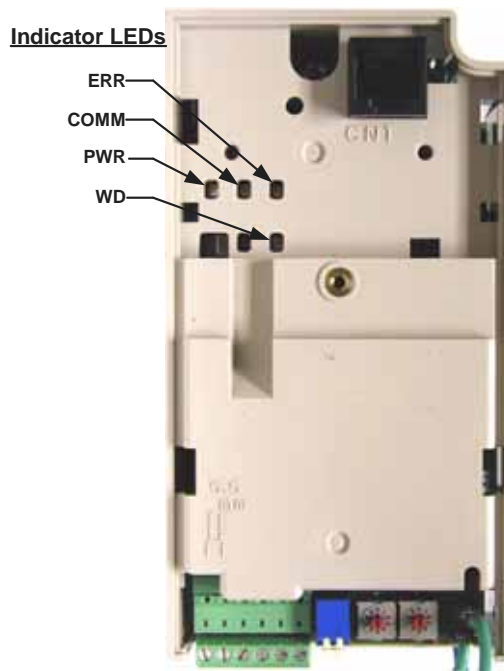

Figure 1.8 – V7 PROFIBUS-DP LED Locations

## ◆ LED Indicators

The following LEDs indicates the PROFIBUS-DP status.

Table 1.6 – Communication LEDs		
LED	Color	Indication/Function
COMM	Green	Lit during data exchange with the PROFIBUS-DP Master .
ERR	Red	Lit when no data exchange is taken place.

## ◆ Module Status Indicators

The following LEDs indicates the status of the *V7 PROFIBUS-DP Option*.

Table 1.7 – Diagnostic LEDs			
LED	Color	Indication/Function	
PWR	Green	Lit when the +5V power to the electronics is OK. Turned off if the +5V is below +4.5V (min)	
WD	Red/Green	Indicates the module status	
		OFF	Communication Option CPU not running.
		Solid Green:	Initialization.
		Flashing green:	Normal operation.
		Solid Red:	Internal Communication Option error.
		Flashing red:	V7 error detected.
Other indication	Unspecified, Communication Option error		

## ◆ LED Diagnostics

The following table presents the faults displayed by the LEDs on the communication option, their causes, and solutions.

Table 1.8 – LED Diagnostics						
LED Display				Content	Cause	Solutions
PWR	COM	ERR	WD			
OFF	OFF	OFF	OFF	Power OFF	Power is not being supplied from the drive. Power is not being supplied to the option unit due to poor option unit connection.	<ul style="list-style-type: none"> <li>• Check the main circuit wiring on the drive.</li> <li>• Cycle drive power.</li> <li>• Turn of the drive power.</li> <li>• Check the option unit connection to the drive.</li> <li>• Cycle drive power.</li> </ul>
Solid Green	OFF	Solid Red	Solid Red	CPU Error	Option unit CPU error.	<ul style="list-style-type: none"> <li>• Cycle drive power.</li> <li>• Replace option unit if fault persists.</li> </ul>
Solid Green	OFF	Solid Red	Flashing Red	Drive Error	Error in Drive unit.	<ul style="list-style-type: none"> <li>• Cycle drive power.</li> <li>• Replace V7 PROFIBUS-DP Option if fault persists</li> <li>• Replace drive if fault persists.</li> </ul>
Solid Green	OFF	Flashing Red	Solid Green	Com Error	A fault has occurred rendering communication impossible.	<ul style="list-style-type: none"> <li>• Check whether the address set in the PROFIBUS-DP Master differs from the address of the option unit.</li> <li>• Check that the master is functioning properly.</li> <li>• Check that the termination resistor is correctly connected to the communication line.</li> <li>• Check whether the communication line is correctly connected (disconnected or poor connection).</li> <li>• Check that the communication line is separated from the main power line.</li> </ul>
Solid Green	Solid Green	Flashing Red	Solid Green	Com Error	A fault has occurred rendering communication impossible.	<ul style="list-style-type: none"> <li>• Check whether the address is duplicated with any other devices within the PROFIBUS-DP network.</li> </ul>
Solid Green	Solid Green	OFF	Solid Green	CPU Init	Option unit under initialization	<ul style="list-style-type: none"> <li>• Wait until WD LED is flashing</li> </ul>
Solid Green	Solid Green	OFF	Flashing Green	Normal	Normal communication possible.	

# Drive Faults

The following is a table of faults caused by the communication option that will be displayed on the V7 Operator Keypad, their causes, and possible solutions. For any fault displayed on the operator that is not listed in the following table, please see the *V7 Technical Manual*.

Table 1.9 – Drive Faults			
Fault	Content	Cause	Solution
BUS	Option Com Error	Communication is not established between PROFIBUS-DP Master and the drive.	<ul style="list-style-type: none"> <li>• Check PROFIBUS-DP communication LED display.</li> </ul>
EF0	External Fault from Option	External fault is active from PROFIBUS-DP option.	<ul style="list-style-type: none"> <li>• Turn OFF external fault input.</li> </ul>
F06	Option Connection Fault	The drive and communication are not correctly connected.	<ul style="list-style-type: none"> <li>• Turn OFF the drive power supply and check the connection of the option unit and drive, and then, turn ON the drive power supply. If the fault persists, change the option unit.</li> </ul>
F21	Communication Option Self-diagnostic Fault	Communication option is not working.	<ul style="list-style-type: none"> <li>• Turn the drive power supply back ON. If the fault persists, replace the option unit.</li> </ul>
F22	Com Option Model Code No. Fault		
F23	Com Option Mutual Diagnostic Fault		

# Parameter Settings

The following sections describe the parameters in the V7 that affect communications through the PROFIBUS-DP Communication Option. For complete information on V7 drive parameters refer to the *V7 MODBUS<sup>®</sup> Technical Manual*.

## ◆ Run/Stop and Frequency Selection

The run/stop and frequency reference commands can originate from serial communication, the operator keypad, external terminals, or the PROFIBUS-DP Option. Parameter n003 (Operation Method Selection) allows the selection of the origin of the run/stop commands. Parameter n004 (Reference Selection) allows the selection of the origin of the frequency reference. The run/stop and frequency reference commands may have different origins. The run/stop command may be set to External Terminals (n003 = 1) while the Frequency Reference may be set to Option Card (PROFIBUS-DP Option) (n004 = 9).

Table 1.10 – Operation Method Selection	
n003	Operation Method Selection (Run/Stop)
0	Operator keypad
1	External Terminals (Default setting is 1)
2	Serial Communication
3	<b>Option Card (PROFIBUS-DP Option)</b>

Table 1.11 – Frequency Reference Source Selection	
n004	Frequency Reference Selection
0	Operator keypad Pot
1	Operator keypad
2	Voltage Reference (0-10V) (Default setting is 2)
3	Current Reference (4 to 20 mA)
4	Current Reference (0 to 20 mA)
5	Pulse Train Reference
6	Serial Communications (Parameter Access)
7	Multi- Function Analog Input (0 to 10V)
8	Multi-Function Analog Input (4 to 20mA)
9	<b>Option Card (PROFIBUS-DP Option)</b>

## ◆ Operator Display Mode

Parameter n035 sets the scaling and units of the frequency reference and output frequency on the operator keypad.. It also determines the scaling and units of the Speed Command, Speed Reference, and Output Frequency used by the PROFIBUS-DP Option

Table 1.12 – Operator keypad Display Mode	
n035	Description
0	0.1hz
1	0.1%
2 – 39	RPM (number of motor poles)
40 - 3999	User setting

---

## ◆ Frequency Reference Units

Parameter n152 sets the resolution of the frequency reference and output frequency monitor. The output frequency resolution of the operator keypad is settable via n035, Frequency Reference Unit Selection. If the operator keypad resolution is set to 0.1 Hz (n035=0), and the resolution is changed to 0.01 Hz in n152, the value in the hundredths digit rounded off when displayed on the operator keypad.

Table 1.13 – Frequency Reference Unit Selection	
n152	Frequency Reference Unit Selection
0	0.1 Hz (Default setting is 0)
1	0.01 Hz
2	100% / 30,000
3	0.1%

This page intentionally left blank.

# Chapter 2 Network Configuration

---

*This chapter provides an example configuration using the **COM PROFIBUS** configuration utility from Siemens. It also explains the differences between the three station configurations.*

<b>Configuration .....</b>	<b>2 - 3</b>
<b>GSD File .....</b>	<b>2 - 6</b>

This page intentionally left blank



# Configuration

Once the *V7 PROFIBUS-DP Option* has been installed and the drive parameters set appropriately, it is necessary to add the drive to the PROFIBUS-DP network through the use of a configuration tool. This tool is usually supplied by the vendor that supplied the PROFIBUS-DP Master controller. This section provides a general overview of how to select the appropriate drive configuration. The Siemens *COM PROFIBUS* configuration tool is used in the examples. The examples and descriptions below assume familiarity with both PROFIBUS-DP network and setting up a PROFIBUS-DP Master for the devices on that network.

The PROFIBUS-DP Communication Option can be configured as one of three possible I/O configurations, 16 word input/output, 6 word input/output and 3 word I/Os, combined input/output, messages. The structure of each message is described in Chapter 3 – Network Communications.

---

## ◆ Configure Master Device

- Copy the GSD file from the CD that came with the *V7 PROFIBUS-DP Option* to the GSD sub-directory under the *COM PROFIBUS* directory. The GSD file may also be downloaded from <http://www.drives.com>
- Open *COM PROFIBUS* and configure the Master device. A Siemens 545-1104 is used in this example.
- Select the DRIVES block from the list of available devices. The cursor should change to  Move the cursor to below the icon representing the Master device and press the left mouse button.



Figure 2.1 – Select Drive

---

## ◆ Select Drive Address

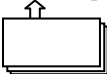
A list box will appear displaying the available addresses for the drive. Select an address for the drive and click on the OK button. The address selected must match the address switch setting on the *V7 PROFIBUS-DP Option* for the drive selected. Refer to the engineering documentation or network schematic to determine which address is applicable for the drive selected.



Figure 2.2 – Select Address

## ◆ Select Station Type

Select the appropriate station type from the list displayed. The *V7 PROFIBUS-DP Option* is listed as **PROFIBUS-DP INTER**. Highlight the selection and click on the **Configure** button.



Figure 2.3 – Select Station Type

## ◆ Station Configuration

Select the configuration desired. **Basic Data** consists of 3 word I/Os, combined input/output. **Extended Data 1** consists of 16 input words and 16 output words. **Extended Data 2** consists of 6 input words and 6 output words.

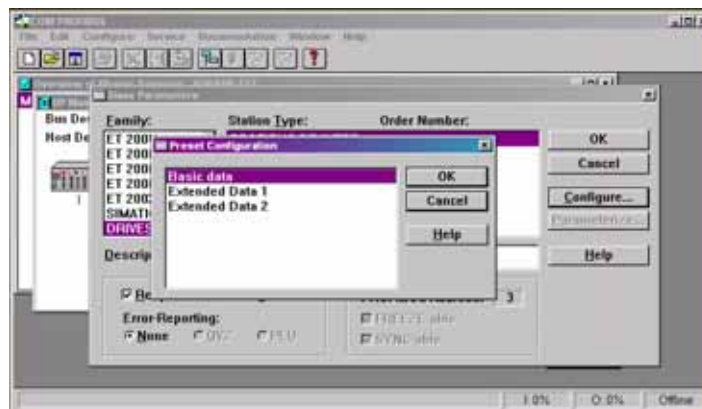

Figure 2.4 – Select Configuration

- The **Basic Data** configuration consists of 6 words of combined I/O. 3 input words and 3 output words. Refer to *3 Word I/O Message* section of *Chapter 3* for a detailed description of the **Basic Data** configuration.

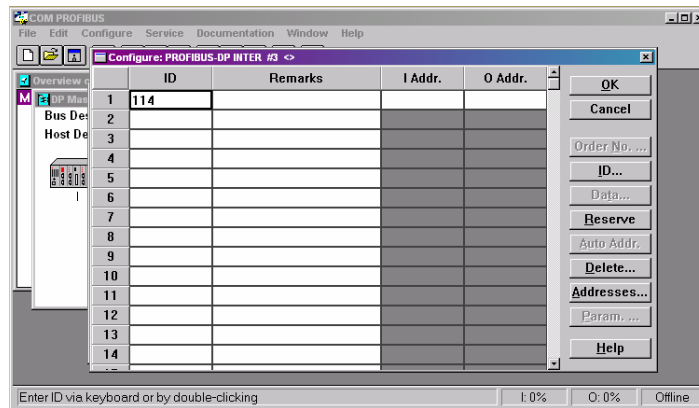

Figure 2.5 – Basic Data Configuration

- The **Extended Data 1** configuration consists of 16 input words and 16 output words. Refer to *16 Word Input/Output Message* section of *Chapter 3* for a detailed description of the **Extended Data 1** configuration. This configuration is also used on those V7 *PROFIBUS-DP Options* that have an Option Name SI-P/V7 or Code Numbers prior to 73606-7110. The Option Name and Code Number are located on the right side of the option.

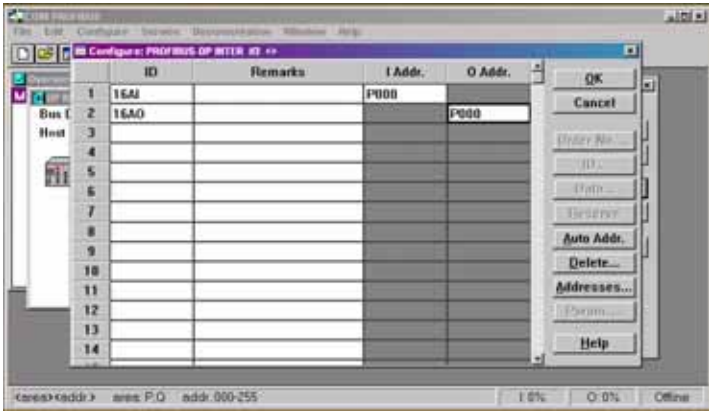

Figure 2.6 – Extended Data 1 Configuration

- The **Extended Data 2** configuration consists of 6 input words and 6 output words. Refer to *6 Word Input/Output Message* section of *Chapter 3* for a detailed description of the **Extended Data 2** configuration. This configuration is also used on those V7 *PROFIBUS-DP Options* previously released as Profibus II.

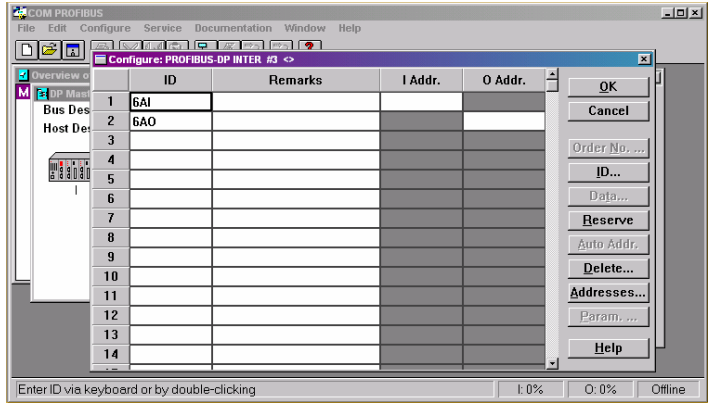

Figure 2.6 – Extended Data 2 Configuration

# GSD File

The listing of the current GSD file is shown below. The GSD file name is YASK00CA.GSD. The file is listed for information purposes only. **Do not attempt to modify the GSD file in any way.**

```
=====
; Device description file according to DIN 19245 Part 3 (PROFIBUS-DP)
=====
;; FILENAME   : YASK00CA_Rev1YEA.GSD
;
; DEVICENAME  : PROFIBUS-DP INTERFACE CARD SI-P1
;
; PROTOCOL    : PROFIBUS-DP slave
;
; VENDOR      : Yaskawa Electric
;
; DATE        : 06 June 2001
;
; MODIFICATIONS : 06 June 2001, rev. 3.0 Created
;                08 April 2002, TW,rev 3.3 Revised for customer compatibility
;
=====
```

```
#PROFIBUS_DP
GSD_Revision   = 1
Vendor_Name    = "YASKAWA ELECTRIC"
Model_Name     = "PROFIBUS-DP INTERFACE CARD SI-P1"
Revision       = "Version 3.3"
Ident_Number   = 0x00CA
Protocol_Ident = 0
Station_Type   = 0
FMS_supp      = 0
Hardware_Release = "Version 1.3"
Software_Release = "Version 3.3"
9.6_supp      = 1
19.2_supp     = 1
45.45_supp    = 1
93.75_supp    = 1
187.5_supp    = 1
500_supp      = 1
1.5M_supp     = 1
3M_supp       = 1
6M_supp       = 1
12M_supp      = 1
MaxTsd_r_9.6  = 60
MaxTsd_r_19.2 = 60
MaxTsd_r_45.45 = 250
MaxTsd_r_93.75 = 60
MaxTsd_r_187.5 = 60
MaxTsd_r_500  = 100
MaxTsd_r_1.5M = 150
MaxTsd_r_3M   = 250
MaxTsd_r_6M   = 450
MaxTsd_r_12M = 800
Redundancy    = 0
Repeater_Ctrl_Sig = 2
24V_Pins      = 0
Implementation_Type = "SPC3"
Freeze_Mode_supp = 1
Sync_Mode_supp = 1
Auto_Baud_supp = 1
Set_Slave_Add_supp = 0
Min_Slave_Intervall = 1
Modular_Station = 1
Max_Module     = 1
Max_Input_Len = 32
Max_Output_Len = 32
Max_Data_Len   = 64
Modul_Offset   = 1
Fail_Safe      = 0
Slave_Family   = 1
Max_Diag_Data_Len = 6
Module = "Basic data" 0x72
EndModule
Module = "Extended Data 1" 0x5F, 0x6F
EndModule
Module = "Extended Data 2" 0x55, 0x65
EndModule
```

# Chapter 3 Network Communications

---

*This chapter describes in detail the composition of the three station types.*

<b>16 Word Input/Output Messages.....</b>	<b>3 - 3</b>
<b>6 Word Input/Output Messages.....</b>	<b>3 - 7</b>
<b>3 Word I/Os Messages .....</b>	<b>3 - 10</b>
<b>Parameter Access Error Messages.....</b>	<b>3 - 12</b>
<b>Handshaking.....</b>	<b>3 - 13</b>

This page intentionally left blank.

# 16 Word Input/Output Message

The V7 PROFIBUS-DP Option can be configured as one of three possible I/O configurations; 16 word input/output message, 6 word input/output message and 3 word I/Os, combined input/output, messages. The 16 word input/output message structure is described in this section.

The 16 word input and output messages are divided into two areas. The first 16 bytes of each message is fixed. This is the most frequently used data and is referred to as the fast I/O data. The remaining 16 bytes of each message are used for reading from and writing to all other drive parameters and is referred to as parameter data. All command, monitor, and parameter data in the drive is accessible via the Parameter Access portion of the message.

Table 3.1 – V7 PROFIBUS-DP 16 Word Input/Output Message Table

Output Data (PROFIBUS-DP Master-> V7)			Input Data (V7 -> PROFIBUS-DP Master )		
	Byte	Function		Byte	Function
Fast I/O Area	0	RUN Operation Command MSB	Fast I/O Area	0	Drive Status MSB
	1	RUN Operation Command LSB		1	Drive Status LSB
	2	Frequency Reference MSB		2	Reserved
	3	Frequency Reference LSB		3	Reserved
	4	Reserved		4	Reserved
	5	Reserved		5	Reserved
	6	Reserved		6	Reserved
	7	Reserved		7	Reserved
	8	Reserved		8	Frequency Reference MSB
	9	Reserved		9	Frequency Reference LSB
	10	Reserved		10	Output Frequency MSB
	11	Reserved		11	Output Frequency LSB
	12	Reserved		12	Output Current MSB
	13	Reserved		13	Output Current LSB
	14	Multifunction Digital Output MSB		14	Main Speed Pulse Train Command MSB
15	Multifunction Digital Output LSB	15	Main Speed Pulse Train Command LSB		
Parameter Access Area	16	Function Code	Parameter Access Area	16	Function Code
	17	Starting Address MSB		17	Starting Address MSB
	18	Starting Address LSB		18	Starting Address LSB
	19	Data Length (2, 4, 6 or 8 bytes of data)		19	Data Length (2, 4, 6 or 8 bytes of data)
	20	Data 1 MSB		20	Data 1 MSB
	21	Data 1 LSB		21	Data 1 LSB
	22	Data 2 MSB		22	Data 2 MSB
	23	Data 2 LSB		23	Data 2 LSB
	24	Data 3 MSB		24	Data 3 MSB
	25	Data 3 LSB		25	Data 3 LSB
	26	Data 4 MSB		26	Data 4 MSB
	27	Data 4 LSB		27	Data 4 LSB
	28	Reserved		28	Reserved
	29	Reserved		29	Reserved
	30	Reserved		30	Reserved
	31	Handshake Register		31	Handshake Register

## ◆ Fast I/O Output Data

The fast I/O output data area is used to transfer parameter data directly to the drive via a dual port RAM interface. The following table details the functions of the fast I/O output data (Bytes 0 to 15) For detailed explanation of the terminal and multi-function inputs and outputs, refer to the *V7 Technical Manual*.

Table 3.2 – 16 Word Input/Output Message Fast I/O Output Data				
Fast I/O Output Data (PROFIBUS-DP Master -> V7)				
Byte	Function	Bit	Note	
0	Command Reference	0	Fwd Run/Stop	1 = RUN Forward (Enabled when n003 is set to 3)
		1	Rev Run/Stop	1 = RUN Reverse (Enabled when n003 is set to 3)
		2	Terminal S3	1 = Close (terminal function dependent on setting of parameter n052)
		3	Terminal S4	1 = Close (terminal function dependent on setting of parameter n053)
		4	Terminal S5	1 = Close (terminal function dependent on setting of parameter n054)
		5	Terminal S6	1 = Close (terminal function dependent on setting of parameter n055)
		6	Terminal S7	1 = Close (terminal function dependent on setting of parameter n056)
		7	Reserved	
1		8	External Fault	1 = External Error
		9	Fault Reset	1 = Reset Fault
		Ah - Fh	Reserved	
2	Frequency Reference	Frequency Reference MSB	0.01Hz scaling is dependent on the setting of parameter n035	
3		Frequency Reference LS		
4 - 13	Reserved	Must be set 0		
14	Multi-Function Output	0	Terminal MA MB MC	1 = Close (terminal function dependent on setting of parameter n057)
		1	Terminal P1-PC	1 = Close (terminal function dependent on setting of parameter n058)
		2	Terminal P2-PC	1 = Close (terminal function dependent on setting of parameter n059)
		3 - Fh	Reserved	
15	Reserved			



## ◆ Fast I/O Input Data

The fast I/O input data area is used to transfer parameter data directly from the drive via a dual port RAM interface. The following table details the functions of the fast I/O input data (Bytes 0 to 15). For detailed explanation of the terminal and multi-function inputs and outputs, refer to the *V7 Technical Manual*.

Table 3.3 – 16 Word Input/Output Message Fast I/O Input Data				
Fast I/O Input Data (V7 -> PROFIBUS-DP Master )				
Byte	Function	Bit	Note	
0	Drive Status	0	Running	
		1	@ Zero Speed	
		2	@ Reverse	
		3	Reset Signal	
		4	@ Frequency Agree	
		5	Drive Ready (Rdy)	
		6	Minor Fault	
		7	Major Fault	
1	Drive Status	8	OPE Error	
		9	Fault Restart	
		10	Local/Remote	
		11	Multi-function Output 1	1 = Close (terminal function dependent on setting of parameter n057)
		12	Multi-function Output 2	1 = Close (terminal function dependent on setting of parameter n058)
		13	Multi-function Output 3	1 = Close (terminal function dependent on setting of parameter n059)
		14	Reserved	
		15	Reserved	
2 - 7	Reserved	Always 0		
8	Frequency Reference	Frequency Reference MSB	0.01Hz scaling is dependent on the setting of parameter n035	
9		Frequency Reference LSB		
10	Output Frequency	Output Frequency MSB	0.01Hz scaling is dependent on the setting of parameter n035	
11		Output Frequency LSB		
12	Output Current	Output Current MSB	0.1A	
13		Output Current LSB		
14	Frequency Reference	Pulse Train MSB		
15	Pulse Train Terminal PR	Pulse train LSB		

## ◆ Parameter Access Area

This area is used to read and write parameter data from and to the drive. The PROFIBUS-DP Master completes the Parameter Access command (output) message and waits for and then processes the data returned in the Parameter Access response (input) message. These messages may contain 1 - 4 words of data. The handshaking byte is used to synchronize the communications between the PROFIBUS-DP Master and the drive. This is necessary due to the additional time required for the drive to process the message. Refer to the *Handshaking* section of this chapter for more information on handshaking. **Note:** Care must be taken when writing certain parameters to the V7 drive as other parameters may be dependant on them. Control method, n002, maximum Frequency, n011, and Acc/Dec Scale Time, n018, are just a few parameters whose setting will affect other parameter's settings or ranges.. Refer to *V7 MODBUS® Technical Manual* for more information.

## ◆ Parameter Access Command Message Structure

Two command, output, functions are available, read parameter data, 03h, and write parameter data, 10h. If no parameter access communications is desired, use 00h as the function code. These function codes are programmed in byte 16 of the 16 word input/output message. Bytes 17 and 18 contain the parameter access address of the parameter to be accessed. Byte 19 contains the number of data bytes to be read from or written to the drive. Since each parameter consists of two bytes, this value is incremented by two for each parameter accessed. Bytes 19 through 27 contain the data to be written to the selected parameter. If the command is to read parameter data, bytes 19 through 27 must be set to 0.

Table 3.4 – 16 Word Input/Output Message Parameter Access Command Structure		
Output Data – Parameter Access Command Message (PROFIBUS-DP Master -> V7)		
Byte	Name	Function
16	Function Code	Parameter Access Command Code (Read data = 03h, Write data = 10h)
17	Starting Address MSB	The first register to be read or written
18	Starting Address LSB	
19	Data Quantity	Bytes of data (2 x Number of parameters to be read or written)
20	Data 1 MSB	Value of data to write to the drive parameter <b>Starting Address</b>
21	Data 1 LSB	
22	Data 2 MSB	Value of data to write to the drive parameter <b>Starting Address + 1</b>
23	Data 2 LSB	
24	Data 3 MSB	Value of data to write to the drive parameter <b>Starting Address + 2</b>
25	Data 3 LSB	
26	Data 4 MSB	Value of data to write to the drive parameter <b>Starting Address + 3</b>
27	Data 4 LSB	
28	Reserved	
29	Reserved	
30	Reserved	
31	Handshaking Register	Synchronizes drive communication with PROFIBUS-DP Master

## ◆ Parameter Access Response Message Structure

The standard Parameter Access response structure is described below. In a non-erroneous response, the Function Code, Starting Register and Data Quantity are identical to the command message. If the command function code is 03h, read data, the data bytes will contain the values of the requested parameters. If the command function code is 10h, write data, the data bytes will contain 0 and should be ignored.

Table 3.5 – 16 Word Input/Output Message Parameter Access Response Structure		
Input Data – Parameter Access Response Message (V7 -> PROFIBUS-DP Master )		
Byte	Name	Function
16	Function Code	Parameter Access Response Code (Command code or command code & 80h for error)
17	Starting Address MSB	The first register to be read or written
18	Starting Address LSB	
19	Data Quantity	Bytes of data (2 x Number of parameters to be read or written)
20	Data 1 MSB	Value of data read from the drive parameter <b>Starting Address</b>
21	Data 1 LSB	
22	Data 2 MSB	Value of data read from the drive parameter <b>Starting Address + 1</b>
23	Data 2 LSB	
24	Data 3 MSB	Value of data read from the drive parameter <b>Starting Address + 2</b>
25	Data 3 LSB	
26	Data 4 MSB	Value of data read from the drive parameter <b>Starting Address + 3</b>
27	Data 4 LSB	
28	Reserved	
29	Reserved	
30	Reserved	
31	Handshaking Register	Synchronizes drive communication with PROFIBUS-DP Master

# 6 Word Input/Output Message

The 6 word input and output messages are divided into two areas. The first 4 bytes of each message is fixed. This is the most frequently used data and is referred to as the fast I/O data. The remaining 8 bytes of each message are used for reading from and writing to all other drive registers and is referred to as parameter data. All command, monitor, and parameter data in the drive is accessible via the Parameter Access portion of the message. . **Note:** Care must be taken when writing certain parameters to the V7 drive as other parameters may be dependant on them. Control method, n002, maximum Frequency, n011, and Acc/Dec Scale Time, n018, are just a few. Refer to *V7 MODBUS® Technical Manual* for more information.

The 6 word input and output messages was designed for situations where processor memory may be a factor in the number of PROFIBUS-DP devices resident on the network.

Output Data (PROFIBUS-DP Master -> V7)			Input Data (V7 -> PROFIBUS-DP Master )		
	Byte	Function		Byte	Function
Fast I/O	0	RUN Operation Command MSB	Fast I/O	0	Drive Status MSB
	1	RUN Operation Command LSB		1	Drive Status LSB
	2	Frequency Reference MSB		2	Frequency Feedback MSB
	3	Frequency Reference LSB		3	Frequency Feedback LSB
Parameter Access	4	Function Code	Parameter Access	4	Function Code
	5	Starting Address MSB		5	Starting Address MSB
	6	Starting Address LSB		6	Starting Address LSB
	7	Data Length (always 2)		7	Data Length (always 2)
	8	Data 1 MSB		8	Data 1 MSB
	9	Data 1 LSB		9	Data 1 LSB
	10	Reserved		10	Reserved
	11	Reserved		11	Reserved
	12	Handshake Register		12	Handshake Register

## ◆ Fast I/O Output Data

The fast I/O output data area is used to transfer parameter data directly to the drive via a dual port RAM interface. The following table details the functions of the fast I/O output data (Bytes 0 to 3) For detailed explanation of the terminal and multi-function inputs and outputs, refer to the *V7 Technical Manual*.

Fast I/O Output Data (PROFIBUS-DP Master -> V7)			
Byte	Function	Bit	Note
0	Command Reference	0	Fwd Run/Stop 1 = RUN Forward (Enabled when n003 is set to 3)
		1	Rev Run/Stop 1 = RUN reverse (Enabled when n003 is set to 3)
		2	Terminal S3 1 = Close (terminal function dependent on setting of parameter n052)
		3	Terminal S4 1 = Close (terminal function dependent on setting of parameter n053)
		4	Terminal S5 1 = Close (terminal function dependent on setting of parameter n054)
		5	Terminal S6 1 = Close (terminal function dependent on setting of parameter n055)
		6	Terminal S7 1 = Close (terminal function dependent on setting of parameter n056)
1	Command Reference	7	Reserved
		8	External Fault 1 = External Error
		9	Fault Reset 1 = Reset Fault
		Ah – Fh	Reserved
2	Frequency Reference	Frequency Reference MSB	0.01Hz scaling is dependent on the setting of parameter n035
3		Frequency Reference LSB	

## ◆ Fast I/O Input Data

The fast I/O input data area is used to transfer parameter data directly from the drive via a dual port RAM interface. The following table details the functions of the fast I/O input data (Bytes 0 to 3) For detailed explanation of the terminal and multi-function inputs and outputs, refer to the *V7 Technical Manual*.

Table 3.9 – 6 Word input/Output Message Fast I/O Input Data				
Fast I/O Input Data (V7 -> PROFIBUS-DP Master )				
Byte	Function	Bit	Note	
0	Drive Status	0	Running	
		1	@ Zero Speed	
		2	@ Reverse	
		3	Reset Signal	
		4	@ Frequency Agree	
		5	Drive Ready (Rdy)	
		6	Minor Fault	
7		Major Fault		
1		8	OPE Error	
		9	Fault Restart	
		10	Local/Remote	
		11	Multi-function Output 1	1 = Close (terminal function dependent on setting of parameter n057)
		12	Multi-function Output 2	1 = Close (terminal function dependent on setting of parameter n058)
		13	Multi-function Output 3	1 = Close (terminal function dependent on setting of parameter n059)
		14	Reserved	
	15	Reserved		
2	Frequency Reference	Frequency Reference MSB	0.01Hz scaling is dependent on the setting of parameter n035	
3		Frequency Reference LSB		

## ◆ Parameter Access Area

This area is used to read and write parameter data from and to the drive. The PROFIBUS-DP Master completes the Parameter Access command (output) message and waits for and then processes the data returned in the response (input) message. These messages may contain 1 - 4 words of data. The handshaking byte is used to synchronize the communications between the PROFIBUS-DP Master and the drive. This is necessary due to the additional time required for the drive to process the message.

## ◆ Parameter Access Command Message Structure

Two command, output, functions are available, read parameter data, 03h, and write parameter data, 10h. If no Parameter Access communications is desired, use 00h as the function code. These function codes are programmed in byte 4 of the 6 word input/output message. Bytes 5 and 6 contain the address of the parameter to be accessed. Byte 7 contains the number of data bytes to be read from or written to the drive. Since only one parameter may be accessed at a time, this value must always be set to 2. Bytes 8 and 9 contain the data to be written to the selected parameter. If the command is to read parameter data, bytes 8 and 9 must be set to 0.

Table 3.10 – 6 Word Input/Output Message Parameter Access Command Messages		
Output Data – Parameter Access Command Message (PROFIBUS-DP Master -> V7)		
Byte	Name	Function
4	Function Code	Parameter Access Command Code (Read data = 03h, Write data = 10h)
5	Starting Address MSB	The first register to be read or written
6	Starting Address LSB	
7	Data Quantity	(Bytes of data (2 x Number of parameters to be read or written))
8	Data 1 MSB	Value of data to write to the drive parameter <b>Starting Address</b>
9	Data 1 LSB	
10	Reserved	
11	Reserved	
12	Handshaking Register	Synchronizes drive communication with PROFIBUS-DP Master

## ◆ Parameter Access Response Message Structure

The standard Parameter Access response structure is described below. In a non-erroneous response, the Function Code, Starting Address and Data Quantity are identical to the command message. If the command function code is 03h, read data, the data bytes will contain the values of the requested registers. If the command function code is 10h, write data, the data bytes will contain 0 and should be ignored.

Table 3.11 – 6 Word Input/Output Message Parameter Access Response Structure		
Input Data – Parameter Access Response Message (V7 -> PROFIBUS-DP Master )		
Byte	Name	Function
4	Function Code	Parameter Access Response Code (Command code or command code & 80h for error)
5	Starting Address MSB	The first register to be read or written
6	Starting Address LSB	
7	Data Quantity	Bytes of data (2 x Number of parameters to be read or written) (always 2)
8	Data 1 MSB	Value of data read from the drive parameter <b>Starting Address</b>
9	Data 1 LSB	
10	Reserved	
11	Reserved	
12	Handshaking Register	Synchronizes drive communication with PROFIBUS-DP Master

# 3 Word I/Os Message

The 3 word I/Os messages have only one fixed area. This is the most frequently used data and is referred to as the fast I/O data. 6 Byte messages are used when processor memory is a critical factor in the network design. As shown below the 3 word I/Os message contains only the minimum drive data.

OUTPUT DATA PROFIBUS-DP Master -> V7			INPUT DATA V7 -> PROFIBUS-DP Master		
	Byte	Function		Byte	Function
Fast I/O	0	RUN Operation Command MSB	Fast I/O	0	Drive Status MSB
	1	RUN Operation Command LSB		1	Drive Status LSB
	2	Frequency Reference MSB		2	Frequency Reference MSB
	3	Frequency Reference LSB		3	Frequency Reference LSB
	4	Torque Reference MSB		4	Torque Reference MSB
	5	Torque Reference LSB		5	Torque Reference LSB

## ◆ Fast I/O Output Data

The fast I/O output data area is used to transfer parameter data directly to the drive via a dual port RAM interface. The following table details the functions of the fast I/O output data (Bytes 0 to 5) For detailed explanation of the terminal and multi-function inputs and outputs, refer to the *V7 Technical Manual*.

Fast I/O Output Data (PROFIBUS-DP Master -> V7)			
Byte	Function	Bit	Note
0	Command Reference	0	Fwd Run/Stop 1 = RUN Forward (Enabled when n003 is set to 3)
		1	Rev Run/Stop 1 = RUN reverse (Enabled when n003 is set to 3)
		2	Terminal S3 1 = Close (terminal function dependent on setting of parameter n052)
		3	Terminal S4 1 = Close (terminal function dependent on setting of parameter n053)
		4	Terminal S5 1 = Close (terminal function dependent on setting of parameter n054)
		5	Terminal S6 1 = Close (terminal function dependent on setting of parameter n055)
		6	Terminal S7 1 = Close (terminal function dependent on setting of parameter n056)
1	Command Reference	7	Reserved
		8	External Fault 1 = External Error
		9	Fault Reset 1 = Reset Fault
Ah - Fh		Reserved	
2	Frequency Reference	Frequency Reference MSB	1 = 0.01Hz or 1 = 1 RPM scaling is dependent on the setting of parameter n035
3		Frequency Reference LSB	
4	Torque Reference	Torque Reference MSB	0 – 100%
5		Torque Reference LSB	

## ◆ Fast I/O Input Data

This area is used to transfer parameter data directly from the drive dual port RAM interface. The following tables detail the functions of the fast I/O input data (Bytes 0 to 5)

Table 3.14 – 3 Word Message Fast I/O Input Data				
Fast I/O Input Data (V7 -> PROFIBUS-DP Master )				
Byte	Function	Bit	Note	
0	Drive Status	0	Running	
		1	@ Zero Speed	
		2	@ Reverse	
		3	Reset Signal	
		4	@ Frequency Agree	
		5	Drive Ready (Rdy)	
		6	Minor Fault	
		7	Major Fault	
1	Drive Status	8	OPE Error	
		9	Fault Restart	
		10	Local/Remote	
		11	Multi-function Output 1	1 = Close (terminal function dependent on setting of parameter n057)
		12	Multi-function Output 2	1 = Close (terminal function dependent on setting of parameter n058)
		13	Multi-function Output 3	1 = Close (terminal function dependent on setting of parameter n059)
		14	Reserved	
15	Reserved			
2	Frequency Reference	Frequency Reference MSB	0.01Hz scaling is dependent on the setting of parameter n035	
3		Frequency Reference LSB		
4	Torque Reference	Torque Reference MSB	0 – 100%	
5		Torque Reference LSB		

# Parameter Access Error Messages

Whenever there is an invalid parameter access message, the drive will respond with an error message containing the fault code for that particular error. Parameter access pertains only to 16 Word and 6 word messages.

---

## ◆ 16 Word Input/Output Message

If an erroneous Parameter Access message is sent to the drive, the drive will respond with a fault message. The MSB of byte 16 of the fault response will be set. If the fault is a read parameter data fault, byte 16 of the response message will contain 83h, read parameter function code 03h with the MSB set. If the fault is a write parameter data fault, byte 16 of the response message will contain 90h, write parameter function code 10h with the MSB set. Byte 19 will contain 2 and byte 21 will contain the specific error code. Refer to Table 3.15 below for description of the possible error codes.

---

## ◆ 6 Word Input/Output Message

If an erroneous Parameter Access message is sent to the drive, the drive will respond with a fault message. The MSB of byte 4 of the fault response will be set. If the fault is a read parameter data fault, byte 4 of the response message will contain 83h, read parameter function code 03h with the MSB set. If the fault is a write parameter data fault, byte 4 of the response message will contain 90h, write parameter function code 10h with the MSB set. Byte 7 will contain 2 and byte 9 will contain the specific error code. Refer to Table 3.15 below for description of the possible error codes.

Error Code	Error Name	Details
01h	Function Error	Invalid function code
02h	Address Error	Parameter starting address greater than 600h
03h	Amount of Data Fault	Read or Write less than 2 words or more than 4 words
21h	Data Content Fault	Parameter exceeds upper and lower limits
22h	Write Fault	<ul style="list-style-type: none"><li>• Parameter change during running or under-voltage</li><li>• ENTER command was written during running</li><li>• Write attempted to read-only data or during under-voltage</li><li>• Write attempted during parameter data storage</li></ul>



# Handshaking

The handshaking register is necessary to synchronize the send/receive timing of parameter access message data between the PROFIBUS-DP Master and the V7 PROFIBUS-DP Option. One register (byte 32 of the 16 word input/output message or byte 12 of the 6 word input/output message) in the input and output parameter access message areas is dedicated to handshaking. The data set in the output area of the master becomes enabled in the V7 PROFIBUS-DP Option when the status of the HS bit, bit 7, is changed.

## ◆ Command Handshaking Register PROFIBUS-DP Master To V7

Table 3.16 – Handshaking Output Register Bit Definitions		
Bit	Name	Function
7	HS	Handshaking bit. Used to synchronize the data exchange. Toggled when a new command is transmitted. This bit must be cleared after power-up or re-initialization by the Master program.
6 - 0		Not used.

## ◆ Response Handshake Register V7 To PROFIBUS-DP Master

Table 3.17 – Handshaking Input Register Bit Definitions		
Bit	Name	Function
7	HS	Handshaking bit. Used to synchronize the data exchange. Toggled when a new response is transmitted
6 - 5	STATUS	Status of data exchanged between Communication Option and drive. 00H: Idle 01H: Sending parameter access message to drive 10H: Waiting for parameter access response from drive 11H: Response received from drive
4 - 1	WD	Watch Dog Counter, incremented approximately every 64 ms.
0		Not used

This page intentionally left blank.

# Appendix A Product Specification

*This appendix describes the specification for the PROFIBUS-DP Option interface car.*

Table A.1 – Product Specification	
V7 PROFIBUS-DP Option	
Ambient Temperature	-10 to +45°C (14 to 113°F)
Storage Temperature	-20 to +60°C (-4 to 140°F)
Relative Humidity	Not to exceed 90% RH (non-condensing)
Altitude	Not to exceed 1000m (3280ft)
Vibration	1G (9.8m/s <sup>2</sup> ) at 10 to 20Hz. 0.2G (2m/s <sup>2</sup> ) at 20 to 50Hz.
PROFIBUS-DP Specification	PROFIBUS-DP Slave- EN 50170
PROFIBUS-DP Profile	Vendor-Specific, PNO-approved
Connector Type	6-pin open-style screw connector
Physical Layer Type	Isolated Physical Layer (RS485 transceiver + photo-coupler)
Node Address Setting	2 Decimal Rotary Switches: address 1 to 99
Baud Rate	Auto-configure: 9600 bps to 12 Mbps
ASIC Implementation	SPC 3
Feature Support	Freeze Mode, Sync Mode, Auto Baud

This page intentionally left blank.

# Appendix B Parameter Access

---

*This appendix describes in detail how to read and write parameter data to and from the V7 drive.*

<b>Parameter Access Overview.....</b>	<b>B - 3</b>
<b>Read Drive Data Example .....</b>	<b>B - 5</b>
<b>Read Drive Data Error Example.....</b>	<b>B - 6</b>
<b>Write Drive Data Example .....</b>	<b>B - 7</b>
<b>Write Drive Data Error Example .....</b>	<b>B - 8</b>

This page intentionally left blank.

# Parameter Access Overview

Parameter access allows the reading and writing of drive parameters. For a detailed description of the V7 drive parameters refer to the *V7 MODBUS<sup>®</sup> Technical Manual*.

---

## ◆ Initialize Data Structures

Prior to setting the command message, insure that the command message handshake byte **HS, bit 7**, bit matches the **HS** bit, bit 7, of the response message.

---

## ◆ Set PROFIBUS-DP Master Command Message

- **Function Code:** Enter 03h (0000 0011) to read data from the drive or 10h (1010 0000) to write data to the drive. If no parameter access messaging is required, enter 00h as the function code.
- **Addressing:** All register addresses consist of two (2) bytes. The most significant byte, the upper half, is entered as the **Starting Address MSB**. The least significant byte, the lower half, is entered as the **Starting Address LSB**. If more than one V7 register is to be accessed, only valid with 16 word input/output messages, the registers must be consecutive beginning with the register at the starting address.
  - **Starting Address MSB:** Enter the upper half of the starting address. For address 1234h, enter 12h.
  - **Starting Address LSB:** Enter the lower half of the starting address. For address 1234h, enter 34h.
- **Data Quantity:** Enter the quantity of data to either read or write. Each register contains 2 data bytes. To read or write 1 register, enter 2. To read or write 2 registers, enter 4. For 6 word input/output messages, 2 is the only valid entry.
- **Data:** All drive register data consists of 2 bytes. The most significant byte, the upper half, of the value is contained in **Data # MSB**. The least significant byte, the lower half, is contained in **Data # LSB**. For reading data from the drive, these registers must be set to 0. For writing data to the drive, enter the data in the order that it is to be written to the drive at consecutive addresses starting with the address entered as the Starting Address. For 16 word input/output messages, if data is to be written to 2 registers, enter the appropriate values into Data 1 and Data 2. Data 3 and Data 4 must contain 0.
  - **Data # MSB:** To read drive data, set this value to 0. To write data, enter the most significant byte, the upper half, of the data to be written. To write data 5678h, enter 56h. To write more than one register, valid for 16 word input/output messages only, the registers must be consecutive starting with the address entered as the Starting Address.
  - **Data # LSB:** To read drive data, set this value to 0. To write data, enter the least significant byte, the lower half, of the data to be written. To write data 5678h, enter 78h. To write more than one register, valid for 16 word input/output messages only, the registers must be consecutive starting with the address entered as the Starting Address.
- **Handshaking:** Set the **HS** bit, the MSB, bit 7, of the command message handshaking byte to the same state as the **HS** bit, the MSB, bit 7, of the response message handshaking byte.

---

## ◆ Toggle the PROFIBUS-DP Master Handshake Bit

Toggle the command message Handshake MSB, the most significant bit, bit 7, to signal the drive that the command message contains a valid parameter access section. Make sure that all data has been entered into the command message before setting this bit. It is advisable to insert at least one processor scan between setting the command message and setting the handshake bit. Maintain the state of the HS bit until another command is to be sent to the drive.

---

## ◆ Message Received By PROFIBUS-DP Option - Ignore All Response Data

To signify the receipt of the command message, the PROFIBUS-DP Option will set the response message handshaking **HS** bit to match the state of the command message handshaking **HS** bit. Depending on the scan time of the PROFIBUS-DP Master and the interval between reviewing response messages, the PROFIBUS-DP Master may not see this response.

## ◆ Message Sent To Drive - Ignore All Response Data

The PROFIBUS-DP Option formats the Parameter Access command message and transmits it to the drive, setting bit 5 of the response message handshake. Depending on the scan time of the PROFIBUS-DP Master and the interval between reviewing response messages, the PROFIBUS-DP Master may not see this response.

---

## ◆ Wait For Drive Response - Ignore All Response Data.

Upon receiving the Parameter Access message from the PROFIBUS-DP Option, the drive processes the message, setting bit 6 and resetting bit 5 of the response message handshake. This processing typically takes 10ms to 15ms dependant on the state of the drive at the time of receiving the message. Depending on the scan time of the PROFIBUS-DP Master and the interval between reviewing response messages, the PROFIBUS-DP Master may not see this response.

---

## ◆ Process Response – Store And Process Data

The response message handshake byte bits 5 and 6 are set to signal that the drive has completed processing the Parameter Access message. If the command message was to read drive data, the data bytes will now contain valid data. If the command message was to write drive data, the data has been successfully written.



# Read Drive Data Example

Table B.2 – Read Drive Data Example				
PROFIBUS-DP Master Command		Initialize Data Structures	Drive Response	
Function Code	00h	Set the command message handshake byte <b>HS</b> bit to the same state as the response message handshake <b>HS</b> bit.	Function Code	03h
Starting Address MSB	00h		Starting Address MSB	01h
Starting Address LSB	00h		Starting Address LSB	00h
Data Quantity	00h		Data Quantity	02h
Data 1 MSB	00h		Data 1 MSB	00h
Data 1 LSB	00h		Data 1 LSB	00h
Handshaking (1000 0000)	80h		Handshaking (1110 0000)	E0h
PROFIBUS-DP Master Command		Set PROFIBUS-DP Master Command Message	Drive Response	
Function Code	03h	Set the <b>Function Code</b> , <b>Starting Address</b> , and <b>Data Quantity</b> . This example configures the command message to retrieve data from drive register at address 0037h, Output Power. For detailed information of drive registers refer to the <i>V7 Technical Manual</i> and the <i>V7 MODBUS® Technical Manual</i> .	Function Code	03h
Starting Address MSB	00h		Starting Address MSB	01h
Starting Address LSB	37h		Starting Address LSB	00h
Data Quantity	02h		Data Quantity	02h
Data 1 MSB	00h		Data 1 MSB	00h
Data 1 LSB	00h		Data 1 LSB	00h
Handshaking (1000 0000)	80h		Handshaking (1110 0000)	E0h
PROFIBUS-DP Master Command		Toggle the PROFIBUS-DP Master Handshake Bit	Drive Response	
Function Code	03h	After the data bits have been set, toggle the <b>HS</b> bit, bit 7, of the command handshake byte to signal the drive that the command message contains a Parameter Access command. On receipt of the command message, the <b>HS</b> bit, bit 7, of the response message handshake byte is set to the same state as the <b>HS</b> bit of the command message handshake byte. As the response message may contain invalid data, ignore all response message data.	Function Code	
Starting Address MSB	00h		Starting Address MSB	
Starting Address LSB	37h		Starting Address LSB	
Data Quantity	02h		Data Quantity	
Data 1 MSB	00h		Data 1 MSB	
Data 1 LSB	00h		Data 1 LSB	
Handshaking (0000 0000)	00h		Handshaking (0000 0000)	00h
PROFIBUS-DP Master Command		Wait for Response	Drive Response	
Function Code	03h	The PROFIBUS-DP Option formats the command message and transmits it to the drive, setting bit 5 of the response handshake byte. As the response message may contain invalid data, ignore all response message data.	Function Code	
Starting Address MSB	00h		Starting Address MSB	
Starting Address LSB	37h		Starting Address LSB	
Data Quantity	02h		Data Quantity	
Data 1 MSB	00h		Data 1 MSB	
Data 1 LSB	00h		Data 1 LSB	
Handshaking (0000 0000)	00h		Handshaking (0010 0000)	20h
PROFIBUS-DP Master Command		Wait for Response	Drive Response	
Function Code	03h	Bit 5 is reset and bit 6 set of the response handshake byte when the message has been received by the drive and that the drive has begun processing the message. As the response message may contain invalid data, ignore all response message data.	Function Code	
Starting Address MSB	00h		Starting Address MSB	
Starting Address LSB	37h		Starting Address LSB	
Data Quantity	02h		Data Quantity	
Data 1 MSB	00h		Data 1 MSB	
Data 1 LSB	00h		Data 1 LSB	
Handshaking (0000 0000)	00h		Handshaking (0100 0000)	40h
PROFIBUS-DP Master Command		Process Response	Drive Response	
Function Code	03h	Bits 5 and 6 of the response byte handshake are both set when the processing has been completed and the response message contains valid data.	Function Code	03h
Starting Address MSB	00h		Starting Address MSB	00h
Starting Address LSB	37h		Starting Address LSB	37h
Data Quantity	02h		Data Quantity	02h
Data 1 MSB	00h		Data 1 MSB	00h
Data 1 LSB	00h		Data 1 LSB	15h
Handshaking (0000 0000)	00h		Handshaking (0110 0000)	60h

# Read Drive Data Error Example

Table B.3 – Read Drive Data Error Example

PROFIBUS-DP Master Command		Initialize Data Structures	Drive Response	
Function Code	00h	Set the command message handshake byte <b>HS</b> bit to the same state as the response message handshake <b>HS</b> bit.	Function Code	03h
Starting Address MSB	00h		Starting Address MSB	01h
Starting Address LSB	00h		Starting Address LSB	00h
Data Quantity	00h		Data Quantity	02h
Data 1 MSB	00h		Data 1 MSB	00h
Data 1 LSB	00h		Data 1 LSB	00h
Handshaking (0000 0000)	00h		Handshaking (0110 0000)	60h
PROFIBUS-DP Master Command		Set PROFIBUS-DP Master Command Message	Drive Response	
Function Code	03h	Set the <b>Function Code</b> , <b>Starting Address</b> , and <b>Data Quantity</b> . This example configures the command message to retrieve data from drive register at address 0037h, Output Power. For detailed information of drive registers refer to the <i>V7 Technical Manual</i> and the <i>V7 MODBUS® Technical Manual</i> . For the purposes of this example, an invalid Starting Address was entered.	Function Code	03h
Starting Address MSB	10h		Starting Address MSB	01h
Starting Address LSB	00h		Starting Address LSB	00h
Data Quantity	02h		Data Quantity	02h
Data 1 MSB	00h		Data 1 MSB	00h
Data 1 LSB	00h		Data 1 LSB	00h
Handshaking (0000 0000)	00h		Handshaking (0110 0000)	60h
PROFIBUS-DP Master Command		Toggle the PROFIBUS-DP Master Handshake Bit	Drive Response	
Function Code	03h	After the data bits have been set, toggle the <b>HS</b> bit, bit 7, of the command handshake byte to signal the drive that the command message contains a Parameter Access command. On receipt of the command message, the <b>HS</b> bit, bit 7, of the response message handshake byte is set to the same state as the <b>HS</b> bit of the command message handshake byte. As the response message may contain invalid data, ignore all response message data.	Function Code	
Starting Address MSB	10h		Starting Address MSB	
Starting Address LSB	00h		Starting Address LSB	
Data Quantity	02h		Data Quantity	
Data 1 MSB	00h		Data 1 MSB	
Data 1 LSB	00h		Data 1 LSB	
Handshaking (1000 0000)	80h		Handshaking (1000 0000)	80h
PROFIBUS-DP Master Command		Wait for Response	Drive Response	
Function Code	03h	The PROFIBUS-DP Option formats the command message and transmits it to the drive, setting bit 5 of the response handshake byte. As the response message may contain invalid data, ignore all response message data.	Function Code	
Starting Address MSB	10h		Starting Address MSB	
Starting Address LSB	00h		Starting Address LSB	
Data Quantity	02h		Data Quantity	
Data 1 MSB	00h		Data 1 MSB	
Data 1 LSB	00h		Data 1 LSB	
Handshaking (1000 0000)	80h		Handshaking (1010 0000)	A0h
PROFIBUS-DP Master Command		Wait for Response	Drive Response	
Function Code	03h	Bit 5 is reset and bit 6 set of the response handshake byte when the message has been received by the drive and that the drive has begun processing the message. As the response message may contain invalid data, ignore all response message data.	Function Code	
Starting Address MSB	10h		Starting Address MSB	
Starting Address LSB	00h		Starting Address LSB	
Data Quantity	02h		Data Quantity	
Data 1 MSB	00h		Data 1 MSB	
Data 1 LSB	00h		Data 1 LSB	
Handshaking (1000 0000)	80h		Handshaking (1100 0000)	C0h
PROFIBUS-DP Master Command		Process Response	Drive Response	
Function Code	03h	Bits 5 and 6 of the response handshake byte are both set when the processing has been completed and the response message contains valid data. The MSB of the function code signifies an error response and Data 1 LSB contains the error code. Refer to Parameter Access Error Messages section of Chapter 3	Function Code	83h
Starting Address MSB	10h		Starting Address MSB	00h
Starting Address LSB	00h		Starting Address LSB	00h
Data Quantity	02h		Data Quantity	02h
Data 1 MSB	00h		Data 1 MSB	00h
Data 1 LSB	00h		Data 1 LSB	02h
Handshaking (1000 0000)	80h		Handshaking (1110 0000)	E0h

# Write Drive Data Example

Table B.4 – Write Drive Data Example

PROFIBUS-DP Master Command		Initialize Data Structures	Drive Response	
Function Code	00h	Set the command message handshake byte <b>HS</b> bit to the same state as the response message handshake <b>HS</b> bit.	Function Code	03h
Starting Address MSB	00h		Starting Address MSB	01h
Starting Address LSB	00h		Starting Address LSB	00h
Data Quantity	00h		Data Quantity	02h
Data 1 MSB	00h		Data 1 MSB	00h
Data 1 LSB	00h		Data 1 LSB	00h
Handshaking (1000 0000)	00h		Handshaking (0110 0000)	60h
PROFIBUS-DP Master Command		Set PROFIBUS-DP Master Command Message	Drive Response	
Function Code	10h	Set the <b>Function Code</b> , <b>Starting Address</b> , and <b>Data Quantity</b> . This example configures the command message to retrieve data from drive register at address 0037h, Output Power. For detailed information of drive registers refer to the <i>V7 Technical Manual</i> and the <i>V7 MODBUS® Technical Manual</i> .	Function Code	03h
Starting Address MSB	01h		Starting Address MSB	01h
Starting Address LSB	05h		Starting Address LSB	00h
Data Quantity	02h		Data Quantity	02h
Data 1 MSB	00h		Data 1 MSB	00h
Data 1 LSB	01h		Data 1 LSB	00h
Handshaking (0000 0000)	00h		Handshaking (0000 0000)	00h
PROFIBUS-DP Master Command		Toggle the PROFIBUS-DP Master Handshake Bit	Drive Response	
Function Code	10h	After the data bits have been set, toggle the <b>HS</b> bit, bit 7, of the command handshake byte to signal the drive that the command message contains a Parameter Access command. On receipt of the command message, the <b>HS</b> bit, bit 7, of the response message handshake byte is set to the same state as the <b>HS</b> bit of the command message handshake byte. As the response message may contain invalid data, ignore all response message data.	Function Code	
Starting Address MSB	01h		Starting Address MSB	
Starting Address LSB	05h		Starting Address LSB	
Data Quantity	02h		Data Quantity	
Data 1 MSB	00h		Data 1 MSB	
Data 1 LSB	01h		Data 1 LSB	
Handshaking (1000 0000)	80h		Handshaking (1000 0000)	80h
PROFIBUS-DP Master Command		Wait for Response	Drive Response	
Function Code	10h	The PROFIBUS-DP Option formats the command message and transmits it to the drive, setting bit 5 of the response handshake byte. As the response message may contain invalid data, ignore all response message data.	Function Code	
Starting Address MSB	01h		Starting Address MSB	
Starting Address LSB	05h		Starting Address LSB	
Data Quantity	02h		Data Quantity	
Data 1 MSB	00h		Data 1 MSB	
Data 1 LSB	01h		Data 1 LSB	
Handshaking (1000 0000)	80h		Handshaking (1010 0000)	A0h
PROFIBUS-DP Master Command		Wait for Response	Drive Response	
Function Code	10h	Bit 5 is reset and bit 6 set of the response handshake byte when the message has been received by the drive and that the drive has begun processing the message. As the response message may contain invalid data, ignore all response message data.	Function Code	
Starting Address MSB	01h		Starting Address MSB	
Starting Address LSB	05h		Starting Address LSB	
Data Quantity	02h		Data Quantity	
Data 1 MSB	00h		Data 1 MSB	
Data 1 LSB	01h		Data 1 LSB	
Handshaking (1000 0000)	80h		Handshaking (1100 0000)	C0h
PROFIBUS-DP Master Command		Process Response	Drive Response	
Function Code	10h	Bits 5 and 6 of the response handshake byte are both set when the processing has been completed and the response message contains valid data.	Function Code	10h
Starting Address MSB	01h		Starting Address MSB	01h
Starting Address LSB	05h		Starting Address LSB	05h
Data Quantity	02h		Data Quantity	02h
Data 1 MSB	00h		Data 1 MSB	00h
Data 1 LSB	01h		Data 1 LSB	00h
Handshaking (1000 0000)	80h		Handshaking (1110 0000)	E0h

# Write Drive Data Error Example

Table B.5 – Write Drive Data Error Example

PROFIBUS-DP Master Command		Initialize Data Structures	Drive Response	
Function Code	00h	Set the command message handshake byte <b>HS</b> bit to the same state as the response message handshake <b>HS</b> bit.	Function Code	03h
Starting Address MSB	00h		Starting Address MSB	01h
Starting Address LSB	00h		Starting Address LSB	00h
Data Quantity	00h		Data Quantity	02h
Data 1 MSB	00h		Data 1 MSB	00h
Data 1 LSB	00h		Data 1 LSB	00h
Handshaking (1000 0000)	80h		Handshaking (0110 0000)	60h
PROFIBUS-DP Master Command		Set PROFIBUS-DP Master Command Message	Drive Response	
Function Code	10h	Set the <b>Function Code</b> , <b>Starting Address</b> , and <b>Data Quantity</b> . This example configures the command message to retrieve data from drive register at address 0037h, Output Power. For detailed information of drive registers refer to the <i>V7 Technical Manual</i> and the <i>V7 MODBUS® Technical Manual</i> . For the purposes of this example an invalid Starting Address was used.	Function Code	03h
Starting Address MSB	10h		Starting Address MSB	00h
Starting Address LSB	00h		Starting Address LSB	37h
Data Quantity	02h		Data Quantity	02h
Data 1 MSB	00h		Data 1 MSB	00h
Data 1 LSB	01h		Data 1 LSB	00h
Handshaking (1000 0000)	80h		Handshaking (1110 0000)	E0h
PROFIBUS-DP Master Command		Toggle the PROFIBUS-DP Master Handshake Bit	Drive Response	
Function Code	10h	After the data bits have been set, toggle the <b>HS</b> bit, bit 7, of the command handshake byte to signal the drive that the command message contains a Parameter Access command. On receipt of the command message, the <b>HS</b> bit, bit 7, of the response message handshake byte is set to the same state as the <b>HS</b> bit of the command message handshake byte. As the response message may contain invalid data, ignore all response message data.	Function Code	
Starting Address MSB	10h		Starting Address MSB	
Starting Address LSB	00h		Starting Address LSB	
Data Quantity	02h		Data Quantity	
Data 1 MSB	00h		Data 1 MSB	
Data 1 LSB	01h		Data 1 LSB	
Handshaking (0000 0000)	00h		Handshaking (0000 0000)	00h
PROFIBUS-DP Master Command		Wait for Response	Drive Response	
Function Code	10h	The PROFIBUS-DP Option formats the command message and transmits it to the drive, setting bit 5 of the response handshake byte. As the response message may contain invalid data, ignore all response message data.	Function Code	
Starting Address MSB	10h		Starting Address MSB	
Starting Address LSB	00h		Starting Address LSB	
Data Quantity	02h		Data Quantity	
Data 1 MSB	00h		Data 1 MSB	
Data 1 LSB	01h		Data 1 LSB	
Handshaking (1000 0000)	00h		Handshaking (0010 0000)	20h
PROFIBUS-DP Master Command		Wait for Response	Drive Response	
Function Code	10h	Bit 5 is reset and bit 6 set of the response handshake byte when the message has been received by the drive and that the drive has begun processing the message. As the response message may contain invalid data, ignore all response message data.	Function Code	
Starting Address MSB	10h		Starting Address MSB	
Starting Address LSB	00h		Starting Address LSB	
Data Quantity	02h		Data Quantity	
Data 1 MSB	00h		Data 1 MSB	
Data 1 LSB	01h		Data 1 LSB	
Handshaking (0000 0000)	00h		Handshaking (0100 0000)	40h
PROFIBUS-DP Master Command		Process Response	Drive Response	
Function Code	10h	Bits 5 and 6 of the response handshake byte are both set when the processing has been completed and the response message contains valid data. The MSB of the function code signifies an error response and Data 1 LSB contains the error code. Refer to Parameter Access Error Message section of Chapter for error code description.	Function Code	90h
Starting Address MSB	10h		Starting Address MSB	00h
Starting Address LSB	00h		Starting Address LSB	00h
Data Quantity	02h		Data Quantity	02h
Data 1 MSB	00h		Data 1 MSB	00h
Data 1 LSB	01h		Data 1 LSB	22h
Handshaking (0000 0000)	80h		Handshaking (0110 0000)	60h

# Appendix C Troubleshooting

---

*This chapter is a basic troubleshooting guide. For detailed information on the V7 drive refer to the V7 Technical Manual. Detailed information on PROFIBUS-DP can be obtained from [www.profibus.com](http://www.profibus.com).*

<b>Troubleshooting Check List .....</b>	<b>C - 3</b>
<b>Installation Troubleshooting.....</b>	<b>C - 5</b>
<b>Wiring And Cabling .....</b>	<b>C - 8</b>
<b>PROFIBUS-DP Configuration .....</b>	<b>C - 11</b>
<b>V7 PROFIBUS-DP Interface Diagnostics .....</b>	<b>C - 12</b>

This page intentionally left blank.

# Troubleshooting Check List

- 1: The V7 drive operates correctly without the PROFIBUS-DP Option installed  
Drive model number \_\_\_\_\_
- 2: The V7 PROFIBUS-DP Option is correctly and securely installed on the drive  
PROFIBUS-DP Option Code number \_\_\_\_\_
- 3: All network devices have unique addresses and drives are addressed between 1 and 99  
Drive address \_\_\_\_\_  
S1 \_\_\_\_\_  
S2 \_\_\_\_\_
- 4: The Run/Stop command source parameter, n003, is set correctly  
n003 \_\_\_\_\_
- 5: The Frequency Reference command source parameter, n004, is set correctly  
n004 \_\_\_\_\_
- 6: The correct cable type is used. Mfg. \_\_\_\_\_ PN \_\_\_\_\_
- 7: All cable connections are correct per device schematic and are secure
- 8: All cables have been checked for continuity. There are no breaks or shorts.
- 9: Cable length between nodes is at least 1 meter
- 10: Maximum segment and maximum network lengths do not exceed the maximum allowed
- 11: The total stub lengths do not exceed the maximum allowed
- 12: There are no more than 32 devices on each segment, including repeaters and controllers.  
There are no more than 31 devices on each segment if no repeaters are used.
- 13: The network is correctly terminated on each end and only at each end.
- 14: The shield is continuous throughout the network and is properly grounded on each end.
- 15: The network cable is routed away from any high voltage cable(s) or source(s).
- 16: The correct GSD file is used. GSD file name \_\_\_\_\_ .GSD
- 17: The controller scan list is configured to send and receive the correct amount of data.
- 18: The PROFIBUS-DP LEDs are in their correct on/off states.
- 19: All network devices have been tested for conformance with the PROFIBUS-DP specification.

## WARNING

- Do not attempt to disassemble this unit. There are no user serviceable parts. Disassembling this unit will void any and all warranties.

This page intentionally left blank.



# Installation Troubleshooting

The following is a short guide to troubleshooting V7 PROFIBUS-DP Option installation. It highlights some of the most common issues faced when diagnosing and correcting issues associated with the startup and operation of a V7 drive with a PROFIBUS-DP industrial network. Further information on the features of each interface can be found in the *V7 PROFIBUS-DP Option Technical Manual*. While most of the information is centered on the application of V7, the guidelines presented are applicable in most PROFIBUS-DP Networks.

Diagnosis of network fault issues will typically fall into three categories: installation of the PROFIBUS-DP option, wiring and cabling issues, and network configuration/diagnostics. Each of these areas will be discussed below to help resolve common problems associated in PROFIBUS-DP network troubleshooting.

---

## ◆ Drive Operates Correctly Without Network Option Installed

Before installing any drive option, **verify that the drive functions properly without the option installed**. Refer to the *V7 Technical Manual*, for information on the drive's installation and operation.

---

## ◆ The PROFIBUS-DP Option Is Properly Installed.

Verify that the connection between CN1 and CN3 on the PROFIBUS-DP Option are securely connected to CN2 and CN1, respectively, on the V7 drive. Verify that the four locking tabs on the PROFIBUS-DP Option are engaged and that the option is fully seated and flush on top of the V7

---

## ◆ Verify And Write Down The Code Number Of The PROFIBUS-DP Option.

The Code Number can be found on the nameplate on the side of the PROFIBUS-DP Option and specifies the version of the interface unit. This Code Number is necessary to select the proper GSD file. It will also be useful if technical support should become necessary.

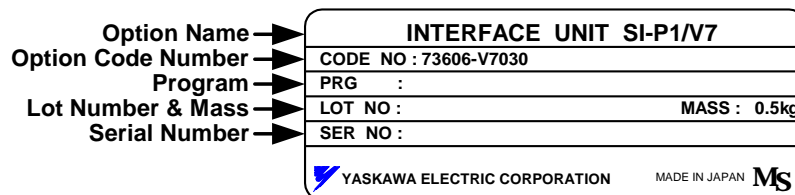

Figure C.1 – Option Nameplate

## ◆ Network Cable Is Connected Correctly

- Determine the type of connector on the *V7 PROFIBUS-DP Option*. Connector Style A is an extended Phoenix connector. The extension can be seen on the back of the connector as a small circuit board. Connector Style B is a standard phoenix connector without any modifications.
- Connect the PROFIBUS-DP network cable to the *V7 PROFIBUS-DP Option*. Refer to the appropriate connection drawing in Figure C.2 below for your connector style.
- Use standard PROFIBUS-DP cable as specified by the PROFIBUS Organization.

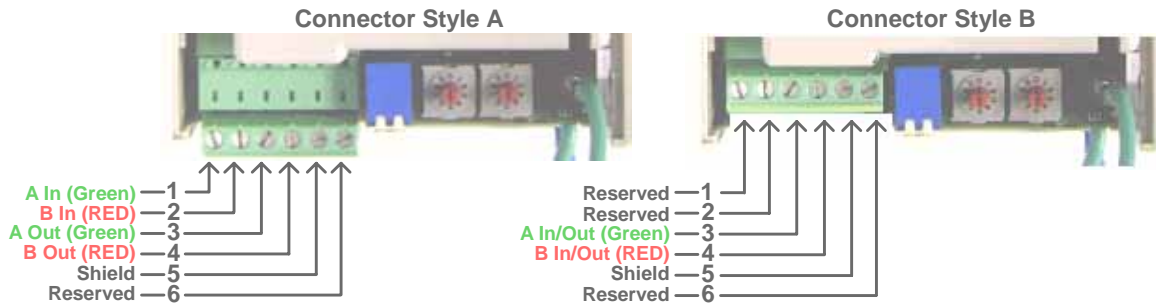

Figure C.2 – V7 PROFIBUS-DP Option Connections

## ◆ Run/Stop Operation Parameter Is Set Correctly.

Parameter n003 needs to be set to the source of the V7's Run/Stop command. If the V7 receives the Run/Stop command from the PROFIBUS-DP network, parameter n003 must be set to "3 – Option Card". Refer to the *V7 Technical Manual* for further explanation of this parameter.

Table C.1 - V7 Run/Stop Reference Source

Parameter	Value	Description
n003	0	Operator Keypad
	1	External Terminals
	2	Serial Communications
	3	<b>Option Card (PROFIBUS-DP Communications)</b>

## ◆ Frequency Reference Parameter Is Set Correctly

Parameter n004 needs to be set to the source of the V7's frequency reference command. If the V7 receives its frequency reference from the PROFIBUS-DP network, parameter n004 must be set to "9 – Option Card". Refer to the *V7 Technical Manual* for further explanation of this parameter.

Table C.2 - V7 Frequency Reference Source

Parameter	Value	Description
n004	0	Operator keypad
	1	Parameter n024
	2	Voltage Reference (0 – 10 vdc)
	3	Current Reference (4 – 20 ma)
	4	Current Reference (0 – 20 ma)
	5	Pulse Train Reference
	6	Serial Communications
	7	Multi-function analog Input (1 – 10 vdc)
	8	Multi-function Analog Input (4 – 20 ma)
	9	<b>Option Card (PROFIBUS-DP Communications)</b>

## ◆ The Network Address Correct And Unique.

Each device on the network must have a unique address. Valid addresses are 1 through 99 with 1 typically reserved for the PROFIBUS-DP Master and 2 reserved for diagnostic equipment. Set the V7 network address via rotary switches S1(x1) and S2(x10). To set a V7 to address 15, set S2 to 1 and S1 to 5.

$$\text{Address} = (\text{Switch 2} \times 10) + (\text{Switch 1} \times 1)$$

Example: Set node address to 15

Set address switch 2 to "1"

Set address switch 1 to "5"

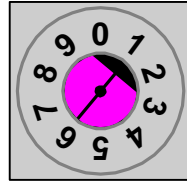

S2

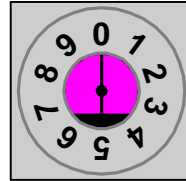

S1

Figure C.3 – V7 PROFIBUS-DP Option Addressing

# Wiring And Cabling

Several serial communications troubleshooting issues can be traced to cabling and grounding. The V7 PROFIBUS-DP Option is based on RS485 differential line technology, and specifies the cable to be used, i.e. cable length requirements, termination requirements, number of nodes allowed per segment, etc. The following lists and describes the items that should be checked during the network installation to verify correct cabling and grounding. Failure to follow the following guidelines could result in total or intermittent communications failure.

---

## ◆ The Network Cable Is The Correct Type.

The cable used by the PROFIBUS-DP network is specified by PROFIBUS European Standard EN50170. It is a shielded, twisted pair cable with the following specifications. In order for the cable to fit the currently available PROFIBUS-DP standard connectors, the surrounding diameter must be 8.0mm (+/- 0.5 mm).

Parameter	PROFIBUS-DP Cable Requirements
Impedance	135 to 165 Ohm / 3 to 20Mhz
Capacitance	< 30 pF / m
Resistance	< 110 Ohm / Km
Wire Gauge	> 0.64 mm
Conductor Area	> 0.34 mm <sup>2</sup>
Shield Density	Greater than 80%

---

## ◆ Cable Is Correctly And Securely Connected

Check for shorts, broken wires, loose connections, and that the signal and shield wires are connected to the correct pin on the option connector. See *Figure C.3 – V7 PROFIBUS-DP Option Connections* above for required wiring.

---

## ◆ Cable Lengths Are Within Specified Limits

Both data rate and cable type affect the total allowable length of the network. The total amount of measured linear cable allowed between any two points on the network segment must be within the following table's specification. Also, the total amount of network length, allowed through segment repeaters must be less than the Maximum Network Length in the following table. The minimum distance of cable that is required between device connections to the PROFIBUS-DP physical media is a distance of one (1) meter.

Baud Rate	Maximum Segment Length	Maximum Network Length
9.6 Kbps	1,200 Meters	10,000 Meters
187.5 Kbps	1,000 Meters	10,000 Meters
500.0 Kbps	400 Meters	4,000 Meters
1.5 Mbps	200 Meters	2,000 Meters
3.0 Mbps	100 Meters	1,000 Meters
6.0 Mbps	100 Meters	1,000 Meters
12.0 Mbps	100 Meters	1,000 Meters

## ◆ Stub Lengths Are Within Specified Limits

The total amount of measured linear cable allowed between the point of the stub connection (from the main PROFIBUS-DP cable) to the node connection on the line, along with the cumulative total or sum of all stub cable length(s) must not exceed the maximum specified. When calculating stub lengths, include stub in the device itself. Use 1cm for each V7 drive. The following table and diagram specifies the stub length requirements. **DO NOT use stubs when the PROFIBUS-DP network is configured to operate at baud rates above 1.5Mbps**

Baud Rate	Total Capacitance for all Stubs	Total Stub Length
9.6 Kbps	15.0 nF	500 Meters
187.5 Kbps	3.0 nF	100 Meters
500.0 Kbps	1.0 nF	33 Meters
1.5 Mbps	0.6 nF	20 Meters
3.0 Mbps	0.2 nF	Approx. 0
6.0 Mbps	Stubs Not Allowed	Approx. 0
12.0 Mbps	Stubs Not Allowed	Approx. 0

## ◆ There Are No More Than 32 Total Devices On Each Network Segment.

This means that only 31 physical devices can be connected on one PROFIBUS-DP network segment without a repeater. Verify that there are no more than 31 physical nodes on the network segment, which includes all Master/PLC connections, slave devices, and configuration nodes for all connections. If there are more than 31 devices, you must add a repeater between the network segments to separate the devices into two separate copper buses. Note, the reason for using RS485 repeaters is for allowing more than 32 devices to talk to one Master PLC port, or there is a need to operate bus segments as ungrounded with reference to each other, or the network segment exceeds the maximum length per the operating baud rate. Up to nine (9) RS485 repeaters can be used in cascade (in-line).

## ◆ The Network Is Terminated Correctly.

A PROFIBUS-DP network copper bus segment is based on an RS485 standard and requires two (2) and only two (2), termination resistors of 120 ohms, ¼ watt, at each of the furthest ends of the PROFIBUS-DP cabling. Typically, a good place for the termination resistors to be ON is at the PLC connector (only, if the network segment starts at that point) and, at the last device on the network segment. This is to keep transmission signal distortion to a minimum along all sections of the network bus.

- If the last device on the network is a drive, the termination switch on the PROFIBUS-DP Option may be used. Set the switch to the ON position.
- Active Termination Devices are the preferred method of terminating the network. They must be continually powered to function correctly and must be used for transmission rates above 1.5 Mbps. The Siemens P/N for the Active Terminator Module is 6ES7 972-0DA00-0AA0.



Figure C.4 – V7 PROFIBUS-DP Option Termination Settings

### ◆ Common Mode Voltage Between Any Two Points Is Less Than 7vdc.

RS485 requires that the common mode voltage be less than 7vdc. Large voltage potential differences between points on the network, may cause equalization current flow in the shield. This interferes with the PROFIBUS-DP signal quality. If common mode voltage is greater than 7vdc, a separate ground conductor must connect the network devices to a central ground point, typically at the start of the segment.

---

### ◆ Shield Is Continuous And Both Ends Of The Shield Are Grounded.

The cable shields, between all nodes of the network segment shall be connected, to form a single conduction path throughout the segment. The shield must then be grounded at each endpoint

---

### ◆ Cable Is Routed Correctly

The PROFIBUS-DP network cable must not run parallel to or close to any high power or high frequency cables. A minimum clearance of 4" – 10" is required, depending on the level of voltage or signals in the cables. If network cables must cross high power or frequency cables, they must do so at a 90 deg angle.

# PROFIBUS-DP Configuration

In order for the V7 drive with the *V7 PROFIBUS-DP Option* to operate in a PROFIBUS-DP networked system, the PROFIBUS-DP master must be configured to recognize the V7 drive on the network. Typically, the master scan list is setup and modified with a PROFIBUS-DP configuration utility, such as *COM PROFIBUS* from Siemens. The configuration utility is typically provided by the vendor supplying the PROFIBUS-DP master.

The V7 drive is a slave device and requires a master PROFIBUS-DP scanner to communicate on a PROFIBUS-DP network. The V7 drive configuration entered into the master scan list, via the configuration utility, must match exactly the configuration built into the *V7 PROFIBUS-DP Option*. The V7 drive has diagnostic LEDs to annunciate the state of the PROFIBUS-DP network.

---

## ◆ Correct GSD file is used.

The configuration utility uses the GSD file to set certain parameters, including the Identification Number, the number of Input and Output words, the supported baud rates, etc. The GSD file is stored in the GSD sub-directory under the directory where *COM PROFIBUS* was originally installed. The “Scan GSD Files” option under the “File” menu can be used to load the GSD file information in *COM PROFIBUS* if it has not already loaded. In *COM PROFIBUS*, for example, the Station Type **PROFIBUS INTER** selects the V7 PROFIBUS-DP Option.

The filename of the current version of the GSD file, that is used for the *V7 PROFIBUS-DP Option* is, “YASK00CA.gsd”. This GSD file can be found at [www.drives.com](http://www.drives.com).

---

## ◆ Master Scan List Is Setup Correctly

Verify that the PROFIBUS-DP Master scan list is configured to send and receive the correct amount of data to each node on the PROFIBUS-DP network and that the PROFIBUS-DP Master has the devices correctly mapped in memory. There are several PROFIBUS-DP scanners on the market today. Some support the configuration tools mentioned above and some have their own configuration tools. Refer to the manufacturer’s documentation for determining how to verify and program the scan list settings in the PROFIBUS-DP Master.

The size and type of information expected from the PROFIBUS-DP Master scanner must match exactly (per the GSD file) the device configuration. Determine that the PROFIBUS-DP Master operational words to and from the PROFIBUS-DP device are mapped into the I/O space of the PROFIBUS-DP Master. For each specific PROFIBUS-DP Master, this I/O mapping may be different. Consult the PROFIBUS-DP Master documentation to insure correct I/O mapping.

---

## ◆ V7 PROFIBUS-DP Option Configuration

With **PROFIBUS-DP INTER** selected as the Station Type, three configuration selections will be displayed. Select the configuration applicable to the particular application. **Basic Data** consists of 3 word I/Os message (3 input words and 3 output words). **Extended Data 1** consists of 16 input words and 16 output words. **Extended Data 2** consists of 6 input words and 6 output words.

- The **Basic Data** configuration consists of 3 words of combined I/O. 3 input words and 3 output words. Refer to *3 Word I/O Message* section of *Chapter 3* for a detailed description of the **Basic Data** configuration.
- The **Extended Data 1** configuration consists of 16 input words and 16 output words. Refer to *16 Word Input/Output Message* section of *Chapter 3* for a detailed description of the **Extended Data 1** configuration. This configuration is also used on those *V7 PROFIBUS-DP Options* that have an Option Name SI-P/V7 or Code Numbers prior to 73606-7110. The Option Name and Code Number are located on the right side of the option.
- The **Extended Data 2** configuration consists of 6 input words and 6 output words. Refer to *6 Word Input/Output Message* section of *Chapter 3* for a detailed description of the **Extended Data 2** configuration. This configuration is also used on those *V7 PROFIBUS-DP Options* referred to as Profibus II.

# V7 PROFIBUS-DP Option Diagnostics

## ◆ The PROFIBUS-DP Option Is Operating Correctly

Verify that the PROFIBUS-DP interface unit on the V7 drive is operating correctly, by reporting the state of the LEDs on the Interface Unit. The drawing below shows the indication LEDs as they appear on the PROFIBUS-DP interface unit.

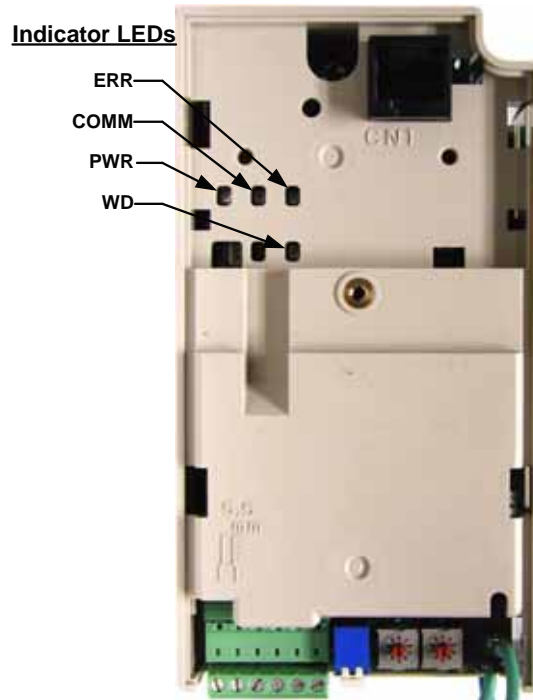

Figure C.5 – V7 PROFIBUS-DP LED Locations

## ◆ LED Indicators

The following LEDs indicates the PROFIBUS-DP status.

Table C.6 – Communication LEDs		
LED	Color	Indication/Function
COMM	Green	Lit during data exchange with the PROFIBUS-DP Master .
ERR	Red	Lit when no data exchange is taken place.



## ◆ Module Status Indicators

The following LEDs indicates the status of the V7 PROFIBUS-DP Option.

LED	Color	Indication/Function	
PWR	Green	Lit when the +5V power to the electronics is OK. Turned off if the +5V is below +4.5V (min)	
WD	Red/Green	Indicates the module status	
		OFF	Communication Option CPU not running.
		Solid Green:	Initialization.
		Flashing green:	Normal operation.
		Solid Red:	Internal Communication Option error.
		Flashing red:	V7 error detected.
		Other indication	Unspecified, Communication Option error

## ◆ LED Diagnostics

The following table presents the faults displayed by the LEDs on the communication Option, their causes, and countermeasures.

LED Display				Content	Cause	Counter measures
PWR	COM	ERR	WD			
OFF	OFF	OFF	OFF	Power OFF	Power is not being supplied from the drive. Power is not being supplied to the option unit due to poor option unit connection.	<ul style="list-style-type: none"> <li>Check the main circuit wiring on the drive.</li> <li>Cycle drive power.</li> <li>Turn of the drive power.</li> <li>Check the option unit connection to the drive.</li> <li>Cycle drive power.</li> </ul>
Solid Green	OFF	Solid Red	Solid Red	CPU Error	Option unit CPU error.	<ul style="list-style-type: none"> <li>Cycle drive power.</li> <li>Replace option unit if fault persists.</li> </ul>
Solid Green	OFF	Solid Red	Flashing Red	Drive Error	Error in Drive unit.	<ul style="list-style-type: none"> <li>Cycle drive power.</li> <li>Replace drive if fault persists.</li> </ul>
Solid Green	OFF	Flashing Red	Solid Green	Com Error	A fault has occurred rendering communication impossible.	<ul style="list-style-type: none"> <li>Check whether the address set in the PROFIBUS-DP Master differs from the address of the option unit.</li> <li>Check that the master is functioning properly.</li> <li>Check that the termination resistor is correctly connected to the communication line.</li> <li>Check whether the communication line is correctly connected (disconnected or poor connection).</li> <li>Check that the communication line is separated from the main power line.</li> </ul>
Solid Green	Solid Green	Flashing Red	Solid Green	Com Error	A fault has occurred rendering communication impossible.	<ul style="list-style-type: none"> <li>Check whether the address is duplicated with any other devices within the PROFIBUS-DP network.</li> </ul>
Solid Green	Solid Green	OFF	Solid Green	CPU Init	Option unit under initialization	<ul style="list-style-type: none"> <li>Wait until WD LED is flashing</li> </ul>
Solid Green	Solid Green	OFF	Flashing Green	Normal	Normal communication possible.	

## ◆ Drive Faults

The following is a table of drive faults that could be caused by the *V7 PROFIBUS-DP Option* that will be displayed on the V7 Operator Keypad, their causes, and possible solutions. For any fault displayed on the operator that is not listed in the following table, please see the *V7 Technical Manual*.

Table 1.9 – Drive Faults			
Fault	Content	Cause	Solution
BUS	Option Com Error	Communication is not established between PROFIBUS-DP Master and the drive.	<ul style="list-style-type: none"> <li>• Check PROFIBUS-DP communication LED display.</li> </ul>
EF0	External Fault from Option	External fault is active from PROFIBUS-DP option.	<ul style="list-style-type: none"> <li>• Turn OFF external fault input.</li> </ul>
F06	Option Connection Fault	The drive and communication are not correctly connected.	<ul style="list-style-type: none"> <li>• Turn OFF the drive power supply and check the connection of the option unit and drive, and then, turn ON the drive power supply. If the fault persists, change the option unit.</li> </ul>
F21	Communication Option Self-diagnostic Fault	Communication option is not working.	<ul style="list-style-type: none"> <li>• Turn the drive power supply back ON. If the fault persists, change the option unit.</li> </ul>
F22	Com Option Model Code No. Fault		
F23	Com Option Mutual Diagnostic Fault		



# V7 PROFIBUS-DP<sup>®</sup> Option



## **YASKAWA ELECTRIC AMERICA, INC.**

Drives Division  
16555 W. Ryerson Rd., New Berlin, WI 53151, U.S.A.  
Phone: (800) YASKAWA (800-927-5292) Fax: (262) 782-3418  
Internet: <http://www.drives.com>

## **YASKAWA ELECTRIC AMERICA, INC.**

Chicago-Corporate Headquarters  
2121 Norman Drive South, Waukegan, IL 60085, U.S.A.  
Phone: (800) YASKAWA (800-927-5292) Fax: (847) 887-7310  
Internet: <http://www.yaskawa.com>

## **MOTOMAN INC.**

805 Liberty Lane, West Carrollton, OH 45449, U.S.A.  
Phone: (937) 847-6200 Fax: (937) 847-6277  
Internet: <http://www.motoman.com>

## **YASKAWA ELECTRIC CORPORATION**

New Pier Takeshiba South Tower, 1-16-1, Kaigan, Minatoku, Tokyo, 105-0022, Japan  
Phone: 81-3-5402-4511 Fax: 81-3-5402-4580  
Internet: <http://www.yaskawa.co.jp>

## **YASKAWA ELETRICO DO BRASIL COMERCIO LTDA.**

Avenida Fagundes Filho, 620 Bairro Saude Sao Paulo-SP, Brasil CEP: 04304-000  
Phone: 55-11-5071-2552 Fax: 55-11-5581-8795  
Internet: <http://www.yaskawa.com.br>

## **YASKAWA ELECTRIC EUROPE GmbH**

Am Kronberger Hang 2, 65824 Schwalbach, Germany  
Phone: 49-6196-569-300 Fax: 49-6196-888-301

## **MOTOMAN ROBOTICS AB**

Box 504 S38525, Torsas, Sweden  
Phone: 46-486-48800 Fax: 46-486-41410

## **MOTOMAN ROBOTEC GmbH**

Kammerfeldstrabe 1, 85391 Allershausen, Germany  
Phone: 49-8166-900 Fax: 49-8166-9039

## **YASKAWA ELECTRIC UK LTD.**

1 Hunt Hill Orchardton Woods Cumbernauld, G68 9LF, Scotland, United Kingdom  
Phone: 44-12-3673-5000 Fax: 44-12-3645-8182

## **YASKAWA ELECTRIC KOREA CORPORATION**

Paik Nam Bldg, 901 188-3, 1-Ga Euljiro, Joong-Gu, Seoul, Korea  
Phone: 82-2-776-7844 Fax: 82-2-753-2639

## **YASKAWA ELECTRIC (SINGAPORE) PTE. LTD.**

Head Office: 151 Lorong Chuan, #04-01, New Tech Park Singapore 556741, Singapore  
Phone: 65-282-3003 Fax: 65-289-3003

## **TAIPEI OFFICE (AND YATEC ENGINEERING CORPORATION)**

10F 146 Sung Chiang Road, Taipei, Taiwan  
Phone: 886-2-2563-0010 Fax: 886-2-2567-4677

## **YASKAWA JASON (HK) COMPANY LIMITED**

Rm. 2909-10, Hong Kong Plaza, 186-191 Connaught Road West, Hong Kong  
Phone: 852-2803-2385 Fax: 852-2547-5773

## **BEIJING OFFICE**

Room No. 301 Office Building of Beijing International Club,  
21 Jianguomanwai Avenue, Beijing 100020, China  
Phone: 86-10-6532-1850 Fax: 86-10-6532-1851

## **SHANGHAI OFFICE**

27 Hui He Road Shanghai 200437 China  
Phone: 86-21-6553-6600 Fax: 86-21-6531-4242

## **SHANGHAI YASKAWA-TONJI M & E CO., LTD.**

27 Hui He Road Shanghai 200437 China  
Phone: 86-21-6533-2828 Fax: 86-21-6553-6677

## **BEIJING YASKAWA BEIKE AUTOMATION ENGINEERING CO., LTD.**

30 Xue Yuan Road, Haidian, Beijing 100083 China  
Phone: 86-10-6232-9943 Fax: 86-10-6234-5002

## **SHOUGANG MOTOMAN ROBOT CO., LTD.**

7, Yongchang-North Street, Beijing Economic & Technological Development Area,  
Beijing 100076 China  
Phone: 86-10-6788-0551 Fax: 86-10-6788-2878

## **YEA, TAICHUNG OFFICE IN TAIWAN**

B1, 6F, No.51, Section 2, Kung-Yi Road, Taichung City, Taiwan, R.O.C.  
Phone: 886-4-2320-2227 Fax: 886-4-2320-2239