

# YASKAWA AC Drive 1000-Series Option LCD Operator Installation Manual

Type JVOP-180

To properly use the product, read this manual thoroughly and retain for easy reference, inspection, and maintenance. Ensure the end user receives this manual.

## 安川インバータ 1000シリーズ オプション LCDオペレータ 取扱説明書

形 式 JVOP-180

製品を安全にお使い頂くために、本書を必ずお読みください。  
また、本書をお手元に保管していただくとともに、最終的に本製品をご使用するユーザー様のお手元に確実に届けられるよう、お取り計らい願います。

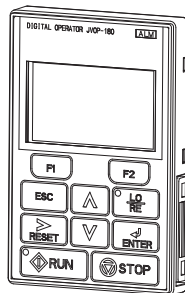

---

## **Copyright © 2007 YASKAWA ELECTRIC CORPORATION**

All rights reserved. No part of this publication may be reproduced, stored in a retrieval system, or transmitted, in any form or by any means, mechanical, electronic, photocopying, recording, or otherwise, without the prior written permission of Yaskawa. No patent liability is assumed with respect to the use of the information contained herein. Moreover, because Yaskawa is constantly striving to improve its high-quality products, the information contained in this manual is subject to change without notice. Every precaution has been taken in the preparation of this manual. Yaskawa assumes no responsibility for errors or omissions. Neither is any liability assumed for damages resulting from the use of the information contained in this publication.

# Table of Contents

---

<b>1 PREFACE AND SAFETY</b> .....	<b>4</b>
<b>2 PRODUCT OVERVIEW</b> .....	<b>8</b>
<b>3 RECEIVING</b> .....	<b>10</b>
<b>4 OPTION COMPONENTS</b> .....	<b>12</b>
<b>5 INSTALLATION PROCEDURE</b> .....	<b>22</b>
<b>6 BASIC OPERATION</b> .....	<b>28</b>
<b>7 RELATED PARAMETERS</b> .....	<b>51</b>
<b>8 OPTION FAULT DIAGNOSTICS</b> .....	<b>54</b>
<b>9 SPECIFICATIONS</b> .....	<b>56</b>
<b>10 REVISION HISTORY</b> .....	<b>57</b>

# 1 Preface and Safety

Yaskawa manufactures products used as components in a wide variety of industrial systems and equipment. The selection and application of Yaskawa products remain the responsibility of the equipment manufacturer or end user. Yaskawa accepts no responsibility for the way its products are incorporated into the final system design. Under no circumstances should any Yaskawa product be incorporated into any product or design as the exclusive or sole safety control. Without exception, all controls should be designed to detect faults dynamically and fail safely under all circumstances. All systems or equipment designed to incorporate a product manufactured by Yaskawa must be supplied to the end user with appropriate warnings and instructions as to the safe use and operation of that part. Any warnings provided by Yaskawa must be promptly provided to the end user. Yaskawa offers an express warranty only as to the quality of its products in conforming to standards and specifications published in the Yaskawa manual. **NO OTHER WARRANTY, EXPRESS OR IMPLIED, IS OFFERED.** Yaskawa assumes no liability for any personal injury, property damage, losses, or claims arising from misapplication of its products.

## ◆ Applicable Documentation

The following manuals are available for the JVOP-180 LCD Operator Option:

### LCD Operator

	<p><b>Yaskawa AC Drive 1000-Series Option LCD Operator Installation Manual Manual No: TOBP C730600 29 (this book)</b></p>	<p>Read this manual first. The installation manual is packaged with the option and contains information required to install the option and set up related unit parameters.</p>
---	---	--

### Yaskawa Unit

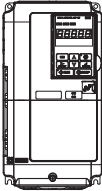
	<p><b>Yaskawa AC Drive 1000-Series Quick Start Guide</b></p>	<p>The unit manuals cover basic installation, wiring, operation procedures, functions, troubleshooting, and maintenance information.</p>
	<p><b>Yaskawa AC Drive 1000-Series Technical Manual</b></p>	<p>The manuals also include important information about parameter settings and unit tuning. Access these sites to obtain Yaskawa instruction manuals: U.S.: <a href="http://www.yaskawa.com">http://www.yaskawa.com</a> Europe: <a href="http://www.yaskawa.eu.com">http://www.yaskawa.eu.com</a> Japan: <a href="http://www.e-mechatronics.com">http://www.e-mechatronics.com</a></p>
	<p><b>YASKAWA D1000 Series Power Regenerative Converter Instruction Manual</b></p>	<p>For questions, contact your local Yaskawa sales office or the nearest Yaskawa representative.</p>
	<p><b>YASKAWA R1000 Series Power Regenerative Unit Instruction Manual</b></p>	

**Note:** Check the option to make sure it is compatible with the A1000. The nameplate on the option must list software number PRG: 0101 or later for compatibility with A1000.

## ◆ Terms

- Note:** Indicates a supplement or precaution that does not cause unit damage.
- ≥ PRG: 1012:** Indicates a unit feature or function that is only available in unit software version 1012 or greater.
- LED:** Light emitting diode.
- LCD:** Liquid crystal display.
- Option:** YASKAWA 1000-Series Option LCD Operator
- Unit:**
- YASKAWA AC Drive 1000-Series
  - YASKAWA D1000 Series Power Regenerative Converter
  - YASKAWA R1000 Series Power Regenerative Unit

# 1 Preface and Safety

---

<b>Drive:</b>	<ul style="list-style-type: none"><li>• YASKAWA AC Drive 1000-Series A1000 High Performance Vector Control Drive</li><li>• YASKAWA AC Drive 1000-Series V1000 Compact Vector Control Drive</li></ul>
<b>Converter:</b>	YASKAWA D1000 Series Power Regenerative Converter
<b>Regenerative Unit:</b>	YASKAWA R1000 Series Power Regenerative Unit

---

## ◆ Registered Trademarks

Company names and product names listed in this manual are the registered trademarks of those companies.

---

## ◆ Supplemental Safety Information

Read and understand this manual before installing, operating or servicing this option. The option must be installed according to this manual and local codes.

The following conventions are used to indicate safety messages in this manual. Failure to heed these messages could result in serious or fatal injury or damage to the products or to related equipment and systems.

### **DANGER**

Indicates a hazardous situation, which, if not avoided, will result in death or serious injury.

### **WARNING**

Indicates a hazardous situation, which, if not avoided, could result in death or serious injury.

### **CAUTION**

Indicates a hazardous situation, which, if not avoided, could result in minor or moderate injury.

### **NOTICE**

Indicates an equipment damage message.

## ■ General Safety

### General Precautions

- The diagrams in this section may include options and units without covers or safety shields to illustrate details. Be sure to reinstall covers or shields before operating any devices. The option board should be used according to the instructions described in this manual.
- Any illustrations, photographs, or examples used in this manual are provided as examples only and may not apply to all products to which this manual is applicable.
- The products and specifications described in this manual or the content and presentation of the manual may be changed without notice to improve the product and/or the manual.
- When ordering a new copy of the manual due to damage or loss, contact your Yaskawa representative or the nearest Yaskawa sales office and provide the manual number shown on the front cover.

### DANGER

#### **Heed the safety messages in this manual.**

Failure to comply will result in death or serious injury.

The operating company is responsible for any injuries or equipment damage resulting from failure to heed the warnings in this manual.

### NOTICE

#### **Do not expose the unit to halogen group disinfectants.**

Failure to comply may cause damage to the electrical components in the option.

Do not pack the unit in wooden materials that have been fumigated or sterilized.

Do not sterilize the entire package after the product is packed.

# 2 Product Overview

### ◆ About This Product

The option provides an enhanced unit user interface that can operate the Yaskawa unit from up to 3 meters away. The option can display information in 13 languages, including English, Japanese, and Spanish. <1><2> The option is an LCD display that simplifies the task of interfacing with the unit to perform these tasks:

- Read or modify unit parameters.
- Read and copy unit parameter settings to another Yaskawa unit.
- Operate the unit.
- Monitor unit operation status.



<1> Eight languages (English, Japanese, German, French, Italian, Spanish, Portuguese, Chinese) are available when using one of the following devices:

- An A1000 with drive software version PRG: 1018 or later and option with software version PRG: 0101.
- An A1000 with drive software version PRG: 1017 or later and option with software version PRG: 0101 or later.
- A1000 models 4A0930 or 4A1200
- V1000

<2> Language support is limited to English, Japanese, and Chinese when using the option with software version PRG: 0101 in combination D1000 or R1000.

**Note:** Installing and connecting the option to a V1000 will cause the built-in LED operator on the drive to display a series of dots as shown in [Table 1](#). This is normal operation. Additionally, when the option is connected, none of the keys on the built-in LED operator on the drive will work, except for the STOP key. To disable the STOP key on the built-in LED operator, set parameter o2-02 (STOP Key Function Selection) to 0 (Disabled).

**Table 1 Built-in LED Display When Option is Connected to a V1000**

Display	LED Display	Drive Status
	Illuminated	During Stop
	Flashing	During Run



### ◆ Applicable Models

The option can be used with the unit models in [Table 2](#).

**Table 2 Applicable Unit Models**

Unit	Unit Software Version <1>
A1000	All versions
V1000	≥ PRG: 1012
D1000	All versions
R1000	All versions

<1> See “PRG” on the unit nameplate for software version number.

- Note:**
1. Check the option to make sure it is compatible with the A1000. The nameplate on the option must list software version PRG: 0101 or later for compatibility with A1000.
  2. To view information on the display in Czech, Russian, Turkish, Polish, or Greek, use option software version PRG: 0102 or later and A1000 drive software version PRG: 1018 or later. Those languages cannot be displayed on A1000 models 4A0930 or 4A1200.
  3. Language support is limited to English, Japanese, and Chinese when using the option with software version PRG: 0101 in combination D1000 or R1000.

### 3 Receiving

Perform the following tasks after receiving the option:

- Inspect the option for damage.  
If the option appears damaged upon receipt, contact the shipper immediately.
- Verify receipt of the correct model by checking the model number printed on the Name plate of the option.
- If you have received the wrong model or the option does not function properly, contact your supplier.

#### ◆ Contents and Packaging

Table 3 Contents of Package

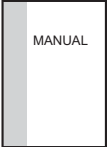
Description:	Option	Installation Manual
—		
Quantity:	1	1

#### ■ Parts Sold Separately

Proper installation of the option requires a digital operator cable (sold separately). A communication cable may be purchased from Yaskawa or recommended LAN cables may be used.

Installation support kit A or B (sold separately) may also be required depending on the option installation method. Refer to [Table 4. Refer to Installing the Option on page 23](#) for more information regarding installation methods.

To order a communication or an installation support kit, contact Yaskawa directly or your nearest Yaskawa distributor.

Table 4 Item Names and Part Numbers (Sold Separately)

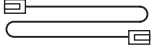
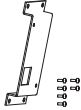
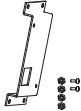
Item	Yaskawa Part Number	Notes	Page
 Digital Operator Cable 1 m (3 ft.) <1>	WV001 Part number for the Americas: UWR0051	Alternate cables (customer-supplied), RJ45 8-pin Straight Connector UTP Cat5e cable	26
 Digital Operator Cable 3 m (10 ft.) <1>	WV003 Part number for the Americas: UWR0052	Alternate cables (customer-supplied), RJ45 8-pin Straight Connector UTP Cat5e cable	26
 Installation Support Kit A	EZZ020642A	Sold Separately; For use with holes through the panel	25
 Installation Support Kit B <2>	EZZ020642B	Sold Separately; For use with panel-mounted threaded studs	25

<1> Digital Operator Cable: Used to connect the digital operator to the drive (sold separately).

<2> Use Installation Support Kit B when weld studs are on the back of the panel.

## ◆ Tool Requirements

The tools listed in Table 5 are required to install the option on an enclosure panel door.

Table 5 Required Tools

Installation Location	Installation Support	Required Tools
External/Face Mount	—	Phillips screwdriver, M3
Internal/Flush Mount	Installation Support Kit A	Phillips screwdriver, M3, M4
	Installation Support Kit B	Phillips screwdriver, M3 Box end or adjustable wrench, M4

# 4 Option Components

### ◆ Option

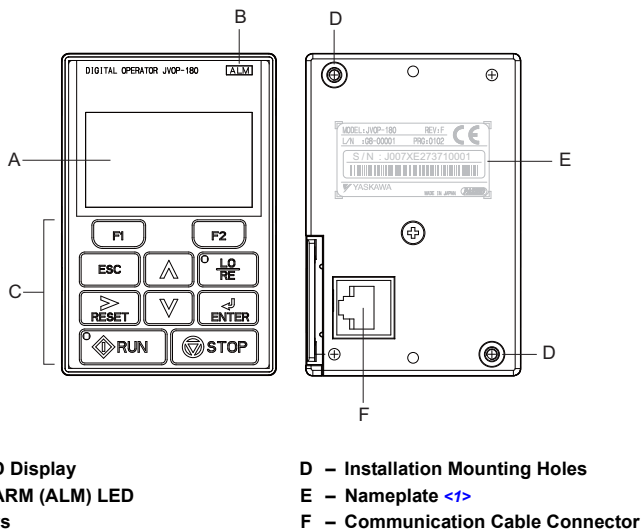

<1> REV: Display option version; PRG: Language data.

**Figure 1 Option Components**



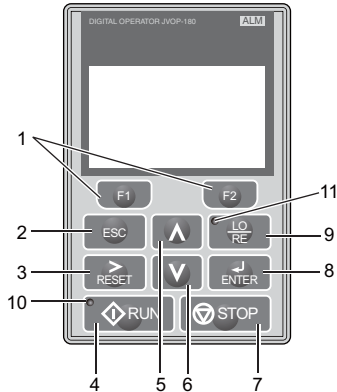

### ◆ Keys

Refer to [Figure 2](#) and [Table 6](#) for details on key names and functions.











**Figure 2 Keys**

**Table 6 Key Names and Functions**

No.	Key	Name	Function
1	 	Function Key (F1, F2)	<p>The functions assigned to F1 and F2 vary depending on the menu that is currently displayed. The name of each function appears in the lower half of the display window.</p> <p>For a description of functions assigned to the F1 and F2 keys, <a href="#">Refer to LCD Display on page 18</a>.</p>
2		ESC Key	<ul style="list-style-type: none"> <li>Returns to the previous display.</li> <li>Moves the cursor one space to the left.</li> <li>Pressing and holding this button will return to the following display:                      Drive: Frequency Reference                      Converter: DC Bus Voltage Reference                      Regenerative unit: DC Bus Voltage</li> </ul>
3		RESET Key	<ul style="list-style-type: none"> <li>Moves the cursor to the right.</li> <li>Resets the unit to clear a fault situation.</li> </ul>

## 4 Option Components

No.	Key	Name	Function
4		RUN Key	Starts the unit and motor.
5		Up Arrow Key	Scrolls up to display the next item, selects parameter numbers and increments setting values.
6		Down Arrow Key	Scrolls down to display the previous item, selects parameter numbers and decrements setting values.
7		STOP Key	Stops unit operation. <b>Note:</b> The STOP key can be enabled or disabled when operating from the external terminal or network communications by setting parameter o2-02.
8		ENTER Key	<ul style="list-style-type: none"> <li>Enters parameter values and settings.</li> <li>Selects a menu item to move between displays.</li> </ul>
9		LO/RE Selection Key	Switches unit control between the operator (LOCAL) and an external source (REMOTE) for the Run command and frequency reference. <b>Note:</b> The LOCAL/REMOTE key is only effective when the unit is stopped in Drive Mode. As a safety precaution, it is possible to disable the LO/RE Selection Key by setting parameter o2-01 (LOCAL/REMOTE Key Function Selection) to 0 (disabled).
10		RUN Light	Illuminated during an operation. <i>Refer to Option LED Status Indicators on page 15</i> for details.
11		LO/RE Light	Illuminated while the option is selected to run the unit (LOCAL mode).

## ◆ Option LED Status Indicators

### ■ Connecting the Option to A1000 or V1000

Table 7 LED Status and Meaning

LED	Illuminated	Flashing <1>	Flashing Quickly <1>	Off
	When the option is selected for Run command and frequency reference control (LOCAL).	—	—	When a device other than the option is selected for Run command and frequency reference control (REMOTE).
	During run.	<ul style="list-style-type: none"> <li>During deceleration to stop.</li> <li>When a Run command is input and the frequency reference is 0 Hz.</li> </ul>	<ul style="list-style-type: none"> <li>During deceleration when a Fast Stop command was entered.</li> <li>During stop by External Fault digital input.</li> </ul>	During stop.
Examples				

<1> Refer to [Figure 3](#) for the difference between “flashing” and “flashing quickly”.

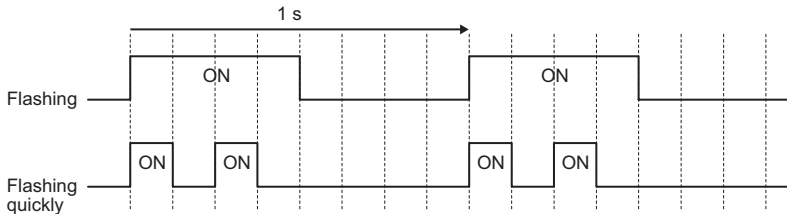

Figure 3 RUN LED Status

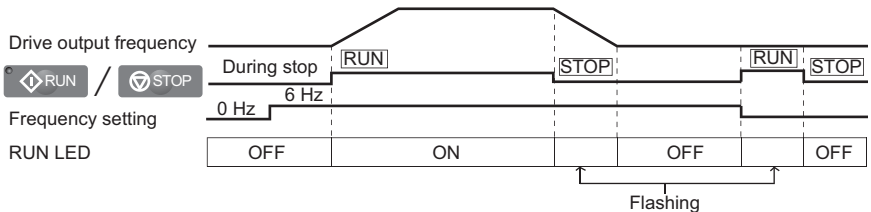







Figure 4 RUN LED and Drive Operation

## 4 Option Components

### ■ Connecting the Option to D1000

Table 8 LED Status and Meaning

LED	Illuminated	Flashing Quickly <1>	Off
	When the run command is selected from the LED operator (LOCAL).	–	When a device other than the option is selected for Run command and frequency reference control (REMOTE).
	During run.	During stop by External Fault digital input.	During stop.
Examples			

<1> Refer to [Figure 5](#) for the difference between “flashing” and “flashing quickly”.

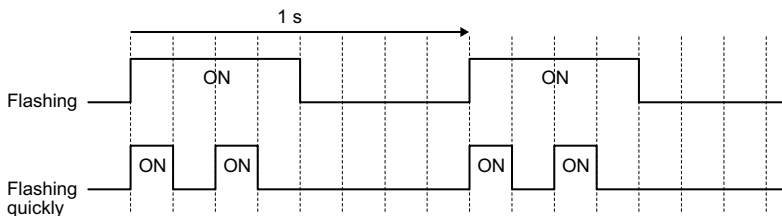

Figure 5 RUN LED Status

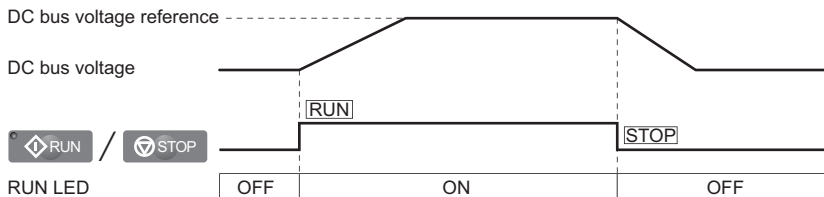







Figure 6 RUN LED and Converter Operation



## ■ Connecting the Option to R1000

**Table 9 LED Status and Meaning**

LED	Illuminated	Flashing Quickly <1>	Off
	When the run command is selected from the LED operator (LOCAL).	—	When a device other than the option is selected for Run command and frequency reference control (REMOTE).
	During run.	During stop by External Fault digital input.	During stop.
Examples			

<1> Refer to [Figure 7](#) for the difference between “flashing” and “flashing quickly”.

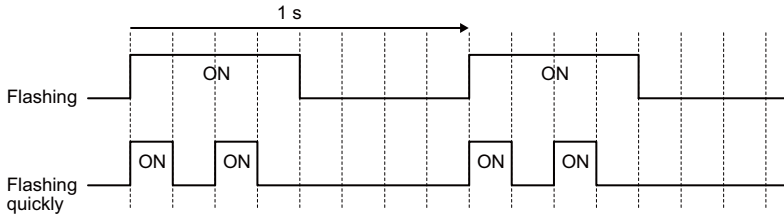

**Figure 7 RUN LED Status**

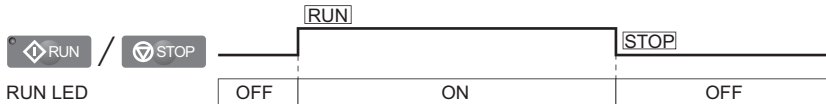

**Figure 8 RUN LED and Regenerative Unit Operation**

## 4 Option Components

### ◆ LCD Display

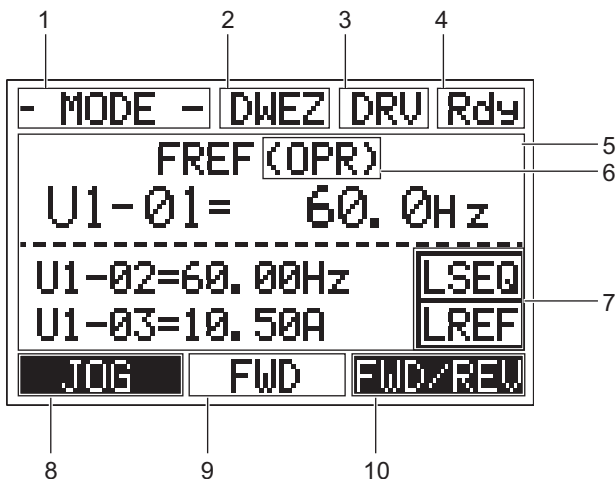

Figure 9 LCD Display









Table 10 Display and Contents

No.	Name	Display	Content
1	Operation Mode Menus	MODE	Displayed when in Mode Selection.
		MONITR	Displayed when in Monitor Mode.
		VERIFY	Indicates the Verify Menu.
		PRMSET	Displayed when in Parameter Setting Mode.
		A.TUNE	Displayed during Auto-Tuning.
		SETUP	Displayed when in Setup Mode.
2	DriveWorksEZ Function Selection <I>	DWEZ	Displayed when the DriveWorksEZ is set to enable. (A1-07 = 1 or 2)
3	Mode Display Area	DRV	Displayed when in Drive Mode.
		PRG	Displayed when in Programming Mode.
4	Ready	Rdy	Indicates the unit is ready to run.
5	Data Display	-	Displays specific data and operation data.

## 4 Option Components

No.	Name	Display	Content
6	Drive: Frequency Reference Assignment ↔	OPR	Displayed when the frequency reference is assigned to the option.
		AI	Displayed when the frequency reference is assigned to the Analog Input of the drive.
		COM	Displayed when the frequency reference is assigned to the MEMOBUS/Modbus Communication Inputs of the drive.
		OP	Displayed when the frequency reference is assigned to an Option Unit of the drive.
		RP	Displayed when the frequency reference is assigned to the Pulse Train Input of the drive.
	Converter: Voltage Reference Assignment ↔	OPR	Displayed when the voltage reference is assigned to the option.
		AI	Displayed when the voltage reference is assigned to the Analog Input of the converter.
		COM	Displayed when the voltage reference is assigned to the MEMOBUS/Modbus Communication Inputs of the converter.
		OP	Displayed when the voltage reference is assigned to an Option Unit of the converter.
		AUTO	Displayed when b1-18 is set to either 7 or 8 (input voltage based control 1 or 2).
	Regenerative Unit: Run Command Assignment ↔	OPR	Displayed when the Run command is assigned to the option.
		AI	Displayed when the Run command is assigned to the Analog Input of the regenerative unit.
COM		Displayed when the Run command is assigned to the MEMOBUS/Modbus Communication Inputs of the regenerative unit.	
OP		Displayed when the Run command is assigned to an Option Unit connected to the regenerative unit.	
7	LO/RE Display ↔	RSEQ	Displayed when the Run command is supplied from a remote source.
		LSEQ	Displayed when the Run command is supplied from the digital operator.
		RREF	Drive: Displayed when the frequency reference is supplied from a remote source. Converter: Displayed when the voltage reference is supplied from a remote source. Regenerative unit: Displayed when the Run command is supplied from a remote source.
		LREF	Drive: Displayed when the frequency reference is supplied from the digital operator. Converter: Displayed when the voltage reference is supplied from the digital operator. Regenerative unit: Displayed when the Run command is supplied from the digital operator.

## 4 Option Components

No.	Name	Display	Content
8	Function Key 1 (F1)	JOG </>	Pressing  executes the Jog function.
		HELP	Pressing  displays the Help menu.
		←	Pressing  scrolls the cursor to the left.
		HOME	Pressing  will return to the following display: Drive: Frequency Reference Converter: DC Bus Voltage Reference Regenerative unit: DC Bus Voltage
		ESC	Pressing  returns to the previous display.
9	FWD/REV </>	FWD	Indicates forward motor operation.
		REV	Indicates reverse motor operation.
10	Function Key 2 (F2)	FWD/REV </>	Pressing  switches between forward and reverse.
		DATA	Pressing  scrolls to the next display.
		→	Pressing  scrolls the cursor to the right.
		RESET	Pressing  resets the existing unit fault or error.



<1> Not available for the converter and regenerative unit.

<2> Displayed when in Frequency Reference, Voltage Reference, or Run Command Mode.

<3> Displayed when in Frequency Reference, Voltage Reference, or Run Command Mode and Monitor Mode.

### ◆ ALARM (ALM) LED Displays

**Table 11 ALARM (ALM) LED Status and Contents**

State	Content	Display
Illuminated	When the unit detects an alarm or error.	
Flashing	<ul style="list-style-type: none"> <li>• When an alarm occurs.</li> <li>• When oPE is detected.</li> <li>• When a fault or error occurs during Auto-Tuning.</li> </ul>	
Off	Normal operation (no fault or alarm).	

# 5 Installation Procedure

### ◆ Section Safety

#### NOTICE

##### **Damage to Equipment**

**Use only Yaskawa connection cables or recommended cables.**

Failure to comply may cause the unit or option to function incorrectly.

**Properly connect the connectors.**

Failure to comply may prevent proper operation and possibly damage equipment.

**Do not exceed communication cable bend radius specifications.**

Failure to comply may result in broken wires or loose connections.

## ◆ Option Dimensions

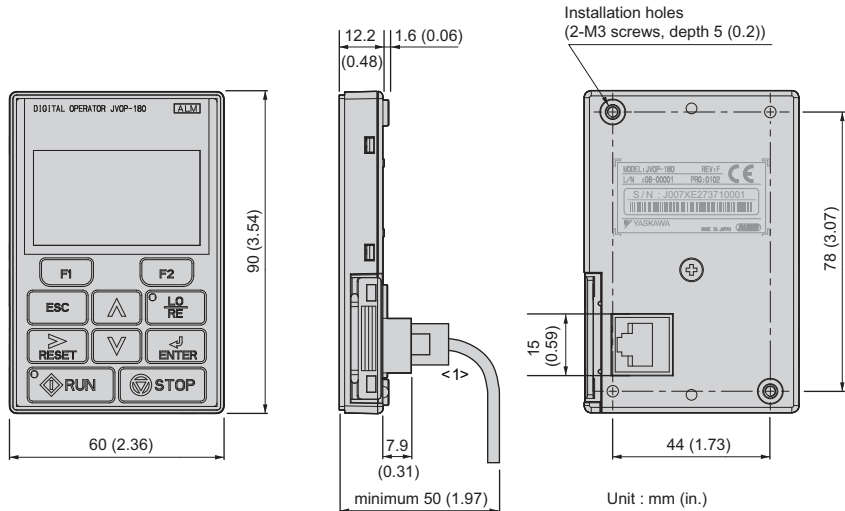

Figure 10 Dimensions

<1> Use only Yaskawa cables or cables recommended by Yaskawa. Refer to [Item Names and Part Numbers \(Sold Separately\) on page 11](#).

## ◆ Installing the Option

The option mounts to an enclosure two different ways:

- **External/face-mount** installs the operator outside the enclosure panel.
- **Internal/flush-mount** installs the operator inside the enclosure panel.

Table 12 Option Installation Methods

Installation Method	Description	Notes
External/Face-mount	Simplified installation with the option is mounted on the outside of the panel with two screws.	—
Internal/Flush-mount	Encloses the option in the panel. The front of the option is flush with the outside of the panel.	Requires purchase of separate items. <a href="#">Refer to Item Names and Part Numbers (Sold Separately) on page 11</a> .

## 5 Installation Procedure

**NOTICE:** Prevent foreign matter such as metal shavings or wire clippings from falling into the unit during installation and project construction. Failure to comply could result in damage to the unit. Place a temporary cover over the top of the unit during installation. Remove the temporary cover before startup, as the cover will reduce ventilation and cause the unit to overheat.

### External/Face-mount Installation

1. Cut an opening in the enclosure panel for the option according to [Figure 12](#).
2. Position the option so the LCD display faces outwards, and mount it to the enclosure panel as shown in [Figure 11](#).

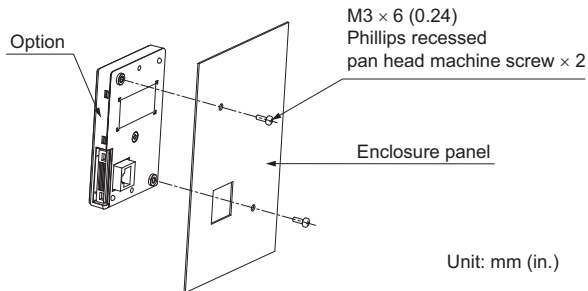

Figure 11 External/Face-mount Installation

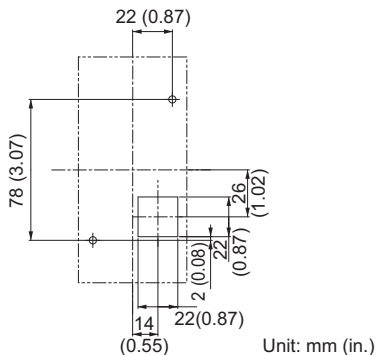

Figure 12 Panel Cut-out Dimensions (External/Face-mount Installation)



### Internal/Flush-mount Installation

The internal flush-mount installation method requires an installation support that is purchased separately. *Refer to Item Names and Part Numbers (Sold Separately) on page 11* for information regarding the installation support and mounting hardware. *Figure 13* illustrates how to install Installation Support Kit A.

1. Cut an opening in the enclosure panel for the option according to *Figure 14*.
2. Mount the option to the installation support (sold separately).
3. Mount the installation support and option to the enclosure panel.

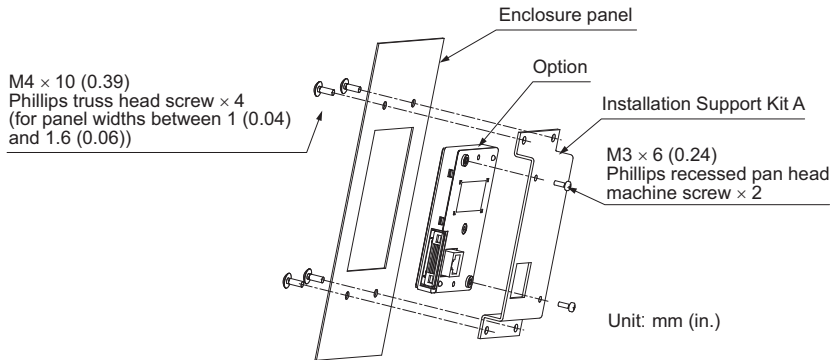

**Figure 13 Internal/Flush Mount Installation**

**Note:** For environments with a significant amount of dust or other airborne debris, use a gasket between the enclosure panel and the option.

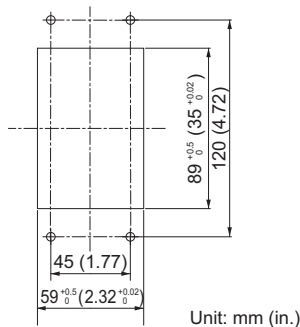

**Figure 14 Panel Cut-out Dimensions (Internal/Flush-mount Installation)**

## 5 Installation Procedure

### ◆ Connecting the Option to the Unit

This section contains instructions for connecting the option to units.

#### ■ Connecting the Option to V1000

Plug the customer-supplied communication cable into the communication cable connector of the option and the drive communications port as shown in *Figure 15*. Ensure both cable ends are firmly connected. *Refer to Item Names and Part Numbers (Sold Separately) on page 11* for information regarding recommended cables.

Refer to *Table 1* for built-in LED display behavior with a connected option.

- Note:**
1. Use only Yaskawa recommended cables. Using a cable not specified may cause the option or drive to malfunction.
  2. The STOP key on the built-in LED operator of the drive is the only functional key on the drive when the option is connected and parameter b1-02 is set to 0 (LCD Operator or Option). Set parameter o2-02 (STOP Key Function Selection) to 0 (Disable) to disable the STOP key.

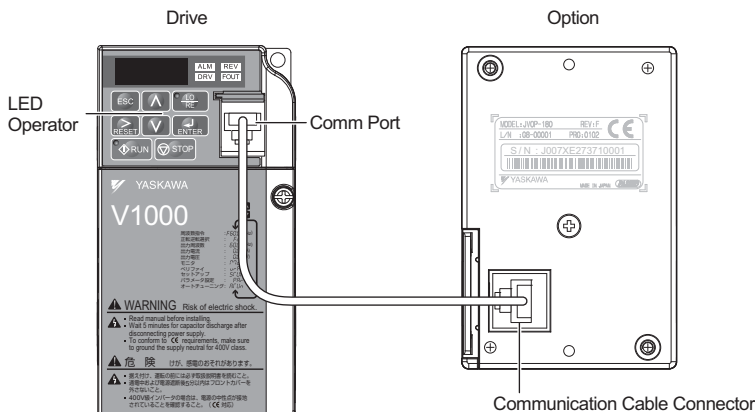
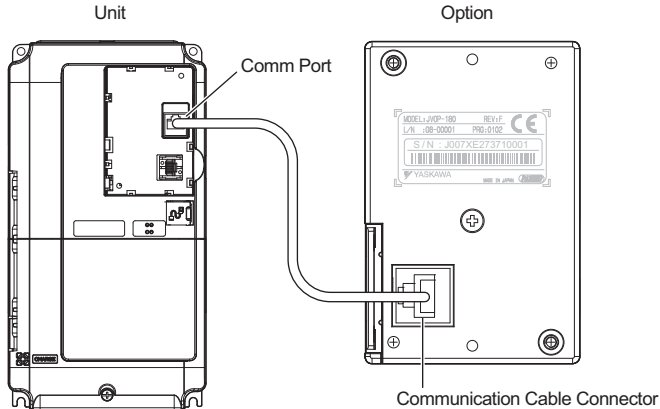

Figure 15 Communication Cable Connection

### ■ Connecting the Option to A1000, D1000, or R1000

Plug the customer-supplied communication cable into the communication cable connector of the option and the unit communications port as shown in **Figure 15**. Ensure both cable ends are firmly connected. **Refer to Item Names and Part Numbers (Sold Separately) on page 11** for information regarding recommended cables.

**Note:** Use only Yaskawa recommended cables. Using a cable not specified may cause the option or unit to malfunction.



**Figure 16 Communication Cable Connection**

# 6 Basic Operation

## ◆ Connecting the Option to A1000 or V1000

### ■ Menu Structure for Option

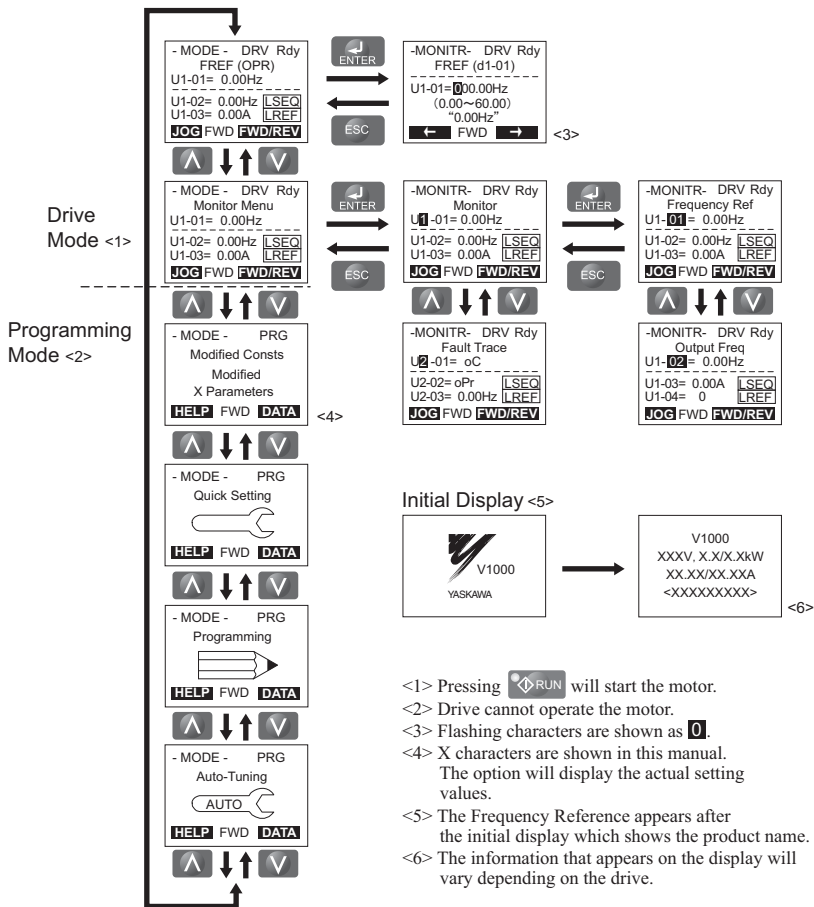



Figure 17 Option Menu Structure







### ■ Example: Basic Operation

The following procedures are examples of drive operation using the option.





**Note:** Actual LCD display data varies based on drive parameter settings.

#### Procedure Example: RUN/STOP















**Note:** If b1-01 is not set to 0 (Operator), press  to set LOCAL.

Procedure	LCD Display
<p>1. Apply main power to the drive. The Frequency Reference appears after the initial display on the option.</p>	<pre style="font-family: monospace;"> - MODE - DRV Rdy   FREF (OPR) U1-01= 0.00Hz ----- U1-02= 0.00Hz LSEQ U1-03= 0.00A  LREF <b>JOG FWD FWD/REV</b>                     </pre>
<p>2. Press  to show the display for inputting the frequency reference.</p> <p>If b1-01 is not set to 0 (Operator), press  to set LOCAL.</p>	<pre style="font-family: monospace;"> -MONITR- DRV Rdy   FREF (d1-01) ----- U1-01= 000.00Hz       (0.00~60.00)       "0.00Hz" <b>← FWD →</b>                     </pre>
<p>3. Press     until the frequency reference changes to 006.00 Hz.</p>	<pre style="font-family: monospace;"> -MONITR- DRV Rdy   FREF (d1-01) ----- U1-01= 006.00Hz       (0.00~60.00)       "0.00Hz" <b>← FWD →</b>                     </pre>
<p>4. Press  to set the output frequency.</p>	<div style="border: 1px solid black; padding: 10px; width: fit-content; margin: 0 auto;">Entry Accepted</div>

## 6 Basic Operation









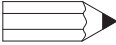

Procedure	LCD Display
5. Press  to start the motor. The motor should accelerate up to 6 Hz while the RUN LED is on.	<pre> -MONITR-  DRV Rdy   FREF (d1-01) ----- U1-01= 006.00Hz (0.00~60.00) "0.00Hz"  FWD  </pre>
6. Press  to stop the motor. The RUN LED will flash until the motor comes to a complete stop.	

### Procedure Example: Viewing Monitors

Procedure	LCD Display
1. Frequency Reference display.	<pre> - MODE -  DRV Rdy   FREF(OPR) U1-01= 0.00Hz ----- U1-02= 0.00Hz  LSEQ U1-03= 0.00A   LREF  FWD  </pre>
2. Press   until the Monitor Menu display appears.	<pre> - MODE -  DRV Rdy   Monitor Menu U1-01= 6.00Hz ----- U1-02= 0.00Hz  LSEQ U1-03= 0.00A   LREF  FWD  </pre>
3. Press  to show the Monitor display.	<pre> -MONITR-  DRV Rdy   Monitor U1-01= 6.00Hz ----- U1-02= 0.00Hz  LSEQ U1-03= 0.00A   LREF  FWD  </pre>
4. Press    to view the drive monitors.	<pre> -MONITR-  DRV Rdy   Last Fault U2-02= oPr ----- U2-03= 0.00Hz  LSEQ U2-04= 0.00Hz  LREF  FWD  </pre>

### Procedure Example: Display Language Selection

The display language can be changed with parameter A1-00 (Select Language).





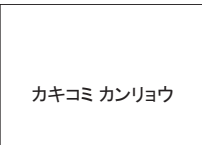



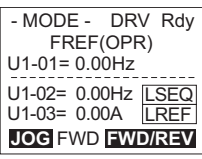

Procedure	LCD Display
1. Frequency Reference.	<pre> - MODE - DRV Rdy   FREF(OPR) U1-01= 0.00Hz ----- U1-02= 0.00Hz LSEQ U1-03= 0.00A  LREF <b>JOG FWD FWD/REV</b>           </pre>
2. Press   to select the Programming Mode.	<pre> -MODE-   PRG   Programming    <b>HELP FWD DATA</b>           </pre>
3. Press  to show the Initialization display.	<pre> -PRMSET- PRG   Initialization ----- <b>A1-00= 0</b>   Select Language <b>← FWD →</b>           </pre>
4. Press     to select A1-00 and press  .	<pre> -PRMSET- PRG   Select Language ----- A1-00= <b>0</b> *0*   English   "1" <b>← FWD →</b>           </pre>
5. Press   to enter setting 1.	<pre> -PRMSET- PRG   ゲンゴ (Language) ----- A1-00= <b>1</b> *0*   コホンゴ (Japanese)   "1" <b>← FWD →</b>           </pre>

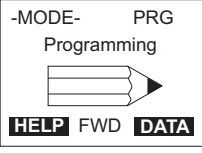
## 6 Basic Operation

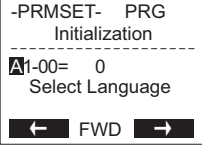
Procedure	LCD Display
6. Press  and the option will display Japanese.	





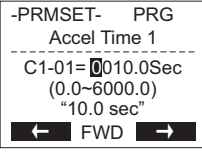

### Procedure Example: Setting Parameters

The example below explains how to change the Deceleration Time parameter C1-01 to 20.0 sec from the default setting of 10.0 sec.

Procedure	LCD Display
1. Frequency Reference display.	
2. Press   to select the Programming Mode.	
3. Press  to show the Initialization display.	
4. Press     to select parameter C1-01 and press  .	

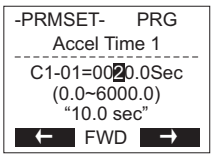

## 6 Basic Operation

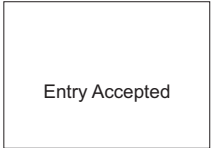
Procedure	LCD Display
5. Press     to enter 20.0 sec.	 <pre>-PRMSET- PRG   Accel Time 1 ----- C1-01=0020.0Sec (0.0~6000.0) "10.0 sec" ← FWD →</pre>
6. Press  to enter and store the new setting for C1-01.	 <pre>Entry Accepted</pre>

## 6 Basic Operation

### Read/Copy Function Procedure

- Read

Reads and saves parameter settings from the drive to the option.

**Note:** The option can perform the Read function an estimated 100,000 times.

- Copy

Copies parameter settings from the option to another Yaskawa drive.

These parameters control the Copy function of the digital operator. The Copy function stores parameter settings into the memory of the digital operator to facilitate the transfer of those settings to other drives that are the same model, capacity, and same control mode setting.





**Note:** Parameter settings can only be copied to other drives that are the same model, capacity, and have the same control mode setting.







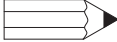

- Verify

Verifies that parameter settings in the drive match the parameter settings saved to the option.

The following procedure is used to read parameters from the drive.

**Note:** Set parameter o3-02 (Read Allowable) to 1 (Enable) to read the parameter settings from the drive.  
Set parameter o3-02 to 0 (Disable) to protect the parameter settings in the option.

Procedure	LCD Display
1. Frequency Reference display.	-MODE- DRV Rdy FREF (OPR) U1-01= 6.00Hz ----- U1-02= 0.00Hz <span style="border: 1px solid black; padding: 2px;">LSEQ</span> U1-03= 0.00A <span style="border: 1px solid black; padding: 2px;">LREF</span> <span style="border: 1px solid black; padding: 2px;">JOG FWD</span> <span style="border: 1px solid black; padding: 2px;">FWD/REV</span>
2. Press   to select the Programming Mode.	-MODE- PRG Programming  <span style="border: 1px solid black; padding: 2px;">HELP</span> <span style="border: 1px solid black; padding: 2px;">FWD</span> <span style="border: 1px solid black; padding: 2px;">DATA</span>
3. Press  to show the Initialization display.	-PRMSET- PRG Initialization ----- <span style="border: 1px solid black; padding: 2px;">A1-00= 0</span> Select Language <span style="border: 1px solid black; padding: 2px;">←</span> <span style="border: 1px solid black; padding: 2px;">FWD</span> <span style="border: 1px solid black; padding: 2px;">→</span>

Procedure	LCD Display
<p>4. Press     to select o3-01 and press .</p>	<pre>-PRMSET- PRG Copy Functon Sel ----- o3-01= 0 *0* COPY SELECT ← FWD →</pre>
<p>5. Press   to enter 1 (INV --&gt; OP READ).</p>	<pre>-PRMSET- PRG Copy Functon Sel ----- o3-01= 1 *0* INV→OP READ "0" ← FWD →</pre>
<p>6. Press  and the option will read the parameter settings from the drive.</p>	<pre>READ INV→OP READING</pre>
<p>7. Automatically return to the Copy Function Selection display.</p>	<pre>End READ COMPLETE</pre>

## ◆ Connecting the Option to D1000

### ■ Menu Structure for Option

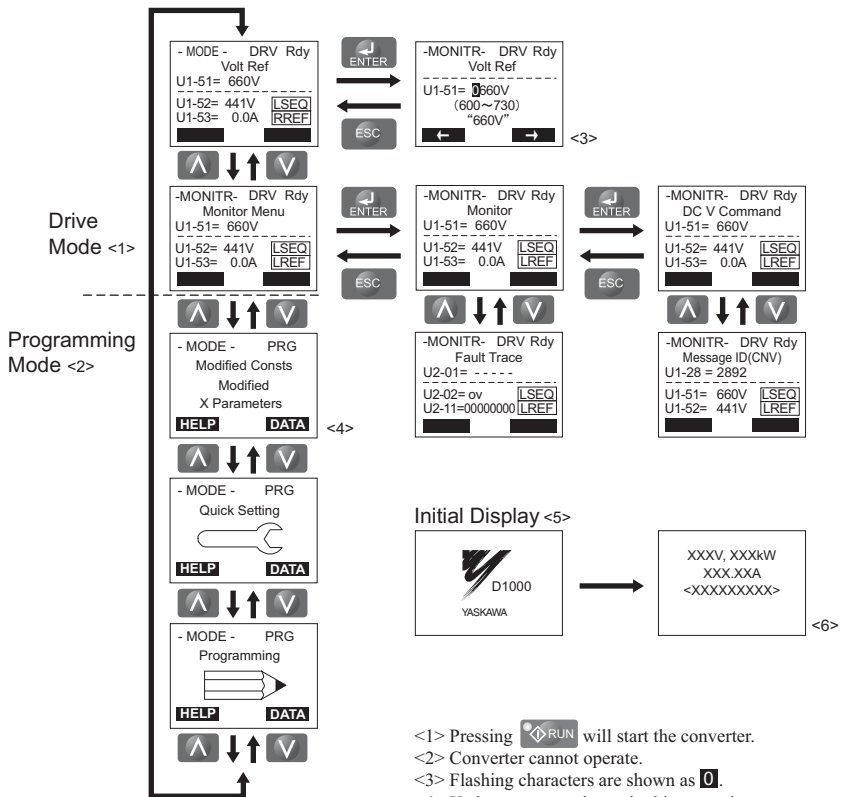

- <1> Pressing will start the converter.
- <2> Converter cannot operate.
- <3> Flashing characters are shown as **0**.
- <4> X characters are shown in this manual. The option will display the actual setting values.
- <5> The DC Bus Voltage Reference appears after the initial display which shows the product name.
- <6> The information that appears on the display will vary depending on the converter.

Figure 18 Option Menu Structure







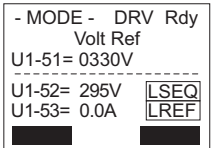

### ■ Example: Basic Operation

The following procedures are examples of converter operation using the option.

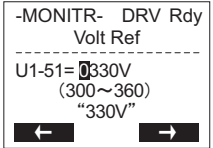

**Note:** Actual LCD display data varies based on converter parameter settings.

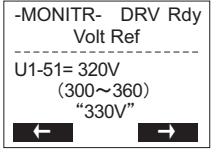
#### Procedure Example: RUN/STOP

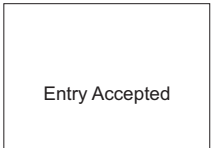





**Note:** If b1-18 is not set to 0 (Operator), press  to set LOCAL.

Procedure	LCD Display
<p>1. Apply main power to the converter. The DC Bus Voltage Reference appears after the initial display on the option.</p>	
<p>2. Press  to show the display for inputting the DC Bus voltage reference.</p> <p>If b1-18 is not set to 0 (Operator), press  to set LOCAL.</p>	
<p>3. Press     until the DC bus voltage reference changes to the desired voltage.</p>	
<p>4. Press  to set the output voltage.</p>	

## 6 Basic Operation

Procedure	LCD Display
5. Press  to start the operation at the set voltage while the RUN LED is on.	<pre> - MODE - DRV Rdy   Volt Ref U1-51= 320V ----- U1-52= 320V  LSEQ U1-53= 5.0A  LREF           [REDACTED]           [REDACTED] </pre>
6. Press  to stop the operation. The RUN LED will be off when the converter comes to a complete stop.	

### Procedure Example: Viewing Monitors

Procedure	LCD Display
1. DC Bus Voltage Reference display.	<pre> - MODE - DRV Rdy   Volt Ref U1-51= 320V ----- U1-52= 295V  LSEQ U1-53= 0.0A  LREF           [REDACTED]           [REDACTED] </pre>
2. Press   until the Monitor Menu display appears.	<pre> - MODE - DRV Rdy   Monitor Menu U1-51= 320V ----- U1-52= 295V  LSEQ U1-53= 0.0A  LREF           [REDACTED]           [REDACTED] </pre>
3. Press  to show the Monitor display.	<pre> -MONITR- DRV Rdy   Monitor U1-51= 320V ----- U1-52= 295V  LSEQ U1-53= 0.0A  LREF           [REDACTED]           [REDACTED] </pre>
4. Press    to view the converter monitors.	<pre> -MONITR- DRV Rdy   Last Fault U2-02= oPr ----- U2-11= 00000000 LSEQ U2-12= 00000000 LREF           [REDACTED]           [REDACTED] </pre>





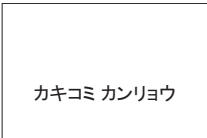





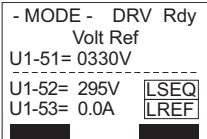

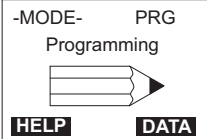
## 6 Basic Operation

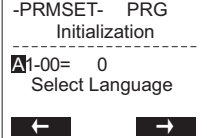
Procedure	LCD Display
6. Press  and the option will display Japanese.	





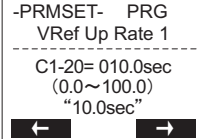



### Procedure Example: Setting Parameters

The example below explains how to change the Deceleration Time parameter C1-20 to 20.0 sec from the default setting of 10.0 sec.

Procedure	LCD Display
1. DC Bus Voltage Reference display.	
2. Press   to select the Programming Mode.	
3. Press  to show the Initialization display.	
4. Press     to select parameter C1-20 and press  .	

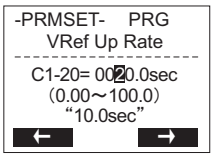

## 6 Basic Operation

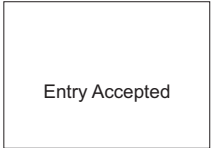
Procedure	LCD Display
5. Press     to enter 20.0 sec.	 <p>-PRMSET- PRG VRef Up Rate ----- C1-20= 00<del>0</del>0.0sec (0.00~100.0) "10.0sec"  </p>
6. Press  to enter and store the new setting for C1-01.	 <p>Entry Accepted</p>

## 6 Basic Operation

### Read/Copy Function Procedure

- Read

Reads and saves parameter settings from the converter to the option.

**Note:** The option can perform the Read function an estimated 100,000 times.

- Copy

Copies parameter settings from the option to another Yaskawa converter.

These parameters control the Copy function of the digital operator. The Copy function stores parameter settings into the memory of the digital operator to facilitate the transfer of those settings to other converters that are the same model, capacity, and same control mode setting.

**Note:** Parameter settings can only be copied to other converters that are the same model, capacity, and have the same control mode setting.





- Verify









Verifies that parameter settings in the converter match the parameter settings saved to the option.

The following procedure is used to read parameters from the converter.

**Note:** Set parameter o3-02 (Read Allowable) to 1 (Enable) to read the parameter settings from the converter.

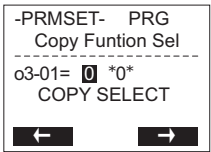
Set parameter o3-02 to 0 (Disable) to protect the parameter settings in the option.

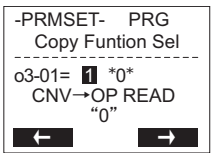
Procedure	LCD Display
1. DC Bus Voltage Reference display.	- MODE - DRV Rdy Volt Ref U1-51= 0330V ----- U1-52= 295V <b>LSEQ</b> U1-53= 0.0A <b>LREF</b> [REDACTED]      [REDACTED]
2. Press   to select the Programming Mode.	-MODE-      PRG Programming  <b>HELP</b> <b>DATA</b>
3. Press  to show the Initialization display.	-PRMSET- PRG Initialization ----- <b>A</b> 1-00= 0 Select Language <b>←</b> <b>→</b>

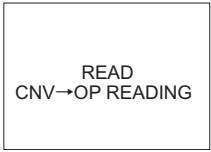
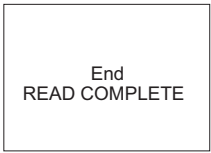
Procedure	LCD Display
<p>4. Press     to select o3-01 and press .</p>	 <pre> -PRMSET- PRG Copy Funtion Sel ----- o3-01= 0 *0* COPY SELECT ← → </pre>
<p>5. Press   to enter 1 (CNV --&gt; OP READ).</p>	 <pre> -PRMSET- PRG Copy Funtion Sel ----- o3-01= 1 *0* CNV-&gt;OP READ "0" ← → </pre>
<p>6. Press  and the option will read the parameter settings from the converter.</p>	 <pre> READ CNV-&gt;OP READING </pre>
<p>7. Automatically return to the Copy Function Selection display.</p>	 <pre> End READ COMPLETE </pre>

## ◆ Connecting the Option to R1000

### ■ Menu Structure for Option

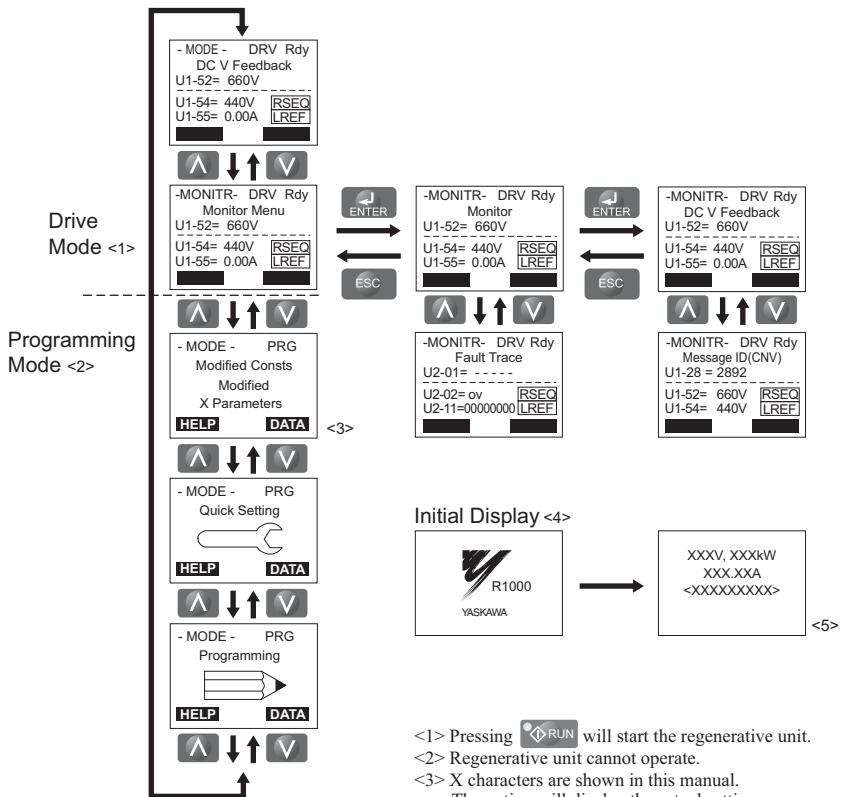

- <1> Pressing will start the regenerative unit.
  - <2> Regenerative unit cannot operate.
  - <3> X characters are shown in this manual.  
The option will display the actual setting values.
  - <4> The DC Bus Voltage appears after the initial display which shows the product name.
  - <5> The information that appears on the display will vary depending on the regenerative unit.
- Note: Flashing characters are shown as **0**.

Figure 19 Option Menu Structure

### ■ Example: Basic Operation







The following procedures are examples of regenerative unit operation using the option.

**Note:** Actual LCD display data varies based on regenerative unit parameter settings.

#### Procedure Example: RUN/STOP

**Note:** If b1-18 is not set to 0 (Operator), press  to set LOCAL.

















#### Procedure Example: Viewing Monitors

Procedure	LCD Display
1. DC Bus Voltage display.	<pre> - MODE -  DRV Rdy DC V Feedback U1-51= 320V ----- U1-52= 295V  [LSEQ] U1-53= 0.0A  [LREF] </pre>
2. Press   until the Monitor Menu display appears.	<pre> - MODE -  DRV Rdy Monitor Menu U1-51= 320V ----- U1-52= 295V  [LSEQ] U1-53= 0.0A  [LREF] </pre>
3. Press  to show the Monitor display.	<pre> -MONITR-  DRV Rdy Monitor U1-51= 320V ----- U1-52= 295V  [LSEQ] U1-53= 0.0A  [LREF] </pre>
4. Press    to view the regenerative unit monitors.	<pre> -MONITR-  DRV Rdy Last Fault U2-02= oPr ----- U2-11= 00000000[LSEQ] U2-12= 00000000[LREF] </pre>

## 6 Basic Operation

### Procedure Example: Display Language Selection









The display language can be changed with parameter A1-00 (Select Language).

Procedure	LCD Display
1. DC Bus Voltage.	<pre> - MODE -  DRV Rdy   DC V Feedback U1-51= 0330V  U1-52= 295V  LSEQ U1-53= 0.0A  LREF           </pre>
2. Press   to select the Programming Mode.	<pre> -MODE-      PRG   Programming           </pre>  <pre> <b>HELP</b>      <b>DATA</b>           </pre>
3. Press  to show the Initialization display.	<pre> -PRMSET- PRG   Initialization ----- A1-00=  0   Select Language           </pre> <p style="text-align: center;"> </p>
4. Press     to select A1-00 and press  .	<pre> -PRMSET- PRG   Select Language ----- A1-00=  0  *0*           English           "1"           </pre> <p style="text-align: center;"> </p>
5. Press   to enter setting 1.	<pre> -PRMSET- PRG   ゲンゴ (Language) ----- A1-00=  1  *0*           コボゴ (Japanese)           "1"           </pre> <p style="text-align: center;"> </p>









Procedure	LCD Display
6. Press  and the option will display Japanese.	<div style="border: 1px solid black; padding: 10px; text-align: center;">             カキコミ カンリョウ           </div>

### Procedure Example: Setting Parameters

The example below explains how to change the Analog Output 1 Monitor Selection parameter H4-01 to 158 from the default setting of 157.

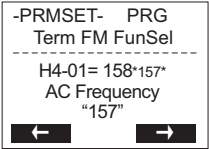
Procedure	LCD Display
1. DC Bus Voltage display.	<div style="border: 1px solid black; padding: 5px;">             - MODE - DRV Rdy              DC V Feedback              U1-51= 0330V              -----              U1-52= 295V <span style="border: 1px solid black; padding: 2px;">LSEQ</span>              U1-53= 0.0A <span style="border: 1px solid black; padding: 2px;">LREF</span>  <span style="background-color: black; color: black;">████████</span> <span style="background-color: black; color: black;">████████</span> </div>
2. Press   to select the Programming Mode.	<div style="border: 1px solid black; padding: 5px;">             -MODE- PRG              Programming    <span style="background-color: black; color: white; padding: 2px;">HELP</span> <span style="background-color: black; color: white; padding: 2px;">DATA</span> </div>
3. Press  to show the Initialization display.	<div style="border: 1px solid black; padding: 5px;">             -PRMSET- PRG              Initialization              -----  <span style="border: 1px solid black; padding: 2px;">A1-00= 0</span>              Select Language  <span style="background-color: black; color: white; padding: 2px;">←</span> <span style="background-color: black; color: white; padding: 2px;">→</span> </div>
4. Press     to select parameter H4-01 and press  .	<div style="border: 1px solid black; padding: 5px;">             -PRMSET- PRG              Term FM FunSel              -----              H4-01= 157*157*              AC Power              "157"  <span style="background-color: black; color: white; padding: 2px;">←</span> <span style="background-color: black; color: white; padding: 2px;">→</span> </div>

## 6 Basic Operation

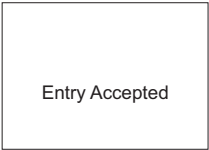
Procedure	LCD Display
5. Press     to enter 158.	 <p>-PRMSET- PRG Term FM FunSel ----- H4-01= 158*157* AC Frequency "157"  </p>
6. Press  to enter and store the new setting for C1-01.	 <p>Entry Accepted</p>







### Read/Copy Function Procedure











- **Read**  
 Reads and saves parameter settings from the regenerative unit to the option.  
**Note:** The option can perform the Read function an estimated 100,000 times.
- **Copy**  
 Copies parameter settings from the option to another Yaskawa regenerative unit.  
 These parameters control the Copy function of the digital operator. The Copy function stores parameter settings into the memory of the digital operator to facilitate the transfer of those settings to other regenerative units that are the same model, capacity, and same control mode setting.  
**Note:** Parameter settings can only be copied to other regenerative units that are the same model, capacity, and have the same control mode setting.
- **Verify**  
 Verifies that parameter settings in the regenerative unit match the parameter settings saved to the option.

The following procedure is used to read parameters from the regenerative unit.

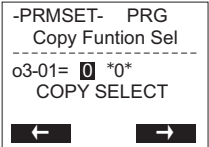
- Note:** Set parameter o3-02 (Read Allowable) to 1 (Enable) to read the parameter settings from the regenerative unit.  
 Set parameter o3-02 to 0 (Disable) to protect the parameter settings in the option.

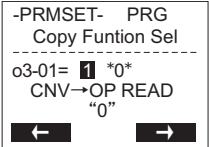
Procedure	LCD Display
1. DC Bus Voltage Reference display.	<div style="border: 1px solid black; padding: 5px;"> <p style="text-align: center;">- MODE - DRV Rdy DC V Feedback U1-51= 0330V</p> <hr style="border-top: 1px dashed black;"/> <p style="text-align: center;">U1-52= 295V <span style="border: 1px solid black; padding: 2px;">LSEQ</span> U1-53= 0.0A <span style="border: 1px solid black; padding: 2px;">LREF</span></p> </div>
2. Press   to select the Programming Mode.	<div style="border: 1px solid black; padding: 5px;"> <p style="text-align: center;">-MODE- PRG Programming</p> <div style="text-align: center;">  </div> <p style="text-align: center;"><span style="border: 1px solid black; padding: 2px;">HELP</span> <span style="border: 1px solid black; padding: 2px;">DATA</span></p> </div>
3. Press  to show the Initialization display.	<div style="border: 1px solid black; padding: 5px;"> <p style="text-align: center;">-PRMSET- PRG Initialization</p> <hr style="border-top: 1px dashed black;"/> <p style="text-align: center;">A1-00= 0 Select Language</p> <p style="text-align: center;"><span style="border: 1px solid black; padding: 2px;">←</span> <span style="border: 1px solid black; padding: 2px;">→</span></p> </div>

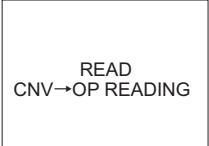
## 6 Basic Operation

Procedure	LCD Display
4. Press     to select o3-01 and press  .	
5. Press   to enter 1 (CNV --> OP READ).	
6. Press  and the option will read the parameter settings from the converter.	
7. Automatically return to the Copy Function Selection display.	

## 7 Related Parameters

Parameters related to the use of the option are listed in *Table 13*. Set these parameters as needed for the application.

**Table 13 Related Parameters**

No.	Name	Unit			Description	Values
		A1000/ V1000	D1000	R1000		
A1-00	Language Selection	YES	YES	YES	<p>Language selection for the option. This parameter is not reset when the unit is initialized by parameter A1-03.</p> <p>0: English 1: Japanese 2: German 3: French 4: Italian 5: Spanish 6: Portuguese 7: Chinese 8: Czech 9: Russian 10: Turkish 11: Polish 12: Greek</p> <p><b>Note: 1.</b> To view information on the display in Czech (8), Russian (9), Turkish (10), Polish (11), or Greek (12), use option software version PRG: 0102 or later and A1000 drive software version PRG: 1018 or later. Those languages cannot be displayed on A1000 models 4A0930 or 4A1200.</p> <p><b>2.</b> When using an option with software version PRG: 0101 or later with a D1000 or R1000, only English (0), Japanese (1), and Chinese (7) are available.</p> <p><b>3.</b> When using an option with a V1000, only English (0), Japanese (1), German (2), French (3), Italian (4), Spanish (5), Portuguese (6), and Chinese (7) are available.</p>	Default: 0 Range: 0 to 12

## 7 Related Parameters

No.	Name	Unit			Description	Values
		A1000/ V1000	D1000	R1000		
b1-01	Frequency Reference Selection 1	YES	N/A	N/A	Selects the source of the frequency reference. 0: Operator -Digital preset speed d1-01 to d1-17 1: Terminals - Analog input terminal A1 or A2 2: MEMOBUS/Modbus serial communications 3: Option PCB 4: Pulse Input (Terminal RP)	Default: 1 Range: 0 to 4
b1-02	Run Command Selection 1	YES	YES	YES	Selects the Run command input source. 0: Operator -RUN and STOP keys on the LCD Operator Option 1: Digital input terminals S1 to S7 2: MEMOBUS/Modbus serial communications 3: Option PCB	Default: 1 Range: 0 to 3
b1-15	Frequency Reference 2	YES	N/A	N/A	Selects the frequency reference input source. 0: Operator - Digital preset speed d1-01 to d1-17 1: Terminals - Analog input terminal A1 or A2 2: MEMOBUS/Modbus serial communications 3: Option PCB 4: Pulse Input (Terminal RP)	Default: 0 Range: 0 to 4
b1-16	Run Command Source 2	YES	N/A	N/A	Selects the Run command input source. 0: Operator - RUN and STOP keys on the LCD Operator Option 1: Digital input terminals S1 to S7 2: MEMOBUS/Modbus serial communications 3: Option PCB	Default: 0 Range: 0 to 3
b1-18	Voltage Reference Source	N/A	YES	N/A	Sets the input source for the DC bus voltage reference. 0: LED operator or LCD operator 1: Control circuit terminal (analog input) 2: MEMOBUS/Modbus communications 3: Option card 7: Input voltage based control 1 8: Input voltage based control 2	Default: 0 Range: 0 to 3, 7, 8
o2-01	LOCAL/REMOTE Key Function Selection	YES	YES	N/A	Enables/Disables the option LOCAL/REMOTE key. 0: Disabled 1: Enabled	Default: 1 Range: 0, 1

## 7 Related Parameters

No.	Name	Unit			Description	Values
		A1000/ V1000	D1000	R1000		
o2-02	STOP Key Function Selection	YES	YES	YES	Enables/Disables the operator panel STOP key when the unit is operated from external sources (not operator). 0: Disabled 1: Enabled	Default: 1 Range: 0, 1
o2-05	Frequency Reference Setting Method Selection	YES	N/A	N/A	Selects if the ENTER key press is required when inputting the frequency reference by the digital operator. 0: Data/Enter key must be pressed to enter a frequency reference. 1: Data/Enter key is not required. The frequency reference is adjusted by the up and down arrow keys.	Default: 0 Range: 0, 1
o2-06	Operation Selection when LCD Operator Option is Disconnected	YES	YES	YES	Sets unit action when the option is removed in LOCAL mode or with b1-02 = 0. 0: The drive, converter, or regenerative unit will continue operation. 1: The drive, converter, or regenerative unit will trigger a fault (oPr) and the motor will coast to stop.	Default: 0 Range: 0, 1
o3-01	Copy Function Selection	YES	YES	YES	This parameter controls the copying of parameters to and from the option. 0: COPY SELECT (no function) 1: All parameters are copied from the drive to the LCD Operator Option. 2: All parameters are copied from the LCD Operator Option to the drive, converter, or regenerative unit. 3: Parameter settings in the drive, converter, or regenerative unit are compared to those in the LCD Operator Option. <b>Note:</b> When using the copy function, the drive model number (o2-04), software number (U1-14), and control method (A1-02) must match or an error will occur.	Default: 0 Range: 0 to 3
o3-02	Copy Allowable	YES	YES	YES	Enables or disables reading of unit parameter settings. 0: Disabled - Read not allowed 1: Enabled - Read allowed	Default: 0 Range: 0, 1

# 8 Option Fault Diagnostics

### ◆ Error Code and Connection Messages

Fault/Error code text will appear on the option display to indicate a specific fault. The fault codes in **Table 14** are displayed on the LED operator and/or the option displays. For information on the fault codes not listed in **Table 14**, refer to the unit manual.

When an option fault occurs, ensure that the communication cable is properly connected to the option and it is not loose.

Contact your nearest Yaskawa representative or sales department if the cable appears to be connect properly but still no message appears to indicate the error.

**Note:** If A1000, D1000, or R1000 is used, the fault codes are displayed on the option only.

**Table 14 Fault/Error Code Displays**

LCD Operator	LED Operator (V1000)	Description
</>	. . . . .	Option is connected This is not an error message.
	. . . . .	This is not an error message. Occurs when the option is connected to the unit.
LCD Operator	LED Operator (V1000)	Description
CPF00 COM-ERR (OP&INV)	</>	LCD Operator Option Communication Error 1
		Occurs when the unit cannot communicate with the option within 5 seconds after the power is switched on.
Cause		Possible Solution
Communication cable between the option and the unit is not properly connected.		Remove and reconnect the option.
Problem with the option.		Replace the option.
Problem with the control circuit in the unit.		<ul style="list-style-type: none"> <li>• Cycle power to the unit.</li> <li>• Replace the unit.</li> </ul>
LCD Operator	LED Operator (V1000)	Description
CPF01 COM-ERR (OP&INV)	</>	LCD Operator Option Communication Error 2
		Occurs when the unit does not respond to the option for longer than 2 seconds.
Cause		Possible Solution
Connector on the option cable is loose or damaged.		Remove and reconnect the option.
Problem with the option.		Replace the option.
Problem with the control circuit in the unit.		<ul style="list-style-type: none"> <li>• Cycle power to the unit.</li> <li>• Replace the unit.</li> </ul>

## 8 Option Fault Diagnostics

LCD Operator	LED Operator (V1000)	Description
oPr Oper Disconnect	oPr	LCD Operator Option Connection Fault
	oPr	Data should appear on the LED operator. By reconnecting the option to the unit, data should also appear on option display. An oPr fault will occur when both of the following conditions are true: Output is interrupted when the option is disconnected (o2-06 = 1). The Run command is assigned to the option (b1-02/b1-16 = 0 and LOCAL is selected).
<b>Cause</b>		<b>Possible Solution</b>
Option is not properly connected to the unit.		<ul style="list-style-type: none"> <li>• Check the connection between the option and the unit.</li> <li>• Replace the cable if damaged.</li> <li>• Turn off the unit input power and disconnect the option. Reconnect the option and reapply unit input power.</li> </ul>

<1> Display will vary depending on operation status.

# 9 Specifications

**Table 15 Option Specifications**

Model	JVOP-180
Connector	RJ-45
Power Supply	Powered from the unit (DC +5 V $\pm$ 5%)
Operating Temperature	-10 to +50°C (+14 to +122°F) </>
Humidity	up to 95% RH (no condensation)
Storage Temperature	-20 to +60°C (-4 to +140°F) (allowed for short-term transport of the product)
Area of Use	Indoor (free of corrosive gas, airborne particles, etc.)
Altitude	Up to 1000 m (3280 ft.)
Shock	10 to 20 Hz: 9.8 m/s <sup>2</sup> 20 to 55 Hz: 5.9 m/s <sup>2</sup>
Read Function Limitation	Estimated 100,000 times

</> The LCD display may respond more slowly if the ambient temperature falls below freezing. Higher temperatures can also shorten the performance life of the LCD display.



## 10 Revision History

The revision dates and numbers of the revised manuals are given on the bottom of the back cover.

MANUAL NO. TOBP C730600 29A

Published in Japan June 2008 07-11 ◊

└─ Date of publication ─┬─ Date of original publication

└─ Revision number ─┬─

Date of Published	Rev. No.	Section	Revised Content
December 2013	◊12	Front cover, back cover	Revision: The title of the manual
November 2013	◊11	All Chapters	Revision: Application to the R1000
		Back cover	Revision: Address
March 2013	◊10	All Chapters	Revision: Application to the D1000
		Back cover	Revision: Address
November 2012	◊9	Chapter 2, 4, 5, and 7	Revision: Revised in accordance with software and hardware upgrade.
		Back cover	Revision: Address
July 2012	◊8	Back cover	Revision: Address
June 2011	◊7	Front cover, back cover	Revision: Format
October 2010	◊6	Chapter 4	Revision: Figure5
August 2010	◊5	Back cover	Revision: Address
April 2010	◊4	Back cover	Revision: Address
December 2008	◊3	Chapter 3	Revision: The part numbers of the additional parts.
August 2008	◊2	All Chapters	Revision: The title of the manual
		All Chapters	Revision: Application to the A1000
June 2008	◊1	Back cover	Revision: Address
November 2007	—	—	First edition

# YASKAWA AC Drive 1000-Series Option LCD Operator Installation Manual

---

## **DRIVE CENTER (INVERTER PLANT)**

2-13-1, Nishimiyachi, Yukufashi, Fukuoka, 824-8511, Japan  
Phone: 81-930-25-3844 Fax: 81-930-25-4369  
<http://www.yaskawa.co.jp>

## **YASKAWA ELECTRIC CORPORATION**

New Pier Takeshiba South Tower, 1-16-1, Kaigan, Minatoku, Tokyo, 105-6891, Japan  
Phone: 81-3-5402-4502 Fax: 81-3-5402-4580  
<http://www.yaskawa.co.jp>

## **YASKAWA AMERICA, INC.**

2121 Norman Drive South, Waukegan, IL 60085, U.S.A.  
Phone: 1-800-YASKAWA (927-5292) or 1-847-887-7000 Fax: 1-847-887-7310  
<http://www.yaskawa.com>

## **YASKAWA ELÉTRICO DO BRASIL LTDA.**

Avenida Piraporinha 777, Diadema, São Paulo, 09950-000, Brasil  
Phone: 55-11-3585-1100 Fax: 55-11-3585-1187  
<http://www.yaskawa.com.br>

## **YASKAWA EUROPE GmbH**

Hauptstrasse 185, 65760 Eschborn, Germany  
Phone: 49-6196-569-300 Fax: 49-6196-569-398  
<http://www.yaskawa.eu.com>

## **YASKAWA ELECTRIC KOREA CORPORATION**

9F Kyobo Securities Bldg., 26-4, Yeouido-dong, Yeongdeungpo-gu, Seoul, 150-737, Korea  
Phone: 82-2-784-7844 Fax: 82-2-784-8495  
<http://www.yaskawa.co.kr>

## **YASKAWA ELECTRIC (SINGAPORE) PTE. LTD.**

151 Lorong Chuan, #04-02A, New Tech Park, 556741, Singapore  
Phone: 65-6282-3003 Fax: 65-6289-3003  
<http://www.yaskawa.com.sg>

## **YASKAWA ELECTRIC (CHINA) CO., LTD.**

12F, Carlton Bld., No.21 HuangHe Road, HuangPu District, Shanghai 200003, China  
Phone: 86-21-5385-2200 Fax: 86-21-5385-3289  
<http://www.yaskawa.com.cn>

## **YASKAWA ELECTRIC (CHINA) CO., LTD. BEIJING OFFICE**

Room 1011, Tower W3 Oriental Plaza, No. 1 East Chang An Ave.,  
Dong Cheng District, Beijing, 100738, China  
Phone: 86-10-8518-4086 Fax: 86-10-8518-4082

## **YASKAWA ELECTRIC TAIWAN CORPORATION**

9F, 16, Nanking E. Rd., Sec. 3, Taipei, 104, Taiwan  
Phone: 886-2-2502-5009 Fax: 886-2-2505-1280

## **YASKAWA INDIA PRIVATE LIMITED**

#17A Electronics City, Hosur Road Bangalore 560 100 (Karnataka), India  
Phone: 91-80-4244-1900 Fax: 91-80-4244-1901  
<http://www.yaskawaindia.in>



YASKAWA ELECTRIC CORPORATION

In the event that the end user of this product is to be the military and said product is to be employed in any weapons systems or the manufacture thereof, the export will fall under the relevant regulations as stipulated in the Foreign Exchange and Foreign Trade Regulations. Therefore, be sure to follow all procedures and submit all relevant documentation according to any and all rules, regulations and laws that may apply. Specifications are subject to change without notice for ongoing product modifications and improvements.

© 2007-2013 YASKAWA ELECTRIC CORPORATION. All rights reserved.

MANUAL NO. TOBP C730600 29G

Published in Japan December 2013 07-11  13-7-11