

YASKAWA AC Drive-V1000 Option MECHATROLINK-II Installation Manual

Type: SI-T3/V

To properly use the product, read this manual thoroughly and retain for easy reference, inspection, and maintenance. Ensure the end user receives this manual.

V1000オプションユニット MECHATROLINK-II 通信 取扱説明書

形式 SI-T3/V

製品を安全にお使い頂くために、本書を必ずお読みください。
また、本書をお手元に保管していただくとともに、最終的に本製品をご使用になるユーザー様のお手元に確実に届けられるよう、お取り計らい願います。

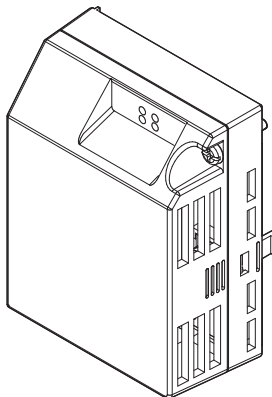

This Page Intentionally Blank



Table of Contents

1 PREFACE AND SAFETY	5
2 PRODUCT OVERVIEW	10
3 RECEIVING	11
4 MECHATROLINK-II OPTION COMPONENTS	12
5 INSTALLATION PROCEDURE	15
6 MECHATROLINK OPTION DRIVE PARAMETERS	22
7 TROUBLESHOOTING	24
8 SPECIFICATIONS	28

Copyright © 2008 YASKAWA ELECTRIC CORPORATION

All rights reserved. No part of this publication may be reproduced, stored in a retrieval system, or transmitted, in any form, or by any means, mechanical, electronic, photocopying, recording, or otherwise, without the prior written permission of Yaskawa. No patent liability is assumed with respect to the use of the information contained herein. Moreover, because Yaskawa is constantly striving to improve its high-quality products, the information contained in this manual is subject to change without notice. Every precaution has been taken in the preparation of this manual. Nevertheless, Yaskawa assumes no responsibility for errors or omissions. Neither is any liability assumed for damages resulting from the use of the information contained in this publication.

1 Preface and Safety

Yaskawa manufactures products used as components in a wide variety of industrial systems and equipment. The selection and application of Yaskawa products remain the responsibility of the equipment manufacturer or end user. Yaskawa accepts no responsibility for the way its products are incorporated into the final system design. Under no circumstances should any Yaskawa product be incorporated into any product or design as the exclusive or sole safety control. Without exception, all controls should be designed to detect faults dynamically and fail safely under all circumstances. All systems or equipment designed to incorporate a product manufactured by Yaskawa must be supplied to the end user with appropriate warnings and instructions as to the safe use and operation of that part. Any warnings provided by Yaskawa must be promptly provided to the end user. Yaskawa offers an express warranty only as to the quality of its products in conforming to standards and specifications published in the Yaskawa manual. **NO OTHER WARRANTY, EXPRESSED OR IMPLIED, IS OFFERED.** Yaskawa assumes no liability for any personal injury, property damage, losses, or claims arising from misapplication of its products.

1 Preface and Safety

◆ Applicable Documentation

The following manuals are available for the MECHATROLINK-II Option:

Option Unit

	V1000 Option MECHATROLINK-II Installation Manual (this book) Manual No. : TOBPC73060049
	Read this manual first. The installation manual is packaged with the MECHATROLINK-II Option and contains a basic overview of wiring, settings, functions, and fault diagnoses.
	V1000 Option MECHATROLINK-II Technical Manual Manual No. : SIEPC73060049
	The technical manual contains detailed information and command registers. To obtain the technical manual access the site below: http://www.e-mechatronics.com

Yaskawa Drive

	V1000 Series AC Drive Technical Manual
	This manual describes installation, wiring, operation procedures, functions, troubleshooting, maintenance, and inspections to perform before operation. To obtain instruction manuals for Yaskawa products access the site below: http://www.e-mechatronics.com
	V1000 Series AC Drive Quick Start Guide
	This guide is packaged together with the product. It contains basic information required to install and wire the drive. This guide provides basic programming and simple set-up and adjustment.

◆ Terms

Note: Indicates supplementary information that Yaskawa highly recommends be followed, even though equipment may not be at risk.

Drive: Yaskawa AC Drive-V1000 Series

MECHATROLINK-II Option: Yaskawa AC Drive-V1000 Option MECHATROLINK-II

≥ 1016: Indicates a drive feature or function that is only available in drive software version 1016 or later.

◆ Registered Trademarks

- MECHATROLINK-I/MECHATROLINK-II is a registered trademark of the MECHATROLINK Members Association (MMA).
- Other company names and product names listed in this manual are registered trademarks of those companies.

◆ Supplemental Safety Information

Read and understand this manual before installing, operating, or servicing this option unit. The option unit must be installed according to this manual and local codes.

The following conventions are used to indicate safety messages in this manual. Failure to heed these messages could result in serious or possibly even fatal injury or damage to the products or to related equipment and systems.

DANGER

Indicates a hazardous situation, which, if not avoided, will result in death or serious injury.

WARNING

Indicates a hazardous situation, which, if not avoided, could result in death or serious injury.

CAUTION

Indicates a hazardous situation, which, if not avoided, could result in minor or moderate injury.

NOTICE

Indicates an equipment damage message.

1 Preface and Safety

■ General Safety

General Precautions

- The diagrams in this section may include option units and drives without covers or safety shields to illustrate details. Be sure to reinstall covers or shields before operating any devices. The option should be used according to the instructions described in this manual.
- Any illustrations, photographs, or examples used in this manual are provided as examples only and may not apply to all products to which this manual is applicable.
- The products and specifications described in this manual or the content and presentation of the manual may be changed without notice to improve the product and/or the manual.
- When ordering a new copy of the manual due to damage or loss, contact your Yaskawa representative or the nearest Yaskawa sales office and provide the manual number shown on the front cover.

DANGER

Heed the safety messages in this manual.

Failure to comply will result in death or serious injury.

The operating company is responsible for any injuries or equipment damage resulting from failure to heed the warnings in this manual.

NOTICE

Do not expose the drive to halogen group disinfectants.

Failure to comply may cause damage to the electrical components in the option unit.

Do not pack the drive in wooden materials that have been fumigated or sterilized.

Do not sterilize the entire package after the product is packed.

Do not modify the drive circuitry.

Failure to comply could result in damage to the drive and will void warranty.

YASKAWA is not responsible for any modification of the product made by the user. This product must not be modified.

■ Option Unit Label Warnings

Warning information is displayed on the option unit as shown in the figure below. Follow all warnings and safety instructions when using the product.

When using the drive in an area that may require displaying warning information in Japanese or Chinese, a warning label sticker is provided with the MECHATROLINK-II Option. This sticker can be placed over the English and French warnings on the front of the MECHATROLINK-II Option.

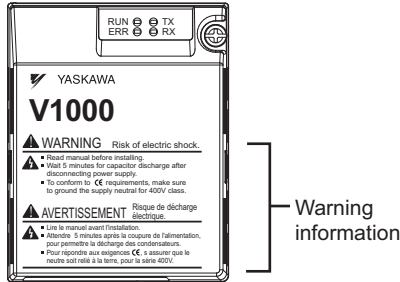

■ Warning Contents

WARNING Risk of electric shock.

-  Read manual before installing.
- Wait 5 minutes for capacitor discharge after disconnecting power supply.
- To conform to **CE** requirements, make sure to ground the supply neutral for 400V class.

AVERTISSEMENT Risque de décharge électrique.

- Lire le manuel avant l'installation.
-  Attendre 5 minutes après la coupure de l'alimentation, pour permettre la décharge des condensateurs.
- Pour répondre aux exigences **CE**, s'assurer que le neutre soit relié à la terre, pour la série 400V.

2 Product Overview

◆ About This Product

MECHATROLINK-II Option (Model: SI-T3/V) is designed for connecting a drive to a field network using the MECHATROLINK protocol.

By installing the MECHATROLINK-II Option to a drive, it is possible to do the following from a MECHATROLINK master device:

- operate the drive
- monitor the operation status of the drive
- change parameter settings.

◆ Applicable Model

The MECHATROLINK-II Option can be used with the drive models in [Table 1](#).

Table 1 Applicable Model

Drive	Software Version <I>
V1000	≥ 1016

<I> See “PRG” on the drive nameplate for the software version number.



3 Receiving

Please perform the following tasks after receiving the MECHATROLINK-II Option:

- Inspect the MECHATROLINK-II Option for damage.
If the MECHATROLINK-II Option appears damaged upon receipt, contact the shipper immediately.
- Verify receipt of the correct model by checking the information on the nameplate (see [Figure 1](#)).
- If you have received the wrong model or the MECHATROLINK-II Option does not function properly, contact your supplier.

◆ Contents and Packaging

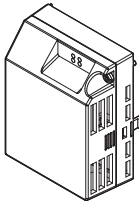
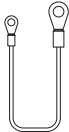
Table 2 Contents of Package

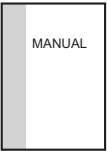
Description:	Option Unit	Ground Cables	Warning Label Stickers	Installation Manual
-				
Quantity:	1	4	1	1

◆ Tool Requirements

A Phillips screwdriver (#2, #3 <1>) U.S. standard size is required to install the MECHATROLINK-II Option.

<1> Screw sizes vary by drive capacity. Select a screwdriver that matches the drive ground terminal (M3.5 to M6).

4 MECHATROLINK-II Option Components

◆ MECHATROLINK-II Option

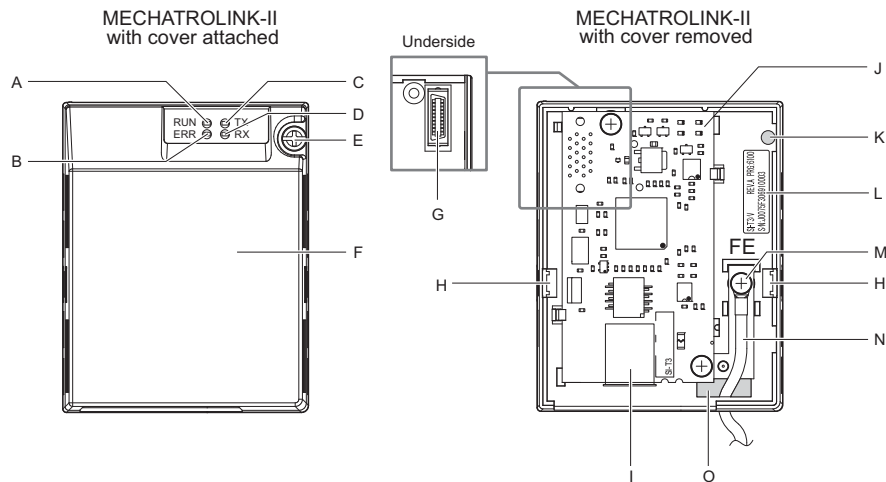

- A – LED (RUN: green)
- B – LED (ERR: red)
- C – LED (TX: green)
- D – LED (RX:green)
- E – Attachment screw (M3)
- F – Option cover
- G – Option connector
- H – Mounting clip

- I – Connector
- J – MECHATROLINK-II PCB
- K – Attachment screw hole for option cover
- L – Nameplate
- M – Function Earth cable connection (FE)
- N – Ground Cable <1>
- O – Through-hole for cable

<1> Cables are not connected to the MECHATROLINK-II Option and are packaged separately in the box.

Figure 1 Option Unit

Note: For details on the LEDs, [Refer to MECHATROLINK-II Option LED Display on page 14.](#)

◆ Dimensions

The installed MECHATROLINK-II Option adds 27 mm to the total depth of the drive.

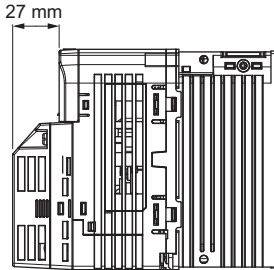

Figure 2 Dimensions

◆ Connector

Table 3 Connector Descriptions

Connector	Pin No.	Signal Name	I/O	Function
CN3	A1	(NC)	–	Not used.
	A2	SRD–	I/O	Send/receive data (–)
	A3	SRD+	I/O	Send/receive data (+)
	A4	(NC)	–	Not used.
	Shell	SLD	–	Shield
	B1	(NC)	–	Not used.
	B2	SRD–	I/O	Send/receive data (–)
	B3	SRD+	I/O	Send/receive data (+)
	B4	(NC)	–	Not used.
Shell	SLD	–	Shield	

4 MECHATROLINK-II Option Components

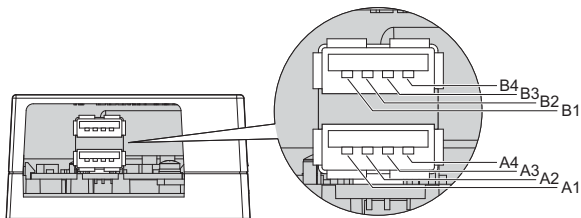

Figure 3 MECHATROLINK-II Option Connector

◆ MECHATROLINK-II Option LED Display

Table 4 MECHATROLINK-II Operation LED Status

LED	Display	Status	Remarks
RUN	ON	Power supply on	SI-T3/V has been successfully powered up
	OFF	No power	<ul style="list-style-type: none"> The drive has no power SI-T3/V is not properly connected to the drive, or SI-T3/V has no power An internal, self-diagnostic error occurred in the SI-T3/V
ERR	ON	Connection error	<ul style="list-style-type: none"> SI-T3/V is not properly connected to the drive Communication error
	Flashing	SI-T3/V error	Error found during SI-T3/V's self-diagnostic check
	OFF	Normal operation	<ul style="list-style-type: none"> SI-T3/V is properly connected to the drive Communication normal
TX	ON	Sending data	Data is being sent (LED may appear to be flashing)
	OFF	Not sending data	<ul style="list-style-type: none"> Not data is being sent During reset
RX	ON	Receiving data	Data is being received (LED may appear to be flashing)
	OFF	Not receiving data	<ul style="list-style-type: none"> Not data is being received During reset

5 Installation Procedure

◆ Section Safety

DANGER

Electrical Shock Hazard

Do not connect or disconnect wiring while the power is on.

Failure to comply will result in death or serious injury.

Disconnect all power to the drive, wait at least five minutes after all indicators are off, measure the DC bus voltage to confirm safe level, and check for unsafe voltages before servicing to prevent electric shock. The internal capacitor remains charged even after the power supply is turned off. The charge indicator LED will extinguish when the DC bus voltage is below 50 Vdc.

WARNING

Electrical Shock Hazard

Do not remove option cover while the power is on.

Failure to comply could result in death or serious injury.

The diagrams in this section may include option units and drives without covers or safety shields to show details. Be sure to reinstall covers or shields before operating any devices. The option should be used according to the instructions described in this manual.

Do not allow unqualified personnel to use equipment.

Failure to comply could result in death or serious injury.

Maintenance, inspection, and replacement of parts must be performed only by authorized personnel familiar with installation, adjustment, and maintenance of this product.

Do not remove option cover while the power to the drive is on.

Failure to comply could result in death or serious injury.

Do not use damaged wires, place excessive stress on wiring, or damage the wire insulation.

Failure to comply could result in death or serious injury.

NOTICE

Damage to Equipment

Observe proper electrostatic discharge procedures (ESD) when handling the option unit, drive, and circuit boards.

Failure to comply may result in ESD damage to circuitry.

Never shut the power off when the drive is outputting voltage.

Failure to comply may cause the application to operate incorrectly or damage the drive.

Do not operate damaged equipment.

Failure to comply may cause further damage to the equipment.

Do not connect or operate any equipment with visible damage or missing parts.

Do not use unshielded cable for control wiring.

Failure to comply may cause electrical interference resulting in poor system performance.

Use shielded twisted-pair wires and ground the shield to the ground terminal of the drive.

Properly connect all pins and connectors.

Failure to comply may prevent proper operation and possibly damage equipment.

Check wiring to ensure that all connections are correct after installing the option unit and connecting any other devices.

Failure to comply may result in damage to the option unit.

◆ Wiring Diagram

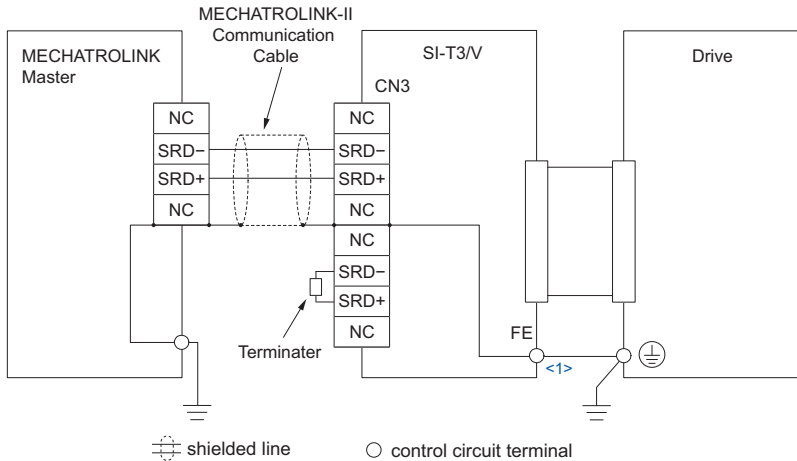

- <1> The FE terminal on the MECHATROLINK-II Option is supplied with a ground cable that should be connected to the ground terminal on the drive.
 If there are noise influences on communication, remove the grounding cable.

Figure 4 Wiring Diagram

5 Installation Procedure

◆ Prior to Installing the Option Unit

Prior to installing the MECHATROLINK-II Option, wire the drive and make necessary connections to the drive terminals. Refer to the Quick Start Guide for information on wiring and connecting the drive. Verify that the drive functions normally prior to installing the Option.

◆ Installing the Option Unit

Remove the front cover of the drive before installing the MECHATROLINK-II Option. Follow the directions below for proper installation.

1. Switch off the power supply to the drive.

DANGER! Electrical Shock Hazard - Do not connect or disconnect wiring while the power is on. Failure to comply will result in death or serious injury. Before installing the MECHATROLINK-II Option, disconnect all power to the drive. The internal capacitor remains charged even after the power supply is turned off. The charge indicator LED will extinguish when the DC bus voltage is below 50 Vdc. To prevent electric shock, wait at least five minutes after all indicators are off and measure the DC bus voltage level to confirm safe level.

2. Remove the front cover. The original drive front cover may be discarded because it will be replaced by the MECHATROLINK-II Option cover in step 8.

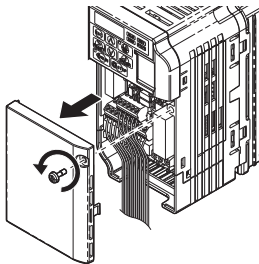

Figure 5 Remove Front Cover

3. Remove the bottom cover and connect the MECHATROLINK-II Option ground cable to the ground terminal.

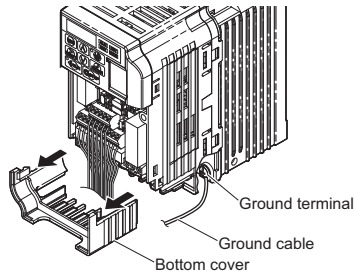
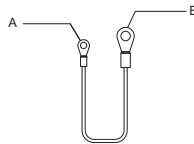

Figure 6 Connect Ground Cable

Note: The four different ground cables packaged with the MECHATROLINK-II Option connect the unit to different models. Select the proper ground cable from the MECHATROLINK-II Option kit depending on drive size.



A – Option unit connection: screw size = M3

B – Drive-side connection: screw size = M3.5 to M6

Figure 7 Ground Cable

Note: Remove the terminal cover <1> before removing the bottom cover to install the MECHATROLINK-II Option. Replace the terminal cover after wiring the MECHATROLINK-II Option.

<1> **Models with a Terminal Cover:**

- Single-Phase 200 V Class: CIMR-V□BA0006 to BA0018
- Three-Phase 200 V Class: CIMR-V□2A0008 to 2A0069
- Three-Phase 400 V Class: All models

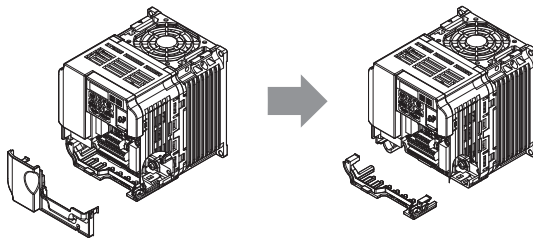

Figure 8 Models with Terminal Cover

5 Installation Procedure

4. Reattach the bottom cover.
5. Connect the MECHATROLINK-II Option to the drive. Properly secure the tabs on the left and right sides of the MECHATROLINK-II Option to the drive case.

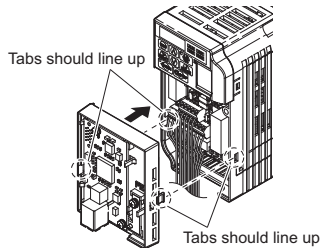

Figure 9 Attach MECHATROLINK-II Option

6. Connect the ground cable from the drive ground terminal to the MECHATROLINK-II Option ground. When wiring the MECHATROLINK-II Option, pass the ground cable through the inside of the drive bottom cover, then pass the ground cable into the through-hole at the front of the MECHATROLINK-II Option.

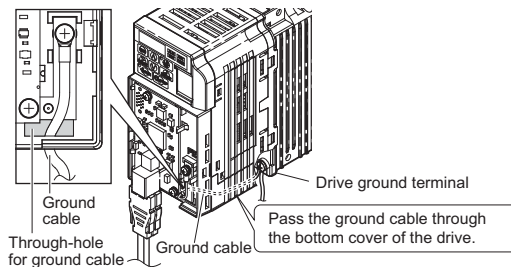

Figure 10 Ground Cable Connection

7. Connect the communications cable to the connector.

8. Attach the MECHATROLINK-II Option cover to the front of the MECHATROLINK-II Option.

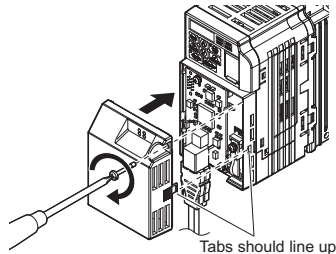

Figure 11 Attach Cover

Note: When using the drive in an area that may require displaying warning information in Japanese or Chinese, a sticker has been provided with the MECHATROLINK-II Option. This sticker can be placed over the English and French warnings on the front of the MECHATROLINK-II Option.

◆ MECHATROLINK-II Communications Cables

Wire the MECHATROLINK-II communications cables to the communications connector (CN3). Install MECHATROLINK-II communications cables apart from main-circuit wiring and other electrical and power lines.

Note: 1. For communications cables, use special shielded twisted-pair cables for MECHATROLINK communications.

Recommended cable: JEPMC-W6002-□□-E </>

JEPMC-W6003-□□-E (with a core) </>

2. Connect the terminator (model No.: JEPMC-W6022-E) on the end of the communication lines.
3. Maximum transmission distance is 50 m. Minimum wiring distance between stations is 0.5 m.

</> □□ is the length (m).

6 MECHATROLINK Option Drive Parameters

Confirm proper setting of the all parameters in *Table 5* before starting network communications.

Table 5 Parameter Settings

No.	Name	Description	Default
b1-01 <>	Frequency Reference Selection	Selects the frequency reference input source. 0: Operator - Digital preset speed d1-01 to d1-17 1: Terminals - Analog input terminal A1 or A2 2: MEMOBUS communications 3: Option PCB 4: Pulse Input (Terminal RP)	1
b1-02 <>	Run Command Selection	Selects the run command input source. 0: Operator - RUN and STOP keys on the digital operator 1: Digital input terminals 2: MEMOBUS communications 3: Option PCB	1
F6-01 <>	Communications Error Operation Selection	0: Ramp to stop. Decelerate to stop using the deceleration time in C1-02. 1: Coast to stop. 2: Fast Stop. Decelerate to stop using the deceleration time in C1-09. 3: Alarm only.	1
F6-02	Selection of External Fault from Communication Option Board	0: Always detected 1: Detection during run only	0
F6-03 <>	Communication Option Fault Stopping Method	0: Ramp to stop. Decelerate to stop using the deceleration time in C1-02. 1: Coast to stop. 2: Fast Stop. Decelerate to stop using the deceleration time in C1-09. 3: Alarm only.	1
F6-07	NetRef/ComRef Function Selection	0: Multi-step reference disabled (same as F7) 1: Multi-step reference enabled (same as V7)	1
F6-08	Reset Communication Parameters	0: Communication-related parameters (F6-□□) are not reset when the drive is initialized using A1-02. 1: Reset all communication-related parameters (F6-□□) when the drive is initialized using A1-02.	0
F6-20 <> <>	MECHATROLINK Station Address	20 to 3FH	21
F6-21 <>	MECHATROLINK Frame Size	0: 32 byte 1: 17 byte	0
F6-22 <>	MECHATROLINK Link Speed	0: 10 Mbps 1: 4 Mbps	0

6 MECHATROLINK Option Drive Parameters

No.	Name	Description	Default
F6-23 <3> <4>	MECHATROLINK Monitor Selection (E)	0 to FFFFH	0
F6-24 <3> <4>	MECHATROLINK Monitor Selection (F)	0 to FFFFH	0
F6-25	Operation Selection at Watchdog Error (E5)	0: Ramp to stop. Decelerate to stop using the deceleration time in C1-02. 1: Coast to stop. 2: Fast Stop. Decelerate to stop using the deceleration time in C1-09. 3: Alarm only.	1
F6-26	MECHATROLINK bUS Errors Detected	Sets the number of option communication errors (bUS). 2 to 10	2

- <1> To start and stop the drive with the MECHATROLINK master device using serial communications, set b1-02 to 3. To control the frequency reference of the drive via the master device, set b1-01 to 3.
- <2> If set to 3, then the drive will continue to operate when a fault is detected. Take proper measures such as installing an emergency stop switch.
- <3> Power must be cycled in order for any setting changes to take affect.
- <4> All station addresses must be unique. If set to 20 or 3F, a Station Address Error (AEr) will occur and the ERR light will turn on.
- <5> Setting byte 10 of INV_CTL to 0EH enables the register set by F6-23. Byte 11 and 12 of the response data enable the register content set by F6-23.
Refer to the SI-T3/V Technical Manual for detail.
- <6> Setting byte 10 of INV_CTL to 0FH enables the register set by F6-24. Byte 11 and 12 of the response data enable the register content set by F6-24.
Refer to the SI-T3/V Technical Manual for detail.

7 Troubleshooting

◆ Drive-Side Error Codes

Drive-side error codes appear on the drive's LED operator. Causes of the errors and corrective actions are listed in [Table 6](#).

For additional error codes that may appear on the LED operator screen, refer to the V1000 Technical Manual.

■ Faults

Both bUS (MECHATROLINK-II Option Communication Error), EF0 (External Fault Input from the MECHATROLINK-II Option) and E5 (SI-T Watchdog Timer Error) can appear as an alarm or as a fault. When a fault occurs, the digital operator ALM LED remains. When an alarm occurs, the digital operator ALM LED flashes.

If communication stops while the drive is running, answer the following questions to help remedy the fault:

- Is the MECHATROLINK-II Option properly installed?
- Is the communication line properly connected to the MECHATROLINK-II Option? Is it loose?
- Is the PLC program working? Has the PLC CPU stopped?
- Did a momentary power loss interrupt communications?

Table 6 Fault Display and Possible Solutions

LED Operator Display		Fault Name
<i>bUS</i>	bUS	MECHATROLINK-II Option Communication Error
		After establishing initial communication, the connection was lost. Only detected when the run command or frequency reference is assigned to the option (b1-01 = 3 or b1-02 = 3).
Cause		Possible Solution
Master controller (PLC) has stopped communicating.		Check for any faulty wiring. ⇒ Correct any wiring problems.
Communication cable is not connected properly.		⇒ Take care of any grounding problems or disconnects wires.
A data error occurred due to noise		Check the various options available to minimize the effects of noise. ⇒ Take steps to counteract noise in the control circuit wiring, main circuit lines, and ground wiring. ⇒ If the magnetic contactor is identified as a source of noise, install a surge absorber to the contactor coil. ⇒ Use cables recommended by Yaskawa, or another type of shielded line. The shield should be grounded on the PLC side and on the option unit side.
MECHATROLINK-II Option is damaged.		⇒ If there are no problems with the wiring and the error continues to occur, replace the MECHATROLINK-II Option.

LED Operator Display		Fault Name
E5	E5	SI-T Watchdog Timer Error The watchdog has timed out.
Cause		Possible Solution
Data has not been received from the PLC, triggering the watchdog timer.		⇒ Execute DISCONNECT or ALM_CLR, then issue a CONNECT command or SYNC_SET command and proceed to phase 3.

LED Operator Display		Fault Name
EF0	EF0	External Fault Input from MECHATROLINK-II Option The alarm function for an external device has been triggered.
Cause		Possible Solution
An external fault is being sent from the master controller (PLC).		⇒ Remove the cause of the external fault. ⇒ Reset the external fault input from the PLC device.
Problem with the PLC program		⇒ Check the program used by the PLC and make the appropriate corrections.

LED Operator Display		Fault Name
oFA00	oFA00	MECHATROLINK-II Option Fault MECHATROLINK-II Option is not properly connected.
Cause		Possible Solution
Non-compatible option connected to the drive		⇒ Connect an option that is compatible with the drive.

LED Operator Display		Fault Name
oFA01	oFA01	MECHATROLINK-II Option Fault MECHATROLINK-II Option is not properly connected.
Cause		Possible Solution
Problem with the connectors between the drive and MECHATROLINK-II Option		⇒ Turn the power off and check the connectors between the drive and MECHATROLINK-II Option.

7 Troubleshooting

LED Operator Display		Fault Name
oFA03	oFA03	MECHATROLINK-II Option Fault
		MECHATROLINK-II Option self-diagnostics error
Cause		Possible Solution
MECHATROLINK-II Option hardware fault		⇒ Replace the MECHATROLINK-II Option. Contact Yaskawa for assistance.

LED Operator Display		Fault Name
oFA04	oFA04	MECHATROLINK-II Option Fault
		MECHATROLINK-II Option Flash write mode
Cause		Possible Solution
MECHATROLINK-II Option hardware fault		⇒ Replace the MECHATROLINK-II Option. Contact Yaskawa for assistance.

LED Operator Display		Fault Name
oFA30 to oFA43	oFA30 to oFA43	MECHATROLINK-II Option Fault
		Communication ID error
Cause		Possible Solution
MECHATROLINK-II Option hardware fault		⇒ Replace the MECHATROLINK-II Option. Contact Yaskawa for assistance.

■ Minor Faults and Alarms

LED Operator Display		Minor Fault Name	
<i>AEr</i>	AEr	Station Address Error	
		MECHATROLINK-II Option is set to an address outside the allowable setting range.	
Cause		Possible Solution	Minor Fault (H2-□□ = 10)
Address outside the specified address range		⇒ Set F6-20 to an address within the specified range.	YES

LED Operator Display		Minor Fault Name	
<i>CALL</i>	CALL	Serial Communication Transmission Error	
		Communication has not yet been established.	
Cause		Possible Solution	Minor Fault (H2-□□ = 10)
Communication wiring is faulty, there is a short circuit, or something is not connected properly.		Check for wiring errors. ⇒ Correct the wiring. ⇒ Remove and ground shorts and reconnect loose wires.	YES
Programming error on the master side		⇒ Check communications at start-up and correct programming errors.	
Communication circuitry is damaged.		Perform a self-diagnostics check. ⇒ Replace the drive if the fault continues to occur.	

8 Specifications

◆ Specifications

Table 7 Option Specifications

Model	SI-T3/V (PCB model: SI-T3)
Access mode	Start-stop synchronization, master/slave method
Communication Speed	10 Mbps (MECHATROLINK-II), 4 Mbps (MECHATROLINK-I)
Transmission cycle	500 μ s to 8 ms <1>
Maximum transmission distance	50 m <2>
Minimum wiring distance between stations	0.5 m
Data length	17-byte data transmission or 32-byte data transmission <3>
Maximum number of stations	30 <2> <4>
Ambient Temperature	-10°C to +50°C
Humidity	up to 95% RH (no condensation)
Storage Temperature	-20°C to +60°C (allowed for short-term transport of the product)
Area of Use	Indoors (free of corrosive gas, airborne particles, etc.)
Altitude	Up to 1000 m

<1> For MECHATROLINK-I, a cycle is 2 ms. For MECHATROLINK-II, a cycle is 1 ms to 8 ms for a 32-byte data transmission, and 500 μ s to 8 ms for a 17-byte data transmission.

<2> At the maximum transmission distance of 50 m, the maximum number of stations is 15.

<3> For MECHATROLINK-I, only a 17-byte data transmission can be selected.

<4> The maximum number of connectable stations changes depending on the types and settings of the host master, baud rate, or communications cycle. For details, refer to the manuals of your master.

Communications cycle: Integral multiple of transmission cycles (depending on the host master settings).

Example: If the host master is an MP2300

- For MECHATROLINK-II (32-byte transmission, 2.0 ms communications cycle: 21 stations max. (21 stations can be set, but then the maximum number of connectable drives will be 16.)

- For MECHATROLINK-II (32-byte transmission, 1.0 ms communications cycle: 9 stations max.

- For MECHATROLINK-II (17-byte transmission, 1.0 ms communications cycle: 15 stations max.

- For MECHATROLINK-I: 14 stations max.

◆ Revision History

The revision dates and numbers of the revised manuals are given on the bottom of the back cover.

MANUAL NO. TOBP C730600 49A

Published in Japan May 2010 08-10 1

└ Date of publication

└ Revision number

└ Date of original publication

Date of Publication	Rev. No.	Section	Revised Content
February 2014	5	Back cover	Revision: Address
May 2013	4	Back cover	Revision: Address
November 2011	3	Front cover, back cover	Revision: Format
September 2010	2	Back cover	Revision: Address
May 2010	1	Back cover	Revision: Address
October 2008	-	-	First edition

YASKAWA AC Drive-V1000 Option MECHATROLINK-II Installation Manual

DRIVE CENTER (INVERTER PLANT)

2-13-1, Nishimiyachi, Yukufashi, Fukuoka, 824-8511, Japan
Phone: 81-930-25-3844 Fax: 81-930-25-4369
<http://www.yaskawa.co.jp>

YASKAWA ELECTRIC CORPORATION

New Pier Takeshiba South Tower, 1-16-1, Kaigan, Minatoku, Tokyo, 105-6891, Japan
Phone: 81-3-5402-4502 Fax: 81-3-5402-4580
<http://www.yaskawa.co.jp>

YASKAWA AMERICA, INC.

2121 Norman Drive South, Waukegan, IL 60085, U.S.A.
Phone: 1-800-YASKAWA (927-5292) or 1-847-887-7300 Fax: 1-847-887-7310
<http://www.yaskawa.com>

YASKAWA ELÉTRICO DO BRASIL LTDA.

Avenida Piraporinha 777, Diadema, São Paulo, 09950-000, Brasil
Phone: 55-11-3585-1100 Fax: 55-11-3585-1187
<http://www.yaskawa.com.br>

YASKAWA EUROPE GmbH

Hauptstrasse 185, 65760 Eschborn, Germany
Phone: 49-6196-569-300 Fax: 49-6196-569-398
<http://www.yaskawa.eu.com>

YASKAWA ELECTRIC KOREA CORPORATION

9F Kyobo Securities Bldg., 26-4, Yeouido-dong, Yeongdeungpo-gu, Seoul, 150-737, Korea
Phone: 82-2-784-7844 Fax: 82-2-784-8495
<http://www.yaskawa.co.kr>

YASKAWA ELECTRIC (SINGAPORE) PTE. LTD.

151 Lorong Chuan, #04-02A, New Tech Park, 556741, Singapore
Phone: 65-6282-3003 Fax: 65-6289-3003
<http://www.yaskawa.com.sg>

YASKAWA ELECTRIC (CHINA) CO., LTD.

12F, Carlton Bld., No.21 HuangHe Road, HuangPu District, Shanghai 200003, China
Phone: 86-21-5385-2200 Fax: 86-21-5385-3299
<http://www.yaskawa.com.cn>

YASKAWA ELECTRIC (CHINA) CO., LTD. BEIJING OFFICE

Room 1011, Tower W3 Oriental Plaza, No. 1 East Chang An Ave.,
Dong Cheng District, Beijing, 100738, China
Phone: 86-10-8518-4086 Fax: 86-10-8518-4082

YASKAWA ELECTRIC TAIWAN CORPORATION

9F, 16, Nanking E. Rd., Sec. 3, Taipei, 104, Taiwan
Phone: 886-2-2502-5009 Fax: 886-2-2505-1280

YASKAWA INDIA PRIVATE LIMITED

#17A Electronics City, Hosur Road Bangalore 560 100 (Karnataka), India
Phone: 91-80-4244-1900 Fax: 91-80-4244-1901
<http://www.yaskawaindia.in>



YASKAWA ELECTRIC CORPORATION

In the event that the end user of this product is to be the military and said product is to be employed in any weapons systems or the manufacture thereof, the export will fall under the relevant regulations as stipulated in the Foreign Exchange and Foreign Trade Regulations. Therefore, be sure to follow all procedures and submit all relevant documentation according to any and all rules, regulations and laws that may apply. Specifications are subject to change without notice for ongoing product modifications and improvements.

© 2008-2014 YASKAWA ELECTRIC CORPORATION. All rights reserved.

MANUAL NO. TOBP C730600 49A

Published in Japan February 2014 08-10 -0
13-7-11