



# Varispeed-656DC5 System Regen Convertor (VS-656DC5)

Model: CIMR-D5A

400V Class 200~800kW (300~1200kVA)

600V Class 300~1200kW (400~1600kVA)

## **Enclosure Installation Manual**

Keep this operator's manual for reference when using this product.

# Table of Contents

<b>Safety Notes</b> .....	<b>3</b>
<b>1. Product Checks</b> .....	<b>6</b>
1.1 Checks Upon Delivery .....	6
1.2 Temporary Storage .....	6
1.2.1 Storage Location .....	6
1.2.2 Storage Method .....	7
<b>2. Transport</b> .....	<b>8</b>
2.1 Cautionary Items During Transport .....	8
2.2 Cautionary Items in Suspending the Unit from Cables .....	8
2.3 Pushing on A Gas-Assisted Loading Cart .....	9
<b>3. Installation</b> .....	<b>10</b>
3.1 Preparation Prior to Installation (Selecting a Location) .....	10
3.2 Leveling .....	10
3.3 Linking of Enclosures (Row Enclosures) .....	10
3.4 Tightening of Base Bolts .....	12
<b>4. Wiring</b> .....	<b>13</b>
4.1 Terminal Position .....	13
4.1.1 DC Input Enclosure .....	13
4.2 Control Circuit Wiring .....	15
4.2.1 The Control Circuit Terminal Block and The General Terminal Block ...	15
<b>5. Grounding</b> .....	<b>16</b>
5.1 Connecting the Grounding Bus .....	16
5.2 Connection of Control Signal Ground .....	16
<b>6. Maintenance/Inspection</b> .....	<b>17</b>
6.1 Cleaning .....	17
6.2 Maintenance Inspection .....	18
6.3 Module Installation/Removal .....	19
6.3.1 Module Removal .....	19
6.3.2 Module Installation .....	20
6.4 Enclosure Exchange Fan Unit .....	21
6.5 Module Disposal .....	22
<b>7. Spare Parts</b> .....	<b>23</b>
7.1 Enclosure .....	23

## YASKAWA ELECTRIC CORPORATION

### General Precautions

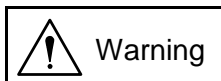
- Some drawings in this manual are shown with the protective covers and shields removed, in order to illustrate detail with more clarity. Make sure all covers and shields are replaced before operating this product.
- This manual may be modified when necessary to reflect improvements to the product, or changes in specifications. Such modifications are denoted by a revised manual No.
- To order a copy of this manual, contact your YASKAWA representative.
- YASKAWA is not responsible for any modification of the product made by the user. Any modifications will void the warranty.

### Safety Symbols

This manual uses the following symbols according to safety-related content. Be sure to observe all notes appended with a safety-related symbol as they contain important information.



**Errors in handling may result in a hazardous condition, possibly resulting in serious injury or death.**



**Errors in handling may result in a hazardous condition, possibly resulting in serious or light injury, as well as material damage. Furthermore, items marked with may lead to more serious results due to the conditions.**

Danger-related symbols differ between the ISO criteria and JIS criteria.

ISO Criteria	JIS Criteria

ISO symbols are used in this manual.

The product warning display labels may be either ISO or JIS standard. Treat either in the same manner.

### Meaning of Basic Terms

In this manual, the following term has the meaning shown below, unless otherwise specified.

- Module : Converter Module




## Safety Notes

Be sure prior to installation, running, maintenance, and inspection, to thoroughly read this manual and other affiliated materials, and to use the product properly. Use this product only after familiarizing oneself with all safety information and cautionary items, and having a thorough knowledge of the device.


### ■ Inspection Upon Receipt of this Product

	
	See Page
<ul style="list-style-type: none"> <li>Do not install or operate a unit which is damaged or has parts missing from it. This may result in injury.</li> </ul>	<a href="#">6</a>


### ■ Transport

	
	See Page
<ul style="list-style-type: none"> <li>Use a qualified operator when transporting the unit by crane. Failure to do so may result in injury or dropping of unit.</li> </ul>	<a href="#">8</a>


### ■ Wiring


	
	See Page
<ul style="list-style-type: none"> <li>Install this unit after verifying that the input power is OFF. Failure to do so may lead to electric shock or fire.</li> <li>Wiring should be performed by a skilled electrician. Failure to do so may lead to electric shock or fire.</li> <li>Be sure to ground the grounding terminal. Failure to do so may lead to electric shock or fire.</li> </ul>	<a href="#">13</a> <a href="#">13</a> <a href="#">13</a>

### ■ Module Disposal


	
	See Page
<ul style="list-style-type: none"> <li>Prior to disposing of the module, drill a hole in the heat pipe mounted within the module and flow air into the unit. Not opening the pipe and releasing the heat may cause the pipe to burst, resulting in injury.</li> </ul>	<a href="#">22</a>

■ **Maintenance/Testing**

 <b>WARNING</b>	
	See Page
<ul style="list-style-type: none"> <li>• Do not touch the terminals on the enclosure as they carry a high voltage. This may lead to electric shock. <span style="float: right;">17</span></li> <li>• Perform maintenance and testing after removing the upper level power supply and verifying that the CHARGE lamp has gone out. There is danger in that a charge remains in the capacitor. This may lead to electric shock. In any case, use a voltmeter to measure for high voltage prior to performing maintenance. <span style="float: right;">17</span></li> <li>• Only designated persons should perform maintenance, testing, and parts replacement. When performing maintenance, remove accessories (watches, bracelets, etc.) prior to working. Use insulated tools. Failure to do so may lead to electric shock. <span style="float: right;">17</span></li> </ul>	

 <b>CAUTION</b>	
	See Page
<ul style="list-style-type: none"> <li>• The control unit uses an CMOS IC. Keep this in mind while handling the unit. Static electricity may damage the IC if it is touched directly with fingers. <span style="float: right;">17</span></li> <li>• Do not change wiring or install/remove connectors while power is applied. This may result in injury. <span style="float: right;">17</span></li> </ul>	

■ **Module Installation/Removal**

 <b>WARNING</b>	
	See Page
<ul style="list-style-type: none"> <li>• Install/remove this module after verifying that the upper level power supply is OFF. Failure to do so may lead to electric shock. <span style="float: right;">19</span></li> <li>• Use a dedicated lifter when mounting/dismounting the module. Failure to do so may result in injury. <span style="float: right;">19</span></li> </ul>	

■ **General Cautionary Items**

**IMPORTANT**

- The figures and photographs in this manual are representative examples. The actual product delivered may differ from these.
- Modifications may be made to this manual due to improvements in the product, specification changes, as well as for purposes of improving the usability of this manual.
- These changes will be reflected in an update of the manual's document number, and its issuance as a revision. The edition number of the revision will be displayed on the back cover.
- To request another copy of this manual due to damage or loss, contact your Yaskawa representative, or the nearest Yaskawa sales office listed on the back cover with the document number.
- If the nameplate on the product somehow is damaged, request a nameplate from your Yaskawa representative, or the nearest Yaskawa sales office listed on the back cover.
- Products which have been modified by the customer fall outside the scope of the Yaskawa warranty. Yaskawa assumes no responsibility for any damage or injury caused by a modified product.

## 1. Product Checks



- Do not install or operate an enclosure which is damaged or has parts missing from it. This may result in injury.

Next, we will describe the procedure for checking the product upon arrival.

### 1.1 Checks Upon Delivery

Check the following items upon product delivery:

- That the product is as ordered
- That all accessories and spare parts are in order

Check the product against the Bill of Lading attached to the enclosure, User's Manual, Specification Sheet, or Order Form.

- Any damage during transport

Visually inspect the outside of the entire unit for damage during transport, etc.

- Any missing wiring or unsecured screws

Check with a screwdriver if necessary.

If there is a problem with any of the above items, immediately contact the Yaskawa representative from whom you purchased the product, or nearest sales office. If there should be any damage to the unit, we will need backup documentation from those responsible for transporting the module.

### 1.2 Temporary Storage

Keep the following items in mind when storing the module for a length of time instead of immediately mounting it. Contact Yaskawa Engineering, Inc. if long-term storage is required.

#### 1.2.1 Storage Location

Store the enclosure in the following type of location:

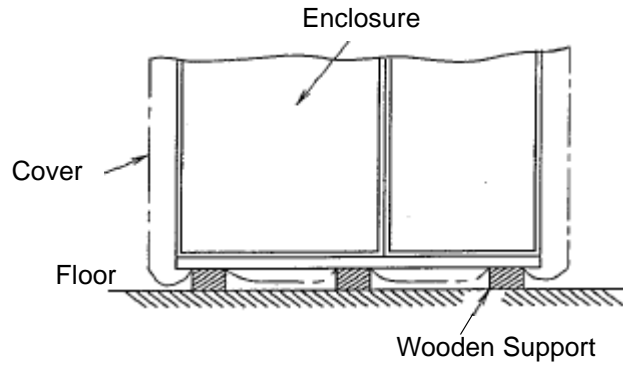
- The location should be indoors.
- The location should be level.
- The location should be free from high temperatures and humidity, and should be well-ventilated.
- The location should be free from vibration.
- The location should be free from particulates, corrosive gas, and salt.



### 1.2.2 Storage Method

Store the enclosure by the following method:

- Do not place the enclosure directly on the floor. Use wooden supports as shown in [Figure 1.1 Storage Method](#).
- Cover with polyethylene sheeting (from delivery).



***Figure 1.1 Storage Method***

## 2. Transport

### ⚠ CAUTION

- Use a qualified operator when transporting the unit by crane. Failure to do so may result in injury or dropping of unit.

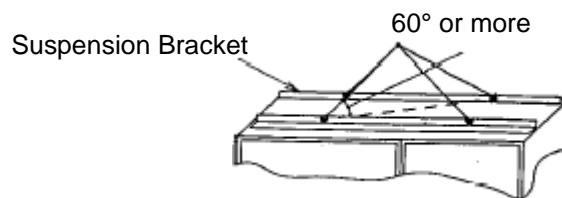
There are two methods for transporting the enclosure, by crane or by pushing on a loading cart. Check that all doors and delivered devices are secured prior to transporting.

### 2.1 Cautionary Items During Transport

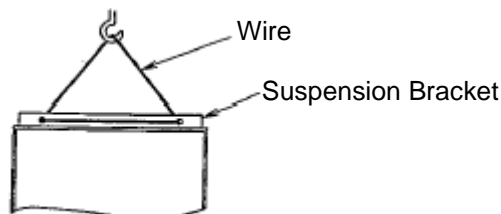
- Do not push or pull the enclosure on a floor (concrete, etc.) unless there is a steel sliding surface or grooved channel base.
- Do not tilt or rock the enclosure.
- Do not apply excessive vibration or shock to the enclosure during transport ( $4.9 \text{ m/s}^2$  (0.5G) or less).

### 2.2 Cautionary Items in Suspending the Unit from Cables

- When suspending the unit, use cables that with a strength to match the mass of the unit.
- Use cables with a length that will assure a suspension angle of  $60^\circ$  or greater as shown in [Figure 2.1 Proper Cable Suspension](#). The allowable suspension load of the suspension bracket cannot be assured if the suspension angle is smaller than this.
- Attach a cable to each of the suspension holes on the suspension bracket. Do not suspend the unit as shown in [Figure 2.2 Example of Improper Cable Suspension](#).
- Prevent shock during suspension. If lifting by a crane after attaching the wires, gradually take up slack until the cables are stretched, the lift after verifying that the cables are taut. Do not lift (or lower) suddenly. When lowering to the floor, stop just prior to contacting the floor, then gradually lower so as not to apply any shock to the enclosure.



**Figure 2.1 Proper Cable Suspension**



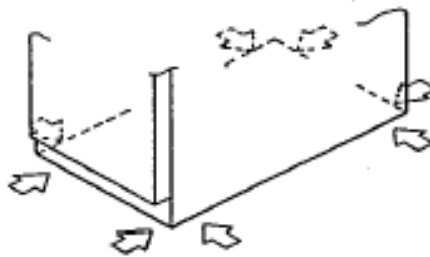
**Figure 2.2 Example of Improper Cable Suspension**

### 2.3 Pushing on A Gas-Assisted Loading Cart

When transporting using a gas-assisted loading cart, take care that the frame is not deformed or the outside of the enclosure damaged.

- Use a cart that extend about 100mm lengthwise past the left and right ends of the unit to be transported. The cart should be compatible with 30~50mm diameter gas bottle.
- Applying Force to the Loading Cart

Upon reaching the installation location, gently lift the unit using the bars, and remove the gas-assisted loading cart. The positioning of the bars should divide the box into four units as shown in [Figure 2.3 Pole Placement Positions](#). If going underneath doorways, be sure that the bars do not strike the bottom of the door frame.



*Figure 2.3 Pole Placement Positions*

### 3. Installation

Perform the installation of the enclosure in accordance with the following items.

#### 3.1 Preparation Prior to Installation (Selecting a Location)

Install the enclosure in the following sort of location:

1. The location should be 1000m or less above sea level.
2. The ambient temperature should be between -5~40°C.
  - The location should not trap hot air from the enclosure.
  - The room ventilation should be good. Poor ventilation can lead to a rise in ambient temperature due to heat sources such as the unit itself.
3. The location should be free from corrosive gases or ocean spray which promote rust and corrosion.
4. The location should be free from dripping of, or contact with, water.

Pay attention to the following when installing indoors.

- If the roof is a metal or glass type, there is a risk of water dripping from condensation.
  - Water may drip from leaks in pipes.
  - There is a risk of the enclosure contacting water if it is installed on concrete that has not been thoroughly dried (particularly in the basements of buildings). If this is the case, place a space heater within the enclosure and always keep the internal temperature higher than the outside air.
5. The location should be free of dust or grime.  
A dusty or dirty location runs the risk of degrading the contact of the contactors as well as damage to the insulation.
  6. The location should be free of vibration or shock.
  7. The location should be free of explosive or flammable gas.
  8. The location should have space for cleaning, inspection, and testing.  
Always maintain this space. (Minimum front and back spaces are also regulated in fire codes.)

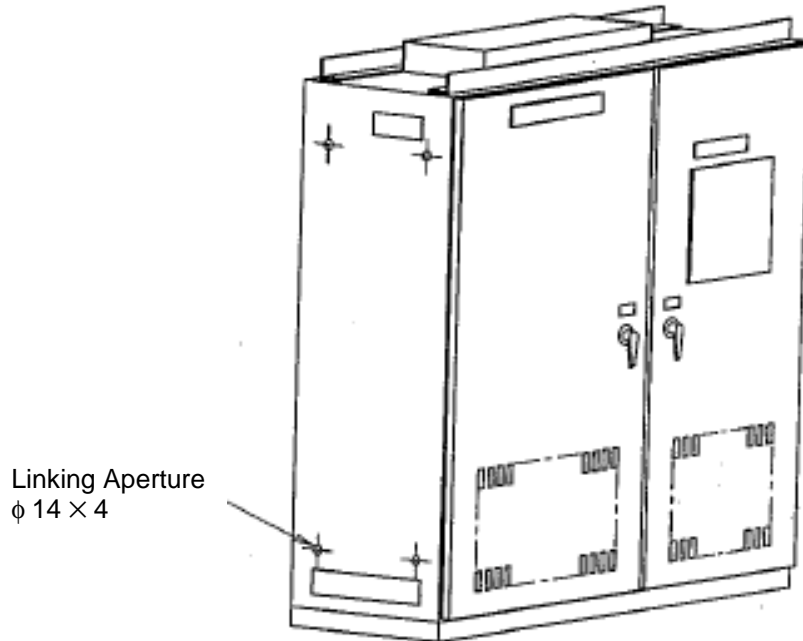
#### 3.2 Leveling

The floor surface of the enclosure installation location should be level to within  $\pm 3\text{mm}$  across  $1\text{m}^2$ .

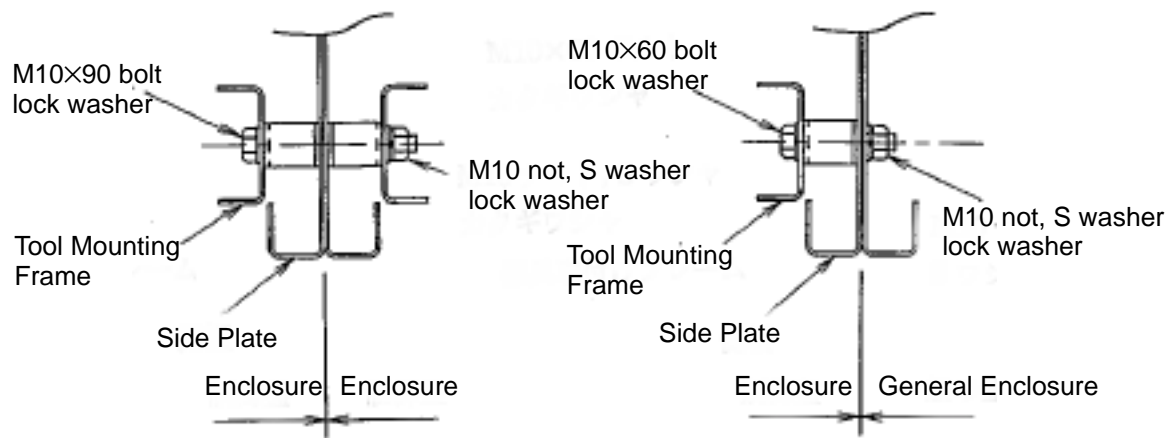
#### 3.3 Linking of Enclosures (Row Enclosures)

When using row enclosures, link the together using joining bolts. There are four fastening locations on each end of the enclosure. Always make sure that the front of each enclosure is straight, and the enclosure does not fall over ([Figure 3.1](#)).

The linking method differs between linking the same enclosures, and linking with other, general, enclosures ([Figure 3.2](#)).



**Figure 3.1 Row Linking of Enclosure**

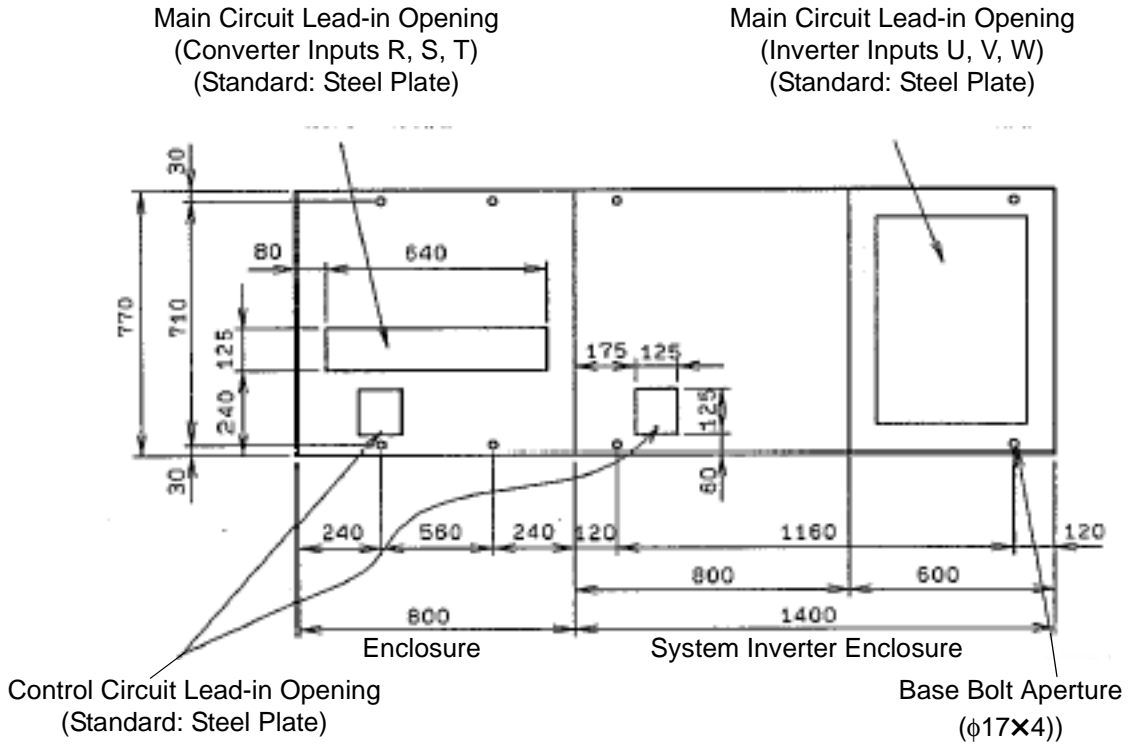


**(a) Linking Identical Enclosures      (b) Linking with General Enclosure**

**Figure 3.2 Enclosure Linkage**

### 3.4 Tightening of Base Bolts

Tighten the base bolts (4 locations) to the enclosure after finishing the work up to item 3.3. Perform the base work by referencing the enclosure drawings provided from Yaskawa. [Figure 3.3](#) shows an example of installing a system inverter enclosure (VS-676H5) to the right of this enclosure.



**Figure 3.3 Example with 400V/400kW Enclosure**

## 4. Wiring

**⚠ WARNING**

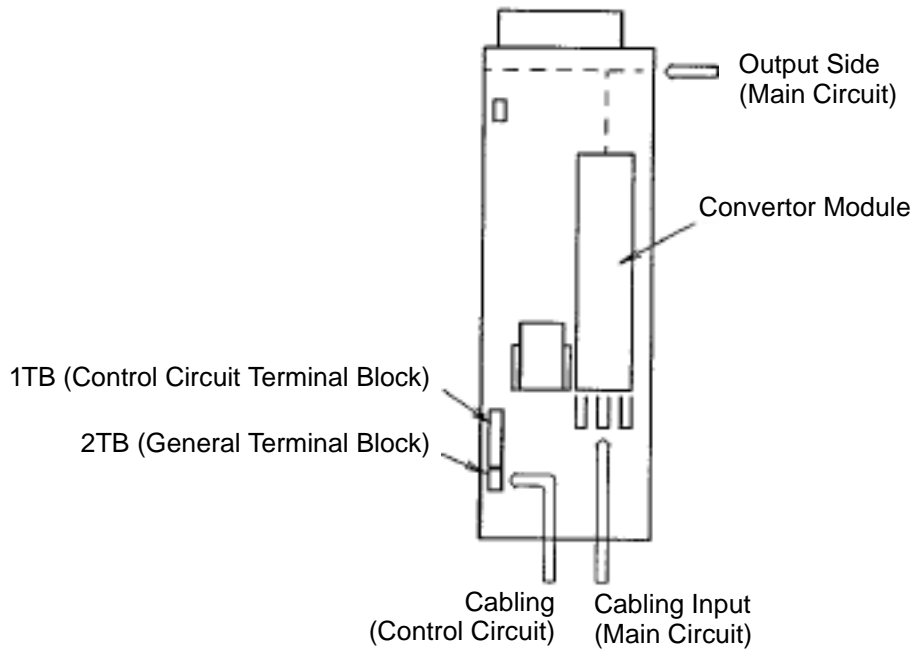
- Install this unit after verifying that the input power is OFF. Failure to do so may lead to electric shock or fire.
- Wiring should be performed by a skilled electrician. Failure to do so may lead to electric shock or fire.
- Be sure to ground the grounding terminal. Failure to do so may lead to electric shock or fire.

Connect the cabling to the enclosure while referencing the wiring connection diagram provided by Yaskawa. Enclosure inputs and outputs may be led-in by relaying the cables through the I/O terminal block.

### 4.1 Terminal Position

#### 4.1.1 DC Input Enclosure

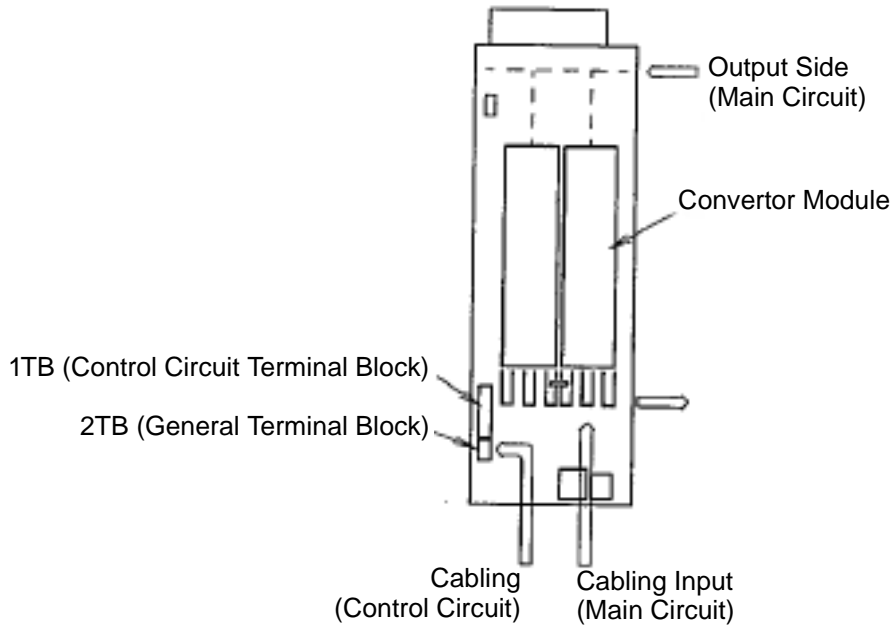
■ 400V-Class/200kW, 575V-Class/300kW



**Figure 4.1**

- **400V-Class/400kW, 600V-Class/800kW**  
**575V-Class/600kW, 900V-Class/1200kW**

Figure 4.2 is an example of a 400V-Class/400kW, or 575V-Class/600kW enclosure.



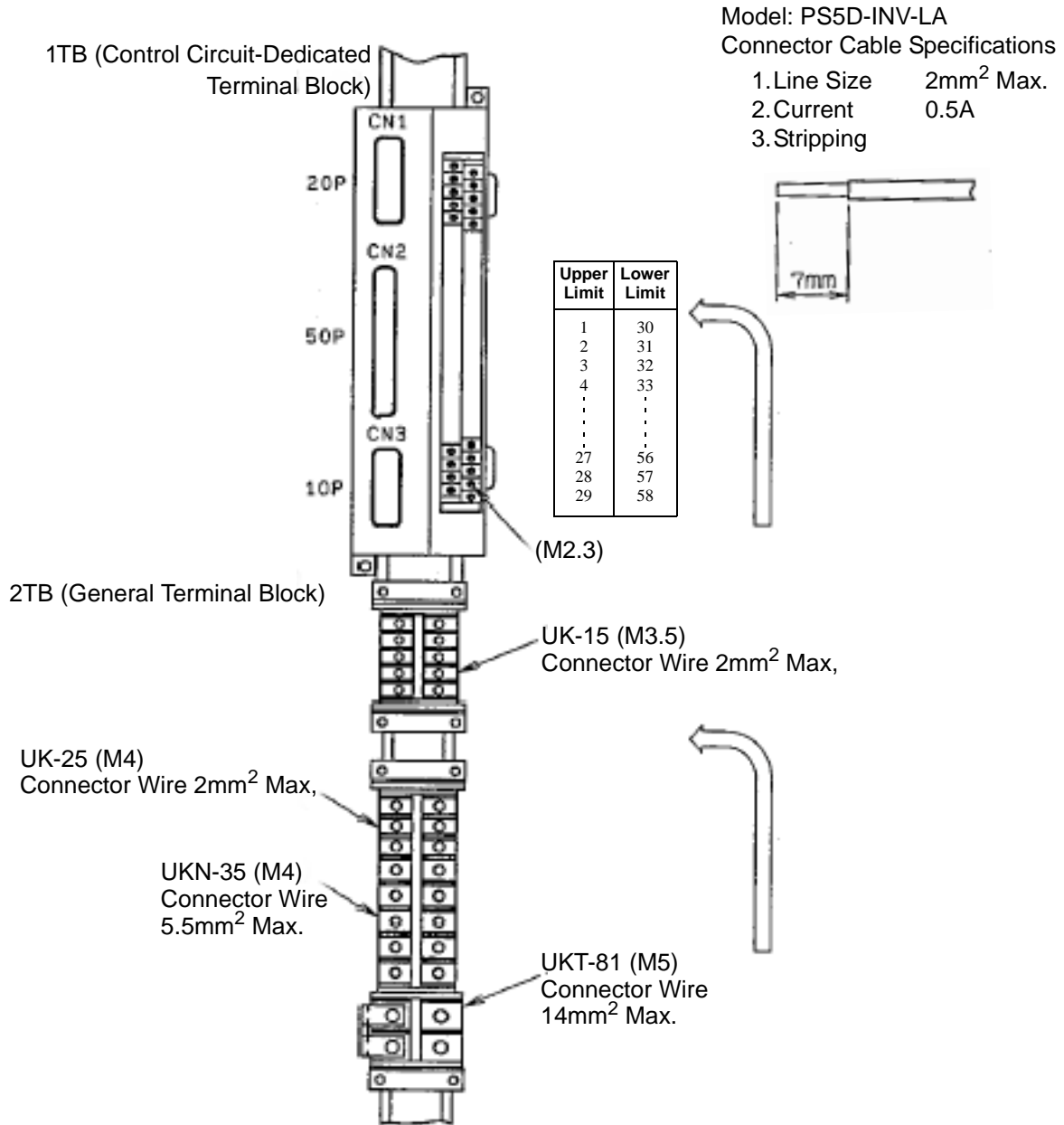
**Figure 4.2**

The main circuit terminals on both the input and output side are installed on the side as bus bar terminals. Connection is typically made on the I/O terminal block on the right or left side.



## 4.2 Control Circuit Wiring

### 4.2.1 The Control Circuit Terminal Block and The General Terminal Block



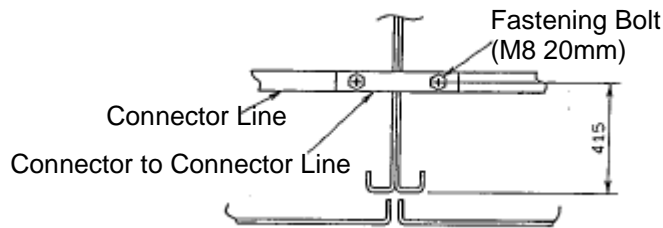
**Figure 4.3**

Maintain proper distance between the connector cables in accordance with the high- and low-voltages indicated in the wiring diagram. The size of the terminals in 2TB (general terminal block) is sometimes larger because these use a larger size connector cable. Verify this on the wiring diagram.

## 5. Grounding

### 5.1 Connecting the Grounding Bus

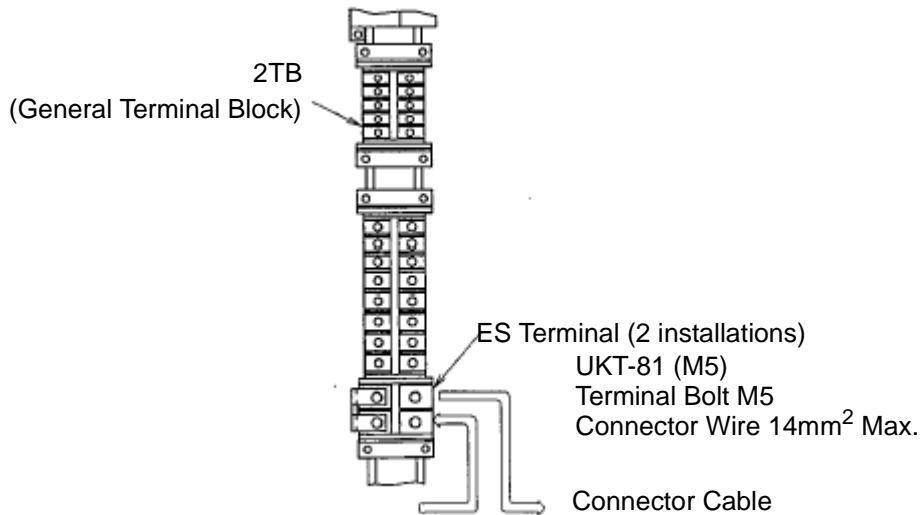
When the enclosure is mounted in series with an I/O terminal block or general enclosure, securely fasten the grounding bus relay (connector or cable) between the ground and the grounding bus as shown in [Figure 5.1](#). Always be sure to connect the grounding bus prior to power application in order to prevent fire, which may accompany a rise in the ground voltage due to leakage, etc.



**Figure 5.1 Ground Bus Connection Example for Series Connection**

### 5.2 Connection of Control Signal Ground

Treat the control signal ground as a dedicated type-3 grounding separate from the grounding bus.



**Figure 5.2**

## 6. Maintenance/Inspection

### **WARNING**

- Do not touch the terminals on the enclosure as they carry a high voltage. This may lead to electric shock.
- Perform maintenance and testing after removing the upper level power supply and verifying that the CHARGE lamp has gone out. There is danger in that a charge remains in the capacitor. This may lead to electric shock. In any case, use a voltmeter to measure for high voltage prior to performing maintenance.
- Only designated persons should perform maintenance, testing, and parts replacement. When performing maintenance, remove accessories (watches, bracelets, etc.) prior to working. Use insulated tools. Failure to do so may lead to electric shock.

### **CAUTION**

- The control unit uses an CMOS IC. Keep this in mind while handling the unit. Static electricity may damage the IC if it is touched directly with fingers.
- Do not change wiring or install/remove connectors while power is applied. This may result in injury.

Appropriate maintenance management is necessary in order to assure reliable operation in the long term. The customer should perform maintenance management in accordance with the maintenance items shown below.

### 6.1 Cleaning

Clear away all grime and dust from the outside before cleaning the inside of the enclosure. Use suction rather than blowing to clean the inside of the enclosure. Close the doors securely after cleaning is finished.

#### **(Dust Filter)**

The dust filter is attached at the bottom of the inside of the door. Wash the filter with water or a soap solution if it becomes clogged by dust, etc. The filter should generally be cleaned every 3~6 months. Replace the filter after 10 washings.

### 6.2 Maintenance Inspection

Perform inspection according to the schedule shown in [Table 6.1](#).

**Table 6.1: Maintenance Inspection Items**

Item	Name	Inspection Item	Inspection Period					Content	
			Daily	Monthly	Yearly	Power ON	Power OFF		
General	Bolts/Screws	Electrical Connection	–	Y	–	–	Y	Tighten with wrench or screwdriver	
	Cable	Insulation Damage	–	Y	–	–	Y	Replace	
	Protective Conduit	Electrical Connection	–	Y	–	–	Y	Replace	
	Bushing, Insulation Cover	Damage, minute Cracking	–	Y	–	–	Y	Repair or replace.	
Machine	Cutoff Switch	Smooth Open/Close Action	–	Y	–	–	Y	Replace	
		Molding Damage	–	Y	–	–	Y		
	Circuit Breaker	Smooth Open/Close Action	–	Y	–	–	Y		
		Molding Damage	–	Y	–	–	Y		
	Convertor Cooling Fan	Abnormal Noise/Vibration	–	Y	–	Y	–	Replace fan.	
		Excessive Cumulative Run Time (20k hours)	–	Y	–	Y	–		
		Exchange Fan (Roof Installed)	Abnormal Noise/Vibration	–	Y	–	Y		–
			Excessive Cumulative Run Time (20k hours)	–	Y	–	Y		–
Bus	Vertical Bus Horizontal Bus	Temperature Rise	–	Y	–	Y	–	Discover cause.	
		Insulation Cover Damage	–	Y	–	–	Y	Repair or replace.	
		Loose Bolts	–	–	Y	–	Y	Tighten	

## 6.3 Module Installation/Removal

### ⚠ WARNING

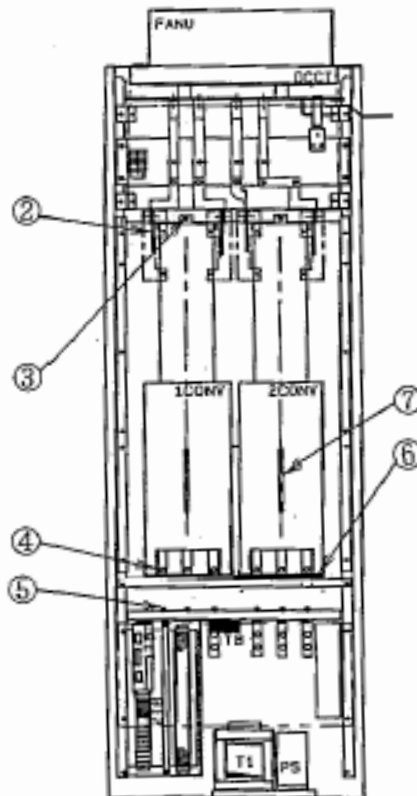
- Install/remove this module after verifying that the upper level power supply is OFF. Failure to do so may lead to electric shock.
- Use a dedicated lifter when mounting/dismounting the module. Failure to do so may result in injury.

The converter module is heavy. Three persons should perform the installation/removal work: one for the refitting work, and two for the installation/removal.

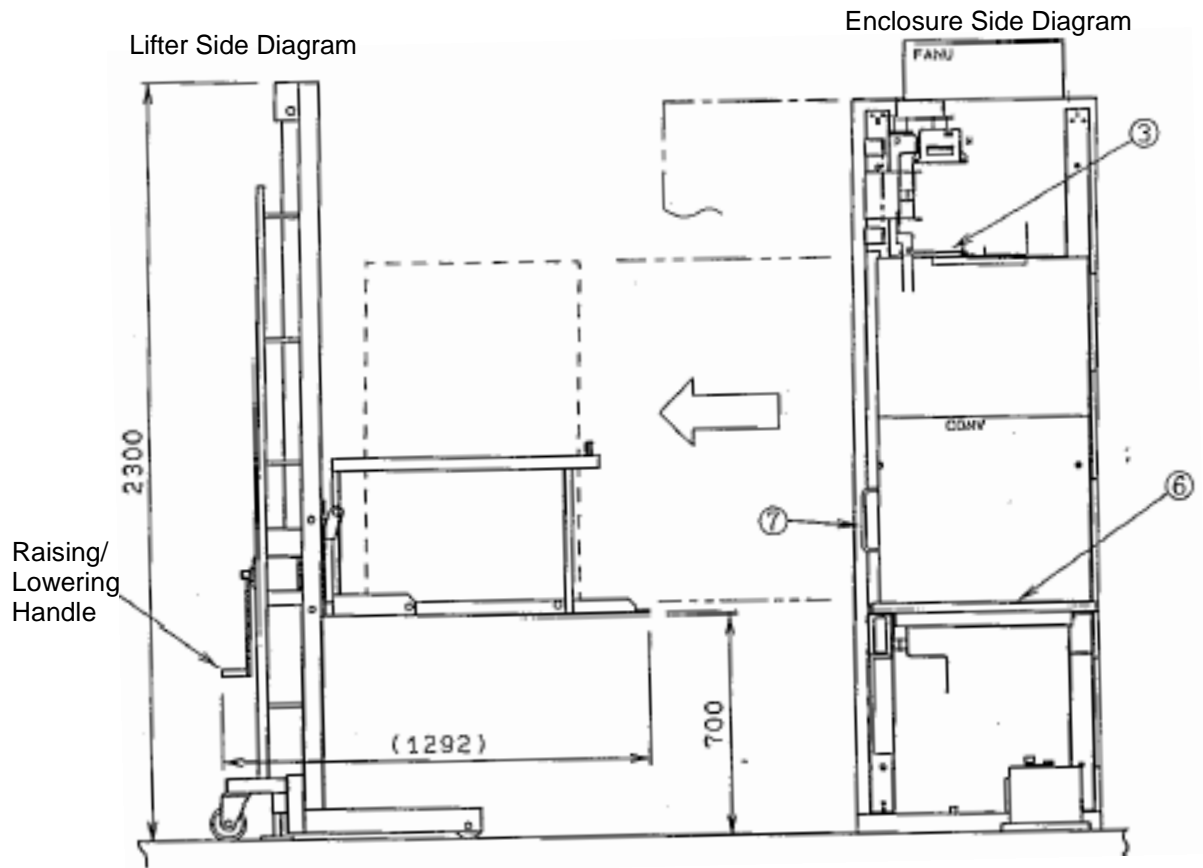
### 6.3.1 Module Removal

Remove the module by the following procedure.

1. Check that the upper-level power supply is OFF.
  2. Remove the (2) bus connection bolts between P and N on the module.
  3. Loosen the safety screw.
  4. Remove the (3) input terminal connection bolts (R, S, T).
  5. Remove the mounting bolts for the bus terminal support.
  6. Connect the dedicated lifter to the module mounting base.
  7. Pull the lever and lead out the lifter.
- (The module will come out easily as there are wheels installed on the lifter.)



*Figure 6.1*



**Figure 6.2**

Name	Capacity	Height* (mm)	Width (mm)	Depth (mm)	Mass (kg)
Convertor Module	400V 200kW	1100	265	670	120
	575V 300kW	1100	265	670	128

\*: Does not include cart dimensions.

### 6.3.2 Module Installation

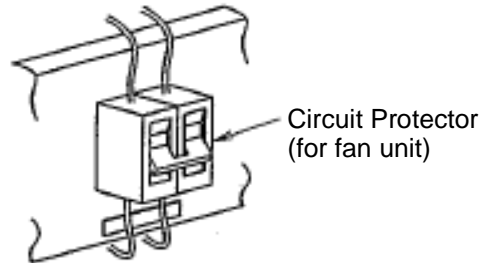
To install the module, perform the removal procedure in reverse.

## 6.4 Enclosure Exchange Fan Unit

A fan unit for releasing hot air within the enclosure is installed in the ceiling of the enclosure. Replace this fan periodically in accordance with section [6.2 Maintenance Inspection](#). An alarm will sound if the fan fails. If this happens, replace the fan immediately.

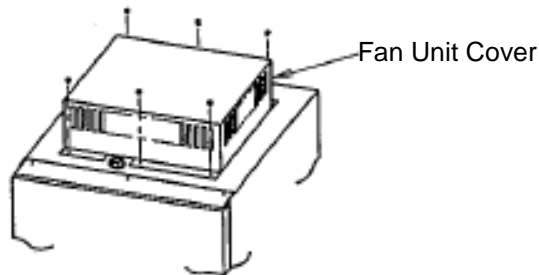
### ■ Replacement Method

1. Turn the circuit protector used by the fan unit at the top of the enclosure OFF.

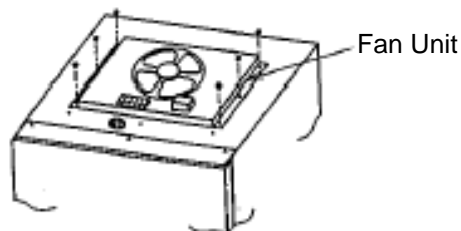


**Figure 6.3 Circuit Protector for Fan Unit**

2. Remove the mounting screws (M5×6) on the fan unit cover, then lift off the fan unit cover. (See)
3. Remove the wiring on the inside of the enclosure, then remove the fan unit. (See)
4. Install a new fan unit by reversing this removal procedure.



**Figure 6.4 Ceiling Mounted Enclosure Exchange Fan**

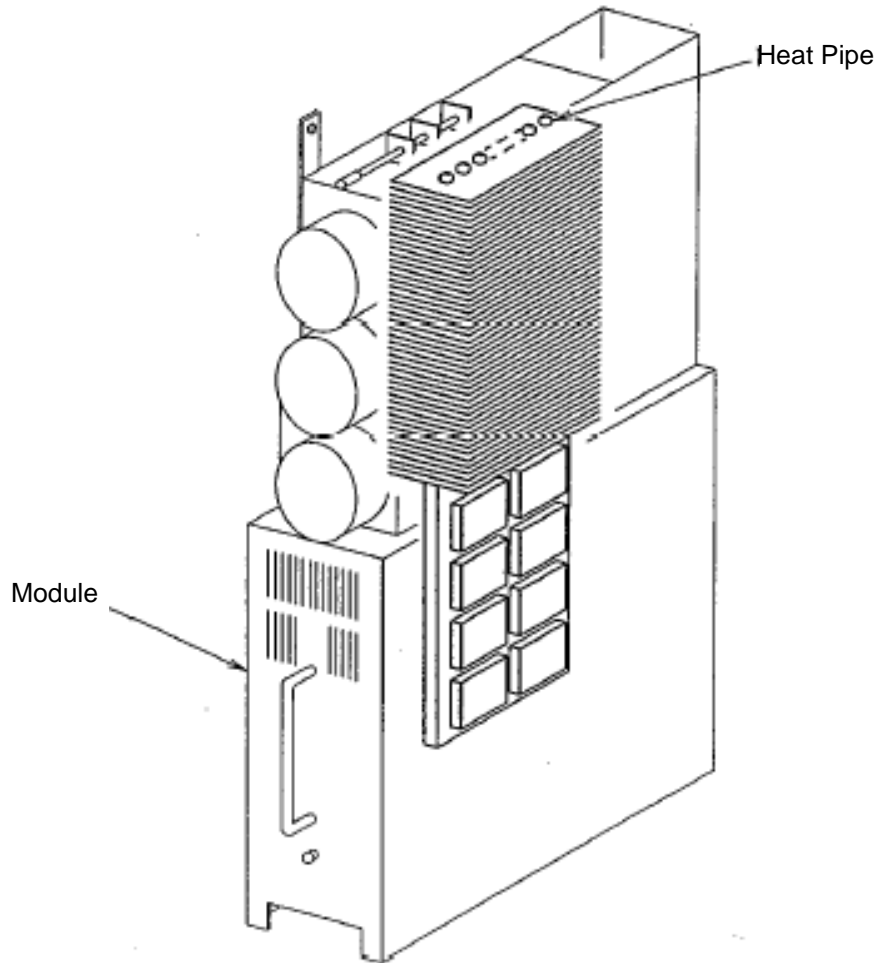


**Figure 6.5 Exchange Fan Unit Removal**

## 6.5 Module Disposal

**⚠ WARNING**

- Prior to disposing of the module, drill a hole in the heat pipe mounted within the module and flow air into the unit. Not opening the pipe and releasing the heat may cause the pipe to burst, resulting in injury.



**Figure 6.6**



## 7. Spare Parts

### 7.1 Enclosure

Voltage (V)	Capacity (kW)	Convertor Module CONV	Power Supply PS	Power Transformer T1	Controller Unit CONT	DC Convertor DCCT	Exchange Fan FANU	Fan Power Supply MCB
400	200	EUJ61505X (×1)	EUJ61501X (×1)	USN-B 1.4kVA (CPT020063) (×1)	EUA61502X (×1)	HC-L700V4B15 (CT003079) (×1)	THA1-350P04-2TP (FAN000205) (×1)	CP32D/10W AC250V 5A (MCB144502) (×1)
	400	EUJ61505X (×2)				HC-LE14V4B15 (CT003080) (×1)	THA1-400P04-2TP (FAN000207) (×1)	
	600	EUJ61505X (×3)				HC-LE21V4B15 (CT003081) (×1)	THA1-350P04-2TP (FAN000205) (×2)	
	800	EUJ61505X (×4)				HC-LE28V4B15 (CT003082) (×1)	THA1-400P04-2TP (FAN000207) (×2)	
600	300	EUJ61506X (×1)	EUJ61501X (×1)	USN-B 1.4kVA (CPT020063) (×1)	EUA61504X (×1)	HC-L700V4B15 (CT003079) (×1)	THA1-350P04-2TP (FAN000205) (×1)	CP32D/10W AC250V 5A (MCB144502) (×1)
	600	EUJ61506X (×2)				HC-LE14V4B15 (CT003080) (×1)	THA1-400P04-2TP (FAN000207) (×1)	
	900	EUJ61506X (×3)				HC-LE21V4B15 (CT003081) (×1)	THA1-350P04-2TP (FAN000205) (×2)	
	1200	EUJ61506X (×4)				HC-LE28V4B15 (CT003082) (×1)	THA1-400P04-2TP (FAN000207) (×2)	

(×1)~(×4) refers to the number of spare parts per set.



**YASKAWA ELECTRIC AMERICA, INC.**

**Chicago-Corporate Headquarters** 2121 Norman Drive South, Waukegan, IL 60085, U.S.A.  
Phone: (847) 887-7000 Fax: (847) 887-7310 Internet: <http://www.yaskawa.com>

**MOTOMAN INC.**

805 Liberty Lane, West Carrollton, OH 45449, U.S.A.  
Phone: (937) 847-6200 Fax: (937) 847-6277

**YASKAWA ELECTRIC CORPORATION**

New Pier Takeshiba South Tower, 1-16-1, Kaigan, Minatoku, Tokyo, 105-0022, Japan  
Phone: 81-3-5402-4511 Fax: 81-3-5402-4580 Internet: <http://www.yaskawa.co.jp>

**YASKAWA ELETRICO DO BRASIL COMERCIO LTDA.**

Avenida Fagundes Filho, 620 Bairro Saude Sao Paulo-SP, Brasil CEP: 04304-000  
Phone: 55-11-5071-2552 Fax: 55-11-5581-8795 E-mail: [yaskawabrasil@originet.com.br](mailto:yaskawabrasil@originet.com.br)

**YASKAWA ELECTRIC EUROPE GmbH**

Am Kronberger Hang 2, 65824 Schwalbach, Germany  
Phone: 49-6196-569-300 Fax: 49-6196-888-301

**MOTOMAN ROBOTICS AB**

Box 504 S38525, Torsas, Sweden  
Phone: 46-486-48800 Fax: 46-486-41410

**MOTOMAN ROBOTEC GmbH**

Kammerfeldstraße 1, 85391 Allershausen, Germany  
Phone: 49-8166-900 Fax: 49-8166-9039

**YASKAWA ELECTRIC UK LTD.**

1 Hunt Hill Orchardton Woods Cumbernauld, G68 9LF, Scotland, United Kingdom  
Phone: 44-12-3673-5000 Fax: 44-12-3645-8182

**YASKAWA ELECTRIC KOREA CORPORATION**

Paik Nam Bldg. 901 188-3, 1-Ga Euljiro, Joong-Gu, Seoul, Korea  
Phone: 82-2-776-7844 Fax: 82-2-753-2639

**YASKAWA ELECTRIC (SINGAPORE) PTE. LTD.**

**Head Office:** 151 Lorong Chuan, #04-01, New Tech Park Singapore 556741, SINGAPORE  
Phone: 65-282-3003 Fax: 65-289-3003

**TAIPEI OFFICE (AND YATEC ENGINEERING CORPORATION)**

10F 146 Sung Chiang Road, Taipei, Taiwan  
Phone: 886-2-2563-0010 Fax: 886-2-2567-4677

**YASKAWA JASON (HK) COMPANY LIMITED**

Rm. 2909-10, Hong Kong Plaza, 186-191 Connaught Road West, Hong Kong  
Phone: 852-2803-2385 Fax: 852-2547-5773

**BEIJING OFFICE**

Room No. 301 Office Building of Beijing International Club,  
21 Jianguomanwai Avenue, Beijing 100020, China  
Phone: 86-10-6532-1850 Fax: 86-10-6532-1851

**SHANGHAI OFFICE**

27 Hui He Road Shanghai 200437 China  
Phone: 86-21-6553-6600 Fax: 86-21-6531-4242

**SHANGHAI YASKAWA-TONJIM & E CO., LTD.**

27 Hui He Road Shanghai 200437 China  
Phone: 86-21-6533-2828 Fax: 86-21-6553-6677

**BEIJING YASKAWA BEIKE AUTOMATION ENGINEERING CO., LTD.**

30 Xue Yuan Road, Haidian, Beijing 100083 China  
Phone: 86-10-6232-9943 Fax: 86-10-6234-5002

**SHOUGANG MOTOMAN ROBOT CO., LTD.**

7, Yongchang-North Street, Beijing Economic & Technological Development Area,  
Beijing 100076 China

Phone: 86-10-6788-0551 Fax: 86-10-6788-2878