

Σ-7シリーズ ACサーボドライブ Σ-7S/Σ-7W サーボパック 400 V 入力仕様 安全上のご注意

形式：SGD7S-□□□□□□□□□□□□□□□□
SGD7W-□□□□□□□□□□□□□□□□

製品を安全にお使いいただくために、本書を必ずお読みください。
また、本書をお手元に保管していただくとともに、最終的に本製品をご使用になるユーザー様のお手元に確実に届けられるよう、お取り計らい願います。

Σ-7-Series AC Servo Drive Σ-7S and Σ-7W SERVOPACK with 400 V-Input Power Safety Precautions

Model: SGD7S-□□□□□□□□□□□□□□□□
SGD7W-□□□□□□□□□□□□□□□□

To properly use the product, read this manual thoroughly and retain for easy reference, inspection, and maintenance. Ensure the end user receives this manual.

Entraînement de servomécanisme CA modèles Σ-7 SERVOPACK Σ-7S et Σ-7W avec alimentation d'entrée 400 V Précautions de sécurité

Modèle: SGD7S-□□□□□□□□□□□□□□□□
SGD7W-□□□□□□□□□□□□□□□□

Pour utiliser correctement le produit, lisez attentivement ce manuel. Conservez-le comme références et pour les cas d'inspections et de maintenance. Assurez-vous que l'utilisateur final reçoit ce manuel.

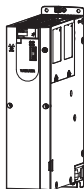

Copyright © 2015 YASKAWA ELECTRIC CORPORATION

All rights reserved. No part of this publication may be reproduced, stored in a retrieval system, or transmitted, in any form, or by any means, mechanical, electronic, photocopying, recording, or otherwise, without the prior written permission of Yaskawa. No patent liability is assumed with respect to the use of the information contained herein. Moreover, because Yaskawa is constantly striving to improve its high-quality products, the information contained in this manual is subject to change without notice. Every precaution has been taken in the preparation of this manual. Nevertheless, Yaskawa assumes no responsibility for errors or omissions. Neither is any liability assumed for damages resulting from the use of the information contained in this publication.

Safety Precautions

◆ Safety Information

To prevent personal injury and equipment damage in advance, the following signal words are used to indicate safety precautions in this document. The signal words are used to classify the hazards and the degree of damage or injury that may occur if a product is used incorrectly. Information marked as shown below is important for safety. Always read this information and heed the precautions that are provided.



DANGER

- Indicates precautions that, if not heeded, are likely to result in loss of life, serious injury, or fire.



WARNING

- Indicates precautions that, if not heeded, could result in loss of life, serious injury, or fire.



CAUTION

- Indicates precautions that, if not heeded, could result in relatively serious or minor injury, or in fire.

NOTICE

- Indicates precautions that, if not heeded, could result in property damage.

◆ Safety Precautions That Must Always Be Observed

■ General Precautions



DANGER

- Read and understand this manual to ensure the safe usage of the product.
- Keep this manual in a safe, convenient place so that it can be referred to whenever necessary. Make sure that it is delivered to the final user of the product.
- Do not remove covers, cables, connectors, or optional devices while power is being supplied to the SERVOPACK.
There is a risk of electric shock, operational failure of the product, or burning.



WARNING

- Use a power supply with specifications (number of phases, voltage, frequency, and AC/DC type) that are appropriate for the product.
There is a risk of burning, electric shock, or fire.
- Connect the ground terminals on the SERVOPACK and Servomotor to ground poles according to local electrical codes (10 Ω or less for a SERVOPACK with a 400-VAC power supply).
There is a risk of electric shock or fire.
- Do not attempt to disassemble, repair, or modify the product.
There is a risk of fire or failure.
The warranty is void for the product if you disassemble, repair, or modify it.



CAUTION

- The SERVOPACK heat sinks, regenerative resistors, External Dynamic Brake Resistors, Servomotors, and other components can be very hot while power is ON or soon after the power is turned OFF. Implement safety measures, such as installing covers, so that hands and parts such as cables do not come into contact with hot components.
There is a risk of burn injury.
- For a 24-VDC power supply, use a power supply device with double insulation or reinforced insulation.
There is a risk of electric shock.
- Do not damage, pull on, apply excessive force to, place heavy objects on, or pinch cables.
There is a risk of failure, damage, or electric shock.
- The person who designs the system that uses the hard wire base block safety function must have a complete knowledge of the related safety standards and a complete understanding of the instructions in this document.
There is a risk of injury, product damage, or machine damage.
- Do not use the product in an environment that is subject to water, corrosive gases, or flammable gases, or near flammable materials.
There is a risk of electric shock or fire.

NOTICE

- Do not attempt to use a SERVOPACK or Servomotor that is damaged or that has missing parts.
- Install external emergency stop circuits that shut OFF the power supply and stops operation immediately when an error occurs.
- In locations with poor power supply conditions, install the necessary protective devices (such as AC reactors) to ensure that the input power is supplied within the specified voltage range.
There is a risk of damage to the SERVOPACK.
- Use a Noise Filter to minimize the effects of electromagnetic interference.
Electronic devices used near the SERVOPACK may be affected by electromagnetic interference.
- Always use a Servomotor and SERVOPACK in one of the specified combinations.
- Do not touch a SERVOPACK or Servomotor with wet hands.
There is a risk of product failure.

■ Storage Precautions



CAUTION

- Do not place an excessive load on the product during storage. (Follow all instructions on the packages.)
There is a risk of injury or damage.

NOTICE

- Do not install or store the product in any of the following locations.
 - Locations that are subject to direct sunlight
 - Locations that are subject to ambient temperatures that exceed product specifications
 - Locations that are subject to relative humidities that exceed product specifications
 - Locations that are subject to condensation as the result of extreme changes in temperature
 - Locations that are subject to corrosive or flammable gases
 - Locations that are near flammable materials
 - Locations that are subject to dust, salts, or iron powder
 - Locations that are subject to water, oil, or chemicals
 - Locations that are subject to vibration or shock that exceeds product specifications
 - Locations that are subject to radiation
- If you store or install the product in any of the above locations, the product may fail or be damaged.

■ Transportation Precautions



CAUTION

- Transport the product in a way that is suitable to the mass of the product.
- Do not use the eyebolts on a SERVOPACK or Servomotor to move the machine.
There is a risk of damage or injury.
- When you handle a SERVOPACK or Servomotor, be careful of sharp parts, such as the corners.
There is a risk of injury.
- Do not place an excessive load on the product during transportation. (Follow all instructions on the packages.)
There is a risk of injury or damage.

NOTICE

- Do not hold onto the front cover or connectors when you move a SERVOPACK.
There is a risk of the SERVOPACK falling.
- A SERVOPACK or Servomotor is a precision device. Do not drop it or subject it to strong shock.
There is a risk of failure or damage.
- Do not subject connectors to shock.
There is a risk of faulty connections or damage.
- If disinfectants or insecticides must be used to treat packing materials such as wooden frames, plywood, or pallets, the packing materials must be treated before the product is packaged, and methods other than fumigation must be used.
Example: Heat treatment, where materials are kiln-dried to a core temperature of 56°C for 30 minutes or more.
If the electronic products, which include stand-alone products and products installed in machines, are packed with fumigated wooden materials, the electrical components may be greatly damaged by the gases or fumes resulting from the fumigation process. In particular, disinfectants containing halogen, which includes chlorine, fluorine, bromine, or iodine can contribute to the erosion of the capacitors.
- Do not overtighten the eyebolts on a SERVOPACK or Servomotor.
If you use a tool to overtighten the eyebolts, the tapped holes may be damaged.

■ Installation Precautions



CAUTION

- Install the Servomotor or SERVOPACK in a way that will support the mass given in technical documents.
- Install SERVOPACKs, Servomotors, regenerative resistors, and External Dynamic Brake Resistors on nonflammable materials.
Installation directly onto or near flammable materials may result in fire.
- Provide the specified clearances between the SERVOPACK and the control panel as well as with other devices.
There is a risk of fire or failure.
- Install the SERVOPACK in the specified orientation.
There is a risk of fire or failure.
- Do not step on or place a heavy object on the product.
There is a risk of failure, damage, or injury.
- Do not allow any foreign matter to enter the SERVOPACK or Servomotor.
There is a risk of failure or fire.

NOTICE

- Do not install or store the product in any of the following locations.
 - Locations that are subject to direct sunlight
 - Locations that are subject to ambient temperatures that exceed product specifications
 - Locations that are subject to relative humidities that exceed product specifications
 - Locations that are subject to condensation as the result of extreme changes in temperature
 - Locations that are subject to corrosive or flammable gases
 - Locations that are near flammable materials
 - Locations that are subject to dust, salts, or iron powder
 - Locations that are subject to water, oil, or chemicals
 - Locations that are subject to vibration or shock that exceeds product specifications
 - Locations that are subject to radiationIf you store or install the product in any of the above locations, the product may fail or be damaged.

- Use the product in an environment that is appropriate for the product specifications.

If you use the product in an environment that exceeds product specifications, the product may fail or be damaged.
- A SERVOPACK or Servomotor is a precision device. Do not drop it or subject it to strong shock.

There is a risk of failure or damage.
- Always install a SERVOPACK in a control panel.
- Do not allow any foreign matter to enter a SERVOPACK or a Servomotor with a Cooling Fan and do not cover the outlet from the Servomotor's cooling fan.

There is a risk of failure.

■ Wiring Precautions



DANGER

- Do not change any wiring while power is being supplied.

There is a risk of electric shock or injury.



WARNING

- **Wiring and inspections must be performed only by qualified engineers.**
There is a risk of electric shock or product failure.
- **Check all wiring and power supplies carefully.**
Incorrect wiring or incorrect voltage application to the output circuits may cause short-circuit failures. If a short-circuit failure occurs as a result of any of these causes, the holding brake will not work. This could damage the machine or cause an accident that may result in death or injury.
- **Connect the AC and DC power supplies to the specified SERVOPACK terminals.**
 - Connect an AC power supply to the L1, L2, and L3 terminals on the SERVOPACK.
 - Connect a DC power supply to the B1 and \ominus 2 terminals and the 24 V and 0 V terminals on the SERVOPACK.
There is a risk of failure or fire.
- **If you use an External Dynamic Brake Resistor, connect one that is suitable for the machine or equipment specifications to the specified terminals.**
There is a risk of unexpected operation, machine damage, burning, or injury when an emergency stop is performed.



CAUTION

- **Wait for six minutes after turning OFF the power supply and then make sure that the CHARGE indicator is not lit before starting wiring or inspection work. Do not touch the power supply terminals while the CHARGE lamp is lit after turning OFF the power supply because high voltage may still remain in the SERVOPACK.**
There is a risk of electric shock.
- **Observe the precautions and instructions for wiring and trial operation precisely as described in this document.**
Failures caused by incorrect wiring or incorrect voltage application in the brake circuit may cause the SERVOPACK to fail, damage the equipment, or cause an accident resulting in death or injury.
- **Check the wiring to be sure it has been performed correctly.**
Connectors and pin layouts are sometimes different for different models. Always confirm the pin layouts in technical documents for your model before operation.
There is a risk of failure or malfunction.
- **Connect wires to power supply terminals and motor connection terminals securely with the specified methods and tightening torque.**
Insufficient tightening may cause wires and terminal blocks to generate heat due to faulty contact, possibly resulting in fire.
- **Use shielded twisted-pair cables or screened unshielded multi-twisted-pair cables for I/O Signal Cables and Encoder Cables.**

Continued on next page.



CAUTION

- The maximum wiring length is 10 m for Control Power Supply Cables (+24 V, 0 V), 3 m for I/O Signal Cables, and 50 m for Encoder Cables or Servomotor Main Circuit Cables.
- Observe the following precautions when wiring the SERVOPACK's main circuit terminals.
 - Turn ON the power supply to the SERVOPACK only after all wiring, including the main circuit terminals, has been completed.
 - If a connector is used for the main circuit terminals, remove the main circuit connector from the SERVOPACK before you wire it.
 - Insert only one wire per insertion hole in the main circuit terminals.
 - When you insert a wire, make sure that the conductor wire (e.g., whiskers) does not come into contact with adjacent wires.
- Install molded-case circuit breakers and other safety measures to provide protection against short circuits in external wiring.
There is a risk of fire or failure.
- Always turn the control power supply ON and OFF from the input (AC) side.
There is a risk of failure if you turn it ON and OFF from the output (DC) side.

NOTICE

- Whenever possible, use the Cables specified by Yaskawa.
If you use any other cables, confirm the rated current and application environment of your model and use the wiring materials specified by Yaskawa or equivalent materials.
- Securely tighten cable connector screws and lock mechanisms.
Insufficient tightening may result in cable connectors falling off during operation.
- Do not bundle power lines (e.g., the Main Circuit Cable) and low-current lines (e.g., the I/O Signal Cables or Encoder Cables) together or run them through the same duct. If you do not place power lines and low-current lines in separate ducts, separate them by at least 30 cm. If the cables are too close to each other, malfunctions may occur due to noise affecting the low-current lines.
- Install a battery at either the host controller or on the Encoder Cable.
If you install batteries both at the host controller and on the Encoder Cable at the same time, you will create a loop circuit between the batteries, resulting in a risk of damage or burning.
- When connecting a battery, connect the polarity correctly.
There is a risk of battery rupture or encoder failure.

■ Operation Precautions



WARNING

- Before starting operation with a machine connected, change the settings of the switches and parameters to match the machine.
Unexpected machine operation, failure, or personal injury may occur if operation is started before appropriate settings are made.
- Do not radically change the settings of the parameters.
There is a risk of unstable operation, machine damage, or injury.
- Install limit switches or stoppers at the ends of the moving parts of the machine to prevent unexpected accidents.
There is a risk of machine damage or injury.
- For trial operation, securely mount the Servomotor and disconnect it from the machine.
There is a risk of injury.
- Forcing the motor to stop for overtravel is disabled when the Jog (Fn002), Origin Search (Fn003), or Easy FFT (Fn206) utility function is executed. Take necessary precautions.
There is a risk of machine damage or injury.
- When an alarm occurs, the Servomotor will coast to a stop or stop with the dynamic brake according to the wiring and settings of the SERVO-PACK. The coasting distance will change with the moment of inertia of the load and the resistance of the External Dynamic Brake Resistor. Check the coasting distance during trial operation and implement suitable safety measures on the machine.
- Do not enter the machine's range of motion during operation.
There is a risk of injury.
- Do not touch the moving parts of the Servomotor or machine during operation.
There is a risk of injury.



CAUTION

- Design the system to ensure safety even when problems, such as broken signal lines, occur.
For example, the P-OT and N-OT signals are set in the default settings to operate on the safe side if a signal line breaks. Do not change the polarity of this type of signal.
- When overtravel occurs, the power supply to the motor is turned OFF and the brake is released. If you use the Servomotor to drive a vertical load, set the Servomotor to enter a zero-clamped state after the Servomotor stops. Also, install safety devices (such as an external brake or counterweight) to prevent the moving parts of the machine from falling.
- Always turn OFF the servo before you turn OFF the power supply. If you turn OFF the main circuit power supply or control power supply during operation before you turn OFF the servo, the Servomotor will stop as follows:
 - If you turn OFF the main circuit power supply during operation without turning OFF the servo, the Servomotor will stop abruptly with the dynamic brake or it will coast to a stop. For details, refer to the manual for the SERVOPACK.
 - If you turn OFF the control power supply without turning OFF the servo, the stopping method that is used by the Servomotor depends on the model of the SERVOPACK. For details, refer to the manual for the SERVOPACK.
 - If you use an External Dynamic Brake Resistor, the Servomotor stopping method will be different from when the built-in dynamic brake resistor is used. For details, refer to the product manual for your SERVOPACK.
- Do not use the dynamic brake for any application other than an emergency stop.

There is a risk of failure due to rapid deterioration of elements in the SERVOPACK and the risk of unexpected operation, machine damage, burning, or injury.

NOTICE

- When you adjust the gain during system commissioning, use a measuring instrument to monitor the torque waveform and speed waveform and confirm that there is no vibration.
If a high gain causes vibration, the Servomotor will be damaged quickly.
- Do not frequently turn the power supply ON and OFF. After you have started actual operation, allow at least one hour between turning the power supply ON and OFF (as a guideline).
Do not use the product in applications that require the power supply to be turned ON and OFF frequently.
The elements in the SERVOPACK will deteriorate quickly.

Continued on next page.

NOTICE

- An alarm or warning may occur if communications are performed with the host controller while the SigmaWin+ or Digital Operator is operating.
If an alarm or warning occurs, it may interrupt the current process and stop the system.
- After you complete trial operation of the machine and facilities, use the SigmaWin+ to back up the settings of the SERVOPACK parameters. You can use them to reset the parameters after SERVOPACK replacement.
If you do not copy backed up parameter settings, normal operation may not be possible after a faulty SERVOPACK is replaced, possibly resulting in machine or equipment damage.

■ Maintenance and Inspection Precautions



DANGER

- Do not change any wiring while power is being supplied.
There is a risk of electric shock or injury.



WARNING

- Wiring and inspections must be performed only by qualified engineers.
There is a risk of electric shock or product failure.



CAUTION

- Wait for six minutes after turning OFF the power supply and then make sure that the CHARGE indicator is not lit before starting wiring or inspection work. Do not touch the power supply terminals while the CHARGE lamp is lit after turning OFF the power supply because high voltage may still remain in the SERVOPACK.
There is a risk of electric shock.
- Before you replace a SERVOPACK, back up the settings of the SERVOPACK parameters. Copy the backed up parameter settings to the new SERVOPACK and confirm that they were copied correctly.
If you do not copy backed up parameter settings or if the copy operation is not completed normally, normal operation may not be possible, possibly resulting in machine or equipment damage.

NOTICE

- Discharge all static electricity from your body before you operate any of the buttons or switches inside the front cover of the SERVOPACK.
There is a risk of equipment damage.

■ Troubleshooting Precautions

DANGER

- If the safety device (molded-case circuit breaker or fuse) installed in the power supply line operates, remove the cause before you supply power to the SERVOPACK again. If necessary, repair or replace the SERVOPACK, check the wiring, and remove the factor that caused the safety device to operate.

There is a risk of fire, electric shock, or injury.

WARNING

- The product may suddenly start to operate when the power supply is recovered after a momentary power interruption. Design the machine to ensure human safety when operation restarts.

There is a risk of injury.

CAUTION

- When an alarm occurs, remove the cause of the alarm and ensure safety. Then reset the alarm or turn the power supply OFF and ON again to restart operation.
There is a risk of injury or machine damage.
- If the Servo ON signal is input to the SERVOPACK and an alarm is reset, the Servomotor may suddenly restart operation. Confirm that the servo is OFF and ensure safety before you reset an alarm.
There is a risk of injury or machine damage.

- Always insert a magnetic contactor in the line between the main circuit power supply and the main circuit power supply terminals on the SERVOPACK so that the power supply can be shut OFF at the main circuit power supply.

If a magnetic contactor is not connected when the SERVOPACK fails, a large current may flow, possibly resulting in fire.

- If an alarm occurs, shut OFF the main circuit power supply.
There is a risk of fire due to a regenerative resistor overheating as the result of regenerative transistor failure.
- Install a ground fault detector against overloads and short-circuiting or install a molded-case circuit breaker combined with a ground fault detector.

There is a risk of SERVOPACK failure or fire if a ground fault occurs.

- The holding brake on a Servomotor will not ensure safety if there is the possibility that an external force (including gravity) may move the current position and create a hazardous situation when power is interrupted or an error occurs. If an external force may cause movement, install an external braking mechanism that ensures safety.

■ Disposal Precautions

- Correctly discard the product as stipulated by regional, local, and municipal laws and regulations. Be sure to include these contents in all labelling and warning notifications on the final product as necessary.



■ General Precautions

- Figures provided in this document are typical examples or conceptual representations. There may be differences between them and actual wiring, circuits, and products.
- The products shown in illustrations in this document are sometimes shown without covers or protective guards. Always replace all covers and protective guards before you use the product.
- If you need a new copy of this document because it has been lost or damaged, contact your nearest Yaskawa representative or one of the offices listed on the back of this document.
- This document is subject to change without notice for product improvements, specifications changes, and improvements to the manual itself.
We will update the document number of the document and issue revisions when changes are made.
- Any and all quality guarantees provided by Yaskawa are null and void if the customer modifies the product in any way. Yaskawa disavows any responsibility for damages or losses that are caused by modified products.

Warranty

◆ Details of Warranty

■ Warranty Period

The warranty period for a product that was purchased (hereinafter called the “delivered product”) is one year from the time of delivery to the location specified by the customer or 18 months from the time of shipment from the Yaskawa factory, whichever is sooner.

■ Warranty Scope

Yaskawa shall replace or repair a defective product free of charge if a defect attributable to Yaskawa occurs during the above warranty period.

This warranty does not cover defects caused by the delivered product reaching the end of its service life and replacement of parts that require replacement or that have a limited service life.

This warranty does not cover failures that result from any of the following causes.

- Improper handling, abuse, or use in unsuitable conditions or in environments not described in product catalogs or manuals, or in any separately agreed-upon specifications
- Causes not attributable to the delivered product itself
- Modifications or repairs not performed by Yaskawa
- Use of the delivered product in a manner in which it was not originally intended
- Causes that were not foreseeable with the scientific and technological understanding at the time of shipment from Yaskawa
- Events for which Yaskawa is not responsible, such as natural or human-made disasters

◆ Limitations of Liability

- Yaskawa shall in no event be responsible for any damage or loss of opportunity to the customer that arises due to failure of the delivered product.
- Yaskawa shall not be responsible for any programs (including parameter settings) or the results of program execution of the programs provided by the user or by a third party for use with programmable Yaskawa products.
- The information described in product catalogs or manuals is provided for the purpose of the customer purchasing the appropriate product for the intended application. The use thereof does not guarantee that there are no infringements of intellectual property rights or other proprietary rights of Yaskawa or third parties, nor does it construe a license.
- Yaskawa shall not be responsible for any damage arising from infringements of intellectual property rights or other proprietary rights of third parties as a result of using the information described in catalogs or manuals.

◆ Suitability for Use

- It is the customer's responsibility to confirm conformity with any standards, codes, or regulations that apply if the Yaskawa product is used in combination with any other products.
- The customer must confirm that the Yaskawa product is suitable for the systems, machines, and equipment used by the customer.
- Consult with Yaskawa to determine whether use in the following applications is acceptable. If use in the application is acceptable, use the product with extra allowance in ratings and specifications, and provide safety measures to minimize hazards in the event of failure.
 - Outdoor use, use involving potential chemical contamination or electrical interference, or use in conditions or environments not described in product catalogs or manuals
 - Nuclear energy control systems, combustion systems, railroad systems, aviation systems, vehicle systems, medical equipment, amusement machines, and installations subject to separate industry or government regulations
 - Systems, machines, and equipment that may present a risk to life or property
 - Systems that require a high degree of reliability, such as systems that supply gas, water, or electricity, or systems that operate continuously 24 hours a day
 - Other systems that require a similar high degree of safety
- Never use the product for an application involving serious risk to life or property without first ensuring that the system is designed to secure the required level of safety with risk warnings and redundancy, and that the Yaskawa product is properly rated and installed.
- The circuit examples and other application examples described in product catalogs and manuals are for reference. Check the functionality and safety of the actual devices and equipment to be used before using the product.
- Read and understand all use prohibitions and precautions, and operate the Yaskawa product correctly to prevent accidental harm to third parties.

◆ Specifications Change

The names, specifications, appearance, and accessories of products in product catalogs and manuals may be changed at any time based on improvements and other reasons. The next editions of the revised catalogs or manuals will be published with updated code numbers. Consult with your Yaskawa representative to confirm the actual specifications before purchasing a product.

1 Product Confirmation

When you receive your Σ -7-Series SERVOPACK, confirm the following items.

Item	Confirmation Method
Did you receive the correct Σ -7-Series SERVOPACK?	Check the model number on the nameplate on the side of the SERVOPACK. Also, check all accessories.
Is the SERVOPACK damaged in any way?	Check the entire external appearance of the SERVOPACK for damage that might have occurred during shipping.
Are there any loose screws?	Use a screwdriver to check for any loose screws.

If you discover any problems with the above items, contact your Yaskawa representative immediately.

■ Nameplate

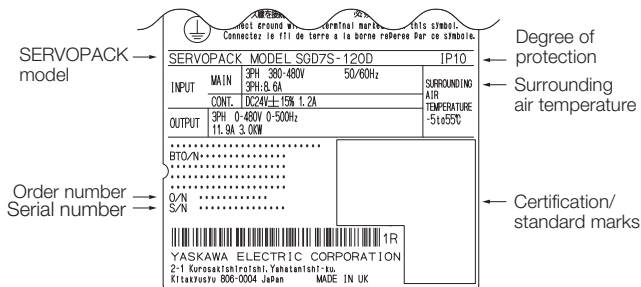

Figure1 SERVOPACK Nameplate

■ Interpreting Manufacturing Year and Month

The manufacturing year and month are given as part of the serial number.

S/N D 0 1 4 3 H 0 9 5 6 1 0 0 0 4

3rd+4th
digits

5th digit

3rd+4th
digits

Manufacturing Year

The last two digits of the manufacturing year are given.

Example

15: 2015

16: 2016

5th digit

Manufacturing Month

The manufacturing month is given using the codes listed in the following table.

Code	Manufacturing Month
1	January
2	February
3	March
4	April
5	May
6	June
7	July
8	August
9	September
X	October
Y	November
Z	December

2 Installation

When you install a SERVOPACK, refer to *Chapter 3 SERVOPACK Installation* in the product manual for your SERVOPACK.

The installation conditions are given in the following table.

Item		Specification				
Environmental Conditions	Surrounding Air Temperature	-5°C to +55°C (-5°C to +40°C for SGD7S-370D only)				
	Storage Temperature	-20°C to +85°C				
	Surrounding Air Humidity	95% relative humidity max. (with no freezing or condensation)				
	Storage Humidity	95% relative humidity max. (with no freezing or condensation)				
	Vibration Resistance	4.9 m/s ²				
	Shock Resistance	19.6 m/s ²				
	Degree of Protection	<table border="1"> <thead> <tr> <th>Degree</th> <th>SERVOPACK Models</th> </tr> </thead> <tbody> <tr> <td>IP10</td> <td> <ul style="list-style-type: none"> • SGD7S-1R9D, -3R5D, -5R4D, -8R4D, -120D, -170D, -210D, -260D, -280D, and -370D • SGD7W-2R6D and -5R4D </td> </tr> </tbody> </table>	Degree	SERVOPACK Models	IP10	<ul style="list-style-type: none"> • SGD7S-1R9D, -3R5D, -5R4D, -8R4D, -120D, -170D, -210D, -260D, -280D, and -370D • SGD7W-2R6D and -5R4D
	Degree	SERVOPACK Models				
	IP10	<ul style="list-style-type: none"> • SGD7S-1R9D, -3R5D, -5R4D, -8R4D, -120D, -170D, -210D, -260D, -280D, and -370D • SGD7W-2R6D and -5R4D 				
	Pollution Degree	2 <ul style="list-style-type: none"> • Must be no corrosive or flammable gases. • Must be no exposure to water, oil, or chemicals. • Must be no dust, salts, or iron powder. 				
Altitude	1,000 m max.					
Others	Do not use the SERVOPACK in the following locations: Locations subject to static electricity noise, strong electromagnetic/magnetic fields, or radioactivity					

Observe the following precautions when you install the SERVOPACK.

■ Installation in a Control Panel

- Design the size of the control panel, the SERVOPACK installation location, and the cooling method so that the temperature around the SERVOPACK meets the environmental conditions given on the previous page.
- If you install more than one SERVOPACK together, provide space between any two adjacent SERVOPACKs and install a fan above the SERVOPACKs. Also, provide space above and below the SERVOPACKs.

■ Installation Near Sources of Heat

Implement measures to prevent temperature increases caused by radiant or convection heat from heat sources so that the temperature around the SERVOPACK meets the environmental conditions.

■ Installation Near Sources of Vibration

Install a vibration absorber on the installation surface of the SERVOPACK so that the SERVOPACK will not be subjected to vibration.

■ Installation in Locations Subject to Corrosive Gas

Implement measures so that corrosive gas does not enter the SERVOPACK. Although corrosive gas will not immediately affect the SERVOPACK, it may cause the SERVOPACK or contact devices to fail in the future.

■ Other Precautions

- Do not install the SERVOPACK in a location subject to high temperatures, high humidity, water drops, cutting oil, excessive dust, excessive dirt, excessive iron powder, corrosive gasses, or radioactivity.
- Do not subject the SERVOPACK to freezing or condensation.
- To ensure long-term reliability, use the SERVOPACK at a surrounding air temperature of 45°C or lower.

3 Wiring

3.1 Wiring Precautions

Before you attempt to perform any wiring, read and understand the safety precautions that are given at the beginning of this document to help prevent bodily injury and equipment damage. Also observe the following precautions.

- Observe the maximum applicable voltage.
400-VAC Class: 480 Vrms AC (neutral ground)
- If you use the SERVOPACK with a Linear Servomotor or similar device on a moving part, use Flexible Cables.

3.2 Terminal Symbols and Terminal Names

Use the main circuit connector and terminal block on the SERVOPACK to wire the main circuit power supply and control circuit power supply to the SERVOPACK.

The layout of the main circuit power supply terminals on the SERVOPACK and detailed SERVOPACK dimensions depend on the model of the SERVOPACK. For details, refer to the product manual for your SERVOPACK.

The SERVOPACKs have two types of main circuit power supply specifications: three-phase 400-VAC power supply input and DC power supply input.



CAUTION

- Wire all connections correctly according to the following table.
If the wiring is not correct, there is a risk of SERVOPACK failure or fire.

◆ Three-Phase, 400-VAC Power Supply Input

Terminal Symbols	Terminal Name	Specification
L1, L2, and L3	Main circuit power supply input terminals for AC power supply input	Three-phase, 380 VAC to 480 VAC, -15% to +10%, 50 Hz/60 Hz
24 V	Control power supply terminals*1	24 VDC, -15% to +15%
0 V		0 VDC

Continued on next page.

Continued from previous page.

Terminal Symbols	Terminal Name	Specification
B1, B2, and B3	Regenerative Resistor terminals	If the internal regenerative resistor is insufficient, remove the lead or short bar between B2 and B3 and connect an External Regenerative Resistor between B1 and B2. Obtain an External Regenerative Resistor separately.
$\ominus 1$ and $\ominus 2$	DC Reactor terminals for power supply harmonic suppression	These terminals are to connect a DC reactor for power supply harmonic suppression and power factor improvement.
\oplus , \ominus	–	None. (Do not connect anything to this terminal.)
U, V, W, and PE	Servomotor terminals	These are the Σ -7S connection terminals for the Servomotor Main Circuit Cable (power line). Do not connect the PE terminal to anything other than the Servomotor ground terminal.
UA, VA, WA, and PE	Servomotor Terminals for Axis A	These are the Σ -7W connection terminals for the Servomotor Main Circuit Cables (power lines). Do not connect the PE terminal to anything other than the Servomotor ground terminal.
UB, VB, WB, and PE	Servomotor Terminals for Axis B	These are the Σ -7W connection terminals for the Servomotor Main Circuit Cables (power lines). Do not connect the PE terminal to anything other than the Servomotor ground terminal.
D1, D2, and D3	Dynamic Brake Resistor terminals	In the following cases, remove the lead or short bar between D2 and D3 and connect an External Dynamic Brake Resistor between D1 and D2. <ul style="list-style-type: none"> To reduce the brake torque when stopping with the dynamic brake To use a load moment of inertia that is larger than the standard specification The dynamic brake resistor is not provided by Yaskawa.
DC+	Servomotor Brake Power Supply Terminals*2	24 VDC, -10% to +10%*3
DC-		0 VDC
BK+ and BK-	Servomotor Brake Terminals*2	Connect these terminals to the Servomotor's holding brake terminals. The holding brake terminals on the Servomotor do not have any polarity.
	Ground terminal	This is the ground terminal to prevent electric shock. Always connect this terminal.

*1. Use an SELV-compliant power supply according to EN/IEC 60950-1 to input 24 VDC to the control power supply terminals.

*2. This terminal information applies only to SERVOPACKs with built-in Servomotor brake control.

- *3. Confirm the brake specifications for the Servomotor before you use the Servomotor.

◆ DC Power Supply Input

WARNING

- Always specify a DC power supply input (Pn001 = n.□1□□) before you input DC power for the main circuit power supply.
If you input DC power without specifying a DC power supply input (i.e., without setting Pn001 to n.□1□□), the SERVOPACK's internal elements may burn and may cause fire or damage to the equipment.
- With a DC power supply input, time is required to discharge electricity after the main power supply is turned OFF. A high residual voltage may remain in the SERVOPACK after the power supply is turned OFF. Be careful not to get an electric shock. Refer to the following section for details.
 **11 Capacitor Discharge Time** on page 54
- The Servomotor returns regenerative energy to the power supply. If you use a SERVOPACK with a DC power supply input, regenerative energy is not processed. Process the regenerative energy at the power supply.

Terminal Symbols	Terminal Name	Specification
24 V	Control power supply terminals*1	24 VDC, -15% to +15%
0 V		0 VDC
B1	Main circuit power supply input terminals for DC power supply input	513 VDC to 648 VDC, -15% to +10%
⊖ ₂		0 VDC
L1, L2, L3, B2, B3, ⊖ ₁ , ⊕, and ⊖	–	None. (Do not connect anything to this terminal.) Note: SGD7S-210D to 370D do not have a B3 terminal.
U, V, W, and PE	Servomotor terminals	These are the Σ-7S connection terminals for the Servomotor Main Circuit Cable (power line). Do not connect the PE terminal to anything other than the Servomotor ground terminal.
UA, VA, WA, and PE	Servomotor Terminals for Axis A	These are the Σ-7W connection terminals for the Servomotor Main Circuit Cables (power lines).
UB, VB, WB, and PE	Servomotor Terminals for Axis B	Do not connect the PE terminal to anything other than the Servomotor ground terminal.

Continued on next page.

Continued from previous page.

Terminal Symbols	Terminal Name	Specification
D1, D2, and D3	Dynamic Brake Resistor terminals	In the following cases, remove the lead or short bar between D2 and D3 and connect an External Dynamic Brake Resistor between D1 and D2. <ul style="list-style-type: none"> • To reduce the brake torque when stopping with the dynamic brake • To use a load moment of inertia that is larger than the standard specification The dynamic brake resistor is not provided by Yaskawa.
DC+	Servomotor Brake Power Supply Terminals*2	24 VDC, -10% to +10%*3
DC-		0 VDC
BK+ and BK-	Servomotor Brake Terminals*2	Connect these terminals to the Servomotor's holding brake terminals. The holding brake terminals on the Servomotor do not have any polarity.
	Ground terminal	This is the ground terminal to prevent electric shock. Always connect this terminal.

*1. Use an SELV-compliant power supply according to EN/IEC 60950-1 to input 24 VDC to the control power supply terminals.

*2. This terminal information applies only to SERVOPACKs with built-in Servomotor brake control.

*3. Confirm the brake specifications for the Servomotor before you use the Servomotor.

3.3 Molded-Case Circuit Breakers and Fuses

Using an AC Power Supply

Use a molded-case circuit breaker and fuse to protect the power supply line. They protect the power line by shutting OFF the circuit when overcurrent is detected. Select these devices based on the information in the following tables.

Note: The following tables provide the net values of the current capacity and inrush current. Select a fuse and a molded-case circuit breaker that meet the following conditions.

- Main circuit and control circuit: No breaking at three times the current value given in the table for 5 s.
- Inrush current: No breaking at the current value given in the table for 20 ms.

◆ Σ-7S SERVOPACKs

Main Circuit Power Supply	Maximum Applicable Motor Capacity [kW]	SERVO-PACK Model: SGD7S-	Power Supply Capacity per SERVO-PACK [kVA]*	Current Capacity		Inrush Current		Rated Voltage	
				Main Circuit [Arms]*	Control Power Supply [Arms]	Main Circuit [A0-p]	Control Power Supply [A0-p]	Fuse [V]	MCCB [V]
Three-phase, 400 VAC	0.5	1R9D	1.1	1.4	1.2	19	-	600	480
	1.0	3R5D	2.3	2.9					
	1.5	5R4D	3.5	4.3					
	2.0	8R4D	4.5	5.8	1.4	38	-		
	3.0	120D	7.1	8.6					
	5.0	170D	11.7	14.5					
	6.0	210D	12.4	17.4	1.7	68	-		
	7.5	260D	14.4	21.7					
	11.0	280D	21.9	31.8					
15.0	370D	30.6	43.4						

* This is the net value at the rated load.

◆ Σ-7W SERVOPACKs

Main Circuit Power Supply	Maximum Applicable Motor Capacity [kW]	SERVO-PACK Model: SGD7W-	Power Supply Capacity per SERVO-PACK [kVA]*	Current Capacity		Inrush Current		Rated Voltage	
				Main Circuit [Arms]*	Control Power Supply [Arms]	Main Circuit [A0-p]	Control Power Supply [A0-p]	Fuse [V]	MCCB [V]
Three-phase, 400 VAC	0.75	2R6D	3.5	4.4	1.2	19	-	600	480
	1.5	5R4D	6.8	8.6		38			

* This is the net value at the rated load.

Using a DC Power Supply

This section gives the power supply specifications for using a DC power supply input. Use the Fuses given in the following tables to protect the power supply line and SERVOPACK. They protect the power line by shutting OFF the circuit when overcurrent is detected.

Note: 1. If you connect more than one SERVOPACK to the same DC power supply, connect Fuses for each SERVOPACK.

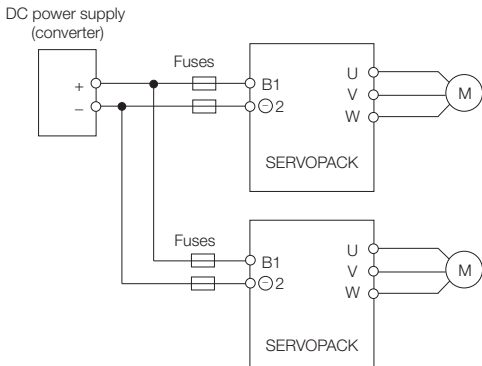

2. The following tables also provide the net values of the current capacity and inrush current.

◆ Σ-7S SERVOPACKs

Main Circuit Power Supply	Maximum Applicable Motor Capacity [kW]	SERVO-PACK Model: SGD7S-	Power Supply Capacity per SERVO-PACK [kVA] ^{*1}	Current Capacity		Inrush Current		External Fuse		
				Main Circuit [Arms] ^{*1}	Control Power Supply [Arms]	Main Circuit [A0-p]	Control Power Supply [A0-p]	Order Number ^{*2}	Current Rating [A]	Voltage Rating [Vdc]
540 VDC	0.5	1R9D	1.1	2.0	1.2	19	-	7,5URG J17/20	20	750
	1.0	3R5D	2.3	3.3						
	1.5	5R4D	3.5	5.5						
	2.0	8R4D	4.5	6.8						
	3.0	120D	7.1	11.0	1.4	38	-	7,5URG J17/35	35	
	5.0	170D	11.7	18.0				10URGJ 20/50	50	
	6.0	210D	12.4	19.6	1.7	68	-	10URGJ 31/125	125	
	7.5	260D	14.4	26.2				10URGJ 37/200	200	
	11.0	280D	21.9	38.3						
15.0	370D	30.6	47.6							

*1. This is the net value at the rated load.

*2. These Fuses are manufactured by Mersen Japan.

◆ Σ-7W SERVOPACKs

Main Circuit Power Supply	Maximum Applicable Motor Capacity [kW]	SERVO-PACK Model: SGD7W-	Power Supply Capacity per SERVO-PACK [kVA] ^{*1}	Current Capacity		Inrush Current		External Fuse		
				Main Circuit [Arms] ^{*1}	Control Power Supply [Arms]	Main Circuit [A0-p]	Control Power Supply [A0-p]	Order Number ^{*2}	Current Rating [A]	Voltage Rating [Vdc]
540 VDC	0.75	2R6D	3.5	5.0	1.2	19	-	7,5URG J17/20	20	750
	1.5	5R4D	6.8	11.0		38		7,5URG J17/35	35	

*1. This is the net value at the rated load.

*2. These Fuses are manufactured by Mersen Japan.

3.4 Wire Sizes and Tightening Torques

SERVOPACK Main Circuit Wires

This section describes the main circuit wires for SERVOPACKs.



Important

These specifications are based on IEC/EN 61800-5-1, UL 61800-5-1, and CSA C22.2 No.274.

1. To comply with UL standards, use UL-compliant wires.
2. Use copper conductors only.
3. Use wires with a rated temperature of 75°C or higher.
4. Use wires with a rated withstand voltage of 600 V or higher.

Note: To use 600-V-grade heat-resistant polyvinyl chloride-insulated wire (HIV), use the following table as reference for the applicable wires.

- The specified wire sizes are for three bundled leads when the rated current is applied with a surrounding air temperature of 40°C.
- Select the wires according to the surrounding air temperature.

If you connect an External Dynamic Brake Resistor, refer to the following section.

 **Dynamic Brake Resistor Terminals:** Σ -7S/ Σ -7W SERVOPACKs on page 37

Connecting the Main Circuit Connector

Connect wires to the main circuit connector as shown below. Tighten the screws to the specified torque.

Place the wire conductor into the wire insertion hole, insert a screwdriver into the screwdriver insertion hole, and tighten the screw.

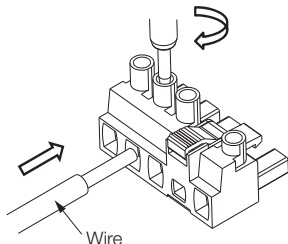

Wiring Connectors for the Control Power Supply Terminals, Servomotor Brake Power Supply Terminals, and Servomotor Brake Terminals

Press the lever with a screwdriver or your fingertip and insert the conductor of the wire into the wire insertion hole.

After you insert conductor, release the screwdriver or your fingertip.

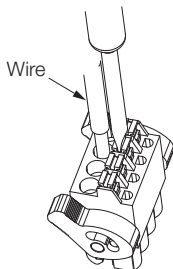



◆ Σ -7S SERVOPACKs for Use with Three-Phase, 400-VAC Power Supplies

SERVO-PACK Model: SGD7S-	Terminal Symbols	Wire Size	Screw Size	Tightening Torque [N·m]	Type of Screwdriver	Screwdriver End Dimensions Blade Thickness × Blade Width [mm]
1R9D	L1, L2, and L3	AWG16 (1.25 mm ²)	-	0.4 to 0.5	Flat-blade	0.6 × 3.5
	U, V, W, and PE*				Phillips or flat-blade	
	24 V and 0 V				Flat-blade	
	B1 and B2				Flat-blade	
		AWG14 (2.0 mm ²) or larger	M4	1.2 to 1.4	Phillips or flat-blade	-

Continued on next page.



Continued from previous page.

SERVO-PACK Model: SGD7S-	Terminal Symbols	Wire Size	Screw Size	Tightening Torque [N·m]	Type of Screwdriver	Screwdriver End Dimensions Blade Thickness × Blade Width [mm]
3R5D	L1, L2, and L3	AWG16 (1.25 mm ²)	-	0.4 to 0.5	Flat-blade	0.6 × 3.5
	U, V, W, and PE*				Phillips or flat-blade	
	24 V and 0 V				Flat-blade	
	B1 and B2				Flat-blade	
		AWG14 (2.0 mm ²) or larger	M4	1.2 to 1.4	Phillips or flat-blade	-
5R4D	L1, L2, and L3	AWG16 (1.25 mm ²)	-	0.4 to 0.5	Flat-blade	0.6 × 3.5
	U, V, W, and PE*				Phillips or flat-blade	
	24 V and 0 V				Flat-blade	
	B1 and B2				Flat-blade	
		AWG14 (2.0 mm ²) or larger	M4	1.2 to 1.4	Phillips or flat-blade	-
8R4D	L1, L2, and L3	AWG16 (1.25 mm ²)	-	0.4 to 0.5	Flat-blade	0.6 × 3.5
	U, V, W, and PE*				Phillips or flat-blade	
	24 V and 0 V				Flat-blade	
	B1 and B2				Flat-blade	
		AWG14 (2.0 mm ²) or larger	M4	1.2 to 1.4	Phillips or flat-blade	-

Continued on next page.



3 Wiring

Continued from previous page.

SERVO-PACK Model: SGD7S-	Terminal Symbols	Wire Size	Screw Size	Tightening Torque [N·m]	Type of Screwdriver	Screwdriver End Dimensions Blade Thickness × Blade Width [mm]
120D	L1, L2, and L3	AWG14 (2.0 mm ²)	-	0.4 to 0.5	Flat-blade	0.6 × 3.5
	U, V, W, and PE*				Phillips or flat-blade	
	24 V and 0 V	AWG16 (1.25 mm ²)			Flat-blade	
	B1 and B2					
	AWG14 (2.0 mm ²) or larger	M4	1.2 to 1.4	Phillips or flat-blade	-	
170D	L1, L2, and L3	AWG12 (3.5 mm ²)	-	0.4 to 0.5	Flat-blade	0.6 × 3.5
	U, V, W, and PE*				Phillips or flat-blade	
	24 V and 0 V	AWG16 (1.25 mm ²)			Flat-blade	
	B1 and B2	AWG14 (2.0 mm ²) or larger			M4	
						
210D	L1, L2, L3	AWG10 (5.5 mm ²)	-	0.4 to 0.5	Phillips or flat-blade	1.0 × 5.5
	U, V, W, PE*					0.6 × 3.5
	24 V, 0 V	AWG16 (1.25 mm ²)				1.0 × 5.5
	B1, B2	AWG12 (3.5 mm ²)		M4		1.2 to 1.4
	AWG14 (2.0 mm ²) or larger					





Continued on next page.

Continued from previous page.

SERVO-PACK Model: SGD7S-	Terminal Symbols	Wire Size	Screw Size	Tightening Torque [N·m]	Type of Screw-driver	Screwdriver End Dimensions Blade Thickness × Blade Width [mm]
260D	L1, L2, L3	AWG10 (5.5 mm ²)	-	1.2 to 1.5	Phillips or flat-blade	1.0 × 5.5
	U, V, W, PE*	AWG8 (8.0 mm ²)				
	24 V, 0 V	AWG16 (1.25 mm ²)		0.4 to 0.5		
	B1, B2	AWG12 (3.5 mm ²)		1.2 to 1.5		
		AWG14 (2.0 mm ²) or larger	M4	1.2 to 1.4		-
280D	L1, L2, L3	AWG8 (8.0 mm ²)	-	1.2 to 1.5	Phillips or flat-blade	1.0 × 5.5
	U, V, W, PE*					
	24 V, 0 V	AWG16 (1.25 mm ²)		0.4 to 0.5		
	B1, B2	AWG10 (5.5 mm ²)		1.2 to 1.5		
		AWG14 (2.0 mm ²) or larger	M4	1.2 to 1.4		-
370D	L1, L2, L3	AWG6 (14 mm ²)	-	1.2 to 1.5	Phillips or flat-blade	1.0 × 5.5
	U, V, W, PE*					
	24 V, 0 V	AWG16 (1.25 mm ²)		0.4 to 0.5		
	B1, B2	AWG8 (8.0 mm ²)		1.2 to 1.5		
		AWG14 (2.0 mm ²) or larger	M4	1.2 to 1.4		-





* If you do not use the recommended Servomotor Main Circuit Cable, use this table to select wires.

◆ Σ-7S SERVOPACKs for Use with DC Power Supplies

SERVO- PACK Model: SGD7S-	Terminal Symbols ¹	Wire Size	Screw Size	Tighten- ing Torque [N·m]	Type of Screw- driver	Screwdriver End Dimen- sions Blade Thick- ness × Blade Width [mm]
1R9D	U, V, W, and PE ^{*2}	AWG16 (1.25 mm ²)	-	0.4 to 0.5	Phillips or flat- blade	0.6 × 3.5
	24 V and 0 V				Flat- blade	
	B1 and ⊖ ²					
		AWG14 (2.0 mm ²) or larger	M4	1.2 to 1.4	Phillips or flat- blade	-
3R5D	U, V, W, and PE ^{*2}	AWG16 (1.25 mm ²)	-	0.4 to 0.5	Phillips or flat- blade	0.6 × 3.5
	24 V and 0 V				Flat- blade	
	B1 and ⊖ ²					
		AWG14 (2.0 mm ²) or larger	M4	1.2 to 1.4	Phillips or flat- blade	-
5R4D	U, V, W, and PE ^{*2}	AWG16 (1.25 mm ²)	-	0.4 to 0.5	Phillips or flat- blade	0.6 × 3.5
	24 V and 0 V				Flat- blade	
	B1 and ⊖ ²					
		AWG14 (2.0 mm ²) or larger	M4	1.2 to 1.4	Phillips or flat- blade	-
8R4D	U, V, W, and PE ^{*2}	AWG14 (2.0 mm ²)	-	0.4 to 0.5	Phillips or flat- blade	0.6 × 3.5
	24 V and 0 V	AWG16 (1.25 mm ²)			Flat- blade	
	B1 and ⊖ ²					
		AWG14 (2.0 mm ²) or larger	M4	1.2 to 1.4	Phillips or flat- blade	-



Continued on next page.

Continued from previous page.

SERVO-PACK Model: SGD7S-	Terminal Symbols*1	Wire Size	Screw Size	Tightening Torque [N·m]	Type of Screwdriver	Screwdriver End Dimensions Blade Thickness × Blade Width [mm]
120D	U, V, W, and PE*2	AWG14 (2.0 mm ²)	-	0.4 to 0.5	Phillips or flat-blade	0.6 × 3.5
	24 V and 0 V	AWG16 (1.25 mm ²)				
	B1 and ⊖2	AWG14 (2.0 mm ²)				
		AWG14 (2.0 mm ²) or larger	M4	1.2 to 1.4	Phillips or flat-blade	-
170D	U, V, W, and PE*2	AWG12 (3.5 mm ²)	-	0.4 to 0.5	Phillips or flat-blade	0.6 × 3.5
	24 V and 0 V	AWG16 (1.25 mm ²)				
	B1 and ⊖2	AWG12 (3.5 mm ²)				
		AWG14 (2.0 mm ²) or larger	M4	1.2 to 1.4	Phillips or flat-blade	-
210D	U, V, W, PE*2	AWG10 (5.5 mm ²)	-	1.2 to 1.5	Phillips or flat-blade	1.0 × 5.5
	24 V, 0 V	AWG16 (1.25 mm ²)		0.4 to 0.5		0.6 × 3.5
	B1, ⊖2	AWG12 (3.5 mm ²)		1.2 to 1.5		1.0 × 5.5
		AWG14 (2.0 mm ²) or larger	M4	1.2 to 1.4	-	
260D	U, V, W, PE*2	AWG8 (8.0 mm ²)	-	1.2 to 1.5	Phillips or flat-blade	1.0 × 5.5
	24 V, 0 V	AWG16 (1.25 mm ²)		0.4 to 0.5		0.6 × 3.5
	B1, ⊖2	AWG10 (5.5 mm ²)		1.2 to 1.5		1.0 × 5.5
		AWG14 (2.0 mm ²) or larger	M4	1.2 to 1.4	-	

Continued on next page.



Continued from previous page.

SERVO-PACK Model: SGD7S-	Terminal Symbols ^{*1}	Wire Size	Screw Size	Tightening Torque [N·m]	Type of Screwdriver	Screwdriver End Dimensions Blade Thickness × Blade Width [mm]
280D	U, V, W, PE ^{*2}	AWG8 (8.0 mm ²)	-	1.2 to 1.5	Phillips or flat-blade	1.0 × 5.5
	24 V, 0 V	AWG16 (1.25 mm ²)		0.4 to 0.5		0.6 × 3.5
	B1, ⊖2	AWG8 (8.0 mm ²)		1.2 to 1.5		1.0 × 5.5
		AWG14 (2.0 mm ²) or larger	M4	1.2 to 1.4		-
370D	U, V, W, PE ^{*2}	AWG6 (14 mm ²)	-	1.2 to 1.5	Phillips or flat-blade	1.0 × 5.5
	24 V, 0 V	AWG16 (1.25 mm ²)		0.4 to 0.5		0.6 × 3.5
	B1, ⊖2	AWG6 (14 mm ²)		1.2 to 1.5		1.0 × 5.5
		AWG14 (2.0 mm ²) or larger	M4	1.2 to 1.4		-

*1. Do not wire the following terminals: L1, L2, L3, B2, B3, ⊕, ⊖1, and ⊖.

*2. If you do not use the recommended Servomotor Main Circuit Cable, use this table to select wires.

◆ Σ -7W SERVOPACKs for Use with Three-Phase, 400-VAC Power Supplies

SERVO-PACK Model: SGD7W-	Terminal Symbols	Wire Size	Screw Size	Tightening Torque [N·m]	Type of Screwdriver	Screwdriver End Dimensions Blade Thickness × Blade Width [mm]
2R6D	L1, L2, and L3	AWG16 (1.25 mm ²)	-	0.4 to 0.5	Flat-blade	0.6 × 3.5
	U, V, W, and PE*				Phillips or flat-blade	
	24 V and 0 V				Flat-blade	
	B1 and B2				Flat-blade	
		AWG14 (2.0 mm ²) or larger	M4	1.2 to 1.4	Phillips or flat-blade	-
5R4D	L1, L2, and L3	AWG14 (2.0 mm ²)	-	0.4 to 0.5	Flat-blade	0.6 × 3.5
	U, V, W, and PE*	AWG16 (1.25 mm ²)			Phillips or flat-blade	
	24 V and 0 V				Flat-blade	
	B1 and B2				Flat-blade	
		AWG14 (2.0 mm ²) or larger	M4	1.2 to 1.4	Phillips or flat-blade	-

* If you do not use the recommended Servomotor Main Circuit Cable, use this table to select wires.

◆ Σ -7W SERVOPACKs for Use with DC Power Supplies

SERVO- PACK Model: SGD7W-	Terminal Symbols ^{*1}	Wire Size	Screw Size	Tighten- ing Torque [N·m]	Type of Screw- driver	Screwdriver End Dimen- sions Blade Thick- ness × Blade Width [mm]
2R6D	U, V, W, and PE ^{*2}	AWG16 (1.25 mm ²)	-	0.4 to 0.5	Phillips or flat- blade	0.6 × 3.5
	24 V and 0 V				Flat- blade	
	B1 and \ominus 2					
	\oplus	AWG14 (2.0 mm ²) or larger	M4	1.2 to 1.4	Phillips or flat- blade	-
5R4D	U, V, W, and PE ^{*2}	AWG16 (1.25 mm ²)	-	0.4 to 0.5	Phillips or flat- blade	0.6 × 3.5
	24 V and 0 V				Flat- blade	
	B1 and \ominus 2	AWG14 (2.0 mm ²)	M4	1.2 to 1.4		Phillips or flat- blade
	\oplus	AWG14 (2.0 mm ²) or larger				

*1. Do not wire the following terminals: L1, L2, L3, B2, B3, \oplus , \ominus 1, and \ominus .

*2. If you do not use the recommended Servomotor Main Circuit Cable, use this table to select wires.

◆ Dynamic Brake Resistor Terminals: Σ-7S/Σ-7W SERVOPACKS

These terminals are used if you connect an External Dynamic Brake Resistor.

SERVOPACK Models		Terminal Symbols	Wire Size*	Screw Size	Tightening Torque [N·m]	Type of Screwdriver	Screwdriver End Dimensions Blade Thickness × Blade Width [mm]
SGD7S-	1R9D, 3R5D, 5R4D, 8R4D, 120D, and 170D	D1 and D2	AWG12 (3.5 mm ²) to AWG18 (0.9 mm ²)	—	0.4 to 0.5	Phillips or flat- blade	0.6 × 3.5
SGD7W-	2R6D and 5R4D	D1 and D2	AWG12 (3.5 mm ²) to AWG18 (0.9 mm ²)	—	0.4 to 0.5	Phillips or flat- blade	0.6 × 3.5

* Any wire sizes within the ranges given in this table can be used for the External Dynamic Brake Resistor.

◆ Servomotor Brake Power Supply Terminals and Brake Terminals: Σ -7S/ Σ -7W SERVOPACKs

SERVOPACK Models		Terminal Symbols	Wire Size	Screw Size	Tightening Torque [N·m]	Type of Screwdriver	Screwdriver End Dimensions Blade Thickness × Blade Width [mm]
SGD7S-	1R9D, 3R5D, 5R4D, 8R4D, 120D, 170D, 210D, 260D, 280D, and 370D	DC+, DC-, BK+, and BK-	AWG16 (1.25 mm ²)	-	-	-	-
SGD7W-	2R6D and 5R4D	DC+, DC-, BK+, and BK-	AWG16 (1.25 mm ²)	-	-	-	-

◆ Wire Types

The following table shows the wire sizes and allowable currents for three bundled leads.

HIV Specifications*		Allowable Current at Surrounding Air Temperatures [Arms]		
Nominal Cross-sectional Area [mm ²]	Configuration [Wires/mm]	30°C	40°C	50°C
0.9	7/0.4	15	13	11
1.25	7/0.45	16	14	12
2.0	7/0.6	23	20	17
3.5	7/0.8	32	28	24
5.5	7/1.0	42	37	31
8.0	7/1.2	52	46	39
14.0	7/1.6	75	67	56

* This is reference data based on JIS C3317 600-V-grade heat-resistant polyvinyl chloride-insulated wires (HIV).

4 Maintenance and Inspection

This section describes the inspection and maintenance of a SERVOPACK.

4.1 Inspections

Perform the inspections given in the following table at least once every year for the SERVOPACK. Daily inspections are not required.

Item	Frequency	Inspection	Correction
External Appearance	At least once a year	Check for dust, dirt, and oil on the surfaces.	Clean with compressed air or a cloth.
Loose Screws		Check for loose terminal block and connector screws and for other loose parts.	Tighten any loose screws or other loose parts.

4.2 Guidelines for Part Replacement

The following electric or electronic parts are subject to mechanical wear or deterioration over time. Use one of the following methods to check the standard replacement period.

- Use the service life prediction function of the SERVOPACK.
- Use the following table.

When any standard replacement period is close to expiring, contact your Yaskawa representative. After an examination of the part in question, we will determine whether the part should be replaced.



Important

The parameters of any SERVOPACKs that are sent to Yaskawa for part replacement are reset to the default settings before they are returned to you. Always keep a record of the parameter settings. And, always confirm that the parameters are properly set before starting operation.

Part	Standard Replacement Period	Remarks
Cooling Fan	4 to 5 years	The standard replacement periods given on the left are for the following operating conditions.
Electrolytic Capacitor	10 years	Surrounding air temperature: Annual average of 30°C Load ratio: 80% max. Operation rate: 20 hours/day max.

Continued on next page.

4 Maintenance and Inspection

Continued from previous page.

Part	Standard Replacement Period	Remarks
Relays	100,000 power ON operations	Frequency of turning ON the power supply: Approx. once an hour
Battery	3 years without power supplied	Surrounding air temperature without power supplied: 20°C
Servomotor Brake Relay	30,000 brake operations	Allowable number of operations: 30 operations max. per minute

5 Conditions for Compliance with EC Directives

5.1 Conditions for Compliance with the EMC Directive

For a Servomotor and SERVOPACK combination to comply with the EMC Directive, ferrite cores, Noise Filters, Surge Absorbers, and possibly other devices must be used. These Yaskawa products are designed to be built into equipment. Therefore, you must implement EMC measures and confirm compliance for the final equipment. The applicable standards are EN 55011 group 1 class A, EN 61000-6-2, EN 61000-6-4, and EN 61800-3 (category C2, second environment).

For information on EMC installation conditions, refer to the product manual for your SERVOPACK.

5.2 Conditions for Compliance with the Low Voltage Directive

The products have been tested according to IEC/EN 61800-5-1 and EN 50178, and they comply the Low Voltage Directive. To comply with the Low Voltage Directive, the equipment or machine in which you use the products must meet the following conditions.

Installation Environment and Insulation Conditions

Overvoltage Category	III	Compliance standards: IEC 60364-4-44 and IEC 60664-1
Pollution Degree	2	Compliance standards: IEC 60364-4-44 and IEC 60664-1
Surrounding Air Temperature	-5°C to 55°C (-5°C to +40°C for SGD7S-370D only)	–
Altitude	1,000 m max.	–
Degree of Protection	Refer to <i>2 Installation</i> on page 18.	Compliance standard: IEC 60529
Protective Class	I	Compliance standard: IEC 61140
Input Power Supply	AC power supply	CE Marking is not applicable if a DC power supply input is used.
Ground	–	Ground to the neutral point of the AC input power supply.

External Power Supply for Control Circuits

For the DC power supply for the control signal I/O circuits (CN1 and CN8), use a power supply device with double insulation or reinforced insulation.

Installation of a Short-Circuit Protection Element

Always use Fuses that comply with UL standards on the main circuit power supply line.

Use either non-time delay fuses or semiconductor fuses.

Refer to *3.3 Molded-Case Circuit Breakers and Fuses* on page 24 for information on selecting fuse voltage and current ratings.

Installation of a Secondary Failure Prevention Element

Configure an external circuit so that a magnetic contactor (2KM) shuts OFF the main circuit power supply to the SERVOPACK whenever an alarm occurs. The SERVOPACK's internal elements may burn and may cause fire or damage to the equipment.

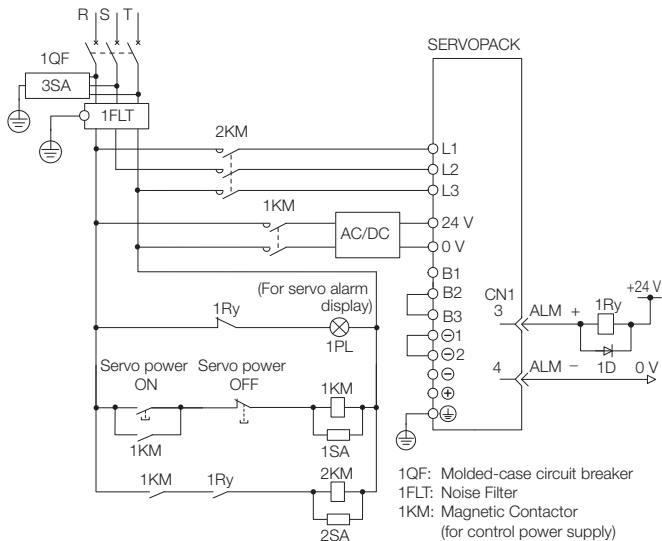

- 1QF: Molded-case circuit breaker
- 1FLT: Noise Filter
- 1KM: Magnetic Contactor
(for control power supply)
- 2KM: Magnetic Contactor
(for main circuit power supply)
- 1Ry: Relay
- 1PL: Indicator lamp
- 1SA: Surge Absorber
- 2SA: Surge Absorber
- 3SA: Surge Absorber
- 1D: Flywheel diode

6 Conditions for Compliance with UL/cUL Standards

The products have been tested according to the following standards and they comply the UL/cUL standards. To comply with the UL/cUL standards, the equipment or machine in which you use the products must meet the following conditions.

- UL: UL 61800-5-1 (Adjustable Speed Electrical Power Drive Systems)
- cUL: CSA C22.2 No.274 (Adjustable speed drives)

Installation Environment and Insulation Conditions

Overvoltage Category	III	Compliance standards: IEC 60364-4-44 and IEC 60664-1
Pollution Degree	2	Compliance standards: IEC 60364-4-44 and IEC 60664-1
Surrounding Air Temperature	-5°C to 55°C (-5°C to +40°C for SGD7S-370D only)	–
Altitude	1,000 m max.	–
Degree of Protection	Refer to 2 <i>Installation</i> on page 18.	Compliance standard: IEC 60529
Protective Class	I	Compliance standard: IEC 61140
Input Power Supply	AC power supply	UL/cUL standards are not applicable if a DC power supply input is used.
Ground	–	Ground to the neutral point of the AC input power supply.

External Power Supply for Control Circuits

The DC power supplies connected to the control signal I/O circuits (CN1 and CN8) must meet one of the following conditions.

- Use a class 2 power supply (compliance standard: UL 1310).
- Connect the control signal I/O circuits (CN1 and CN8) to a circuit with a maximum voltage of 30 Vrms and a peak voltage of 42.4 V that uses a UL 5085-3 (previous standard: UL 1585)-compliant class 2 transformer as its power supply.
- Use an isolated power supply with a maximum voltage of 30 Vrms and a peak voltage of 42.4 V that is isolated by double or reinforced insulation.

Wiring the Main Circuit Terminals

Wire the main circuit terminals according to the National Electrical Code (NEC/NFPA70) of the United States.

To comply with UL/cUL standards, always use the connectors that are enclosed with the SERVOPACK to wire the main circuit terminals.

Installing Branch Circuit Protection and Short-Circuit Current Rating

Integral solid state short circuit protection does not provide branch circuit protection.

Branch circuit protection must be provided in accordance with the National Electrical Code and any additional local codes.

To provide protection for short-circuit accidents in internal circuits, always connect molded-case circuit breakers or Fuses on the input side of the SERVOPACK as branch circuit protective devices.

The short-circuit current rating (SCCR) of the SERVOPACK will depend on the type of branch circuit protective device that you connect.

◆ Short-Circuit Current Rating (SCCR) for 400 V type: 5,000 Arms (Sine Wave)

Suitable for use on a circuit capable of delivering not more than 5,000 rms symmetrical amperes, 480 V maximum when protected by one of the branch circuit protection devices given in the following tables.

The time delay and non-time delay fuses shown in the chart below must be UL Listed Class CC, Class J, or Class T fuses.

The circuit breakers shown in the chart below must be UL Listed Molded-Case Circuit Breakers.

• Σ-7S SERVOPACKs

SERVOPACK Model: SGD7S-	Rated Output Current [Arms]	Maximum Current Rating of Molded-Case Circuit Breaker [A]	Maximum Current Rating of Time Delay Fuse [A]	Maximum Current Rating of Non-Time Delay Fuse [A]
1R9D	1.9	15	3	3
3R5D	3.5	15	6	10
5R4D	5.4	15	6	15
8R4D	8.4	25	10	25
120D	11.9	25	20	35
170D	16	40	25	45
210D	20.8	50	35	60

Continued on next page.

6 Conditions for Compliance with UL/cUL Standards

Continued from previous page.

SERVOPACK Model: SGD7S-	Rated Output Current [Arms]	Maximum Current Rating of Molded-Case Circuit Breaker [A]	Maximum Current Rating of Time Delay Fuse [A]	Maximum Current Rating of Non-Time Delay Fuse [A]
260D	25.7	50	40	70
280D*	28.1	50	45	80
370D*	37.2	50	60	110

* When only a molded-case circuit breaker is used to regulate the short-circuit current rating (SCCR), this SERVOPACK complies with the UL standard, not with the cUL standard.

• Σ-7W SERVOPACKS

SERVOPACK Model: SGD7W-	Rated Output Current [Arms]	Maximum Current Rating of Molded-Case Circuit Breaker [A]	Maximum Current Rating of Time Delay Fuse [A]	Maximum Current Rating of Non-Time Delay Fuse [A]
2R6D	2.6	10	6	15
5R4D	5.4	25	15	30

◆ Short-Circuit Current Rating (SCCR) for 400V type: 42,000 Arms (Sine Wave)

Suitable for use on a circuit capable of delivering not more than 42,000 rms symmetrical amperes, 480 V maximum when used with Busmann semiconductor fuses indicated in short circuit ratings tables below.

• Σ-7S SERVOPACKS

SERVOPACK Model: SGD7S-	Semiconductor Fuse Model	Current Rating of Semiconductor Fuse [A]	Voltage Rating of Semiconductor Fuse [V]
1R9D, 3R5D, and 5R4D	FWH-35B*	35	500
8R4D and 120D	FWH-50B*	50	
170D, 210D, and 260D	FWH-60B*	60	
280D and 370D	FWH-100B*	100	

* These Fuses are manufactured by the Busmann Division of Eaton.

• Σ -7W SERVOPACKs

SERVOPACK Model: SGD7W-	Semiconductor Fuse Model	Current Rating of Semiconductor Fuse [A]	Voltage Rating of Semiconductor Fuse [V]
2R6D	FWH-35B*	35	500
5R4D	FWH-50B*	50	

* These Fuses are manufactured by the Bussmann Division of Eaton.

Attaching of Warning Label Concerning Safe Handling During Maintenance and Inspection

In order to specify the instructions for the safe handling of this product for inspection and maintenance personnel, a self-adhesive warning label is included in the box with this SERVOPACK.

Affix this label to the inside of the enclosure (panel) in which the SERVOPACK is installed in a location that is visible during maintenance.

Servomotor Overtemperature Protection

Motor overtemperature protection that complies with UL standards (i.e., has speed-sensitive overload protection) is not provided. Motor overtemperature protection must be provided in the end use when required by the NEC/NFPA70 (Article 430, Chapter X, 430.126).

When used with a Yaskawa SGM□□ Servomotor, external overtemperature protection may not be needed because the motor is rated for continuous torque from 0 to the rated speed.

Precaution in Using Built-in Servomotor Brake Control

To control the Servomotor brake when you use a SERVOPACK with built-in Servomotor brake control, use a Σ -7-Series Servomotor with a Brake. The rating of that Servomotor must be equal to or lower than the rated output of the SERVOPACK. If the rating of the Servomotor is larger than the output rating of the SERVOPACK, the rating of the built-in brake relay may be exceeded.

7 Information on Hazardous Substances in Revised China RoHS (Labeling of Environment-friendly Use Period)

(基于“修订版中国 RoHS” (张贴环境保护使用期限) 的产品中含有有害物质的信息)

This is based on the “Management Methods for the Restriction of the Use of Hazardous Substances in Electrical and Electronic Products.”

本资料根据中国《电器电子产品有害物质限制使用管理办法》制定。

Contents of hazardous substances in products
产品中有毒物质的名称及含量

Parts Name 部件名称	Hazardous substances 有害物质					
	Lead 铅 (Pb)	Mercury 汞 (Hg)	Cad- mium 镉 (Cd)	Hexava- lent chro- mium 六价铬 (Cr (VI))	Polybro- minated biphenyls 多溴联苯 (PBB)	Polybromi- nated diphe- nyl ethers 多溴二苯醚 (PBDE)
Circuit Board 实装基板	×	○	○	○	○	○
Electronic parts 电子元件	×	○	○	○	○	○
Heat sink 散热器	×	○	○	○	○	○
Mechanical parts 机械元件	×	○	○	○	○	○

This table has been prepared in accordance with the provisions outlined in SJ/T 11364.

本表格依据 SJ/T 11364 的规定编制。

○: Indicates that said hazardous substance contained in all of the homogeneous materials for this part is below or equal to the limit requirement of GB/T 26572.

×: Indicates that said hazardous substance contained in at least one of the homogeneous materials used for this part is above the limit requirement of GB/T 26572.

○: 表示该有害物质在该部件所有均质材料中的含量均在 GB/T 26572 规定的限量要求以下。

×: 表示该有害物质至少在该部件的某一均质材料中的含量超出 GB/T 26572 规定的限量要求。

7 Information on Hazardous Substances in Revised China RoHS (Labeling of Environment-friendly Use Period)

Note: This product complies with EU RoHS directives.

In the above table, “x” indicates that hazardous substances that are exempt from EU RoHS directives are contained.

注：本产品符合欧洲的 RoHS 指令。

上表中的“x”表示含有欧盟 RoHS 指令豁免的有害物质。

8 Precautions for Korean Radio Waves Act (한국 전파법에 관한 주의사항)

These products confirm to broadcast and communications equipment for business use (Class A) and are designed for use in locations other than in ordinary houses.

KC 마크가 부착되어 있는 제품은 한국 전파법에 적합한 제품입니다. 한국에서 사용할 경우에는 아래 사항에 주의하여 주십시오.

사용자 안내문

이 기기는 업무용 환경에서 사용할 목적으로 적합성평가를 받은 기기로서 가정용 환경에서 사용하는 경우 전파간섭의 우려가 있습니다.

(주)사용자 안내문은 “업무용 방송통신기자재”에만 적용한다.

9 Crimp Terminals and Insulating Sleeves

If you use crimp terminals for wiring, use insulating sleeves. Do not allow the crimp terminals to come close to adjacent terminals or the case.

To comply with UL standards, you must use UL-compliant closed-loop crimp terminals and insulating sleeves for the main circuit terminals. Use the tool recommended by the crimp terminal manufacturer to attach the crimp terminals.

The following tables give the recommended tightening torques, closed-loop crimp terminals, and insulating sleeves in sets. Use the set that is suitable for your model and wire size.

If you use a SERVOPACK that supports a Dynamic Brake Option and connect an External Dynamic Brake Resistor, refer to the following section.

 **Dynamic Brake Resistor Terminals:** Σ -7S/ Σ -7W SERVOPACKs on page 52

Σ -7S SERVOPACKs for Use with Three-Phase, 400-VAC or DC Power Supplies

SERVOPACK Model: SGD7S-	Main Circuit Terminals	Screw Size	Tightening Torque [N·m]	Crimp Terminal Horizontal Width	Recommended Wire Size	Crimp Terminal Model	Crimping Tool	Die	Insulating Sleeve Model
						From J.S.T. Mfg. Co., Ltd.			
1R9D, 3R5D, 5R4D, 8R4D, 120D, 170D, 210D, 260D, 280D, and 370D	Connector								
		M4	1.2 to 1.4	10 mm max.	AWG14 (2.0 mm ²)	R2-4	YHT-2210	—	—

Σ -7W SERVOPACKs for Use with Three-Phase, 400-VAC or DC Power Supplies

SERVOPACK Model: SGD7W-	Main Circuit Terminals	Screw Size	Tightening Torque [N·m]	Crimp Terminal Horizontal Width	Recommended Wire Size	Crimp Terminal Model	Crimping Tool	Die	Insulating Sleeve Model
						From J.S.T. Mfg. Co., Ltd.			
2R6D, and 5R4D	Connector								
		M4	1.2 to 1.4	10 mm max.	AWG14 (2.0 mm ²)	R2-4	YHT-2210	—	—

Dynamic Brake Resistor Terminals: Σ-7S/Σ-7W SERVOPACKs

These terminals are used if you connect an External Dynamic Brake Resistor.

SERVOPACK Models	Dynamic Brake Terminals	Screw Size	Tightening Torque [N·m]	Crimp Terminal Horizontal Width	Recommended Wire Size	Crimp Terminal Model	Crimping Tool	Insulating Sleeve Model
						From J.S.T. Mfg. Co., Ltd.		From Tokyo Dip Co., Ltd.
SGD7S-	1R9D, 3R5D, 5R4D, 8R4D, 120D, and 170D	Connector						
SGD7W-	2R6D and 5R4D	Connector						

◆ Crimp Terminal Dimensional Drawing

■ Crimp Terminal Model: R2-4

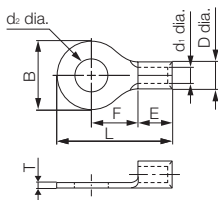

Crimp Terminal Model	Dimensions (mm)							
	d ₂ dia.	B	L	F	E	D dia.	d ₁ dia.	T
R2-4	4.3	8.5	16.8	7.8	4.8	4.1	2.3	0.8

10 SERVOPACK Overload Protection Characteristics

The overload detection level is set for hot start conditions with a SERVOPACK surrounding air temperature of 55°C.

An overload alarm (A.710 or A.720) will occur if overload operation that exceeds the overload protection characteristics shown in the following diagram (i.e., operation on the right side of the applicable line) is performed. The actual overload detection level will be the detection level of the connected SERVOPACK or Servomotor that has the lower overload protection characteristics.

In most cases, that will be the overload protection characteristics of the Servomotor.

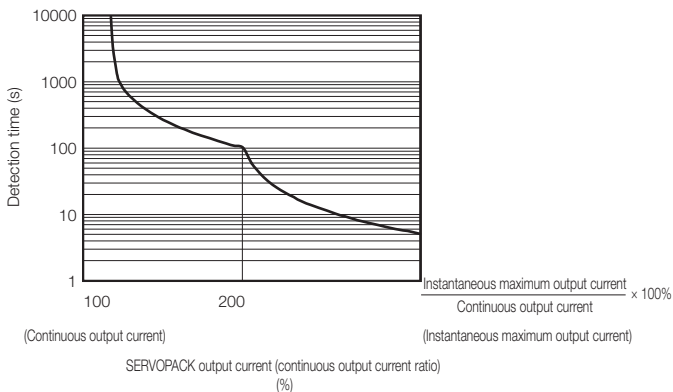

Note: The above overload protection characteristics do not mean that you can perform continuous duty operation with an output of 100% or higher.

For a Yaskawa-specified combination of SERVOPACK and Servomotor, maintain the effective torque or the effective force within the continuous duty zone of the torque-motor speed characteristics or the force-motor speed characteristics of the Servomotor. Refer to the catalog for the torque-motor speed characteristics and force-motor speed characteristics.

11 Capacitor Discharge Time

Do not touch the power supply terminals within the capacitor discharge time given in the following table after turning OFF the power supply because high voltage may still remain in the SERVOPACK.

After the CHARGE indicator goes out, use a tester to check the voltage on the DC bus line (between the B1 and $\ominus 2$ terminals) and confirm that it is safe to proceed before starting wiring or inspection work.

Note: 1. When the parameter is set for an AC power supply input and the recommended power shutoff sequence is configured (i.e., to shut off the control power supply after shutting off the main circuit power supply), the capacitor discharge times given in the *AC Power Supply Input* column in the following table apply.

If you shut off the control power supply before you shut off the main circuit power supply, the discharge times given in the *DC Power Supply Input* column apply even if the parameter is set for an AC power supply input.

2. If a failure occurs in the SERVOPACK, the discharge times given in the *DC Power Supply Input* column may apply even if the parameter is set for an AC power supply input.

Σ -7S SERVOPACKs

SERVOPACK Model: SGD7S-	Discharge Time	
	AC Power Supply Input	DC Power Supply Input
1R9D	40 ms	6 min
3R5D	80 ms	6 min
5R4D	80 ms	6 min
8R4D	80 ms	6 min
120D	80 ms	6 min
170D	80 ms	6 min
210D	90 ms	10 min
260D	110 ms	10 min
280D	110 ms	15 min
370D	130 ms	15 min

Σ -7W SERVOPACKs

SERVOPACK Model: SGD7W-	Discharge Time	
	AC Power Supply Input	DC Power Supply Input
2R6D	80 ms	6 min
5R4D	80 ms	6 min

Revision History

The revision dates and numbers of the revised manuals are given at the right bottom of the back cover.

MANUAL NO. TOMP C710828 02B <1>

Revision number

Published in UK May 2016

Date of publication

Date of Publication	Rev. No.	Section	Revised Content
March 2020	<8>	Chapters 1, 3, 6	Partly revised.
		Back cover	Revision: Address
January 2019	<7>	Preface	Revision: Disposal Precautions
November 2018	<6>	Back cover	Revision: Address
September 2018	<5>	Preface	Revision: Wiring Precautions
		Back cover	Revision: Address
April 2017	<4>	Chapter 6	Revision: Values for current ratings and voltage ratings for molded-case circuit breakers and fuses for short-circuit current rating (SCCR)
		Chapter 8	Revision: Description of Precautions for Korean Radio Waves Act
January 2017	<3>	Chapter 3, 6, 8, and 10	Addition: SGD7S-210D, -260D, -280D, and -370D
		Chapter 3	Addition: Information on wire types
		Chapter 6	Addition: Information on external power supply for control circuits
			Deletion: Fuse models from Mersen Japan
		Chapter 7	Addition: Information on Hazardous Substances in Revised China RoHS (Labeling of Environment-friendly Use Period)
Back cover	Revision: Address		
June 2016	<2>	Chapter 6	Revision: Information on short-circuit current rating (5,000 Arms)

Date of Publication	Rev. No.	Section	Revised Content
May 2016	<1>	All chapters	Addition: SGD7S-170D, SGD7W-2R6D, and SGD7W-5R4D
		Chapter 1	Addition: Information on interpreting manufacturing year and month.
		Chapter 3	Revision: Details on terminals
		4.2	Addition: Information on Servomotor brake relays
		5.2	Addition: Installation of a Secondary Failure Prevention Element
		Chapter 6	Addition: Fuse models from Mersen Japan
			Addition: Precaution in using a SERVOPACK with built-in Servomotor brake control
Back cover	Revision: Address		
May 2015	–	–	First edition

Σ -7-Series AC Servo Drive Σ -7S and Σ -7W SERVOPACK with 400 V-Input Power Safety Precautions

IRUMA BUSINESS CENTER (SOLUTION CENTER)

480, Kamifujisawa, Iruma, Saitama, 358-8555, Japan
Phone: +81-4-2962-5151 Fax: +81-4-2962-6138
www.yaskawa.co.jp

YASKAWA AMERICA, INC.

2121, Norman Drive South, Waukegan, IL 60085, U.S.A.
Phone: +1-800-YASKAWA (927-5292) or +1-847-887-7000 Fax: +1-847-887-7310
www.yaskawa.com

YASKAWA ELÉTRICO DO BRASIL LTDA.

777, Avenida Piraporinha, Diadema, São Paulo, 09950-000, Brasil
Phone: +55-11-3585-1100 Fax: +55-11-3585-1187
www.yaskawa.com.br

YASKAWA EUROPE GmbH

Hauptstraße 185, 65760 Eschborn, Germany
Phone: +49-6196-569-300 Fax: +49-6196-569-398
www.yaskawa.eu.com E-mail: info@yaskawa.eu.com

YASKAWA ELECTRIC KOREA CORPORATION

35F, Three IFC, 10 Gukjegeumyung-ro, Yeongdeungpo-gu, Seoul, 07326, Korea
Phone: +82-2-784-7844 Fax: +82-2-784-8495
www.yaskawa.co.kr

YASKAWA ASIA PACIFIC PTE. LTD.

30A, Kallang Place, #06-01, 339213, Singapore
Phone: +65-6282-3003 Fax: +65-6289-3003
www.yaskawa.com.sg

YASKAWA ELECTRIC (THAILAND) CO., LTD.

59, 1F-5F, Flourish Building, Soi Ratchadapisek 18, Ratchadapisek Road, Huaykwang, Bangkok, 10310, Thailand
Phone: +66-2-017-0099 Fax: +66-2-017-0799
www.yaskawa.co.th

YASKAWA ELECTRIC (CHINA) CO., LTD.

22F, Link Square 1, No.222, Hubin Road, Shanghai, 200021, China
Phone: +86-21-5385-2200 Fax: +86-21-5385-3299
www.yaskawa.com.cn

YASKAWA ELECTRIC (CHINA) CO., LTD. BEIJING OFFICE

Room 1011, Tower W3 Oriental Plaza, No.1, East Chang An Avenue,
Dong Cheng District, Beijing, 100738, China
Phone: +86-10-8518-4086 Fax: +86-10-8518-4082

YASKAWA ELECTRIC TAIWAN CORPORATION

12F, No. 207, Section 3, Beishin Road, Shindian District, New Taipei City 23143, Taiwan
Phone: +886-2-8913-1333 Fax: +886-2-8913-1513 or +886-2-8913-1519
www.yaskawa.com.tw

YASKAWA

YASKAWA ELECTRIC CORPORATION

In the event that the end user of this product is to be the military and said product is to be employed in any weapons systems or the manufacture thereof, the export will fall under the relevant regulations as stipulated in the Foreign Exchange and Foreign Trade Regulations. Therefore, be sure to follow all procedures and submit all relevant documentation according to any and all rules, regulations and laws that may apply. Specifications are subject to change without notice for ongoing product modifications and improvements.
© 2015 YASKAWA ELECTRIC CORPORATION

MANUAL NO. TOMP C710828 02H

Published in UK March 2020

19-10-16

Original instructions