

Σ Series SGME/SGDE (for position control) USER'S MANUAL

AC Servomotor and Driver

SGME Servomotor

SGDE-□□□P Servopack

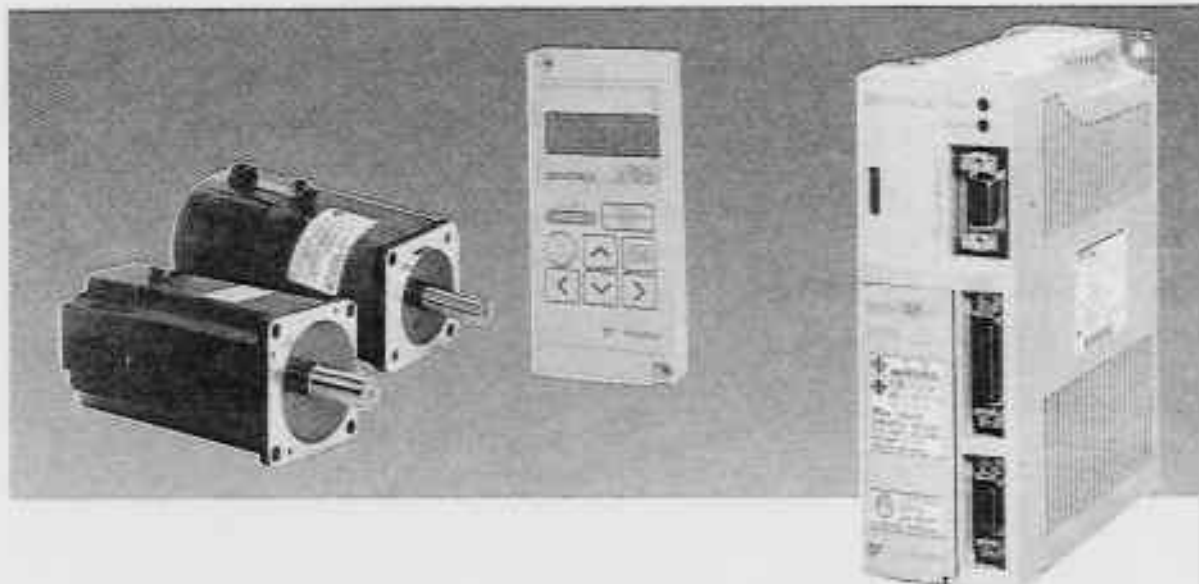

NOTES FOR SAFE OPERATION

This manual covers the products of the Σ Series SGME/SGDE, which feature superior functions and performance. This manual was designed to provide comprehensible information for users who are about to use a servo for the first time as well as for users who already have experience in using servos. This manual enables users to understand how to design, install, operate, and maintain a servo system. Keep this manual in a convenient location and refer to it whenever necessary in operating and maintaining the servo system.



General Precautions

- Some drawings in this manual are shown with the protective cover or shields removed, in order to describe the detail with more clarity. Make sure all covers and shields are replaced before operating this product.
- Some drawings in this manual are shown as typical example and may differ from the shipped product.
- This manual may be modified when necessary because of improvement of the product, modification or changes in specifications.
Such modification is made as a revision by renewing the manual No.
- To order a copy of this manual, if your copy has been damaged or lost, contact your YASKAWA representative listed on the last page stating the manual No. on the front cover.
- YASKAWA is not responsible for accidents or damages due to any modification of the product made by the user since that will void our guarantee.

NOTES FOR SAFE OPERATION

Read this manual thoroughly before installation, operation, maintenance or inspection of the AC Servo Drives. In this manual, the NOTES FOR SAFE OPERATION are classified as "WARNING" or "CAUTION".

WARNING

Indicates a potentially hazardous situation which, if not avoided, could result in death or serious personal injury.

CAUTION

Indicates a potentially hazardous situation which, if not avoided, may result in minor or moderate personal injury and/or damage to the equipment.

In some instances, items described in  CAUTION may also result in a serious accident. In either case, follow these important items.

WARNING

(WIRING)

- Grounding must be in accordance with the national code and consistent with sound local practices.
Failure to observe this warning may lead to electric shock or fire.

(OPERATION)

- Never touch any rotating motor parts or machine movable part during operation.
Failure to observe this warning may result in personal injury.

(INSPECTION AND MAINTENANCE)

- Be sure to turn OFF power before inspection or maintenance.
Otherwise, electric shock may result.
- Never open the terminal cover while power is ON, and never turn ON power when the terminal cover is open.
Otherwise, electric shock may result.
- After turning OFF power, wait at least five minutes before servicing the product.
Otherwise, residual electric charges may result in electric shock.

CAUTION

(RECEIVING)

- Use the specified combination of SERVOMOTOR and SERVOPACK.
Failure to observe this caution may lead to fire or failure.

(INSTALLATION)

- Never use the equipment where it may be exposed to splashes of water, corrosive or flammable gases, or near flammable materials.
Failure to observe this caution may lead to electric shock or fire.



CAUTION

(WIRING)

- Do not connect three-phase power supply to output terminals ① ② and ③.
Failure to observe this caution may lead to personal injury or fire.
- Securely tighten screws on the power supply and motor output terminals.
Failure to observe this caution can result in a fire.
- Never change wiring while power is ON.
Failure to observe this caution may result in electric shock or personal injury.
- When terminals P and N are connected in parallel, always turn ON the power supply to all axes at the same time.
Failure to observe this caution may lead to fire or failure.

(OPERATION)

- To avoid inadvertent accidents, run the SERVOMOTOR only in test run (without load).
Failure to observe this caution may result in personal injury.
- Before starting operation with a load connected, set up user constants suitable for the machine.
Starting operation without setting up user constants may lead to overrun failure.
- Before starting operation with a load connected, make sure emergency-stop procedures are in place.
Failure to observe this caution may result in personal injury.
- During operation, do not touch the heat sink.
Failure to observe this caution may result in burns.

(INSPECTION AND MAINTENANCE)

- Do not disassemble the SERVOMOTOR.
Failure to observe this caution may result in electric shock or personal injury.
- Never change wiring while power is ON.
Failure to observe this caution may result in electric shock or personal injury.

Manual Contents

This manual provides Σ -Series users with information on the following:

- Checking the product on delivery and basic applications of the servo.
- Servo applications.
- Selecting an appropriate servo for your needs and placing an order.
- Inspection and maintenance.

Manual Structure

All chapters in this manual are classified into one or more of three areas according to their contents: A, B, and C. Refer to the applicable chapters for the information you require.

A: Chapters explaining how to select a servo: For users who wish to gain a basic understanding of Σ Series products or who need to select an appropriate servo.

B: Chapters explaining how to design a servo system: For users who are about to design, install, and operate a Σ -Series Servo Control System.

C: Chapters explaining maintenance: For users who are going to maintain and troubleshoot Σ -Series products.

Chapter	Title	Page	Area
CHAPTER 1	Basic Uses of Σ-series Products	1	B
	Describes steps to take when product is received, plus basic wiring and application methods.		
CHAPTER 2	Applications of Σ-series Products	27	B
	Describes the effective usage of Σ -Series features according to application.		
CHAPTER 3	Using the Digital Operator	73	B
	Describes operating procedures for Σ -Series servos, turning features ON and OFF, setting control constants, etc.		
CHAPTER 4	Servo Selection and Data Sheets	101	A, B
	Describes selection methods for Σ -Series servos and peripherals and provides servo specifications.		
CHAPTER 5	Inspection, Maintenance, and Troubleshooting	179	C
	Describes user maintenance and troubleshooting.		
APPENDIXES			
A	Servo Adjustment	197	B, C
B	List of I/O Signals	207	A, B, C
C	List of User Constants	211	B, C
INDEX	215	A, B, C

Basic Terms

Unless otherwise specified, the following definitions are used:

- Servomotor:** Σ -Series SGME Servomotor
- Servopack:** An amplifier (Trademark of Yaskawa servo amplifier "SGDE Servopack")
- Servodrive:** A SGME Servomotor and an amplifier (SGDE Servopack)
- Servo system:** A complete servo control system consisting of servodrive, host controller, and peripheral devices

Visual Aids

The following aids are used to indicate certain types of information for easier reference.



Indicates references for additional information.



Technical terms placed in bold in the text are briefly explained in a "TERMS" section at the bottom of the page. The following kinds of technical terms are explained: Technical terms that need to be explained to users who are not very familiar with servo systems or electronic devices and technical terms specific to Σ Series Servos that need to be explained in descriptions of functions.



The text indicated by this icon explains the operating procedure using hand-held type digital operator (Type: JUSP-OP02A-1).

JUSP-OP02A-1



JUSP-OP03A

The text indicated by this icon explains the operating procedure using mount type digital operator (Type: JUSP-OP03A).

NOTE A Σ -Series Servodrive alone cannot ensure the functionality and performance of the entire machine control system. It must be combined with an appropriate machine and host controller so that the entire control system works properly. Therefore, carefully read the instruction manuals for the machine to be used before attempting to operate the servodrive.

©Yaskawa, 1996

All rights reserved. No part of this publication may be reproduced, stored in a retrieval system, or transmitted, in any form, or by any means, mechanical, electronic, photocopying, recording, or otherwise, without the prior written permission of Yaskawa. No patent liability is assumed with respect to the use of the information contained herein. Moreover, because Yaskawa is constantly striving to improve its high-quality products, the information contained in this manual is subject to change without notice. Every precaution has been taken in the preparation of this manual. Nevertheless, Yaskawa assumes no responsibility for errors or omissions. Neither is any liability assumed for damages resulting from the use of the information contained in this publication.

CONTENTS

CHAPTER 1	BASIC USES OF Σ-SERIES PRODUCTS	1
1.1	Precautions	2
1.1.1	Notes on Use	2
1.2	Installation	4
1.2.1	Checking on Delivery	4
1.2.2	Installing the Servomotor	5
1.2.3	Installing the Servopack	8
1.2.4	Power Loss	11
1.3	Connection and Wiring	11
1.3.1	Connecting to Peripheral Devices	11
1.3.2	Main Circuit Wiring and Power ON Sequence	14
1.4	Conducting a Test Run	16
1.4.1	Test Run in Two Steps	16
1.4.2	Step 1: Conducting a Test Run for Motor without Load	18
1.4.3	Step 2: Conducting a Test Run with the Motor Connected to the Machine	22
1.4.4	Supplementary Information on Test Run	24
1.4.5	Minimum User Constants Required and Input Signals	25
CHAPTER 2	APPLICATIONS OF Σ-SERIES PRODUCTS	27
2.1	Setting User Constants According to Machine Characteristics	30
2.1.1	Changing the Direction of Motor Rotation	30
2.1.2	Setting the Overtravel Limit Function	31
2.2	Setting User Constants According to Host Controller	33
2.2.1	Inputting Position Reference	33
2.2.2	Using Contact I/O Signals	37
2.2.3	Using Electronic Gear	39
2.3	Setting Up the Σ Servopack	43
2.3.1	Using Autotuning Function	43
2.3.2	Setting Servo Gain	43
2.3.3	Using the Smoothing Function	45
2.3.4	Setting the Torque Reference Filter Time Constant	46
2.4	Setting Stop Mode	47
2.4.1	Dynamic Brake	47
2.4.2	Using Holding Brake	48
2.5	Forming a Protective Sequence	51
2.5.1	Using Servo Alarm Output	51
2.5.2	Using Servo ON Input Signal	51
2.5.3	Using Positioning Complete Signal	53
2.5.4	Handling of Power Failure	54
2.6	Special Wiring	56
2.6.1	Wiring Instructions	56
2.6.2	Wiring for Noise Control	58
2.6.3	Using More Than One Servo Drive	63
2.6.4	Using Regenerative Units	64
2.6.5	Using SGDE Servopack with High Voltage Line	67
2.6.6	Connector Terminal Layouts	69
CHAPTER 3	USING THE DIGITAL OPERATOR	73
3.1	Basic Operations	74

CONTENTS

3.1.1	Connecting the Digital Operator	74
3.1.2	Resetting Servo Alarms	75
3.1.3	Basic Functions and Mode Selection	76
3.1.4	Operation in Status Display Mode	77
3.1.5	Operation in User Constant Setting Mode	78
3.1.6	Operation in Monitor Mode	83
3.2	Using the Functions	86
3.2.1	Operation in Alarm Trace-back Mode	86
3.2.2	Operation Using the Digital Operator	88
3.2.3	Autotuning	91
3.2.4	Clearing Alarm Trace-back Data	97
3.2.5	Checking Motor Type	98
3.2.6	Checking Software Version	99
CHAPTER 4	SERVO SELECTION AND DATA SHEETS	101
4.1	Selecting a Σ -Series Servo	103
4.1.1	Selecting a Servomotor	103
4.1.2	Selecting a Servopack	110
4.1.3	Selecting a Digital Operator	112
4.2	SGM Servomotor	113
4.2.1	Ratings and Specifications	113
4.2.2	Mechanical Characteristics	120
4.3	Servopack Ratings and Specifications	122
4.3.1	Ratings and Specifications	122
4.3.2	Overload Characteristics	125
4.3.3	Starting Time and Stopping Time	126
4.3.4	Load Inertia	126
4.3.5	Overhanging Loads	128
4.3.6	Power Consumption	129
4.4	Σ -Series Dimensional Drawings	130
4.4.1	Servomotor Dimensional Drawings	130
4.4.2	Servopack Dimensional Drawings	140
4.4.3	Digital Operator Dimensional Drawings	143
4.5	Selecting Peripheral Devices	144
4.5.1	Selecting Peripheral Devices	144
4.6	Specifications and Dimensional Drawings of Peripheral Devices	149
4.6.1	Cable Specifications and Peripheral Devices	149
4.6.2	Motor Cables	152
4.6.3	Connector Kits	155
4.6.4	Brake Power Supply	159
4.6.5	Encoder Cables	161
4.6.6	1CN Connector	165
4.6.7	Connector Terminal Block Converter Unit	167
4.6.8	Cable With 1CN Connector and One End Without Connector	169
4.6.9	Circuit Breaker	169
4.6.10	Noise Filter	170
4.6.11	Magnetic Contactor	171

CONTENTS

4.6.12	Surge Suppressor	172
4.6.13	Regenerative Unit	173
4.6.14	Cables for Connecting PC and Servopack	175

CHAPTER 5 INSPECTION, MAINTENANCE, AND TROUBLESHOOTING 179

5.1	Inspection and Maintenance	180
5.1.1	Servomotor	180
5.1.2	Servopack	181
5.2	Troubleshooting	182
5.2.1	Troubleshooting Problems with Alarm Display	182
5.2.2	Troubleshooting Problems With No Alarm Display	194
5.2.3	Internal Connection Diagram and Instrument Connection Examples	195

APPENDIXES

A	Servo Adjustment	197
A.1	Σ -Series AC Servopack Gain Adjustment	198
A.1.1	Σ -Series AC Servopacks and Gain Adjustment Methods	198
A.1.2	Basic Rules for Gain Adjustment	199
A.2	Adjusting a Position-control Servopack	200
A.3.1	Adjusting Using Auto-tuning	200
A.3.2	Manual Adjustment	201
A.3	Gain Setting References	204
A.4.1	Guidelines for Gain Settings According to Load Inertia Ratio	204
B	List of I/O Signals	207
C	List of User Constants	211

INDEX 214

BASIC USES OF Σ -SERIES PRODUCTS

1

This chapter describes the first things to do when Σ -Series products are delivered. It also explains the most fundamental ways of connecting and operating Σ -Series products. Both first-time and experienced servo users **must read** this chapter.

1.1	Precautions	2
1.1.1	Notes on Use	2
1.2	Installation	4
1.2.1	Checking on Delivery	4
1.2.2	Installing the Servomotor	5
1.2.3	Installing the Servopack	8
1.3	Connection and Wiring	11
1.3.1	Connecting to Peripheral Devices	11
1.3.2	Main Circuit Wiring and Power ON Sequence	14
1.4	Conducting a Test Run	16
1.4.1	Test Run in Two Steps	16
1.4.2	Step 1: Conducting a Test Run for Motor without Load	18
1.4.3	Step 2: Conducting a Test Run with the Motor Connected to the Machine	22
1.4.4	Supplementary Information on Test Run	24
1.4.5	Minimum User Constants Required and Input Signals	25

1.1 Precautions

- This section provides notes on using Σ -Series products.

1.1.1 Notes on Use

1.1.1 Notes on Use

NOTE Always note the following to ensure safe use.

Two types of supply voltage are available, 100 V and 200 V.

Both Σ -Series Servomotor and Servopack have 100 V and 200 V types. Be sure to use the correct type.

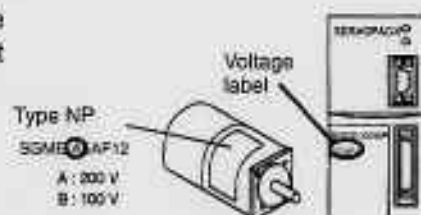

Always use the SGME Servomotor and SGDE Servopack in pairs.

The SGME Servomotor cannot run without the SGDE Servopack. Do not plug the SGME Servomotor directly into the commercial power supply. (Direct connection to the commercial power supply will damage the Servomotor.)

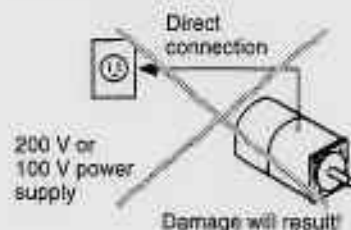

Do not change wiring when power is ON.

Always turn the power OFF before connecting or disconnecting a connector. (Except for Digital Operator (Types: JUSP-OP02A-1, JUSP-OP03A))



Note that residual voltage still remains in the Servopack even after the power is turned OFF.

Even after the power is turned OFF, residual voltage still remains in the capacitor inside the Servopack. If inspection is to be performed after the power is turned OFF, always wait at least 5 minutes to avoid the risk of an electrical shock.

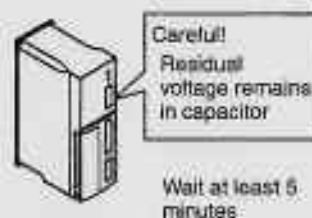

Always follow the specified installation method.

The Servopack generates heat. Install the Servopack so that it can radiate heat freely. Note also that the Servopack must be in an environment free from condensation, vibration and shock.

Provide sufficient clearance

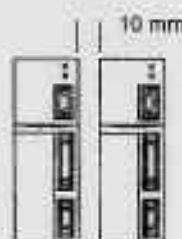

Ambient temperature: 0 to 50°C

Perform noise reduction and grounding properly.

If the signal line is noisy, vibration or malfunction will result.

- Separate high-voltage cables from low-voltage cables.
- Use cables as short as possible.
- Use at least class 3 grounding (ground resistance 100Ω or below) for the Servomotor and Servopack.
- Never use a line filter for the power supply in the motor circuit.

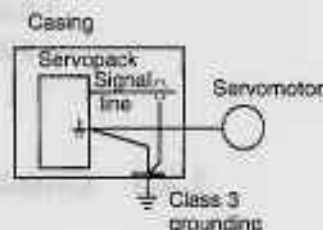
**Conduct a voltage resistance test under the following conditions.**

- Voltage: 1,500 Vrms AC, one minute
- Braking current: 18 mA
- Frequency: 50/60 Hz
- Voltage applied point: Between R, T terminals and frame ground (connect terminals R and T securely.)



Conduct a dielectric strength test as described on the left.

Use a fast-response type ground-fault interrupter.

For a ground-fault interrupter, always use a fast-response type or one designed for PWM inverters. Do not use a time-delay type.

Ground-fault interrupter

GOOD	GOOD	POOR
Fast-response type	For PWM inverter	Time-delay type

Do not perform continuous operation under overhanging load.

Continuous operation cannot be performed by rotating the motor from the load and applying regenerative braking. Regenerative braking by the Servopack can be applied only for a short period, such as the motor deceleration time.

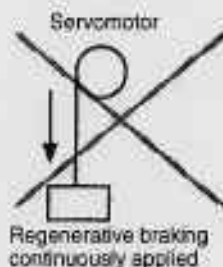

Regenerative braking continuously applied

The Servomotor cannot be operated by turning the power ON and OFF.

Frequently turning the power ON and OFF causes the internal circuit elements to deteriorate. Always start or stop the servomotor by using reference pulses.

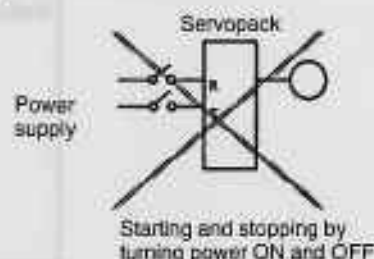

Starting and stopping by turning power ON and OFF

1.2 Installation

This section describes how to check Σ -Series products on delivery and how to install them.

1.2.1	Checking on Delivery	4
1.2.2	Installing the Servomotor	5
1.2.3	Installing the Servopack	8



1.2.1 Checking on Delivery

1) When Σ -Series products are delivered, check the following items:

Check Items	Remarks
Check if the delivered products are the ones you ordered.	Check the types marked on the nameplates of Servomotor and Servopack (see the table below).
Check if the motor shaft rotates smoothly.	If the motor shaft is smoothly turned by hand, it is normal. However, if the motor has brakes, it cannot be turned manually.
Check for damage.	Check the overall appearance, and check for damage or scratches resulting from transportation.
Check screws for looseness.	Check for looseness by using a screwdriver as necessary.

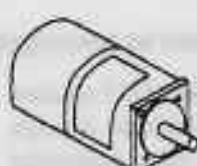
If any of the above items are faulty or incorrect, contact the dealer from which you purchased the products or your nearest local sales representative.

Appearance	Nameplate	Type
 <p>Servo motor</p> <p>Σ-Series SGME Servomotor</p>	<p>Rated output</p> <p>Servomotor type</p> <p>Rated current</p> <p>Rated torque</p> <p>AC SERVO MOTOR SGME-02AF12</p> <p>W200 N=0.63/2.0</p> <p>r/min 3000 1995.06</p> <p>S/N 588022-1-3</p> <p>YAMAWA ELECTRIC CORPORATION JAPAN</p> <p>Serial number</p> <p>Manufacturing date</p> <p>Rated rotation speed</p>	<p>SGME - 01 A F 1 2 □</p> <p>Σ-Series SGME Servomotor</p> <p>Rated Output A3:0.04HP A5:0.07HP D1:0.19HP D2:0.27HP D3:0.40HP D4:0.53HP D5:1.01HP</p> <p>Power supply A:250V B:100V</p> <p>Encoder specifications F: 1024P/R incremental encoder</p> <p>Design revision order</p> <p>Shaft specifications 2: Straight without key 3: Flat key seat 4: Straight with key</p> <p>Option Blank: Standard (W/O brake) B: With brake (90VDC) C: With brake (24VDC)</p>

	Appearance	Nameplate	Type
Servo-pack Σ-Series SGDE Servopack			

1.2.2 Installing the Servomotor

Servomotor SGME type can be installed either horizontally or vertically. However, if the Servomotor is installed incorrectly or in an inappropriate location, the service life will be shortened or unexpected problems will occur. To prevent this, always observe the installation instructions described below.

Before installation:

Anticorrosive paint is coated on the edge of the motor shaft. Clean off the anticorrosive paint thoroughly using a cloth moistened with thinner.

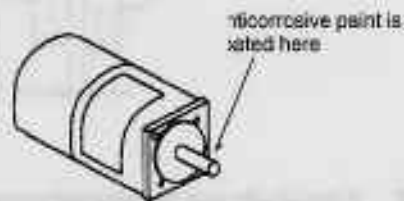

NOTE Avoid getting thinner on other parts of the Servomotor when cleaning the shaft.

Storage:

When the Servomotor is to be stored with the power cable disconnected, store it in the following temperature range:

Between -20°C and 60°C

Installation sites:

The Servomotor SGME type is designed for indoor use. Install Servomotor in an environment which meets the following conditions:

- Free from corrosive and explosive gases
- Well-ventilated and free from dust and moisture
- Ambient temperature of 0 to 40°C
- Relative humidity of 20% to 80% (non-condensing)
- Inspection and cleaning can be performed easily

If the Servomotor is used in a location subject to water or oil mist, install a shield cover over the Servomotor.

Alignment:

Align the shaft of the Servomotor with that of the equipment to be controlled, then connect the shafts with couplings. Install the Servomotor so that alignment accuracy falls within the range shown below.

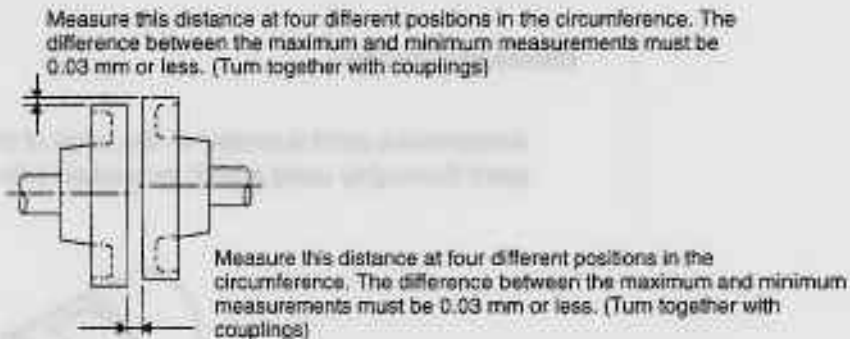

NOTE If the shafts are not aligned properly, vibration will occur, resulting in damage to the bearings.

Mechanical shock to the shaft end must be less than 98m/s² (10G) and must be applied no more than twice.

Design the mechanical system so that **thrust load and radial load** applied to the servomotor shaft end during operation falls within the range shown in the following table.



Thrust load and radial load

1. Thrust load: Shaft-end load applied parallel to the centerline of a shaft
2. Radial load: Shaft-end load applied perpendicular to the centerline of a shaft

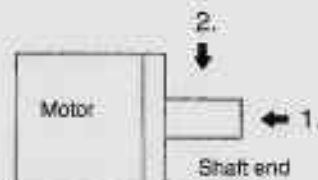

Motor Type	Allowable Radial Load Fr [N(lb)]	Allowable Thrust Load Fs [N(lb)]	Reference Drawing
SGME-A3	68 (15)	54 (12)	
SGME-A5	68 (15)	54 (12)	
SGME-01	78 (17)	54 (12)	
SGME-02	245 (55)	74 (16)	
SGME-03	245 (55)	74 (16)	
SGME-04	245 (55)	74 (16)	
SGME-08	392 (88)	147 (33)	

Note The radial load and thrust load values shown above are the maximum allowed values for the sum of the load generated by motor torque and the load externally applied to the shaft.

1

Installation position	Load
Vertical installation (upward)	Radial load: 68 N (15 lb) Thrust load: 54 N (12 lb)
Vertical installation (downward)	Radial load: 68 N (15 lb) Thrust load: 54 N (12 lb)
Horizontal installation	Radial load: 78 N (17 lb) Thrust load: 54 N (12 lb)
Installation with external load	Radial load: 245 N (55 lb) Thrust load: 74 N (16 lb)
Installation with external load (upward)	Radial load: 245 N (55 lb) Thrust load: 74 N (16 lb)
Installation with external load (downward)	Radial load: 245 N (55 lb) Thrust load: 74 N (16 lb)
Installation with external load (horizontal)	Radial load: 392 N (88 lb) Thrust load: 147 N (33 lb)

1.2.3 Installing the Servopack

Σ-Series SGDE Servopack is a book-shaped compact servo controller.

Incorrect installation will cause problems. Always observe the installation instructions described in the next page.

Storage:

When the Servopack is to be stored with the power cable disconnected, store it in the following temperature range:

Between -20°C and 85°C

Installation sites:

Situation	Notes on Installation
When installed in a control panel	Design the control panel size, unit layout, and cooling method so that the temperature around the periphery of the Servopack does not exceed 50°C .
When installed near a heating unit	Suppress radiation heat from the heating unit and a temperature rise caused by convection so that the temperature around the periphery of the Servopack does not exceed 50°C .
When installed near a source of vibration	Install a vibration isolator underneath the Servopack to prevent it from receiving vibration.
When installed in a place receiving corrosive gases	Corrosive gases do not immediately affect the Servopack but will eventually cause contactor-related devices to malfunction. Take appropriate action to prevent corrosive gases.
Others	Avoid installation in a hot and humid place or where excessive dust or iron powder is present in the air.

Orientation:

Install the Servopack perpendicular to the wall as shown in the figure.

The Servopack must be orientated as shown in the figure because it is designed to be cooled by natural convection.

- Firmly secure the Servopack through three mounting holes.



SGDE Servopack

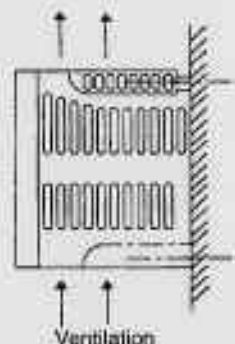

Installation method:

When installing multiple Servopacks side by side in a control panel, observe the following installation method:

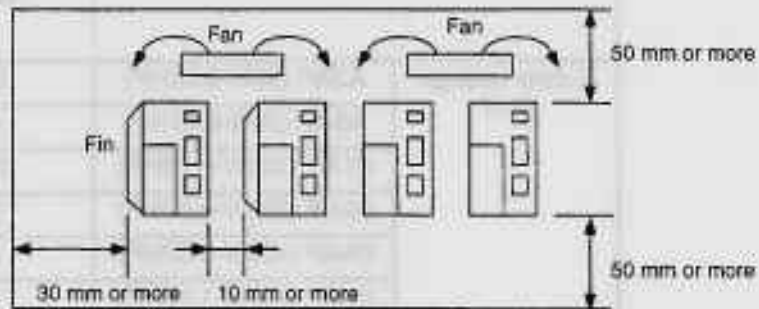

- a) Install Servopack perpendicular to the wall so that the front panel (containing connectors) faces outward.
- b) Provide sufficient space around each Servopack to allow cooling by natural convection.
- c) When installing Servopacks side by side, provide at least 10 mm space between them and at least 50 mm space above and below them as shown in the figure above. Install cooling fans above the Servopacks to prevent the temperature around each Servopack from increasing excessively and also to maintain the temperature inside the control panel evenly.
- d) Maintain the following conditions inside the control panel:
 - Ambient temperature for Servopack: 0 to 50°C
 - Humidity: 90%RH or less
 - Vibration: 0.5G (4.9 m/s²)
 - Condensation and freezing: None
 - Ambient temperature to ensure long-term reliability: 45°C or less

1.2.4 Power Loss

Servopack SGDE-		Output Current (Effective Value) A	Power Loss W
Supply Voltage 200V	A3AP (30W-0.04HP)	0.42	15
	A5AP (50W-0.07HP)	0.6	18
	01AP (100W-0.13HP)	0.87	20
	02AP (200W-0.27HP)	2.0	35
	04AP (400W-0.53HP)	2.6	45
	08AP (750W-1.01HP)	4.4	60
Supply Voltage 100V	A3BP (30W-0.04HP)	0.63	17
	A5BP (50W-0.07HP)	0.9	20
	01BP (100W-0.13HP)	2.2	30
	02BP (200W-0.27HP)	2.7	47
	03BP (300W-0.40HP)	3.7	70

1.3 Connection and Wiring

This section describes how to connect Σ -Series products to peripheral devices and explains a typical example of wiring the main circuit. It also describes an example of connecting to main host controllers.

1.3.1	Connecting to Peripheral Devices	11
1.3.2	Main Circuit Wiring and Power ON Sequence	14

1.3.1 Connecting to Peripheral Devices

- 1) This section shows a standard example of connecting Σ -Series products to peripheral devices and briefly explains how to connect to each peripheral device.
- 2) Before wiring, turn OFF the power switch and post a notice of "No Conduction". Only a qualified electrical technician should perform the wiring.

Standard connection method for Σ -Series AC Servo Drives:

Molded-case circuit breaker (MCCB)

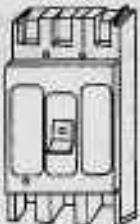

Used to protect power supply line. Shuts the circuit off when overcurrent is detected.

Noise filter



Used to eliminate external noise from power supply line.

Types: LF-205A (for SGDE-A3AP, A5AP, 01AP, 02AP, A5BP, 01BP)
 LF-210 (for SGDE-04AP and 02BP)
 LF-220 (for SGDE-03BP and 08AP)

Magnetic contactor



Turns the servo ON or OFF. Use a surge suppressor for the magnetic contactor.

Type: HI-15E5 (30 A)

Brake power supply

Used for Servomotor with brake.

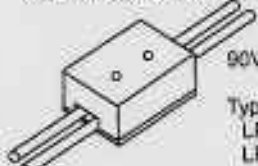

90VDC Specifications

Types:
 LPSE-2H01 (for 200 V input)
 LPDE-1H01 (for 100 V input)

Regenerative unit

Type: JUSP-RG08



Exterior type regenerative resistor

Type: JUSP-RG08C

Digital

Allows the user to set user constants or operation references and display operation status or alarm status. The following two types are available in addition to personal computers:



Mount type (JUSP-OP03A)
 This type can be mounted directly on the Servopack.

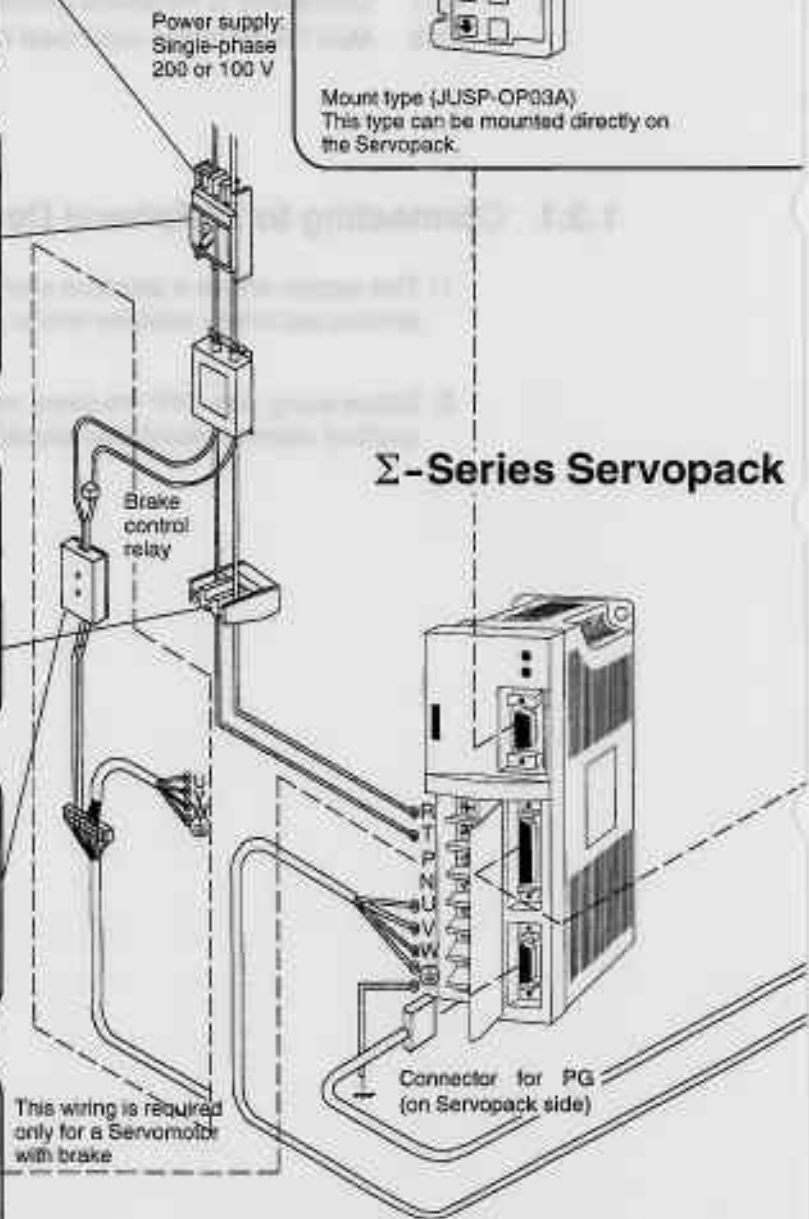

Connector kits for pulse generator (PG) and for motor are not required if the following parts are ordered:

- Cable with terminal connectors
- Cable with connector and amplifier terminal

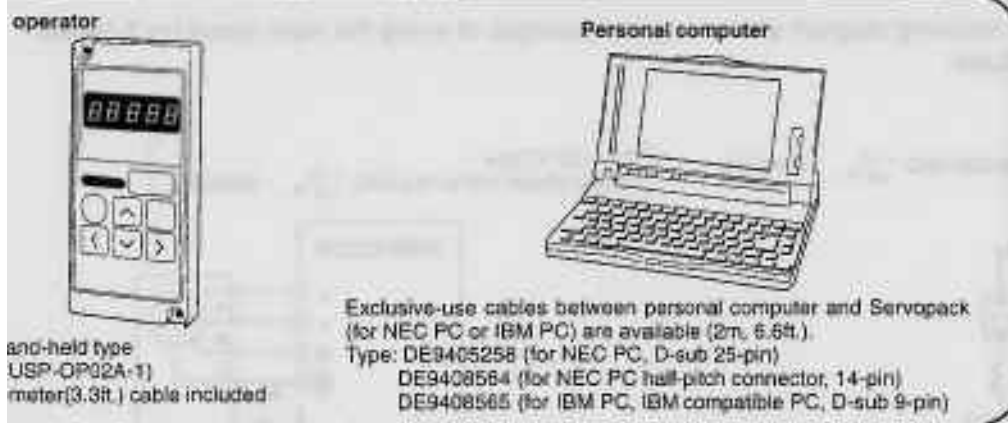

1

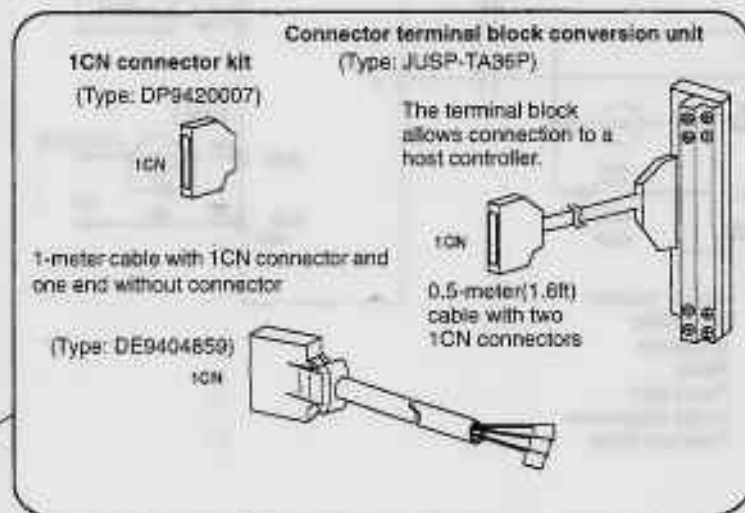
**Cable for PG**

This cable is used to connect a Servomotor encoder to a Servopack.

Cable for incremental encoder (with connector on both ends)

9.8ft: DP9320089-1 16.4ft: DP9320089-2
 32.8ft: DP9320089-3 49.2ft: DP9320089-4
 65.6ft: DP9320089-5

A cable with a single connector (without connector on Servopack side) and a cable without connectors are also available.

Connector kit for PG

This connector kit is required for cables without connectors. For moving parts, a cable for robot must be ordered separately.

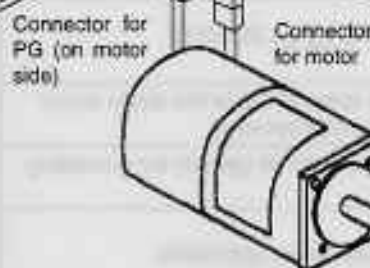
**Cable for motor**

This is a power cable for connecting a Servomotor to a Servopack.

For a Servomotor with brake, this cable is also used to wire the brake.

Without brake (connector and amplifier terminal included)

9.8ft: DP9320081-1 16.4ft: DP9320081-2
 32.8ft: DP9320081-3 49.2ft: DP9320081-4
 65.6ft: DP9320081-5

With brake (connector and amplifier terminal included)

9.8ft: DP9320083-1 16.4ft: DP9320083-2
 32.8ft: DP9320083-3 49.2ft: DP9320083-4
 65.6ft: DP9320083-5

A cable without connector and amplifier terminal is also available.

Connector kit for motor

Connector for motor (on motor side)



This connector kit is required for cables without connector and amplifier terminal.

 Σ -Series Servomotor

1.3.2 Main Circuit Wiring and Power ON Sequence

1) The following diagram shows a typical example of wiring the main circuit for Σ-Series products:

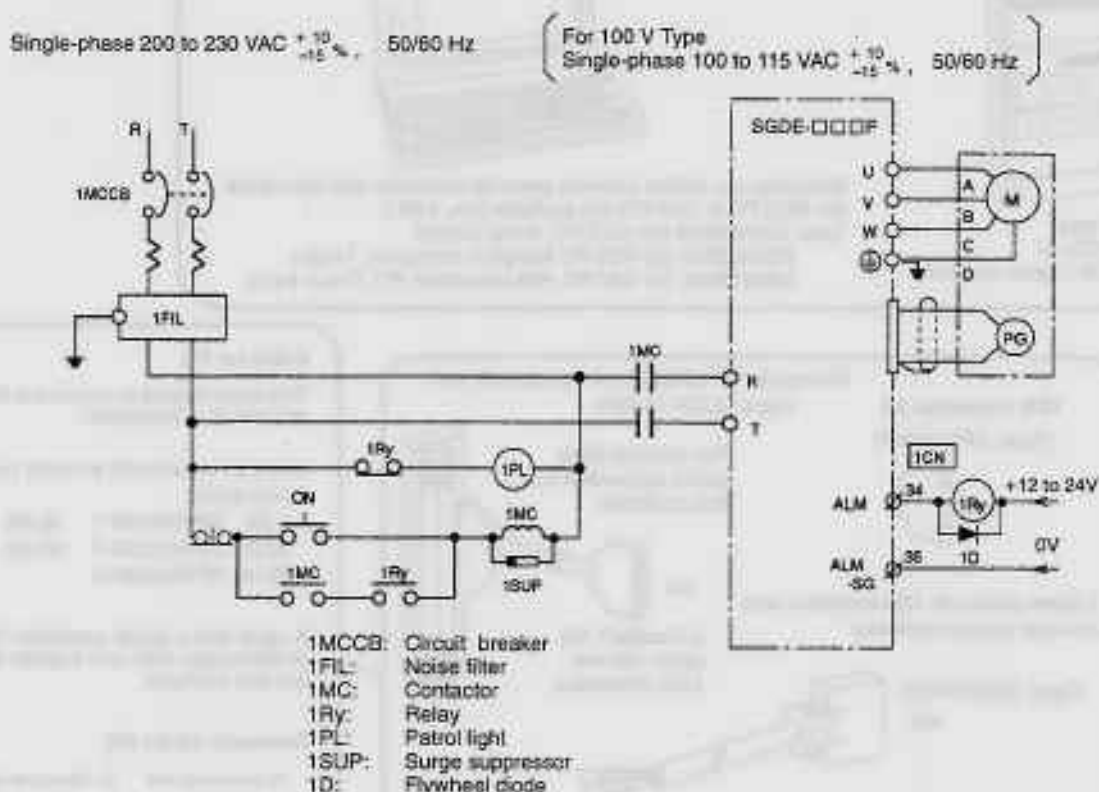

2) The following table shows the name and description of each main circuit terminal:

Terminal Symbol	Name	Description
Ⓡ Ⓣ	Main circuit AC input terminal	Single-phase 200 to 230 VAC $\pm 10\%$ / -15% , 50/60Hz*
Ⓤ Ⓥ Ⓦ	Motor connection terminal	Connect U to the red motor terminal, V to the white motor terminal, and W to the blue motor terminal
Ⓢ	Ground terminal	Connect to the motor ground terminal (green) for grounding purposes.
Ⓟ Ⓠ	Regenerative unit connection terminal	Connect to a regenerative unit when applicable.

* For 100 V power supply: Single-phase 100 to 115 VAC $\pm 10\%$ / -15% , 50/60Hz

- 3) Form a power ON sequence as follows:
- Form a power ON sequence so that the power is turned OFF when a servo alarm signal is output. (See the circuit diagram shown on the previous page.)
 - Hold down the power ON push-button for at least two seconds. The Servopack outputs a servo alarm signal for approximately two seconds or less when the power is turned ON. This operation is required to initialize the Servopack.

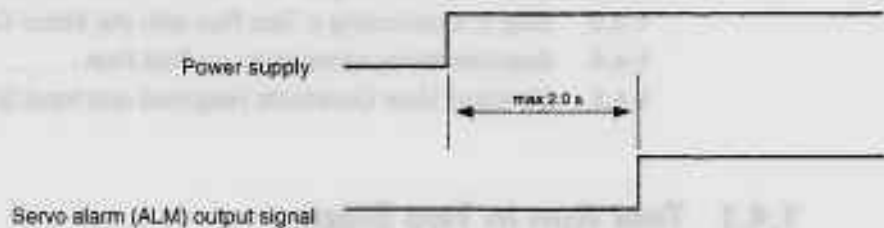

- NOTE**
- After turning the power OFF, do not touch the power terminals for 5 minutes. High voltage may remain in the Servopack.
 - Avoid frequently turning the power ON and OFF. Since the Servopack has a capacitor in the power supply, a high charging current flows (for 0.2 second) when the power is turned ON. Therefore, frequently turning the power ON and OFF causes the main power devices (such as capacitors and fuses) to deteriorate, resulting in unexpected problems.
 - If the Servopack is turned ON immediately after being turned OFF, a power loss alarm may arise. To prevent this, always wait for the time shown in the following table before turning the power ON again:

	Single-phase 200 VAC	Single-phase 100 VAC	Power Holding Time
Servopack Type SGDE-	A3AP, A5AP	A3BP	6 seconds
	01AP, 02AP, 04AP	A5BP, 01BP, 02BP	10 seconds
	08AP	03BP	15 seconds

1.4 Conducting a Test Run

This section describes how to conduct a full test run. The test run is divided into two steps. Complete a test run in step 1 first, then proceed to step 2.

1.4.1	Test Run in Two Steps	16
1.4.2	Step 1: Conducting a Test Run for Motor without Load	18
1.4.3	Step 2: Conducting a Test Run with the Motor Connected to the Machine	22
1.4.4	Supplementary Information on Test Run	24
1.4.5	Minimum User Constants Required and Input Signals	25

1.4.1 Test Run in Two Steps

Conduct the test run when wiring is complete.

Generally, conducting a test run for servo drives can be difficult. However, by following the two steps described below, the test run can be performed safely and correctly.

NOTE To prevent accidents, initially conduct a test run only for a servomotor under no load (i.e., with all couplings and belts disconnected). Do not run the servomotor while it is connected to a machine.

The test run is divided here into steps 1 and 2.

Complete the test run in step 1 first, then proceed to step 2. The purposes of each step are described on the next page.

Step	Purpose
1	Test run for motor without load
2	Test run with motor connected to machine

Step 1: Conducting a test run for the motor without load Check that the motor is wired correctly

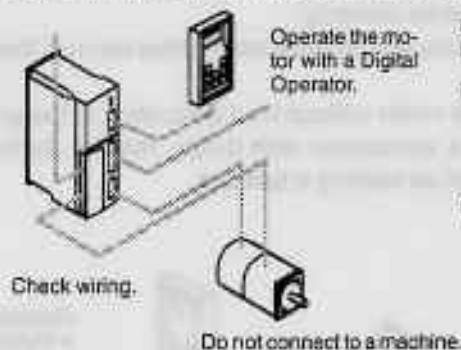

Conduct a test run with the motor shaft disconnected from the machine.

- Purpose:**
- To check power supply circuit wiring
 - To check motor wiring
 - To check I/O signal (1CN) wiring

- Outline:**
- Turn the power ON.
 - Operate the motor with a digital operator.
 - Check I/O signals (1CN).
 - Conduct a test run using I/O signals.

Step 2: Conducting a test run with the motor and machine connected

Adjust Servopack according to machine characteristics.

Connect to the machine and conduct a test run.

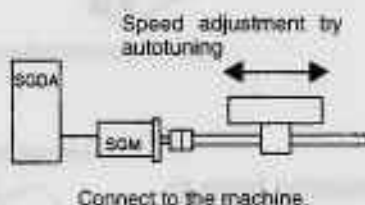

- Purpose:**
- To perform autotuning to adjust the motor according to machine characteristics
 - To match the speed and direction of rotation with the machine specifications
 - To check the final control mode

- Outline:**
- Perform autotuning.
 - Adjust user constant settings.
 - Record user constant settings.

End of test run

For customers who use a servomotor with a brake, refer to *Section 1.4.4 Supplementary Information on Test Run* before starting a test run.

The following pages describe the test run procedure in detail.

1.4.2 Step 1: Conducting a Test Run for Motor without Load

Check that the motor is wired correctly.

If the motor fails to rotate properly during a servo drive test run, the cause most frequently lies in incorrect wiring.

Conduct a test run for the motor without load according to the procedure described below. For customers who use a servomotor with brake, refer to *Section 1.4.4 Supplemental Information on Test Run* before starting a test run.

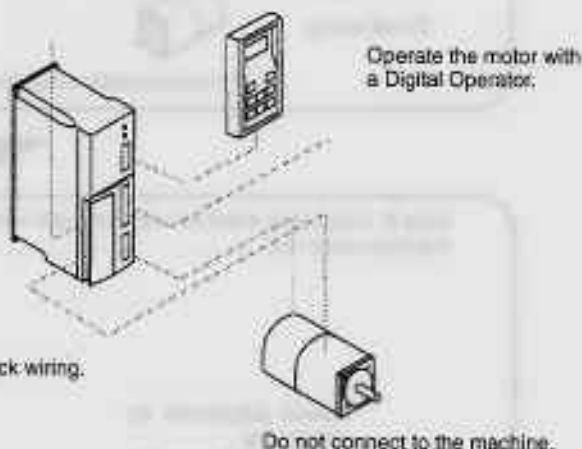

(1) Secure the servomotor.

Secure the servomotor to mounting holes to prevent it from moving during operation. Alternatively, install the servomotor on the machine and disconnect couplings and belts.

Secure servomotor to mounting holes.



(2) Disconnect connector 1CN, then check the motor wiring in the power supply circuit. I/O signals (1CN) are not to be used so leave connector 1CN disconnected.



(3) Short the alarm signal circuit.

Because connector 1CN is disconnected, the alarm signal prevents the power supply circuit from being turned ON. Therefore, temporarily short the alarm signal circuit.

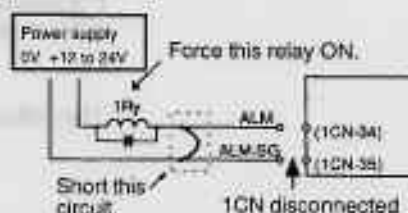

(4) Turn the power ON.

Turn the Servopack power ON. If the Servopack is turned ON normally, the LED on the Digital Operator lights up as shown in the figure.

Power is not supplied to the servomotor because the servo is OFF.

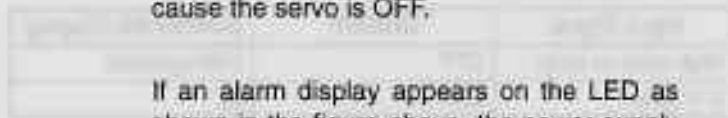

If an alarm display appears on the LED as shown in the figure above, the power supply circuit, motor wiring or encoder wiring is incorrect. In this case, turn the power OFF, then correct the problem.

Normal display



Alternately displayed

Example of alarm display



Refer to Section 5.2 Troubleshooting.

(5) Operate using the Digital Operator

Operate the motor with the Digital Operator. Check that the motor runs normally.

Refer to 3.2.2 Operating Using the Digital Operator.

Operation by Digital Operator



If an alarm occurs, the power supply circuit, motor wiring, or encoder wiring is incorrect.

(6) Connect signal lines.

Connect connector 1CN as follows:

- (1) Turn the power OFF.
- (2) Return the alarm signal circuit shorted in the above step (3) to its original state.
- (3) Connect connector 1CN.
- (4) Turn the power ON again.

After turning the power OFF, remove the short circuit.

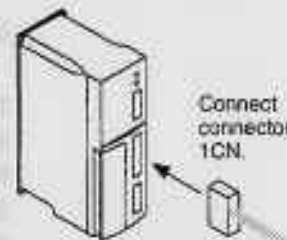
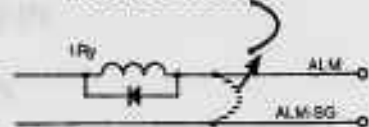

Connect connector 1CN.

(7) Check input signals.

Check the input signal wiring in monitor mode. For the checking method, refer to 3.1.6 Operation in Monitor Mode.

Example of Un-05

Internal status bit display (Un-05, Un-06)



S-ON (1CN-14) P-CON (1CN-17) P-OT (1CN-16) N-OT (1CN-17)

The memory switch can be used to eliminate the need for external short-circuits in wiring (see page 52).

BASIC USES OF Σ-SERIES PRODUCTS

1.4.2 Step 1: Conducting a Test Run for Motor without Load cont.

- Checking method

Turn each connected signal line ON and OFF to check that the monitor bit display changes accordingly.

Input Signal	ON/OFF	Monitor Bit Display
High level or open	OFF	Extinguished
0 V level	ON	Lit

If the signal lines below are not wired correctly, the motor fails to rotate. Always wire them correctly. (If signal lines are not to be used, short them as necessary.)

P-OT	1CN-16	Motor can rotate in forward direction when this input signal is at 0 V.
N-OT	1CN-17	Motor can reverse when this input signal is at 0 V.
S-ON	1CN-14	Servo is turned ON when this input signal is at 0 V. However, leave the servo in OFF status.

- (8) Turn servo (motor) ON.

Turn the servo ON as follows:

- (1) Check that no reference has been input.

PULS (1CN-1) and SIGN (1CN-3) are fixed.

- (2) Turn the servo ON signal ON.

Set S-ON (1CN-14) to 0 V. If normal, the motor is turned ON and the Digital Operator displays the data as shown in the figure. If an alarm display appears, take appropriate action as described in *Section 5.2 Troubleshooting*.

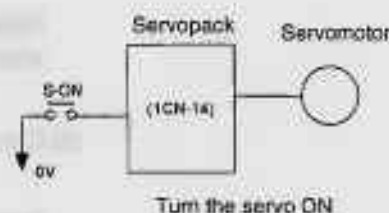

Display when servo is turned ON



- (9) Operate by reference input.

The operating procedures are as follows:

- (1) Set user constant Cn-02 so that the reference pulse form matches the host controller output form. (See page 78 for details on how to set user constants.)

Selecting reference pulse form (See page 34)

Cn-02	Bit 3
	Bit 4
	Bit 5

(2) Input a slow speed pulses from the host controller and execute low-speed operation.

(3) Check the following items in monitor mode (see page 63):



- (1) Has a reference pulse been input?
- (2) Is the motor speed as set?
- (3) Does the reference speed match the actual motor speed?
- (4) Does the motor stop when no reference is input?

Un-00	Actual motor speed
Un-07	Reference pulse speed display
Un-08	Position error

(4) To change motor speed or the direction of rotation, reset the user constants shown below.

Cn-24,Cn-25	Electronic gear ratio (see page 41)
Cn-02 bit 0	Reverse rotation mode (see page 30)

If an alarm occurs or the motor fails to rotate during the above operation, connector 1CN wiring is incorrect or the user constant settings do not match the host controller specifications.

In this case, check the wiring and review the user constant settings, then repeat step 1.

Refer to Appendix C List of User Constants.

This is all that is required to complete step 1 (conducting a test run for motor without load). Whenever possible, perform tuning associated with the host controller and other necessary adjustments in step 1 (before installing the motor on the machine).

1.4.3 Step 2: Conducting a Test Run with the Motor Connected to the Machine

After step 1 is complete, proceed to step 2 in which a test run is conducted with the motor connected to the machine. The purpose of step 2 is to adjust the Servopack according to the machine characteristics.

Conduct a test run according to the procedure described below.

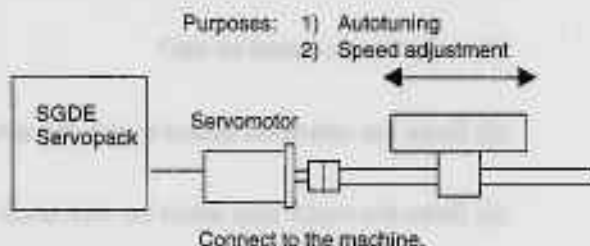

NOTE Before proceeding to step 2, repeat step 1 (conducting a test run for the motor without load) until you are fully satisfied that the test has been completed successfully. Operation faults that arise after the motor is connected to the machine not only damage the machine but may also cause an accident resulting in injury or death. Therefore, all items including user constants setting and wiring should be tested as conclusively as possible before step 1 is complete.

- (1) Check that power is OFF.
Turn the Servopack power OFF.

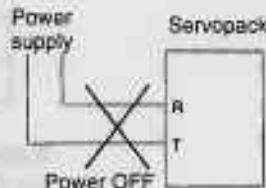

- (2) Connect the servomotor to the machine.
Refer to 1.2.2 *Installing the Servomotor*.

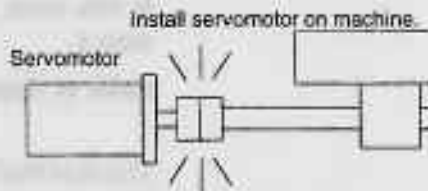

- (3) Perform autotuning.
Tune the Servopack according to the machine characteristics. Refer to 3.2.3 *Autotuning*.

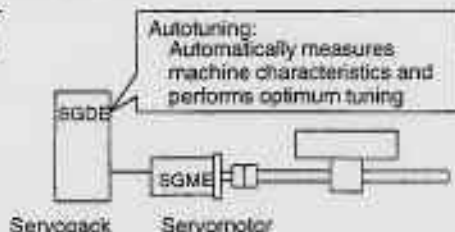

- (4) Operate by reference input.
As in step 1 (conducting a test run for motor without load), perform (9) *Operate by reference input* on page 20. Perform tuning associated with the host controller.

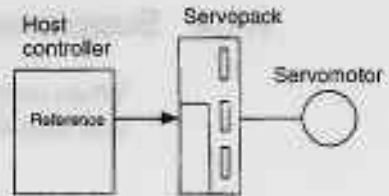

- (5) Set user constants and record the settings.
Set user constants as necessary. Record all the user constant settings for maintenance purposes.

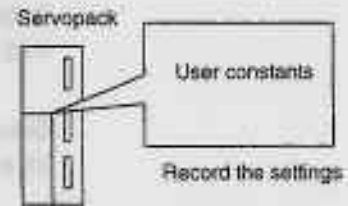

This is all that is required to conduct the test run.

Normally, the machine may cause much friction because of an insufficient running-in period. After a test run is complete, perform adequate running-in.

1.4.4 Supplementary Information on Test Run

When using a servomotor with a brake, always refer to the information described below before starting a test run:

1) When using a servomotor with brake

The brake prevents the motor shaft from rotating due to a backdriving torque. Such a torque may be created by an external force or the force of gravity acting on the load and may result in undesired motion or the load, should motor power be lost.

Servopack uses the brake interlock output (BK) signal to control holding brake operation for a servomotor with brake.

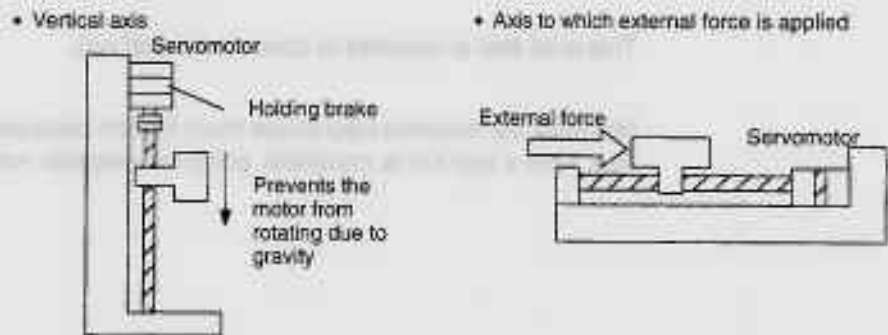

NOTE To prevent faulty operation caused by gravity (or external force), first check that the motor and holding brake operate normally with the motor disconnected from the machine. Then, connect the motor to the machine and conduct a test run.

For wiring of a servomotor with a brake, refer to 2.4.2 Using Holding Brake.

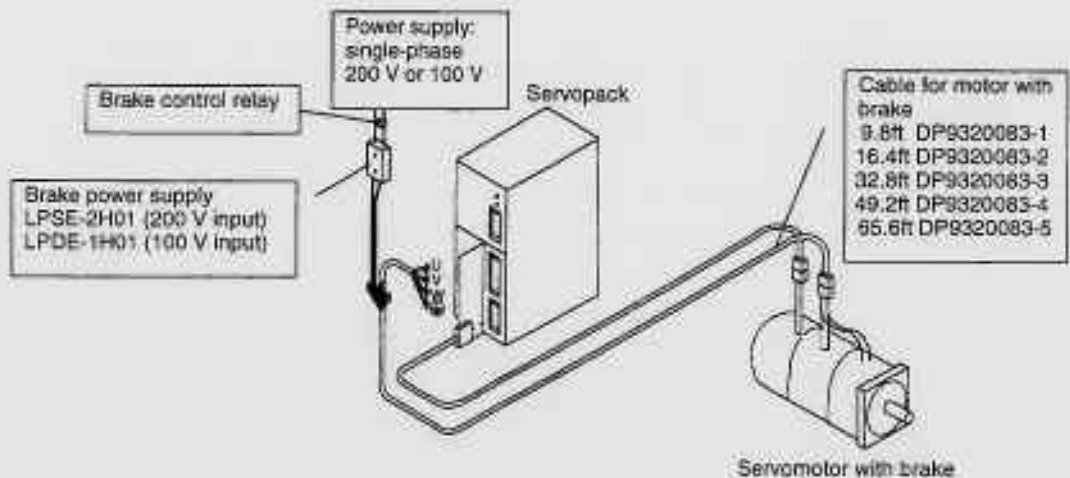

1.4.5 Minimum User Constants Required and Input Signals

- 1) This section describes the minimum user constants that must be set to conduct a test run. For details on how to set each user constant, refer to 3.1.5 *Operation in User Constant Setting Mode*.

Cn-02 bits 3,4,5	Reference pulse form selection
Cn-24	Electronic gear ratio (numerator)
Cn-25	Electronic gear ratio (denominator)

- 2) If the specified direction of rotation differs from the actual direction of rotation, the wiring may be incorrect. In this case, recheck the wiring and correct it accordingly. Then, if the direction of rotation is to be reversed, set the following user constant:

Cn-02 (bit 0)	Reverse rotation mode (see page 30)
---------------	-------------------------------------

After changing the Cn-02 setting, always turn the power OFF, then ON. This makes the new setting valid.

- 3) The following table lists the minimum input signals required to conduct a test run. For details of each input signal, refer to the relevant page.

Signal Name	Pin Number	Function
S-ON (servo ON)	1CN-14	Switching between motor ON and OFF status. The memory switch can be used to eliminate the need for external short-circuit wiring (see page 52).
P-OT (forward rotation prohibited)	1CN-16	Overtravel limit switch The memory switch can be used to eliminate the need for external short-circuit wiring (see page 32).
N-OT (reverse rotation prohibited)	1CN-17	

APPLICATIONS OF Σ -SERIES PRODUCTS

2

This chapter is prepared for readers who wish to learn more about the applications of Σ -series products after fully understanding *Chapter 1 Basic Uses of Σ -series Products*. It explains how to set user constants for each purpose and how to use each function. Read the applicable sections according to your requirements.

2.1	Setting User Constants According to Machine Characteristics	30
2.1.1	Changing the Direction of Motor Rotation	30
2.1.2	Setting the Overtravel Limit Function	31
2.2	Setting User Constants According to Host Controller	33
2.2.1	Inputting Position Reference	33
2.2.2	Using Contact I/O Signals	37
2.2.3	Using Electronic Gear	39
2.3	Setting Up the Σ Servopack	43
2.3.1	Using Autotuning Function	43
2.3.2	Setting Servo Gain	43
2.3.3	Using the Smoothing Function	45
2.3.4	Setting the Torque Reference Filter Time Constant	46
2.4	Setting Stop Mode	47
2.4.1	Dynamic Brake	47
2.4.2	Using Holding Brake	48
2.5	Forming a Protective Sequence	51
2.5.1	Using Servo Alarm Output	51
2.5.2	Using Servo ON Input Signal	52
2.5.3	Using Positioning Complete Signal	53
2.5.4	Handling of Power Failure	54

2.6	Special Wiring	56
2.6.1	Wiring Instructions	56
2.6.2	Wiring for Noise Control	58
2.6.3	Using More Than One Servo Drive	63
2.6.4	Using Regenerative Units	64
2.6.5	Using SGDE Servopack with High Voltage Line	67
2.6.6	Connector Terminal Layouts	69

Chapter 2.6: Special Wiring

This chapter provides detailed instructions for wiring servos and servopacks. It covers topics such as noise control, using multiple servos, regenerative units, and high voltage line connections. The chapter includes diagrams and tables to help you understand the correct wiring configurations for various applications.

2.6.1	Wiring Instructions	56
2.6.2	Wiring for Noise Control	58
2.6.3	Using More Than One Servo Drive	63
2.6.4	Using Regenerative Units	64
2.6.5	Using SGDE Servopack with High Voltage Line	67
2.6.6	Connector Terminal Layouts	69

Before Reading this Chapter

- 1) This chapter describes how to use each 1CN connector I/O signal for the SGDE Servopack and how to set the corresponding user constant.
- 2) For a list of I/O signals of 1CN connector, refer to *Appendix B List of I/O Signals*. For terminal arrangement for I/O signals of 1CN connector, refer to *2.6.6 Connector Terminal Layouts*.

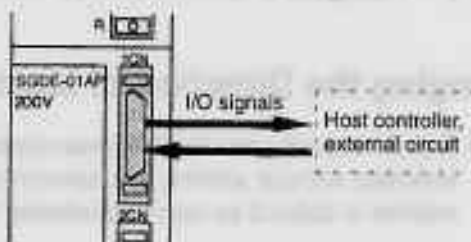

- 3) For a list of user constants, refer to *Appendix C List of User Constants*.
- 4) User constants are divided into the following two types.

1) Memory switch Cn-01 and Cn-02	Set each bit to ON or OFF to select a function.
2) Constant setting Cn-04 and later	Set a numerical value such as speed loop gain.

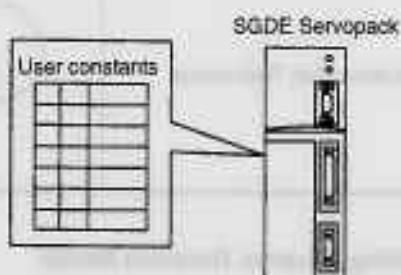

- 5) For details on how to set user constants, refer to *3.1.5 Operation in User Constant Setting Mode*.



2.1 Setting User Constants According to Machine Characteristics

This section describes how to set user constants according to the dimensions and performance of the machine to be used.

2.1.1	Changing the Direction of Motor Rotation	30
2.1.2	Setting the Overtravel Limit Function	31

2.1.1 Changing the Direction of Motor Rotation

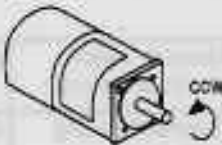
- 1) This Servopack provides a reverse rotation mode in which the direction of rotation can be reversed without altering the servomotor wiring. With the standard setting, forward rotation is defined as counterclockwise (CCW) when viewed from the drive end.
- 2) If reverse rotation mode is used, the direction of motor rotation can be reversed without other items being changed. The direction (+/-) of axial motion is reversed.

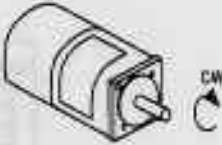
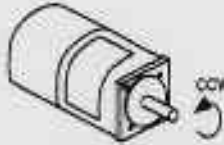
	Standard Setting	Reverse Rotation Mode
Forward Run Reference		
Reverse Run Reference		

3) Setting Reverse Rotation Mode:

Set bit 0 of memory switch Cn-02 to select reverse rotation mode.

Cn-02 Bit 0	Rotation Direction Selection	Factory Setting: 0
-------------	------------------------------	--------------------

Set the direction of rotation.

Setting	Meaning
0	Forward rotation is defined as counterclockwise rotation when viewed from the drive end. (Standard setting)
1	Forward rotation is defined as clockwise rotation when viewed from the drive end. (Reverse rotation mode)

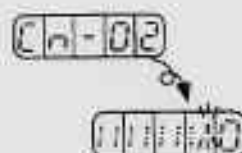

2.1.2 Setting the Overtravel Limit Function

- 1) The overtravel limit function forces the moving part of the machine to stop when it exceeds the movable range. Use the dynamic brake to force the motor to stop.
- 2) To use the overtravel limit function, connect the following input signal terminals correctly.

→ Input P-OT 1CN-16	Forward Rotation Prohibited (Forward Overtravel)
→ Input N-OT 1CN-17	Reverse Rotation Prohibited (Reverse Overtravel)

Inputs terminals for overtravel limit switch.

For linear motion, connect a limit switch to prevent damage to the machine.

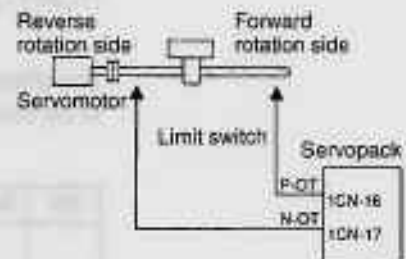

P-OT	ON: 1CN-16 is at low level.	Forward rotation allowed. Normal operation status.
	OFF: 1CN-16 is at high level.	Forward rotation prohibited (reverse rotation allowed).
N-OT	ON: 1CN-17 is at low level.	Reverse rotation allowed. Normal operation status.
	OFF: 1CN-17 is at high level.	Reverse rotation prohibited (forward rotation allowed).

APPLICATIONS OF Σ-SERIES PRODUCTS

2.1.2 Setting the Overtravel Limit Function cont.

- 3) Use the following user constants (memory switch) to specify whether input signals for overtravel are to be used.

Cn-01 Bit 2	Use of P-OT Input Signal	Factory Setting: 0
Cn-01 Bit 3	Use of N-OT Input Signal	Factory Setting: 0

Specifies whether the P-OT input signal for prohibiting forward rotation at overtravel (1CN-16) is to be used and whether the N-OT input signal for prohibiting reverse rotation at overtravel (1CN-17) is to be used.

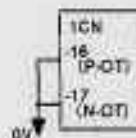

Specifies "1" when external short-circuit wiring is to be omitted.

The short-circuit wiring shown in the figure can be omitted when P-OT and N-OT are not used.

Bit	Setting	Meaning
Bit 2	0	Uses the P-OT input signal for prohibiting forward rotation. (Forward rotation is prohibited when 1CN-16 is open. Forward rotation is allowed when 1CN-16 is at 0 V.)
	1	Does not use the P-OT input signal for prohibiting forward rotation. (Forward rotation is always allowed. This has the same effect as shorting 1CN-16 to 0 V.)
Bit 3	0	Uses the N-OT input signal for prohibiting reverse rotation. (Reverse rotation is prohibited when 1CN-17 is open. Reverse rotation is allowed when 1CN-17 is at 0 V.)
	1	Does not use the N-OT input signal for prohibiting reverse rotation. (Reverse rotation is always allowed. This has the same effect as shorting 1CN-17 to 0 V.)

2.2 Setting User Constants According to Host Controller

This section describes how to connect a Σ -series Servo to a host controller and how to set user constants.

2.2.1	Inputting Position Reference	33
2.2.2	Using Contact I/O Signals	37
2.2.3	Using Electronic Gear	39

2.2.1 Inputting Position Reference

- 1) Input a position reference by using the following input signal "reference pulse input." Since there are several specifications for input signal, select reference input for the system to be created.

Inputs a move reference by pulse input.

Position reference can correspond to the following three types of output form:

- Line driver output
- +12V Open collector output
- +5V Open collector output

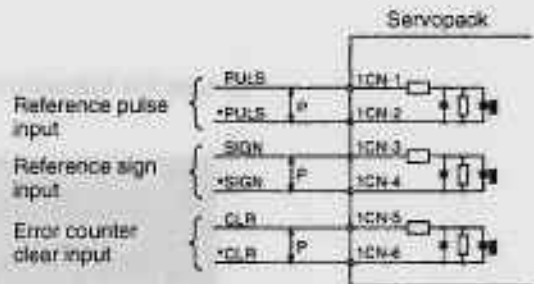

‡P: Represents twisted-pair cables

Connection Example 1: Line Driver Output

Line Driver Used:

SN75174 manufactured by Texas Instruments Inc., or MC3487 or equivalent.

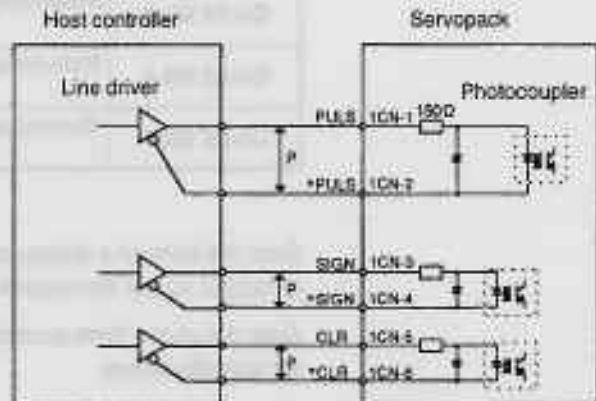

Connection Example 2: Open Collector Output

Sets the value of limiting resistor R1 so that input current i falls within the following range:

Input Current i : 7 to 15 mA

Examples:

- When V_{cc} is 12 V, $R1 = 1\text{ k}\Omega$
- When V_{cc} is 5 V, $R1 = 180\ \Omega$

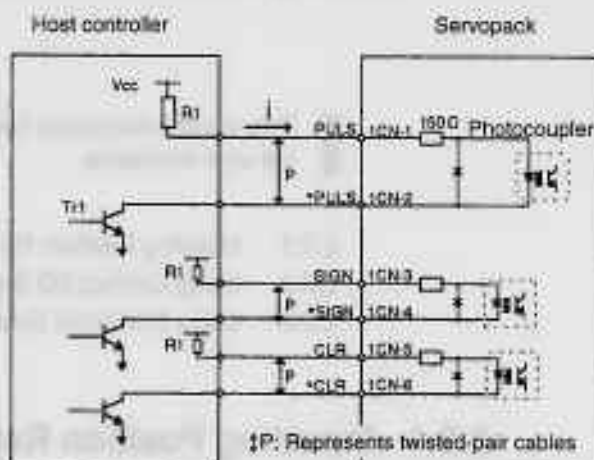

Note The signal logic for open collector output is as follows.

When Tr1 is ON	Equivalent to high level input
When Tr1 is OFF	Equivalent to low level input

2) Use the following memory switch to select the reference pulse form to be used:

→ Input PULS	1CN-1	Reference Pulse Input
→ Input *PULS	1CN-2	Reference Pulse Input
→ Input SIGN	1CN-3	Reference Sign Input
→ Input *SIGN	1CN-4	Reference Sign Input

The motor only rotates at an angle proportional to the input pulse.

Cn-02 Bit 3	Reference Pulse Form Selection	Factory Setting: 0
Cn-02 Bit 4	Reference Pulse Form Selection	Factory Setting: 0
Cn-02 Bit 5	Reference Pulse Form Selection	Factory Setting: 0

Sets the form of a reference pulse that is external output to the Servopack.

Sets the pulse form according to the host controller specifications.

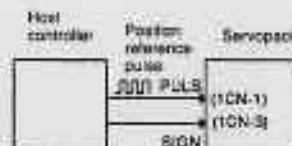

Cn-02			Input Pulse Multiplier	Reference Pulse Form	Motor Forward Run Reference	Motor Reverse Run Reference
Bit 5	Bit 4	Bit 3				
0	0	0	/	Sign + pulse train		
0	1	0	×1	Two-phase pulse train with 90° phase difference		
0	1	1	×2			
1	0	0	×4			
0	0	1	/	CW pulse + CCW pulse		

Input Pulse Multiply Function:

When the reference form is two-phase pulse train with 90° phase difference, the input pulse multiply function can be used.

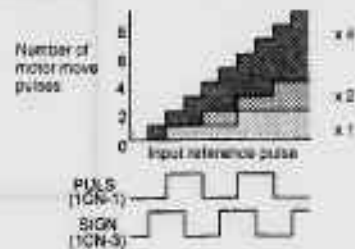

The electronic gear function can also be used to convert input pulses.

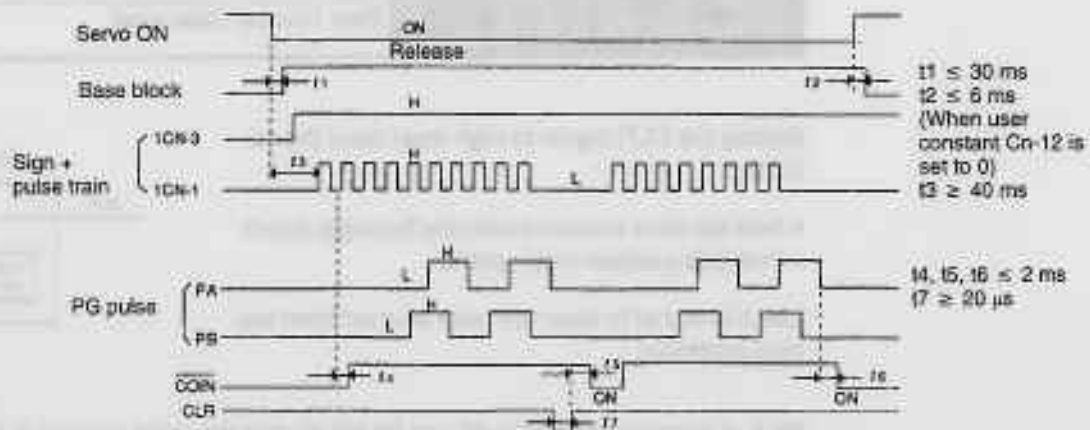
Example of I/O Signal Generation Timing

Note The interval from the time the servo ON signal is turned ON until a reference pulse is input must be at least 40 ms. Otherwise, the reference pulse may not be input. The error counter clear (CLR) signal must be ON for at least 20 μ s. Otherwise, it becomes invalid.

Allowable Voltage Level and Timing for Reference Pulse Input

Reference Pulse Form	Electrical Specifications	Remarks
Sign + pulse train input (SIGN + PULS signal) Maximum reference frequency: 225 kpps	<p> $T_1, T_2 \leq 0.1 \mu s$ $T \geq 1.1 \mu s$ $T_3, T_4 \leq 0.1 \mu s$ $T_4, T_5, T_6 > 3 \mu s$ </p>	The signs for each reference pulse are as follows: ⊕: High level ⊖: Low level
90° different two-phase pulse train (phase A + phase B)	<p> $T_1, T_2 \leq 0.1 \mu s$ $T \geq 1.1 \mu s$ $T < 100 \leq 60\%$ </p>	User constant Cn-02 (bits 3, 4 and 5) is used to switch the input pulse multiplier mode.
CCW pulse + CW pulse Maximum reference frequency: 225 kpps	<p> $T_1, T_2 \leq 0.1 \mu s$ $T \geq 1.1 \mu s$ $T_3, T_4 \leq 0.1 \mu s$ $T > 3 \mu s$ $T < 100 \leq 50\%$ </p>	

3) The following describes how to clear the error counter.

→ Input CLR 1CN-5	Error Counter Clear Input
→ Input ∴CLR 1CN-6	Error Counter Clear Input

Setting the CLR signal to high level does the following:

- Sets the error counter inside the Servopack to 0.
- Prohibits position loop control.

Use this signal to clear the error counter from the host controller.



Bit A of memory switch Cn-02 can be set so that the error counter is cleared only once when the leading edge of an input pulse rises.

Cn-02 Bit A	Error Counter Clear Signal Selection	Factory Setting: 0
-------------	--------------------------------------	--------------------

Selects the pulse form of error counter clear signal CLR (1CN-5).

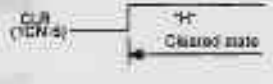
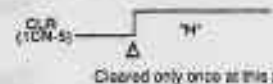
Setting	Meaning	
0	Clears the error counter when the CLR signal is set at high level. Error pulses do not accumulate while the signal remains at high level.	
1	Clears the error counter only once when the rising edge of the CLR signal rises.	

2.2.2 Using Contact I/O Signals

1) Contact Input Signal Terminal Connections

These signals are used to control SGDE Servopack operation. Connect these signal terminals as necessary.

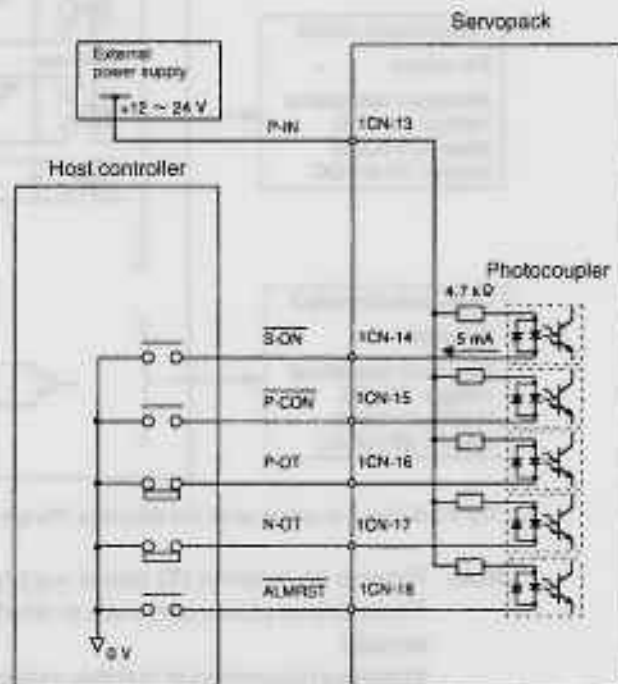

Note Provide an external I/O power supply separately. There are no power terminals to which the SGDE Servopack outputs signals externally.

External Power Supply: +12 to 24 VDC
30 mA or more

Yaskawa recommends that this external power supply be the same type as for the output circuit.

→ Input P-IN 1CN-13

I/O Power Supply

This external power supply input terminal is common to the following contact input signals:

- Contact Input Signals:**
- S-ON (1CN-14)
 - P-CON (1CN-15)
 - P-OT (1CN-16)
 - N-OT (1CN-17)
 - ALMRST (1CN-18)

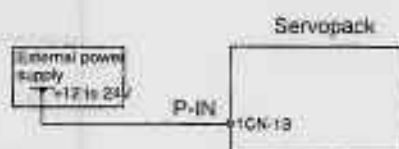

Connect an external I/O power supply.

2) Contact Output Signal Terminal Connections

These output signals are used to indicate SGDE Servopack operation status.

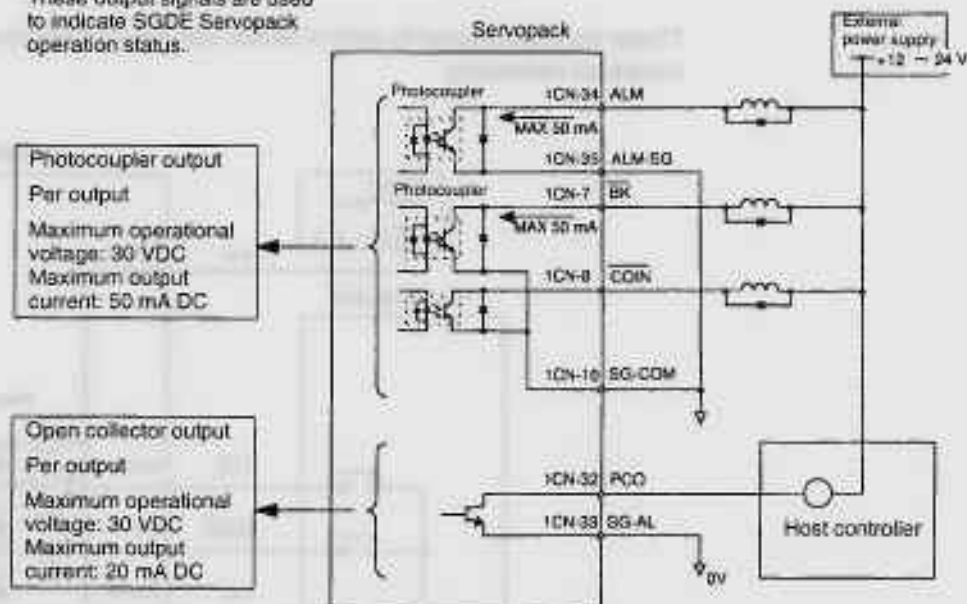

Photocopier output
Per output
Maximum operational voltage: 30 VDC
Maximum output current: 50 mA DC

Open collector output
Per output
Maximum operational voltage: 30 VDC
Maximum output current: 20 mA DC

The PCO phase is output when the transistor (Tr) turns OFF at phase C.

Note Provide an external I/O power supply separately.
There are no power terminals to which the SGDE Servopack outputs signals externally.
Yaskawa recommends that this external power supply be the same type as for the input circuit.

Output → SG-COM 1CN-10

Output Signal Ground Common

This signal ground is used for the following output signals. Connect to 0 V on the external power supply.

- Contact Output Signals:**
- BK (1CN-7)
 - COIN (1CN-8)

2.2.3 Using Electronic Gear

1) Outline

The electronic gear function enables the motor travel distance per input reference pulse to be set to any value. It allows the host controller to perform control without having to consider the machine gear ratio and the number of encoder pulses.

When Electronic Gear Function is Not Used

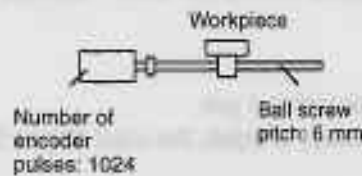

To move a workpiece 10 mm,

One revolution is equivalent to 6 mm, so
 $10 \div 6 = 1.6666$ (revolutions)
 1024 x 4 (pulses) is equivalent to one revolution, so
 $1.6666 \times 1024 \times 4 = 6827$ (pulses)

A total of 6827 pulses must be input as a reference, the host controller needs to make this calculation.

When Electronic Gear Function is Used

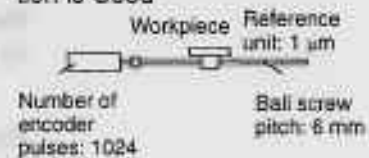

Machine conditions and reference unit must be defined for the electronic gear function beforehand.

To move a workpiece 10 mm:
 Reference unit is 1 μm, so
 $10 \text{ mm} \rightarrow 1 \mu\text{m} = 10,000$ pulses

2) Setting the Electronic Gear

Calculate the electronic gear ratio (B/A) according to the procedure below and set the value in Cn-24 and Cn-25.

a) Check the machine specifications.

Items related to electronic gear:

- Gear ratio
- Ball screw pitch
- Pulley diameter

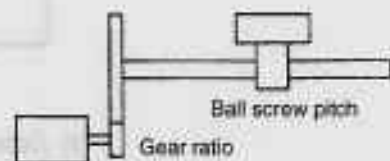

- b) Determine the reference unit to be used.

Reference unit is the minimum unit of position data used for moving the load. (Minimum unit of reference from host controller)

**Examples:
0.01 mm, 0.001 mm, 0.1°, 0.01 inch**

Reference input of one pulse moves the load by one reference unit.

Example: When reference unit is 1 μm
If a reference of 50000 pulses is input, the load moves 50 mm (50,000 x 1 μm).

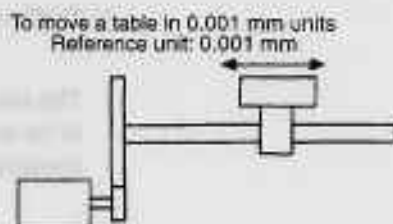

Determine the reference unit according to machine specifications and positioning accuracy.

- c) Determine the load travel distance per revolution of load shaft in reference units.

$$\text{Load travel distance per revolution of load shaft (in reference units)} = \frac{\text{Load travel distance per revolution of load shaft (in unit of distance)}}{\text{Reference unit}}$$

**Example: When ball screw pitch is 5 mm and reference unit is 0.001 mm
5/0.001 = 5,000 (reference units)**

Ball Screw	Disc Table	Belt & Pulley

- d) Determine the electronic gear ratio $\left(\frac{B}{A}\right)$.

If the load shaft makes "n" revolutions when the motor shaft makes "m" revolutions, the gear ratio of motor shaft and load shaft is $\frac{n}{m}$.

$$\text{Electronic gear ratio } \left(\frac{B}{A}\right) = \frac{\text{Number of encoder pulses} \times 4}{\text{Travel distance per revolution of load shaft (in reference units)}} \times \frac{n}{m}$$

SGME Servomotor number of encoder pulses: 1024

NOTE Make sure that the electronic gear ratio meets the following condition:

$$0.01 \leq \text{Electronic gear ratio } \left(\frac{B}{A}\right) \leq 100$$

If the electronic gear ratio is outside this range, the Servopack does not work properly. In this case, modify the load configuration or reference unit.

e) Set the electronic gear ratio in the user constants below.

Reduce the electronic gear ratio $\left(\frac{B}{A}\right)$ to their lowest terms so that both A and B are an integer smaller than 65535, then set A and B in the following user constants.

$\left(\frac{B}{A}\right)$	Cn-24	RATB	Electronic gear ratio (numerator)
	Cn-25	RATA	Electronic gear ratio (denominator)

This is all that is required to set the electronic gear.

Cn-24	RATB Electronic Gear Ratio (Numerator)	Unit: None	Setting Range: 1 to 65535	Factory Setting: 4
Cn-25	RATA Electronic Gear Ratio (Denominator)	Unit: None	Setting Range: 1 to 65535	Factory Setting: 1

$$\text{Electronic gear ratio } \left(\frac{B}{A}\right) = \frac{\text{Cn-24}}{\text{Cn-25}}$$



$$B = [(\text{Number of encoder pulses}) \times 4] \times [\text{Motor shaft rotating speed}]$$

$$A = [\text{Reference unit (load travel distance per revolution of load shaft)}] \times [\text{Load shaft rotating speed}]$$

Note that the user constant settings must meet the following condition:

$$0.01 \leq \left(\frac{B}{A}\right) \leq 100$$

3) Examples of Setting an Electronic Gear Ratio for Different Load Mechanisms

Ball Screw

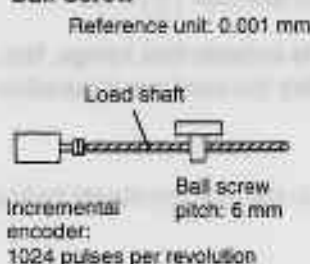

$$\text{Travel distance per revolution of load shaft} = \frac{6\text{mm}}{0.001\text{mm}} = 6000$$

$$\text{Electronic gear ratio} \left(\frac{B}{A}\right) = \frac{1024 \times 4 \times 1}{6000 \times 1} = \frac{Cn-24}{Cn-25}$$

Preset values	Cn-24	4096
	Cn-25	6000

Disc Table

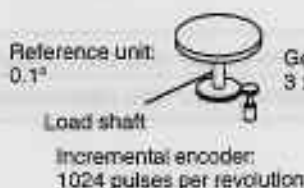

$$\text{Travel distance per revolution of load shaft} = \frac{360^\circ}{0.1^\circ} = 3600$$

$$\text{Electronic gear ratio} \left(\frac{B}{A}\right) = \frac{1024 \times 4 \times 3}{3600 \times 1} = \frac{Cn-24}{Cn-25}$$

Preset values	Cn-24	12288
	Cn-25	3600

Belt & Pulley

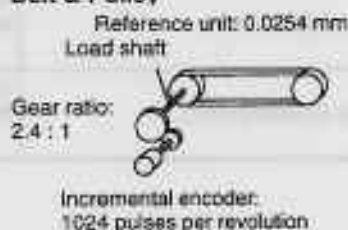

$$\text{Travel distance per revolution of load shaft} = \frac{3.14 \times 100\text{mm}}{0.0254\text{mm}} = 12362$$

$$\text{Electronic gear ratio} \left(\frac{B}{A}\right) = \frac{1024 \times 4 \times 2.4}{12362 \times 1} = \frac{Cn-24}{Cn-25}$$

$$= \frac{9830.4}{12362} = \frac{49152}{61810}$$

Preset values	Cn-24	49152
	Cn-25	61810

4) Control Block Diagram for SGDE-□□□P Servopack for Position Control

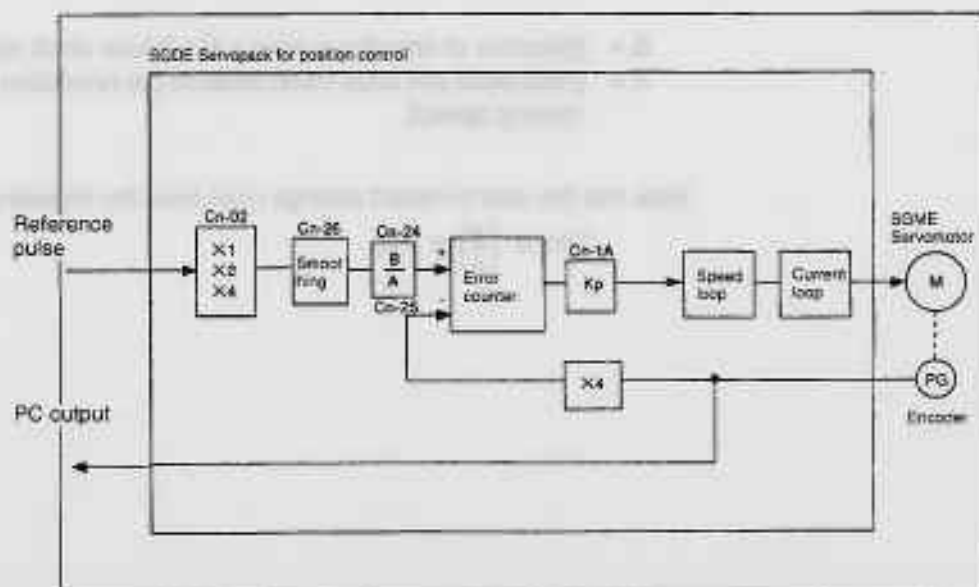

2.3 Setting Up the Σ Servopack

This section describes how to set user constants to operate the SGDE Servopack.

2.3.1	Using Autotuning Function	43
2.3.2	Setting Servo Gain	43
2.3.3	Using the Smoothing Function	45
2.3.4	Setting the Torque Reference Filter Time Constant	46

2.3.1 Using Autotuning Function

- 1) If speed loop gain and position loop gain for the servo system are not set properly, positioning may become slow. Techniques and experience are required to set these servo gain values according to machine configuration and machine rigidity.
- 2) Σ -series Servopacks have an autotuning function that automatically measures machine characteristics and sets the necessary servo gain values. With this function, even first-time servo users can easily perform tuning for servo gain. Servo gain values are set in user constants.
- 3) The following user constants can be automatically set by the autotuning function.

User Constant	Meaning
Cn-04	Speed loop gain
Cn-05	Speed loop integration time constant
Cn-1A	Position loop gain

- 4) For details of how to perform autotuning, refer to 3.2.3 *Autotuning*

2.3.2 Setting Servo Gain

- 1) Check and reset the servo gain when:
 - a) Automatically set servo gain values need to be checked after autotuning.
 - b) Each servo gain value checked in a) is to be directly set for another Servopack.
 - c) Response performance needs to be further enhanced after autotuning, or servo gain values need to be reset for a system with lower response performance.

2) Set the following user constants related to speed loop as necessary.

Cn-04	LOOPHZ Speed Loop Gain (Kv)	Unit: Hz	Setting Range: 1 to 2000	Factory Setting: 80
Cn-05	PITIME Speed Loop Integration Time Constant (Ti)	Unit: ms	Setting Range: 2 to 10000	Factory Setting: 20

Cn-04 and Cn-05 are a speed loop gain and an integration time constant for the Servopack, respectively.

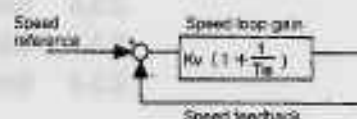

The higher the speed loop gain value or the smaller the speed loop integration time constant value, the higher the speed control response. There is, however, a certain limit depending on machine characteristics.

Factory setting of speed loop gain is PI control as shown above. P control and PI control can be switched by P-CON (1CN-15).

P-CON is OFF	PI Control
P-CON is ON	P Control

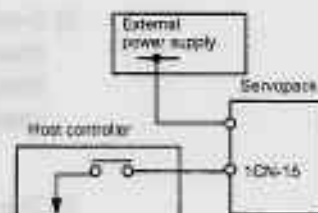

These user constants are automatically set by the autotuning function.

3) Set the following user constants related to position loop as necessary.

Cn-1A	POSGN Position Loop Gain (Kp)	Unit: 1/s	Setting Range: 1 to 200	Factory Setting: 40
-------	----------------------------------	--------------	-------------------------------	---------------------------

This user constant is a position loop gain for the Servopack.

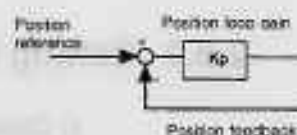

Increasing the position loop gain value provides position control with higher response and less error. However, there is a certain limit depending on machine characteristics.

This user constant is automatically set by the autotuning function.

OVERLV Overflow	Unit: 256 References	Factory Setting: 1024
--------------------	----------------------	-----------------------

The error pulse level at which a position error pulse overflow alarm (alarm A.31) is detected is as shown on the right.



2.3.3 Using the Smoothing Function

- The smoothing function adjusts constant-frequency reference input inside the Servopack so that acceleration and deceleration can be as constant as possible. To use this function, set the following user constant.

Cn-26	ACCTME	Position Reference Acceleration/Deceleration Time Constant (Smoothing)	Unit: 0.1 ms	Setting Range: 0 to 640	Factory Setting: 0
-------	--------	--	--------------	-------------------------	--------------------

This function performs acceleration/deceleration processing for input reference pulses (primary lag characteristics).

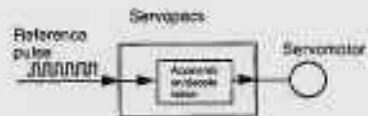

This function prevents the motor from running at progressive speeds in the following cases:

- When the host controller which outputs references cannot perform acceleration/deceleration processing
- When reference pulse frequency is too low
- When reference electronic gear ratio is too high (more than 10 times)

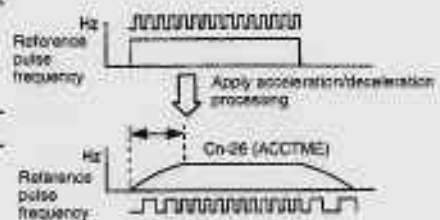

This function does not change the travel distance (number of pulses).

2.3.4 Setting the Torque Reference Filter Time Constant

- 1) If the machine causes vibration, possibly resulting from the servo drive, adjust the following filter time constant. Vibration may stop.

Cn-17	TRQFIL Torque Reference Filter Time Constant	Unit: 100 μ s	Setting Range: 0 to 250	Factory Setting: 4	For Speed/Torque Control and Position Control
--------------	--	----------------------	-------------------------------	--------------------------	---

Cn-17 is a torque reference filter time constant for the SGDE Servopack. The smaller the value, the higher the torque control response. There is, however, a certain limit depending on machine conditions.

With the standard setting, the machine may cause vibration resulting from the servo drive. In this case, increase the constant setting. Vibration may stop. Vibration can be caused by incorrect gain adjustment, machine problems and so on.

2.4 Setting Stop Mode

This section describes how to stop the motor properly.

3.4.1	Dynamic Brake	47
3.4.2	Using Holding Brake	48

2.4.1 Dynamic Brake

1) The Servopack enters servo OFF status when:

- Servo ON input signal (S-ON, 1CN-14) is turned OFF
- Servo alarm occurs
- Power is turned OFF

Then, stops the servomotor by **dynamic brake (DB)**



Dynamic brake (DB)

One of the general methods to cause a motor sudden stop. "Dynamic brake" suddenly stops a servomotor by shorting its electrical circuit.

This dynamic brake circuit is incorporated in the Servopack.

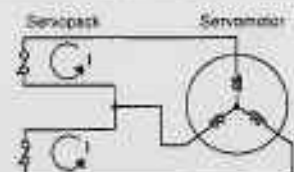

2.4.2 Using Holding Brake

1) Outline

Holding brake is useful when a servo drive is used to control a vertical axis. A servomotor with brake prevents the movable part from dropping due to gravitation when the system power is turned OFF.

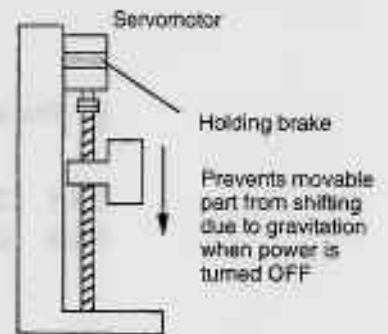

NOTE The built-in brake in Servomotor with brake is a de-energization operation type, which is used for holding purposes only and cannot be used for braking purposes. Use the holding brake only to retain a stopped motor. Brake torque is more than 100% of the rated motor torque.

- 2) Use Servopack contact output-signal \overline{BK} and brake power supply to form a brake ON/OFF circuit.

An example of standard wiring is shown below.

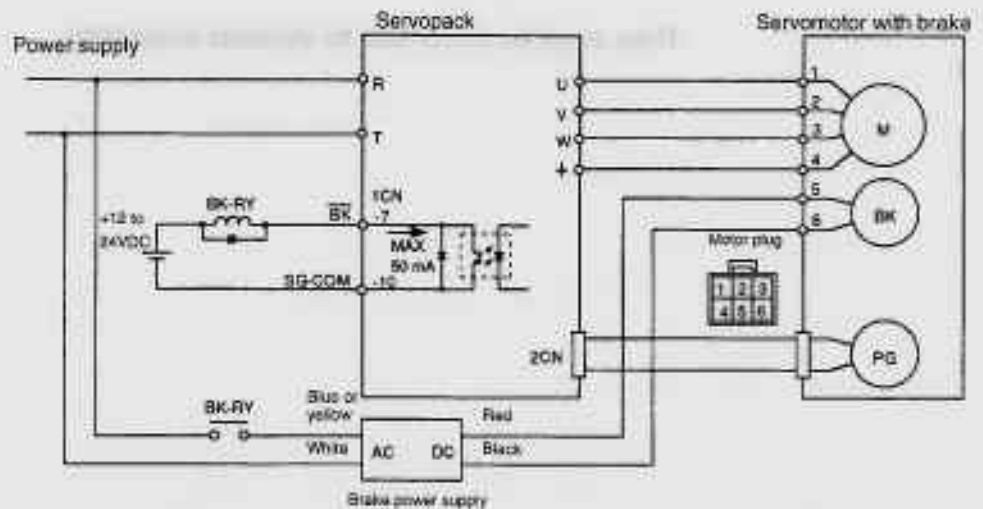

BK-RY: Brake control relay

Brake power supply has two types (200 V, 100 V).

Output → BK 1CN-7 Brake Interlock Output

This output signal controls the brake when a motor with brake is used. This signal terminal need not be connected when a motor without brake is used.

Related User Constants

Cn-12	Time delay from brake signal until servo OFF
Cn-15	Speed level for brake signal output during operation
Cn-16	Output timing of brake signal during motor operation

ON Status: Circuit between 1CN-7 and 1CN-10 is closed. 1CN-7 is at low level.	Releases the brake.
OFF Status: Circuit between 1CN-7 and 1CN-10 is open. 1CN-7 is at high level.	Applies the brake.

Output → SG-COM 1CN-10 Output Signal Ground Common

This is a signal ground for the output signals shown below. Connect this signal terminal to 0 V on the external power supply.

Contact Output Signals: \overline{BK} (1CN-7)
COIN (1CN-8)

- 3) If the machine moves slightly due to gravity when the brake is applied, set the following user constant to adjust brake ON timing:

Cn-12	BRKTIM	Time delay from the time a brake signal is output until servo OFF status occurs	Unit: 10 ms	Setting Range: 0 to 50	Factory Setting: 0
-------	--------	---	-------------	------------------------	--------------------

This user constant is used to set output timing of brake control signal BK (1CN-7) and servo OFF operation (motor output stop) when SGME/SGMEP Servomotor with brake is used.

Brake Timing when Motor is in Stopped Status



2.4.2 Using Holding Brake cont.

With the standard setting, the servo is turned OFF when BK signal (brake operation) is output. The machine may move slightly due to gravitation. This movement depends on machine configuration and brake characteristics. If this happens, use this user constant to delay servo OFF timing to prevent the machine from moving.

Set in this constant the brake ON timing used when the motor is in stopped status.

For brake ON timing during motor operation, use Cn-15 and Cn-16.

- 4) Set the following user constants to adjust brake ON timing so that holding brake is applied when the motor stops.

BRKSPD	Speed Level at which Brake Signal is Output during Motor Operation	Unit: r/min	Setting Range: 0 to Maximum Speed	Factory Setting: 100
BRKWAI	Output Timing of Brake Signal during Motor Operation	Unit: 10 ms	Setting Range: 10 to 100	Factory Setting: 50

Use these user constants to set brake timing used when the servo is turned OFF by input signal S-ON (1CN-14) or alarm occurrence during motor rotation.

Brake for SGME Servomotor is designed as holding brakes. Therefore, brake ON timing when the motor stops must be appropriate. Adjust the user constant settings while observing machine operation.

Brake Timing when Motor is in Stopped Status

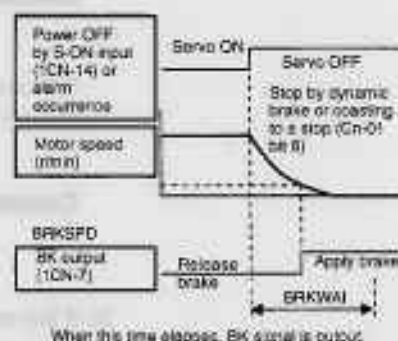

- Conditions for BK signal (1CN-7) output during motor operation. The circuit between 1CN-7 and 1CN-10 is opened in either of the following situations.

1	Motor speed drops below 100 r/min after servo OFF occurs.
2	500 ms has elapsed after servo OFF occurred.

2.5 Forming a Protective Sequence

This section describes how to use I/O signals from the Servopack to form a protective sequence for safety purposes.

2.5.1	Using Servo Alarm Output	51
2.5.2	Using Servo ON Input Signal	52
2.5.3	Using Positioning Complete Signal	53
2.5.4	Handling of Power Failure	54

2.5.1 Using Servo Alarm Output

1) Basic Wiring for Alarm Output Signals

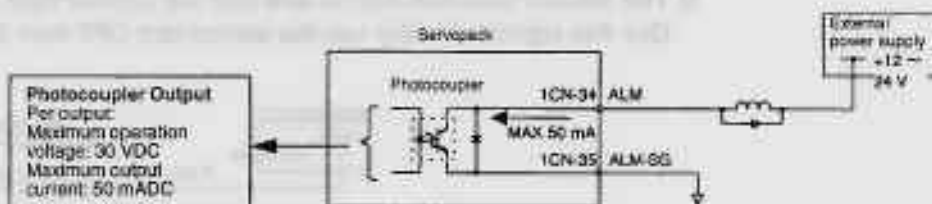

Provide an external I/O power supply separately. There are no DC power available from Servopack for output signals.

2) Contact Output Signal ALM

Output → ALM 1CN-34	Servo Alarm Output
Output → ALM-SG 1CN-35	Signal Ground for Servo Alarm Output

Signal ALM is output when the Servopack detects an alarm.

Form an external circuit so that this alarm output (ALM) turns the Servopack OFF.

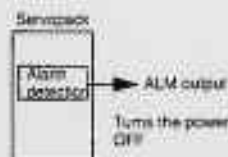

ON status:	Circuit between 1CN-34 and 1CN-35 is closed. 1CN-34 is at low level.	Normal state
OFF status:	Circuit between 1CN-34 and 1CN-35 is open. 1CN-34 is at high level.	Alarm state

3) When the servo alarm (ALM) is output, eliminate the cause of the alarm and set the following ALMRST input signal at high level (+12 to 24VDC) to reset the alarm state.

→ Input ALMRST 1CN-18	Alarm Reset
------------------------------	-------------

2.5.2 Using Servo ON Input Signal

This signal is used to reset the servo alarm state.

Normally, this signal terminal need not be wired. This is because an external circuit is normally formed so that servo power is turned OFF when servo alarm is output. Alarm state is automatically reset when servo power is turned ON next time.

Alarm state can be reset using the Digital Operator.

When an alarm occurs, always eliminate the cause before resetting the alarm state. 5.2.1 *Troubleshooting Problems with Alarm Display* describes how to troubleshoot the system when an alarm arises.

2.5.2 Using Servo ON Input Signal

- 1) This section describes how to wire and use contact input signal "servo ON (S-ON)."
Use this signal to forcibly turn the servomotor OFF from the host controller.

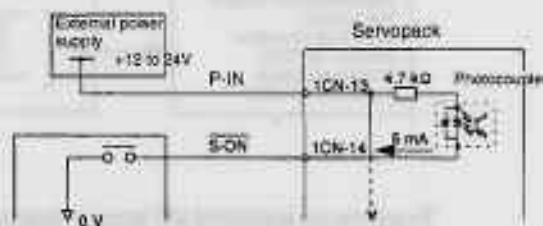

→ Input S-ON 1CN-14 Servo ON

This signal is used to turn the motor ON or OFF.

ON: 1CN-14 is at low level	Turns the motor ON. This is normal operation state (called "servo ON state").
OFF: 1CN-14 is at high level	Turns the motor OFF. This is inoperable state (called "servo OFF state"). If the servo is turned OFF during motor operation, the motor is decelerated to a stop by applying dynamic brake.

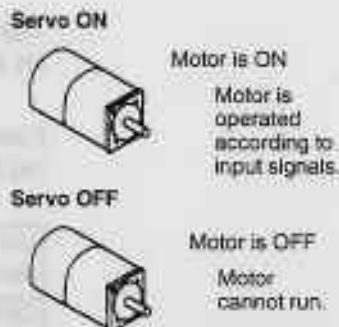

NOTE Do not use the S-ON signal to start or stop the motor. Always use an input reference to start and stop the motor.

- 2) If the $\overline{S-ON}$ signal is not to be used, set the following memory switch to 1:

Cn-01 Bit 0	Use of Servo ON Input Signal	Factory Setting: 0
-------------	------------------------------	--------------------

This memory switch is used to enable or disable the servo ON input signal $\overline{S-ON}$ (1CN-14).

When external short-circuit wiring is omitted, set the memory switch to "1."



When $\overline{S-ON}$ is not used, this short-circuit wiring can be omitted.

Setting	Meaning
0	Uses servo ON signal $\overline{S-ON}$. (When 1CN-14 is open, servo is OFF. When 1CN-14 is at 0 V, servo is ON.)
1	Does not use servo ON signal $\overline{S-ON}$.

2.5.3 Using Positioning Complete Signal

- 1) This section describes how to wire and use contact output-signal "positioning complete output (\overline{COIN}).^{*} This signal is output to indicate that servomotor operation is complete.

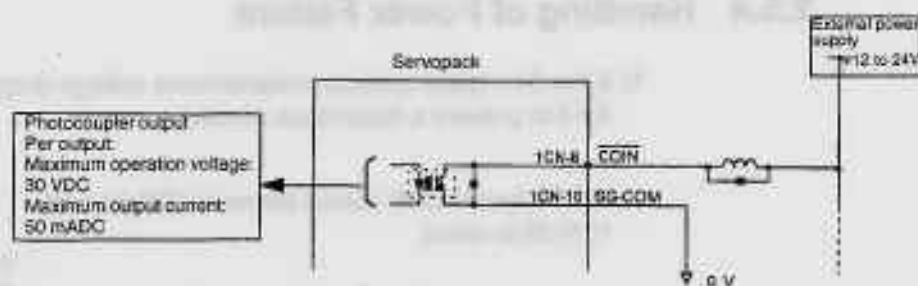

Output → COIN 1CN-8 Positioning Complete Output

This output signal indicates that motor operation is complete during position control. The host controller uses this signal as an interlock to confirm that positioning is complete.

ON status:	Circuit between 1CN-8 and 1CN-10 is closed. 1CN-8 is at low level.	Positioning is complete (position error is below the preset value).
OFF status:	Circuit between 1CN-8 and 1CN-10 is open. 1CN-8 is at high level.	Positioning is not complete (position error is over the preset value).

Preset Value: Cn-1B (positioning complete range)

APPLICATIONS OF Σ -SERIES PRODUCTS

2.5.4 Handling of Power Failure

- 2) Set the number of error pulses in the following user constant to adjust output timing of COIN (positioning complete output).

Cn-1B	COINLV Positioning Complete Range	Unit: Reference Unit	Setting Range: 0 to 250	Factory Setting: 7
-------	--------------------------------------	----------------------------	-------------------------------	-----------------------

This user constant is used to set output timing of positioning complete signal (COIN, 1CN-8) to be output when motor operation is complete after a position reference pulse has been input.

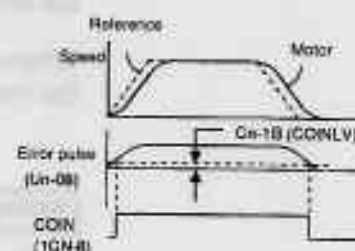

Set the number of error pulses in terms of reference unit (the number of input pulses that is defined using the electronic gear function).

If too large a value is set in this user constant, error may become too small when the motor runs at a low speed, causing COIN to be output continuously.

COINLV does not affect the final positioning accuracy.

2.5.4 Handling of Power Failure

- 1) If the Servopack detects instantaneous voltage drop in power supply, it outputs alarm ALM3 to prevent a hazardous situation.

ALM output is OFF (circuit between 1CN-34 and 1CN-35 is open)

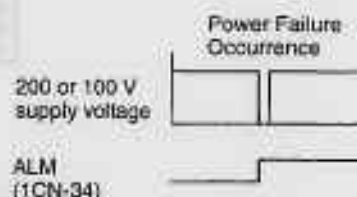

Note Clearing Servo Alarm:

To change a user constant that is made valid by turning the Servopack OFF and then ON, always wait for at least the "power holding time" after the Servopack is turned OFF, then turn the Servopack ON. Follow the procedure below.

- Make sure that all indicators (LEDs) on the Digital Operator have gone OFF.
- Make sure that the power and alarm indicators (LEDs) on the front panel of the Servopack have gone OFF.

Then, turn the power ON again.

Reason

When clearing servo alarm, the Servopack will operate normally even if it is turned ON without waiting "power holding time" after being turned OFF. In this case, however, the inside of the Servopack has not yet been reset (power ON reset). Therefore, user constants that have been modified do not become valid if these constants are made valid by turning the power OFF and then ON. Although the modified (new) settings appear on the display, the old settings are still valid inside the Servopack.

Parameter	Default Value	Unit
...
...
...
...
...
...
...
...

...

Parameter	Default Value	Unit
...
...

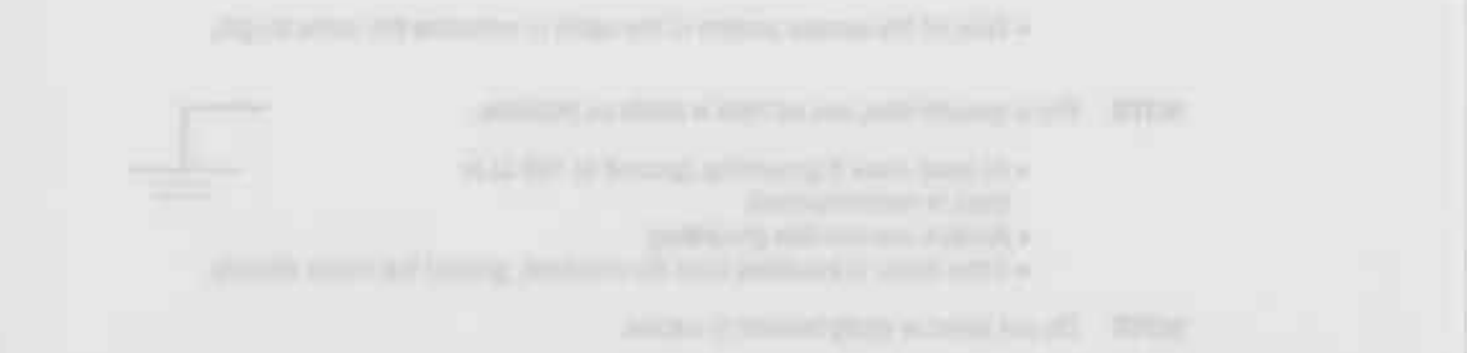

...

2.6 Special Wiring

This section describes special wiring methods including the one for noise control. Always refer to *2.6.1 Notes on Wiring* and *2.6.2 Wiring for Noise Control*, and refer to other sections as necessary.

2.6.1	Wiring Instructions	56
2.6.2	Wiring for Noise Control	58
2.6.3	Using More Than One Servo Drive	63
2.6.4	Using Regenerative Units	64
2.6.5	Using SGDE Servopack with High Voltage Line	67
2.6.6	Connector Terminal Layouts	69

2.6.1 Wiring Instructions

To ensure safe and stable operation, always refer to the following wiring instructions.

NOTE Always use the following cables for reference input and encoder wiring.

	Cable Type	Yaskawa Drawing No.	Maximum Allowable Length
For reference input	Twisted-pair cables	DE9404859	3 m (9.8 ft.)
For encoder	Multiconductor shielded twisted-pair cable	B9400064 (for incremental encoder)	20 m (65.6 ft.)

- Trim off the excess portion of the cable to minimize the cable length.

NOTE For a ground wire, use as thick a cable as possible.

- At least class 3 grounding (ground to 100 Ω or less) is recommended.
- Always use one-line grounding.
- If the motor is insulated from the machine, ground the motor directly.



NOTE Do not bend or apply tension to cables.

- Since the conductor of a signal cable is very thin (0.2 to 0.3 mm), handle it with adequate care.

NOTE Use a noise filter to prevent noise interference.
(For details, refer to the following *Caution*.)

Noise filter



- If the servo is to be used near private houses or may receive noise interference, install a noise filter on the input side of the power supply line. Since this Servopack is designed as an industrial device, it provides no mechanism to prevent noise interference.

NOTE To prevent malfunction due to noise, take the following actions:

- Position the input reference device and noise filter as close to the Servopack as possible.
- Always install a surge absorber circuit in the relay, solenoid and magnetic contactor coils.
- The distance between a power line (such as a power supply line or motor cable) and a signal line must be at least 30 cm (12 in). Do not put the power and signal lines in the same duct or bundle them together.
- Do not share the power supply with an electric welder or electrical discharge machine. When the Servopack is placed near a high-frequency oscillator, install a noise filter on the input side of the power supply line.

- Note**
- a) Since Servopack uses high-speed switching elements, signal lines may receive noise. To prevent this, always take the above actions.
 - b) For details of grounding and noise filters, refer to 2.6.2 *Wiring for Noise Control*.

NOTE Use a molded-case circuit breaker (MCCB) or fuse to protect the power supply line from high voltage.

- This Servopack is directly connected to commercial power supply without a transformer. Always use an MCCB or fuse to protect the servo system from accidental high voltage.
- Select an appropriate MCCB or fuse according to the Servopack capacity and the number of Servopacks to be used as shown below.

MCCB

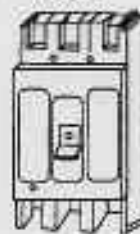

MCCB or Fuse for Each Power Capacity

Power Voltage	Servopack Type	Power Capacity Per Servopack (kVA) (see note 1)	Power Capacity Per MCCB or Fuse (A) (see note 2)
200 V	SGDE-A3AP	0.25	5
	SGDE-A5AP	0.3	
	SGDE-01AP	0.5	
	SGDE-02AP	0.75	
	SGDE-04AP	1.2	9
	SGDE-08AP	2.2	18
100 V	SGDE-A3BP	0.2	5
	SGDE-A5BP	0.3	
	SGDE-01BP	0.5	
	SGDE-02BP	0.75	8
	SGDE-03BP	1.4	15

- Note**
- 1) Power capacity at rated load
 - 2) Operating characteristics (25°C): 2 seconds or more for 200%, 0.01 second or more for 700%
 - 3) A fast-operating fuse cannot be used because the Servopack power supply is a capacitor input type. A fast-operating fuse may blow out when the power is turned ON.

2.6.2 Wiring for Noise Control

1) Example of Wiring for Noise Control

- a) This Servopack uses high-speed switching elements in the main circuit. It may receive "switching noise" from these high-speed switching elements if wiring or grounding around the Servopack is not appropriate. To prevent this, always wire and ground the Servopack correctly.
- b) This Servopack has a built-in microprocessor (CPU). To protect the microprocessor from external noise, install a noise filter in place.

c) The following is an example of wiring for noise control.

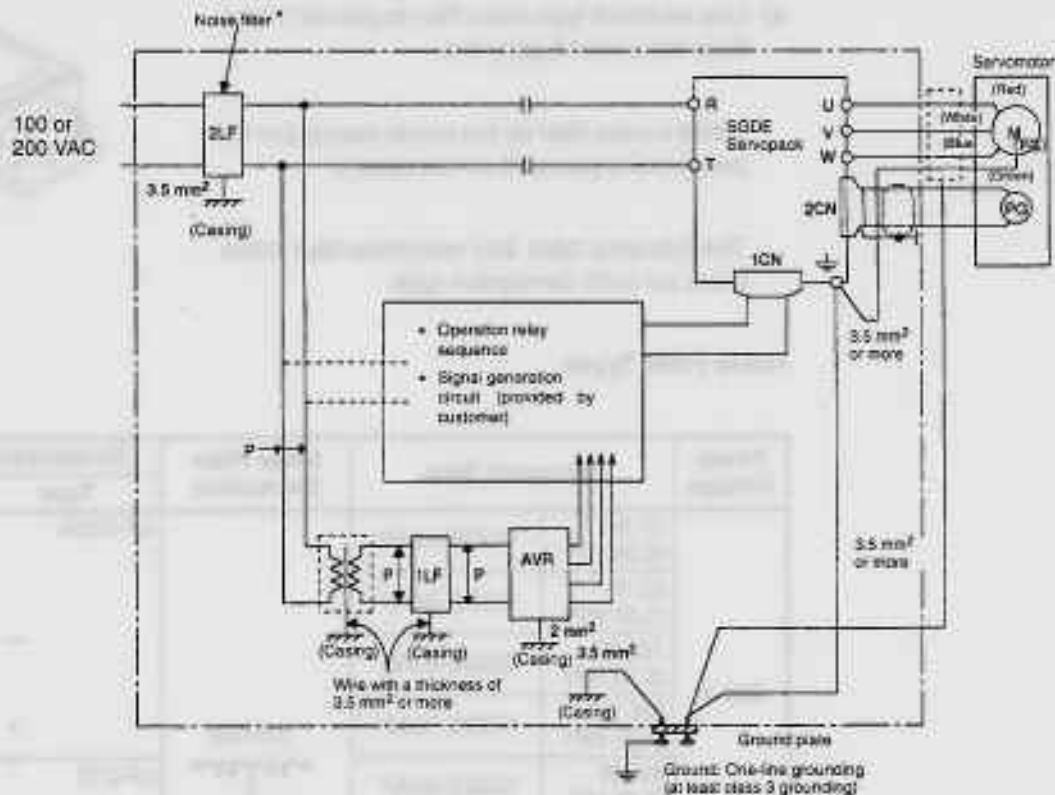

* When using a noise filter, always observe the following wiring instructions:

- Note**
- For a ground wire to be connected to the casing, use a thick wire with a thickness of at least 3.5 mm² (preferably, plain stitch cooper wire).
 - For wires indicated by P₁, use twisted-pair cables whenever possible.

2) Correct Grounding

- Always ground the motor frame.

Always connect servomotor frame terminal FG (green) to the Servopack ground terminal. Be sure to ground the ground terminal.

- If the servomotor is grounded via the machine, a switching noise current will flow from the Servopack power unit through motor stray capacitance. The above grounding is required to prevent the adverse effects of switching noise.
- If the reference input line receives noise, do the following.

Ground the 0 V line (such as SG-V and SG-T) of the reference input line. If the main circuit wiring for the motor is accommodated in a metal conduit, ground the conduit and its junction box. For all grounding, always use one-line grounding.

3) Noise Filter Installation

- a) Use an inhibit type noise filter to prevent noise from the power supply line.

Install a noise filter on the power supply line for peripheral equipment as necessary.

The following table lists recommended noise filters for each Servopack type.

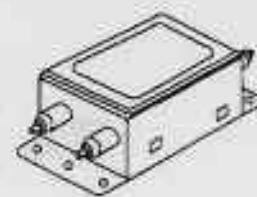

Noise Filter Types

Power Voltage	Servopack Type		Noise Filter Connection	Recommended Noise Filter	
				Type	Specifications
200 V	30 W (0.04 HP)	SGDE-A3AP	<p>(Correct)</p>	LF-205A	Single-phase 200 VAC, 5 A
	50 W (0.07 HP)	SGDE-A5AP			
	100 W (0.13 HP)	SGDE-01AP			
	200 W (0.27 HP)	SGDE-02AP			
	400 W (0.53 HP)	SGDE-04AP			
	750 W (1.01 HP)	SGDE-06AP			
100 V	30 W (0.04 HP)	SGDE-A3BP	<p>(Incorrect)</p>	LF-205A	Single-phase 200 VAC, 5 A
	50 W (0.07 HP)	SGDE-A5BP		LF-210	Single-phase 200 VAC, 10 A
	100 W (0.13 HP)	SGDE-01BP		LF-220	Single-phase 200 VAC, 20 A
	200 W (0.27 HP)	SGDE-02BP		LF-210	Single-phase 200 VAC, 10 A
	300 W (0.39 HP)	SGDE-03BP		LF-220	Single-phase 200 VAC, 20 A

Note These noise filters are manufactured by Tokin Corp. and available from Yaskawa. For noise filters, contact your nearest Yaskawa sales representatives.

- b) Always observe the following installation and wiring instructions. Incorrect use of a noise filter halves its benefits.

- Separate input lines from output lines.

Do not put the input and output lines in the same duct or bundle them together.

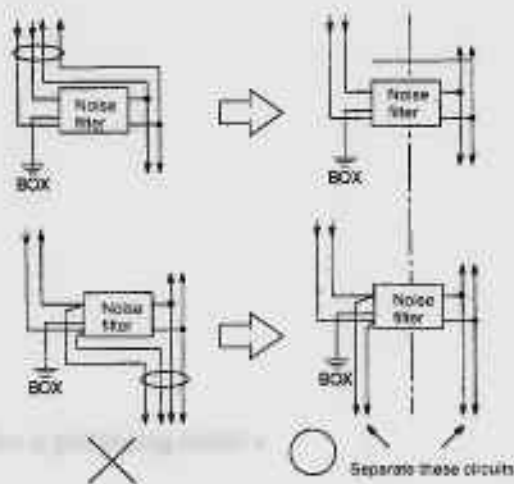
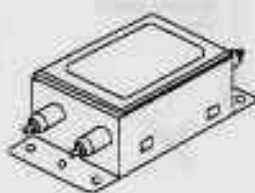

- Separate the noise filter ground wire from the output lines.

Do not accommodate the noise filter ground wire, output lines and other signal lines in the same duct or bundle them together.

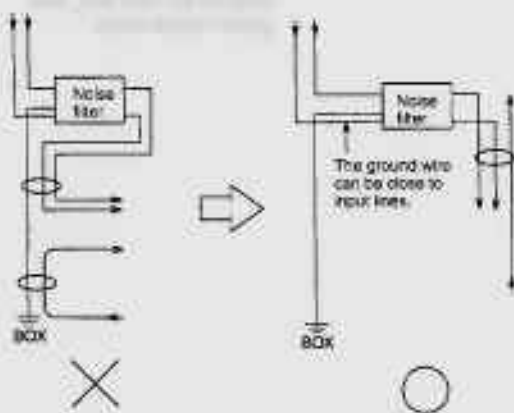

APPLICATIONS OF E-SERIES PRODUCTS

2.6.2 Wiring for Noise Control cont.

- Connect the noise filter ground wire directly to the ground plate.

Do not connect the noise filter ground wire to other ground wires.

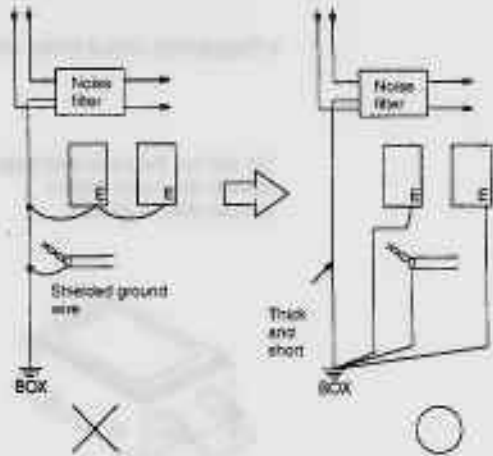

- When grounding a noise filter inside a Unit.

If a noise filter is located inside a Unit, connect the noise filter ground wire and the ground wires from other devices inside the Unit to the ground plate for the Unit first, then ground these wires.

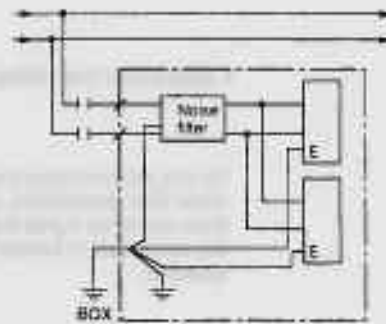

2.6.3 Using More Than One Servo Drive

Example of Wiring More than One Servo Drive

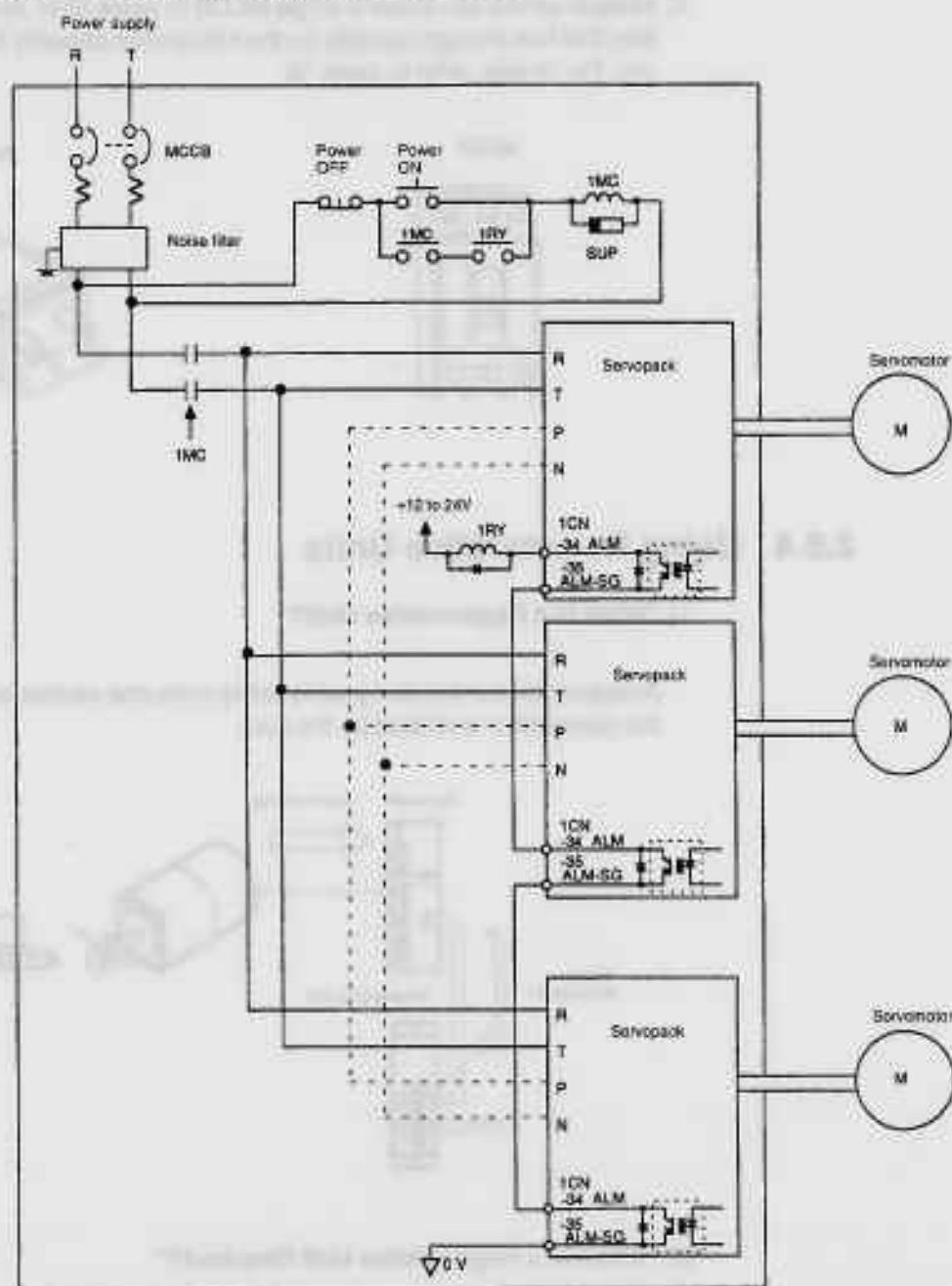

- 1) Connect the alarm output (ALM) terminals for the three Servopacks in series to enable alarm detection relay 1RY to operate. This is because ALM is a logical complement output signal, so the output transistor is turned OFF when the system enters an alarm state.
- 2) When some of the Servopack's regenerative capacity is not sufficient, connect terminals P and N for regenerative units in parallel. Since the Servopack power supply is a capacitor input type, connecting P and N terminals in parallel produces high power capacity over all, enhancing regenerative performance.

- 3) When terminals P and N are connected in parallel, always turn the power ON to all axes simultaneously. Do not turn the power ON to only part of the axes.
- 4) Multiple servos can share a single MCCB or noise filter. Always select a MCCB or noise filter that has enough capacity for the total power capacity (load conditions) of those servos. For details, refer to page 58.



2.6.4 Using Regenerative Units

1) "What is a Regenerative Unit?"

A regenerative unit is designed to safely consume electric energy that is generated when the servomotor is rotated by the load.

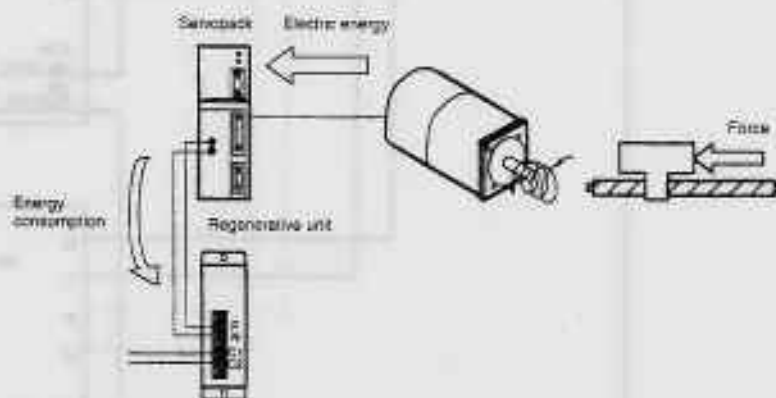

2) "When is a Regenerative Unit Required?"

For general use, a regenerative unit is not required. In the following cases, however, the user must determine whether a regenerative unit is required or not:

- a) When the motor is used to control a vertical axis.
- b) When the motor starts and stops frequently.
- c) When load inertia exceeds the allowable load inertia on the motor side.

- d) When the motor rotates at a speed higher than the rated speed (3000 r/min).

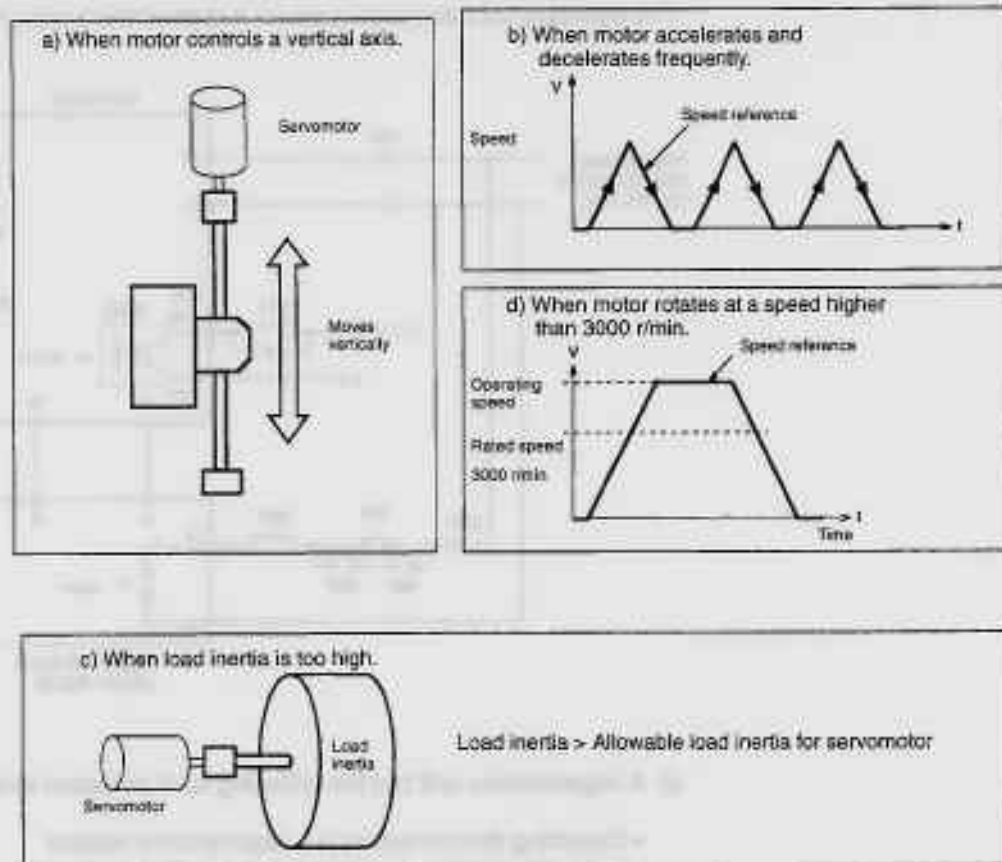

3) "How can we Determine Whether a Regenerative Unit is Required or Not?"

Using software "regenerative capacity check program" enables the user to easily determine whether a regenerative unit is required. This software is included as part of Yaskawa proprietary software "AC servomotor sizing software," which is supplied free of charge. Use this software as necessary.

4) Connecting a Regenerative Unit (JUSP-RG08 type)

The standard connection diagram for a regenerative unit (JUSP-RG08) is shown below.

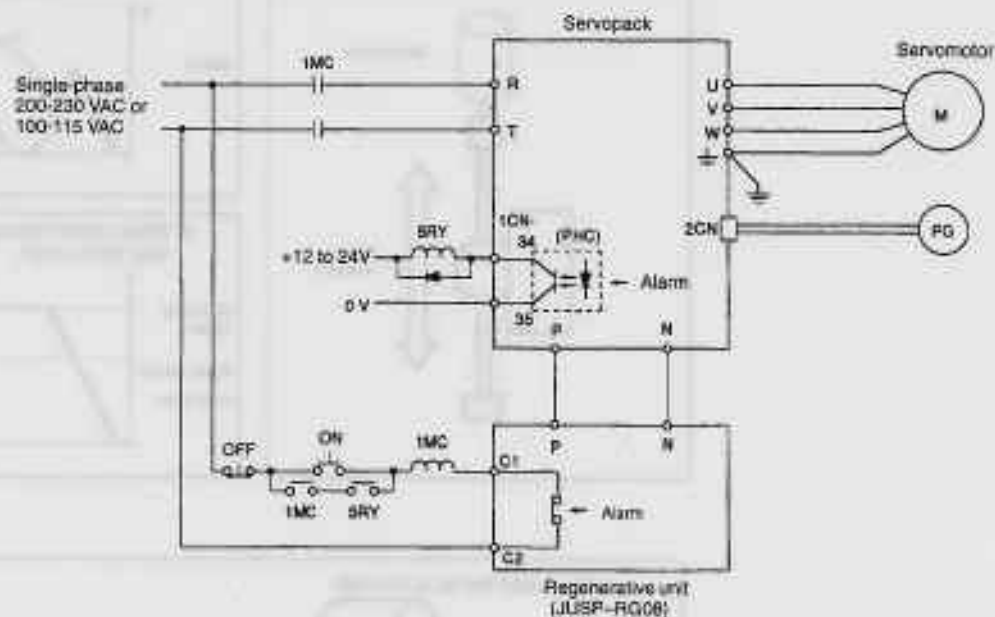

a) A regenerative unit has the following fault detection functions:

- Detecting disconnection in a regenerative resistor
- Detecting faults in a regenerative transistor
- Detecting overvoltage

b) When one of these fault detection functions operates, the internal alarm relay is actuated. Then, the circuit between output terminals C1 and C2 is opened.

c) Form a sequence so that the Servopack power is turned OFF when the alarm relay is actuated.

5) Connecting a Regenerative Unit (JUSP-RG08C type)

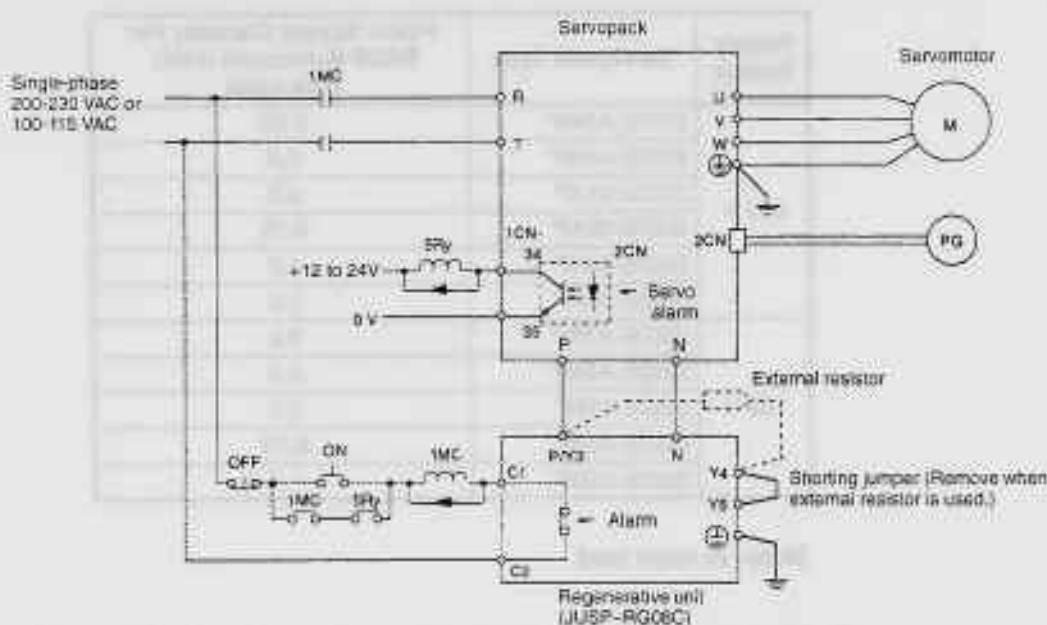

- a) A regenerative unit has the following fault detection functions:
 - Detecting disconnection in a regenerative resistor
 - Detecting faults in a regenerative transistor
 - Detecting overvoltage
- b) When one of these fault detection functions operates, the internal alarm relay is actuated. Then, the circuit between output terminals C1 and C2 is opened.
- c) When an external resistor is used, remove the shorting jumper between Y4 and Y5. Then, connect the resistor between P/Y3 and Y4.
- d) The resistance value of the external resistor should be 50 Ω min.

2.6.5 Using SGDE Servopack with High Voltage Line

- 1) SGDE Servopacks are divided into single-phase 200 V and single-phase 100 V types according to supply voltage.

If, however, three-phase 400 VAC class (400 V, 440 V) power supply must be used, prepare the following power transformer (for single-phase).

<Primary side>		<Secondary side>
1) 400 or 440 VAC	→	200 VAC
2) 400 or 440 VAC	→	100 VAC

APPLICATIONS OF Σ -SERIES PRODUCTS

2.6.5 Using SGDE Servopack with High Voltage Line cont.

2) Select appropriate power transformer capacity according to the following table.

Supply Voltage	Servopack Type	Power Supply Capacity Per SGDE Servopack (kVA) (see note)
200 V	SGDE-A3AP	0.25
	SGDE-A5AP	0.3
	SGDE-01AP	0.5
	SGDE-02AP	0.75
	SGDE-04AP	1.2
	SGDE-08AP	2.2
100 V	SGDE-A3BP	0.2
	SGDE-A5BP	0.3
	SGDE-01BP	0.5
	SGDE-02BP	0.75
	SGDE-03BP	1.4

Note At rated load.

3) When 400-V-class supply voltage is used, power must be turned ON and OFF on the primary side of the power transformer.

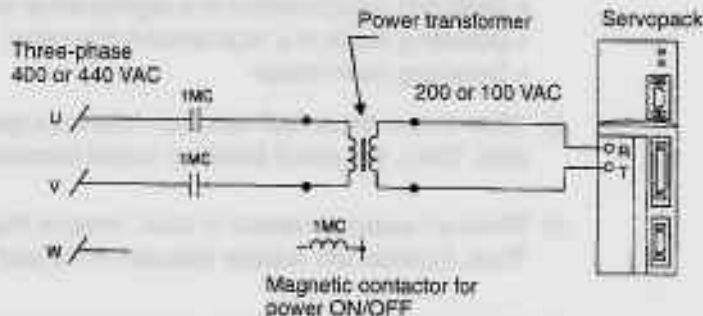

2.6.6 Connector Terminal Layouts

This section describes connector terminal layouts for Servopacks and Servomotors.

1) Servopack Connectors

1CN Terminal Layout

2	*PULS	Reference pulse input	1	PULS	Reference pulse input	20	—	Not used	19	—	Not used
4	*SIGN	Reference signal input	3	SIGN	Reference sign input	22	—	Not used	21	—	Not used
6	*CLR	Error counter clear input	5	CLR	Error counter clear input	24	—	Not used	23	—	Not used
8	CDN	Positioning complete signal output	7	BK	Brake interlock signal output	26	—	Not used	25	—	Not used
10	SG	0 V	9	—	Not used	28	—	Not used	27	—	Not used
12	—	Not used	11	—	Not used	30	—	Not used	29	—	Not used
14	SON	Servo ON input	13	P-IN	External power supply input	32	PG	PG output phase C	31	—	Not used
16	F-OT	Forward rotation prohibited input	15	P-CDN	P control input	34	ALM	Servo alarm output	33	SG	0 V
18	ALMST	Alarm reset input	17	R-OT	Reverse rotation prohibited	36	FG	Frame ground	35	SG	0 V

- **Servopack Side** Connector type: 178239-5 (manufactured by AMP)
- **Cable Side** Connector type: 10136-3000VE (manufactured by 3M)
Connector case type: 10336-52A0-008 (manufactured by 3M)

2CN Terminal Layout

2	PG0V	PG power supply 0 V	1	PG0V	PG power supply 0 V	12	—	Not used	11	—	Not used
4	PG5V	PG power supply +5 V	3	PG0V	PG power supply 0 V	14	PC	PG input phase C	13	—	Not used
6	PG5V		5	PG5V		PG power supply +5 V	16	PA	PG input phase A	15	PG
8	—	Not used	7	—	Not used	18	PA	PG input phase A	17	PA	PG input phase A
10	—	Not used	9	—	Not used	20	PB	PG input phase B	19	PB	PG input phase B

- **Servopack Side** Connector type: 178239-2 (manufactured by AMP)
- **Cable Side** Connector type: 10120-3000VE (manufactured by 3M)
Connector case type: 10320-52A0-008 (manufactured by 3M)

2) Connectors for Incremental Encoder

1	Channel A output	Blue
2	Channel \bar{A} output	Blue/Black
3	Channel B output	Yellow
4	Channel \bar{B} output	Yellow/Black
5	Channel C output	Green
6	Channel \bar{C} output	Green/Black
7	0 V (power supply)	Gray
8	+5 V (power supply)	Red
9	Frame ground (FG)	Orange



Items to be Prepared by Customer
 Cap: 172161-1
 Socket: 170361-1 (chain type) or
 170365-1 (case type)

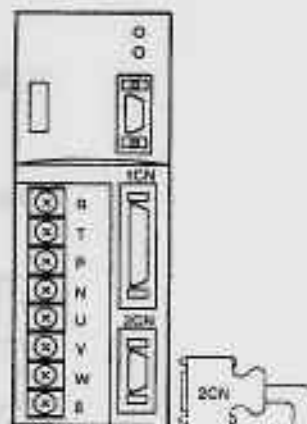

Items to be Prepared by Customer
 Case:
 10320-52A0-008
 (manufactured by 3M)
 Connector:
 10120-3000VE
 (manufactured by 3M)

3) Connectors and Terminals for Standard-type Motor without Brake

1	Phase U	Red
2	Phase V	White
3	Phase W	Blue
4	Frame ground (FG)	Green



Cap: 172159-1
 Socket: 170362-1 or
 170365-1

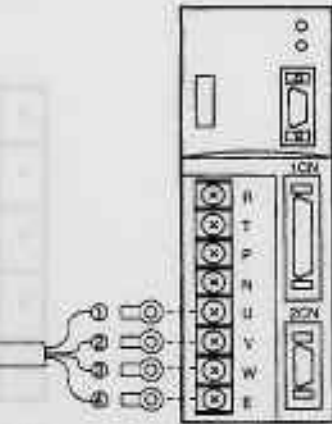

M4 crimp terminal
 Items to be Prepared by Customer
 Round crimp terminal R1.25-4TOR
 (manufactured by AMP)

4) Connectors and Terminals for Motor with Brake

1	Phase U	Red
2	Phase V	White
3	Phase W	Blue
4	Frame ground (FG)	Green
5	Brake terminal	Black
6	Brake terminal	Black

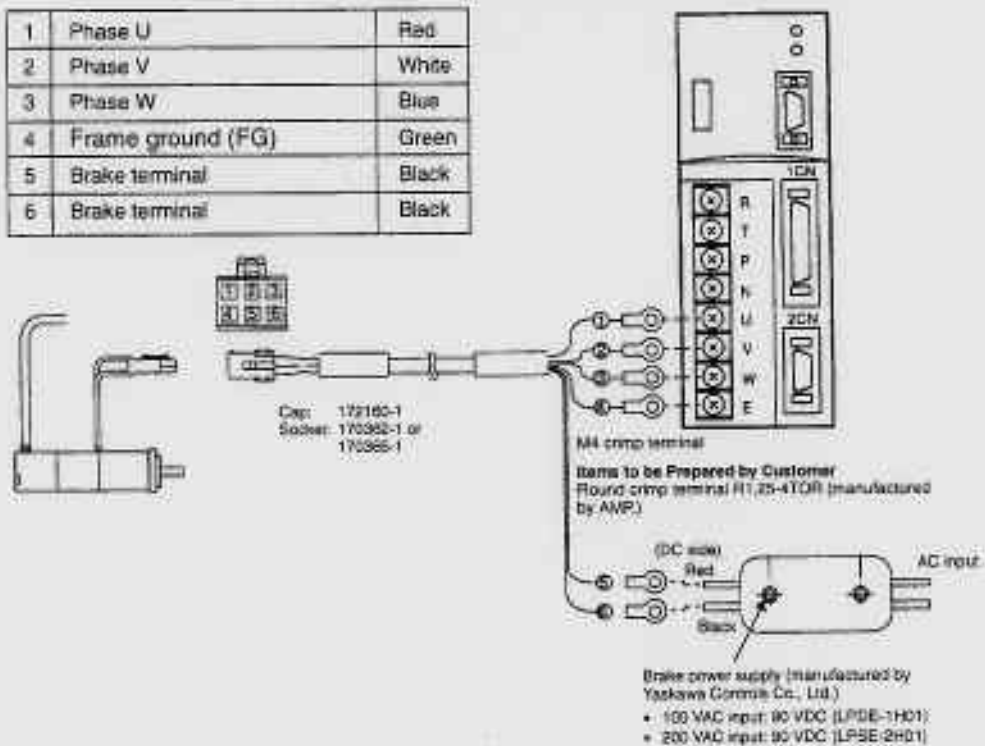

USING THE DIGITAL OPERATOR

3

This chapter describes the basic operation of the digital operator and the convenient features it offers.

All constant settings and motor operations are possible by simple, convenient, operation.

Operate the digital operator as you read through this chapter.

3.1 Basic Operations	74
3.1.1 Connecting the Digital Operator	74
3.1.2 Resetting Servo Alarms	75
3.1.3 Basic Functions and Mode Selection	76
3.1.4 Operation in Status Display Mode	77
3.1.5 Operation in User Constant Setting Mode	78
3.1.6 Operation in Monitor Mode	83
3.2 Using the Functions	86
3.2.1 Operation in Alarm Trace-back Mode	86
3.2.2 Operation Using the Digital Operator	88
3.2.3 Autotuning	91
3.2.4 Clearing Alarm Trace-back Data	97
3.2.5 Checking Motor Type	98
3.2.6 Checking Software Version	99

3.1 Basic Operations

■ This section describes the basic operations using the Digital Operator.

3.1.1	Connecting the Digital Operator	74
3.1.2	Resetting Servo Alarms	75
3.1.3	Basic Functions and Mode Selection	76
3.1.4	Operation in Status Display Mode	77
3.1.5	Operation in User Constant Setting Mode	78
3.1.6	Operation in Monitor Mode	83

3.1.1 Connecting the Digital Operator

The Digital Operator is available as two types: JUSP-OP02A-1 (Hand-held Type) and JUSP-OP03A (Mount Type).

Each type is connected to the Servopack as shown below.

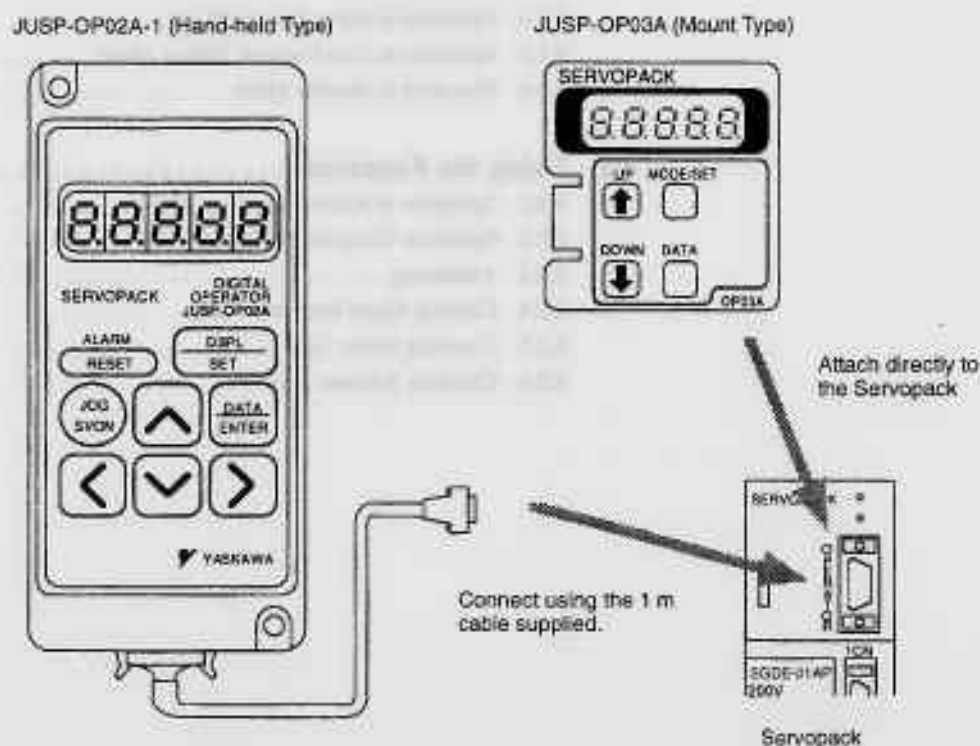

- The Digital Operator connector can be connected or disconnected while the Servopack power is ON.

3.1.2 Resetting Servo Alarms

Servo alarms can be reset using the Digital Operator. (Servo alarms can also be reset by the 1CN-18, ALMRST input signal. Refer to 2.5.1 for details.)



NOTE After an alarm occurs, remove the cause of the alarm before resetting it. Refer to *Section 5.2 Troubleshooting* to determine and remedy the cause of an alarm.

3.1.3 Basic Functions and Mode Selection

Digital Operator operation allows status display, user constant setting, operating reference, and auto-tuning operations.

Basic Mode Selection

The four basic modes are listed below. Each time the mode key is pressed, the next mode in the sequence is selected.

JUSP-OP02A-1



Press the



key to switch the mode.

JUSP-OP03A



Press the



key to switch the mode.

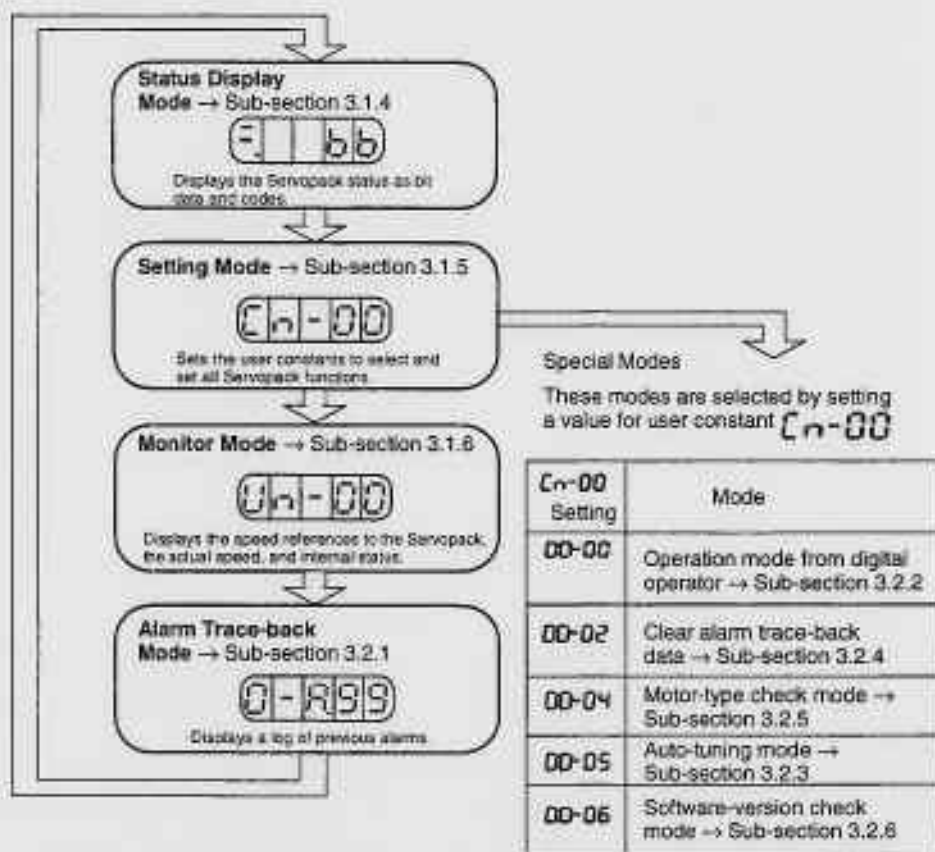

3.1.4 Operation in Status Display Mode

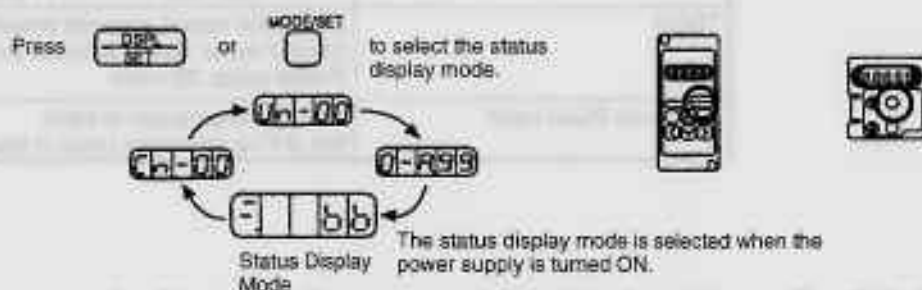

The status display mode displays the Servopack status as bit data and codes.

• Selecting Status Display Mode

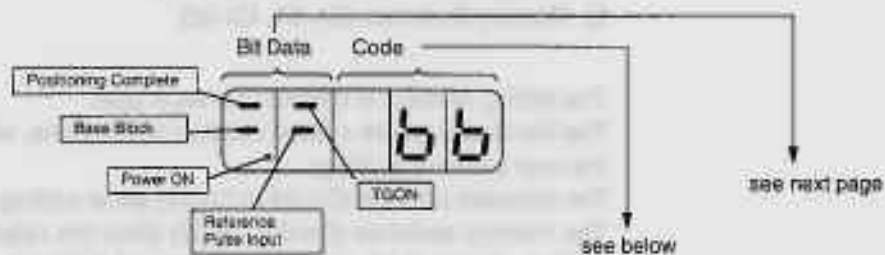

Keys to the status display are shown below.

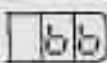
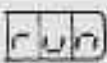
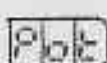
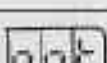
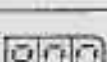
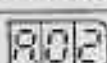

Code	Status
	Base block Servo OFF
	Run Servo ON
	Forward Rotation Prohibited 1CN-16 (P-OT) OFF. See Cn-01 Bit 2 (page 32).
	Reverse Rotation Prohibited 1CN-17 (N-OT) OFF. See Cn-01 Bit 3 (page 32).
	Alarm Status Displays the alarm number.
	
	

Bit Data	Description
Power ON	Lit when Servopack power ON. Not lit when Servopack power OFF.
Base Block	Lit for base block. Not lit at servo ON.
Positioning Complete	Lit if error between position reference and actual motor position is below preset value. Not lit if error between position reference and actual motor position exceeds preset value. Preset value: Set in Cn-1B (1 pulse is standard setting)
TGON	Lit if motor speed exceeds preset value. Not lit if motor speed is below preset value. Preset value: 20 r/min
Reference Pulse Input	Lit if reference pulse is input. Not lit if no reference pulse is input.

3.1.5 Operation in User Constant Setting Mode

1) Two types of user constant are used

- a) Constant Settings (Cn-04 to Cn-26)
- b) Memory Switches (Cn-01, Cn-02)

The setting method is different for each type.

The Servopack offers a large number of functions, which are selected and adjusted by the user constant settings.

The constant settings (Cn-04 to Cn-26) allow setting of a constant within a fixed range.

The memory switches (Cn-01, Cn-02) allow the required functions to be selected.

Refer to *Appendix C List of User Constant Settings*.

Bit Data	Description
Power ON	Lit when Servopack power ON. Not lit when Servopack power OFF.
Base Block	Lit for base block. Not lit at servo ON.
Positioning Complete	Lit if error between position reference and actual motor position is below preset value. Not lit if error between position reference and actual motor position exceeds preset value. Preset value: Set in Cn-1B (1 pulse is standard setting)
TGON	Lit if motor speed exceeds preset value. Not lit if motor speed is below preset value. Preset value: 20 r/min
Reference Pulse Input	Lit if reference pulse is input. Not lit if no reference pulse is input.

2) Using the Setting Mode for Constant Settings (Cn-04 to Cn-26)

The constant settings (Cn-04 to Cn-26) allow setting of a constant. Check the permitted range of the constant in *Appendix C List of User Constant Settings*, before changing the data. The example below shows how to change user setting Cn-04 from 80 to 40.



JUSP-OP02A-1

For JUSP-OP02A-1

- 1) Press to select the user constant setting mode.

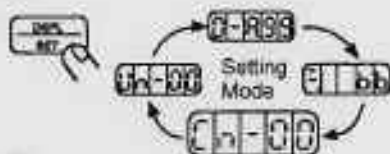

- 2) Select the user constant number to set.
Press the and keys to select the digit.
Press the and keys to change the value.

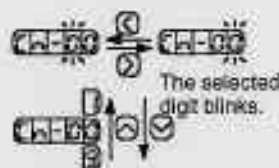

- 3) Press to display the current data for the user constant selected at step 2.



- 4) Set the required data.
Press the and keys to select the digit.
Press the and keys to change the value.

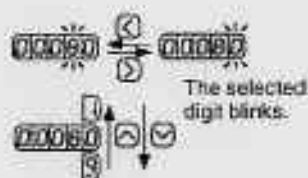

- 5) Press to store the data.

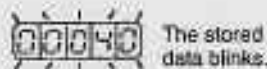

- 6) Press once more to display the user constant number again.



- 7) Repeat steps 2 to 6 as often as required.

USING THE DIGITAL OPERATOR

3.1.5 Operation in User Constant Setting Mode cont.



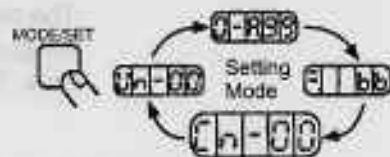

For JUSP-OP03A

- 1) Press  to select the user constant setting mode.



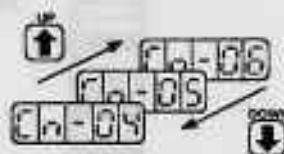

- 2) Press the  and  keys to select the user constant number to set.

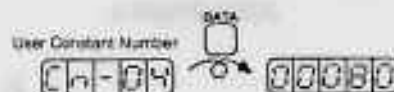

- 3) Press  to display the current data for the user constant selected at step 2.



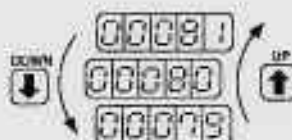

- 4) Press the  and  keys to change the data to the required value.

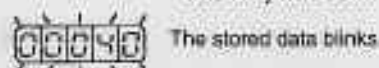

Value changes rapidly when key held down

- 5) Press  to store the data.



- 6) Press  once more to display the user constant number again.



- 7) Repeat steps 2 to 6 as often as required.

- Refer to *Appendix C List of User Constant Settings*

3) Using the Setting Mode for Memory Switches (Cn-01, Cn-02)

Turn the bits of the memory switches ON and OFF to select the functions required. The example below shows how to turn ON Bit 3 of memory switch Cn-01.



JUSP-OP02A-1

For JUSP-OP02A-1

- 1) Press to select the user constant setting mode.

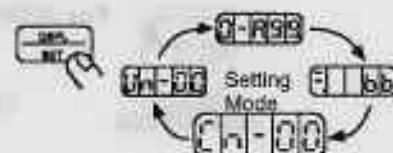

- 2) Select the user constant number to set.
Press the and keys to select the digit.
Press the and keys to change the value.

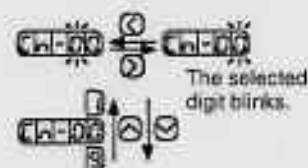

- 3) Press to display the current data for the memory switch selected at step 2.



- 4) Press the and keys to select the bit number to set.

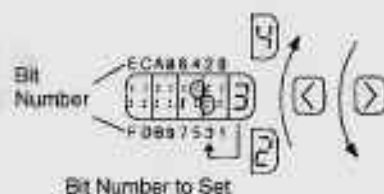

- 5) Press the and keys to set the memory switch data ON or OFF for the bit number.

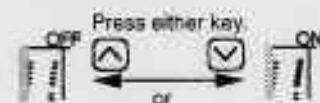

- 6) Repeat steps 4 and 5 as often as required.

- 7) Press to store the data.

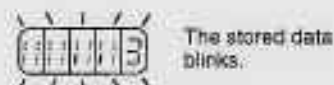

Turning Bits ON and OFF

Memory switches use bits, not numbers, to select functions.

Sixteen bits are available (1 to 9 and A to E). Select the required functions by turning the appropriate bit ON (function ON) or OFF (function OFF).



- 8) Press  once more to display the user constant number again.





• Refer to Appendix C List of User Constant Settings.



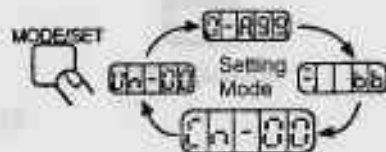

For JUSP-OP03A

- 1) Press  to select the user constant setting mode.



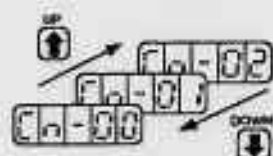

- 2) Press the  and  keys to select the user constant number to set.



- 3) Press  to display the current data for the memory switch selected at step 2.



- 4) Press the  and  keys to select the bit number to set.

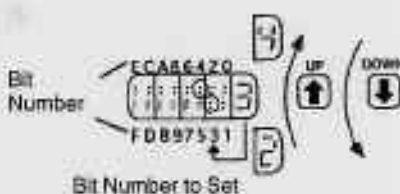

- 5) Press  to set the memory switch data ON or OFF for the bit number.



- 6) Repeat steps 4 and 5 as often as required.

- 7) Press  to store the data.



- 8) Press  once more to display the user constant number again.



• Refer to Appendix C List of User Constant Settings

3.1.6 Operation in Monitor Mode

- 1) The monitor mode allows the reference values input into the Servopack, I/O signal status, and Servopack internal status to be monitored.
The monitor mode can be set during motor operation.

2) Using the Monitor Mode

The example below shows how to display 1500, the contents of monitor number Un-00.



JUSP-OP02A-1

For JUSP-OP02A-1

- 1) Press to select the monitor mode

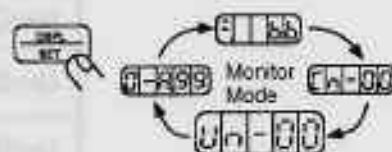

- 2) Press the and keys to select the monitor number to display.

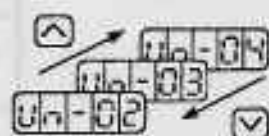

- 3) Press to display the data for the monitor number selected at step 2.



- 4) Press once more to display the monitor number again.



JUSP-OP03A

For JUSP-OP03A

- 1) Press to select the monitor mode.



- 2) Press the and keys to select the monitor number to display.

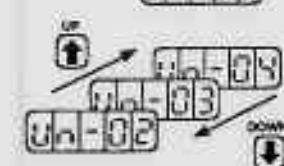

- 3) Press to display the data for the monitor number selected at step 2.



- 4) Press once more to display the monitor number again.



USING THE DIGITAL OPERATOR

3.1.6 Operation in Monitor Mode cont.

3) Keys to Monitor Mode Display are shown below.

Monitor Number	Monitor Display
Un-00	Actual motor speed Units: r/min.
Un-02	Units: r/min. (with respect to rated torque)
Un-03	Number of pulses from motor U-phase edge Units: pulses
Un-04	Electrical angle Units: deg
Un-05	Internal status bit display
Un-06	Internal status bit display
Un-07	Input reference pulse speed display Units: r/min.
Un-08	Position error Units: x1 reference unit (Cn-02 Bit E = 0) x100 reference unit (Cn-02 Bit E = 1)
Un-09	Reference pulse counter Units: pulses

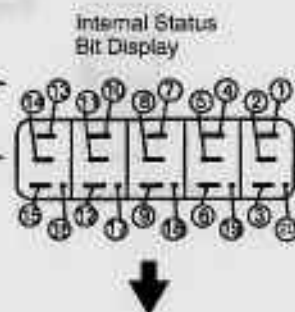

Monitor #	Bit #	Description	Related I/O Signal, User Constant
Un-05	1	Servo alarm	1CN-34 (ALM)
	2	Dynamic brake ON	
	3	Reverse rotation mode	Cn-02 Bit 0, 2CN-7 (DIR)
	4	During motor rotation	Status display mode
	5	Positioning complete	1CN-8 (COIN), status display mode
	6	Mode switch ON	
	7	Not used	
	8	Not used	
	9	Motor power ON	
	10	A-phase	2CN-16(PA), 2CN-17(+PA)
	11	B-phase	2CN-18(PB), 2CN-19(+PB)
	12	C-phase	2CN-14(PC), 2CN-15(+PC)
	13	U-phase	
	14	V-phase	
	15	W-phase	
	16	Servo ON	1CN-14 (S-ON), Cn-01 Bit 0
	17	P operation	1CN-15 (P-CON)
	18	Forward overtravel	1CN-16 (P-OT), Cn-01 Bit 2
	19	Reverse overtravel	1CN-17 (N-OT), Cn-01 Bit 3
	20	Not used	

Monitor #	Bit #	Description	Related I/O Signal, User Constant
Un-06	1	Input reference pulse	1CN-1 (PLUS), 1CN-2 (*PULS)
	2	Input pulse sign	1CN-3 (SIGN), 1CN-4 (*SIGN)
	3	Error counter clear input	1CN-5 (CLR), 1CN-6 (*CLR)
	4 to 20	Not used	

3.2 Using the Functions

This section describes how to use the basic operations described in section 1 to operate and adjust the motor.

3.2.1	Operation in Alarm Trace-back Mode	86
3.2.2	Operation Using the Digital Operator	88
3.2.3	Autotuning	91
3.2.4	Clearing Alarm Trace-back Data	97
3.2.5	Checking Motor Type	98
3.2.6	Checking Software Version	99

3.2.1 Operation in Alarm Trace-back Mode

- 1) The alarm trace-back mode displays up to ten alarms which occurred previously. By allowing confirmation of what alarm occurred when, it is a useful aid to speed up troubleshooting.



Alarm Sequence Number
The higher the number,
the older the alarm data

Alarm Code

Refer to Section 5.2
for troubleshooting.

NOTE The alarm trace-back data are not cleared on alarm reset or when the Servopack power is turned OFF. This does not adversely affect operation. The data are cleared using the special mode: Clear alarm trace-back data. Refer to sub-section 3.2.4 for details.

Alarms CPF00 and CPF01 are not stored as alarm trace-back data, since they are operator-related alarms.

2) Using the Alarm Trace-back Mode

Follow the procedure below to determine which alarms occurred previously.



JUSP-OP02A-1

For JUSP-OP02A-1

- 1) Press to select the alarm trace-back mode.

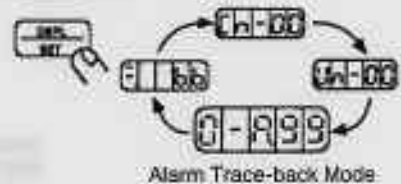

- 2) Press the and keys to scroll the alarm sequence numbers up and down and display information on previous alarms. The higher the left-hand digit (alarm sequence number), the older the alarm data.

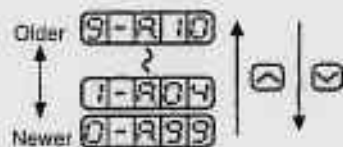

JUSP-OP03A

For JUSP-OP03A

- 1) Press to select the alarm trace-back mode.

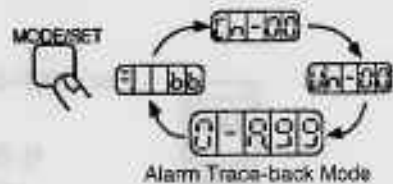

- 2) Press the and keys to scroll the alarm sequence numbers up and down and display information on previous alarms. The higher the left-hand digit (alarm sequence number), the older the alarm data.

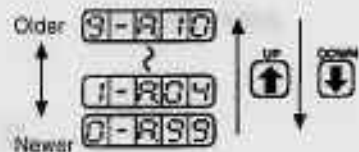

NOTE Refer to Section 5.2 for troubleshooting.

3.2.2 Operation Using the Digital Operator



Simple Motor Check

Operation from the Digital Operator allows the Servopack to run the motor. This allows rapid checking of basic operations during machine set-up and testing, without the trouble of connecting a host controller.

Used during machine set-up and testing. Forward, reverse settings possible.

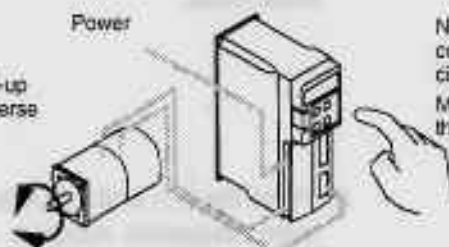

No need to connect to host controller or external circuits. Motor can be run just from the Digital Operator.

NOTE SGME Servomotor runs at 500 r/min. The motor speed cannot be changed.

1) Operation Using the Digital Operator

Use the following procedure to operate the motor from the Digital Operator



JUSP-OP02A-1

For JUSP-OP02A-1

- 1) Press to select the user constant setting mode.

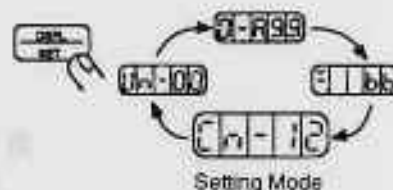

- 2) Select the user constant number Cn-00. (User constant Cn-00 is selected when the power is turned ON.)

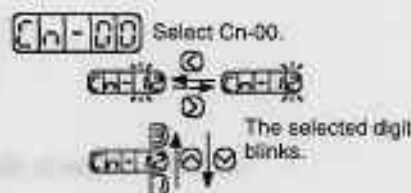

Press the and keys to select the digit.

Press the and keys to change the value.

- 3) Press to display the current data for the user constant Cn-00.



- 4) Press the and keys to change the data to 00.
(This user constant is set to 00 when the power is turned ON.)

Set to 00-00.

Press the keys to change the value.

- 5) Press to set the Digital Operator in operation mode. Operation is now possible under Digital Operator control.

Display for operation mode from Digital Operator:

- 6) Press to set the servo ON status (motor power turned ON).

Select Servo ON/Servo OFF

Press to change.

- 7) Press the and keys to operate the motor.

Motor Forward/Reverse Rotation

Motor runs forward while this key is pressed.

Motor runs backward while this key is pressed.

- 8) Press to revert to . This sets the servo OFF status (motor power turned OFF).

(Alternatively, press to set the servo OFF status.)

- 9) Press to return to the setting mode display. This disables operation under Digital Operator control.

Setting Mode Display



JUSP-OP03A

For JUSP-OP03A

- 1) Press to select the user constant setting mode.

Setting Mode

- 2) Press the and keys to select the user constant number Cn-00.
(User constant Cn-00 is selected when the power is turned ON.)



Select Cn-00.

- 3) Press to display the current data for the user constant Cn-00.

User Constant Number

USING THE DIGITAL OPERATOR

3.3.2 Operation Using the Digital Operator cont.

- 4) Press the  and  keys to change the data to 00.
(This user constant is set to 00 when the power is turned ON.)

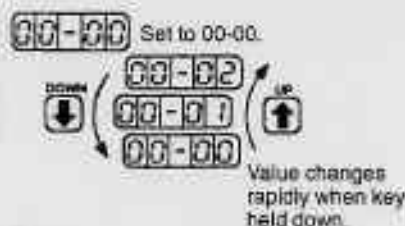

- 5) Press  to set the Digital Operator in operation mode. Operation is now possible under Digital Operator control.



- 6) Press  to set the servo ON status (motor power turned ON).

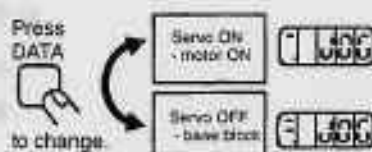

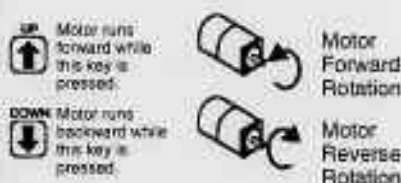

Select Servo ON/Servo OFF

- 7) Press the  and  keys to operate the motor.



Motor Forward/Reverse Rotation

- 8) Press  to revert to . This sets the servo OFF status (motor power turned OFF).



(Alternatively, press  to set the servo OFF status.)

- 9) Press  to return to the setting mode display. This disables operation under Digital Operator control.

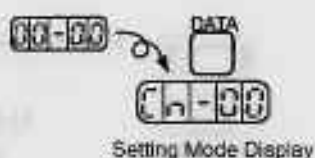

3.2.3 Autotuning



No experience required to achieve optimum settings.

The Servopack contains a built-in autotuning function to automatically measure the machine characteristics and set the user constants.

Servo drives normally require tuning to match the machine configuration and rigidity. This tuning requires a great deal of experience and is difficult for a person unfamiliar with the tuning procedure.

However, autotuning allows even totally inexperienced people to easily complete the tuning.

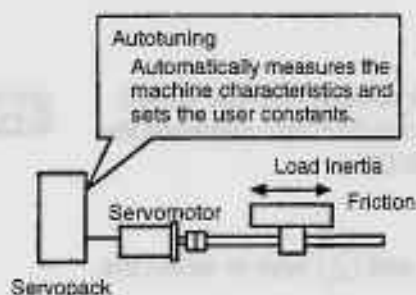

Autotuning is similar to auto-focus for a camera.

1) User Constants Automatically Settable with Autotuning

Cr-04	Speed loop gain
Cr-05	Speed loop integration time constant
Cr-1A	Position loop gain

Once autotuning has been completed, the autotuning procedure can be omitted for subsequent machines, providing the machine specifications remain unchanged.

It is sufficient to directly set the user constants for subsequent machines.

The **machine rigidity** can be selected from one of seven levels.

- NOTE**
- Conduct autotuning with the motor attached to the machine. Make sure that the machine is ready for operation and take sufficient safety precautions when operating the machine.
 - Make sure that the $\overline{P-CON}$ signal is OFF (PI control is selected) before starting autotuning.



Machine Rigidity

The machine rigidity is one of the machine characteristics related to servo control. Set the servo to high response for a machine, such as a machine tool, with high rigidity, and to low response for a machine, such as a robot, with low rigidity.



2) Using Autotuning

Follow the procedure below to run autotuning.



JUSP-OP02A-1

For JUSP-OP02A-1

1) Press to select the user constant setting mode.



2) Select the user constant number Cn-00. (User constant Cn-00 is selected when the power is turned ON.)

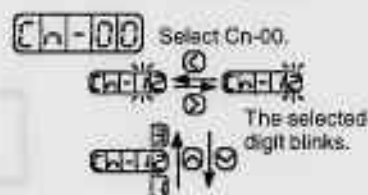

Press the and keys to select the digit.

Press the and keys to change the value.

3) Press to display the current data for the user constant Cn-00.



4) Press the and keys to change the data to 05.



5) Press to display the machine rigidity.

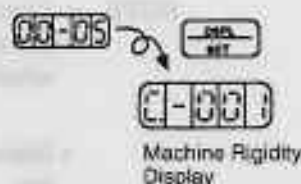

6) Press the and keys to select the machine rigidity. If the actual rigidity is unknown, select medium rigidity.

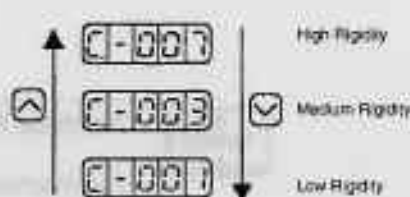

7) Press to select autotuning mode.



- 8) Press  to set the servo ON status.

Select Servo ON/Servo OFF



- 9) Press the  and  keys to operate the motor.

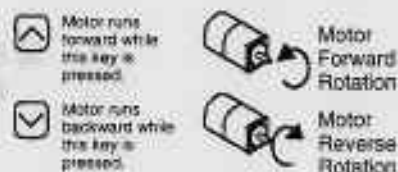

Motor Forward/Reverse Rotation





- 10) When autotuning is complete, the END message is displayed, as shown to the right.

Servo OFF status is automatically selected. If Servo ON/Servo OFF is selected by a signal from an external contact, turn this signal OFF.

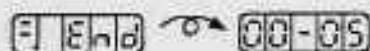

- 11) Release the  and  keys to revert to the  display.



- 12) Press  to return to the setting mode display. This ends the autotuning operation.

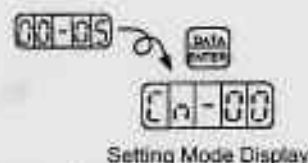



- Refer to sub-section 3) on page 95 for the precautions relating to autotuning.



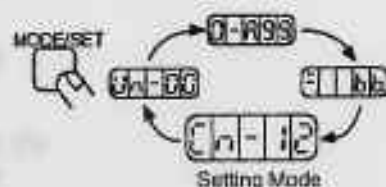

For JUSP-OP03A

- 1) Press  to select the user constant setting mode.

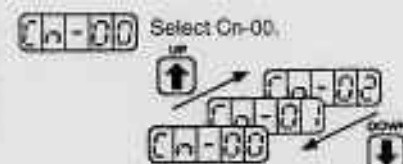

- 2) Press the  and  keys to select the user constant number Cn-00. (User constant Cn-00 is selected when the power is turned ON.)



- 3) Press  to display the current data for the user constant Cn-00.





- 4) Press the  and  keys to change the data to 05.

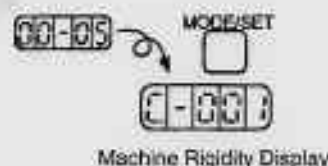

- 5) Press  to display the machine rigidity.



- 6) Press the  and  keys to select the machine rigidity.

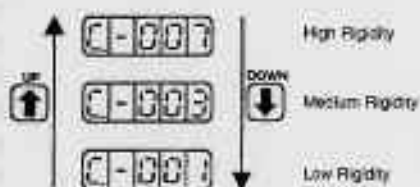

- 7) Press  to select autotuning mode.

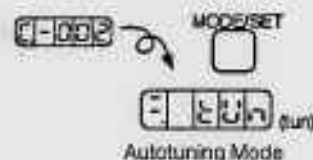

- 8) Press  to set the servo ON status.

Select Servo ON/Servo OFF



- 9) Press the  and  keys to operate the motor.

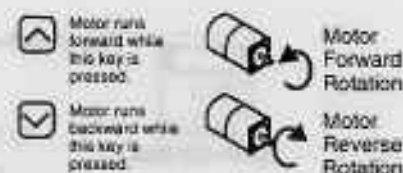

Motor Forward/Reverse Rotation



- 10) When autotuning is complete, the END message is displayed, as shown to the right.



Servo OFF status is automatically selected. If Servo ON/Servo OFF is selected by a signal from an external contact, turn this signal OFF.

- 11) Release the  and  keys to revert to the  display.



- 12) Press  to return to the setting mode display. This ends autotuning operation.

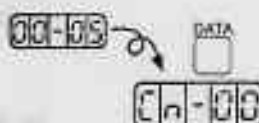





Setting Mode Display

- Refer to the following sub-section 3) for the precautions relating to autotuning.

3) Precautions Relating to Autotuning

a) Speed Setting During Autotuning

The motor speed during autotuning is 500 r/min.

The motor runs intermittently while the  or  (or  or ) key is held down. The motor does not rotate continuously.

b) Machine Rigidity Selection







Select the machine rigidity as described below. If the actual rigidity is unknown, select medium rigidity.

 High Rigidity



 Medium Rigidity

 Low Rigidity

- If the Machine Resonates

At servo ON when the  (or ) key is pressed or when the motor is operated by pressing the  or  ( or ) key, machine resonance indicates an inappropriate machine rigidity setting. Follow the procedure below to correct the machine rigidity setting, and run autotuning once more.

- (1) Press the  (or ) key to cancel autotuning.

- (2) Press the  (or ) key once more to enter the machine rigidity setting mode. Reduce the setting by one.

• If Autotuning Does Not End

Failure of autotuning to end $\boxed{F} \boxed{E} \boxed{n} \boxed{d}$, is caused by an inappropriate machine rigidity setting. Follow the procedure below to correct the machine rigidity setting, and run autotuning once more.

(1) Press the $\boxed{\text{STOP}} \boxed{\text{SET}}$ (or $\boxed{\text{MODE/SET}}$) key to cancel autotuning.

(2) Press the $\boxed{\text{STOP}} \boxed{\text{SET}}$ (or $\boxed{\text{MODE/SET}}$) key once more to enter the machine rigidity setting mode. Increase the setting by one.

Autotuning may not end for machines with large play or extremely low rigidity. In these cases, use conventional manual adjustment.

c) Input Signals

- The OT signal is enabled during autotuning. Input the OT signal during autotuning. To conduct autotuning without inputting these signals, set user constant Cn-01 Bits 2 and 3 to 1.
- Autotuning is not possible during over (P-OT or N-OT signal OFF).

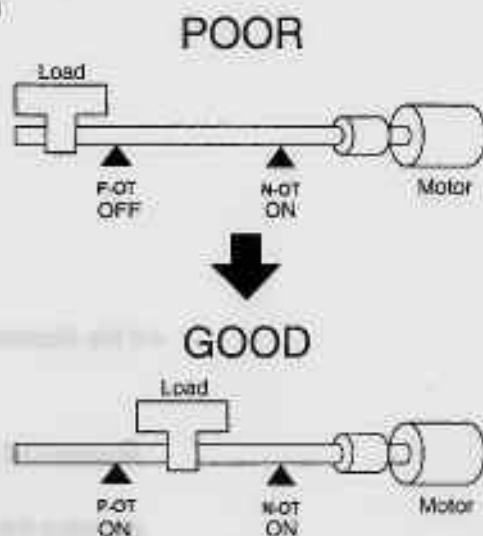

- Conduct autotuning when no overtravel has occurred (both P-OT and N-OT signal ON).

- Set the $\overline{\text{P-CON}}$ signal OFF during autotuning.

- If using the $\overline{\text{S-ON}}$ signal to set the servo ON status, display $\boxed{F} \boxed{E} \boxed{n} \boxed{d}$ before turning ON the $\overline{\text{S-ON}}$ signal.

3.2.4 Clearing Alarm Trace-back Data

- 1) This procedure clears the alarm history, which stores the alarms occurring in the Servo-pack. Each alarm in the alarm history is set to A99, which is not an alarm code. Refer to 3.2.1 Operation in Alarm Trace-back Mode for details.
- 2) Follow the procedure below to clear the alarm trace-back data.

For JUSP-OP02A-1



JUSP-OP02A-1

- 1) Press to select the user constant setting mode.

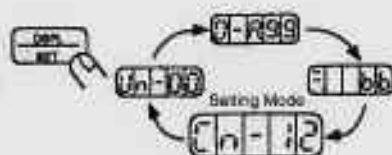

- 2) Select the user constant number Cn-00. (User constant Cn-00 is selected when the power is turned ON.)

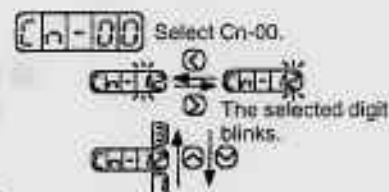

Press the and keys to select the digit.

Press the and keys to change the value.

- 3) Press to display the current data for the user constant Cn-00.



- 4) Press the and keys to change the data to 02.



- 5) Press to clear the alarm trace-back data.



- 6) Press to return to the user constant data display.



For JUSP-OP03A



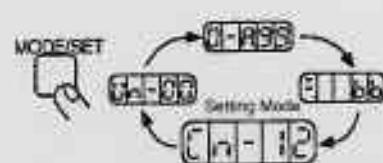

JUSP-OP03A

- 1) Press to select the user constant setting mode.



3.2.5 Checking Motor Type

- 2) Press the  and  keys to select the user constant number Cr-00.
(User constant Cr-00 is selected when the power is turned ON.)

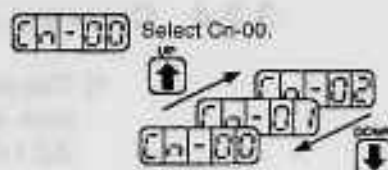

- 3) Press  to display the current data for the user constant Cr-00.



- 4) Press the  and  keys to change the data to 02.



- 5) Press  to clear the alarm trace-back data.



- 6) Press  to return to the user constant data display.



3.2.5 Checking Motor Type

Set Cr-00 to 00-04 to select the motor-type check mode.
This mode is used for maintenance and is not normally used by the customer.

Operation

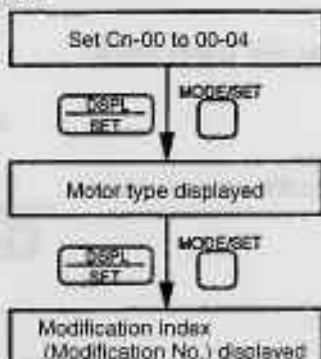

Motor Type Display



Modification Index (Modification No.) Display



$\textcircled{1} \times 10^3 + \textcircled{2} \times 10^2 + \textcircled{3} \times 10 + \textcircled{4} = \text{Modification index (Modification No.)}$

3.2.6 Checking Software Version

- 1) Set Cn-00 to 00-06 to select the software-version check mode.
This mode is used for maintenance and is not normally used by the customer.

Operation:

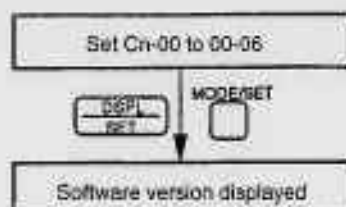

Software Version Display:



SERVO SELECTION AND DATA SHEETS

4

This chapter describes how to select Σ -series servo drives and peripheral devices.

The section also presents the specifications and dimensional drawings required for selection and design.

Choose and carefully read the relevant sections of this chapter.

4.1	Selecting a Σ-series Servo	103
4.1.1	Selecting a Servomotor	103
4.1.2	Selecting a Servopack	110
4.1.3	Selecting a Digital Operator	112
4.2	SGME Servomotor	113
4.2.1	Ratings and Specifications	113
4.2.2	Mechanical Characteristics	120
4.3	Servopack Ratings and Specifications	122
4.3.1	Ratings and Specifications	122
4.3.2	Overload Characteristics	125
4.3.3	Starting Time and Stopping Time	126
4.3.4	Load Inertia	126
4.3.5	Overhanging Loads	128
4.3.6	Power Consumption	129
4.4	Σ-series Dimensional Drawings	130
4.4.1	Servomotor Dimensional Drawings	130
4.4.2	Servopack Dimensional Drawings	140
4.4.3	Digital Operator Dimensional Drawings	143
4.5	Selecting Peripheral Devices	144
4.5.1	Selecting Peripheral Devices	144

4

4.6	Specifications and Dimensional Drawings of Peripheral Devices	149
4.6.1	Cable Specifications and Peripheral Devices	149
4.6.2	Motor Cables	152
4.6.3	Connector Kits	155
4.6.4	Brake Power Supply	159
4.6.5	Encoder Cables	161
4.6.6	1CN Connector	165
4.6.7	Connector Terminal Block Converter Unit	167
4.6.8	Cable with 1CN Connector and One End without Connector	169
4.6.9	Circuit Breaker	169
4.6.10	Noise Filter	170
4.6.11	Magnetic Contactor	171
4.6.12	Surge Suppressor	172
4.6.13	Regenerative Unit	173
4.6.14	Cables for Connecting PC and Servopack	175

4.1 Selecting a Σ -Series Servo

This section describes how to select the Σ -Series Servomotor, Servopack, and Digital Operator.

4.1.1	Selecting a Servomotor	103
4.1.2	Selecting a Servopack	110
4.1.3	Selecting a Digital Operator	112

4.1.1 Selecting a Servomotor

- 1) The selection of SGME Servomotor matched to the servo system in which it is used is based on the servomotor type, that is, the seven alphanumeric characters after "SGME-", described below. The numbers (1) to (6) below correspond to the numbers in the flow-chart for Servomotor selection on the following pages.

SGME-XXXXXX	XXXXXX
SGME-1111111	111111
SGME-1111112	111112
SGME-1111113	111113
.....

- 2) The actual selection of the SGMEEE Servomotor is conducted according to the flowchart in the next page.

Flowchart for Servomotor Selection

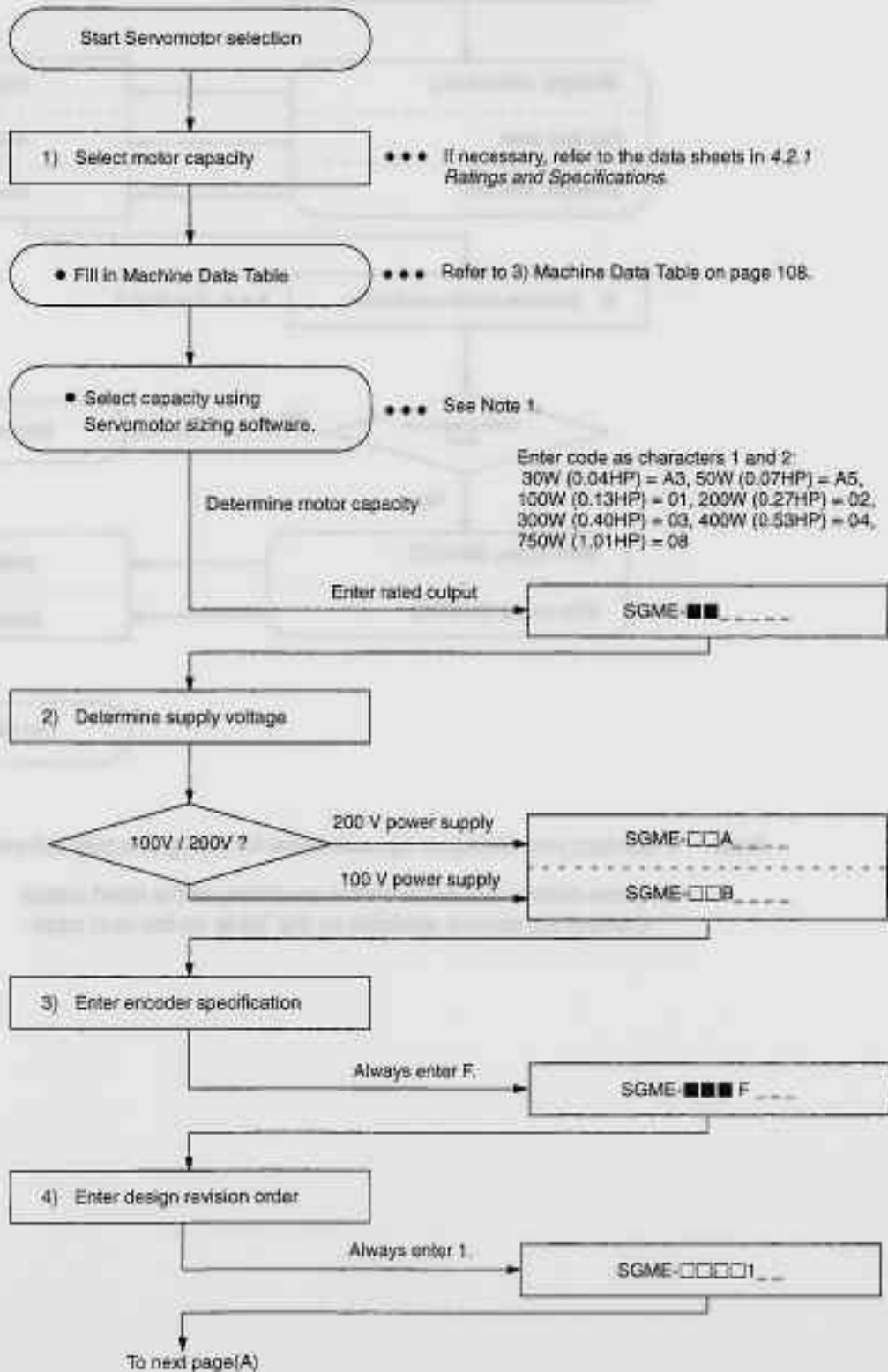

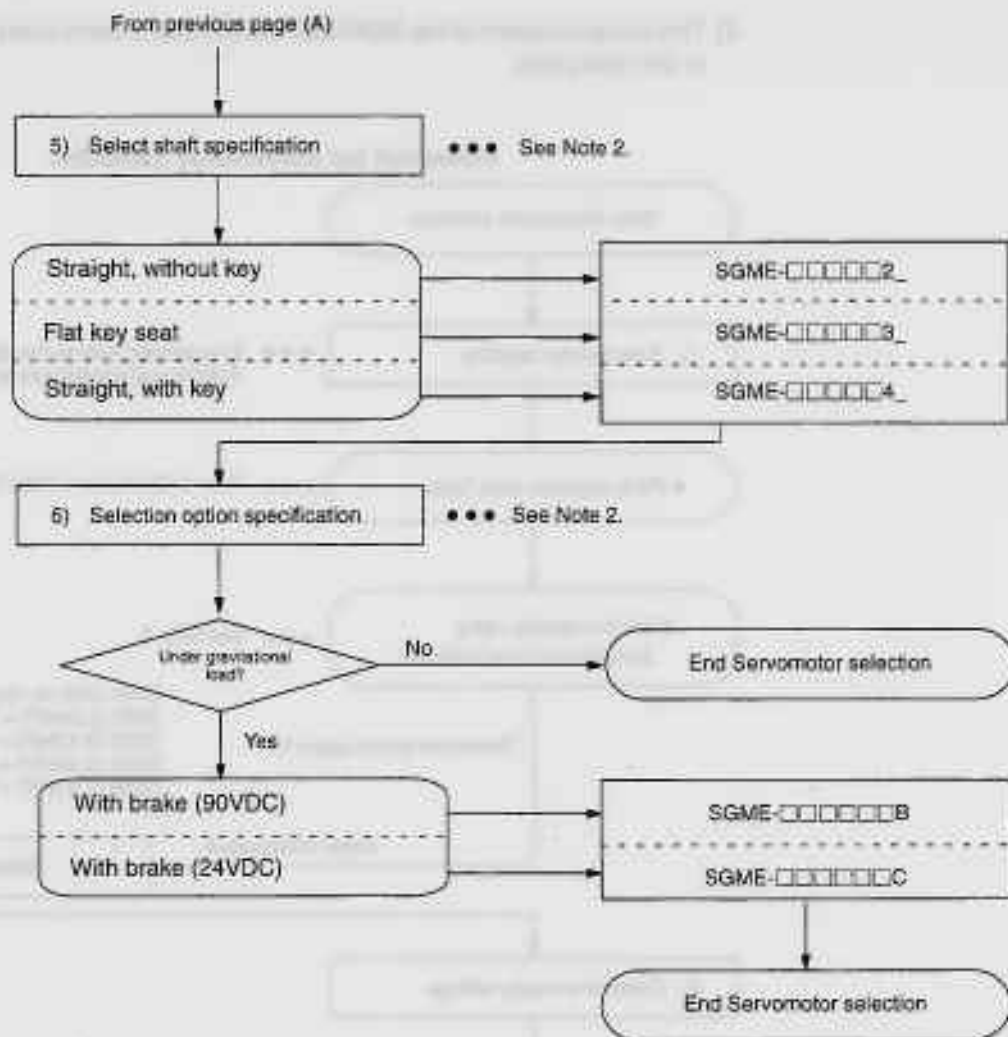

Note 1 Contact your Yaskawa representative for sizing or sizing software.

2 Some options are not available according to the rated output.
Confirm the options available by the Table on the next page.

	Power Supply		Shaft Specifications			Brake 90 VDC	Brake 24 VDC
	100V	200V	Straight, W/O Key	Flat Key Seat	Straight, W/ Key		
30W (0.04HP)	○	○	○	○	×	○	○
50W (0.07HP)	○	○	○	○	×	○	○
100W (0.13HP)	○	○	○	○	×	○	○
200W (0.27HP)	○	○	○	○	○	○	○
300W (0.40HP)	○	×	○	○	○	○	○
400W (0.53HP)	×	○	○	○	○	○	○
750W (1.01HP)	×	○	○	○	○	○	○

○: Available ×: Not available

SERVO SELECTION AND DATA SHEETS

4.1.1 Selecting a Servomotor cont.

3) Machine Data Table

Fill out the machine data table below as an aid to selecting the drive system. When the machine data table is complete, use the servomotor sizing software to select the motor capacity.

1) Ball Screw Horizontal Axis			
Load mass	W	—kg (lb)	
Thrust	F	—kg (lb)	
Coefficient of friction	μ	—	
Overall efficiency	η	—	
Gear ratio	R (= Nm/NI)	—	
Gear+coupling	GD ² g	—kg·cm ² (lb·in ² .)	
Ball screw pitch	P	—mm (in.)	
Ball screw diameter	D	—mm (in.)	
Ball screw length	L	—mm (in.)	
2) Ball Screw Vertical Axis			
Load mass	W ₁	—kg (lb)	
Counterweight	W ₂	—kg (lb)	
Coefficient of friction	μ	—	
Overall efficiency	η	—	
Gear ratio	R (= Nm/NI)	—	
Gear+coupling	GD ² g	—kg·cm ² (lb·in ² .)	
Ball screw pitch	P	—mm (in.)	
Ball screw diameter	D	—mm (in.)	
Ball screw length	L	—mm (in.)	
3) Timing Belt			
Load mass	W	—kg (lb)	
Thrust	F	—kg (lb)	
Coefficient of friction	μ	—	
Overall efficiency	η	—	
Gear ratio	R (= Nm/NI)	—	
Gear+coupling	GD ² g	—kg·cm ² (lb·in ² .)	
Pulley	GD ² d	—kg·cm ² (lb·in ² .)	
Pulley diameter	D	—mm (in.)	
4) Rack and Pinion			
Load mass	W	—kg (lb)	
Thrust	F	—kg (lb)	
Coefficient of friction	μ	—	
Overall efficiency	η	—	
Gear ratio	R (= Nm/NI)	—	
Gear+coupling	GD ² g	—kg·cm ² (lb·in ² .)	
Pinion diameter	D	—mm (in.)	
Pinion thickness	t	—mm (in.)	

5) Roll Feeder

Load GD^2	$GD^2\ell$	—kg·cm ² (lb·in ² .)
Tension	F	—kg (lb)
Press force	P	—kg (lb)
Roller diameter	D	—mm (in.)
Coefficient of friction	μ	—
Overall efficiency	η	—
Gear ratio	R (= Nm/Nl)	—
Gear+coupling	GD^2g	—kg·cm ² (lb·in ² .)

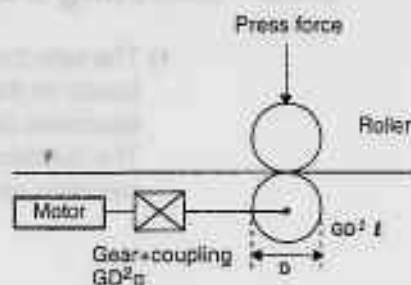

6) Rotor

Load GD^2	$GD^2\ell$	—kg·cm ² (lb·in ² .)
Load torque	$T\ell$	—kg·cm ² (lb·in ² .)
Overall efficiency	η	—
Gear ratio	R (= Nm/Nl)	—
Gear+coupling	GD^2g	—kg·cm ² (lb·in ² .)

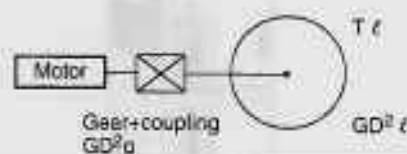

7) Others

Load GD^2	$GD^2\ell$	—kg·cm ² (lb·in ² .)
Load torque	$T\ell$	—kg·cm ² (lb·in ² .)
Motor speed	Nm	—r/min
DUTY	t_d	—s
Positioning time	t_s	—s
Accel/decel time	t_a	—s

● Duty cycle

DUTY	t_d	—s
Positioning distance	L_s	—mm (in.)
Moving member speed	$V\ell$	—m/min
Positioning time	t_s	—s
Accel/decel time	t_a	—s

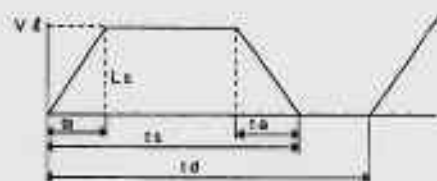

Enter either $V\ell$ or t_s . If both are entered, specify priority.

● Operating environment	Operating temperature
	Others

4.1.2 Selecting a Servopack

1) The selection of an SGDE Servopack matched to the servo system in which it is used is based on the Servopack type, that is, the four alphanumeric characters after "SGDE-", described below.

The numbers (1) to (3) below correspond to the numbers in the flowchart for Servopack selection on the following pages.



SGDE- 01 A P

Σ-Series
SGDE: SGDE Servopack

- 1) Rated output
 A3: 30W (0.04HP) A5: 50W (0.07HP)
 01: 100W (0.13HP) 02: 200W (0.27HP)
 03: 300W (0.40HP) 04: 400W (0.53HP)
 08: 750W (1.01HP)
- 2) Supply voltage
 A: 200V B: 100V
- 3) Model
 P: For position control

Flowchart for Servopack selection

	Selected Servopack type
Example	SGDE-0102A0P
Axis 1	SGDE-0102A0P
Axis 2	SGDE-0102A0P
• • •	• • • • •

- 2) The actual selection of the SGDE Servopack is conducted according to the following flowchart.

Flowchart for Servopack Selection

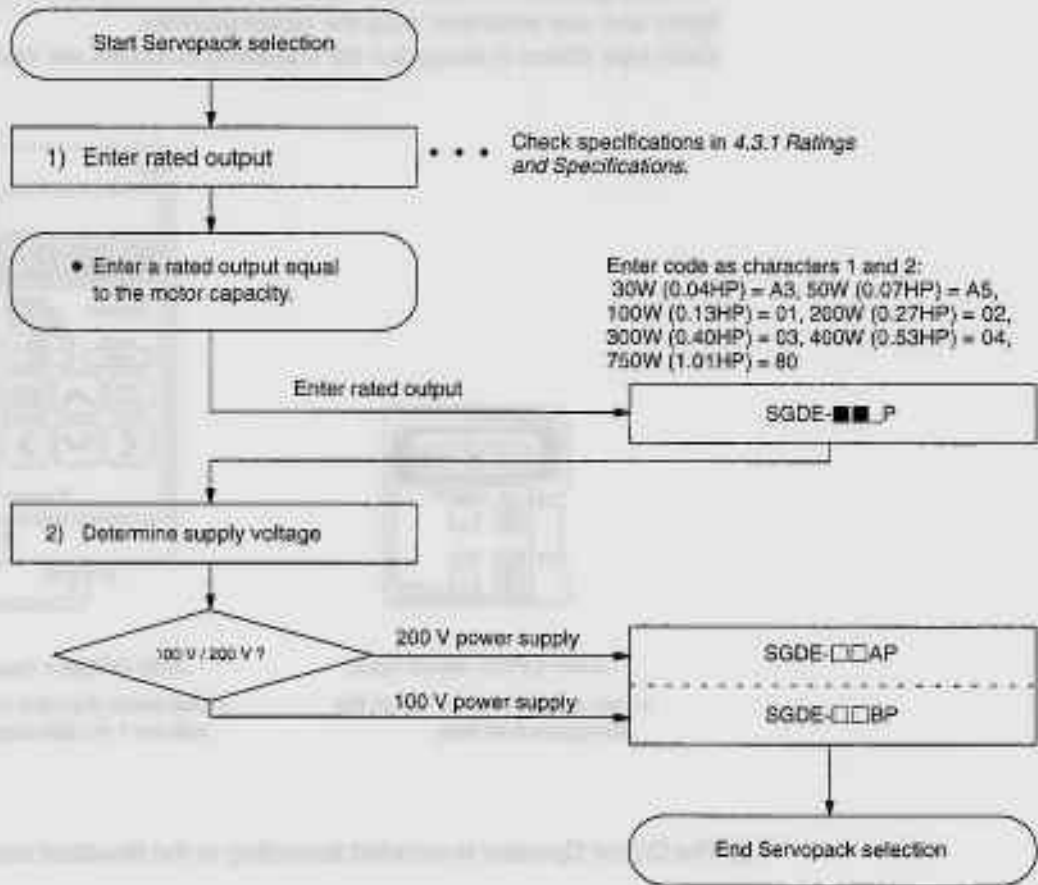

4.1.3 Selecting a Digital Operator

- The following two types of Digital Operator are available.
The two types cannot be used simultaneously. However, it is convenient to prepare both types and use whichever suits the circumstances.
Each type differs in shape but the operating functions are identical.



JUSP-OP03A (Mount Type)

- Use attached to the top of the Servopack front face.

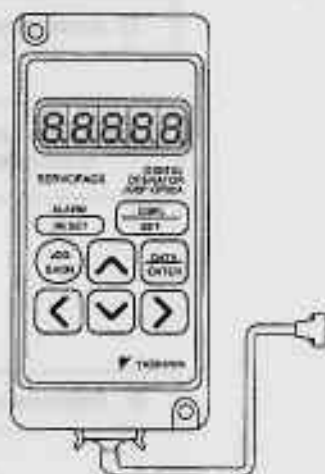

JUSP-OP02A-1 (Hand-held Type)

- Use held in the hand while connected with the 1 m cable supplied.

- The Digital Operator is selected according to the flowchart below.

Flowchart for Digital Operator Selection

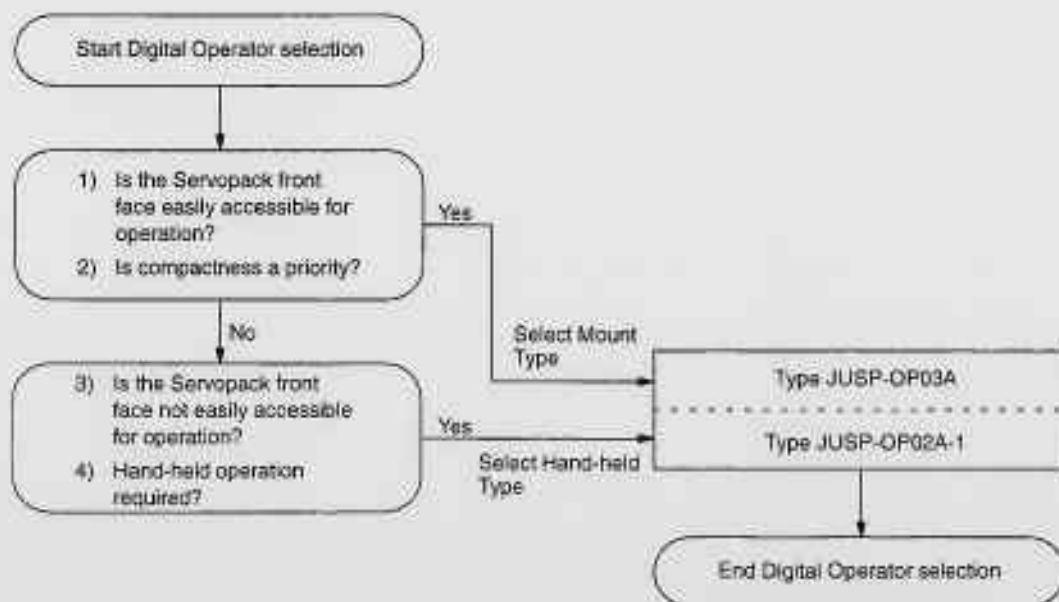

4.2 SGME Servomotor

This section presents tables of ratings and specifications for SGME Servomotor. Refer to these tables when selecting a Servomotor.

5.2.1	Ratings and Specifications	113
5.2.2	Mechanical Characteristics	120

4.2.1 Ratings and Specifications

1) Ratings and Specifications of 200-VAC SGME Servomotors

Time rating:	continuous
Thermal class:	B
Vibration class:	15 μ m or below
Withstand voltage:	1500 VAC
Insulation resistance:	500 VDC 10M Ω min.
Enclosure:	totally enclosed, self-cooled
Ambient temperature:	0 to 40°C
Ambient humidity:	20% to 80% (non-condensing)
Excitation:	permanent magnet
Drive method:	direct drive
Mounting:	flange method

SGME Servomotor		A3A	A5A	01A	02A	04A	08A
Rated Output* ¹	W (HP)	30 (0.04)	50 (0.07)	100 (0.13)	200 (0.27)	400 (0.53)	750 (1.01)
	Rated Torque* ^{1,2}						
	N·m	0.095	0.159	0.318	0.637	1.27	2.39
	(oz·in)	(13.5)	(22.6)	(45.1)	(90.1)	(181)	(338)
Instantaneous Peak Torque* ¹	N·m	0.29	0.48	0.96	1.91	3.82	7.1
	(oz·in)	(40.5)	(67.7)	(135)	(270)	(542)	(1010)
Rated Current* ¹	A (rms)	0.42	0.6	0.87	2.0	2.6	4.4
Instantaneous Max Current* ¹	A (rms)	1.3	1.9	2.8	6.0	8.0	13.9
Rated Speed* ¹	r/min	3000					
Instantaneous Max Speed* ¹	r/min	4500					
Torque Constant* ¹	N·m/A (rms)	0.255	0.286	0.408	0.355	0.533	0.590
	(oz·in/A) (rms)	(36.2)	(40.5)	(57.8)	(50.2)	(75.5)	(83.5)
Moment of Inertia [J _M]	$\times 10^{-4}$ kg·m ²	0.021	0.026	0.040	0.123	0.191	0.671
	($\times 10^{-3}$ oz·in·s ²)	(0.288)	(0.368)	(0.576)	(1.74)	(2.70)	(9.52)
Rated Power Rate* ¹	kW/s	4.36	9.63	25.4	32.8	84.6	85.1
Rated Angular Acceleration* ¹	rad/s ²	45200	61200	79500	51800	666000	35600
Inertia Time Constant	ms	1.5	0.9	0.5	0.4	0.3	0.3
Inductive Time Constant	ms	1.5	1.8	1.9	5.4	6.4	13

■ 200-VAC SGME Servomotor Torque-Motor Speed Characteristics

• SGME-A3A

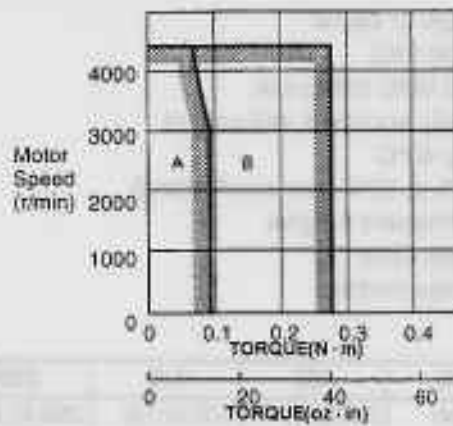

• SGME-A5A

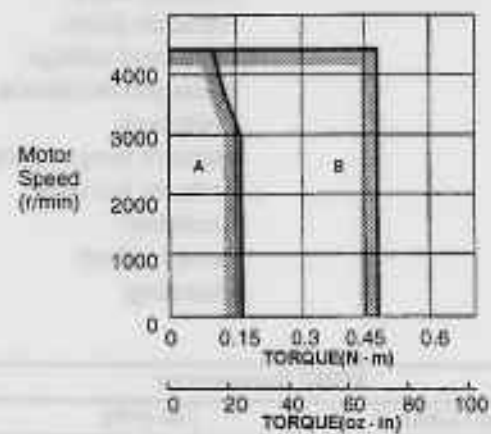

• SGME-01A

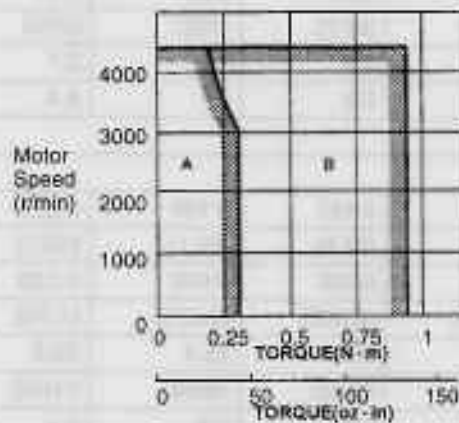

• SGME-02A

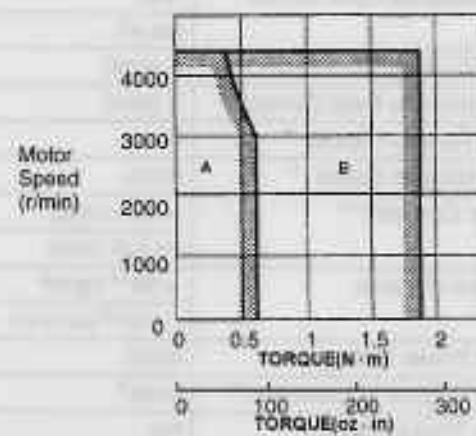

• SGME-04A

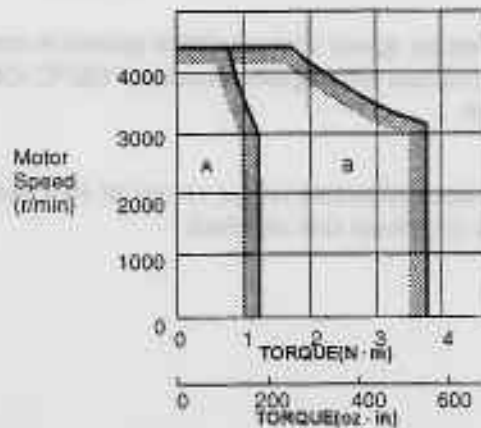

• SGME-08A

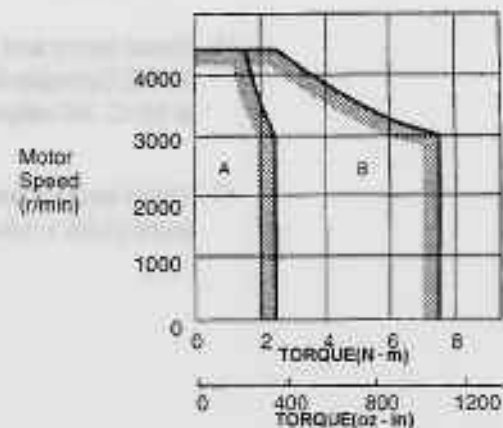

A: Continuous Duty Zone
B: Intermittent Duty Zone

2) Ratings and Specifications of 100-VAC SGME Servomotors

Time rating:	continuous
Thermal class:	B
Vibration class:	15 μ m or below
Withstand voltage:	1500 VAC
Insulation resistance:	500 VDC 10M Ω min.
Enclosure:	totally enclosed, self-cooled
Ambient temperature:	0 to 40°C
Ambient humidity:	20% to 80% (non-condensing)
Excitation:	permanent magnet
Drive method:	direct drive
Mounting:	flange method

SGME Servomotor		A3B	A5B	01B	02B	03B
Rated Output *1	W (HP)	30 (0.04)	50 (0.07)	100 (0.13)	200 (0.27)	300 (0.40)
Rated Torque *1 *2	N·m	0.095	0.159	0.318	0.637	0.95
	(oz·in)	(13.5)	(22.6)	(45.1)	(90.1)	(135.0)
Instantaneous Peak Torque *1	N·m	0.29	0.48	0.96	1.91	3.72
	(oz·in)	(40.5)	(67.7)	(135)	(270)	(527.7)
Rated Current *1	A (rms)	0.63	0.9	2.2	2.7	3.7
Instantaneous Peak Current *1	A (rms)	2.0	2.9	7.1	8.4	14.8
Rated Rotation Speed *1	r/min	3000				
Max. Rotation Speed *1	r/min	4500				
Torque Constant *1	N·m/A (rms)	0.168	0.194	0.156	0.255	0.279
	oz·in/A (rms)	(23.8)	(27.5)	(22.1)	(36.1)	(39.6)
Moment of Inertia	$\times 10^{-4}$ kg·m ²	0.021	0.026	0.040	0.123	0.191
	($\times 10^{-3}$ oz·in·s ²)	(0.288)	(0.368)	(0.576)	(1.74)	(2.71)
Rated Power Rating *1	KW/S	4.36	9.63	25.4	32.8	47.3
Rated Angular Acceleration *1	rad/s ²	45200	61200	79500	51800	49700
Inertia Time Constant	ms	1.6	0.9	0.6	0.4	0.3
Inductive Time Constant	ms	1.3	1.6	1.6	5.7	5.3

*1 These items and torque-motor speed characteristics quoted in combination with an SGDE Servopack at an armature winding temperature of 100°C. Other values quoted at 20°C. All values typical.

*2 Rated torques are continuous allowable torque values at 40°C with a 250 x 250 x 6 (mm) (9.84 x 9.84 x 0.24 (in.)) heat sink attached.

NOTE The ratings and specifications above refer to a standard Servomotor.

Add the numerical values below to the moment of inertia values in the table for a motor fitted with a holding brake.

Other specifications will also change slightly.

Item		Type	SGME-				
			A3B	A5B	01B	02B	03B
Holding brake	$\times 10^{-4} \text{ kg.m}^2$		0.0085			0.058	
	$(\times 10^{-9} \text{ oz.in.s}^2)$		0.12			0.82	

■ 100-VAC SGME Servomotor Torque-Motor Speed Characteristics

• SGME-A3B

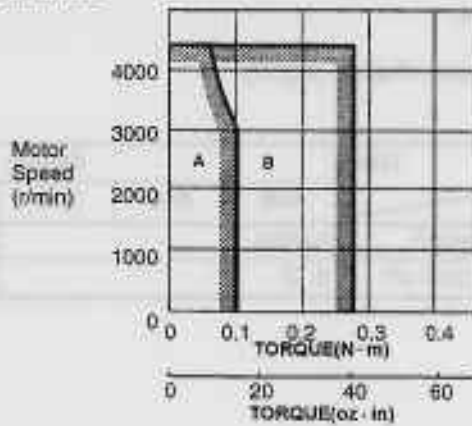

• SGME-A5B

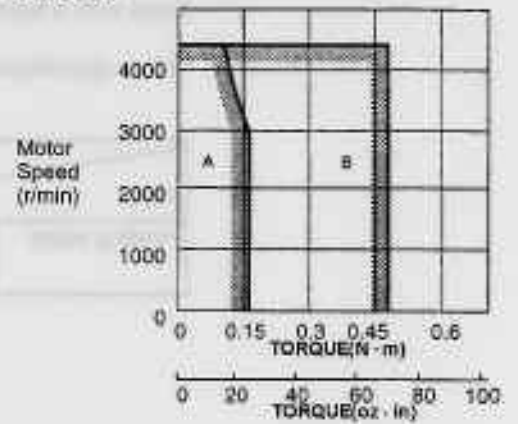

• SGME-01B

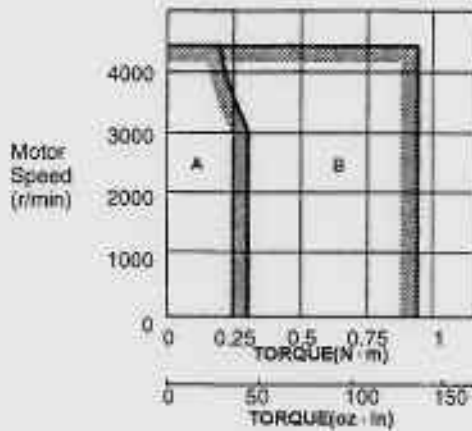

• SGME-02B

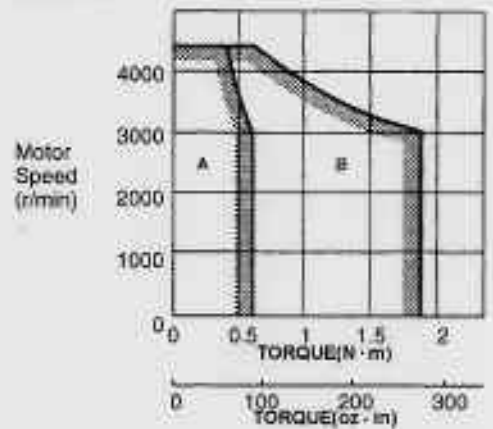

• SGME-03B

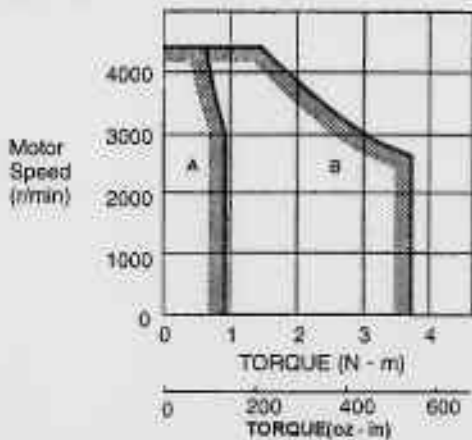

A: Continuous Duty Zone
B: Intermittent Duty Zone

3) Specifications of SGME Servomotors with Holding Brake

Ratings and specifications of Servomotors with **holding brake** are basically the same as those of standard (without holding brake) Servomotors shown in 1) and 2). However, the moment of inertia is as shown below. Other specifications will also change slightly.

Item \ Type		SGME-										
		A3A	A5A	01A	02A	04A	08A	A3B	A5B	01B	02B	03B
Moment of Inertia (W/brake)	$\times 10^{-4}$ kg.m	0.0295	0.0345	0.0485	0.181	0.249	0.811	0.0295	0.0345	0.0485	0.181	0.372
	$\times 10^{-3}$ oz-in-s ²	0.408	0.488	0.696	2.556	3.516	11.5	0.408	0.488	0.696	2.556	3.53

Electrical Specifications of the Holding Brake

Motor Type	Motor Capacity (W)	Holding Brake Specifications					
		Capacity (W)	Holding Torque (Kg-cm)	90VDC		24VDC	
				Coil Resistance Ω (at 20°C)	Rated Current A (at 20°C)	Coil Resistance Ω (at 20°C)	Rated Current A (at 20°C)
SGME-A3□□□□	30	6	2.0	1350	0.067	96	0.25
SGME-A5□□□□	50	6	2.0	1350	0.067	96	0.25
SGME-01□□□□	100	6	3.5	1350	0.067	96	0.25
SGME-02□□□□	200	6.5	15	1246	0.072	89	0.27
SGME-03□□□□	300	6.5	15	1246	0.072	89	0.27
SGME-04□□□□	400	6.5	15	1246	0.072	89	0.27
SGME-08□□□□	750	6	25	1350	0.067	96	0.28



Holding Brake

The holding brake is automatically applied to the motor shaft to prevent the load falling in vertical axis applications when the motor power supply is turned off or fails. It is only to hold the load and cannot be used for stopping motor.

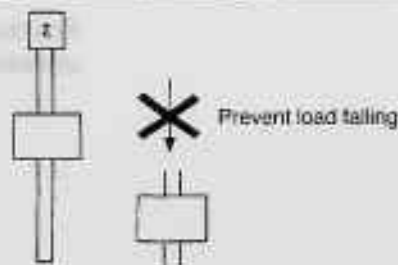

4.2.2 Mechanical Characteristics

1) Allowable Radial Load, Allowable Thrust Load

The output shaft allowable loads for SGME Servomotor are shown below.

Conduct mechanical design such that the thrust loads and radial loads do not exceed the values stated below.

Servomotor Type	Allowable Radial Load F_r [N(lb)]	Allowable Thrust Load F_s [N(lb)]	Reference Diagram
SGME-A3	68 (15)	54 (12)	
SGME-A5	68 (15)	54 (12)	
SGME-01	78 (17)	54 (12)	
SGME-02	245 (55)	74 (16)	
SGME-03	245 (55)	74 (16)	
SGME-04	245 (55)	74 (16)	
SGME-08	392 (88)	147 (33)	

2) Mechanical Tolerance

The tolerances of the SGME Servomotor output shaft and installation are shown in the table below.

Tolerance (T.I.R.)	Reference Diagram
Perpendicularity between flange face and output shaft (A) 0.08mm (0.0031in.)	
Mating concentricity of flange O.D. (B) 0.06mm (0.0024in.)	
Run-out at end of shaft (C) 0.03mm (0.0012in.)	

Note T.I.R. = Total Indicator Reading

3) Direction of Motor Rotation

Positive rotation of the servomotor is counter-clockwise, viewing from the load.

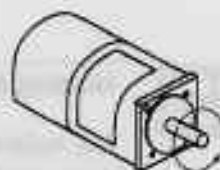

4) Impact Resistance

Mount the servomotor with the axis horizontal. The servomotor must withstand the following vertical impacts.



- Impact Acceleration: 98 m/s^2
- Number of Impacts: 2

NOTE In SGME Servomotor, an accurate detector is attached to the shaft at the opposite end from the load. Avoid applying impacts directly to the shaft as these may damage the detector.

5) Vibration Resistance

Mount the servomotor with the axis horizontal. The servomotor must withstand the following vibration accelerations in three directions: vertical, transverse, and longitudinal.

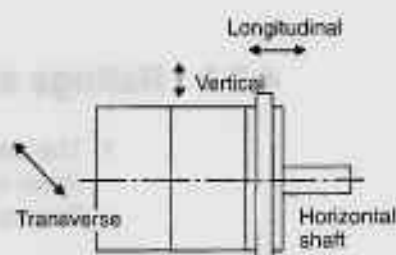

- Vibration Acceleration: 24.5 m/s^2

6) Vibration Class

The SGME Servomotor meets the following **vibration class** at rated speed.

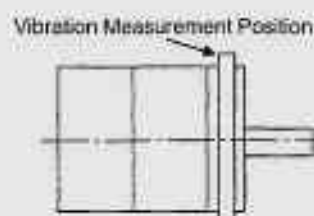

- Vibration Class: $15\mu\text{m}$ or below

**Vibration Class**

Vibration class $15\mu\text{m}$ or below indicates that the total amplitude of vibration of the motor alone, running at rated speed, does not exceed $15\mu\text{m}$.

4.3 Servopack Ratings and Specifications

This section presents tables of SGDE Servopack ratings and specifications.

4.3.1	Ratings and Specifications	122
4.3.2	Overload Characteristics	125
4.3.3	Starting Time and Stopping Time	126
4.3.4	Load Inertia	126
4.3.5	Overhanging Loads	128
4.3.6	Power Consumption	129

4.3.1 Ratings and Specifications

- The ratings and specifications of the SGDE Servopack are shown on the next page. Refer to them as required when selecting a Servopack. Refer to the specifications listed for combination with the appropriate type of Servomotor.

2) Ratings and Specifications of SGDE Servopack

Voltage			200 VAC					100 VAC						
SGDE Servopack			A3AP	A5AP	01AP	02AP	04AP	08AP	A3BP	A5BP	01BP	02BP	03BP	
Max. Applicable Motor Capacity W (HP)			30 (0.04)	50 (0.07)	100 (0.13)	200 (0.27)	400 (0.53)	750 (1.01)	30 (0.04)	50 (0.07)	100 (0.13)	200 (0.27)	300 (0.40)	
Combined Specifications	Motor	Type SGME-	A3AF	A5AF	01AF	02AF	04AF	08AF	A3BF	A5BF	01BF	02BF	03BF	
		Motor Capacity W (HP)	30 (0.04)	50 (0.07)	100 (0.13)	200 (0.27)	400 (0.53)	750 (1.01)	30 (0.04)	50 (0.07)	100 (0.13)	200 (0.27)	300 (0.40)	
		Rated/ Max. Motor Speed	3000/4500 r/min					3000/4500 r/min						
		Applicable encoder	Incremental encoder 1024 P/R											
		Allowable Load Iner- tia ¹⁾ J _L × 10 ⁻⁴ kg·m ² (× 10 ⁻³ oz·in·s ²)	0.63 (8.80)	0.78 (11.0)	1.20 (17.0)	3.69 (52.2)	3.82 (54.1)	13.4 (189)	0.63 (8.80)	0.78 (11.0)	1.20 (17.0)	3.69 (52.2)	3.82 (54.1)	
		Continuous Output Current	0.42	0.6	0.87	2.0	2.6	4.4	0.63	0.90	2.2	2.7	3.7	
Max. Output Current			1.3	1.9	2.8	6.0	8.0	13.9	2.0	2.9	7.1	8.4	14.8	
Basic Specifications	Power Supply		Single-phase 200 to 230 VAC, +10% to -15%, 50/60 Hz ²⁾					Single-phase 100 to 115 VAC ²⁾ , +10% to -15%, 50/60 Hz						
	Control Method		Single-phase, full-wave rectification IGBT-PWM (sine-wave driven)											
	Feedback		Incremental encoder 1024 P/R											
	Location	Ambient Temp.	0 to 50°C ³⁾											
		Storage Temp.	-20°C to +85°C											
		Ambient/ Storage Humidity	90% or less (with no condensation)											
		Vibration/ Shock Re- sistance	0.5/2G											
	Structure		Base mounted											
Approx. Mass kg (lb)		0.9 (1.98)			1.2 (2.65)		1.5 (3.31)		0.9 (1.98)			1.2 (2.65)		1.5 (3.31)
Performance	Position Complete		0 to 250 reference units.											
	Width Setting		Reference unit: minimum unit of position data which moves load											

SERVO SELECTION AND DATA SHEETS

4.3.1 Ratings and Specifications

Voltage			200 VAC	100 VAC
Input Signal	Reference Pulse	Type	SIGN + PULSE train, 90° phase difference 2-phase pulse, (A-phase+B-phase), CCW pulse+CW pulse	
		Pulse Form	Line driver (+5 V level), open collector (+5 V or +12 V level)	
		Pulse Frequency	0 to 225 kpps	
	Control Signal	CLEAR (input pulse form identical to reference pulse)		
I/O Signals	Position Output	Output Form	C-phase open collector output	
	Sequence Input	Servo ON, P drive, forward run stop (P-OT), reverse run stop (N-OT), alarm reset		
	Sequence Output	Positioning complete, brake interlock		
Dynamic Brake		Operated at main power OFF, servo alarm or overtravel.		
External Regenerative Unit		Required when exceeding the allowable load inertia		
Overtravel		Dynamic brake stop at P-OT or N-OT		
Protective Functions		Overcurrent, grounding, overload, overvoltage, overspeed, overrun prevention, CPU error, overflow		
Indicators		Alarm and power LEDs		
		Programming panel is available as an option		
Others		Brake interlock signal output, reverse run connection, JOG run, electronic gear, auto-tuning		

*1 Allowable load inertia ranges require no optional external regenerative unit. Values are 30 times the moment of inertia for 30 W (0.04 HP) to 200 W (0.27 HP) Servomotors, and 20 times for 400 W (0.53 HP) and 750 W (1.01 HP) Servomotors. If load inertias exceed these ranges, restrict the operation or use a regenerative unit.

*2 Supply voltage should not exceed 230 V + 10% (253 V) or 115 V + 10% (127 V). A step-down transformer is required if the voltage should exceed these values.

*3 Use within the ambient temperature range. When enclosed in a box, the internal temperatures must not exceed the ambient temperature range.

4.3.2 Overload Characteristics

The Servopack has a built-in overload protective function to protect the Servopack and Servomotor from overload. Therefore, the Servopack allowable power is limited by the overload protective function, as shown below.

The overload detection level is quoted under **hot start** conditions at a motor ambient temperature of 40°C.

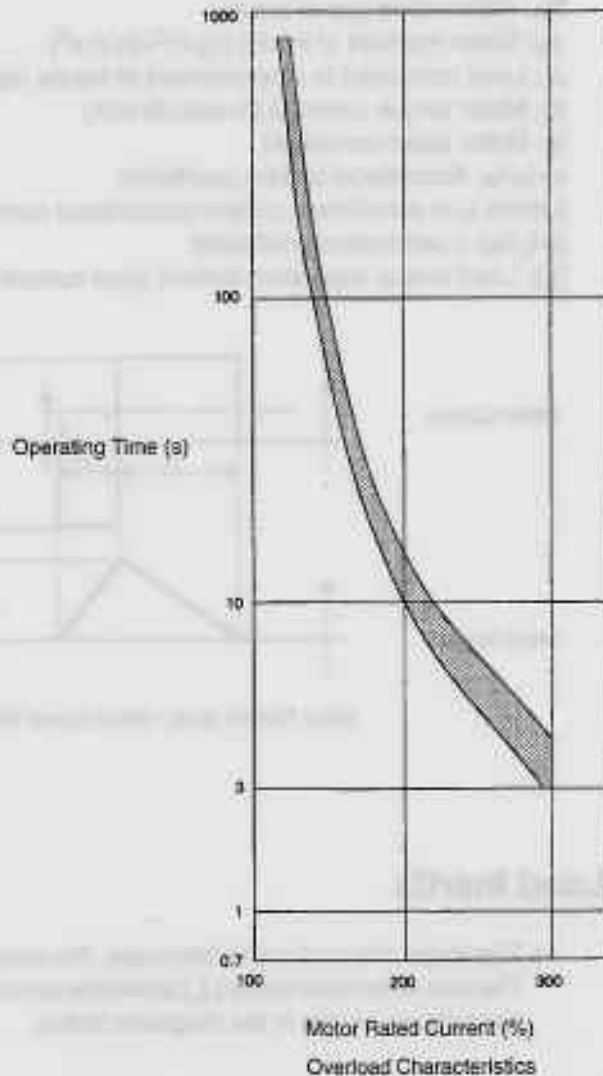

Hot Start

Indicates that both Servopack and Servomotor have run long enough at rated load to be thermally saturated.

4.3.3 Starting Time and Stopping Time

- 1) The motor starting time (t_r) and stopping time (t_f) under constant load are calculated by the following formulas. The motor viscous torque and friction torque are ignored.

$$\text{Starting Time: } t_r = 104.7 \times \frac{N_R (J_M + J_L)}{K_t I_R (\alpha - \beta)} \text{ [ms]}$$

$$\text{Stopping Time: } t_f = 104.7 \times \frac{N_R (J_M + J_L)}{K_t I_R (\alpha + \beta)} \text{ [ms]}$$

N_R : Motor rated speed (r/min.)

J_M : Motor moment of inertia ($\text{kg}\cdot\text{m}^2 = \text{lb}\cdot\text{in}\cdot\text{s}^2$) ... ($\text{GD}_M^2/4$)

J_L : Load converted to shaft moment of inertia ($\text{kg}\cdot\text{m}^2$) .. ($\text{GD}_L^2/4$)

K_t : Motor torque constant ($\text{N}\cdot\text{m}/\text{A} = \text{lb}\cdot\text{in}/\text{A}$)

I_R : Motor rated current (A)

$\alpha = I_P/I_R$: Accel/decel current coefficient

[where I_P is accel/decel current (accel/decel current is α times the motor rated current) (A)]

$\beta = I_L/I_R$: Load current coefficient

[I_L : Load torque equivalent current (load current is β times the motor rated current) (A)]

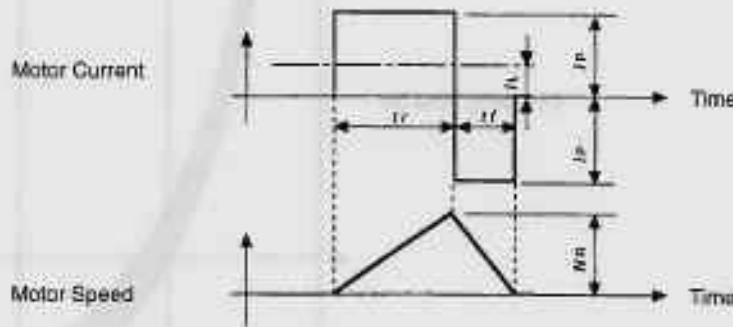

Motor Current (size) - Motor Speed Timing Chart

4.3.4 Load Inertia

- 1) The larger the load inertia becomes, the worse the movement response of the load. The size of the load inertia [J_L] allowable when using a Servomotor depends on the motor capacity, as shown in the diagrams below.

- Small Load Inertia

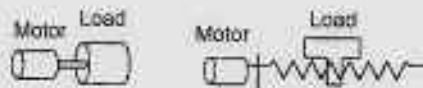

- Large Load Inertia

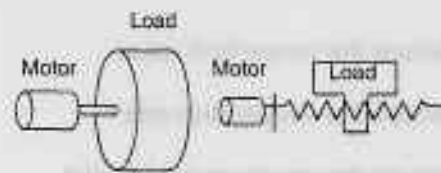

Load Inertia
 $\times 10^{-4} \text{ kg}\cdot\text{m}^2$
 $(\times 10^{-3} \text{ oz}\cdot\text{in}\cdot\text{s}^2)$

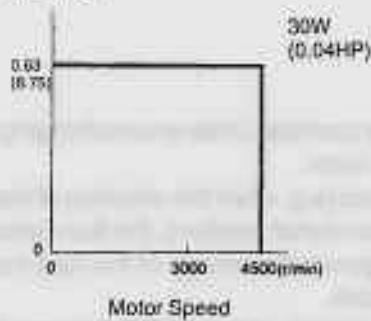

Load Inertia
 $\times 10^{-4} \text{ kg}\cdot\text{m}^2$
 $(\times 10^{-3} \text{ oz}\cdot\text{in}\cdot\text{s}^2)$

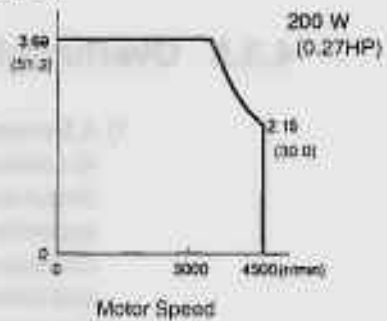

Load Inertia
 $\times 10^{-4} \text{ kg}\cdot\text{m}^2$
 $(\times 10^{-3} \text{ oz}\cdot\text{in}\cdot\text{s}^2)$

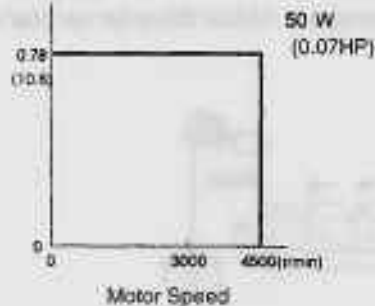

Load Inertia
 $\times 10^{-4} \text{ kg}\cdot\text{m}^2$
 $(\times 10^{-3} \text{ oz}\cdot\text{in}\cdot\text{s}^2)$

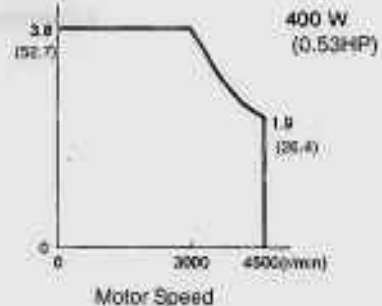

Load Inertia
 $\times 10^{-4} \text{ kg}\cdot\text{m}^2$
 $(\times 10^{-3} \text{ oz}\cdot\text{in}\cdot\text{s}^2)$

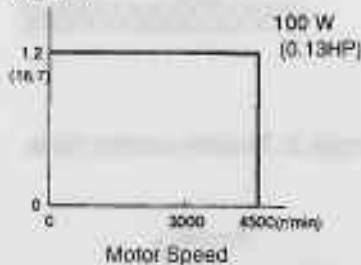

Load Inertia
 $\times 10^{-4} \text{ kg}\cdot\text{m}^2$
 $(\times 10^{-3} \text{ oz}\cdot\text{in}\cdot\text{s}^2)$

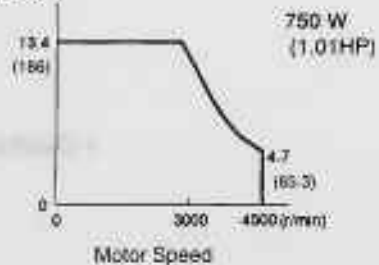

Note The above diagrams represent deceleration under maximum torque. Applying an acceleration/deceleration curve to the reference allows operation outside the range of the diagrams. (That is, characteristics change according to pattern of operation and load conditions).

- 2) An overvoltage alarm is likely during deceleration if the load inertia exceeds the range of the diagrams. Take one of the countermeasures below.
 - a) Reduce the torque limit value.
 - b) Reduce the deceleration rate.
 - c) Reduce the maximum speed used.
 - d) Add a regenerative unit.

4.3.5 Overhanging Loads

- 1) A Servomotor may not be operated under an overhanging load, that is a load which tends to continually rotate the motor.

Under an overhanging load (e.g. when the direction of the torque applied by the motor is opposite from the direction of shaft rotation), the Servopack regenerative brake is applied continuously and the regenerative energy of the load may exceed the allowable range and damage the Servopack.

The regenerative brake capacity of the SGDE Servopack is rated for short-time operation, approximately equivalent to the deceleration stopping time.

- Overhanging Load Example 1: Motor drive for vertical axis, using no counterweight

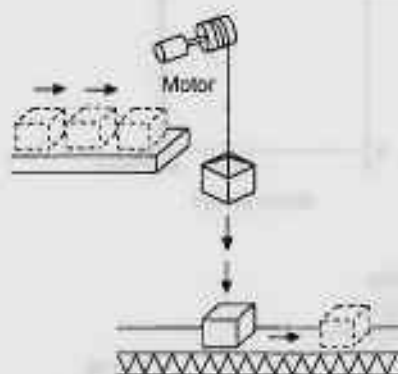

- Overhanging Load Example 2: Tension control drive

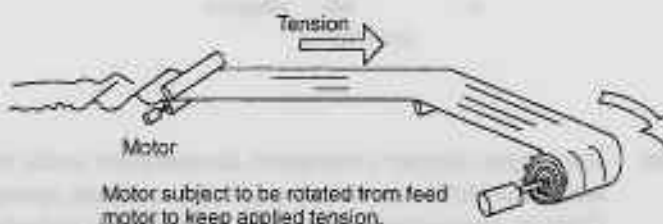

4.3.6 Power Consumption

Servopack SGDE-		In-rush Current (Peak Value) A	Output Current (Effective Value) A	Power Loss W			<Total> Power Loss W
				Main Circuit	Control Circuit	DB Circuit	
Supply Voltage 200V	A3AP (30W-0.04HP)	20	0.42	2.9	13	Varies depending on operating conditions	15.9
	A5AP (50W-0.07HP)	20	0.6	4.2	13		17.2
	01AP (100W-0.13HP)	30	0.87	6.3	13		19.3
	02AP (200W-0.27HP)	30	2.0	14.5	13		27.5
	04AP (400W-0.53HP)	30	2.6	22.2	13		35.2
	08AP (750W-1.01HP)	70	4.4	36.1	13		49.1
Supply Voltage 100V	A3BP (30W-0.04HP)	10	0.63	2.9	13	15.9	
	A5BP (50W-0.07HP)	15	0.9	4.4	13	17.4	
	01BP (100W-0.13HP)	15	2.2	12.0	13	25.0	
	02BP (200W-0.27HP)	15	2.7	16.2	13	29.2	
	03BP (300W-0.40HP)	35	3.7	20.1	13	33.1	

4.4 Σ -Series Dimensional Drawings

This section presents dimensional drawings of the Σ -Series Servomotor, Servopack, and Digital Operator.

4.4.1	Servomotor Dimensional Drawings	130
4.4.2	Servopack Dimensional Drawings	140
4.4.3	Digital Operator Dimensional Drawings	143

4.4.1 Servomotor Dimensional Drawings

1) The dimensional drawings of the SGME Servomotors are broadly grouped into the following two categories.

- a) Incremental encoder, no brake (from page 131)
- b) Incremental encoder, with brake (from page 135)

Motor capacities are available as 30 W (0.04 HP), 50 W (0.07 HP), 100 W (0.13 HP), 200 W (0.27 HP), 300 W (0.40 HP), 400 W (0.53 HP), 750 W (1.01 HP). These are grouped into three categories, as follows:

- 30W (0.04 HP), 50W (0.07 HP), 100W (0.13 HP)
- 200W (0.27 HP), 300W (0.40 HP), 400W (0.53 HP)
- 750W (1.01 HP)

(1) SGME Servomotor
Incremental encoder, no brake

• 30W (0.04 HP), 50W (0.07 HP), 100W (0.13 HP)

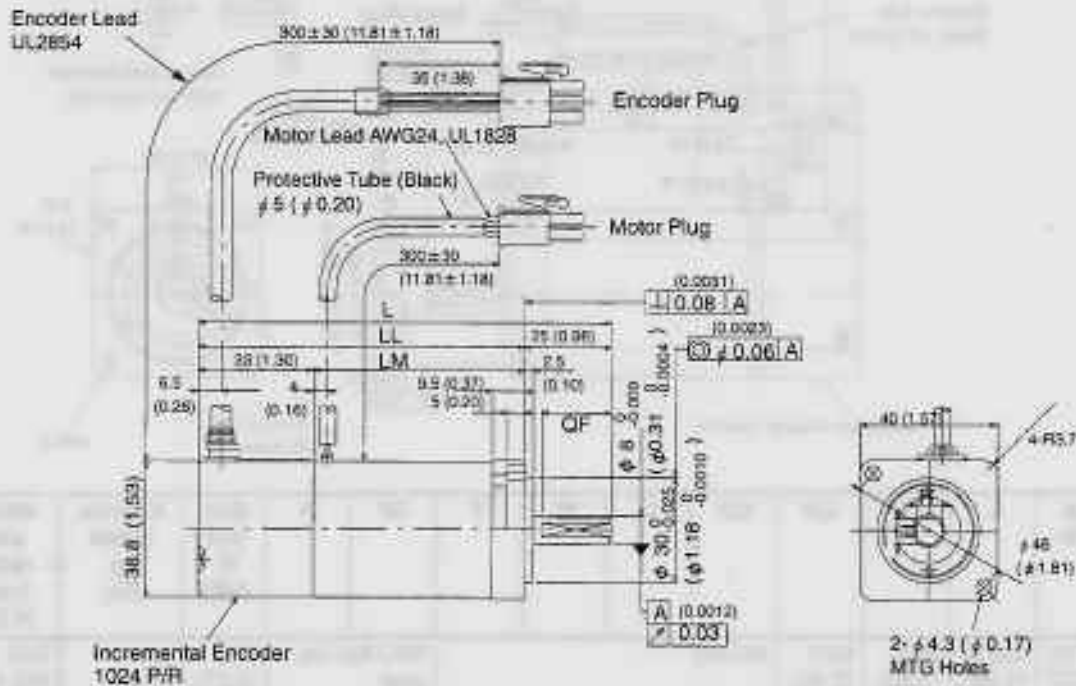

Type SGME-	L	LL	LM	QF	H	Output W (HP)	Approx. mass kg (lb)	Allowable radial load N (lb)	Allowable thrust load N (lb)
A3AF12	94.5 (3.72)	69.5 (2.74)	36.5 (1.44)	W/O flat key seat		30 (0.04)	0.3 (0.66)	68 (15)	54 (12)
A3BF12				20 (0.79)	7.5 (0.30)				
A3AF13									
A3BF13									
A5AF12	102.0 (4.02)	77.0 (3.03)	44.0 (1.73)	W/O flat key seat		50 (0.07)	0.4 (0.88)	78 (18)	
A5BF12				20 (0.79)	7.5 (0.30)				
A5AF13									
A5BF13									
O1AF12	119.5 (4.70)	94.5 (3.72)	61.5 (2.42)	W/O flat key seat		100 (0.13)	0.5 (1.10)	78 (18)	
O1BF12				20 (0.79)	7.5 (0.30)				
O1AF13									
O1BF13									

Note 1) The detector uses an incremental encoder 1024 P/R.

2) Type "A" indicates 200 V specification, and type "B" indicates 100 V specification.

3) The quoted allowable radial load is the value at a position 20 mm (0.79 in.) from the motor mounting surface.

SERVO SELECTION AND DATA SHEETS

4.4.1 Servomotor Dimensional Drawings

- 200 W (0.27 HP), 300 W (0.04 HP, 100 VAC only), 400 W (0.53 HP, 200 VAC only)

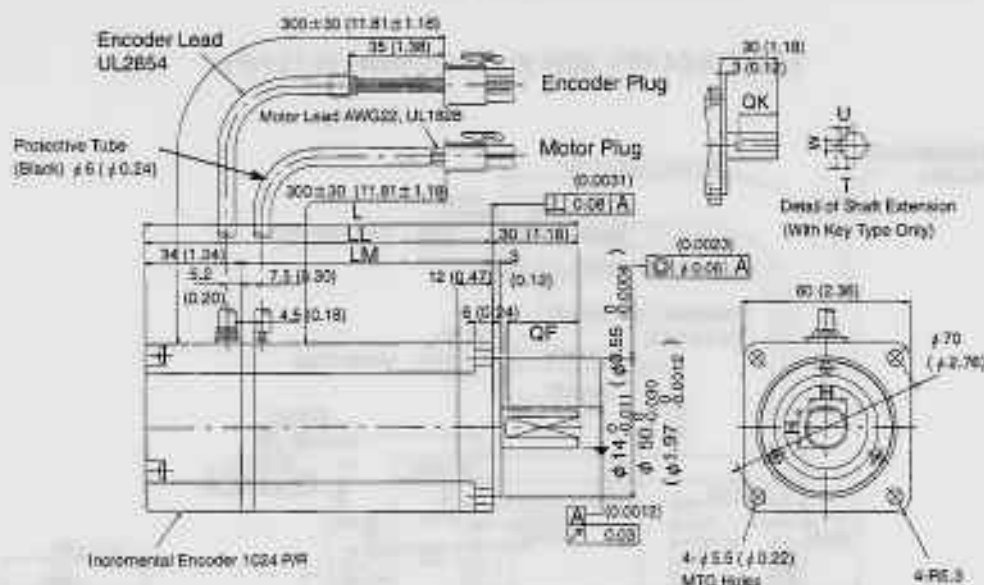

Type SGME-	L	LL	LM	OK	U	W	T	QF	H	Output W (HP)	Approx. mass kg (lb)	Allowable radial load N (lb)	Allowable thrust load N (lb)
02AF12	126.5	96.5	62.5	No key				W/O flat key seat		200 (0.27)	1.1 (2.43)	245 (55.1)	74 (17)
02BF12	(4.98)	(3.80)	(2.46)					25 (0.98)	13 (0.51)				
02AF13													
02BF13													
02AF14				20	3	5	5	W/O flat key seat					
02BF14				(0.79)	(0.12)	(0.20)	(0.20)						
03BF12	154.5	124.5	90.5	No key				W/O flat key seat		300 (0.40)	1.7 (3.75)		
03BF13	(6.08)	(4.90)	(3.56)					25 (0.98)	13 (0.51)				
03BF14				20	3	5	5	W/O flat key seat					
04AF12				No key				W/O flat key seat		400 (0.53)			
04AF13								25 (0.98)	13 (0.51)				
04AF14				20	3	5	5	W/O flat key seat					
				(0.79)	(0.12)	(0.20)	(0.20)						

- Note**
- 1) The detector uses an incremental encoder 1024 P/R.
 - 2) Type "A" indicates 200 V specification, and type "B" indicates 100 V specification.
 - 3) "02A(B)F14", "03BF14" and "04AF14" have a keyed shaft. The keyway complies with JIS B 1301-1976 (precision). A straight key is supplied.
 - 4) The quoted allowable radial load is the value at a position 25 mm (0.98 in.) from the motor mounting surface.

- 750 W (1.01 HP, 200 VAC only)

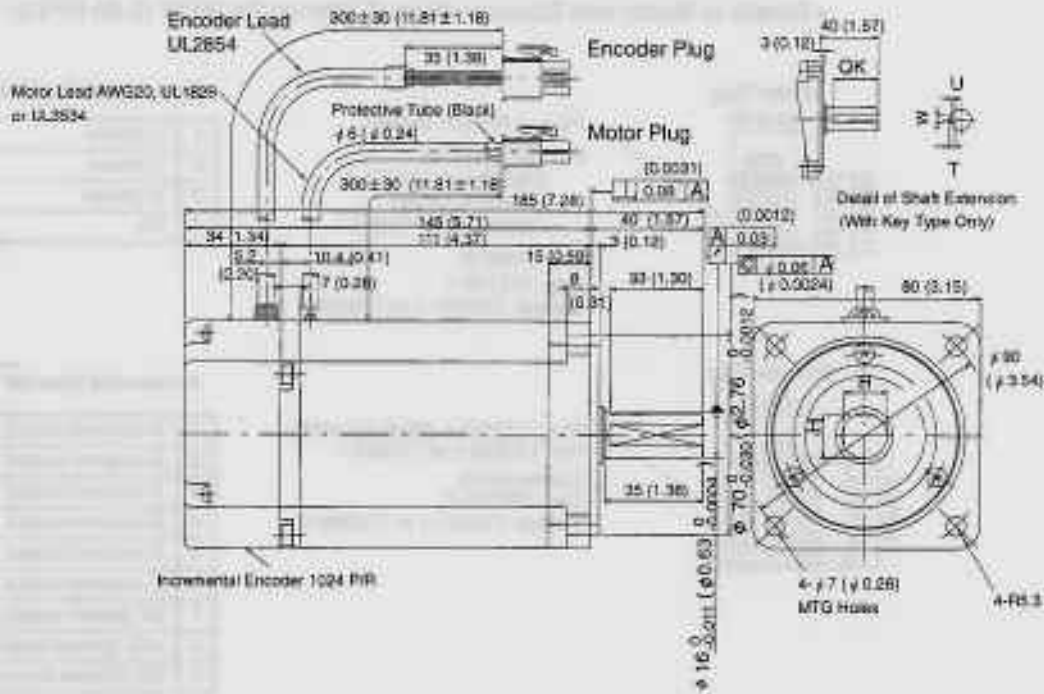

Type SGME-	QK	U	W	T	QF	H	Output W (HP)	Approx. mass kg (lb)	Allowable radial load N (lb)	Allowable thrust load N (lb)
08AF12	No key				W/O flat key seat		750 (1.01)	3.4 (7.50)	392 (88)	147 (33)
08AF13					33 (1.30)	15 (0.59)				
08AF14	30 (1.18)	3 (0.12)	5 (0.20)	5 (0.20)	W/O flat key seat					

SERVO SELECTION AND DATA SHEETS

4.4.1 Servomotor Dimensional Drawings

- Note**
- 1) The detector uses an incremental encoder 1024 P/R.
 - 2) Type "A" indicates 200 V specification.
 - 3) "08AF14" has a keyed shaft. The keyway complies with JIS B 1301-1976 (precision). A straight key is supplied.
 - 4) The quoted allowable radial load is the value at a position 25 mm (0.98 in.) from the motor mounting surface.

• Details of Motor and Encoder Plugs (Common for 30 W (0.04 HP) to 750 W (1.01 HP))

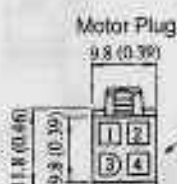

Plug: 172167-1 (AMP)
 Pin: (30 to 100W)
 170359-1 or 170363-1
 (200W to 750W)
 170360-1 or 170364-1

Connected to
 Cap: 172159-1
 Socket: 170362-1 or 170366-1

Motor Wiring Specifications

1	U phase	Red
2	V phase	White
3	W phase	Blue
4	FG	Green

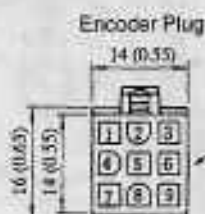

Plug: 172169-1 (Made by AMP)
 Pin: 170359-1 or 170363-1
 Connected to
 Cap: 172161-1
 Socket: 170361-1 or 170365-1

Incremental Encoder Wiring Specifications

1	A channel output	Blue
2	A channel output	Blue/Black
3	B channel output	Yellow
4	B channel output	Yellow/Black
5	C channel output	Green
6	C channel output	Green/Black
7	0V (power supply)	Gray
8	+5V (power supply)	Red
9	FG (Frame Ground)	Orange

Model	Power	Speed	Positioning Accuracy	Resolution	Encoder	Mounting	Weight	Dimensions	Notes
08AF14	30W	3000 RPM	±0.05°	1024 P/R	170359-1	Standard	0.15 kg	42 x 42 x 42 mm	
08AF14A	30W	3000 RPM	±0.05°	1024 P/R	170359-1	Standard	0.15 kg	42 x 42 x 42 mm	
08AF14B	30W	3000 RPM	±0.05°	1024 P/R	170359-1	Standard	0.15 kg	42 x 42 x 42 mm	
08AF14C	30W	3000 RPM	±0.05°	1024 P/R	170359-1	Standard	0.15 kg	42 x 42 x 42 mm	
08AF14D	30W	3000 RPM	±0.05°	1024 P/R	170359-1	Standard	0.15 kg	42 x 42 x 42 mm	
08AF14E	30W	3000 RPM	±0.05°	1024 P/R	170359-1	Standard	0.15 kg	42 x 42 x 42 mm	
08AF14F	30W	3000 RPM	±0.05°	1024 P/R	170359-1	Standard	0.15 kg	42 x 42 x 42 mm	
08AF14G	30W	3000 RPM	±0.05°	1024 P/R	170359-1	Standard	0.15 kg	42 x 42 x 42 mm	
08AF14H	30W	3000 RPM	±0.05°	1024 P/R	170359-1	Standard	0.15 kg	42 x 42 x 42 mm	
08AF14I	30W	3000 RPM	±0.05°	1024 P/R	170359-1	Standard	0.15 kg	42 x 42 x 42 mm	
08AF14J	30W	3000 RPM	±0.05°	1024 P/R	170359-1	Standard	0.15 kg	42 x 42 x 42 mm	
08AF14K	30W	3000 RPM	±0.05°	1024 P/R	170359-1	Standard	0.15 kg	42 x 42 x 42 mm	
08AF14L	30W	3000 RPM	±0.05°	1024 P/R	170359-1	Standard	0.15 kg	42 x 42 x 42 mm	
08AF14M	30W	3000 RPM	±0.05°	1024 P/R	170359-1	Standard	0.15 kg	42 x 42 x 42 mm	
08AF14N	30W	3000 RPM	±0.05°	1024 P/R	170359-1	Standard	0.15 kg	42 x 42 x 42 mm	
08AF14O	30W	3000 RPM	±0.05°	1024 P/R	170359-1	Standard	0.15 kg	42 x 42 x 42 mm	
08AF14P	30W	3000 RPM	±0.05°	1024 P/R	170359-1	Standard	0.15 kg	42 x 42 x 42 mm	
08AF14Q	30W	3000 RPM	±0.05°	1024 P/R	170359-1	Standard	0.15 kg	42 x 42 x 42 mm	
08AF14R	30W	3000 RPM	±0.05°	1024 P/R	170359-1	Standard	0.15 kg	42 x 42 x 42 mm	
08AF14S	30W	3000 RPM	±0.05°	1024 P/R	170359-1	Standard	0.15 kg	42 x 42 x 42 mm	
08AF14T	30W	3000 RPM	±0.05°	1024 P/R	170359-1	Standard	0.15 kg	42 x 42 x 42 mm	
08AF14U	30W	3000 RPM	±0.05°	1024 P/R	170359-1	Standard	0.15 kg	42 x 42 x 42 mm	
08AF14V	30W	3000 RPM	±0.05°	1024 P/R	170359-1	Standard	0.15 kg	42 x 42 x 42 mm	
08AF14W	30W	3000 RPM	±0.05°	1024 P/R	170359-1	Standard	0.15 kg	42 x 42 x 42 mm	
08AF14X	30W	3000 RPM	±0.05°	1024 P/R	170359-1	Standard	0.15 kg	42 x 42 x 42 mm	
08AF14Y	30W	3000 RPM	±0.05°	1024 P/R	170359-1	Standard	0.15 kg	42 x 42 x 42 mm	
08AF14Z	30W	3000 RPM	±0.05°	1024 P/R	170359-1	Standard	0.15 kg	42 x 42 x 42 mm	

(2) SGME Servomotor
Incremental encoder, with brake

- 30W (0.04 HP), 50W (0.07 HP), 100W (0.13 HP)

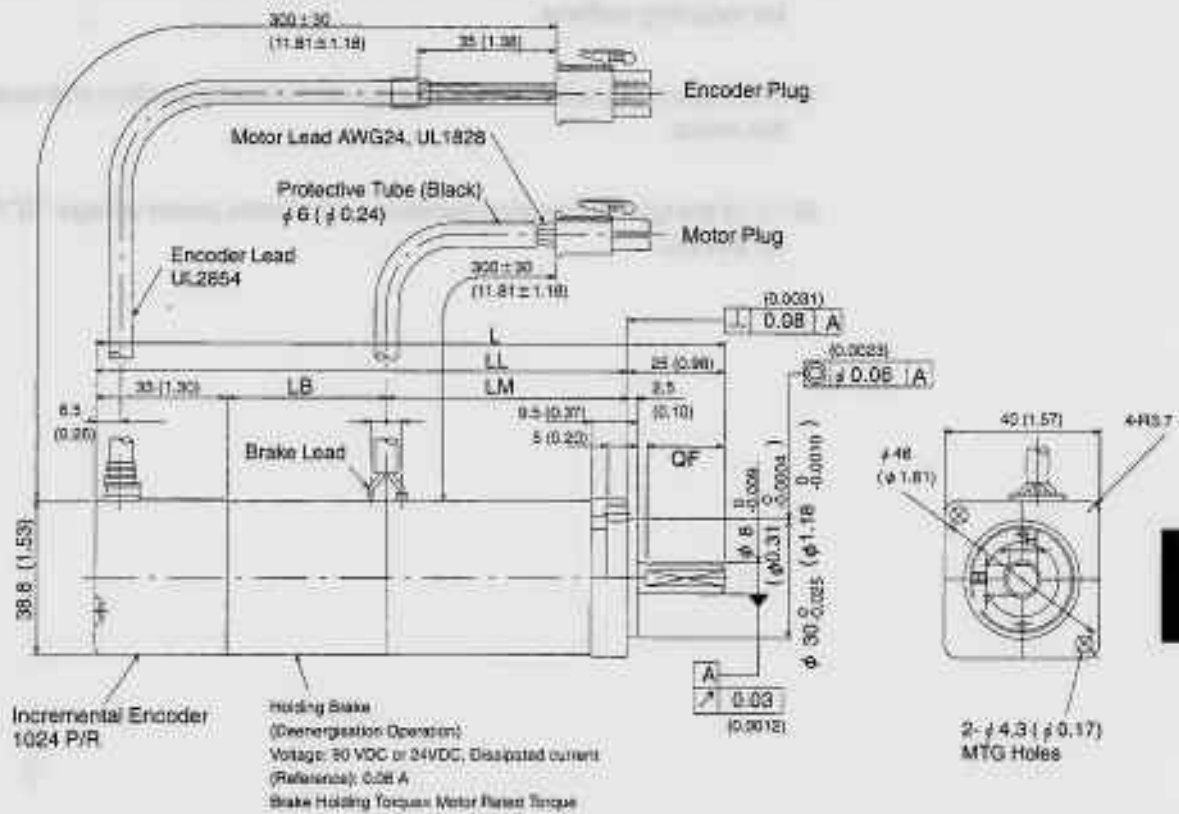

Type SGME-	L	LL	LM	QF	H	Output W (HP)	Approx. mass kg (lb)	Allowable radial load N (lb)	Allowable thrust load N (lb)
A3AF12*	126.0 (4.96)	101.0 (3.98)	36.5 (1.44)	W/O flat key seat		30 (0.04)	0.6 (1.32)	68 (15)	54 (12)
A3BF12*									
A3AF13*				20 (0.79)	7.5 (0.30)				
A3BF13*									
A5AF12*	133.5 (5.26)	108.5 (4.27)	44.0 (1.73)	W/O flat key seat		50 (0.07)	0.7 (1.54)	78 (18)	
A5BF12*									
A5AF13*				20 (0.79)	7.5 (0.30)				
A5BF13*									
O1AF12*	180.0 (6.30)	135.0 (5.31)	61.5 (2.42)	W/O flat key seat		100 (0.13)	0.8 (1.76)	78 (18)	
O1BF12*									
O1AF13*				20 (0.79)	7.5 (0.30)				
O1BF13*									

SERVO SELECTION AND DATA SHEETS

4.4.1 Servomotor Dimensional Drawings

- Note**
- 1) The detector uses an incremental encoder 1024 P/R.
 - 2) Type "A" indicates 200 V specification, and type "B" indicates 100 V specification.
 - 3) The quoted allowable radial load is the value at a position 20 mm (0.79 in.) from the motor mounting surface.
 - 4) The electromagnetic brake is only to hold the load in position and cannot be used to stop the motor.
 - 5) "*" of the type designation depends on the brake power voltage: "B" for 90 VDC and "C" for 24VDC.

Model	Power	Speed	Current	Voltage	Weight	Dimensions	Notes
S-1000	100W	3000rpm	1.0A	100V	0.5kg	100x100x100	Standard model
	100W	1500rpm	1.0A	100V	0.5kg	100x100x100	
	100W	750rpm	1.0A	100V	0.5kg	100x100x100	
	100W	300rpm	1.0A	100V	0.5kg	100x100x100	
S-2000	200W	3000rpm	2.0A	200V	1.0kg	150x150x150	Standard model
	200W	1500rpm	2.0A	200V	1.0kg	150x150x150	
	200W	750rpm	2.0A	200V	1.0kg	150x150x150	
	200W	300rpm	2.0A	200V	1.0kg	150x150x150	
S-3000	300W	3000rpm	3.0A	300V	1.5kg	200x200x200	Standard model
	300W	1500rpm	3.0A	300V	1.5kg	200x200x200	
	300W	750rpm	3.0A	300V	1.5kg	200x200x200	
	300W	300rpm	3.0A	300V	1.5kg	200x200x200	
S-4000	400W	3000rpm	4.0A	400V	2.0kg	250x250x250	Standard model
	400W	1500rpm	4.0A	400V	2.0kg	250x250x250	
	400W	750rpm	4.0A	400V	2.0kg	250x250x250	
	400W	300rpm	4.0A	400V	2.0kg	250x250x250	

SERVO SELECTION AND DATA SHEETS

4.4.1 Servomotor Dimensional Drawings

- 4) The quoted allowable radial load is the value at a position 25 mm (0.98 in.) from the motor mounting surface.
- 5) The electromagnetic brake is only to hold the load in position and cannot be used to stop the motor.
- 6) "*" of the type designation depends on the brake power voltage: "B" for 90 VDC and "C" for 24VDC.

• 750 W (1.01 HP)

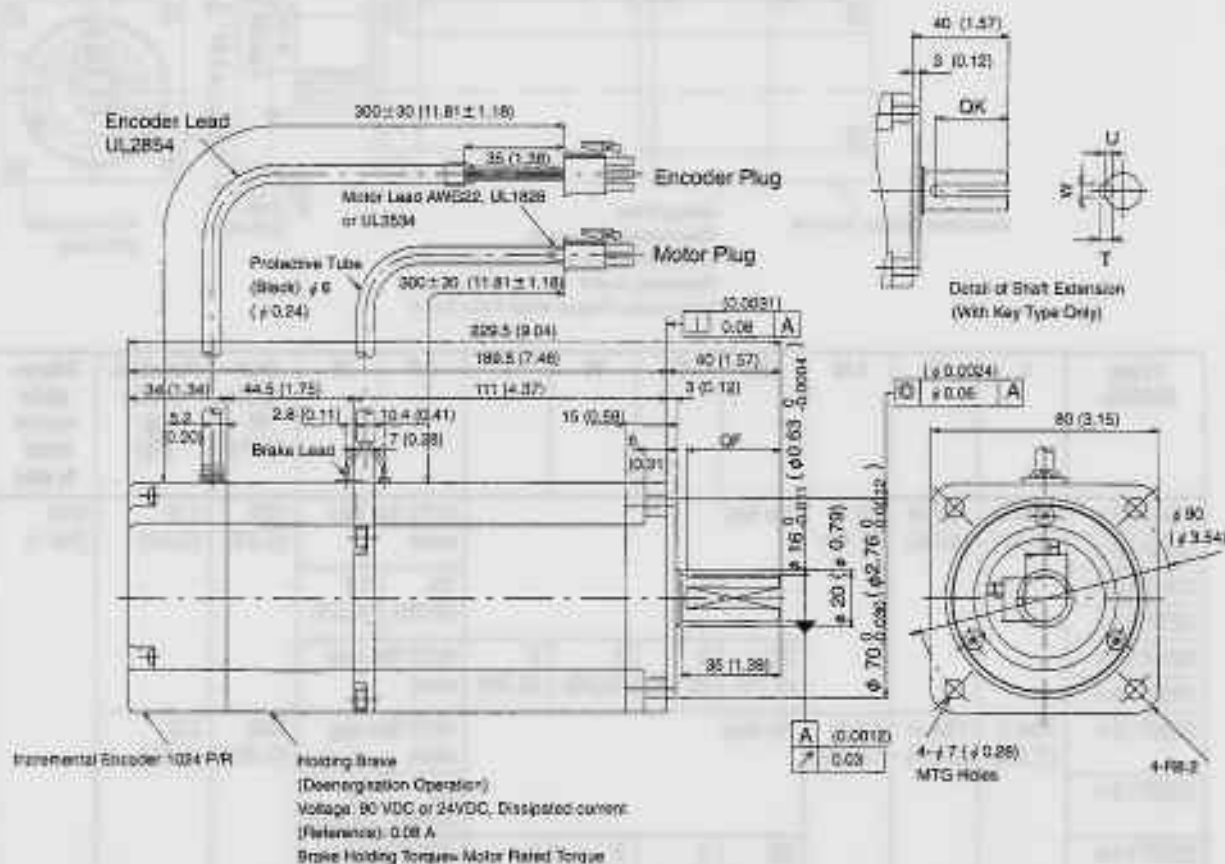

Type SGME-	QK	U	W	T	QF	H	Output W (HP)	Approx. mass kg (lb)	Allowable radial load N (lb)	Allowable thrust load N (lb)
08AF12*	No key					W/O flat key seat	750 (1.01)	4.3 (9.48)	392 (88)	147 (33)
08AF13*						33 (1.30)	15 (0.59)			
08AF14*	30 (1.18)	3 (0.12)	5 (0.20)	5 (0.20)	W/O flat key seat					

- Note**
- 1) The detector uses an incremental encoder 1024 P/R.
 - 2) Type "A" indicates 200 V specification.
 - 3) "08AF14*" has a keyed shaft. The keyway complies with JIS B 1301-1976 (precision). A straight key is supplied.
 - 4) The quoted allowable radial load is the value at a position 25 mm (0.98 in.) from the motor mounting surface.
 - 5) The electromagnetic brake is only to hold the load in position and cannot be used to stop the motor.
 - 6) "*" of the type designation depends on the brake power voltage: "B" for 90 VDC and "C" for 24VDC.

• Details of Motor and Encoder Plugs (Common for 30 W (0.04 HP) to 750 W (1.01 HP))

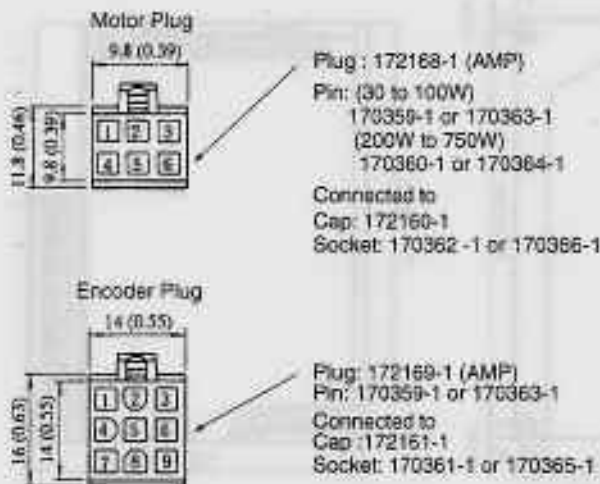

Motor Wiring Specifications

1	U phase	Red
2	V phase	White
3	W phase	Blue
4	FG	Green/Yellow
5	Brake terminal	Red
6	Brake terminal	Black

Incremental Encoder Wiring Specifications

1	A channel output	Blue
2	A channel output	Blue/Black
3	B channel output	Yellow
4	B channel output	Yellow/Black
5	C channel output	Green
6	C channel output	Green/Black
7	0V (power supply)	Gray
8	+5V (power supply)	Red
9	FG (Frame Ground)	Orange

4.4.2 Servopack Dimensional Drawings

1) The dimension drawings of the SGDE Servopack are broadly grouped according to capacity into the following three categories.

a) 200V, 30W (0.04 HP) to 200 W (0.27HP) (Type: SGDE-A3AP to 02AP)
 100V, 30W (0.04 HP) to 100 W (0.13HP) (Type: SGDE-A3BP to 01BP)

b) 200V, 400W (0.53 HP) (Type: SGDE-04AP)
 100V, 200W (0.27 HP) (Type: SGDE-02BP)

c) 200V, 750W (1.01 HP) (Type: SGDE-08AP)
 100V, 300W (0.40 HP) (Type: SGDE-03BP)

a) SGDE-A3AP to 02AP (200V, 30 (0.04 HP) to 200 W (0.27HP))
 SGDE-A3BP to 01BP (100V, 30 (0.04 HP) to 100 W (0.13HP))

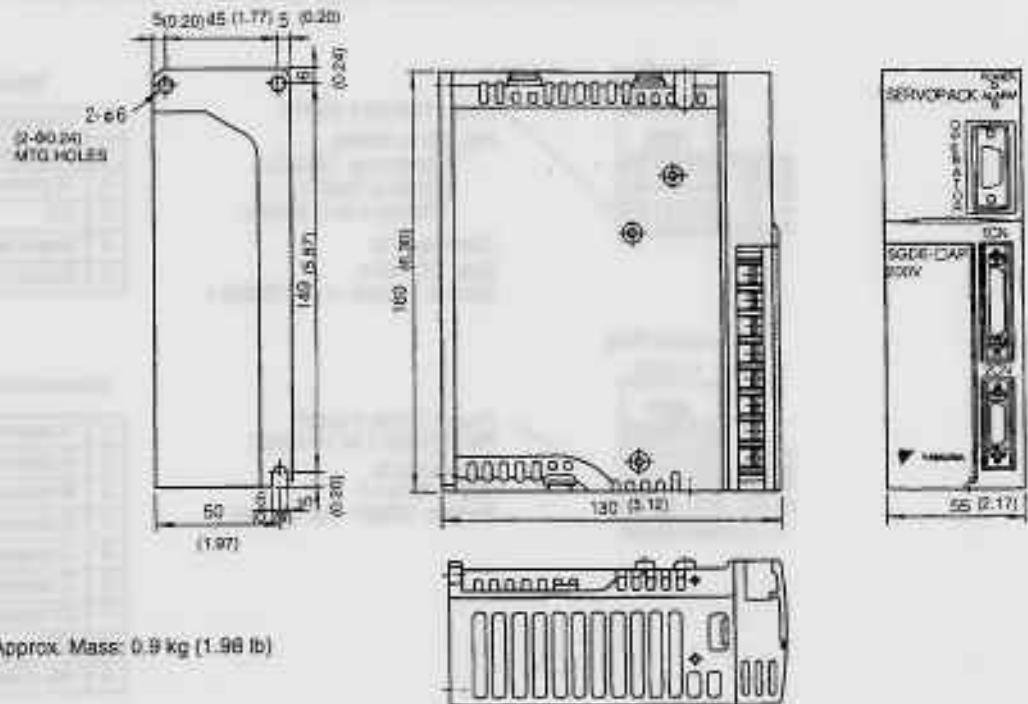

- b) SGDE-04AP (200V, 400W (0.53 HP))
 SGDE-02BP (100V, 200W (0.27 HP))

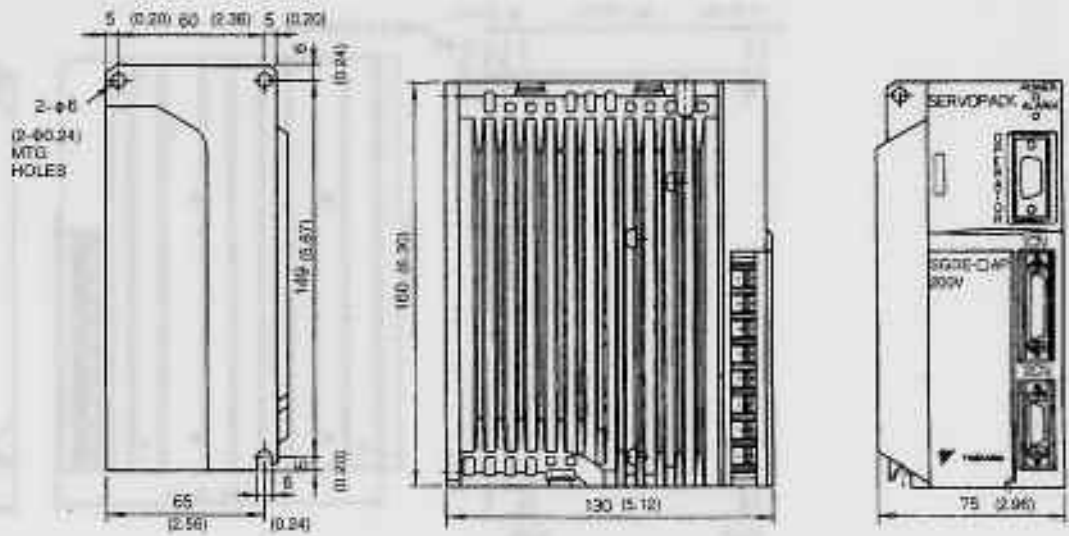

Approx. Mass: 1.2 kg (2.65 lb)

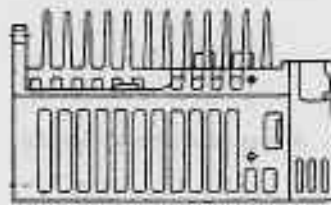

SERVO SELECTION AND DATA SHEETS

4.4.2 Servopack Dimensional Drawings

- c) SGDE-08AP (200V, 750W (1.01 HP))
 SGDE-03BP (100V, 300W (0.40 HP))

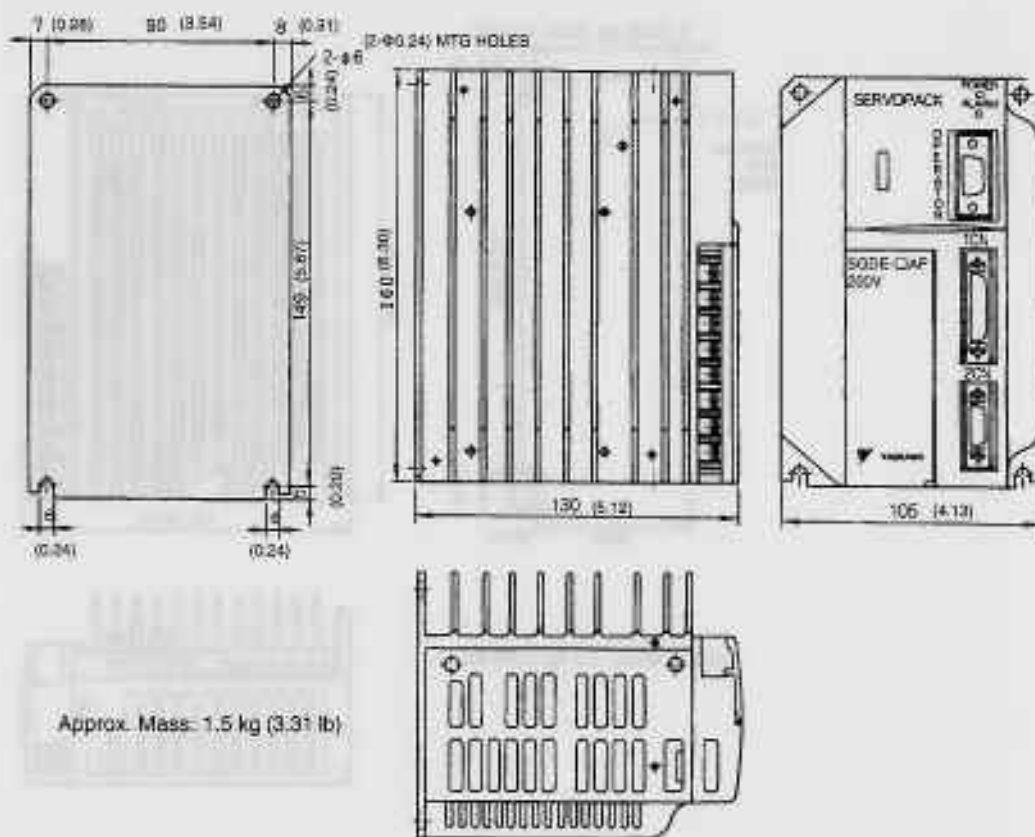

4.4.3 Digital Operator Dimensional Drawings

1) The following two types of Digital Operator are available.

- a) JUSP-OP02A-1 Hand-held Type
- b) JUSP-OP03A Mount Type

a) JUSP-OP02A-1

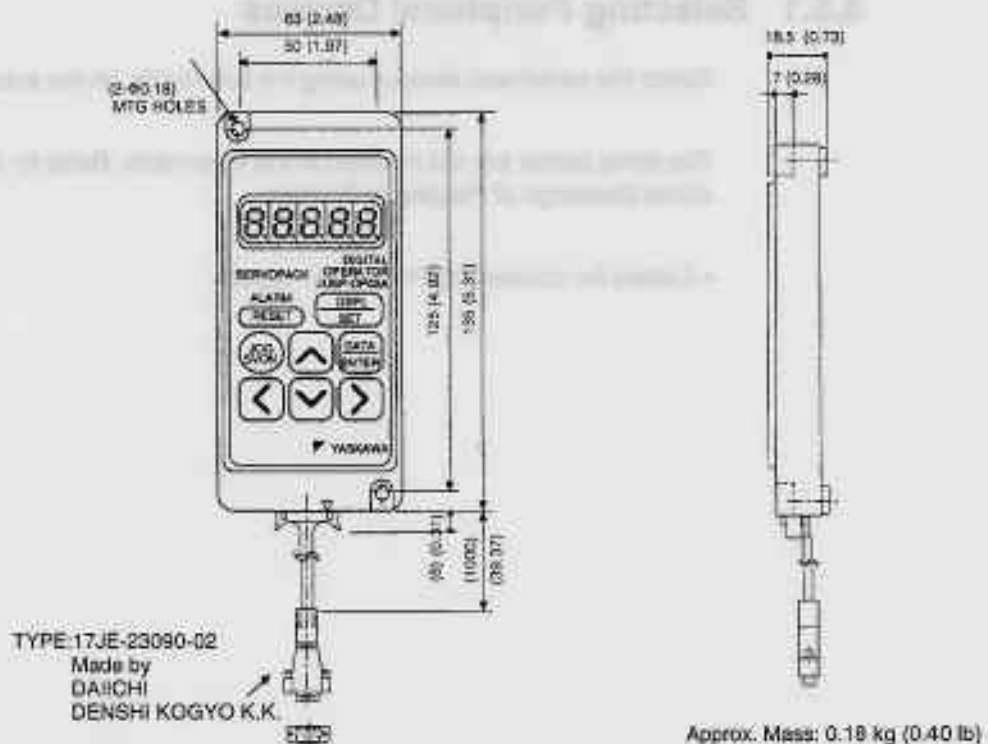

b) JUSP-OP03A

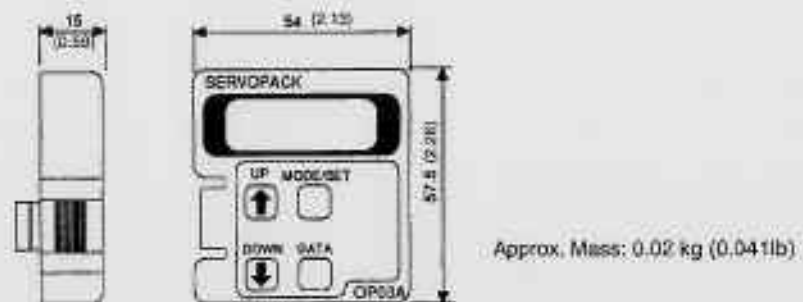

4.5 Selecting Peripheral Devices

- This section shows how to select peripheral devices using flowcharts.

4.5.1 Selecting Peripheral Devices	144
--	-----

4.5.1 Selecting Peripheral Devices

Select the peripheral devices using the flowcharts on the subsequent pages.

The items below are not included in the flowcharts. Refer to *4.6 Specifications and Dimensional Drawings of Peripheral Devices*.

- Cables for connecting PC and Servopack

<Flowchart for peripheral device selection>

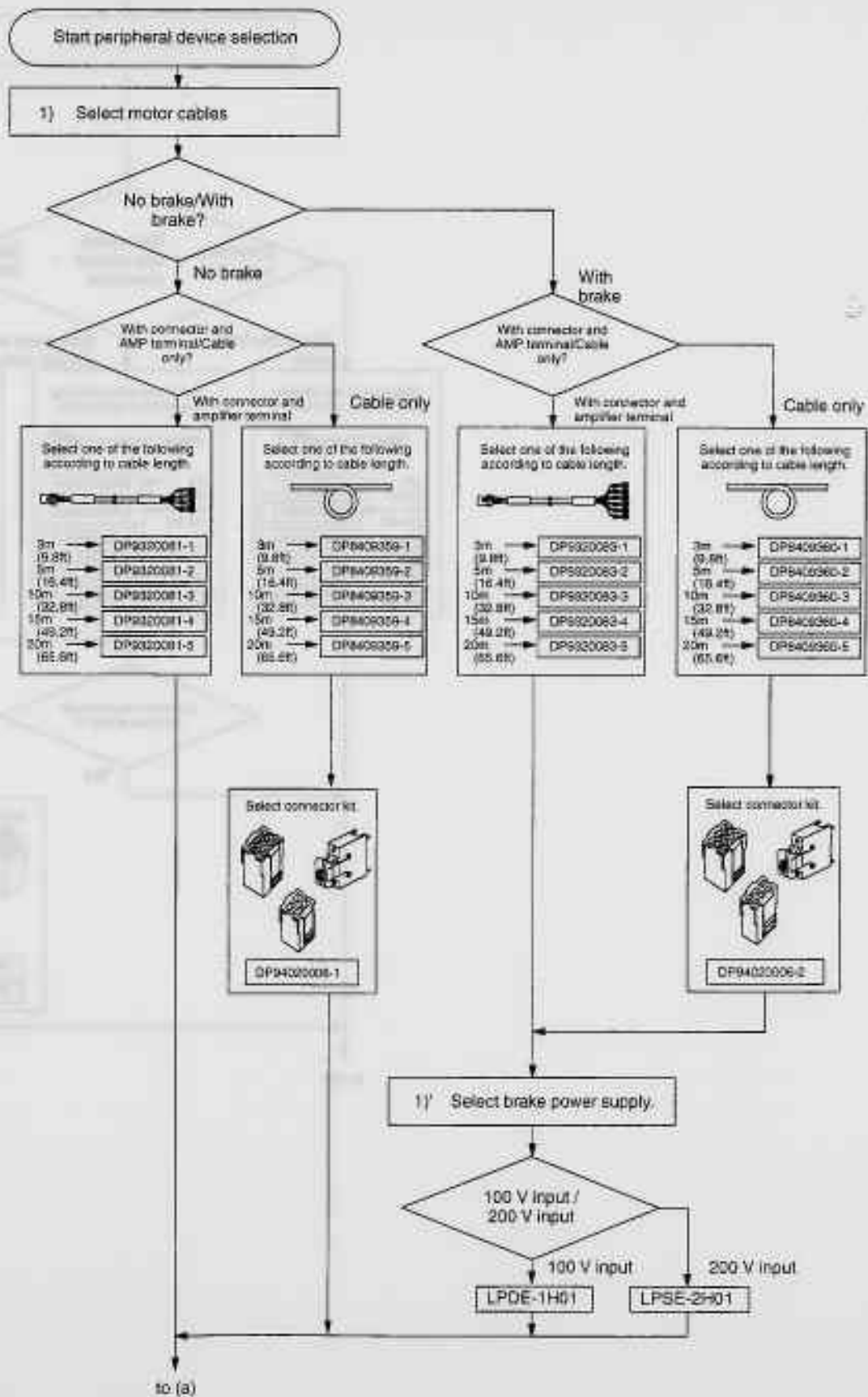

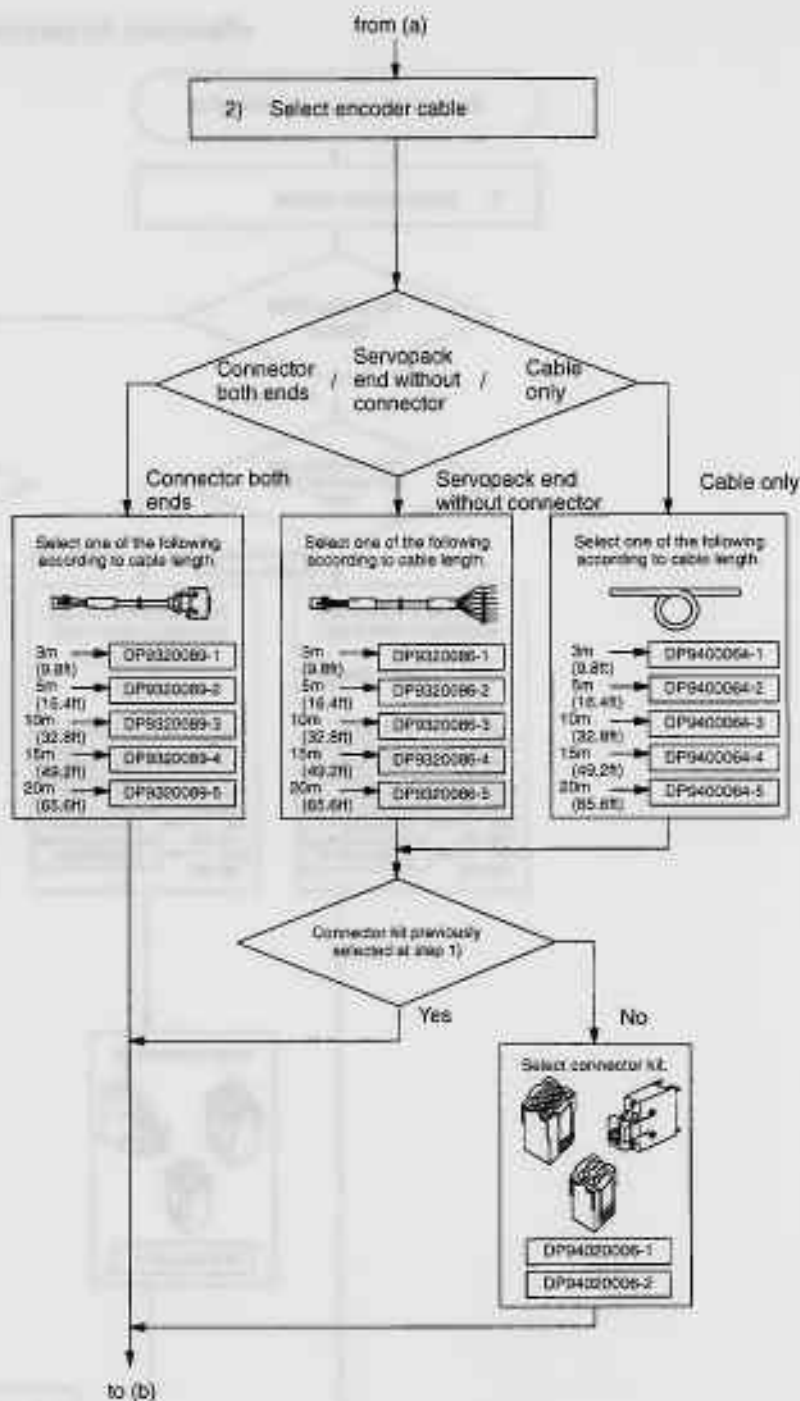

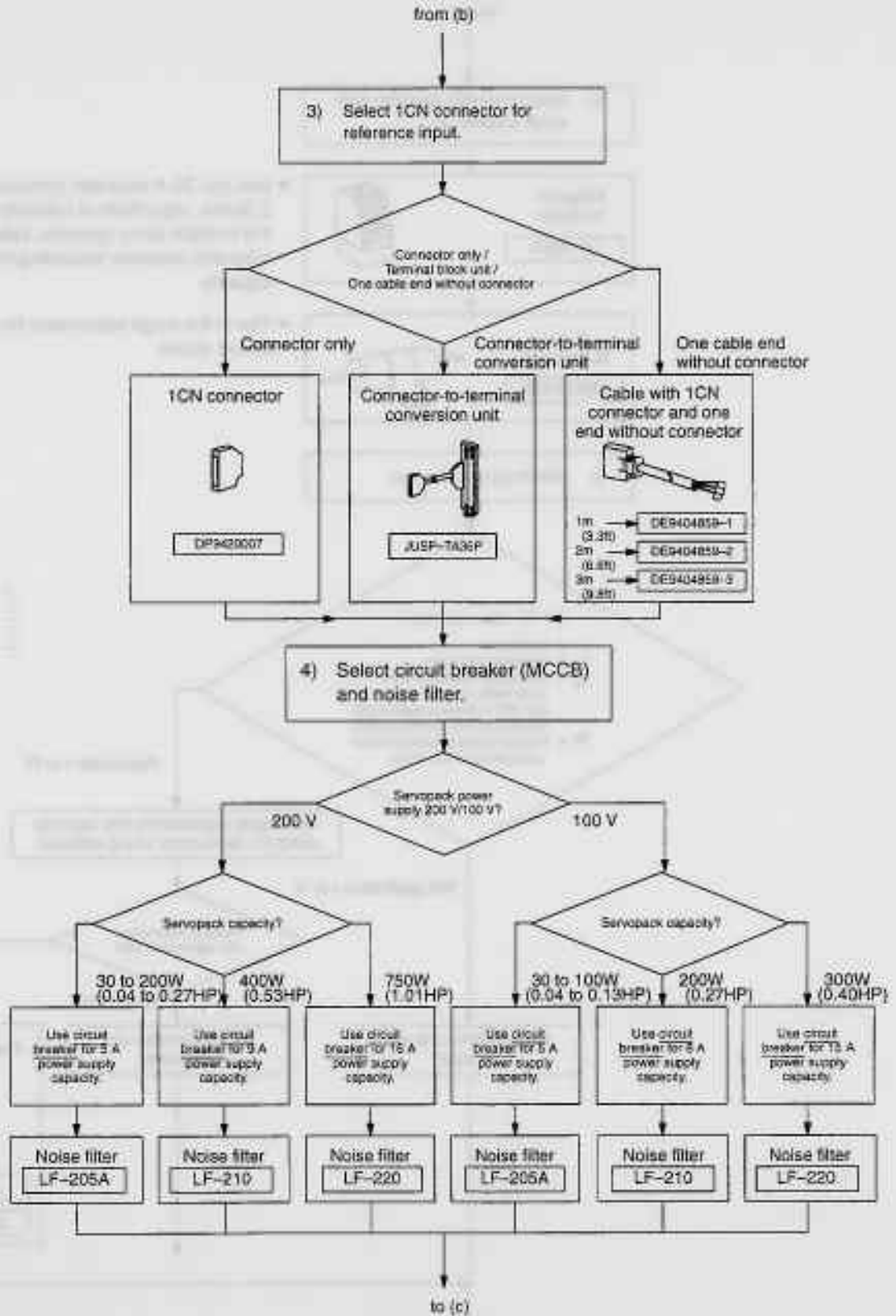

4.5.1 Selecting Peripheral Devices cont.

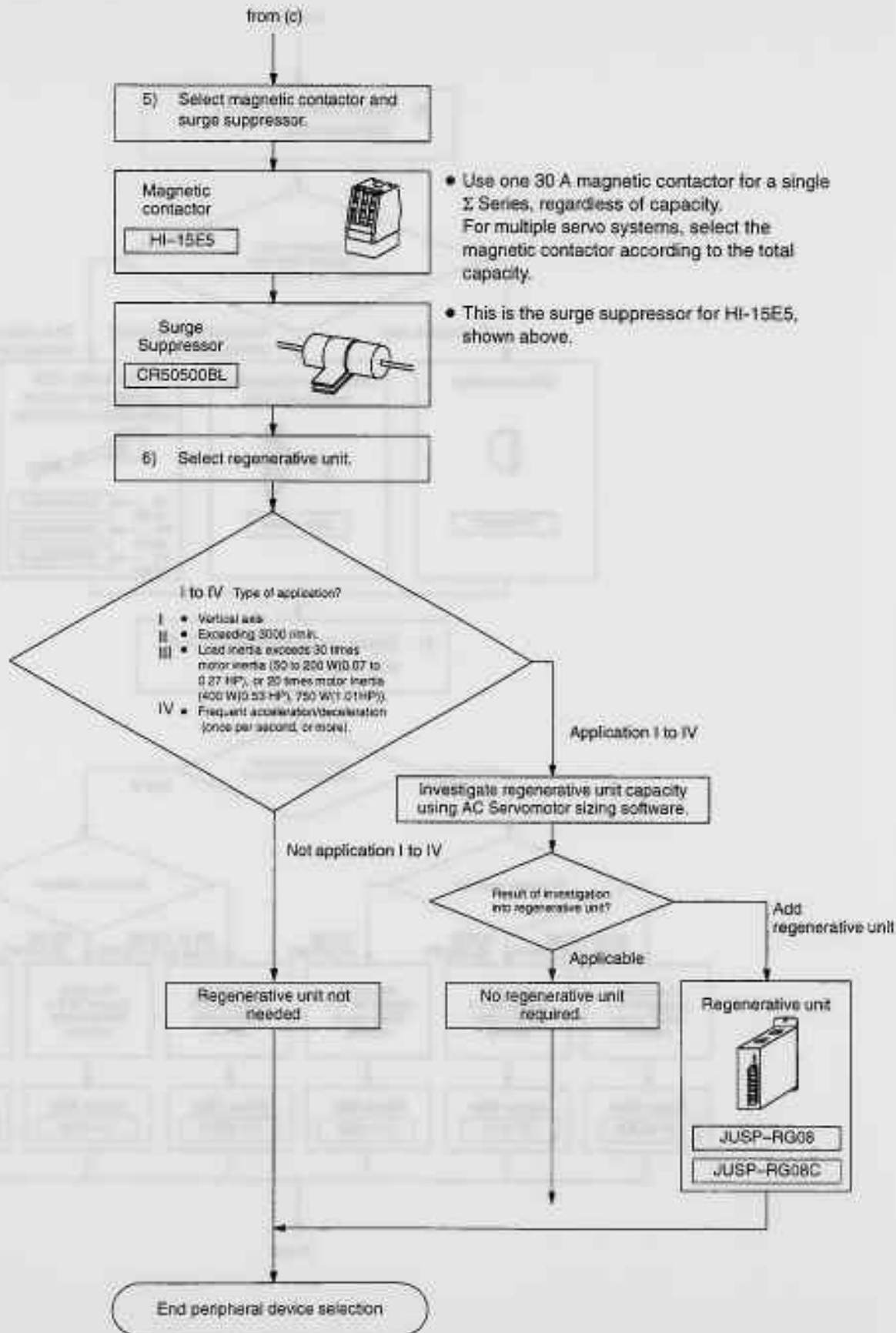

4.6 Specifications and Dimensional Drawings of Peripheral Devices

This section shows the specifications and dimensional drawings of the peripheral devices required for the Σ -Series servo system. The sequence of peripheral devices is given by the Flowchart for Peripheral Device Selection in 4.5 *Selecting Peripheral Devices*.

4.6.1	Cable Specifications and Peripheral Devices	149
4.6.2	Motor Cables	152
4.6.3	Connector Kits	155
4.6.4	Brake Power Supply	159
4.6.5	Encoder Cables	161
4.6.6	1CN Connector	165
4.6.7	Connector Terminal Block Converter Unit	167
4.6.8	Cable With 1CN Connector and One End Without Connector	169
4.6.9	Circuit Breaker	169
4.6.10	Noise Filter	170
4.6.11	Magnetic Contactor	171
4.6.12	Surge Suppressor	172
4.6.13	Regenerative Unit	173
4.6.14	Cables for Connecting PC and Servopack	175

4.6.1 Cable Specifications and Peripheral Devices



- 1) The rated current of the SGDE Servopack external terminals, cable size, and peripheral devices are listed in the next table.

The cable specifications and size are selected according to the operating environment and current capacity.

The cable specifications were selected under conditions of three cables per bundle at 40° C ambient temperature, with the rated current flowing.

SERVO SELECTION AND DATA SHEETS

4.6.1 Cable Specifications and Peripheral Devices cont.

Type	Servopack Type SQDE-		Main circuit power input terminal (R) (T)		Motor connec- tion terminals (U) (V) (W) \perp		Power Supply capacity per Servo- pack* ¹ kVA	MCCB or fuse ca- pacity* ² A	Noise filter type (refer- ence dia- gram)	Recom- mended noise filter* ³		Power ON/OFF switch
			Rated current A(rms)	Cable spec.	Rated current A (rms)	Cable spec.				Type	Spec.	
For 200 V	30 W (0.04HP)	A3AP	1.3	HiV 1.25 min.	0.42	Use Yaskawa cable. See 4.6.2 Motor Cables below for details.	0.25	5	Applicable 	LF- 205A	Single- phase 200 VAC Class, 5 A	Yaskawa HI-15E5 (30 A), or equiva- lent
	50 W (0.07HP)	A5AP	1.5		0.6		0.3					
	100 W (0.13HP)	01AP	2.5		0.87		0.5					
	200 W (0.27HP)	02AP	4.0		2.0		0.75					
	400 W (0.53HP)	04AP	6.0	HiV 2.0 min.	2.6	When select- ing non-Yas- kawa cables, check the cable current rating and consider the operating en- vironment.	1.2	9	Not ap- plicable 	LF- 210	Single- phase 200 VAC Class, 10 A	
	750 W (1.01HP)	08AP	11.0		4.4		2.2			16	LF- 220	
For 100 V	30 W (0.04HP)	A3BP	2.0	HiV 1.25 min.	0.63	Use cable size AWG22 to AWG18 (0.3 to 0.89 mm ²).	0.25	5	Not ap- plicable 	LF- 205A	Single- phase 200 VAC Class, 5 A	
	50 W (0.07HP)	A5BP	2.6		0.9		0.3					
	100 W (0.13HP)	01BP	4.5		2.2		0.5					
	200 W (0.27HP)	02BP	8.0	HiV 2.0 min.	2.7		8	LF- 210		Single- phase 200 VAC Class, 10 A		
	300 W (0.40HP)	03BP	14.0		3.7			1.4		15	LF- 220	VAC Class, 10 A

*1 Value at rated load.

*2 Braking characteristics (at 25°C): 200% for 2 s min., 700% for 0.01 s min.

*3 Yaskawa recommends noise filters manufactured by Tokin Corp. Yaskawa Controls Co., Ltd. can supply these noise filters.

- 2) The types of cable are shown in the table below. Use it in combination with the table above.

Cable Type		Conductor Allowable Temperature °C
Symbol	Name	
PVC	Normal vinyl cable	—
IV	600 V vinyl cable	60
HIV	Temperature-resistant vinyl cable	75

- Note**
- 1) Use cable with 600 V min. withstand voltage for main circuits.
 - 2) Consider allowable current reduction ratio if cables are bundled in PVC or metal ducts.
 - 3) Use temperature-resistant cable under high ambient or panel temperature where normal vinyl cables rapidly deteriorate.
- 3) The appropriate cables for Servopack connectors 1CN and 2CN are shown in the table below.

Control I/O Signal Connector	1CN	Cable	Use twisted-pair cable or twisted-pair shielded cable.
		Applicable Cable	AWG24,26,28,30
		Finished Cable Dimensions	∅16.0 mm (∅ 0.63 in.)MAX.
PG Signal Connector	2CN	Cable	Use Yaskawa cable. Use twisted-pair shielded cable if Yaskawa cable is not used.
		Applicable Cable	Applicable cable types: AWG24, 26, 28, 30. However, use AWG22 for encoder power supply and FG line. Use AWG26 for other signals. These connections permit wiring distances up to 20 m (65.6 ft).
		Finished Cable Dimensions	∅11.6(20.46 in.) mm MAX.

- Note** Cable selection conditions: three cables per bundle at 40 °C ambient temperature, with the rated current flowing.

4.6.2 Motor Cables

1) The dimensions and appearance of the motor cables are shown below. Specify the cable type when ordering.

a) Cables For Motor Without Brake (with connector and AMP terminals)

Type	L in mm (feet)	
DP9320081-1	3000 ⁺¹⁰⁰ ₀	(10 ^{+0.33} ₀)
DP9320081-2	5000 ⁺¹⁰⁰ ₀	(16.7 ^{+0.33} ₀)
DP9320081-3	10000 ⁺⁵⁰⁰ ₀	(33.3 ^{+1.67} ₀)
DP9320081-4	15000 ⁺⁵⁰⁰ ₀	(50 ^{+1.67} ₀)
DP9320081-5	20000 ⁺⁵⁰⁰ ₀	(66.7 ^{+1.67} ₀)

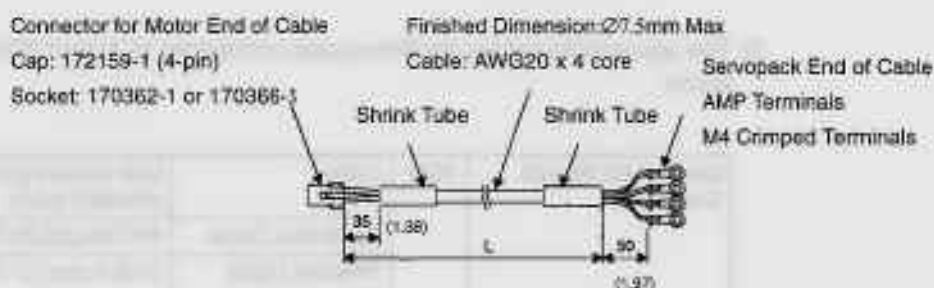

b) Cables For Motor With Brake (with connector and AMP terminals)

Type	L in mm (feet)	
DP9320083-1	3000 ⁺¹⁰⁰ ₀	(10 ^{+0.33} ₀)
DP9320083-2	5000 ⁺¹⁰⁰ ₀	(16.7 ^{+0.33} ₀)
DP9320083-3	10000 ⁺⁵⁰⁰ ₀	(33.3 ^{+1.67} ₀)
DP9320083-4	15000 ⁺⁵⁰⁰ ₀	(50 ^{+1.67} ₀)
DP9320083-5	20000 ⁺⁵⁰⁰ ₀	(66.7 ^{+1.67} ₀)

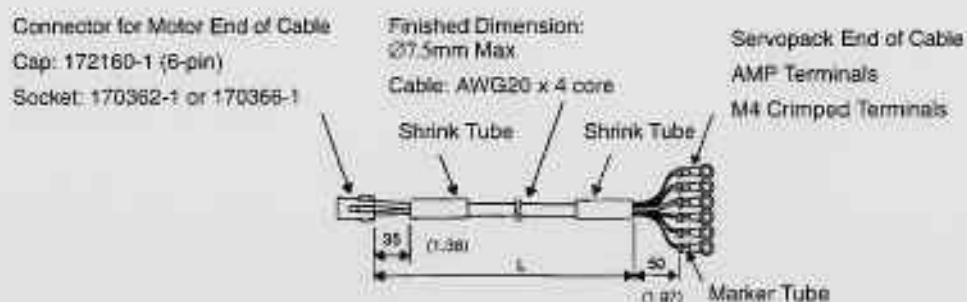

c) Cables For Motor Without Brake
(Cable Only)

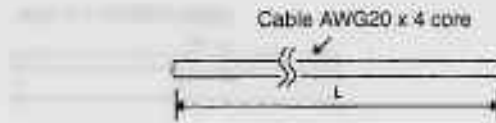

Type	L in mm (feet)
DP8409359-1	3000 ⁺¹⁰⁰ ₀ (10 ^{+0.33} ₀)
DP8409359-2	5000 ⁺¹⁰⁰ ₀ (16.7 ^{+0.33} ₀)
DP8409359-3	10000 ⁺⁵⁰⁰ ₀ (33.3 ^{+1.67} ₀)
DP8409359-4	15000 ⁺⁵⁰⁰ ₀ (50 ^{+1.67} ₀)
DP8409359-5	20000 ⁺⁵⁰⁰ ₀ (66.7 ^{+1.67} ₀)

AMP Connector
Cap: 172159-1
Socket: 170362-1 or 170366-1 (Manufactured by AMP.)

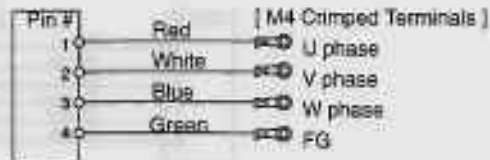

SERVO SELECTION AND DATA SHEETS

4.6.2 Motor Cables cont.

d) Cables For Motor With Brake (Cable Only)

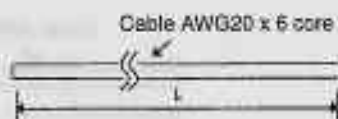

Type	L in mm (feet)
DP8409360-1	3000 ⁺¹⁰⁰ ₀ (10 ^{+0.33} ₀)
DP8409360-2	5000 ⁺¹⁰⁰ ₀ (16.7 ^{+0.33} ₀)
DP8409360-3	10000 ⁺⁵⁰⁰ ₀ (33.3 ^{+1.67} ₀)
DP8409360-4	15000 ⁺⁵⁰⁰ ₀ (50 ^{+1.67} ₀)
DP8409360-5	20000 ⁺⁵⁰⁰ ₀ (66.7 ^{+1.67} ₀)

AMP Connector

Cap: 172160-1

Socket: 170362-1 or 170366-1 (Manufactured by AMP.)

Pin #	Color	[M4 Crimped Terminals] *
1	Red	U phase
2	White	V phase
3	Blue	W phase
4	Green	FG (Frame Ground)
5	Black	Br (Brake Terminal)
6	Black	Br (Brake Terminal)

- * If cable only is ordered, purchase the AMP connector and M4 crimped terminals separately. Refer to 4.6.3 Connector Kits for details about caps and sockets.

4.6.3 Connector Kits

- 1) A connector kit comprises three connectors as shown in the diagram below: one encoder connector at both the motor and Servopack ends of the cable and a motor connector for the motor end of the cable.

Encoder Connector for Motor End of Cable

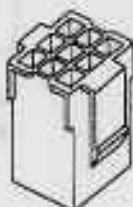

Encoder Connector for Servopack End of Cable

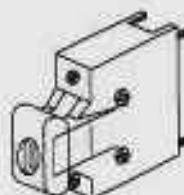

Motor Connector for Motor End of Cable



Two types of connector kit are available according to the following information:

- Is the motor with or without a brake?

A connector kit is required in the following cases:

- If motor cable only is purchased (whether or not motor has a brake).
- If the encoder cable with a motor connector only and Servopack end without connector, or encoder cable only is purchased.

- 2) Select the following encoder cable connector.

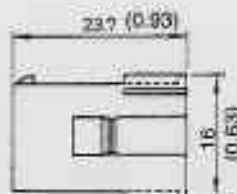
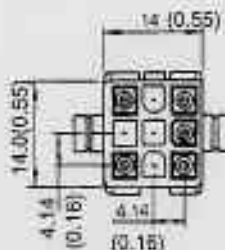

Cap: 172161-1

Socket: 170365-1

3) Select one of the following two types of motor cable connector.

a) Motor Without Brake

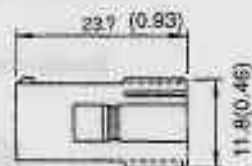
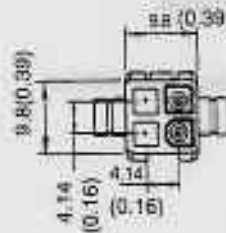

Cap: 172159-1
Socket: 170362-1 or 170366-1

b) Motor With Brake

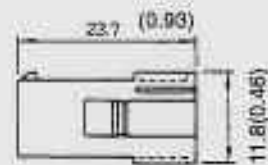
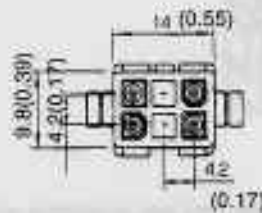

Cap: 172160-1
Socket: 170362-1 or 170366-1

4) Only one type of encoder connector is available for the Servopack end of the cable.

• Connector

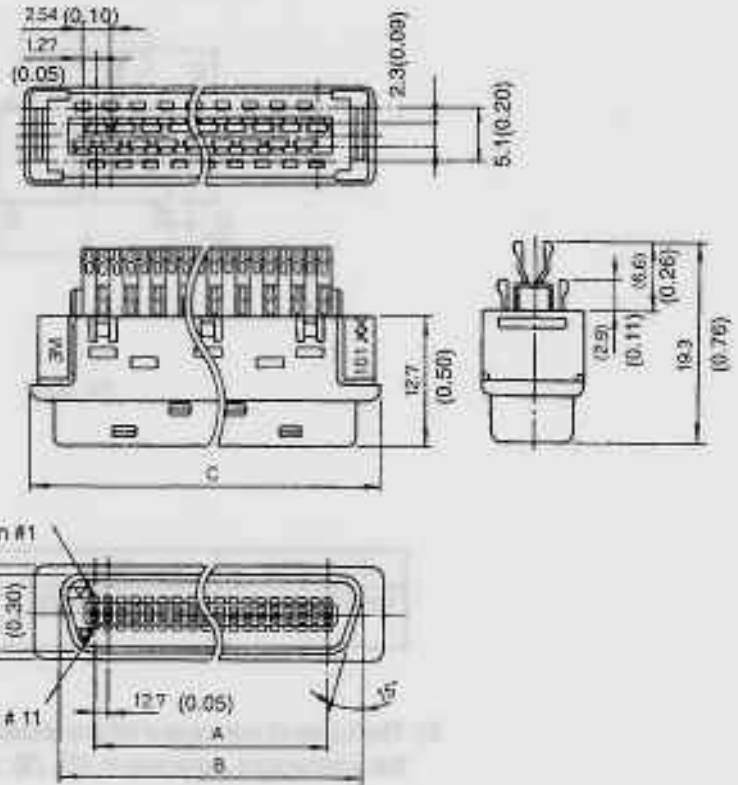

4

Units: mm (inches)

Connector Type	A	B	C
10120-3000VE	11.43(0.45)	17.6(0.69)	22.0(0.87)

SERVO SELECTION AND DATA SHEETS

4.6.3 Connector Kits cont.

• Case

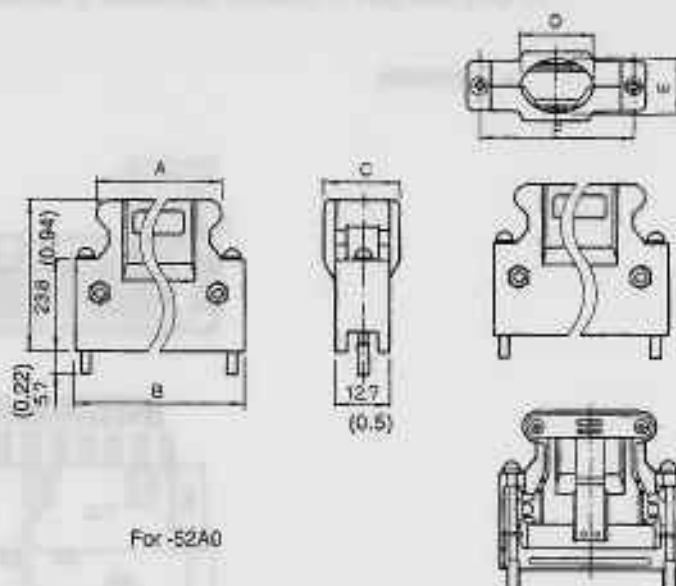

Diagram of Assembled Connector (for reference)

Units: mm (inches)

Connector	Case	A	B	C	D	E	F
10120-3000VE	10320-52A0-008	22.0 (0.87)	18.0 (0.71)	14.0 (0.55)	12.0 (0.47)	10.0 (0.39)	27.4 (1.08)

- 5) The types of connector kit are shown below. Select the type of connector kit according to the connectors selected in (2), (3), and (4) above.

Connector Kit Type	Application		Connector Kit Part List												
			Encoder/Motor Cable		For Encoder Cable						For Motor Cable				
	Encoder Type	Motor Brake With/ Without	Encoder End				Servopack End		Cap		Socket				
			Type	Q ty	Type	Qty	Type	Q ty	Type	Q ty	Type	Q ty	Type	Qty	
DP9420006-1	Incremental	Without	*1 172151 -1	1	*1 170365 -1	*3 10	*2 1	10120-3000VE	*2 1	10320-52A0-008	*1 1	172159 -1	1	*1 170365 -1	*3 5
DP9420006-2	Incremental	With									*1 1	172160 -1	1		*3 7

*1 Manufactured by AMP.

*2 Manufactured by 3M.

*3 Including one spare.

4.6.4 Brake Power Supply

1) Brake power supplies are available for 200 V and 100 V input.

200 VAC Input: LPSE-2H01

100 VAC Input: LPDE-1H01

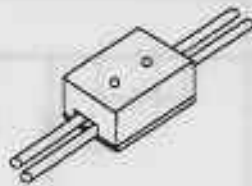

Use for Servomotor with brake.

• Dimensional Drawings

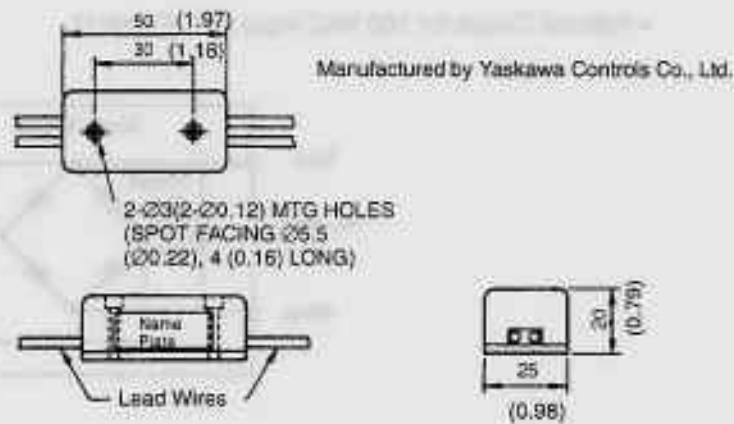

- Lead Wire Length: 500 mm each (19.69 in.)
- Max. Ambient Temperature: 60°C
- Lead Wires: Color Coded

AC Input		Brake
100V	200V	
Blue/White	Yellow/White	Red/Black

4.6.4 Brake Power Supply cont.

2) The internal circuits are shown below. While it is possible to switch either the AC or DC side of the brake power supply, it is normally safer to switch the AC side. If the DC side is to be switched, install a surge suppressor near the brake coil to prevent the surge voltages due to switching the DC side damaging the brake coil.

• Internal Circuit for 200 VAC Input (LPSE-2H01)

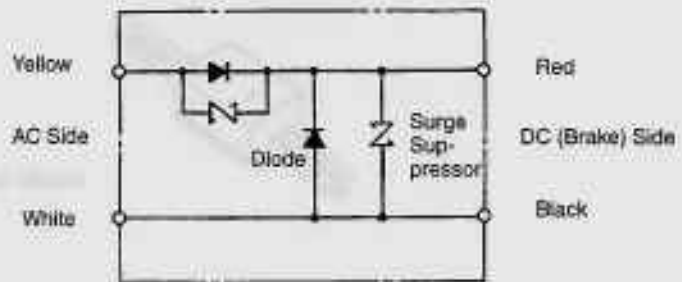

• Internal Circuit for 100 VAC Input (LPDE-1H01)

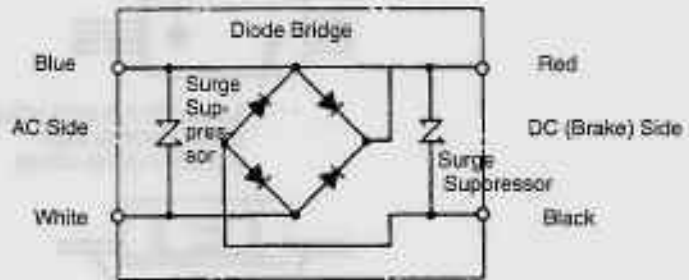

4.6.5 Encoder Cables

- 1) The dimensions and appearance of the encoder cables are shown below. Specify the cable type when ordering.

a) Connector Both Ends

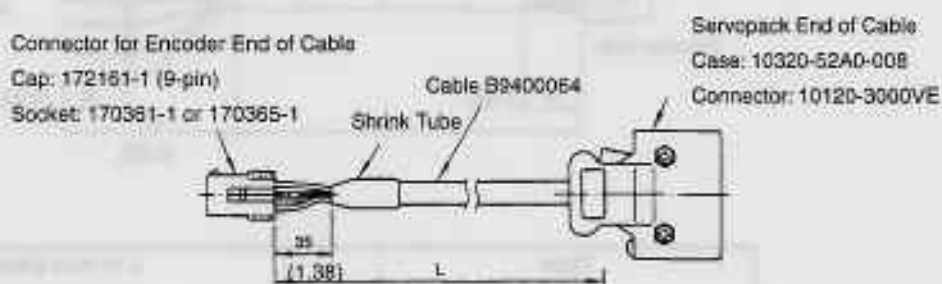

Type	L in mm (feet)	
DP9320089-1	3000^{+100}_0	$(10.0^{+0.33}_0)$
DP9320089-2	5000^{+100}_0	$(16.7^{+0.33}_0)$
DP9320089-3	10000^{+500}_0	$(33.3^{+1.67}_0)$
DP9320089-4	15000^{+500}_0	$(50^{+1.67}_0)$
DP9320089-5	20000^{+500}_0	$(66.7^{+1.67}_0)$

b) Servopack End without Connector

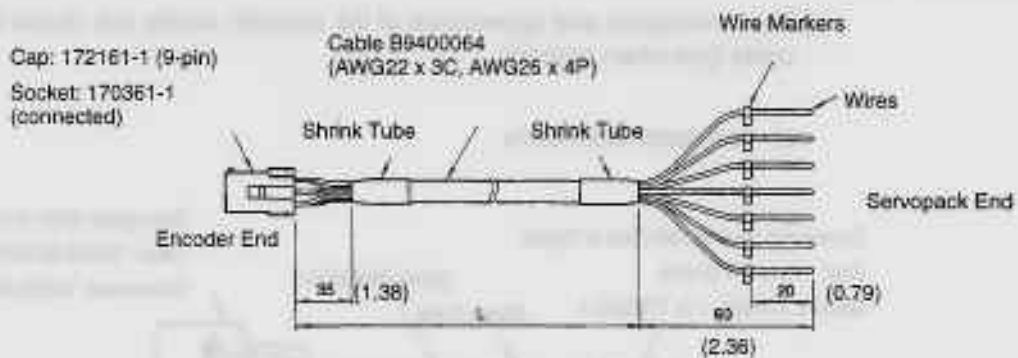

Type	L in mm (feet)
DP9320086-1	3000 ⁺¹⁰⁰ ₀ (10.0 ^{+0.33} ₀)
DP9320086-2	5000 ⁺¹⁰⁰ ₀ (16.7 ^{+0.33} ₀)
DP9320086-3	10000 ⁺⁵⁰⁰ ₀ (33.3 ^{+1.67} ₀)
DP9320086-4	15000 ⁺⁵⁰⁰ ₀ (50 ^{+1.67} ₀)
DP9320086-5	20000 ⁺⁵⁰⁰ ₀ (66.7 ^{+1.67} ₀)

Case: 10320-52A0-008 (Manufactured by 3M.)
 Connector: 10120-3000VE (Manufactured by 3M.)

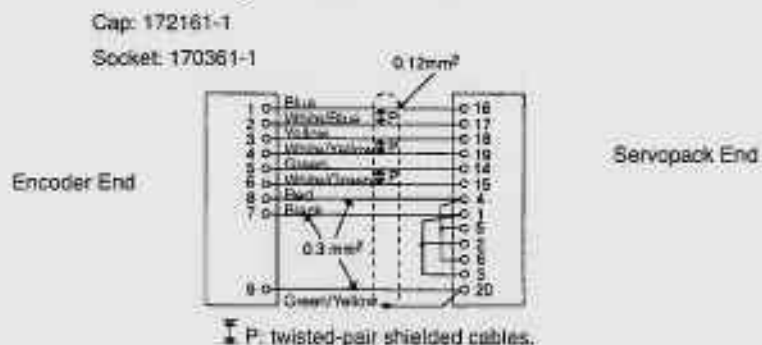

*Purchase cases and connectors separately. Refer to 4.6.3 Connector Kits for details.

c) Cable Only

Cable AWG22 x 3C, AWG26 x 4P

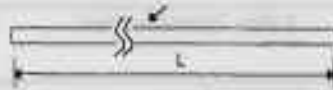

Type	L in mm (feet)	
B9400064-1	3000 ⁺¹⁰⁰ ₀	(10.0 ^{+0.33} ₀)
B9400064-2	5000 ⁺¹⁰⁰ ₀	(16.7 ^{+0.33} ₀)
B9400064-3	10000 ⁺⁵⁰⁰ ₀	(33.3 ^{+1.67} ₀)
B9400064-4	15000 ⁺⁵⁰⁰ ₀	(50 ^{+1.67} ₀)
B9400064-5	20000 ⁺⁵⁰⁰ ₀	(66.7 ^{+1.67} ₀)

Cap: 172161-1 (Manufactured by AMP.)

Case: 10320-52A0-006 (Manufactured by 3M.)

Socket: 170361-1 or 170365-1
(Manufactured by AMP.)

Connector: 10120-3000VE (Manufactured by 3M.)

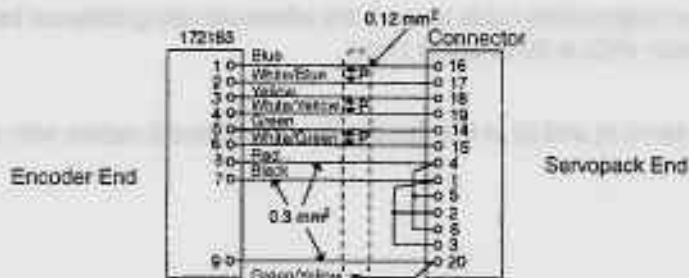

P: twisted-pair shielded cables.

- Purchase caps, sockets, cases, and connectors separately. Refer to 4.6.3 Connector Kits for details.

SERVO SELECTION AND DATA SHEETS

4.6.5 Encoder Cables cont.

- 2) Details of the encoder cables are summarized in the table below. These cables are not supplied as accessories with a Servopack or Servomotor. Purchase in standard specified lengths as required.

Cable Specification	Incremental Encoder (Yaskawa Drg. #B9400064)
Basic Specifications	Compound KQVV-SW AWG22 x 3C, AWG26 x 4P
Finished Dimension	Ø7.5 mm (Ø0.30 in.)
Internal Structure and Lead Colors	 <p>A₁ Red A₂ Black A₃ Green/Yellow F₁ Blue – White/Blue (Twisted pair) F₂ Yellow – White/Yellow (Twisted pair) F₃ Green – White/Green (Twisted pair) F₄ Orange – White/Orange (Twisted pair)</p>
Yaskawa standard specifications	Standard lengths: 3 m (9.8ft.), 5 m (16.4ft.), 10 m (32.8ft.), 15 m (49.2ft.), 20 m (65.6ft.) *

*When appropriate cable is used, the allowable wiring distance between Servopack and Servomotor (PG) is 20 m (65.6ft.) max.

Note See items a) and b) in this section for details about cables with connectors.

4.6.6 1CN Connector

1) This connector is required to connect the host controller to 1CN on the Servopack.

• Connector

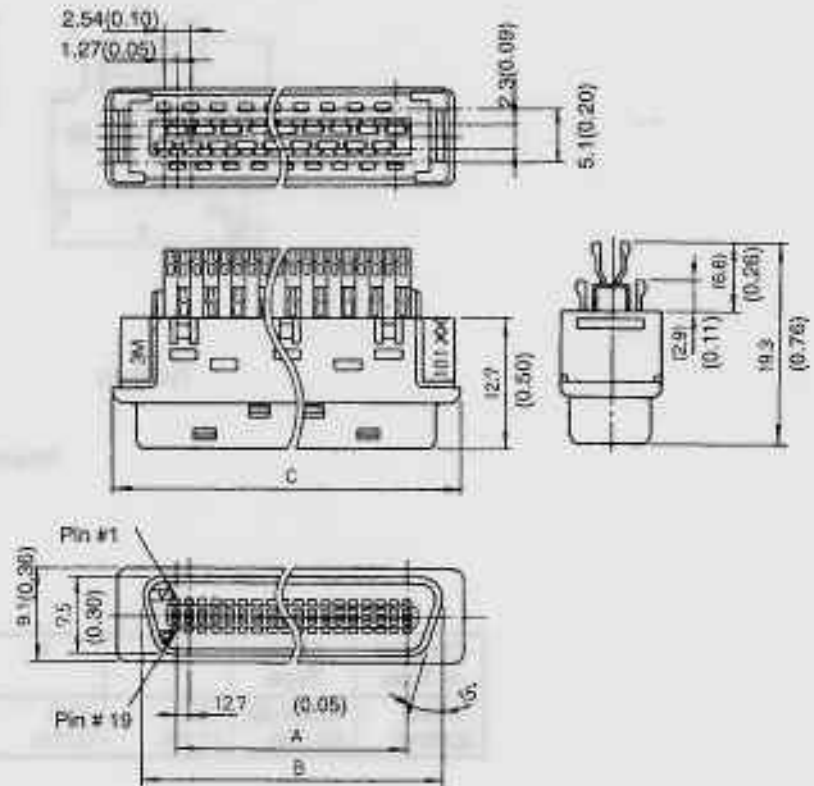

Units: mm (inches)

Connector Type	A	B	C
10136-3000VE	21.59 (0.85)	27.8 (1.09)	32.2 (1.27)

• Case

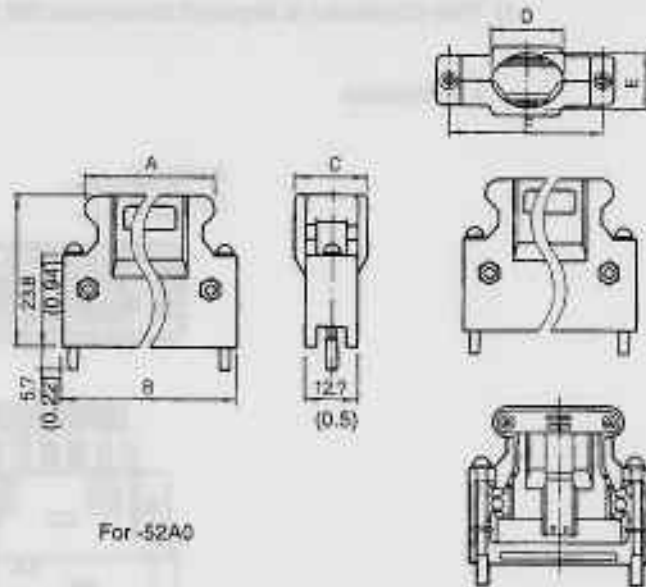

Diagram of Assembled Connector (for reference)

Units: mm (inches)

Connect or Type	Case Type	A	B	C	D	E	F
10136-3000VE	10336-52A0-008	32.2 (1.27)	43.5 (1.71)	18.0 (0.71)	17.0 (0.67)	14.0 (0.55)	37.6 (1.48)

2) The 1CN connector type is shown below.

Connector Type	Application	Connector Part List			
		Connector		Case	
		Type	Qty	Type	Qty
DP9420007	I/O connector for 1CN	10136-3000V E*	1	10336-52A0-008*	1

* Manufactured by 3M.

4.6.7 Connector Terminal Block Converter Unit

- 1) A connector terminal block converter unit comprises a 1CN connector 0.5 m (1.64 ft) cable.
The terminal block numbers match the Servopack 1CN connector numbers.

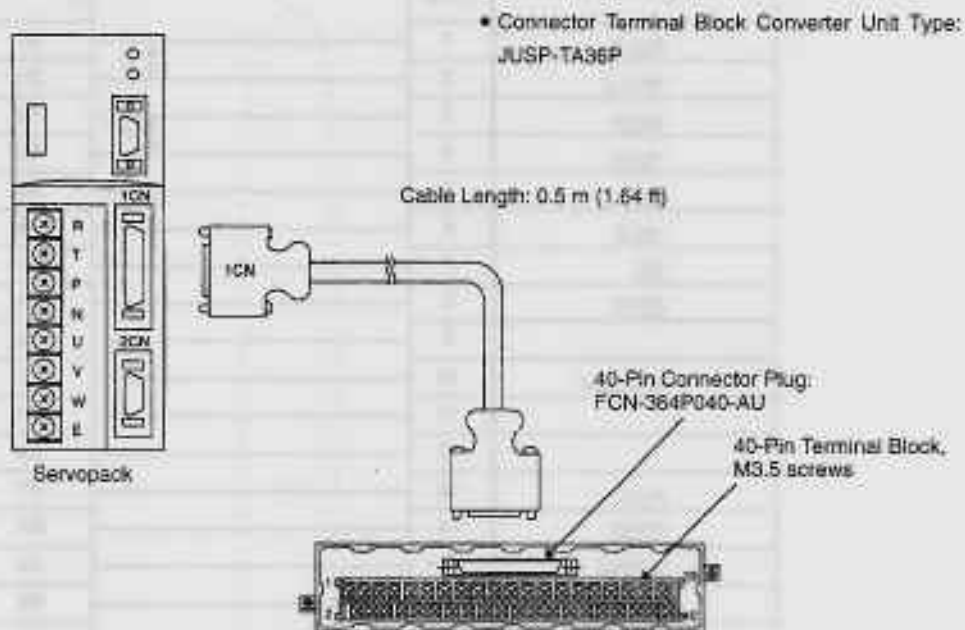

SERVO SELECTION AND DATA SHEETS

4.6.7 Connector Terminal Block Converter Unit cont.

- 2) The relationships between terminal block pin numbers and signal names are shown in the table below.

SGDE Servopack		JUSP-TA36P Terminal Block Unit		
Signal Name	1CN Pin #		Connector #	Terminal Block #
PULS	1		A1	1
*PULS	2		B1	2
SIGN	3		A2	3
*SIGN	4		B2	4
CLR	5		A3	5
*CLR	6		B3	6
BK	7		A4	7
COM	8		B4	8
	9		A5	9
SG-COM	10		B5	10
	11		A6	11
	12		B6	12
P-IN	13		A7	13
S-ON	14		B7	14
P-COM	15		A8	15
P-OT	16		B8	16
N-OT	17		A9	17
ALMRST	18		B9	18
	19		A10	19
	20		B10	20
	21		A11	21
	22		B11	22
	23		A12	23
	24		B12	24
	25		A13	25
	26		B13	26
	27		A14	27
	28		B14	28
	29		A15	29
	30		B15	30
	31		A16	31
PCO	32		B16	32
SG	33		A17	33
ALM	34		B17	34
ALM-SG	35		A18	35
FG	36		B18	36
Connector Case			A19	37
			B19	38
			A20	39
			B20	40

Cable: Supplied with terminal block
 P : Twisted pair

4.6.8 Cable With 1CN Connector and One End Without Connector

- 1) Use a cable with no connector at the host controller end. The loose wires are marked with labels with terminal numbers indicated.

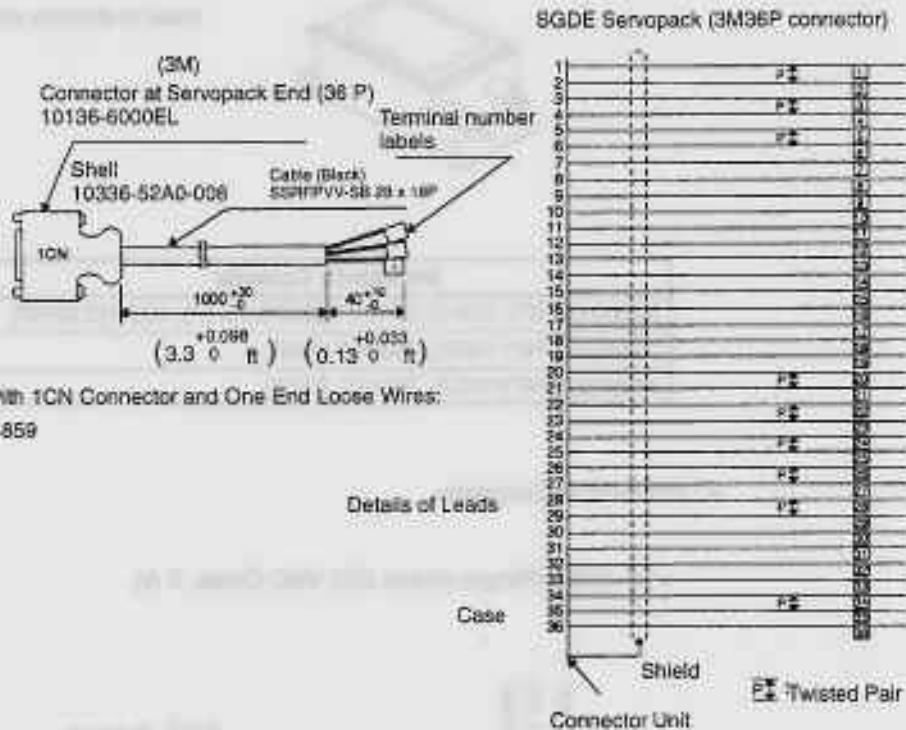

4

4.6.9 Circuit Breaker

- 1) The customer should purchase a circuit breaker (MCCB) of appropriate capacity.



• Recommended Product

Ground fault detector for motor protection manufactured by
Mitsubishi Electric Co. Ltd.
Type: MN50-CF
Rated Current: 7.1 A, 10 A, 16 A, 25 A, 32 A, 45A

Use to protect the power lines.

4.6.10 Noise Filter

- 1) Select the noise filter from the following three types according to the Servopack capacity.



Install to eliminate external noise from the power lines.

Servopack Capacity	Noise Filter Type
30W(0.04 HP), 50W(0.07HP), 100W(0.13HP), 200W(0.27HP)	LF-205A
200W(0.27HP)(100V), 400W(0.53HP)	LF-210
300W(0.40HP)(100V), 750W(1.01HP)	LF-220

• Dimensional Diagrams

- LF-205A (Single-phase 200 VAC Class, 5 A)

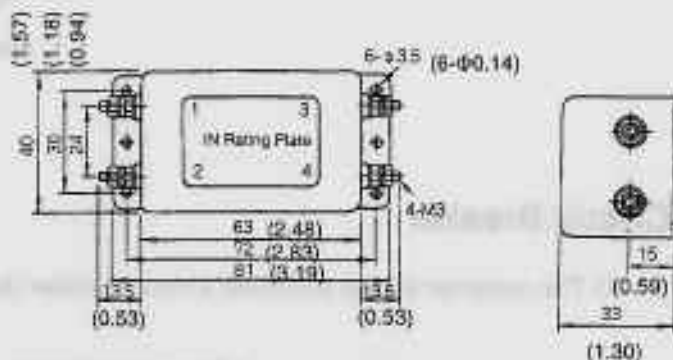

- LF-210 (Single-phase 200 VAC Class, 10 A)

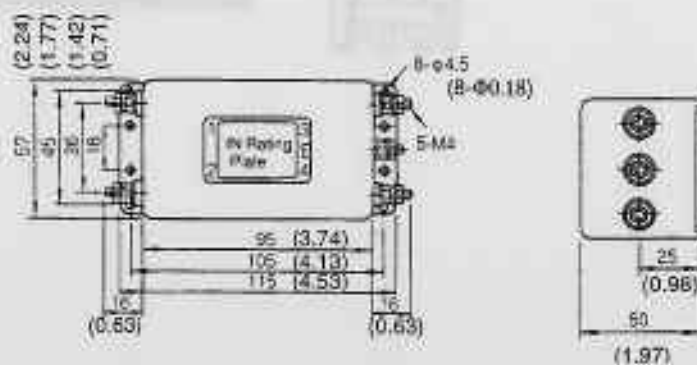

- LF-220 (Single-phase 200 VAC Class, 20 A)

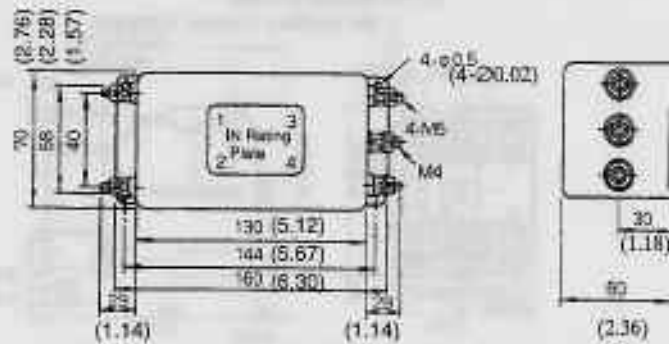

4.6.11 Magnetic Contactor

- 1) Use one 30 A magnetic contactor of the type shown below for a single Σ Series, regardless of capacity. For multiple servo systems, select the magnetic contactor according to the total capacity.



Type: HI-15E5 (30 A)

Turns servo ON and OFF.

(Note) Attach an appropriate surge suppressor to the magnetic contactor.

- Internal Connection Diagram

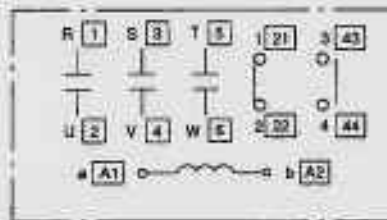

4.6.12 Surge Suppressor

• Dimensional Diagram

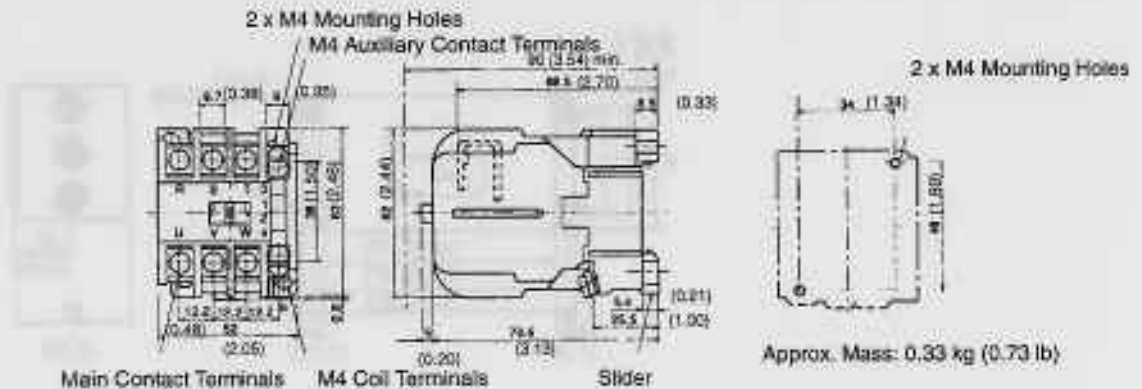

4.6.12 Surge Suppressor

- 1) Attach a surge suppressor to the magnetic contactor to prevent power supply noise and protect contacts.

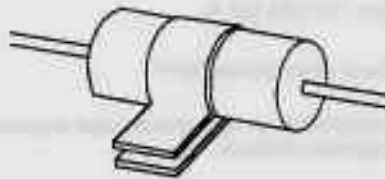

• Recommended Product

Spark Killer manufactured by Okaya Electric Industries Co., Ltd.
 Type: CR50500BA (250 VAC)
 Static Electricity Capacity: 0.5 μ F \pm 20%
 Resistance: 50 Ω (1/2 W) \pm 30%

4.6.13 Regenerative Unit

1) JUSP-RG08 type

Dimensional drawings of the regenerative unit are shown below.

• Dimensional Drawings

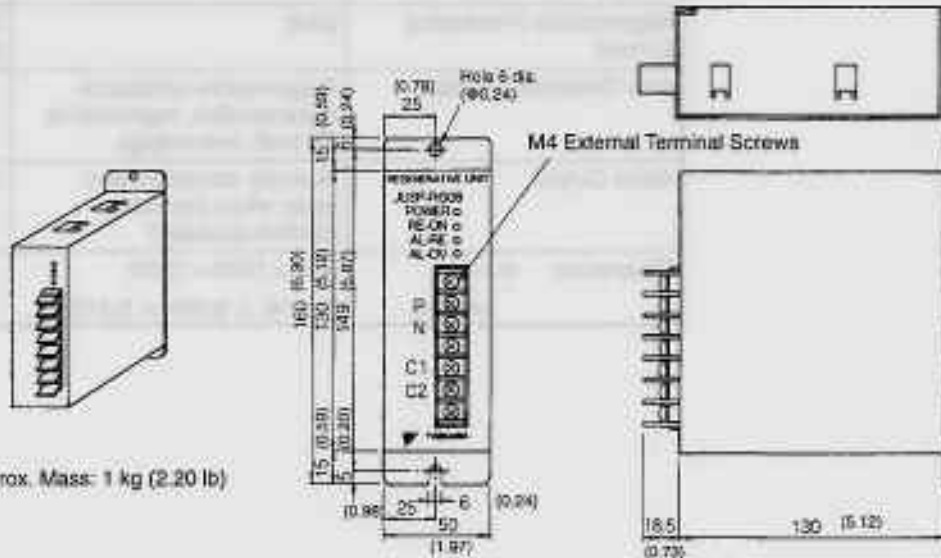

2) JUSP-RG08C type

JUSP-RG08C type is an exterior type regenerative unit. When regenerative ability of the built-in resistor is insufficient, install this regenerative unit to enhance the regenerative ability.

• Dimensional Drawings

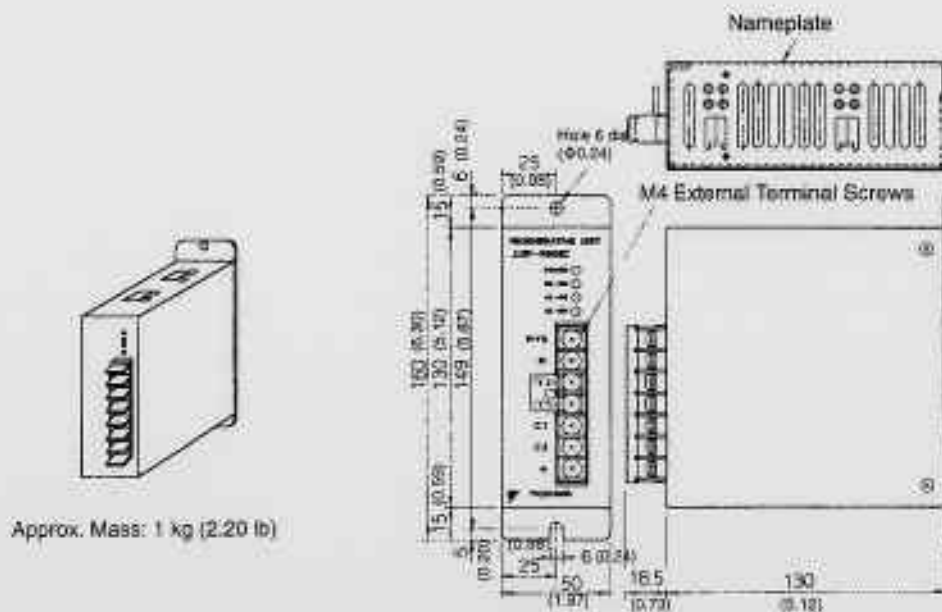

• Regenerative Unit Specifications

Type	JUSP-RG08 JUSP-RG08C	Remarks
Applicable Servopack	SGDE Servopack	
Regenerative Working Voltage	380Vdc	
Regenerative Processing Current	8Adc	Regenerative Resistance: 50 Ω, 60 W
Error Detection Function	Regenerative resistance disconnection, regenerative TR fault, overvoltage	
Alarm Output	Normally closed contact (open when protective function operates)	200 V operation OK
Dimensions in mm (inches)	55W × 160H × 130D (2.17W × 6.30H × 5.31D)	

4.6.14 Cables for Connecting PC and Servopack

- 1) Special cables for connecting a PC to a Servopack. Using these cables allows monitoring and setting of user constants with a PC.
PC software is available for these communications. Ask your Yaskawa representative for details. Operate the software as described in the manual supplied.

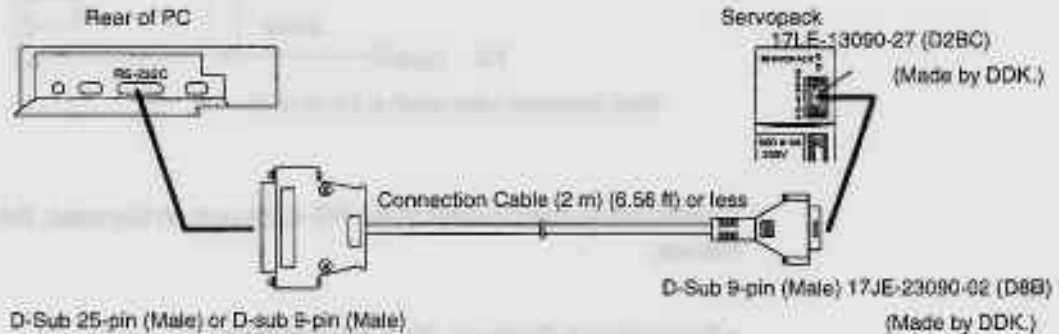

- Dimensional Drawings for Type DE9405258 (for NEC PC)

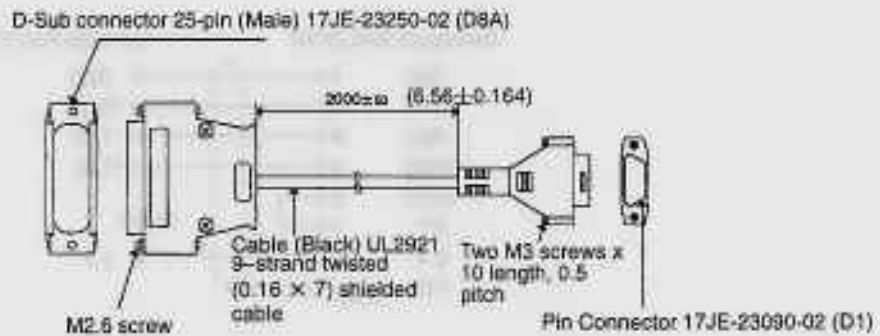

Note: Fold back the cable shielding at each end of the cable and secure it with clamps.

- 2) The communications specifications and connecting-circuit specifications are listed below.

- Baud Rate: 9600 bps
- Number of Bits Start: 1 bit
Data: 7 bits
Stop: 1 bit
Parity: 1 bit (even)
- Synchronization Start-Stop
- XON/XOFF Control None
- Shift Control: None

SERVO SELECTION AND DATA SHEETS

4.6.14 Cables for Connecting PC and Servopack cont.

- Communications Method: Semi-duplex

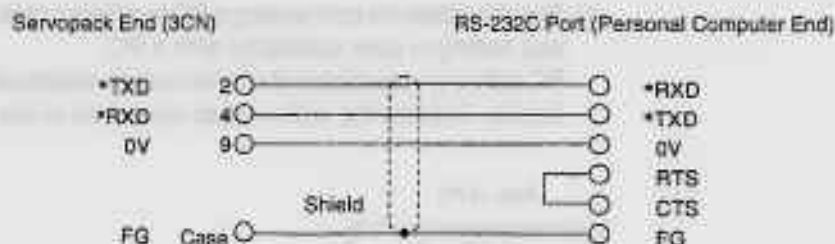

Note: Maximum cable length is 2 m (6.56 ft).

- 3) Connection is also possible to the RS-422A port. In this case, the connection circuit is as follows:

- Transmission Distance: 30 m (98.4 ft) max.

- Transmission System: RS-422A

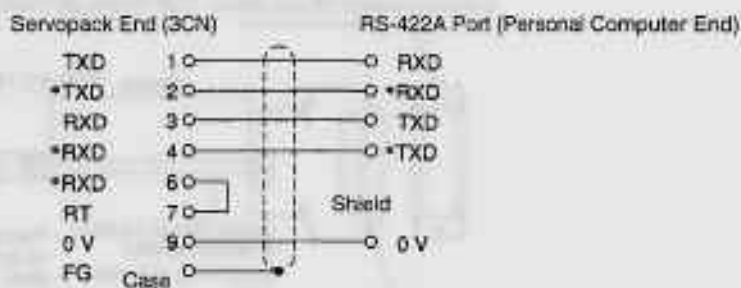

- Terminal Arrangement at Servopack End

Pin #	Signal Name	Signal Circuit Name	Signal Direction
1	TXD	Transmit data (not inverted)	P→S
2	*TXD	Transmit data (inverted)	P→S
3	RXD	Receive data (not inverted)	P→S
4	*RXD	Receive data (inverted)	P→S
5	OPH		#
6	*RXD	Shorting pins 6 and 7 inserts 220 Ω termination resistance between RXD and *RXD.	
7	RT		
8	5VPP		#
9	GND	Signal ground 0 V	

P: Personal computer
 S: Servopack
 #: Terminal not used, leave open.

4) Cable for connecting Servopack and IBM PC (IBM compatible PC)

Use Yaskawa DE9408565 type cable.

- Dimensional Drawings

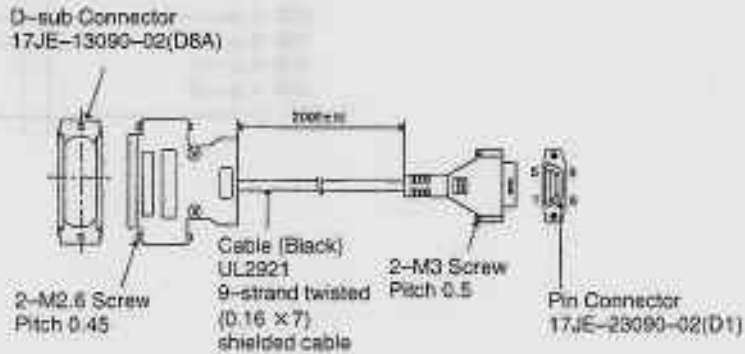

Note: Fold back the cable shielding at each end of the cable and secure it with clamp.

- Connection

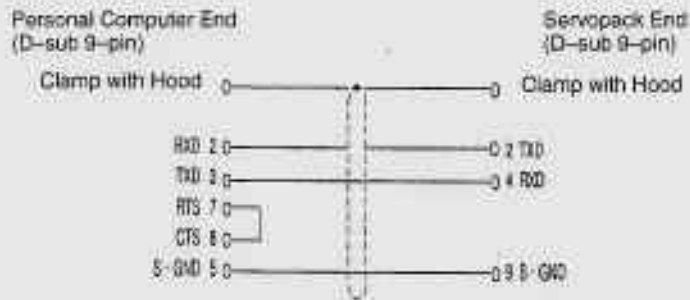

5) Cable for connecting Servopack and NEC PC-98 half-pitch connector

Use Yaskawa DE9408564 type cable.

- Dimensional Drawings

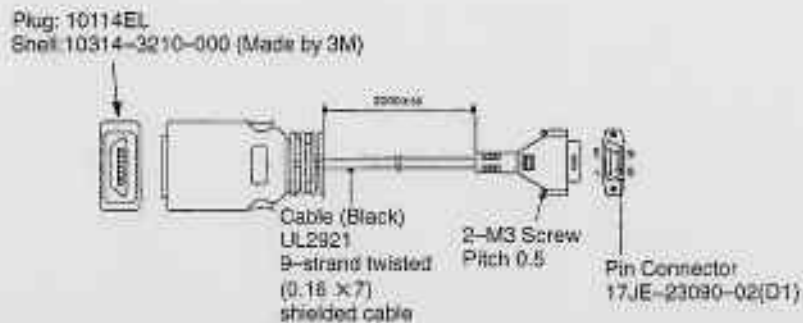

Note: Fold back the cable shielding at each end of the cable and secure it with clamp.

SERVO SELECTION AND DATA SHEETS

4.6.14 Cables for Connecting PC and Servopack cont.

• Connection

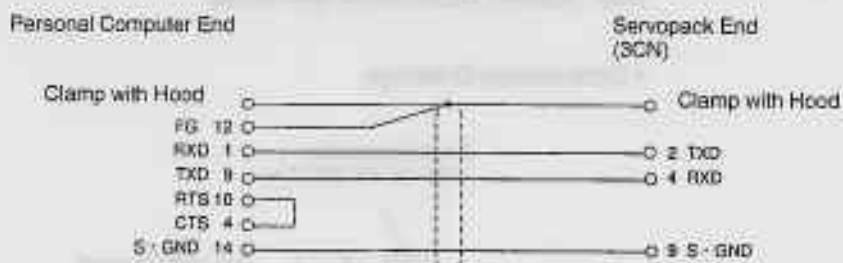

INSPECTION, MAINTENANCE, AND TROUBLESHOOTING

5

This chapter describes the basic inspections and maintenance to be carried out by the customer.

In addition, troubleshooting procedures are described for problems which cause an alarm display and for problems which result in no alarm display.

5.1	Inspection and Maintenance	180
5.1.1	Servomotor	180
5.1.2	Servopack	181
5.2	Troubleshooting	182
5.2.1	Troubleshooting Problems with Alarm Display	182
5.2.2	Troubleshooting Problems With No Alarm Display	194
5.2.3	Internal Connection Diagram and Instrument Connection Examples	195

5.1 Inspection and Maintenance

This section describes the basic inspections and maintenance for Σ -Series servo drives.

5.1.1	Servomotor	180
5.1.2	Servopack	181

5.1.1 Servomotor

For inspection and maintenance of servomotors, follow the simple, daily inspection procedures in the table below.

The AC servomotors are brushless. Simple, daily inspection is sufficient. The inspection and maintenance frequencies in the table are only guidelines. Determine the frequency to suit the operating conditions and environment.

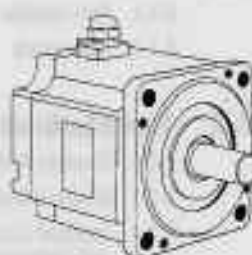

Item	Frequency	Procedure	Comments
Vibration and noise	Daily	Touch and listen.	Levels higher than normal?
Appearance	According to degree of contamination	Clean with cloth or compressed air.	
Insulation resistance measurement	Yearly	Disconnect Servopack and test insulation resistance at 500 V. Must exceed 10 M Ω . (See note below)	Contact your Yaskawa representative if the insulation resistance is below 10 M Ω .
Replace oil seal	Every 5,000 hours	Remove servomotor from machine and replace oil seal.	Applies only to motors with oil seal.
Overhaul	Every 20,000 hours or 5 years	Contact your Yaskawa representative.	The customer should not disassemble and clean the servomotor.

Note Measure across the servomotor FG (green/yellow) and the U-phase (red), V-phase (white), or W-phase (blue) power lead.

During inspection and maintenance, do not disassemble the servomotor. If disassembly of the servomotor is required, contact your Yaskawa representative.

5.1.2 Servopack

For inspection and maintenance of the Servopack, follow the inspection procedures in the table below at least once every year.

The Servopack contains highly reliable parts and daily inspection is not required. Carry out the inspections and maintenance in the table below once every year.



Item	Frequency	Procedure	Remedy
Clean unit interior and circuit boards	Yearly	Check for dust, dirt, and oil on the surfaces.	Clean with compressed air.
Loose screws	Yearly	Check for loose terminal block and connector screws.	Tighten any loose screws.
Defective parts in unit or on circuit boards	Yearly	Check for discoloration, damage or discontinuities due to heating.	Contact your Yaskawa representative.

Part Replacement Schedule

The following parts are subject to mechanical wear or deterioration over time. To avoid failure, replace these parts at the frequency indicated.

Part	Standard Replacement Period	Replacement Method
Smoothing Capacitor	7 to 8 years	Test. Replace with new part if necessary.
Relays	—	Test. Replace if necessary.
Fuse	10 years	Replace with new part.

Note Operating Conditions:

- Ambient Temperature: annual average 30°C
- Load Factor: 80% max.
- Operation Rate: 20 hours/day max.

5.2 Troubleshooting

This section describes causes and remedies for problems which cause an alarm display and for problems which result in no alarm display.

6.2.1	Troubleshooting Problems with Alarm Display	182
6.2.2	Troubleshooting Problems With No Alarm Display	194
6.2.3	Internal Connection Diagram and Instrument Connection Examples	195

5.2.1 Troubleshooting Problems with Alarm Display

Refer to the tables below to identify the cause of a problem which causes an alarm display and take the corrective actions described.

Note that A.99 does not indicate an alarm.

Contact your Yaskawa representative if the problem cannot be solved by the described procedures.

• Display and Outputs

Digital Operator Display and Alarm Name	Alarm Output
	ALM Output
A.99	ON

OFF: Output transistor is OFF
 ON: Output transistor is ON

Status When Alarm Occurred

Indicates normal operation. Not an alarm.

• Display and Outputs

Digital Operator Display and Alarm Name	Alarm Output
	ALM Output
A.02 User constants breakdown	OFF

OFF: Output transistor is OFF
ON: Output transistor is ON

Status When Alarm Occurred

At power ON — **A, B**

	Cause	Remedy
A	Power turned OFF during parameter write. Alarm occurred next power ON.	Replace Servopack.
B	Circuit board (1PWB) defective	Replace Servopack.

• Display and Outputs

Digital Operator Display and Alarm Name	Alarm Output
	ALM Output
A.04 User constant setting error	OFF

OFF: Output transistor is OFF
ON: Output transistor is ON

Status When Alarm Occurred

At power ON — **A, B**

	Cause	Remedy
A	An out-of-range user constant was previously set or loaded.	Reset all user constants in range. Otherwise, re-load correct user constants.
B	Circuit board (1PWB) defective	Replace Servopack.

5.2.1 Troubleshooting Problems with Alarm Display cont.

• Display and Outputs

	Digital Operator Display and Alarm Name	Alarm Output
		ALM Output
A.10 Overcurrent		OFF

OFF: Output transistor is OFF

ON: Output transistor is ON

Status When Alarm Occurred

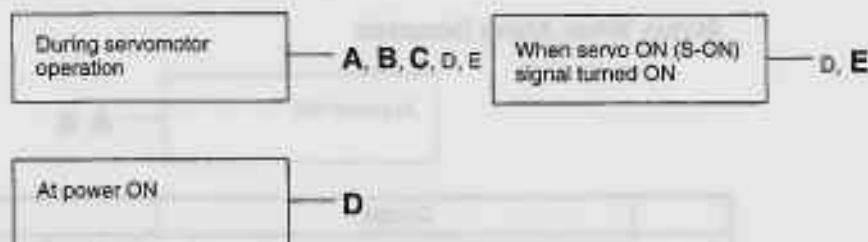

	Cause	Remedy
A	Wiring grounded between Servopack and servomotor.	Check and correct wiring.
B	Servopack ambient temperature exceeds 50°C	Bring Servopack ambient temperature to 50°C Note Alarm cannot be reset while power transistor module temperature exceeds 90°C.
C	Servomotor U, V, or W phase grounded.	Replace servomotor.
D	<ul style="list-style-type: none"> • Circuit board (1PWB) defective • Power transistor defective 	Replace Servopack.
E	Current feedback circuit, power transistor, DB relay, or circuit board defective.	Replace Servopack.

• Display and Outputs

Digital Operator Display and Alarm Name	Alarm Output
	ALM Output
A.31 Position error pulse overflow	OFF

OFF: Output transistor is OFF

ON: Output transistor is ON

Status When Alarm Occurred

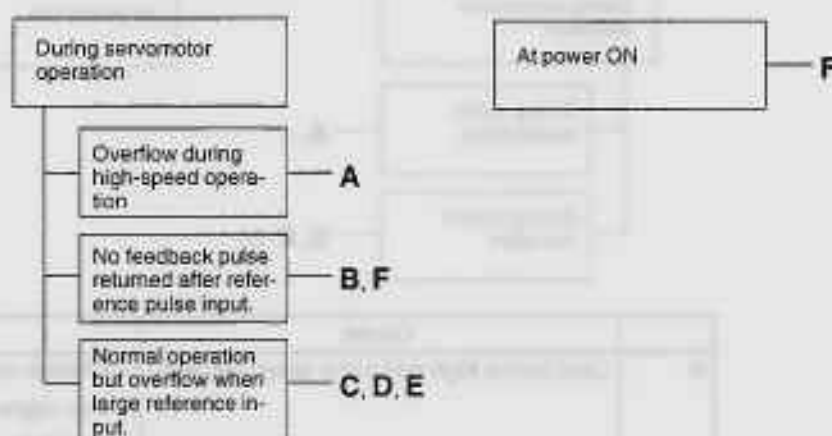

	Cause	Remedy
A	Servomotor wiring incorrect.	Check and correct wiring. (Check A-, B-, C-phase pulses correct at 2CN.)
B	Encoder wiring incorrect (disconnection, shortcircuit, power supply, etc.)	
C	Servopack adjustment incorrect	Increase speed loop gain (Cn-04) and/or position loop gain (Cn-1A).
D	Servomotor overloaded	Reduce load torque and inertia. Otherwise, replace with larger capacity servomotor.
E	Position reference pulse frequency too high	<ul style="list-style-type: none"> • Decrease reference pulse frequency. • Use smoothing function. • Change electronic gear ratio.
F	Circuit board (1PWB) defective.	Replace Servopack.

5.2.1 Troubleshooting Problems with Alarm Display cont.

• Display and Outputs

ALM Output

	Digital Operator Display and Alarm Name	Alarm Output
		ALM Output
	A.40 Overvoltage	OFF

OFF: Output transistor is OFF
ON: Output transistor is ON

Status When Alarm Occurred

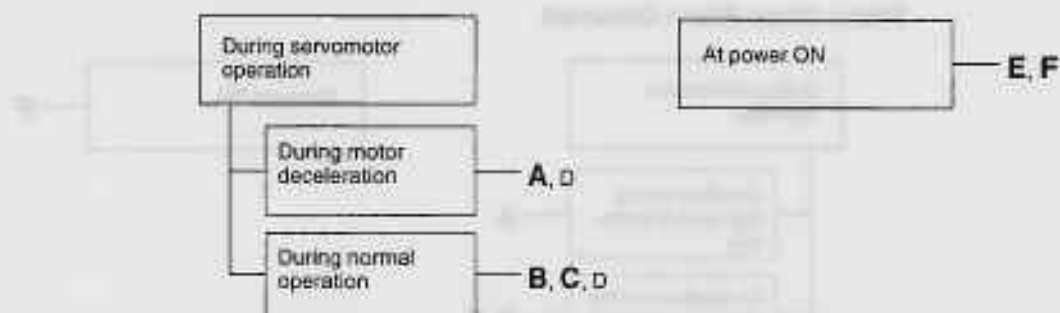

	Cause	Remedy
A	Load inertia high and motor speed too high	<ul style="list-style-type: none"> Change operating conditions. Use regenerative unit. If multiple units are used, connect all P, N terminals in parallel.
B	Load exceeds capacity of regenerative unit	Change operating conditions.
C	Servomotor speed too high	Reduce motor speed.
D	Servopack defective	Replace Servopack.
E	Input voltage too high	Change input voltage to normal value.
F	Circuit board (1PWB) defective.	Replace Servopack.

• Display and Outputs

Digital Operator Display and Alarm Name	Alarm Output
	ALM Output
A.51 Overspeed	OFF

OFF: Output transistor is OFF

ON: Output transistor is ON

Status When Alarm Occurred

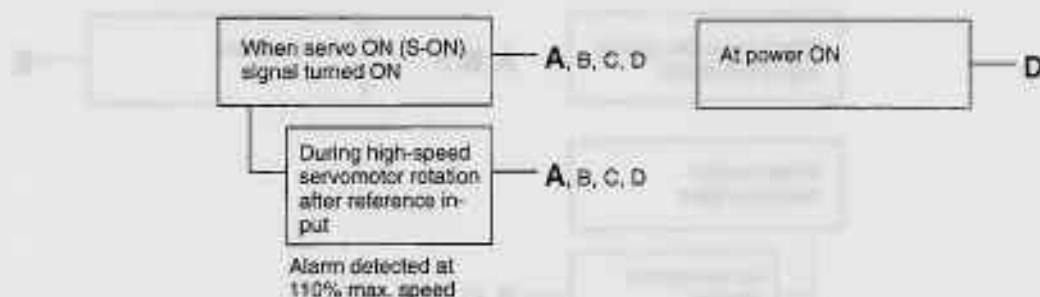

	Cause	Remedy
A	<ul style="list-style-type: none"> • Servomotor wiring incorrect. • Encoder wiring incorrect (disconnection, shortcircuit, power supply, etc.) 	Check and correct wiring. (Check A-, B-, C-phase pulses correct at 2CN.)
B	Incremental encoder power not supplied from Servopack.	Use the Servopack power supply for the encoder.
C	Noise in encoder wiring.	Separate encoder wiring from main wiring circuits.
D	Circuit board (1PWB) defective	Replace Servopack.

5.2.1 Troubleshooting Problems with Alarm Display cont.

• Display and Outputs

Servopack Alarm Display

Digital Operator Display and Alarm Name	Alarm Output
	ALM Output
A.70 Overload	OFF

OFF: Output transistor is OFF
 ON: Output transistor is ON

Status When Alarm Occurred

Servopack Alarm Display

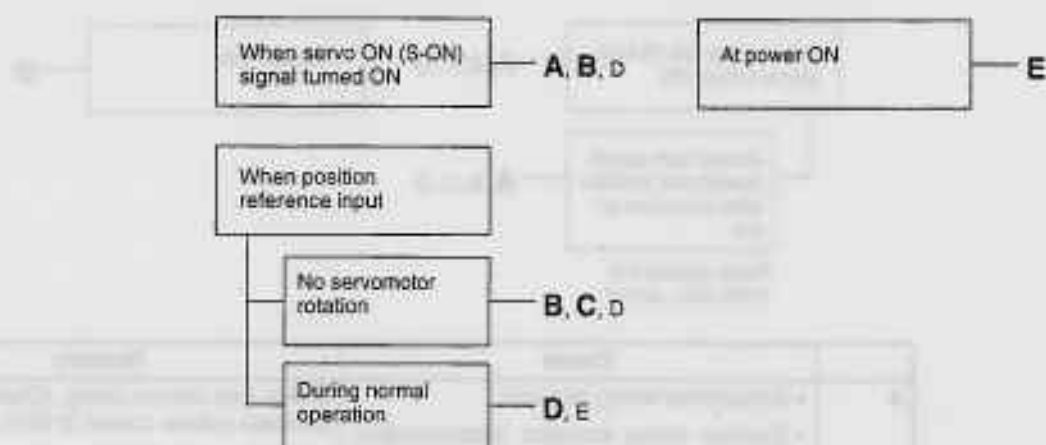

	Cause	Remedy
A	Servomotor wiring incorrect or disconnected	Check wiring and connectors at servomotor.
B	Encoder wiring incorrect or disconnected	Check wiring and connectors at encoder.
C	Load greatly exceeds rated torque	Reduce load torque and inertia. Otherwise, replace with larger capacity servomotor.
D	Incremental encoder power not supplied from Servopack.	Use the Servopack power supply for the encoder.
E	Circuit board (1PWB) defective	Replace Servopack.

• Display and Outputs

Digital Operator Display and Alarm Name	Alarm Output
	ALM Output
A.C1 Servo overrun	OFF

OFF: Output transistor is OFF
ON: Output transistor is ON

Status When Alarm Occurred

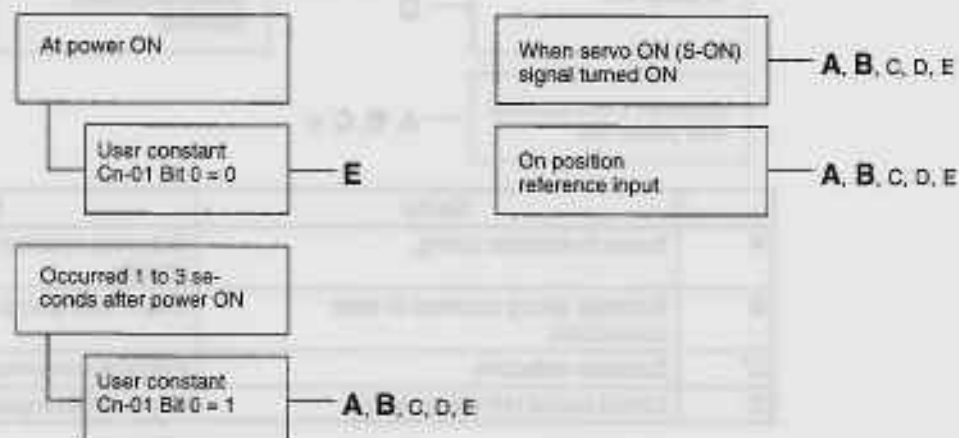

	Cause	Remedy
A	Servomotor wiring incorrect or disconnected	Check wiring and connectors at servomotor.
B	Encoder wiring incorrect or disconnected	Check wiring and connectors at encoder.
C	Incremental encoder power not supplied from Servopack.	Use the Servopack power supply for the encoder.
D	Encoder defective	Replace servomotor.
E	Circuit board (1PWB) defective	Replace Servopack.

• Display and Outputs

Digital Operator Display and Alarm Name	Alarm Output
	ALM Output
A.C2 Encoder phase detection error	OFF

OFF: Output transistor is OFF
ON: Output transistor is ON

Status When Alarm Occurred

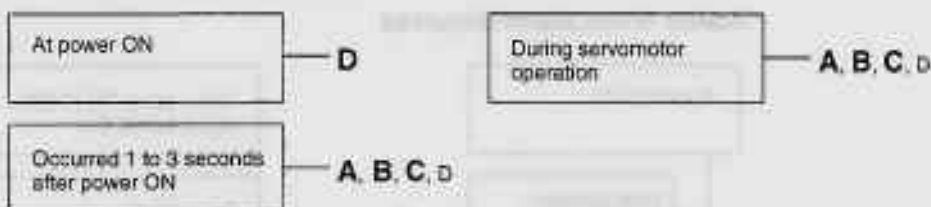

	Cause	Remedy
A	Noise in encoder wiring.	Separate encoder wiring from main wiring circuits.
B	Encoder wiring incorrect or poor connection	Check wiring and connectors at encoder.
C	Encoder defective	Replace servomotor.
D	Circuit board (1PWB) defective	Replace Servopack.

• Display and Outputs

Digital Operator Display and Alarm Name	Alarm Output
	ALM Output
A.C3 Encoder A-, B-phase discontinuity	OFF

OFF: Output transistor is OFF
ON: Output transistor is ON

Status When Alarm Occurred

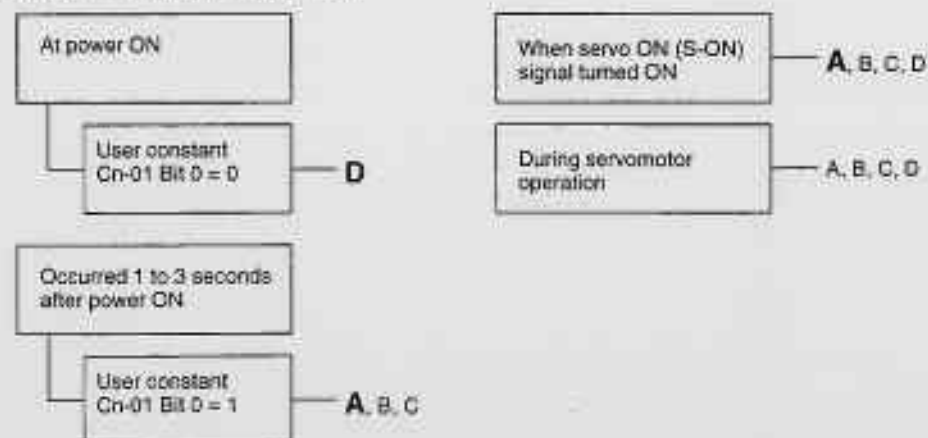

	Cause	Remedy
A	Encoder wiring incorrect or poor connection	Check wiring and connectors at encoder.
B	Noise in encoder wiring.	Separate encoder wiring from main wiring circuits.
C	Encoder defective	Replace servomotor.
D	Circuit board (1PWB) defective	Replace Servopack.

• Display and Outputs

Digital Operator Display and Alarm Name	Alarm Output
	ALM Output
A.C4 Encoder C-phase discontinuity	OFF

OFF: Output transistor is OFF
ON: Output transistor is ON

Status When Alarm Occurred

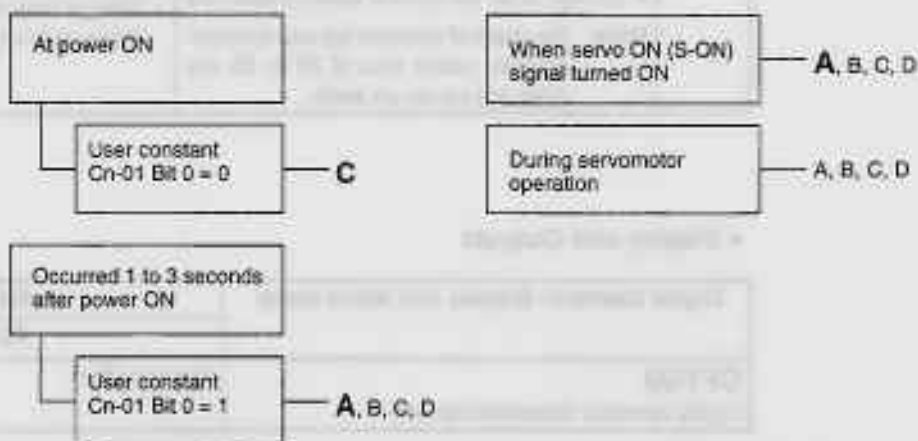

	Cause	Remedy
A	Encoder wiring incorrect or poor connection	Check wiring and connectors at encoder.
B	Noise in encoder wiring.	Separate encoder wiring from main wiring circuits.
C	Encoder defective	Replace servomotor.
D	Circuit board (1PWB) defective	Replace Servopack.

5.2.1 Troubleshooting Problems with Alarm Display cont.

• Display and Outputs

Digital Operator Display and Alarm Name	Alarm Output
	ALM Output
A.F3 Power loss error	OFF

OFF: Output transistor is OFF
ON: Output transistor is ON

Status When Alarm Occurred



	Cause	Remedy
A	Time between turning power OFF and back ON was shorter than the power holding time.	After turning power OFF, wait more than the power holding time (6 to 15 s, according to type) before turning the power back ON.
B	If any of the following power supply conditions are met during motor operation: <ul style="list-style-type: none"> • Complete power failure : half cycle of supply frequency • Voltage drop: full cycle of supply frequency Note: Because of detector lag and detector margin, power loss of 30 to 55 ms does not cause an alarm.	Check the power supply. Terms <ul style="list-style-type: none"> • Complete power failure=Power failure where voltage drops to zero. • Voltage drop=Power failure where voltage drops, but not to zero.

• Display and Outputs

Digital Operator Display and Alarm Name	Alarm Output
	ALM Output
CPF00 Digital operator transmission error 1	Not specified

Note This alarm is not stored in alarm trace-back function memory.

Status When Alarm Occurred



	Cause	Remedy
A	Cable defective or poor contact between digital operator and Servopack.	<ul style="list-style-type: none"> • Check connector connections. • Replace cable.
B	Malfunction due to external noise	Separate digital operator and cable from noise source.
C	Digital operator defective	Replace digital operator.
D	Servopack defective	Replace Servopack.

• Display and Outputs

Digital Operator Display and Alarm Name	Alarm Output
	ALM Output
CPF01 Digital operator transmission error 2	Not specified

Note This alarm is not stored in alarm trace-back function memory.

Status When Alarm Occurred

During operation

A B C D

	Cause	Remedy
A	Cable defective or poor contact between digital operator and Servopack.	<ul style="list-style-type: none"> • Check connector connections. • Replace cable.
B	Malfunction due to external noise	Separate digital operator and cable from noise source.
C	Digital operator defective	Replace digital operator.

5.2.2 Troubleshooting Problems With No Alarm Display

Refer to the tables below to identify the cause of a problem which causes no alarm display and take the remedy described.

Turn OFF the servo system power supply before commencing the shaded procedures.

Contact your Yaskawa representative if the problem cannot be solved by the described procedures.

Troubleshooting Table No Alarm Display

Symptom	Cause	Inspection	Corrective Action
Servomotor does not start	Power not connected.	Check voltage across R and T.	Correct the power circuit.
	Loose connection	Check terminals of connectors (1CN, 2CN)	Tighten any loose parts.
	Connector (1CN) external wiring incorrect	Check connector (1CN) external wiring	Refer to connection diagram and correct wiring.
	Servomotor or encoder wiring disconnected.		Reconnect wiring
	Overloaded	Run under no load.	Reduce load or replace with larger capacity servomotor.
	Position references not input	Check input pins # 1 to 4 of connector 1CN.	Correctly input position references.
	S-ON is turned OFF	Cn-01 Bit 0 is 0.	Turn S-ON input ON.
	Reference pulse mode selection incorrect.	Refer to Subsection 2.2.1.	Select correct user constants Cn-02 Bits 3, 4, 5.
	Encoder type differs.	1024 P/R incremental encoder?	Use the motor with 1024 P/R incremental encoder.
	P-OT and N-OT inputs are turned OFF.	(If Cn-01 Bits 2, 3 are 0)	Turn P-OT and N-OT input signals ON.
CLR input is turned ON	Check status of error counter clear input.	Turn CLR input OFF.	
Servomotor moves instantaneously, then stops	Servomotor or encoder wiring incorrect.		Refer to Subsection 2.6.6 and correct wiring.
Suddenly stops during operation and will not restart	Alarm reset signal (ALM-RST) is turned ON because an alarm occurred.		Remove cause of alarm. Turn alarm reset signal (ALM-RST) from ON to OFF.
Servomotor speed unstable	Wiring connection to motor defective	Check connection of power lead (U, V, and W phase) and encoder connectors.	Tighten any loose terminals or connectors
Servomotor vibrates at approximately 200 to 400 Hz.	Speed loop gain value too high.		Reduce speed loop gain (Cn-04) preset value.
	Position reference input lead too long.		Minimize length of speed/position reference input lead, with impedance not exceeding several hundred ohms
	Position reference input lead is bundled with power cables.		Separate reference input lead at least 30 cm from power cables.
High rotation speed overshoot on starting and stopping.	Speed loop gain value too high.		Reduce speed loop gain (Cn-04) preset value.

Symptom	Cause	Inspection	Corrective Action
Servomotor overheated	Ambient temperature too high	Measure servomotor ambient temperature.	Reduce ambient temperature to 40°C max.
	Servomotor surface dirty	Visual check	Clean dust and oil from motor surface.
	Overloaded	Run under no load.	Reduce load or replace with larger capacity servomotor.
Abnormal noise	Mechanical mounting incorrect	Servomotor mounting screws loose?	Tighten mounting screws.
		Coupling not centered?	Center coupling.
		Coupling unbalanced?	Balance coupling.
	Bearing defective	Check noise and vibration near bearing.	Consult your Yaskawa representative if defective.
Machines causing vibrations	Foreign object intrusion, damage or deformation of sliding parts of machine.	Consult with machine manufacturer.	

5.2.3 Internal Connection Diagram and Instrument Connection Examples

The SGDE Servopack internal connection diagram and instrument connection examples are given below.

Refer to these diagrams during inspection and maintenance.

1) Internal Connection Diagram

Single-phase 200 to 230 VAC $\pm 10\%$ / -15% 50/60 Hz

or single-phase 100 to 115 VAC $\pm 10\%$ / -15% 50/60 Hz

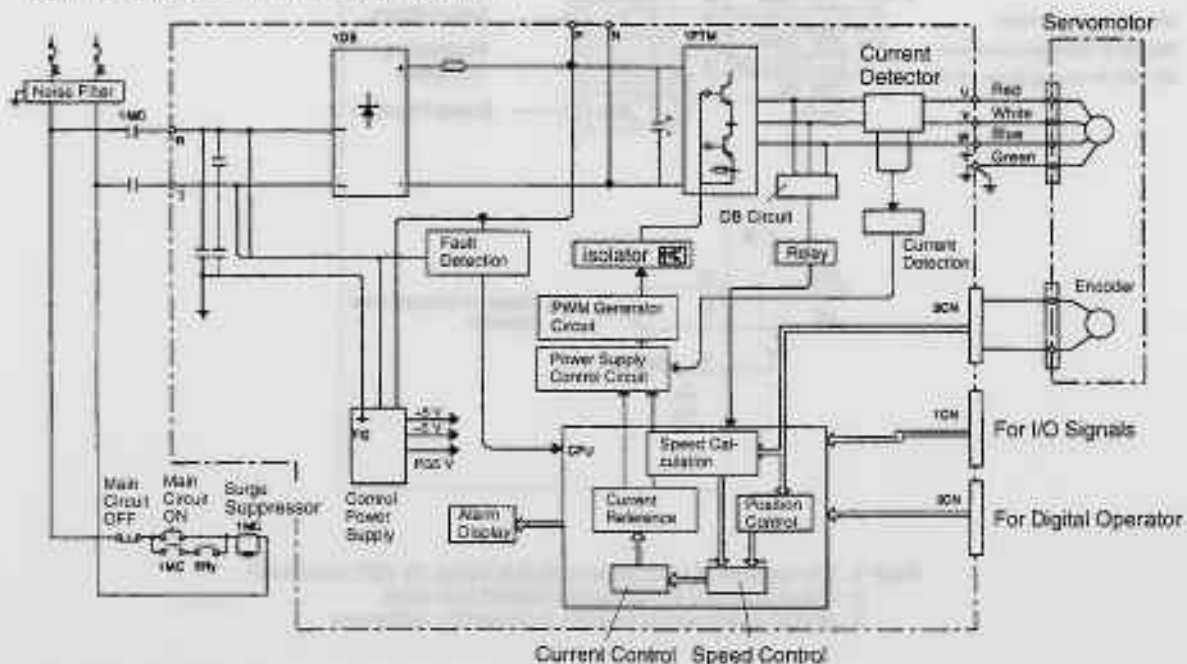

5.2.3 Internal Connection Diagram and Instrument Connection Examples cont.

2) Instrument Connection Examples

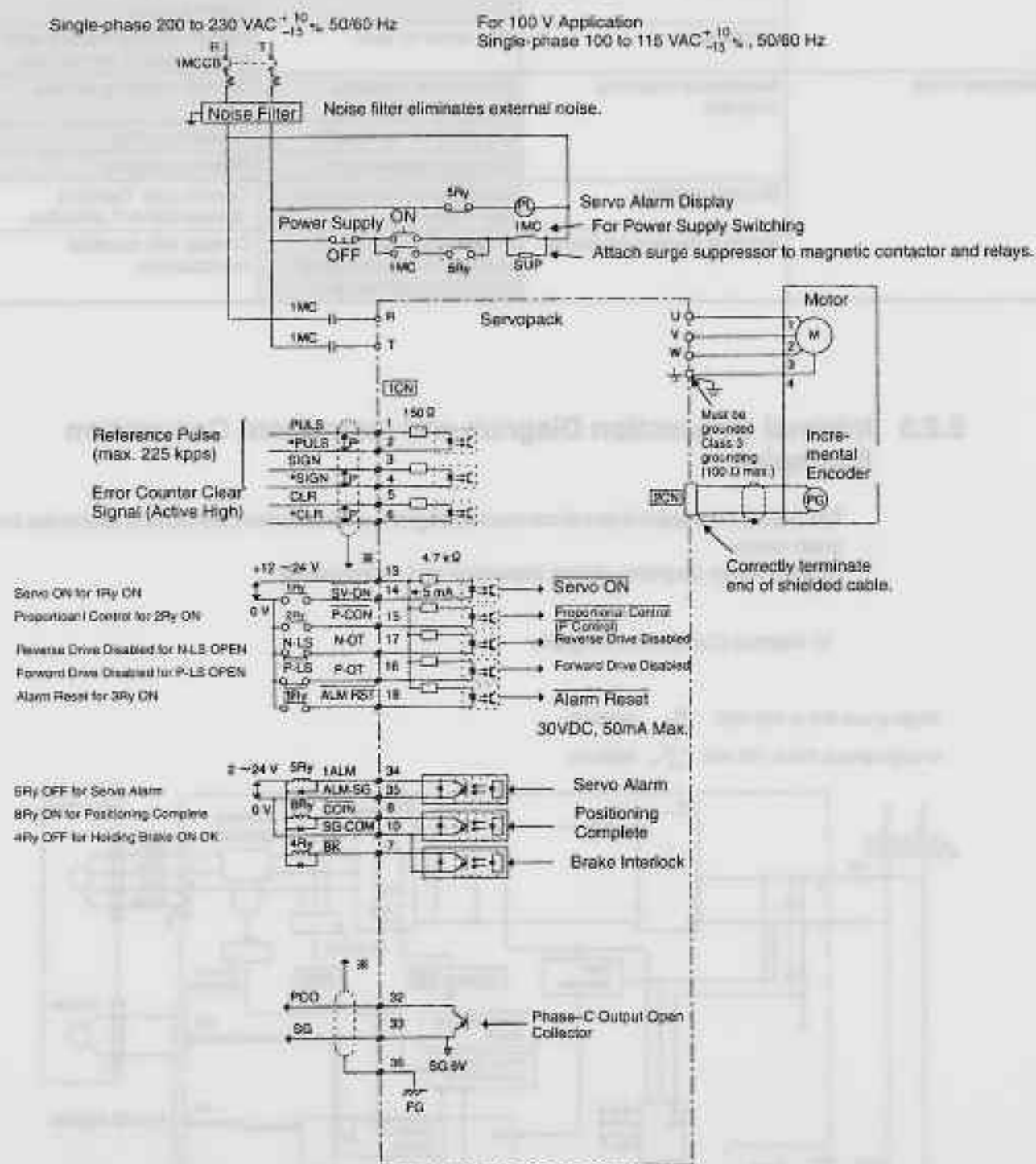

Appendix **A**

Servo Adjustment

A

This appendix presents the basic rules for Σ -Series AC Servopack gain adjustment, describes various adjustment techniques, and gives some preset values as guidelines.

A.1	Σ-Series AC Servopack Gain Adjustment	198
A.1.1	Σ -Series AC Servopacks and Gain Adjustment Methods	198
A.1.2	Basic Rules for Gain Adjustment	199
A.2	Adjusting a Position-control Servopack	200
A.2.1	Adjusting Using Auto-tuning	200
A.2.2	Manual Adjustment	201
A.3	Gain Setting References	204
A.3.1	Guidelines for Gain Settings According to Load Inertia Ratio	204

A.1 Σ -Series AC Servopack Gain Adjustment

This section gives some basic information required to adjust the servo system.

A.1.1	Σ -Series AC Servopacks and Gain Adjustment Methods	198
A.1.2	Basic Rules for Gain Adjustment	199

A.1.1 Σ -Series AC Servopacks and Gain Adjustment Methods

1) The adjustment method of all Σ -Series AC Servopacks is basically identical for each Servopack type.

The Servopacks allow both manual adjustment by the conventional method of observing the machine response and automatic adjustment using the internal auto-tuning function.

2) The main user constants changed by the customer to adjust the servo system include the following:

- Cn-04 (Speed Loop Gain)
- Cn-05 (Speed Loop Integration Time Constant)
- Cn-17 (Torque Reference Filter Time Constant)
- Cn-1A (Position Loop Gain)

A simple block diagram of the servo system is shown below.

Servo System Block Diagram

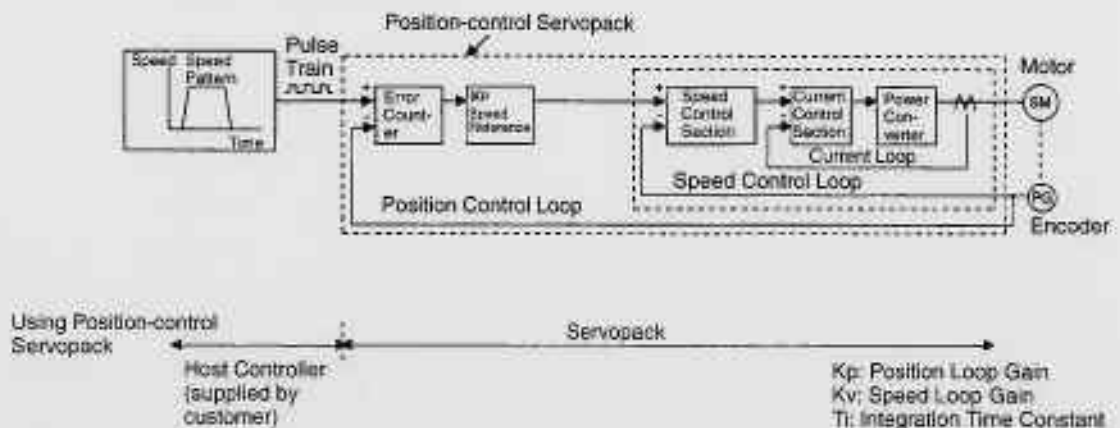

A.1.2 Basic Rules for Gain Adjustment

- 1) The servo system comprises three feedback systems: position loop, speed loop, and current loop. The response must increase from outer loop to inner loop (see Servo System Block Diagram, above). The response deteriorates and oscillates if this principle is not obeyed.
The customer cannot adjust the current loop. Sufficient response is assured for the current loop.
The customer can adjust the position loop gain and speed loop gain, as well as the speed loop integration time constant and torque reference filter.
- 2) The position loop and speed loop must be adjusted to provide a balanced response. In particular, if the position loop gain only is increased, the speed references oscillate and the result is increased, oscillating position control times.
If the position loop gain is increased, the speed loop gain (Cn-04) must be similarly increased.
If the mechanical system starts to oscillate after the position loop gain and speed loop gain are increased, do not increase the gains further.
- 3) The position loop gain should not normally be increased above the characteristic frequency of the mechanical system.
For example, the harmonic gears used in an articulated robot form a structure with extremely poor rigidity and a characteristic frequency of approximately 10 to 20 Hz. This type of machine allows a position loop gain of only 10 to 20 (1/sec).
Conversely, the characteristic frequency of a precision machine tool such as a chip moulder or IC bonder exceeds 70 Hz, allowing a position loop gain exceeding 70 (1/sec) for some machines.
Therefore, although the response of the servo system (controller, servo driver, motor, detectors, etc.) is an important factor where good response is required, it is also important to improve the rigidity of the mechanical system.
- 4) In cases where the position loop response is greater than or equal to the speed loop response and linear acceleration or deceleration is attempted, the poor speed loop response and follow-up cause an accumulation of position loop errors and result in increased output of speed references from the position loop.
The motor moves faster and overshoots as a result of increased speed references, and the position loop tends to decrease the speed references. However, the poor motor follow-up due to the poor speed loop response results in oscillating speed references, as shown in the diagram below.
If this problem occurs, reduce the position loop gain or increase the speed loop gain to eliminate the speed reference oscillations.

Speed Reference Output with Unbalanced Position Loop Gain and Speed Loop Gain

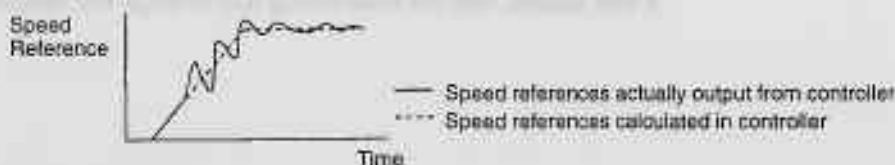

A.2 Adjusting a Position-control Servopack

This section gives examples of adjusting the gains of a position-control Servopack manually and using auto-tuning.

A.2.1	Adjusting Using Auto-tuning	200
A.2.2	Manual Adjustment	201

A.2.1 Adjusting Using Auto-tuning

1) Important Points About Auto-tuning

a) Selecting Machine Rigidity

If the machine rigidity is unknown, select the rigidity according to the following standards.

Drive Method	Machine Rigidity	
	Level	Rigidity
Ball screw, direct	3 (C-003) to 7 (C-007)	High/medium response
Ball screw, with reduction gears	2 (C-002) to 3 (C-003)	Medium response
Timing belt	1 (C-001) to 3 (C-003)	Low/medium response
Chain	1 (C-001) to 2 (C-002)	Low response
Harmonic gears	1 (C-001) to 2 (C-002)	Low response

Select the machine rigidity level for SGDE according to the table.

Level	Rigidity
7 (C-007)	High
6 (C-006)	
5 (C-005)	
4 (C-004)	
3 (C-003)	Medium
2 (C-002)	
1 (C-001)	Low

Auto-tuning may not end if high response is selected for a low-rigidity machine or low response is selected for a high-rigidity machine.

If this occurs, halt the auto-tuning and change the machine rigidity selection.

2) If Auto-tuning is Unsuccessful

Auto-tuning may be unsuccessful (the end of auto-tuning not displayed) for machines with large play or extremely low rigidity.

Similarly, auto-tuning may be unsuccessful for a machine with high load inertia (exceeding 15 to 30 times the motor moment of inertia).

In these cases, use conventional manual adjustment.

Even if auto-tuning is successful for a machine with large fluctuations in load inertia or load torque, vibrations or noise may still occur in some positions.

3) Response During Operation is Unsatisfactory after Auto-tuning

Auto-tuning sets the gain and integration time constant with some safety margin (to avoid oscillations). This can result in positioning times.

In particular, the target position may not be reached if low response is selected, because the machine does not move in response to the final minute references. An excessively high setting of the integration time constant (Cn-05) during auto-tuning is one cause of this problem.

If response is slow after auto-tuning, the speed loop gain cannot be manually increased very much before vibration starts.

In this case, manually reduce the integration time constant while observing the machine behavior to ensure oscillation does not occur.

Auto-tuning does not set the torque reference filter (Cn-17).

A

A.2.2 Manual Adjustment

1) The role of each user constant is briefly described below.

a) Speed Loop Gain (Cn-04)

This user constant sets the speed loop response.

The response is improved by setting this user constant to the maximum value in the range which does not cause vibrations in the mechanical system.

The following formula relates the speed loop gain to the load inertia.

$$\text{Speed Loop Gain } K_v \text{ [Hz]} = \frac{2}{\frac{GD_L^2}{GD_M^2} + 1} \times (\text{Cn-04 Preset value})$$

GD_L^2 : Motor Axis Converted Load Inertia

GD_M^2 : Motor Moment of Inertia

b) Speed Loop Integration Time Constant (Cn-05)

The speed loop has an integration element to allow response to micro-inputs.

This integration element can produce a delay in the servo system, and the positioning setting time increases and response becomes slower as the time constant increases.

However, the integration time constant must be increased to prevent machine vibra-

tion if the load inertia is large or the mechanical system includes a vibration elements. The following formula calculates a guideline value.

$$T_i \geq 2.3 \times \frac{1}{2\pi \times K_v}$$

T_i : Integration Time Constant (sec)

K_v : Speed Loop Gain (Hz) (calculated above)

c) Torque Reference Filter Time Constant (Cn-17)

When a ball screw is used, torsional resonance may occur which increases the pitch of the vibration noise.

These vibrations can sometimes be overcome by increasing the torque reference filter time constant.

However, this filter can produce a delay in the servo system, as is the integration time constant, and its value should not be increased more than necessary.

d) Position Loop Gain (Cn-1A)

The position loop gain user constant sets the servo system response.

The higher the position loop gain is set, the better the response and shorter the positioning times.

To enable a high setting of the position loop gain, increase the machine rigidity and raise the machine characteristic frequency.

Increasing the position loop gain only to improve the response can result in oscillating response of the overall servo system, that is, the speed references output from the position loop oscillate. Therefore, also increase the speed loop gain while observing the response.

The position loop gain is determined from the following relationship.

$$K_p = \frac{VS}{\epsilon}$$

K_p [1/s]: Position loop gain

VS [PPS]: Steady speed reference

ϵ [pulse]: Steady error

(The number of pulses in the error counter at steady speed.)

2) Adjustment Procedure

a) Set the position loop gain to a low value and increase the speed loop gain (Cn-04) within the range that no abnormal noise or oscillation occurs.

b) Slightly reduce the speed loop gain from the value at step 1, and increase the position loop gain in the range that no overshooting or vibration occurs.

c) Determine the speed loop integration time constant (Cn-05), by observing the positioning set time and vibrations in the mechanical system.

The positioning set time may become excessive if the speed loop integration time constant (Cn-05) is too large.

- d) It is not necessary to change the torque reference time constant (Cn-17) unless torsional resonance occurs in the machine shafts. Torsional resonance may be indicated by a high vibration noise. Adjust the torque reference filter time constant to reduce the vibration noise.
- e) Finally, fine adjustment of the position gain, speed gain, and integration time constant is required to determine the optimum point for step response, etc.

The adjustment procedures described above are common for all Yaskawa position-control digital AC Servopacks. However, not all functions are available on each Servopack. Consult the technical specifications of your Servopack for details.

The adjustment procedures are also identical for conventional analog servos. However, in this case, the adjustments are made using potentiometers instead of the user constants.

A

A.3 Gain Setting References

This section presents tables of load inertia values for reference when adjusting the gain.

A.3.1 Guidelines for Gain Settings According to Load Inertia Ratio 204

A.3.1 Guidelines for Gain Settings According to Load Inertia Ratio

- 1) Adjustment guidelines are given below according to the rigidity of the mechanical system and load inertia. Use these values as guidelines when adjusting according to the procedures described above.

These values are given as guidelines only. Oscillations and poor response may occur inside the specified value ranges. Observe the response (waveform) when optimizing the adjustment.

Higher gains are possible for machines with high rigidity.

a) Machines with High Rigidity

Ball Screw, Direct Drive Machines

Example: Chip moulder, IC bonder, precision machine tools

Load/Inertia Ratio (GD_L^2/GD_M^2)	Position Loop Gain (Cn-1A) [1/s]	Speed Loop Gain (Cn-04) [Hz]	Speed Loop Integration Time Constant (Cn-05) [ms]
1 x	50 to 70	50 to 70	5 to 20
3 x		100 to 140	Slightly increase for inertia ratio of 20 x, or greater.
5 x		150 to 200	
10 x		270 to 380	
15 x		400 to 560	
20 x		500 to 730	
30 x		700 to 1100	

For an inertia ratio of 10 x, or greater, slightly reduce the position loop gain and speed loop gain below the values shown and set the integration time constant to a higher value before starting the adjustment.

As the inertia ratio increases, set the position loop gain and speed loop gain to the lower limit of the range of values specified. Conversely, increase the speed loop integration time constant.

b) Machines with Medium Rigidity

Machines driven by ball screw through reduction gears, or machines directly driven by long ball screws.

Example: General machine tools, orthogonal robots, conveyors

Load/Inertia Ratio (GD_L^2/GD_M^2)	Position Loop Gain (Cn-1A) [1/s]	Speed Loop Gain (Cn-04) [Hz]	Speed Loop Integration Time Constant (Cn-05) [ms]
1 x	30 to 50	30 to 50	10 to 40 Slightly increase for inertia ratio of 20 x, or greater.
3 x		60 to 100	
5 x		90 to 150	
10 x		160 to 270	
15 x		240 to 400	
20 x		310 to 520	
30 x		450 to 770	

For an inertia ratio of 10 x, or greater, slightly reduce the position loop gain and speed loop gain below the values shown and set the integration time constant to a higher value before starting the adjustment.

As the inertia ratio increases, set the position loop gain and speed loop gain to the lower limit of the range of values specified. Conversely, increase the speed loop integration time constant.

c) Machines with Low Rigidity

Machines driven by timing belts, chains or harmonic gears.

Example: Conveyors, articulated robots

Load/Inertia Ratio (GD_L^2/GD_M^2)	Position Loop Gain (Cn-1A) [1/s]	Speed Loop Gain (Cn-04) [Hz]	Speed Loop Integration Time Constant (Cn-05) [ms]
1 x	10 to 20	10 to 20	50 to 120 Slightly increase for inertia ratio of 20 x, or greater.
3 x		20 to 40	
5 x		30 to 60	
10 x		50 to 110	
15 x		80 to 160	
20 x		100 to 210	
30 x		150 to 310	

For an inertia ratio of 10 x, or greater, slightly reduce the position loop gain and speed loop gain below the values shown and set the integration time constant to a higher value before starting the adjustment.

As the inertia ratio increases, set the position loop gain and speed loop gain to the lower limit of the range of values specified. Conversely, increase the speed loop integration time constant.

Appendix B

List of I/O Signals

B

This appendix lists I/O signal terminals (connector 1CN) on Servopacks which connect to a host controller or external circuit.

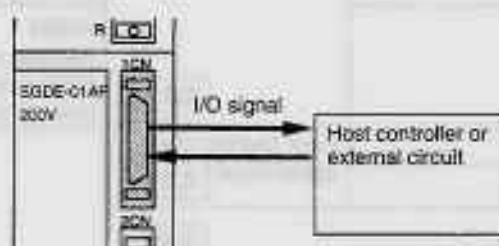

Note 1) Refer to *Chapter 2* for details of how to use I/O signals.

2) Note that the functions of I/O signal terminals differ according to the memory switch (Cn-01, Cn-02) settings.

List of I/O Signals

Specifications	Standard Specifications		CCW Pulse + CW Pulse Reference	90° Different Two-phase Pulse Reference	
Memory Switch Setting	Standard Setting		Cn-02 Bits 5, 4, 3 = 0, 0, 1	Cn-02 Bits 5, 4, 3 = 0, 1, 0 (x 1 multiplication) = 0, 1, 1 (x 2 multiplication) = 1, 0, 0 (x 4 multiplication)	
1CN Terminal No.	1	PULS	Reference pulse input	PULS Forward rotation (CCW) reference pulse input 2.2.1	PULS Phase A reference pulse input 2.2.1
	2	•PULS	2.2.1	•PULS Forward rotation (CCW) reference pulse input 2.2.1	•PULS Phase A reference pulse input 2.2.1
	3	SIGN	Reference sign input	SIGN Reverse rotation (CW) reference pulse input 2.2.1	SIGN Phase B reference pulse input 2.2.1
	4	•SIGN	2.2.1	•SIGN Reverse rotation (CW) reference pulse input 2.2.1	•SIGN Phase B reference pulse input 2.2.1
	5	CLR	Error counter clear signal input 2.2.1		
	6	•CLR			
	7	BK Brake interlock output	2.4.2		
	8	COIN Positioning complete signal	2.5.3		
	9	(Do not use.)			
	10	SG-COM Signal ground common	2.2.2		
	11	— (Do not use.)			
	12	— (Do not use.)			
	13	P-IN External power input (+12 to 24V)	2.2.2		
	14	S-ON Serve ON	2.5.2		
	15	P-CON Proportional control			
	16	P-OT Forward rotation prohibited	2.1.2		

Note Information described in the "Standard Specifications" column is also applicable to blank columns.

Number "x.x.x" in box represents a section number corresponding to each signal name. For example, [2.2.1](#) represents Section 2.2.1.

Specifications	Standard Specifications	CCW Pulse + CW Pulse Reference	90° Different Two-phase Pulse Reference
Memory Switch Setting	Standard Setting	Cn-02 Bits 5, 4, 3 = 0, 0, 1	Cn-02 Bits 5, 4, 3 = 0, 1, 0 (x 1 multiplication) = 0, 1, 1 (x 2 multiplication) = 1, 0, 0 (x 4 multiplication)
17	N-OT Reverse rotation prohibited 2.1.2		
18	ALMRST Alarm reset 2.5.1		
19	SG-PG Signal ground for PG signal output		
20	— (Do not use.)		
21	— (Do not use.)		
22	— (Do not use.)		
23	— (Do not use.)		
24	— (Do not use.)		
25	— (Do not use.)		
26	— (Do not use.)		
27	— (Do not use.)		
28	— (Do not use.)		
29	— (Do not use.)		
30	— (Do not use.)		
31	— (Do not use.)		
32	PCO Phase-C open collector output 2.2.2		
33	SG-AL Signal ground for phase-C open collector output		
34	ALM Alarm output 2.5.1		
35	ALM-SG Signal ground for alarm code output		
36	FG Frame ground		

Note Information described in the "Standard Specifications" column is also applicable to blank columns.

Number "x.x.x" in box represents a section number corresponding to each signal name. For example, 2.2.1 represents Section 2.2.1.

Appendix C

List of User Constants

- Σ -Series Servopacks provide many functions, and have parameters called “user constants” to allow the user to select each function and perform fine adjustment. This appendix lists these user constants.
- User constants are divided into the following two types:

1) Memory switch Cn-01, Cn-02	Each bit of this switch is turned ON or OFF to select a function.
2) User constant setting Cn-04 and later	A numerical value such as speed loop gain is set in this constant.

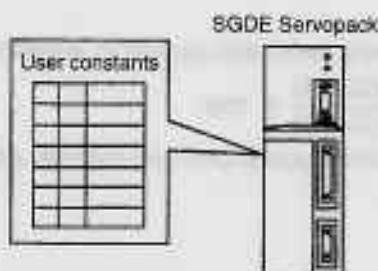

- Note**
- 1) Refer to *Chapter 2* for details of how to use user constants.
 - 2) For details of how to set user constants, refer to *Section 3.1.5 Operation in User Constant Setting Mode*.

List of User Constants (User Constant Setting)

User Constant No.	Code	Name	Unit	Lower Limit	Upper Limit	Factory Setting	Remarks
Cn-01	Memory switch (see the Table below.)						
Cn-02	Memory switch (see page 213.)						
Cn-04	LOOPHZ	Speed loop gain	Hz	1	2000	80	
Cn-05	PITIME	Speed loop integration time constant	ms	2	10000	20	
Cn-12	BRKTIM	Time delay from brake reference until servo OFF	10 ms	0	50	0	
Cn-17	TRQFIL	Torque reference filter time constant	100 μ s	0	250	4	
Cn-1A	POSGN	Position loop gain	1/s	1	200	40	
Cn-1B	COINLV	Positioning complete range	Reference unit	0	250	7	
Cn-24	RATB	Electronic gear ratio (numerator)		1	65535	4	See note
Cn-25	RATA	Electronic gear ratio (denominator)		1	65535	1	See note
Cn-26	ACCTME	Position reference accel/decel time constant	100 μ s	0	640	0	

Note The following restriction applies to electronic gear ratio (Cn-24 and Cn-25):

$$0.01 \leq \frac{B(\text{Cn-24})}{A(\text{Cn-25})} \leq 100$$

Always turn the power OFF and then ON after changing the setting. This makes the new setting valid.

List of User Constants (Memory Switch Setting)

User Constant No.	Bit No.	Setting	Factory Setting
Cn-01	0	0	0
		Uses servo ON input (S-ON).	Always servo ON
	2	0	0
		Uses forward rotation prohibited input (P-OT).	Does not use forward rotation prohibited input (P-OT).
	3	0	0
		Uses reverse rotation prohibited input (N-OT).	Does not use reverse rotation prohibited input (N-OT).
6	Stops the motor by applying dynamic brake when overtravel is detected.	Stops the motor by applying the maximum torque when overtravel is detected.	0
A	Error counter clear selection at base block (Error counter is cleared.)	Error counter clear selection at base block (Error counter is not cleared.)	0

User Constant No.	Bit No.	Setting					Factory Setting
Cn-02	0	0			1		0
		Defines counterclockwise (CCW) rotation as forward rotation.			Defines clockwise (CW) rotation as forward rotation (reverse rotation mode).		
	5•4•3	0•0•0	0•0•1	0•1•0	0•1•1	1•0•0	0•0•0
	Sign + Pulse	CW + CCW	Phase A + Phase B (x 1 multiplication)	Phase A + Phase B (x 2 multiplication)	Phase A + Phase B (x 4 multiplication)		
	A	Clears the error counter when an error counter signal is at high level.			Clear the error counter when the leading edge of an error counter clear signal rises.		0
	C*	Torque reference filter time constant (Primary)			Torque reference filter time constant (Secondary)		0
E	Displays position error Un-08 in x 1 reference units while in monitor mode.			Displays position error Un-08 in x 100 reference units while in monitor mode.		0	

* Can be changed at software versions 4 and after.

Note For the Cn-01 and Cn-02 memory switches, always turn the power OFF and then ON after changing the setting. This makes the new setting valid.

C

Numbers

- 1CN connector
 - dimensional drawings, 165
 - specifications, 165
- 1CN connector kit, 13

A

- AC servomotor sizing software, 65
- alarm output signals, wiring, 51
- alarm signal circuit, test run, 18
- alarm traceback data, clearing, 97
- alarm traceback mode, 86
- alarms
 - display, troubleshooting, 182
 - Servo, resetting using Digital Operator, 75
 - servo, reset, 75
- alignment, 6
 - radial load, 6
 - thrust load, 6
- autotuning, 92
 - precautions, 95
- autotuning function, 43
 - Digital Operators, 91

B

- bits, turning ON and OFF, 81
- brake power supply, 12
 - dimensional drawings, 158
 - internal circuit, 160
 - specifications, 158

C

- cables, 56
 - encoders
 - dimensional drawings, 161
 - specifications, 161
 - for connecting PC and Servopack, 175
 - motor
 - connectors, 156
 - dimensional drawings, 152
 - specifications, 152

- specifications, 149
- tension, 56

- connections
 - contact input signal terminals, 37
 - contact output signal terminals, 38
- connector kits, 155
 - dimension drawings, 155
 - specifications, 155
- connector terminal block conversion unit, 13
- connectors
 - 1CN, test run, 18
 - encoder cables, 155
 - incremental encoder, 70
 - motor cables, 156
 - standard-type motor without brake, 70
 - standard-type motor with brake, 71
 - terminal layouts, 69
 - Servopack position control, 69
- contact input signal terminals, connections, 37
- contact output signal terminals, connections, 38

D

- Digital Operators, 13
 - alarm traceback mode, 86
 - autotuning, 91
 - connection, 74
 - dimensional drawings, 142
 - mode selection, 76
 - monitor mode, 83
 - status display mode, 77
 - user constant setting mode, 78
 - motor operation, 88
 - selection, 112
 - flowchart, 112
 - servo alarm reset, 75
 - simple motor check, 88
 - test run, 19
- dimensional diagrams, noise filter, 170
- dimensional drawings, 130
 - 1CN connector, 165
 - brake power supply, 158
 - cables, encoders, 161
 - connector kits, 155
 - Digital Operators, 142
 - magnetic contactor, 171
 - motor cables, 152
 - regenerative unit, 173
 - Servomotors, 130-164

Servopacks, 140
dynamic brake, 47

E

electronic gear function, 39
setting, 39
electronic gear ratio, 39
for different load mechanisms, 42
load travel distance per revolution of load shaft in
reference units, 40
machine specifications, 39
reference unit, 40
encoders, cables
connectors, 155
dimensional drawings, 161
specifications, 161
error counter, clearing, 36

F

fuse, 58

G

gain, adjustment, 43
Ground terminal, 14
ground wire, 56
ground-fault interrupter, 3
grounding, 3
wiring, 59

H

high-voltage lines, Servopacks, 67
holding brake, 48
electrical specifications
100-VAC SGMP Servomotors, 119
200-VAC SGM Servomotors, 119
hot start, 125

I

impact resistance, 121

input pulse multiply function, 35

input signal terminals
alarm reset, 52
error counter clear input, 36
forward rotation prohibited, 31
I/O power supply, 37
reference pulse input, 34
reference sign input, 34
reverse rotation prohibited, 31
servo ON, 52

inspection, 180, 181
Servomotors, 180
Servopacks, 181

installation, 4
servomotor, alignment, 6
Servomotors, 5
Servopacks, 8

L

limit switch, 31
overtravel limit function, 31
load inertia, 126
loads
allowable radial load, 120
allowable thrust load, 120

M

machine data table, 108
machine rigidity, 91
selection, 95
magnetic contactor, 12
dimensional drawings, 171
internal connection diagram, 171
specifications, 171
maintenance, 180, 181
Servomotors, 180
Servopacks, 181
MCCB, 12, 57, 58, 169
mechanical tolerance, 120
memory switches
See ⇒ user constants
mode selection, Digital Operators, 76
molded-case circuit breaker
See ⇒ MCCB

monitor mode, 83
motor
 checking, Digital Operators, 88
 operation, Digital Operators, 88
 type check, 98

N

N-OT input signal, 32
noise control, 3
 filter, 12, 57
 dimensional diagrams, 170
 installation, 60
 specifications, 170
 wiring, 58

O

output signal terminals
 brake interlock output, 49
 output signal ground common, 38, 49
 positioning complete output, 53
 servo alarm output, 51
 signal ground for servo alarm output, 51
overhanging load
 precautions, 3
 Servomotors, 128
overload, characteristics, Servopacks, 125
overtravel limit function, 31
 limit switch, 31

P

P-OT input signal, 32
peripheral devices
 selection, 144
 flowchart, 145
 specifications, 149
 wiring, 11
personal computer, 13
position references, inputs, 33
 line driver output, 33
 open collector output, 34
positioning complete signal, 53
Power Consumption, 129

Power Failure, 54
Power Loss, 10
precautions, 2
protective sequence, 51

R

radial load, 6
ratings
 100-VAC SGM Servomotors, 116
 200-VAC SGM Servomotors, 113
 SGDA Servopacks, 122
 SGDE Servopacks, 123
reference pulse
 form, 34
 input
 allowable voltage level, 36
 timing, 36
regenerative unit, 12, 64
 connection, 66
 dimensional drawings, 173
 specifications, 173
residual voltage, precautions, 2
reverse rotation mode, 30
 user constant, 30

S

servo ON input signal, 52
Servomotors, 180
 100-VAC SGM ratings, 116
 100-VAC SGM specifications, 116
 100-VAC SGM torque-motor speed characteristics, 118
 200-VAC SGM ratings, 113
 200-VAC SGM specifications, 113
 200-VAC SGM torque-motor speed characteristics, 115
 dimensional drawings, 130-164
 inspection, 180
 installation, 5
 maintenance, 180
 overhanging load, 128
 selection, 103
 flowchart, 105
 machine data table, 108
 test run, 18

Servopacks, 181
 dimensional drawings, 140
 high-voltage lines, 67
 inspection, 181
 installation, 8
 instrument connection examples, 195
 internal connection diagram, 195
 maintenance, 181
 overload characteristics, 125
 ratings, 122, 123
 selection, 110
 flowchart, 111
 specifications, 122, 123

servos
 alarm output, 51
 alarm reset, 75
 gain adjustment, 43

smoothing function, 45
 position reference acceleration/deceleration time constant, 45

software, version check, 99

specifications
 100-VAC SGM Servomotors, 116
 1CN connector, 165
 200-VAC SGM Servomotors, 113
 brake power supply, 158
 cables, 149
 encoders, 161
 connector kits, 155
 magnetic contactor, 171
 noise filter, 170
 peripheral devices, 149
 regenerative unit, 173
 SGDA Servopacks, 122
 SGDE Servopacks, 123

starting time, 126

status display mode, 77

stop mode, setting, 47

stopping time, 126

supply voltages, precautions, 2

surge suppressor, 172

T

terminals
 standard-type motor without brake, 70
 standard-type motor with brake, 71

test run, 16
 minimum user constants, 25
 motor alone, 18
 motor connected to the machine, 22
 servomotor with brake, 24

thrust load, 6

torque reference filter time constant, 46

troubleshooting
 alarm display, 182
 without alarm display, 194

U

user constant setting mode, 78

user constants, 30, 32
 brake signal output timing during motor operation, 50
 brake signal speed level output during motor operation, 50
 electronic gear ratio, 41
 error counter clear signal selection, 36
 N-OT input signal, 32
 overflow, 44
 position loop gain, 44
 positioning complete range, 54
 P-OT input signal, 32
 reference pulse form selection, 34
 reverse rotation mode, 30
 rotation direction selection, 30
 servo ON input signal, 53
 speed loop gain, 44
 speed loop integration time constant, 44
 stopping motor at servo OFF, 47
 time delay from brake signal output to servo OFF, 49
 torque reference filter time constant, 46

V

vibration class, 121
vibration resistance, 121
voltage resistance test, 3

W

wiring, 11, 14, 56
 grounding, 59
 main circuit, 14

more than one servo drive, 63

noise control, 58

peripheral devices, 11

precautions, 2, 56

U

U-robot, 11

U-robot, 11

U-robot, 11

U-robot, 11

U-robot, 11

U-robot, 11

U-robot, 11

U-robot, 11

U-robot, 11

U-robot, 11

U-robot, 11

U-robot, 11

U-robot, 11

U-robot, 11

U-robot, 11

U-robot, 11

U-robot, 11

U-robot, 11

U-robot, 11

U-robot, 11

U-robot, 11

U-robot, 11

V

V-robot, 11

V-robot, 11

V-robot, 11

W

W-robot, 11

W-robot, 11

W-robot, 11

X

X-robot, 11

X-robot, 11

X-robot, 11

Σ Series SGME / SGDE (for position control) USER'S MANUAL

TOKYO OFFICE

New Pier Takashiba South Tower, 1-16-1, Kaigan, Minatoku, Tokyo 105-6691 Japan
Phone 81-3-5402-4511 Fax 81-3-5402-4580

YASKAWA ELECTRIC AMERICA, INC.

2121 Norman Drive South, Waukegan, IL 60085, U.S.A.
Phone 1-847-867-7000 Fax 1-847-867-7370

MOTOMAN INC. HEADQUARTERS

805 Liberty Lane West Carrollton, OH 45449, U.S.A.
Phone 1-937-847-6200 Fax 1-937-847-6277

YASKAWA ELÉTRICO DO BRASIL COMÉRCIO LTDA.

Av. Amida Fagundes Filho, 825, Bairro Sauda-Sao Paulo-SP, Brazil CEP: 04304-000
Phone 55-11-5071-2552 Fax 55-11-5581-4795

YASKAWA ELECTRIC EUROPE GmbH

Am Kienberger Hang 2, 65824 Schwabach, Germany
Phone 49-6196-569-300 Fax 49-6196-699-301

Motoman Robotics Europe AB

Box 504 58626 Torsås, Sweden
Phone 46-486-48800 Fax 46-486-41410

Motoman Robotec GmbH

Kahnfelderstraße 1, 85371 Alzenhausen, Germany
Phone 49-8106-900 Fax 49-8165-9039

YASKAWA ELECTRIC UK LTD.

1 Hunt Hill Orchardton Woods, Cumbernauld, G68 9LF, United Kingdom
Phone 44-1236-735000 Fax 44-1236-458182

YASKAWA ELECTRIC KOREA CORPORATION

Kyja Bldg #1201, 35-4 Yeouido-dong, Yeongdeungpo-Ku, Seoul 150-010, Korea
Phone 82-2-784-7844 Fax 82-2-784-5425

YASKAWA ELECTRIC (SINGAPORE) PTE. LTD.

151 Lorong Chuan, #04-01, New Tech Park Singapore 556741, Singapore
Phone 65-292-3003 Fax 65-289-3003

YASKAWA ELECTRIC (SHANGHAI) CO., LTD.

4F No.18 Aena Road, Waigaoqiao Free Trade Zone, Pudong New Area, Shanghai 200121, China
Phone 86-21-5865-3470 Fax 86-21-5866-8801

YATEC ENGINEERING CORPORATION

Shen Hsiang Tang Sung Chang Building 10F, 146 Sung Chang Road, Taipei, Taiwan
Phone 886-2-2563-0010 Fax 886-2-2567-4677

YASKAWA ELECTRIC (HK) COMPANY LIMITED

Rm. 2309-10, Hong Kong Plaza, 186-101 Connaught Road West, Hong Kong
Phone 852-2503-2385 Fax 852-2547-5773

BEIJING OFFICE

Room No. 201 Office Building of Beijing International Club, 21
Jiangmenwai Avenue, Beijing 100020, China
Phone 86-10-6532-1650 Fax 86-10-6532-1251

TAIPEI OFFICE

Shen Hsiang Tang Sung Chang Building 10F, 146 Sung Chang Road, Taipei, Taiwan
Phone 886-2-2563-0010 Fax 886-2-2567-4677

SHANGHAI YASKAWA-TONGJI M & E CO., LTD.

27 Yu He Road Shanghai China 200437
Phone 86-21-6531-4242 Fax 86-21-6553-8060

BEIJING YASKAWA BEIKE AUTOMATION ENGINEERING CO., LTD.

30 Xue Yuan Road, Haidian, Beijing P.R. China Post Code 100083
Phone 86-10-6233-2782 Fax 86-10-6232-1536

SHOUGANG MOTOMAN ROBOT CO., LTD.

7, Yongchang North Sewer, Beijing Economic Technological Investment & Development Area,
Beijing 100076, P.R. China
Phone 86-10-6788-0551 Fax 86-10-6788-2578



YASKAWA ELECTRIC CORPORATION