

YASKAWA

DIRECT DRIVE VS. ROTARY GEAR MOTOR

A QUANTIFICATION OF DESIGN ADVANTAGES

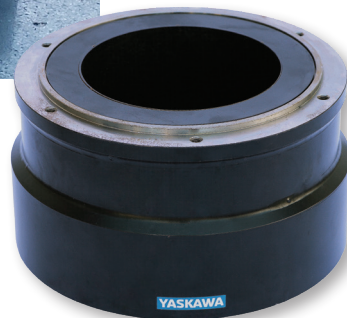
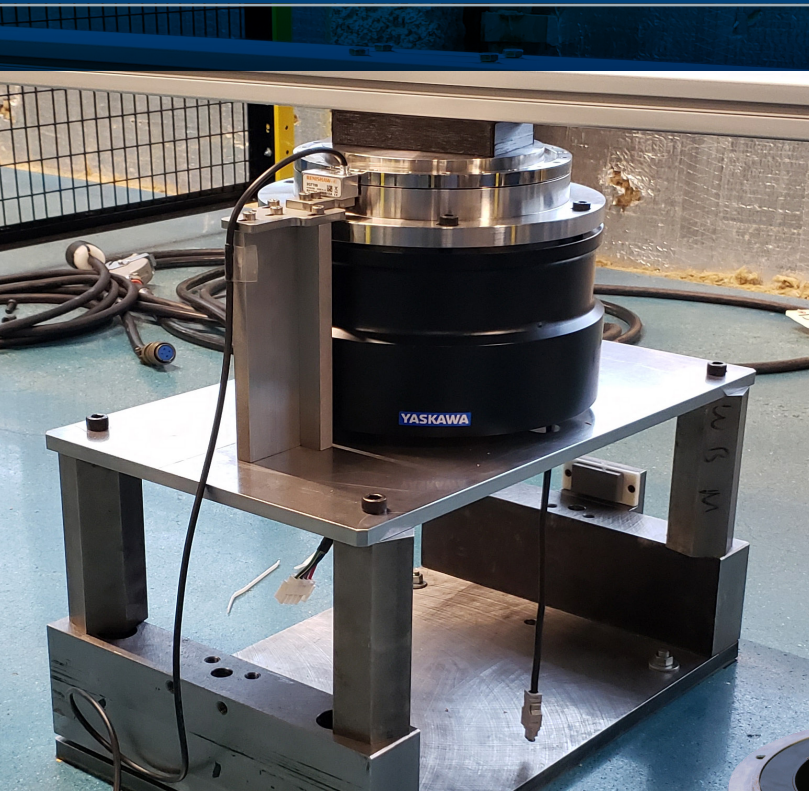

This document examines direct drive motor technology, compares it in terms of cost and performance with that of a rotary gear motor in an application simulation, then identifies the best applications for direct drive motors.

Is a geared servo motor the pinnacle of rotary motion technology, or is there a better solution?

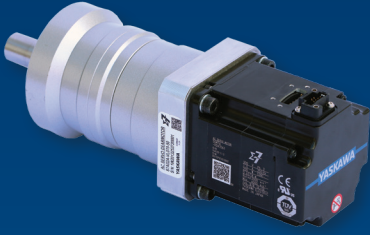

BACKLASH:

Loss of motion between the motor and the load caused by the mechanical tolerances of the transmission elements

INTRODUCTION

For decades, geared servo motors have been one of the most common tools in the industrial automation toolbox. Offering excellent performance for positioning, velocity matching, electronic camming, winding, tensioning, and tightening applications, geared servo motors efficiently match the power of a servo motor to the load.

This raises the question: Is a geared servo motor the pinnacle of rotary motion technology, or is there a better solution?

In a perfect world, a rotary servo system would have torque and speed ratings that match the application, such that the motor is neither oversized nor undersized. Additionally, the combination of motor, transmission elements, and load should have infinite torsional stiffness and zero backlash. Unfortunately, real world rotary servo systems fall short of this ideal to varying degrees.

BACKLASH

In a typical servo system, **backlash** is defined as the loss of motion between the motor and the load caused by the mechanical tolerances of the transmission elements. This includes any motion loss throughout gearboxes, belts, chains, and couplings.

When a machine is initially powered on, the load will float somewhere in the middle of the mechanical tolerances (Figure 1A).

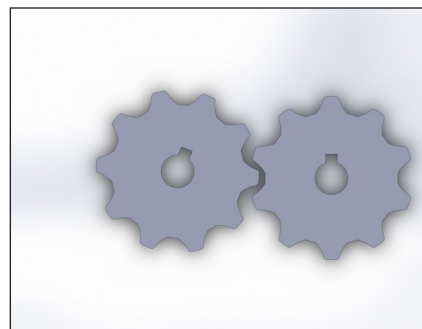

Figure 1A

Before the load itself may be moved by the motor, the motor must rotate to take up all slack existing in the transmission elements (Figure 1B).

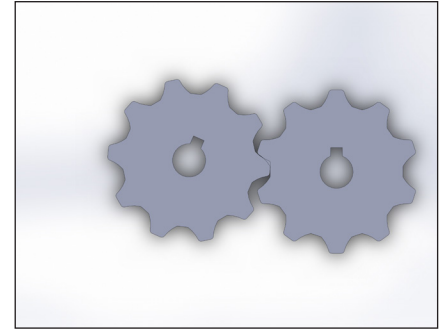

Figure 1B

When the motor begins to decelerate at the end of a move, the load position may actually overtake the motor position as momentum carries the load beyond the motor position. The motor must again take up the slack in the opposite direction before applying torque to the load to decelerate it (Figure 1C).

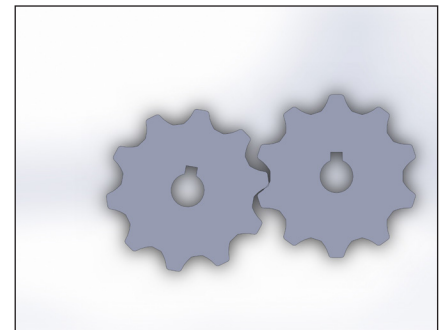

Figure 1C

This loss of motion is called backlash, and is typically measured in arc-minutes, equal to 1/60th of a degree.

Gearboxes designed for use with servos in industrial applications typically have backlash specifications ranging from 3 to 9 arc-minutes.

TORSIONAL STIFFNESS:

Resistance to twisting of the motor shaft, transmission elements, and the load in response to the application of torque

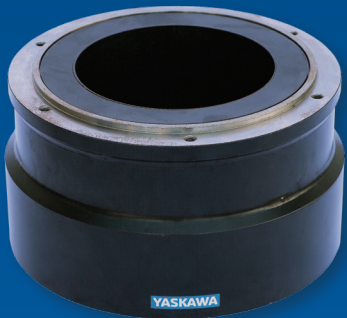

Direct drive servo motors eliminate transmission elements by directly coupling the load to the motor.

TORSIONAL STIFFNESS

Torsional stiffness is the resistance to twisting of the motor shaft, transmission elements, and the load in response to the application of torque.

An infinitely stiff system would transmit torque to the load with no angular deflection about the axis of rotation. However, even a solid steel shaft will twist slightly under heavy load.

The magnitude of deflection varies with the torque applied, the material of the transmission elements, and their shape. Intuitively, long, thin parts will twist more than short, fat ones. This resistance to twisting is what makes coil springs work, as compressing the spring twists each turn of the wire slightly. Fatter wire makes a stiffer spring. Anything less than infinite torsional stiffness causes the system to act as a spring, meaning that potential energy will be stored in the system as the load resists rotation.

COMBINED EFFECTS

When combined together, finite torsional stiffness and backlash can significantly degrade the performance of a servo system.

Backlash can introduce uncertainty, as the motor encoder indicates the position of the motor's shaft, not where the backlash has allowed the load to settle. Backlash also introduces tuning issues as the load couples and uncouples from the motor briefly when the load and motor reverse relative direction.

In addition to backlash, finite torsional stiffness stores energy by converting some of the kinetic energy of the motor and load into potential energy, releasing it later.

This delayed release of energy causes load oscillation, induces resonance, reduces maximum usable tuning gains, and negatively

impacts the responsiveness and settling time of the servo system.

In all cases, reducing backlash and increasing the stiffness of a system will increase servo performance as well as simplify tuning.

DIRECT DRIVE MOTOR CONFIGURATION

The most common rotary axis configuration is a rotary servo motor with a built-in encoder for position feedback and a gearbox to match the available torque and speed of the motor to the required torque and speed of the load. The gearbox is a constant power device that is the mechanical analog of a transformer for load matching.

An improved hardware configuration uses a direct drive rotary servo motor, which eliminates the transmission elements by directly coupling the load to the motor.

Whereas the gear motor configuration uses a coupling to a relatively small diameter shaft, the direct drive system bolts the load directly to a much larger rotor flange.

This configuration eliminates backlash and greatly increases torsional stiffness. The higher pole count and high torque windings of direct drive motors match the torque and speed characteristics of a gear motor with a ratio of 10:1 or higher.

A THIRD OPTION

The least common and most complicated configuration is the fully closed loop system, whereby a regular rotary servo motor and gearbox or other transmission elements is combined with a second encoder that is used to measure the position of the load, masking, but not eliminating the effects of backlash. This adds significant cost and complexity of a second encoder, additional machining and mounting hardware, additional cabling, and added maintenance.

Attempting to quantify the performance advantage through manufacturer documentation can be impossible, as the motors seem remarkably similar in terms of specification.

We designed our test to evaluate:

- Positioning accuracy
- Backlash
- Settling time
- Cycle time
- Machine cost and payback time
- Design complexity

DETERMINING THE BEST SOLUTION

Of these three system designs, the direct drive rotary servo motor offers the best performance and lowest system complexity, but at a higher cost than the gear motor solution.

Attempting to quantify the performance advantage through manufacturer manuals and catalogs is impossible though, as the motors seem remarkably similar in terms of specification.

DESIGNING OUR TEST

So in an effort to show a clear performance advantage for one solution over another, we mounted each to a common load that simulates a high inertia rotary indexing table.

Using a 30-bit ring encoder on the load, the motion of the load is recorded, and compared to that of each motor. Performance metrics are evaluated and weighed against the cost and complexity of each system.

The following evaluation criteria are considered:

- Positioning accuracy
- Backlash
- Settling time
- Cycle time
- Machine cost and payback time
- Design complexity

For this test, a servo system was created representative of an indexing table application where the table has high rotational inertia. The load inertia, RMS torque, and speed requirements were chosen such that a gear motor and direct drive servo motor would both operate near their rated limits.

In order to directly measure the positioning accuracy and cycle time of this simulated “machine,” an external encoder was affixed to the load to precisely measure the position of the load itself. This external encoder was not used in closing the position loop, but only as an independent measuring tool for the test.

Performance differences were quantified using the data gathered from both the motor encoders and load side ring encoder feedback.

Before designing the test hardware, a Yaskawa S7A02A-VL070-50 gear motor and a Yaskawa SGM7D-2817C52 direct drive motor were chosen for comparison.

These motors were selected as the 50:1 gear reduction gives the Sigma-7 gear motor comparable torque, speed, and overall size to the direct drive motor, as seen in Table 1 below.

Based on these characteristics, it is no stretch of the imagination that both of these motors could be competing against one another to control an axis on a new machine.

Specifications	Gear Motor	Direct Drive Motor
Model	S7A02A-VL070-50	SGM7D-2817C52
Backlash [arcmin]	<5	0
Torque (Cont. / Peak) [Nm]	28.7 / 50.0	28.0 / 50.0
Speed (Cont. / Peak) (rpm)	60 / 120	90 / 108
Length (mm)	170.5	158
Footprint (mm)	70	264
Axial Load (N)	1100	40000
Hollow Bore (mm)	N/A	150

Table 1: motors selected for test

A 50:1 gear ratio was selected for the Sigma-7 gear motor, as it provides the best overall match in comparable torque, speed, and overall size with the direct drive motor

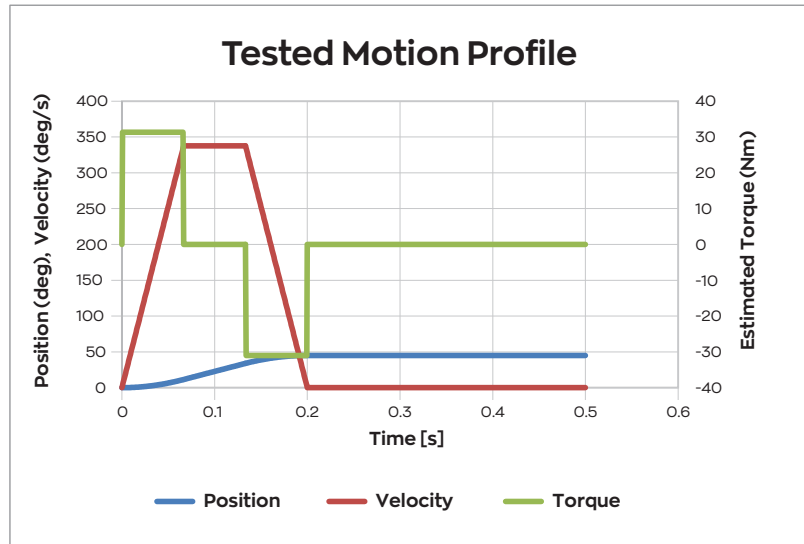

Figure 2: Tested motion profile

TEST SETUP

After selecting the motors and motion profile, Yaskawa's servo motor sizing software, SigmaSelect, was used to find a load inertia to push both motors nearly to their rated limits, ensuring that neither motor was over or undersized for the application.

The motion profile selected was a trapezoidal indexing move of 45 degrees in 200 ms followed by 300 ms of dwell, a motion profile similar to what one might see on a large indexing table in an assembly,

inspection, or packaging application. This motion profile can be seen graphed above in Figure 2.

Using the target load inertia value as a design-to criterion in Solidworks, a dummy load was designed that would both push the motors to their RMS torque limit and allow for the external ring encoder to be attached to the load.

Figure 3 below shows the test setup with the gear motor and Figure 4 shows the test setup with the direct drive motor.

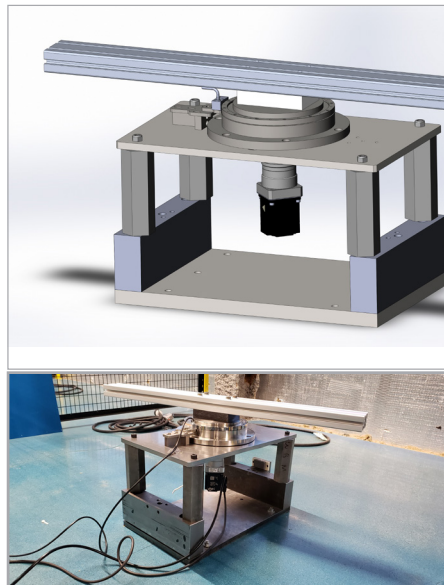

Figure 3: Gear motor setup

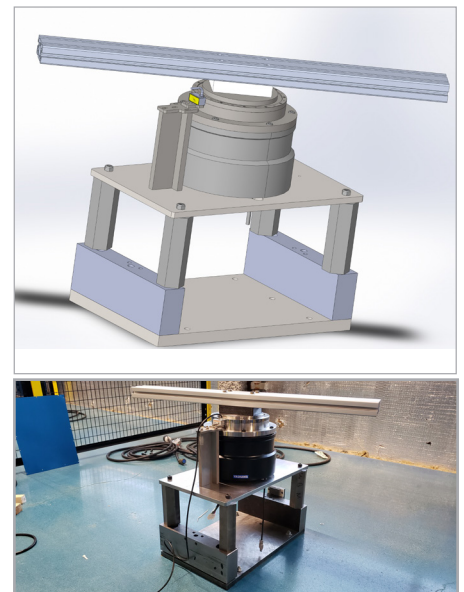

Figure 4: Direct drive motor setup

The direct drive motor showed significant improvement over the gear motor in both average settling time and total move time

Tolerance Window (degrees)	Direct Drive Settling Time (ms)	Gear Motor Settling Time (ms)	Improvement with Direct Drive
0.050	25.4	130.8	415%
0.010	34.6	307.6	789%
0.001	51.3	407.2	694%

Table 2: Average settling time comparison

SETTLING TIME

For this test, the average settling time is defined to be the time elapsed between when the commanded motion signal ended and when the load had settled to within a tolerance window of the goal position.

As seen in Table 2 above, the load driven by the direct drive motor settled much faster on average than when driven by the gear motor.

shorter moving time than the gear motor, despite having the same commanded motion profile.

For machine operations with short cycle times, the settling time advantage becomes more significant. In this test, even a conservative cycle time of 500 ms with a move time of 200 ms provides an impressive point for comparison.

MOVE TIME

The second metric, total move time, is defined here as the time elapsed between the start of commanded motion to when the load had settled within a tolerance window of the goal position.

The total move time is the sum of the commanded move time and the settling time, shown above.

Table 3 below shows the direct drive motor had a significantly

OSCILLATION

Figures 5 and 6 on the next page depict the oscillation of the load that occurred at the end of the motion for both the gear motor and direct drive motor.

The gear motor showed damped oscillation at the end of the move, typical of this mechanical configuration, whereas the direct drive motor had virtually no vibration whatsoever. This difference in vibration amplitude and duration was seen uniformly across all tests

Tolerance Window (degrees)	Direct Drive Move Time (ms)	Gear Motor Move Time (ms)	Improvement with Direct Drive
0.050	225.4	330.8	47%
0.010	234.6	507.6	116%
0.001	251.3	607.2	142%

Table 3: Total move time comparison

Examining the oscillation at the load reveals the effects of backlash and finite torsional stiffness of the gear motor system.

The direct drive motor settles faster, but how can milliseconds of settling time equate to cost savings?

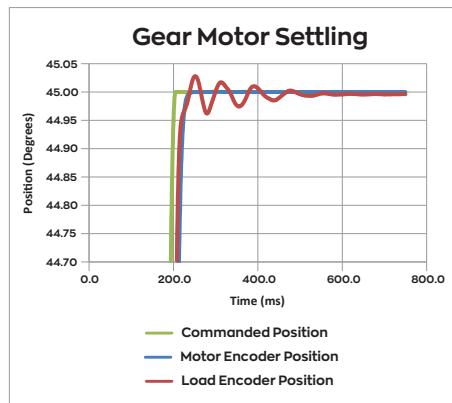

Figure 5: Gear motor oscillation at load

The visible oscillation and additional settling time required by the gear motor is attributed to a combination of backlash and finite torsional stiffness seen in the gearbox. In fact, the backlash is visible in Figure 5, as seen by the load position leading the encoder position during most of the deceleration before springing back and oscillating.

Effectively, the gearing is interlocking at the forward mechanical tolerance point during acceleration and then shifting to the reverse mechanical tolerance point during deceleration.

This deceleration coupled with the torsional stiffness effectively acts like a spring, causing the load to bounce back and forth until friction and internal losses dampen the motion.

The servo motor is attempting to compensate, but due to backlash much of the oscillation is uncoupled from the servo motor and does not manifest as a position error on the servo motor encoder.

It's also worth noting that the motor encoder shows that the load has settled much sooner than it actually has. If the process requires the load to settle to a tighter tolerance than is achieved when the servo motor indicates it has reached the

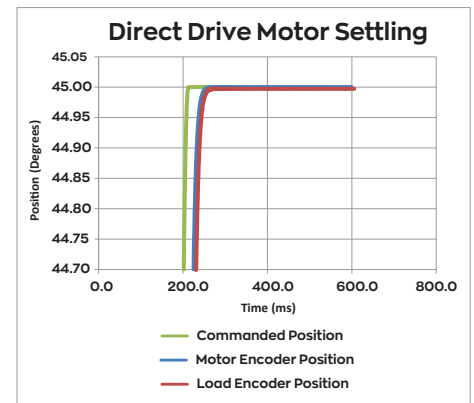

Figure 6: Direct drive motor oscillation at load

target position, delay timers may be required in the motion program. These timers add wasted time to the motion profile as the delay period must be conservative enough to remain effective across a wide range of operating conditions.

The direct drive motor provides a more direct look at the actual motion of the load. Therefore, the feedback from the encoder is sufficient to optimally sequence the machine without additional timers.

Another solution would be to use an external encoder to fully close the loop with the load. However, this adds additional design, fabrication, maintenance, and material costs to a BOM and can be the most cost prohibitive solution.

THE RESULTS

Percentage-wise, the results seen in Tables 2 and 3 show significant improvements with the direct drive motor, but in reality the motor is only shaving off a few hundred milliseconds per movement. This small difference may seem insignificant; however, these fractions of a second add up tremendously over the lifetime of a machine.

Even though the system with a direct drive motor initially costs \$6,298 more than the gear motor system, it pays for itself in less than 14 days of operation.

QUANTIFICATION OF THE RESULTS

In order to add some perspective to what we observed, consider an indexing table that has eight stations. The table rotates 45 degrees in 200 milliseconds (nominally) during each index.

After this rotation, a secondary process is performed for 300 milliseconds to complete the cycle. The table needs to be settled to within 0.050 degrees for the widget to be made correctly. Every rotation produces a \$0.05 widget, and the machine runs one 8 hour shift per day.

In this scenario, the increased throughput brought about by using a direct drive motor would allow the motor to pay for itself in less than 14 days, despite the fact that the direct drive system lists for \$6,298 more than the gear motor system.

Naturally one might assume that processes don't need the level of accuracy provided with a 0.050 degree settling window. However, on a 5 foot diameter table, a 0.050 degree tolerance allows a float equivalent to +/- 0.026" or slightly less than 1/32" in either direction at the edge of the table.

When put in this perspective, it's easy to understand that most processes

require a window even tighter than +/- 1/32" to be completed accurately, and the tolerance is not exceptionally unreasonable as such.

When comparing the three primary solutions available for indexing tables, the gear motor, direct drive motor, and gear motor with an external encoder, the direct drive motor solution will offer the best overall combination of price, performance, and simplicity.

As seen in this test, the gearmotor solution simply cannot compete with a direct drive motor in terms of positioning accuracy, backlash, settling time, and cycle time.

A gear motor with an external encoder would be closer to the performance capabilities of a direct drive motor, but the additional mechanical design, machining, installation, maintenance, and programming time costs of a fully closed system make it the most cost prohibitive and engineering intensive solution available.

While the price of a direct drive servo motor may cause engineers to give pause, the performance advantages and the rapid payback in productivity make direct drive servo motors the pinnacle solution for a wide range of rotary servo axis applications.

Criteria	Direct Drive Motor	Gear Motor	Gear Motor with Fully-Closed Loop
Positioning accuracy	BEST	WORST	MIDDLE
Backlash	BEST	WORST	MIDDLE
Settling time	BEST	WORST	MIDDLE
Cycle time	BEST	WORST	MIDDLE
Machine cost and payback time	BEST	MIDDLE	WORST
Design complexity	BEST	MIDDLE	WORST

Table 4: Overall rankings of the 3 solutions

As direct drive servo motors become more common, with a wider range of sizes and features, they are finding homes in more applications than ever before.

WHEN DOES A DIRECT DRIVE MOTOR FIT THE APPLICATION?

Direct drive motors and geared servo motors are frequently quoted against one another for similar applications. This overlap often causes confusion about which motor type is best suited for a particular axis. As direct drive servo motors become more common, with a wider range of sizes and features, they are finding homes in more applications than ever before.

DEFINING CHARACTERISTICS

A direct drive servo motor is designed to accommodate the load mounted directly to the rotating flange of the motor. To accomplish this, the motors are designed with large, high-capacity bearings designed to carry the entire load, without using additional support or bearings. Directly coupling the load to the motor also eliminates the backlash and torsional flex that can negatively impact the performance of a traditional rotary servo motor and gearbox combination.

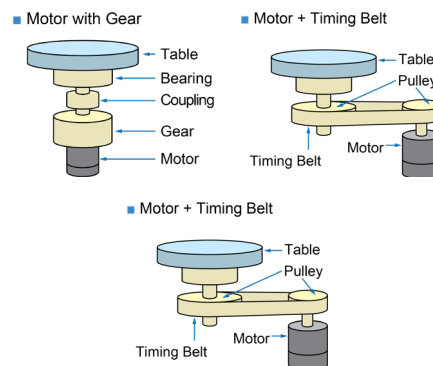

Figure 7: Mechanical designs

This simplified mechanical design, seen in Figure 7, lends itself to space-constrained situations such as robotic arms or a 4th or 5th axis on a CNC or additive manufacturing machine, where the space savings can reduce the overall size and mass, improving system performance and reducing cost.

Most rotary servo motors are capable of much higher speeds than most applications require, but oftentimes they also lack sufficient torque.

As a result, gearboxes or timing belts are used to convert the excess speed capacity into usable torque and to reduce the reflected inertia to improve tuning. Instead, the direct drive design uses a much higher pole count within the motor and windings optimized to provide high torque at lower speeds, similar to the torques and speeds exhibited by a highly geared servo motor. Since the gearbox is eliminated, backlash is eliminated, and efficiency is improved.

Matching the reflected inertia to the motor's inertia is important in increasing the frequency response of the system. A poorly matched system cannot be tuned for optimal performance and may, in extreme cases, oscillate or become unstable.

While a gearbox reduces the reflected inertia in a geared rotary servo motor system by the square of the gear ratio, direct drive servo motors must handle the full inertial load without mechanical assistance.

To deal with this, direct drive servo motors utilize a two-pronged approach for improving frequency response: increased rotor inertia, and high mechanical stiffness. The high mass and large diameter of the rotor provide sufficient inertia to damp disturbances at the load, reducing settling times, and improving system performance.

On the other hand, the high mechanical stiffness associated with coupling the load directly to the rotor flange reduces the potential for stored energy, which can lead to oscillations and instability upon release. When properly sized, a direct drive servo motor can offer better tuning performance with faster settling and increased resistance to load disturbances than a comparable geared servo motor.

A direct drive servo motor is designed to accommodate the load mounted directly to the rotating flange of the motor.

Direct drive motors have become commonplace in indexing table applications, where rapid, repeatable movement of large loads is critical.

This reduction in backlash, high torque, and excellent inertia handling are reasons that direct drive motors have become commonplace in indexing table applications, where the rapid and repeatable movement of a large load is critical.

The large rotor and bearings provide another benefit as well. Shifting the mass outward opens up the center of the motor, leaving a large hollow bore. This hollow bore that gives the direct drive motor its signature shape can actually be used to pass through cables and plumbing to equipment located at the load.

The hollow bore is critically important in many robotic applications, where peripheral cables on the arm are passed through the center of the motor to reduce cable strain.

■ Hollow Motor + Hollow Gear

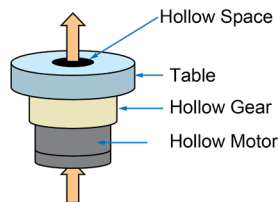

■ Direct Drive Servomotor (Large center aperture)

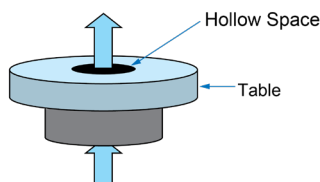

Figure 8: Hollow bore designs

DIRECT DRIVE MOTOR TYPES

When considering a direct drive motor for an application, three basic designs are generally offered:

- Coreless with an inner-rotor
- iron core with an inner rotor
- iron core with an outer rotor.

Each of these design differences offers an inherent advantage towards common industrial automation applications.

The first distinguishing feature between these motor types is whether or not the direct drive motor has an inner rotor or an outer rotor. This simply refers to whether or not the rotor is inside the stator or outside of the stator.

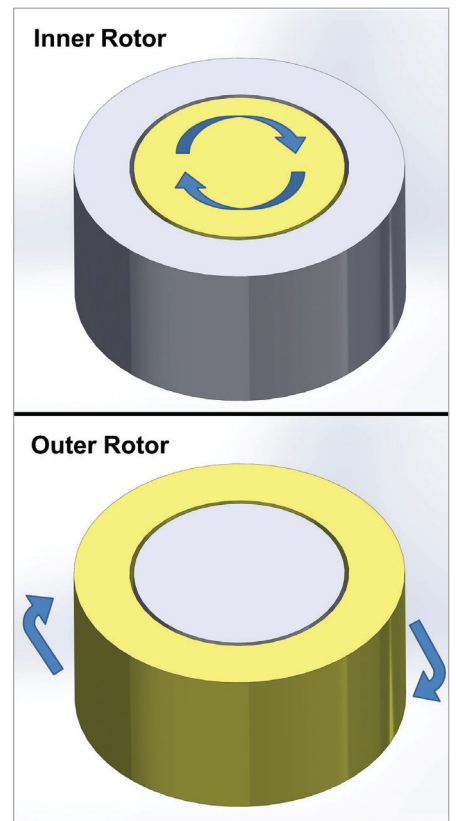

Figure 9: Direct drive rotor types

Outer rotor motors are very well suited for applications with high load inertia, as the larger radius of the outer rotor increases the rotor inertia.

On the other hand, inner rotor motors have lower rotor inertia, and are best suited to applications with low load inertia and where high acceleration is required.

The other common difference in direct drive motor design is whether or not the motor uses an iron core in the stator windings. The iron core is used to concentrate the magnetic flux from the stator windings and align it with the magnets in the rotor.

It is important to recognize the 3 different designs of direct drive motors.

Each design offers a different advantage for common industrial applications

DIRECT DRIVE MOTOR BEST FITS:

- Semiconductor handling
- Machine tool
- End-of-arm robot applications
- Additive Manufacturing
- Indexing tables

The coreless direct drive motor design foregoes the iron core, which reduces the magnetic efficiency, but also eliminates the cogging forces caused by the magnets passing by the iron core.

The coreless design offers the smoothest operation available, and is widely used in semiconductor and coating equipment applications where the load inertia is typically small and the absolute smoothest possible motion is required.

While the iron core motors are not quite as smooth, the difference is minimal, and the iron core design offers the benefit of greatly improved torque density.

CONCLUSION

Direct drive servo motors offer similar torque and speed characteristics to geared servo motors.

However, the direct drive motor's inherent design advantages allow it to be the clear solution for many applications. Industrial automation applications such as **semiconductor handling** and **machine tool** benefit tremendously from the small size and low mechanical complexity of the direct drive motor, whereas **end-of-arm robot** and **additive manufacturing** applications frequently take advantage of the direct drive servo's hollow bore for routing of cables and pneumatics.

Furthermore, the exceptional inertia handling of a direct drive motor excels at moving large inertial loads such as those seen on an **indexing table**, improving performance and ROI versus an equivalent gear motor.

All in all, direct drive servo motors can be applied nearly anywhere a geared rotary servo motor is used, and the added benefits of smaller size, higher efficiency, improved tuning performance, and easy integration often make the direct drive servo motor the ideal solution.

YASKAWA.COM



Yaskawa is the leading global manufacturer of low and medium voltage variable frequency drives, servo systems, machine controllers and industrial robots. Our standard products, as well as tailor-made solutions, are well known and have a high reputation for outstanding quality and reliability.

YASKAWA

YASKAWA AMERICA, INC. | Drives & Motion Division

1-800-YASKAWA | Email: info@yaskawa.com | yaskawa.com

Document No. WP.MTN.14 | 05/10/2021 | © 2021 Yaskawa America, Inc.