

Rotary Servomotors

SGMAV



Model Designations

● Without Gears

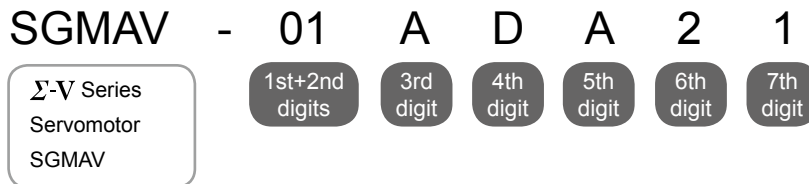

1st+2nd digits Rated Output

Code	Specifications
A5	50 W
01	100 W
C2	150 W
02	200 W
04	400 W
06	550 W
08	750 W
10	1.0 kW

3rd digit Power Supply Voltage

Code	Specifications
A	200 VAC

4th digit Serial Encoder

Code	Specifications
3	20-bit absolute *
D	20-bit incremental

5th digit Design Revision Order

Code	Specifications
A	Standard

6th digit Shaft End

Code	Specifications
2	Straight without key
6	Straight with key and tap
B	With two flat seats

7th digit Options

Code	Specifications
1	Without options
C	With holding brake (24 VDC)
E	With oil seal and holding brake (24 VDC)
S	With oil seal

NOTE: Shaded items are non-stock.

*: When exporting the servomotors themselves, export restrictions may apply. Follow each country's export restrictions.

Features

- Super high power rate (Extremely low inertia)
- Instantaneous peak torque (300% of rated torque)
- Mounted high-resolution serial encoder:
20 bits
- Maximum speed: 6,000 min⁻¹
- Wide selection: 50 W to 1.0 kW capacity, holding
brake and gear options

Application Examples

- Semiconductor equipment
- Chip mounters
- PCB drilling stations
- Robots
- Material handling machines
- Food processing equipment

Ratings and Specifications

Time Rating: Continuous
 Vibration Class: V15
 Insulation Resistance: 500 VDC, 10 MΩ min.
 Ambient Temperature: 0 to 40°C
 Excitation: Permanent magnet
 Mounting: Flange-mounted
 Thermal Class: B

Withstand Voltage: 1500 VAC for one minute
 Enclosure: Totally enclosed, self-cooled, IP65
 (except for shaft opening)
 Ambient Humidity: 20% to 80% (no condensation)
 Drive Method: Direct drive
 Rotation Direction: Counterclockwise (CCW) with forward run
 reference when viewed from the load side

Voltage		200 V							
Servomotor Model: SGM _{AV} -□□□□		A5A	01A	C2A	02A	04A	06A	08A	10A
Rated Output ^{*1}	W	50	100	150	200	400	550	750	1000
Rated Torque ^{*1, *2}	N·m	0.159	0.318	0.477	0.637	1.27	1.75	2.39	3.18
Instantaneous Peak Torque ^{*1}	N·m	0.477	0.955	1.43	1.91	3.82	5.25	7.16	9.55
Rated Current ^{*1}	A _{rms}	0.66	0.91	1.3	1.5	2.6	3.8	5.3	7.4
Instantaneous Max. Current ^{*1}	A _{rms}	2.1	2.8	4.2	5.3	8.5	12.2	16.6	23.9
Rated Speed ^{*1}	min ⁻¹	3000							
Max. Speed ^{*1}	min ⁻¹	6000							
Torque Constant	N·m/A _{rms}	0.265	0.375	0.381	0.450	0.539	0.496	0.487	0.467
Rotor Moment of Inertia	×10 ⁻⁴ kg·m ²	0.0242 (0.0389)	0.0380 (0.0527)	0.0531 (0.0678)	0.116 (0.180)	0.190 (0.254)	0.326 (0.403)	0.769 (0.940)	1.20 (1.41)
Rated Power Rate ^{*1}	kW/s	10.4	26.6	42.8	35.0	84.9	93.9	74.1	84.3
Rated Angular Acceleration ^{*1}	rad/s ²	65800	83800	89900	54900	67000	53700	31000	26500
Applicable SERVOPACK	SGDV-□□□□□	R70□	R90□	1R6A,2R1F		2R8□	5R5A	5R5A	120A

*1: These items and torque-motor speed characteristics quoted in combination with an SGD_V SERVOPACK are at an armature winding temperature of 100°C. Other values quoted are at 20°C.

*2: Rated torques are continuous allowable torque values at 40°C with an aluminum heat sink of the following dimensions attached.
 SGM_{AV}-A5A, -01A: 200 mm×200 mm×6 mm
 SGM_{AV}-C2A, -02A, -04A, -06A, -08A: 250 mm×250 mm×6 mm
 SGM_{AV}-10A: 300 mm×300 mm×12 mm

Note: The values in parentheses are for servomotors with holding brakes.

● Torque-Motor Speed Characteristics A: Continuous Duty Zone B: Intermittent Duty Zone^(See Note3)

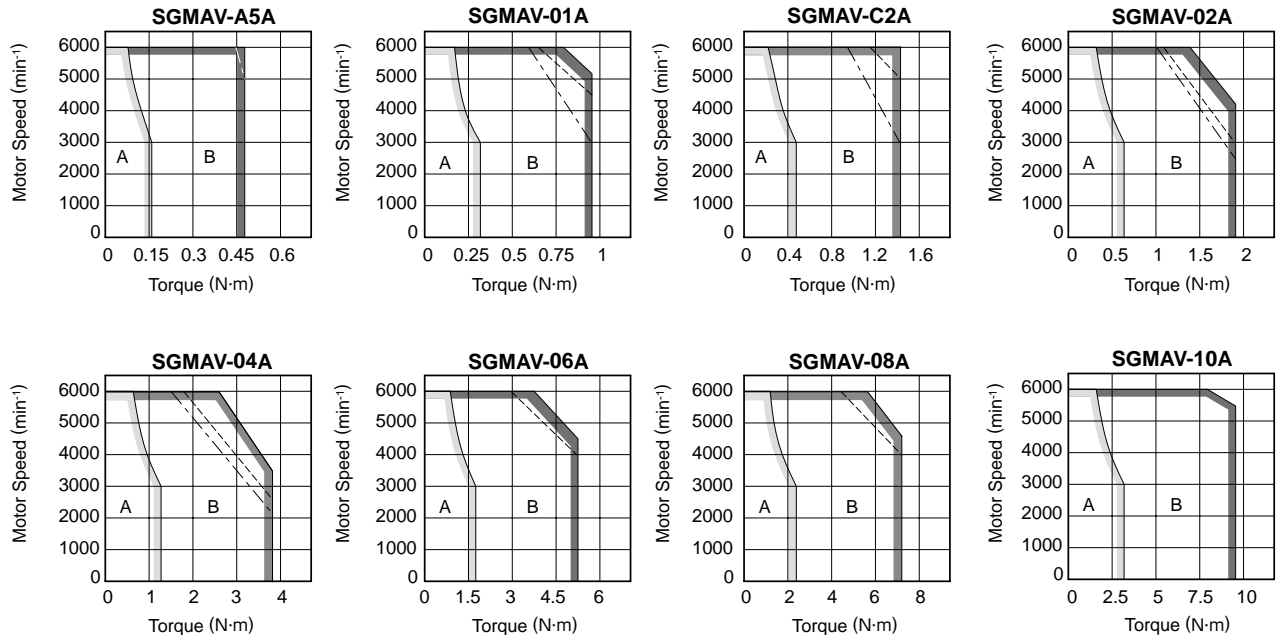

Notes: 1 The solid, dotted, and dashed-dotted lines of the intermittent duty zone indicate the characteristics when a servomotor runs with the following combinations:

- The solid line: With a three-phase 200 V or a single-phase 230 V SERVOPACK
- The dotted line: With a single-phase 200 V SERVOPACK
- The dashed-dotted line: With a single-phase 100 V SERVOPACK

An SGM_{AV}-A5A servomotor has the same characteristics in combination with three-phase 200 V and single-phase 200 V SERVOPACKS.

- 2 The characteristics of the intermittent duty zone differ depending on the supply voltages.
- 3 When the effective torque during intermittent duty is within the rated torque, the servomotor can be used within the intermittent duty zone.
- 4 When the main circuit cable length exceeds 20 m, note that the intermittent duty zone of the Torque-Motor Speed Characteristics will shrink as the line-to-line voltage drops.

Ratings and Specifications

● Derating Rate for Servomotor Fitted with an Oil Seal

When a motor is fitted with an oil seal, use the following derating rate because of the higher friction torque.

Servomotor Model SGMVA-	A5A	01A	C2A	02A	04A	06A	08A	10A
Derating Rate %	80	90			95			

● Holding Brake Electrical Specifications

Holding Brake Rated Voltage	Servomotor Model	Servomotor Rated Output W	Holding Brake Specifications					
			Capacity W	Holding Torque N·m	Coil Resistance Ω(at 20°C)	Rated Current A(at 20°C)	Brake Release Time ms	Brake Operation Time ms
24 VDC ^{+10%} ₀	SGMAV-A5A	50	5.5	0.159	103	0.23	60	100
	SGMAV-01A	100		0.318				
	SGMAV-C2A	150	5.1	0.477	114	0.21	60	100
	SGMAV-02A	200	6	0.637	97.4	0.25	60	100
	SGMAV-04A	400		1.27				
	SGMAV-06A	550	8	1.75	74.3	0.32	80	100
	SGMAV-08A	750	6.5	2.39	87.7	0.27	80	100
	SGMAV-10A	1000	7	3.18	82.8	0.29	80	100

- Notes: 1 The holding brake is only used to hold the load and cannot be used to stop the servomotor.
 2 The holding brake open time and holding brake operation time vary depending on which discharge circuit is used. Make sure holding brake open time and holding brake operation time are correct for your servomotor.
 3 A 24-VDC power supply is provided by customers.

● Overload Characteristics

The overload detection level is set under hot start conditions at a servomotor ambient temperature of 40°C.

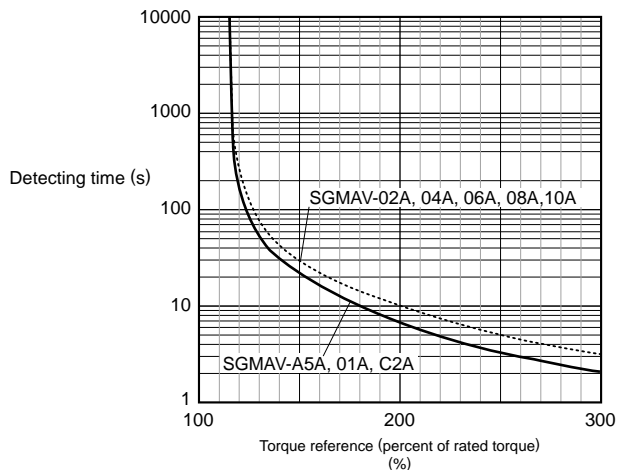

Note: Overload characteristics shown above do not guarantee continuous duty of 100% or more output. Use a servomotor with effective torque within the continuous duty zone of Torque-Motor Speed Characteristics.

Ratings and Specifications

● Allowable Load Moment of Inertia at the Motor Shaft

The rotor moment of inertia ratio is the value for a servomotor without a gear and a brake.

Servomotor Model		Servomotor Rated Output	Allowable Load Moment of Inertia (Rotor Moment of Inertia Ratio)
SGMAV-	A5A, 01A, C2A, 02A	50 to 200 W	30 times
	04A, 06A, 08A	400 to 750 W	20 times
	10A	1000 W	10 times

● Load Moment of Inertia

- The larger the load moment of inertia, the worse the movement response.
- The allowable load moment of inertia (J_L) depends on motor capacity, as shown above. This value is provided strictly as a guideline and results may vary depending on servomotor drive conditions.
- Use the AC servo drive capacity selection program SigmaJunmaSize+ to check the operation conditions. The program can be downloaded for free from our web site (<http://www.e-mechatronics.com/>).
- An overvoltage alarm (A.400) is likely to occur during deceleration if the load moment of inertia exceeds the allowable load moment of inertia. SERVOPACKs with a built-in regenerative resistor may generate a regenerative overload alarm (A.320). Take one of the following steps if this occurs.
 - Reduce the torque limit.
 - Reduce the deceleration rate.
 - Reduce the maximum speed.
 - Install an external regenerative resistor if the alarm cannot be cleared using the steps above. Refer to Regenerative Resistors on page 386.
- Regenerative resistors are not built into SERVOPACKs for 400 W motors or less.
- External regenerative resistors are required when this condition is exceeded or if the allowable loss capacity (W) of the built-in regenerative resistor is exceeded due to regenerative drive conditions when a regenerative resistor is already built in.

● Allowable Radial and Thrust Loads

Design the mechanical system so thrust and radial loads applied to the servomotor shaft end during operation fall within the ranges shown in the table.

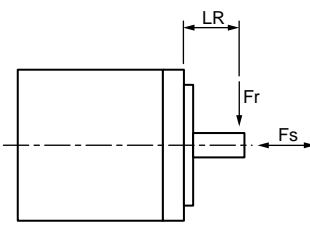
Servomotor Model		Allowable Radial Load (F_r) N	Allowable Thrust Load (F_s) N	LR mm	Reference Diagram
SGMAV-	A5A	78	54	20	
	01A				
	C2A				
	02A	245	74	25	
	04A				
	06A				
	08A	392	147	35	
	10A				

External Dimensions Units: mm

(1) 50 to 150 W

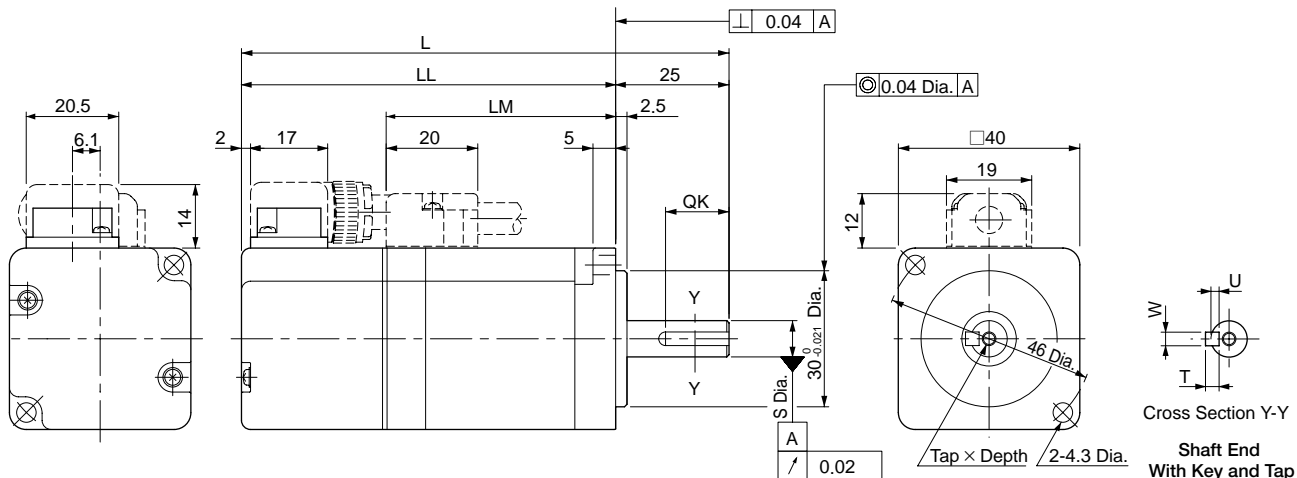

Model SGMAV-	L	LL	LM	S	Tap x Depth	Key Dimensions				Approx. Mass kg
						QK	U	W	T	
A5A□A21 (A5A□A2C)	95.5 (140.5)	70.5 (115.5)	38.5	8 ⁰ _{-0.009} *	No tap	No key				0.3 (0.6)
M3 x 6L					14	1.8	3	3		
A5A□A61 (A5A□A6C)	107.5 (152.5)	82.5 (127.5)	50.5	8 ⁰ _{-0.009}	No tap	No key				0.4 (0.7)
M3 x 6L					14	1.8	3	3		
C2A□A21 (C2A□A2C)	119.5 (164.5)	94.5 (139.5)	62.5	8 ⁰ _{-0.009}	No tap	No key				0.5 (0.8)
M3 x 6L					14	1.8	3	3		

Note: The models and values in parentheses are for servomotors with holding brakes.

*: When you need the same shaft diameter as the conventional servomotors, contact your Yaskawa representative.

Shaft End and Other Options

● With Two Flat Seats

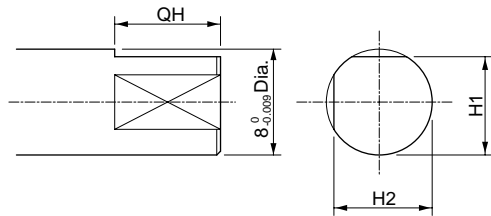

Model SGMAV-	Dimensions of Servomotor with Two Flat Seats		
	QH	H1	H2
A5A□AB□	15	7.5	7.5
O1A□AB□			
C2A□AB□			

● With an Oil Seal

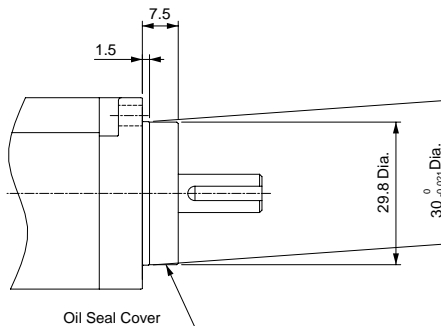

Note: The 7th digit of the model designation is "S" or "E."
The key dimensions are the same as those in the table above.

External Dimensions Units: mm

(2) 200 W to 1.0 kW

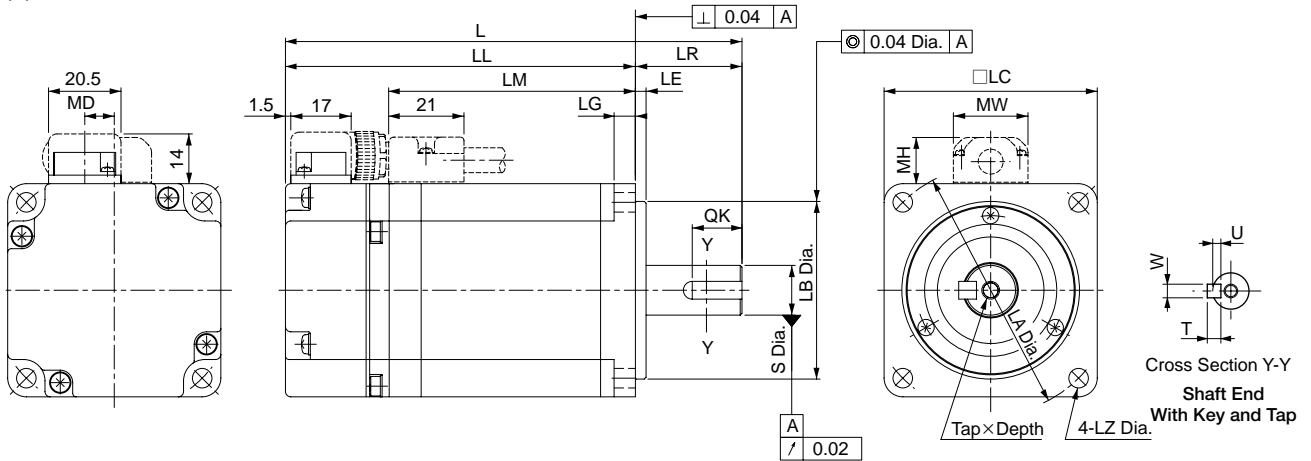

Model SGMAV-	L	LL	LM	Flange Face Dimensions								S	Tap x Depth	Key Dimensions				MD	MW	MH	Approx. Mass kg
				LR	LE	LG	LC	LA	LB	LZ	QK			U	W	T					
02A□A21 (02A□A2C)	110 (150)	80 (120)	51	30	3	6	60	70	50 ⁰ _{-0.025}	5.5	14 ⁰ _{-0.011}	No tap	No key				8.5	21	13	0.9 (1.5)	
02A□A61 (02A□A6C)												M5 x 8L	14	3	5	5					
04A□A21 (04A□A2C)	128.5 (168.5)	98.5 (138.5)	69.5	30	3	6	60	70	50 ⁰ _{-0.025}	5.5	14 ⁰ _{-0.011}	No tap	No key				8.5	21	13	1.2 (1.8)	
04A□A61 (04A□A6C)												M5 x 8L	14	3	5	5					
06A□A21 (06A□A2C)	154.5 (200.5)	124.5 (170.5)	95.5	30	3	6	60	70	50 ⁰ _{-0.025}	5.5	14 ⁰ _{-0.011}	No tap	No key				8.5	21	13	1.7 (2.4)	
06A□A61 (06A□A6C)												M5 x 8L	14	3	5	5					
08A□A21 (08A□A2C)	155 (200)	115 (160)	85	40	3	8	80	90	70 ⁰ _{-0.030}	7	19 ⁰ _{-0.013} *	No tap	No key				13.8	27	15	2.6 (3.2)	
08A□A61 (08A□A6C)												M6 x 10L	22	3.5	6	6					
10A□A21 (10A□A2C)	185 (235)	145 (195)	115	40	3	8	80	90	70 ⁰ _{-0.030}	7	19 ⁰ _{-0.013} *	No tap	No key				13.8	27	15	3.6 (4.6)	
10A□A61 (10A□A6C)												M6 x 10L	22	3.5	6	6					

Note: The models and values in parentheses are for servomotors with holding brakes.

*: When you need the same shaft diameter as the conventional servomotors, contact your Yaskawa representative.

Shaft End and Other Options

● With Two Flat Seats

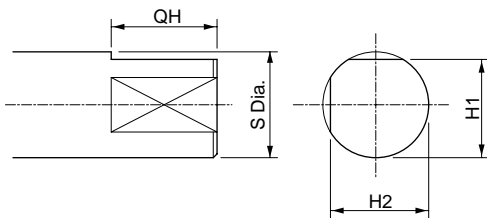

Model SGMAV-	Dimensions of Servomotor with Two Flat Seats			
	QH	S	H1	H2
02A□AB□	14	14 ⁰ _{-0.011}	13	13
04A□AB□				
06A□AB□				
08A□AB□	22	19 ⁰ _{-0.013}	18	18
10A□AB□				

● With an Oil Seal

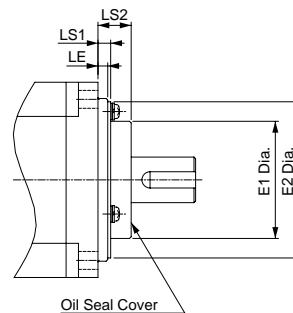

Model SGMAV-	Dimensions of Servomotor with an Oil Seal			
	E1	E2	LS1	LS2
02A, 04A, 06A	36	48	4	10
08A, 10A	49	66	6	11

Note: The 7th digit of the model designation is "S" or "E."

The key dimensions are the same as those in the table above.

Selecting Cables

● Cables Connections

● Standard Wiring (Max. encoder cable length: 20 m)

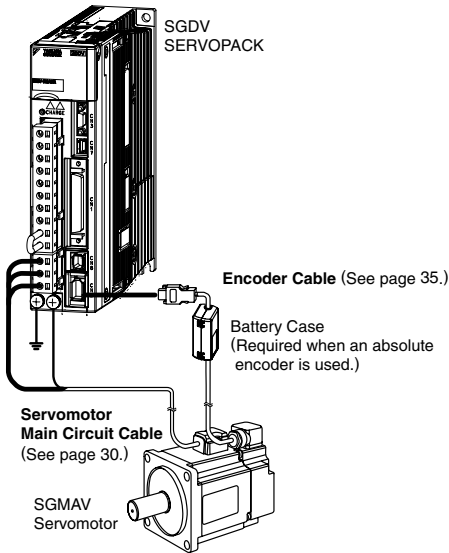

● Encoder Cable Extension from 30 to 50 m

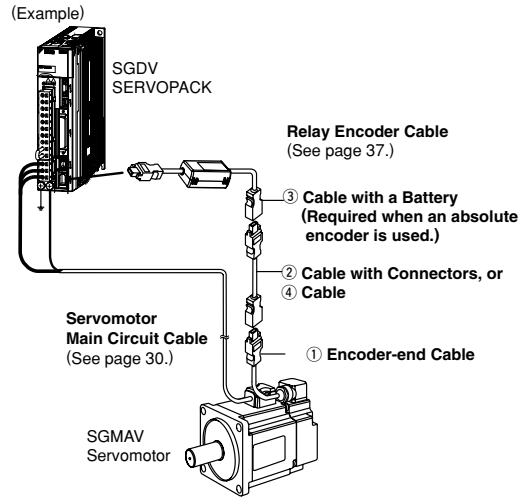

⚠ CAUTION

- Separate the servomotor main circuit cable wiring from the I/O signal cable and encoder cable at least 30 cm, and do not bundle or run them in the same duct.
- When the cable length exceeds 20 m, be sure to use a relay encoder cable.
- When the main circuit cable length exceeds 20 m, note that the intermittent duty zone of the Torque-Motor Speed Characteristics will shrink as the line-to-line voltage drops.



● Servomotor Main Circuit Cable

Name	Servomotor Rated Output	Length	Order No.			Specifications	Details
			Standard Type	Flexible Type*	Premium Type*		
For Servomotor without Holding Brakes	50 to 150 W	3 m	JZSP-CSM01-03-E	JZSP-CSM21-03-E	YAI-CSM21-03-P-E		(1)
		5 m	JZSP-CSM01-05-E	JZSP-CSM21-05-E	YAI-CSM21-05-P-E		
		10 m	JZSP-CSM01-10-E	JZSP-CSM21-10-E	YAI-CSM21-10-P-E		
		15 m	JZSP-CSM01-15-E	JZSP-CSM21-15-E	YAI-CSM21-15P-E		
		20 m	JZSP-CSM01-20-E	JZSP-CSM21-20-E	YAI-CSM21-20-P-E		
		30 m	JZSP-CSM01-30-E	JZSP-CSM21-30-E	YAI-CSM21-30-P-E		
		40 m	JZSP-CSM01-40-E	JZSP-CSM21-40-E	YAI-CSM21-40-P-E		
	50 m	JZSP-CSM01-50-E	JZSP-CSM21-50-E	YAI-CSM21-50-P-E			
	200 to 550 W	3 m	JZSP-CSM02-03-E	JZSP-CSM22-03-E	YAI-CSM22-03-P-E		
		5 m	JZSP-CSM02-05-E	JZSP-CSM22-05-E	YAI-CSM22-05-P-E		
		10 m	JZSP-CSM02-10-E	JZSP-CSM22-10-E	YAI-CSM22-10-P-E		
		15 m	JZSP-CSM02-15-E	JZSP-CSM22-15-E	YAI-CSM22-15P-E		
		20 m	JZSP-CSM02-20-E	JZSP-CSM22-20-E	YAI-CSM22-20-P-E		
		30 m	JZSP-CSM02-30-E	JZSP-CSM22-30-E	YAI-CSM22-30-P-E		
		40 m	JZSP-CSM02-40-E	JZSP-CSM22-40-E	YAI-CSM22-40-P-E		
	50 m	JZSP-CSM02-50-E	JZSP-CSM22-50-E	YAI-CSM22-50-P-E			
	750 W, 1.0 kW	3 m	JZSP-CSM03-03-E	JZSP-CSM23-03-E	YAI-CSM23-03-P-E		
		5 m	JZSP-CSM03-05-E	JZSP-CSM23-05-E	YAI-CSM23-05-P-E		
		10 m	JZSP-CSM03-10-E	JZSP-CSM23-10-E	YAI-CSM23-10-P-E		
		15 m	JZSP-CSM03-15-E	JZSP-CSM23-15-E	YAI-CSM23-15P-E		
		20 m	JZSP-CSM03-20-E	JZSP-CSM23-20-E	YAI-CSM23-20-P-E		
		30 m	JZSP-CSM03-30-E	JZSP-CSM23-30-E	YAI-CSM23-30-P-E		
		40 m	JZSP-CSM03-40-E	JZSP-CSM23-40-E	YAI-CSM23-40-P-E		
	50 m	JZSP-CSM03-50-E	JZSP-CSM23-50-E	YAI-CSM23-50-P-E			

*: Use flexible cables for movable sections such as robot arms.

(Cont'd)

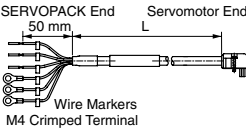
Selecting Cables

Name	Servomotor Rated Output	Length	Order No.			Specifications	Details
			Standard Type	Flexible Type*	Premium Type*		
For Servomotor with Holding Brakes	50 to 150 W	3 m	JZSP-CSM11-03-E	JZSP-CSM31-03-E	YAI-CSM31-03-P-E		(2)
		5 m	JZSP-CSM11-05-E	JZSP-CSM31-05-E	YAI-CSM31-05-P-E		
		10 m	JZSP-CSM11-10-E	JZSP-CSM31-10-E	YAI-CSM31-10-P-E		
		15 m	JZSP-CSM11-15-E	JZSP-CSM31-15-E	YAI-CSM31-15-P-E		
		20 m	JZSP-CSM11-20-E	JZSP-CSM31-20-E	YAI-CSM31-20-P-E		
		30 m	JZSP-CSM11-30-E	JZSP-CSM31-30-E	YAI-CSM31-30-P-E		
		40 m	JZSP-CSM11-40-E	JZSP-CSM31-40-E	YAI-CSM31-40-P-E		
	200 to 550 W	3 m	JZSP-CSM12-03-E	JZSP-CSM32-03-E	YAI-CSM32-03-P-E		
		5 m	JZSP-CSM12-05-E	JZSP-CSM32-05-E	YAI-CSM32-05-P-E		
		10 m	JZSP-CSM12-10-E	JZSP-CSM32-10-E	YAI-CSM32-10-P-E		
		15 m	JZSP-CSM12-15-E	JZSP-CSM32-15-E	YAI-CSM32-15-P-E		
		20 m	JZSP-CSM12-20-E	JZSP-CSM32-20-E	YAI-CSM32-20-P-E		
		30 m	JZSP-CSM12-30-E	JZSP-CSM32-30-E	YAI-CSM32-30-P-E		
		40 m	JZSP-CSM12-40-E	JZSP-CSM32-40-E	YAI-CSM32-40-P-E		
	750 W, 1.0 kW	3 m	JZSP-CSM13-03-E	JZSP-CSM33-03-E	YAI-CSM33-03-P-E		
		5 m	JZSP-CSM13-05-E	JZSP-CSM33-05-E	YAI-CSM33-05-P-E		
		10 m	JZSP-CSM13-10-E	JZSP-CSM33-10-E	YAI-CSM33-10-P-E		
		15 m	JZSP-CSM13-15-E	JZSP-CSM33-15-E	YAI-CSM33-15-P-E		
		20 m	JZSP-CSM13-20-E	JZSP-CSM33-20-E	YAI-CSM33-20-P-E		
		30 m	JZSP-CSM13-30-E	JZSP-CSM33-30-E	YAI-CSM33-30-P-E		
		40 m	JZSP-CSM13-40-E	JZSP-CSM33-40-E	YAI-CSM33-40-P-E		
Servomotor-end Connector Kit	50 to 150 W	JZSP-CSM9-1-E			N/A	Crimping Type (A crimp tool is required.) 	(3)
	200 to 550 W	JZSP-CSM9-2-E			N/A		(4)
	750 W, 1.0 kW	JZSP-CSM9-3-E			N/A		(5)
Cables	50 to 550 W	5 m	JZSP-CSM90-05-E	JZSP-CSM80-05-E	N/A		(6)
		10 m	JZSP-CSM90-10-E	JZSP-CSM80-10-E	N/A		
		15 m	JZSP-CSM90-15-E	JZSP-CSM80-15-E	N/A		
		20 m	JZSP-CSM90-20-E	JZSP-CSM80-20-E	N/A		
		30 m	JZSP-CSM90-30-E	JZSP-CSM80-30-E	N/A		
		40 m	JZSP-CSM90-40-E	JZSP-CSM80-40-E	N/A		
		50 m	JZSP-CSM90-50-E	JZSP-CSM80-50-E	N/A		
	750 W, 1.0kW	5 m	JZSP-CSM91-05-E	JZSP-CSM81-05-E	N/A		(7)
		10 m	JZSP-CSM91-10-E	JZSP-CSM81-10-E	N/A		
		15 m	JZSP-CSM91-15-E	JZSP-CSM81-15-E	N/A		
		20 m	JZSP-CSM91-20-E	JZSP-CSM81-20-E	N/A		
		30 m	JZSP-CSM91-30-E	JZSP-CSM81-30-E	N/A		
		40 m	JZSP-CSM91-40-E	JZSP-CSM81-40-E	N/A		
		50 m	JZSP-CSM91-50-E	JZSP-CSM81-50-E	N/A		

*: Use flexible cables for movable sections such as robot arms.

Selecting Cables

(1) Wiring Specifications for Servomotors without Holding Brakes

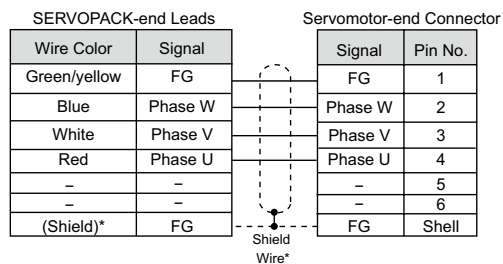

* Shield wire only on Premium Type Cables, and is accessible if cable jacket is removed.

(2) Wiring Specifications for Servomotor with Holding Brakes

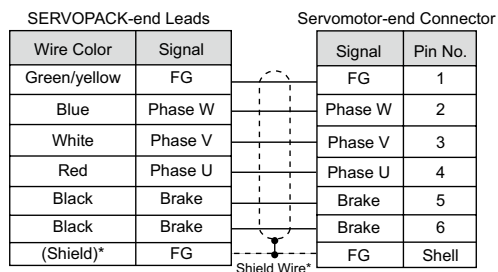

Note: No polarity for connection to a holding brake.
 *Shield wire only on premium-type cables, and is accessible if cable jacket is removed.

(3) Servomotor-end Connector Kit Specifications: For 50 to 150 W Servomotors

Items	Specifications	External Dimensions mm
Order No.	JZSP-CSM9-1-E (Cables are not included.)	
Applicable Servomotors	SGMAV-A5A, -01A, -C2A	
Manufacturer	J.S.T. Mfg. Co., Ltd.	
Receptacle	J17-06FMH-7KL-1-CF	
Electrical Contact	SJ1F-01GF-P0.8	
Applicable Wire Size	AWG20 to 24	
Outer Diameter of Insulating Sheath	1.11 dia. to 1.53 dia. mm	
Crimp Hand tool	YRS-8841	
Tool Applicator	APLMK SJ1F/M-01-08	
Mounting Screw	M2 Pan-head screw	
Applicable Cable Outer Diameter	7±0.3 dia. mm	

Selecting Cables

(4) Servomotor-end Connector Kit Specifications: For 200 to 550 W Servomotors

Items		Specifications	External Dimensions mm
Order No.	JZSP-CSM9-2-E (Cables are not included.)		
Applicable Servomotors	SGMAV-02A, -04A, -06A		
Manufacturer	J.S.T. Mfg. Co., Ltd.		
Receptacle	J27-06FMH-7KL-1-CF		
Electrical Contact	SJ2F-01GF-P1.0		
Applicable Wire Size	AWG20 to 24		
Outer Diameter of Insulating Sheath	1.11 dia. to 1.53 dia. mm		
Crimp Tool	Hand tool	YRS-8861	
	Applicator	APLMK SJ2F/M-01-08	
Mounting Screw	M2 Pan-head screw		
Applicable Cable Outer Diameter	7±0.3 dia. mm		

(5) Servomotor-end Connector Kit Specifications: For 750 W, 1.0 kW Servomotors

Items		Specifications		External Dimensions mm
Order No.	JZSP-CSM9-3-E (Cables are not included.)			
Applicable Servomotors	SGMAV-08A,-10A			
Manufacturer	J.S.T. Mfg. Co., Ltd.			
Receptacle	J37-06FMH-8KL-1-CF			
Cable Type	Standard			
Electrical Contact	SJ3F-41GF-P1.8 (For power terminals)	SJ3F-01GF-P1.8 (For holding brake terminals)		
Applicable Wire Size	AWG16 to 20	AWG20 to 24		
Outer Diameter of Insulating Sheath	1.53 dia. to 2.5 dia. mm	1.11 dia. to 1.86 dia. mm		
Crimp Tool	Hand tool	YRF-880	YRF-881	
	Applicator	APLMK SF3F/M-41-20	APLMK SF3F/M-01-20	
Mounting Screw	M2.5 Pan-head screw			
Applicable Cable Outer Diameter	8±0.3 dia. mm			

Selecting Cables

(6) Cable Specifications: For 50 to 550 W Servomotors

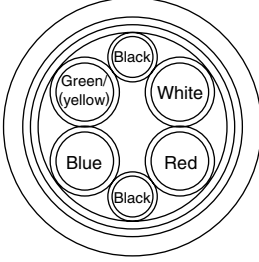
Items	Standard Type	Flexible Type
Order No.*	JZSP-CSM90-□□-E (50 m max.)	JZSP-CSM80-□□-E (50 m max.)
Specifications	UL2517 (Max. operating temperature: 105°C) AWG20×6C For power line: AWG20 (0.52 mm ²) Outer diameter of insulating sheath: 1.53 dia. mm For holding brake line: AWG20 (0.52 mm ²) Outer diameter of insulating sheath: 1.53 dia. mm	UL2517 (Max. operating temperature: 105°C) AWG22×6C For power line: AWG22 (0.33 mm ²) Outer diameter of insulating sheath: 1.37 dia. mm For holding brake line: AWG22 (0.33 mm ²) Outer diameter of insulating sheath: 1.37 dia. mm
Finished Dimensions	7±0.3 dia. mm	
Internal Configuration and Lead Color		
Yaskawa Standard Specifications (Standard Length)	Cable length: 5 m, 10 m, 15 m, 20 m, 30 m, 40 m, 50 m	

*: Specify the cable length in □□ of order no.
 Example: JZSP-CSM90-05-E (5 m)

(7) Cable Specifications: For 750 W, 1.0 kW Servomotors

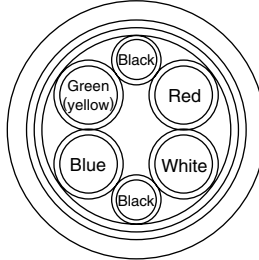
Items	Standard Type	Flexible Type
Order No.*	JZSP-CSM91-□□-E (50 m max.)	JZSP-CSM81-□□-E (50 m max.)
Specifications	UL2517 (Max. operating temperature: 105°C) AWG16×4C, AWG20×2C For power line: AWG16 (1.31 mm ²) Outer diameter of insulating sheath: 2.15 dia. mm For holding brake line: AWG20 (0.52 mm ²) Outer diameter of insulating sheath: 1.6 dia. mm	UL2517 (Max. operating temperature: 105°C) AWG16×4C, AWG22×2C For power line: AWG16 (1.31 mm ²) Outer diameter of insulating sheath: 2.35 dia. mm For holding brake line: AWG22 (0.33 mm ²) Outer diameter of insulating sheath: 1.37 dia. mm
Finished Dimensions	8±0.3 dia. mm	
Internal Configuration and Lead Color		
Yaskawa Standard Specifications (Standard Length)	Cable length: 5 m, 10 m, 15 m, 20 m, 30 m, 40 m, 50 m	

*: Specify the cable length in □□ of order no.
 Example: JZSP-CSM91-15-E (15 m)

Selecting Cables

Encoder Cables (Length: 20 m or less)

Name	Length	Order No.		Specifications	Details
		Standard Type	Flexible Type*		
Cable with Connectors (For Incremental Encoder)	3 m	JZSP-CSP01-03-E	JZSP-CSP21-03-E		(1)
	5 m	JZSP-CSP01-05-E	JZSP-CSP21-05-E		
	10 m	JZSP-CSP01-10-E	JZSP-CSP21-10-E		
	15 m	JZSP-CSP01-15-E	JZSP-CSP21-15-E		
	20 m	JZSP-CSP01-20-E	JZSP-CSP21-20-E		
Cable with Connectors (For Absolute Encoder, with a Battery Case)	3 m	JZSP-CSP05-03-E	JZSP-CSP25-03-E		(2)
	5 m	JZSP-CSP05-05-E	JZSP-CSP25-05-E		
	10 m	JZSP-CSP05-10-E	JZSP-CSP25-10-E		
	15 m	JZSP-CSP05-15-E	JZSP-CSP25-15-E		
	20 m	JZSP-CSP05-20-E	JZSP-CSP25-20-E		
SERVOPACK-end Connector Kit		JZSP-CMP9-1-E		Soldered 	(3)
Encoder-end Connector Kit		JZSP-CSP9-2-E		Crimping Type (A crimp tool is required.) 	
Cables	3 m	JZSP-CMP09-03-E	JZSP-CSP39-03-E		(4)
	5 m	JZSP-CMP09-05-E	JZSP-CSP39-05-E		
	10 m	JZSP-CMP09-10-E	JZSP-CSP39-10-E		
	15 m	JZSP-CMP09-15-E	JZSP-CSP39-15-E		
	20 m	JZSP-CMP09-20-E	JZSP-CSP39-20-E		

*: Use flexible cables for movable sections such as robot arms.

Note: When the battery from the host controller is used for the absolute encoder, no battery case is required. In this case, use a cable for the incremental encoders.

(1) Wiring Specifications for Cable with Connectors (For incremental encoder)

Standard Type

SERVOPACK End		Encoder (Servomotor) End	
Pin No.	Signal	Pin No.	Wire Color
6	/PS	5	Light blue/white
5	PS	4	Light blue
4	BAT (-)	8	Orange/white
3	BAT (+)	9	Orange
2	PG 0V	3	Black
1	PG 5V	6	Red
Shell	FG	Shell	FG

Flexible Type

SERVOPACK End		Encoder (Servomotor) End	
Pin No.	Signal	Pin No.	Wire Color
6	/PS	5	Black/pink
5	PS	4	Red/pink
4	BAT (-)	8	Black/light blue
3	BAT (+)	9	Red/light blue
2	PG 0V	3	Green
1	PG 5V	6	Orange
Shell	FG	Shell	FG

(2) Wiring Specifications for Cable with Connectors (For absolute encoder, with a battery case)

Standard Type

SERVOPACK End		Encoder (Servomotor) End	
Pin No.	Signal	Pin No.	Wire Color
6	/PS	5	Light blue/white
5	PS	4	Light blue
4	BAT (-)	8	Orange/white
3	BAT (+)	9	Orange
2	PG 0V	3	Black
1	PG 5V	6	Red
Shell	FG	Shell	FG

Battery Case	
Pin No.	Signal
2	BAT (-)
1	BAT (+)

Flexible Type

SERVOPACK End		Encoder (Servomotor) End	
Pin No.	Signal	Pin No.	Wire Color
6	/PS	5	Black/pink
5	PS	4	Red/pink
4	BAT (-)	8	Black/light blue
3	BAT (+)	9	Red/light blue
2	PG 0V	3	Green
1	PG 5V	6	Orange
Shell	FG	Shell	FG

Battery Case	
Pin No.	Signal
2	BAT (-)
1	BAT (+)

Selecting Cables

(3) SERVOPACK-end/Encoder-end Connector Kit Specifications

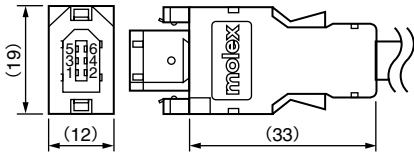
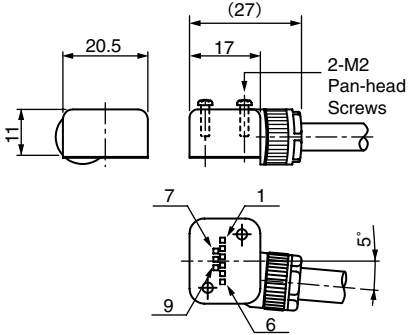
Items	SERVOPACK-end Connector Kit	Encoder-end Connector Kit
Order No.	JZSP-CMP9-1-E (Cables are not included.)	JZSP-CSP9-2-E (Cables are not included.)
Manufacturer	Molex Japan Co., Ltd.	Molex Japan Co., Ltd.
Specifications	55100-0670 (soldered)	54346-0070 (crimped)* Mounting screw: M2 pan-head screw (×2) Outer diameter of applicable cable: 6.3 dia. to 7.7 dia. mm Applicable wire size: AWG22 to 26 Outer diameter of insulating sheath: 1.05 dia. to 1.4 dia. mm
External Dimensions mm		

*: A crimp tool is required.
The following crimp tools are applicable for the cables provided by Yaskawa. When using other wire sizes, contact the respective manufacturer for crimp tools.
Applicable crimp tool for Yaskawa's wire size: Hand Tool Model No. 57175-5000
Applicator Model No. 57175-3000

(4) Cable Specifications

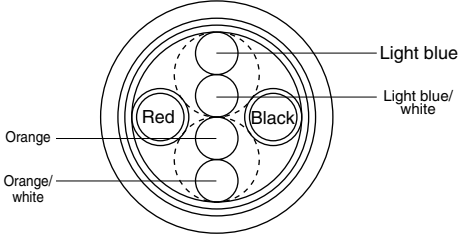
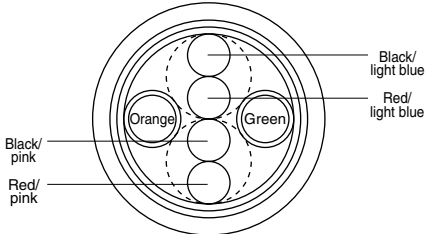
Items	Standard Type	Flexible Type
Order No.*	JZSP-CMP09-□□-E	JZSP-CSP39-□□-E
Cable Length	20 m max.	
Specifications	UL20276 (Max. operating temperature: 80°C) AWG22×2C+AWG24×2P AWG22 (0.33 mm ²) Outer diameter of insulating sheath: 1.15 dia. mm AWG24 (0.20 mm ²) Outer diameter of insulating sheath: 1.09 dia. mm	UL20276 (Max. operating temperature: 80°C) AWG22×2C+AWG24×2P AWG22 (0.33 mm ²) Outer diameter of insulating sheath: 1.35 dia. mm AWG24 (0.20 mm ²) Outer diameter of insulating sheath: 1.21 dia. mm
Finished Dimensions	6.5 dia. mm	6.8 dia. mm
Internal Configuration and Lead Color		
Yaskawa Standards Specifications (Standard Length)	Cable length: 5 m, 10 m, 15 m, 20 m	

*: Specify the cable length in □□ of order no.
Example: JZSP-CSM09-05-E (5 m)

Selecting Cables

● Relay Encoder Cables (For extending from 30 to 50 m)

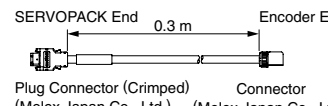
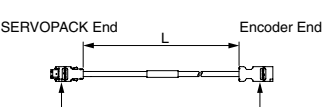
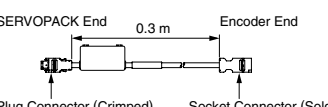
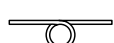
Name	Length	Order No. Standard Type	Specifications	Details
① Encoder-end Cables (For incremental and absolute encoder)	0.3 m	JZSP-CSP11-E	 <p>SERVOPACK End 0.3 m Encoder End</p> <p>Plug Connector (Crimped) Connector (Molex Japan Co., Ltd.) (Molex Japan Co., Ltd.)</p>	(1)
② Cable with Connectors (For incremental and absolute encoder)	30 m	JZSP-UCMP00-30-E	 <p>SERVOPACK End L Encoder End</p> <p>Plug Connector (Crimped) Socket Connector (Soldered) (Molex Japan Co., Ltd.) (Molex Japan Co., Ltd.)</p>	(2)
	40 m	JZSP-UCMP00-40-E		
	50 m	JZSP-UCMP00-50-E		
③ Cable with a Battery Case (Required when an absolute encoder is used.)	0.3 m	JZSP-CSP12-E*	 <p>SERVOPACK End 0.3 m Encoder End</p> <p>Plug Connector (Crimped) Socket Connector (Soldered) (Molex Japan Co., Ltd.) (Molex Japan Co., Ltd.)</p>	(3)
④ Cables	30 m	JZSP-CMP19-30-E		(4)
	40 m	JZSP-CMP19-40-E		
	50 m	JZSP-CMP19-50-E		

* When using an incremental encoder or using an absolute encoder with a battery connected to the host controller, no battery case is required.

(1) Wiring Specifications for Encoder-end Cable

SERVOPACK End		Encoder (Servomotor) End	
Pin No.	Signal	Pin No.	Wire Color
6	/PS	5	Light blue/white
5	PS	4	Light blue
4	BAT (-)	8	Orange/white
3	BAT (+)	9	Orange
2	PG 0V	3	Black
1	PG 5V	6	Red
Shell	FG	Shell	FG

Shield Wire

(2) Wiring Specifications for Cable with Connectors

SERVOPACK End		Encoder (Servomotor) End	
Pin No.	Signal	Pin No.	Wire Color
6	/PS	6	Light blue/white
5	PS	5	Light blue
4	BAT (-)	4	Orange/white
3	BAT (+)	3	Orange
2	PG 0V	2	Black
1	PG 5V	1	Red
Shell	FG	Shell	FG

Shield Wire

Selecting Cables

(3) Wiring Specifications for Cable with a Battery Case

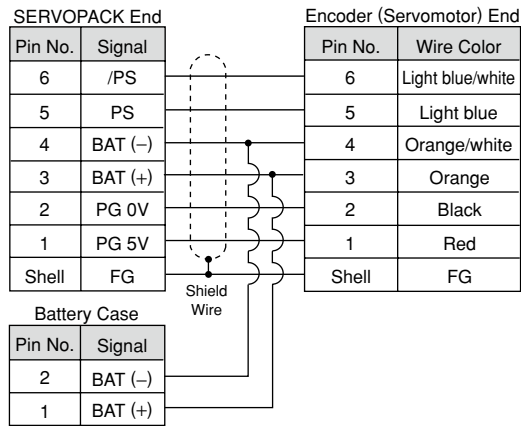

(4) Cable Specifications

Item	Standard Type
Order No.*	JZSP-CMP19-□□-E
Cable Length	50 m max.
Specifications	UL20276 (Max. operating temperature: 80°C) AWG16×2C+AWG26×2P AWG16 (1.31 mm ²) Outer diameter of insulating sheath: 2.0 dia. mm AWG26 (0.13 mm ²) Outer diameter of insulating sheath: 0.91 dia. mm
Finished Dimensions	6.8 dia. mm
Internal Configuration and Lead Colors	
Yaskawa Standard Specifications (Standard Length)	Cable length: 30 m, 40 m, 50 m

*: Specify the cable length in □□ of order no.
Example: JZSP-CMP19-30-E (30 m)