

Direct Drive Servomotors

SGMCS

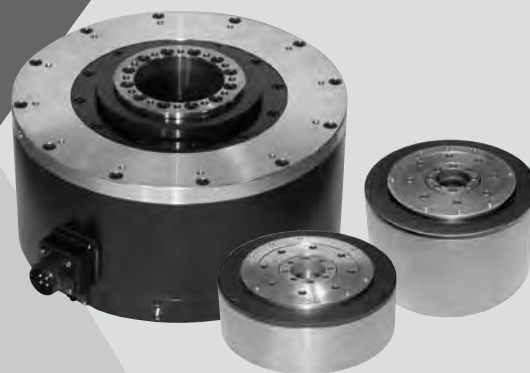

Model Designations

SGMCS - 02 B 3 C 1 1

Direct Drive Servomotor SGMCS

1st+2nd digits 3rd digit 4th digit 5th digit 6th digit 7th digit

1st+2nd digits Rated Torque

● Small-capacity

Code	Specifications
02	2.0 N·m
04	4.0 N·m
05	5.0 N·m
07	7.0 N·m
08	8.0 N·m
10	10 N·m
14	14 N·m
16	16 N·m
17	17 N·m
25	25 N·m
35	35 N·m

● Medium-capacity

Code	Specifications
45	45 N·m
80	80 N·m
1A	110 N·m
1E	150 N·m
2Z	200 N·m

3th digit Motor Outer Diameter

Code	Specifications
B	135 dia. mm
C	175 dia. mm
D	230 dia. mm
E	290 dia. mm
M	280 dia. mm
N	360 dia. mm

4th digit Encoder Specifications

Code	Specifications
3	20-bit absolute (without multiturn data) (standard)
D	20-bit incremental (option)

5th digit Design Revision Order

Code	Specifications
A	Model of servomotor outer diameter code M, N
B	Model of servomotor outer diameter code E
C	Model of servomotor outer diameter code B, C, D

6th digit Flange Specifications

Code	Flange Specifications		Motor Outer Diameter Code (3rd digit)					
	Specifications	Mounted Side	B	C	D	E	M	N
1	C-face	Non-load side	○	○	○	○	-	-
		load end	-	-	-	-	○	○
3	C-face	Non-load side	-	-	-	-	○	○
4	C-face	Non-load side (with cable on side)	○	○	○	○	-	-

○ : Applicable Model

7th digit Option

Code	Specifications
1	Without options

NOTE: Shaded items are non-stock.

Features

- Directly coupled to a load without a mechanical transmission such as a gear.
- Powerful and smooth operation throughout the speed range from low to high.
(Instantaneous peak torque: 6 to 600 N·m
maximum speed: 250 to 500 min⁻¹)
- High-resolution, 20-bit encoder for highly precise indexing.
- Easy wiring and piping with the hollow structure.

Application Examples

- Semiconductor equipment
- LCD manufacturing equipment
- Units for inspection and testing
- Electronic parts assembling machines
- IC handlers
- Inspection units for integrated circuits
- Automated machines
- Robots

Rated Torque / Peak Torque

● Small-capacity

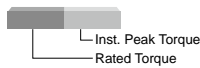

Outer Diameter 135 mm, Inner Diameter 20 mm

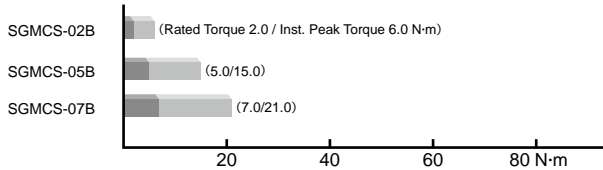

Outer Diameter 175 mm, Inner Diameter 35 mm

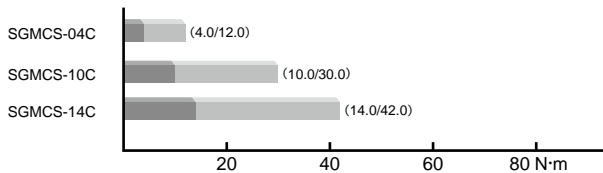

Outer Diameter 230 mm, Inner Diameter 60 mm

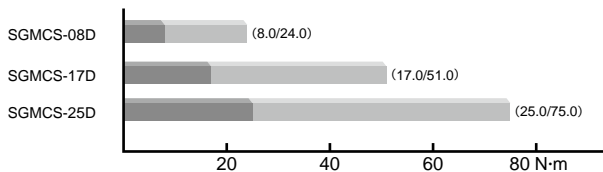

Outer Diameter 290 mm, Inner Diameter 75 mm

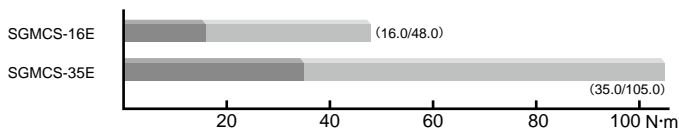

● Medium-capacity

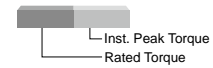

Outer Diameter 280 mm, Inner Diameter 75 mm

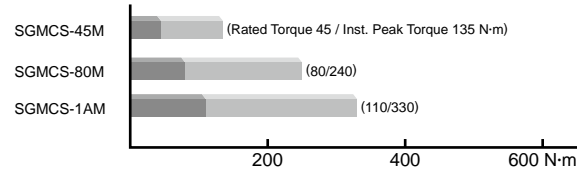

Outer Diameter 360 mm, Inner Diameter 118 mm

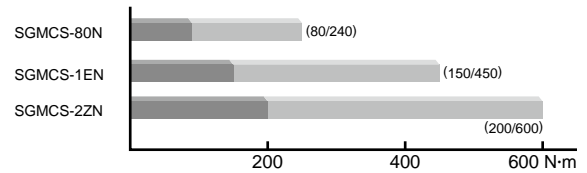

Ratings and Specifications

● Small-capacity Series

Time Rating: Continuous

Vibration Class: V15

Insulation Resistance: 500 VDC, 10 M Ω min.

Ambient Temperature: 0 to 40°C

Excitation: Permanent magnet

Mounting: Flange method

Thermal Class: A

Withstand Voltage: 1500 VAC for one minute

Enclosure: Totally enclosed, self-cooled, IP42 (except for gaps on the rotating section of the shaft)

Ambient Humidity: 20% to 80% (no condensation)

Drive Method: Direct drive

Rotation Direction: Counterclockwise (CCW) with forward run reference when viewed from the load side

Voltage		200 V										
Servomotor Model SGMCS-□□□□□		02B□C	05B□C	07B□C	04C□C	10C□C	14C□C	08D□C	17D□C	25D□C	16E□B	35E□B
Rated Output ^{*1}	W	42	105	147	84	209	293	168	356	393	335	550
Rated Torque ^{*1, *2}	N·m	2.0	5.0	7.0	4.0	10.0	14.0	8.0	17.0	25.0	16.0	35.0
Instantaneous Peak Torque ^{*1}	N·m	6.0	15.0	21.0	12.0	30.0	42.0	24.0	51.0	75.0	48.0	105
Stall Torque ^{*1}	N·m	2.05	5.15	7.32	4.09	10.1	14.2	8.23	17.4	25.4	16.5	35.6
Rated Current ^{*1}	A _{rms}	1.8	1.7	1.4	2.2	2.2	2.8	1.9	2.5	2.6	3.3	3.5
Instantaneous Max. Current ^{*1}	A _{rms}	5.4	5.1	4.1	7.0	7.0	8.3	5.6	7.5	8.0	9.4	10.0
Rated Speed ^{*1}	min ⁻¹	200			200			200		150	200	150
Max. Speed ^{*1}	min ⁻¹	500			500	400	300	500	350	250	500	250
Torque Constant	N·m/A _{rms}	1.18	3.17	5.44	2.04	5.05	5.39	5.1	7.8	10.8	5.58	11.1
Rotor Moment of Inertia	×10 ⁻⁴ kg·m ²	28	51	77	77	140	220	285	510	750	930	1430
Rated Power Rate ^{*1}	kW/s	1.4	4.9	6.4	2.1	7.1	8.9	2.2	5.7	8.3	2.75	8.57
Rated Angular Acceleration ^{*1}	rad/s ²	710	980	910	520	710	640	280	330	330	170	240
Absolute Accuracy	arc-sec	±15			±15			±15		±15		
Repeatability	arc-sec	±1.3			±1.3			±1.3		±1.3		
Applicable SERVOPACK	SGDV-□□□□	2R8A, 2R1F			2R8A, 2R8F			2R8A, 2R8F		5R5A		

*1: These items and torque-motor speed characteristics quoted in combination with an SGDV SERVOPACK are at an armature winding temperature of 100°C. Other values quoted at 20°C.

*2: Rated torques are continuous allowable torque values at 40°C with a steel heat sink attached.

Heat sink: SGMCS-□□B : 350 mm × 350 mm × 12 mm SGMCS-□□C : 450 mm × 450 mm × 12 mm
 SGMCS-□□D : 550 mm × 550 mm × 12 mm SGMCS-□□E : 650 mm × 650 mm × 12 mm

Notes: 1 SGMCS servomotor with holding brake is not available.

2 For the bearings used in SGMCS servomotors, loss varies according to the bearing temperature. At low temperatures, the amount of heat loss will be large.

● Small-capacity Series: Torque-Motor Speed Characteristics **A** : Continuous Duty Zone **B** : Intermittent Duty Zone^(Note2)

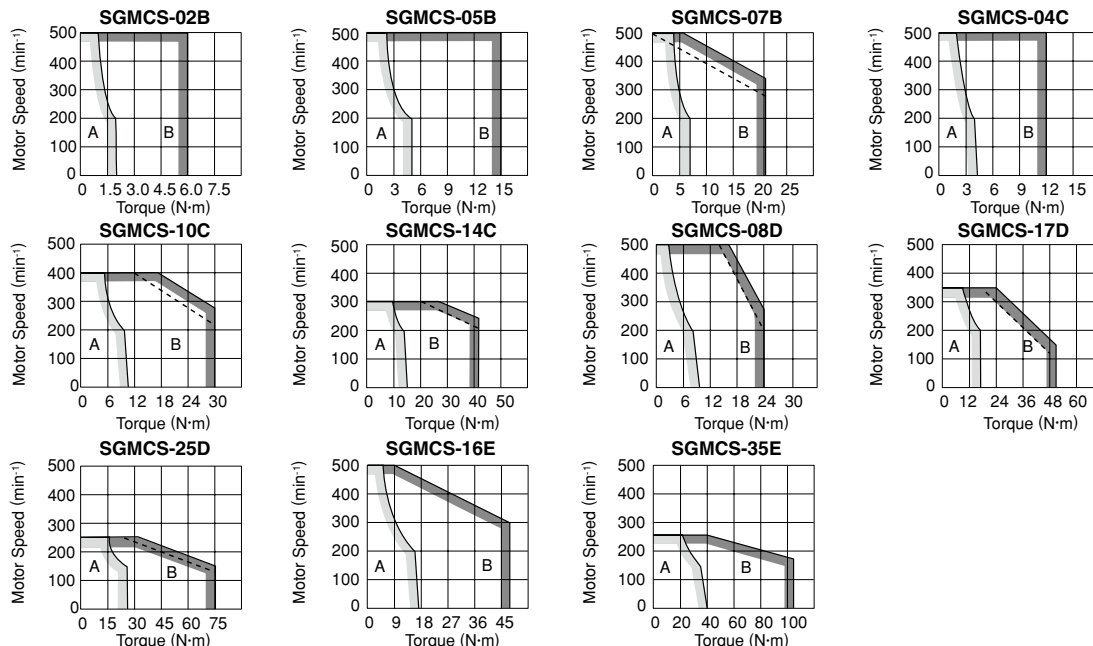

Notes: 1 The solid, dotted lines of the intermittent duty zone indicate the characteristics when a servomotor runs with the following combinations:

- The solid line: With a three-phase 200 V SERVOPACK
- The dotted line: With a single-phase 100 V SERVOPACK

2 When the effective torque during intermittent duty is within the rated torque, the servomotor can be used within the intermittent duty zone.

3 When the main circuit cable length exceeds 20 m, note that the intermittent duty zone of the Torque-Motor Speed Characteristics will shrink as the line-to-line voltage drops.

Ratings and Specifications

● Medium-capacity Series

Time Rating: Continuous

Vibration Class: V15

Insulation Resistance: 500 VDC, 10 MΩ min.

Ambient Temperature: 0 to 40°C

Excitation: Permanent magnet

Mounting: Flange method

Thermal Class: F

Withstand Voltage: 1500 VAC for one minute

Enclosure: Totally enclosed, self-cooled, IP44

(except for shaft opening)

Ambient Humidity: 20% to 80% (no condensation)

Drive Method: Direct drive

Rotation Direction: Counterclockwise (CCW) with forward run reference when viewed from the load side

Voltage		200 V					
Servomotor Model SGMCS-□□□□		45M□□	80M□□	1AM□□	80N□□	1EN□□	2ZN□□
Rated Output ^{*1}	W	707	1260	1730	1260	2360	3140
Rated Torque ^{*1, *2}	N·m	45	80	110	80	150	200
Instantaneous Peak Torque ^{*1}	N·m	135	240	330	240	450	600
Stall Torque ^{*1}	N·m	45	80	110	80	150	200
Rated Current ^{*1}	A _{rms}	5.80	9.74	13.4	9.35	17.4	18.9
Instantaneous Max. Current ^{*1}	A _{rms}	17	28	42	28	56	56
Rated Speed ^{*1}	min ⁻¹	150					
Max. Speed ^{*1}	min ⁻¹	300			250		
Torque Constant	N·m/A _{rms}	8.39	8.91	8.45	9.08	9.05	11.5
Rotor Moment of Inertia	×10 ⁻⁴ kg·m ²	388	627	865	1360	2470	3060
Rated Power Rate ^{*1}	kW/s	52.2	102	140	47.1	91.1	131
Rated Angular Acceleration ^{*1}	rad/s ²	1160	1280	1270	588	607	654
Applicable SERVOPACK	SGDV-□□□□	7R6A	120A	180A	120A	200A	200A

*1: These items and torque-motor speed characteristics quoted in combination with an SGDV SERVOPACK are at an armature winding temperature of 20°C.

*2: Rated torques are continuous allowable torque values at 40°C with a steel heat sink attached.

Heat sink: 750 mm × 750 mm × 45 mm

Notes: 1 SGMCS servomotor with holding brake is not available.

2 For the bearings used in SGMCS servomotors, loss varies according to the bearing temperature. At low temperatures, the amount of heat loss will be large.

● Medium-capacity Series: Torque-Motor Speed Characteristics A : Continuous Duty Zone B : Intermittent Duty Zone^(Note 1)

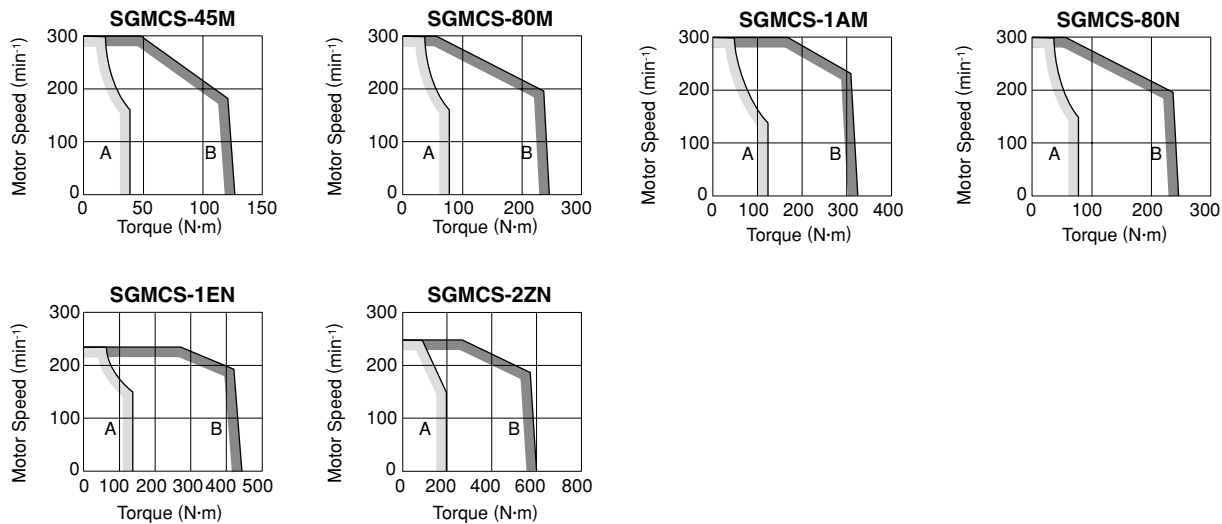

Notes: 1 When the effective torque during intermittent duty is within the rated torque, the servomotor can be used within the intermittent duty zone.

2 When the main circuit cable length exceeds 20 m, note that the intermittent duty zone of the Torque-Motor Speed Characteristics will shrink as the line-to-line voltage drops.

Ratings and Specifications

● Allowable Load Moment of Inertia at the Motor Shaft

Servomotor Model		Rated Torque N·m	Allowable Load Moment of Inertia (Rotor Moment of Inertia Ratio)
SGMCS-	02B□C, 05B□C, 07B□C, 04C□C	2.0, 5.0, 7.0, 4.0	10 times
	10C□C	10.0	5 times
	14C□C, 08D□C, 17D□C, 25D□C, 16E□B, 35E□B	14.0, 8.0, 17.0, 25.0, 16.0, 35.0	3 times
	45M□A, 80M□A, 1AM□A, 80N□A, 1EN□A, 2ZN□A	45, 80, 110, 150, 200	3 times

● Load Moment of Inertia

The larger the load moment of inertia, the worse the movement response.

The allowable load moment of inertia (J_L) depends on motor capacity, as shown above. This value is provided strictly as a guideline and results may vary depending on servomotor drive conditions.

Use the AC servo drive capacity selection program SigmaJunmaSize+ to check the operation conditions. The program can be downloaded for free from our web site (<http://www.e-mechatronics.com/>).

An overvoltage alarm (A.400) is likely to occur during deceleration if the load moment of inertia exceeds the allowable load moment of inertia. SERVOPACKs with a built-in regenerative resistor may generate a regenerative overload alarm (A.320). Take one of the following steps if this occurs.

- Reduce the torque limit.
- Reduce the deceleration rate.
- Reduce the maximum speed.
- Install an external regenerative resistor if the alarm cannot be cleared using the steps above. Refer to Regenerative Resistors on page 386.

Mechanical Specifications

● **Allowable Loads**

The loads applied while a servomotor is running are roughly classified in the following patterns. Design the machine so that the thrust load and moment load will not exceed the values in the table.

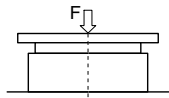

Where F is external force,
Thrust load: $F_a = F + \text{Load mass}$
Moment load: $M = 0$

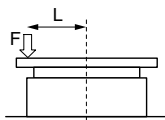

Where F is external force,
Thrust load: $F_a = F + \text{Load mass}$
Moment load: $M = F \times L$

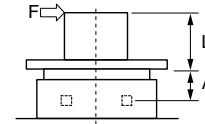

Where F is external force,
Thrust load: $F_a = \text{Load mass}$
Moment load: $M = F \times (L + A)$

(See the table below for the dimension A of each servomotor model.)

Servomotor Model SGMCS-□	02B	05B	07B	04C	10C	14C	08D	17D	25D	16E	35E	45M	80M	1AM	80N	1EN	2ZN
Dimension A mm	0			0			0			0			33		37.5		
Allowable Thrust Load (Fa) N	1500			3300			4000			11000			9000		16000		
Allowable Moment Load (M) N·m	40	50	64	70	75	90	93	103	135	250	320	180		350			

Note: SGMCS-02B to -35E servomotors, set dimensions A to 0 (zero).

● **Mechanical Tolerance**

The following table shows tolerances for the servomotor's output shaft and installation area. See the dimensional drawing of the individual servomotor for more details on tolerances.

(1) Small-capacity Series

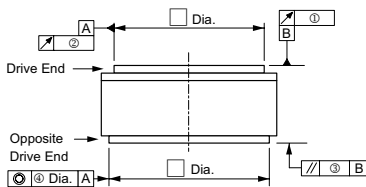

Tolerance T.I.R. (Total Indicator Reading) Units: mm	Servomotor Model SGMCS-										
	02B	05B	07B	04C	10C	14C	08D	17D	25D	16E	35E
① Run-out of the Surface of the Shaft	0.02		0.02		0.02		0.02		0.02		0.02
② Run-out at the End of the Shaft	0.04		0.04		0.04		0.04		0.04		0.04
③ Parallelism between the Flange Face and Output Shaft	0.07		0.07		0.07		0.08		0.08		0.08
④ Coaxiality of Output Axis and Mounting Socket Joint	0.07		0.07		0.07		0.08		0.08		0.08

(2) Medium-capacity Series

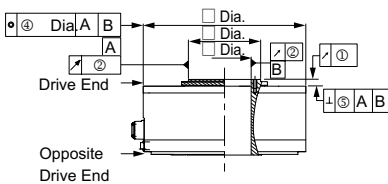

Tolerance T.I.R. (Total Indicator Reading) Units: mm	Servomotor Model SGMCS-					
	45M	80M	1AM	80N	1EN	2ZN
① Run-out of the Surface of the Shaft	0.02		0.02			
② Run-out at the End of the Shaft	0.04		0.04			
③ Parallelism between the Flange Face and Output Shaft*	-		-			
④ Coaxiality of Output Axis and Mounting Socket Joint	0.08		0.08			
⑤ Right angle between Flange Face and Output Shaft	0.08		0.08			

* This tolerance is specified for certain models. See the dimensional drawing of the individual servo motor for details

● **Direction of Rotation**

Positive rotation of the servomotor is counterclockwise when viewed from the load.

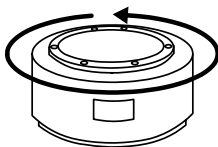

● **Impact Resistance**

Mount the servomotor with the axis horizontal. The servomotor will withstand the following vertical impacts:

- Impact Acceleration: 490 m/s²
- Number of Impacts: 2

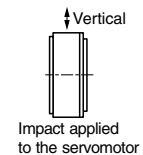

● **Vibration Resistance**

Mount the servomotor with the axis horizontal. The servomotor will withstand the following vibration acceleration in three directions: Vertical, side to side, and front to back.

Servomotor Type	Vibration Acceleration at Flange
Small-capacity Series	49 m/s ²
Medium-capacity Series	24.5 m/s ²

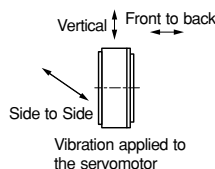

● **Vibration Class**

The vibration class at rated motor speed is V15. (A vibration class of V15 indicates a total vibration amplitude of 15 μm maximum on the servomotor during rated rotation.)

● **Enclosure**

Servomotor Type	Enclosure
Small-capacity Series	IP42 (except for gaps on the rotating section of the shaft)
Medium-capacity Series	IP44

External Dimensions Units: mm

● Small-capacity Series

(1) Rated Torque 2.0 to 7.0 N·m (Outer Diameter 135 mm Inner Diameter 20 mm)

· Applicable Flange: 1

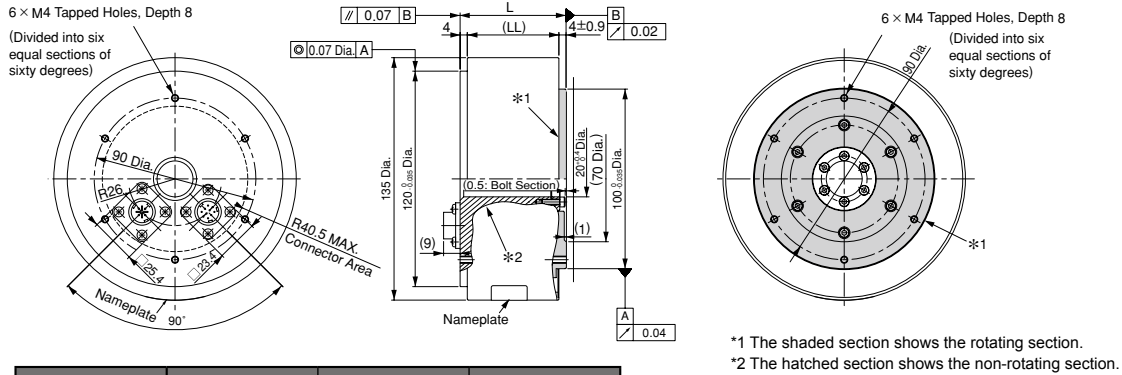

Model SGMCS-	L	(LL)	Approx. Mass kg
02B□C11	59	51	4.8
05B□C11	88	80	5.8
07B□C11	128	120	8.2

· Applicable Flange: 4

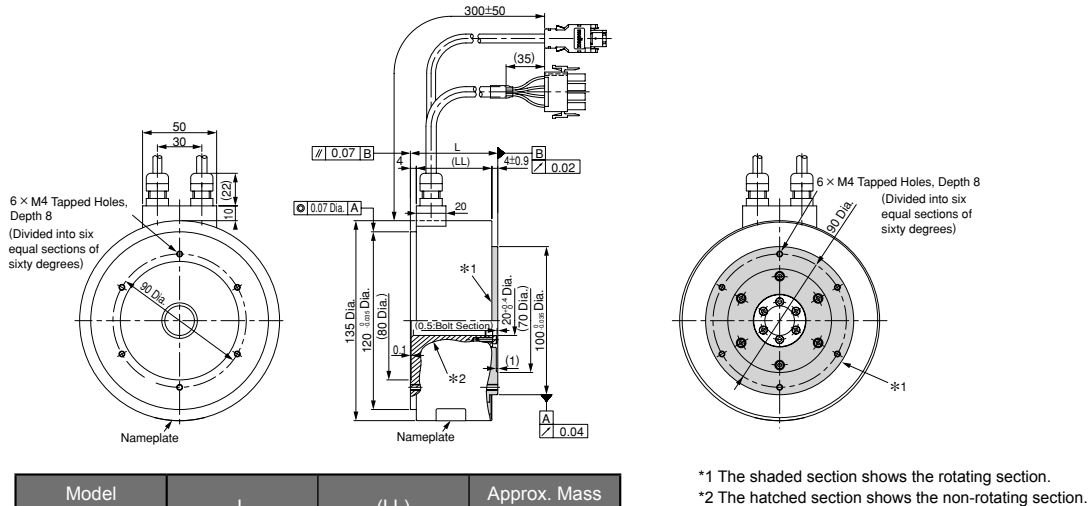

Model SGMCS-	L	(LL)	Approx. Mass kg
02B□C41	59	51	4.8
05B□C41	88	80	5.8
07B□C41	128	120	8.2

● Servomotor Connector for Small-capacity Series Servomotors (Applicable Flange: 1)

Servomotor-end Connector Specifications

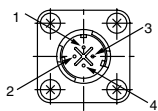

Model: JN1AS04MK2
Manufacturer: Japan Aviation Electronics Industry, Ltd.
Applicable plug: JN1DS04FK1
(Provided by the customer.)

1	Phase U	Red
2	Phase V	White
3	Phase W	Blue
4	FG (Frame ground)	Green (yellow)

Encoder-end Connector Specifications

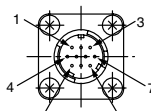

Model: JN1AS10ML1
Manufacturer: Japan Aviation Electronics Industry, Ltd.
Applicable plug: JN1DS10SL1
(Provided by the customer.)

1	PS	Light blue	6	-	-
2	/PS	Light blue/ white	7	FG (Frame ground)	Shield
3	-	-	8	-	-
4	PG5V	Red	9	PG0V	Black
5	-	-	10	-	-

External Dimensions Units: mm

(2) Rated Torque 4.0 to 14.0 N·m (Outer Diameter 175 mm Inner Diameter 35 mm)

· Applicable Flange: 1

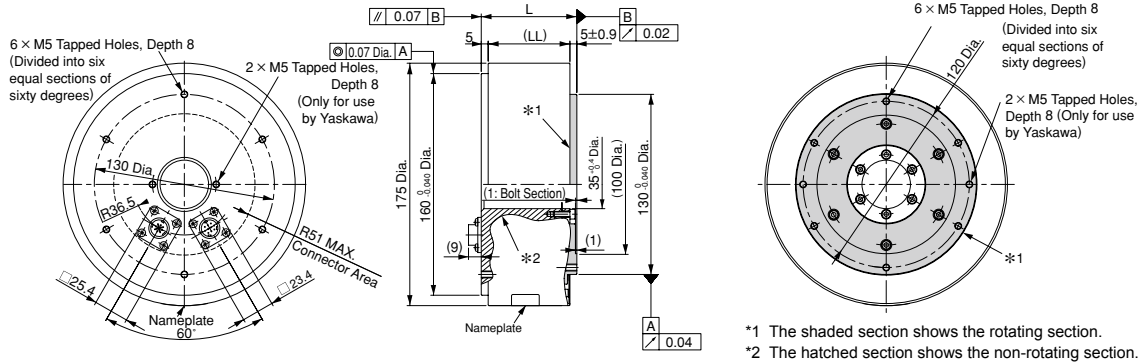

Model SGMCS-	L	(LL)	Approx. Mass kg
04C□C11	69	59	7.2
10C□C11	90	80	10.2
14C□C11	130	120	14.2

· Applicable Flange: 4

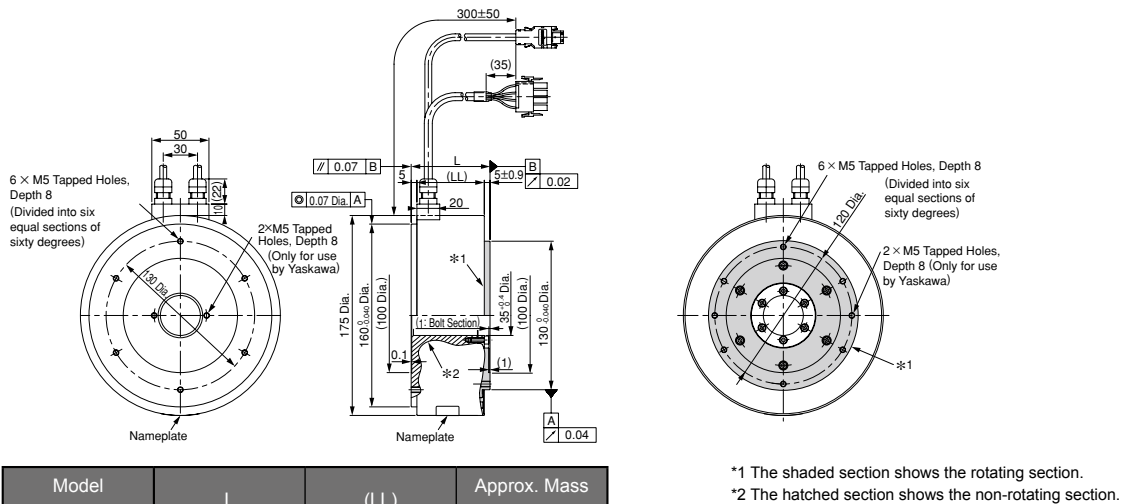

Model SGMCS-	L	(LL)	Approx. Mass kg
04C□C41	69	59	7.2
10C□C41	90	80	10.2
14C□C41	130	120	14.2

● Servomotor Connector (Applicable Flange: 4)

Servomotor-end Connector Specifications

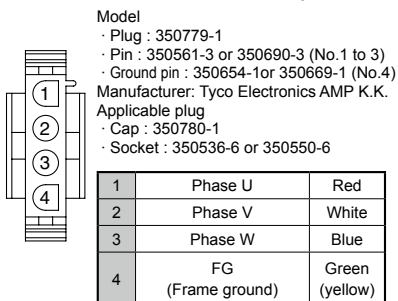

Encoder-end Connector Specifications

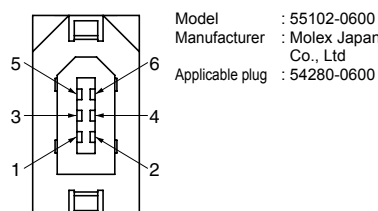

1	PG5V	Red
2	PG0V	Black
3	-	-
4	-	-
5	PS	Light blue
6	/PS	Light blue/white
Connector Case	FG (Frame ground)	Shield

External Dimensions Units: mm

(3) Rated Torque 8.0 to 25.0 N·m (Outer Diameter 230 mm Inner Diameter 60 mm)

· Applicable Flange: 1

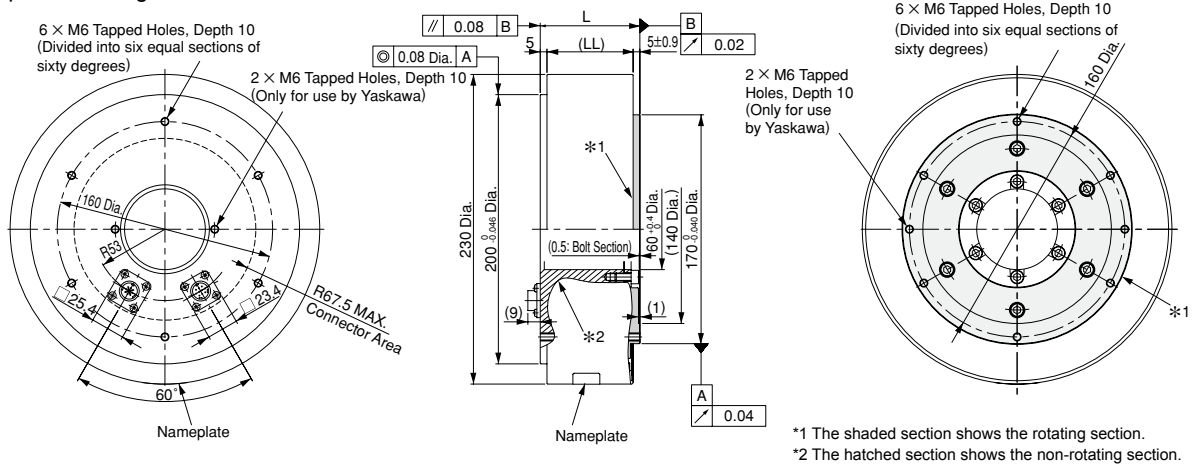

Model SGMCS-	L	(LL)	Approx. Mass kg
08D□C11	74	64	14.0
17D□C11	110	100	22.0
25D□C11	160	150	29.7

· Applicable Flange: 4

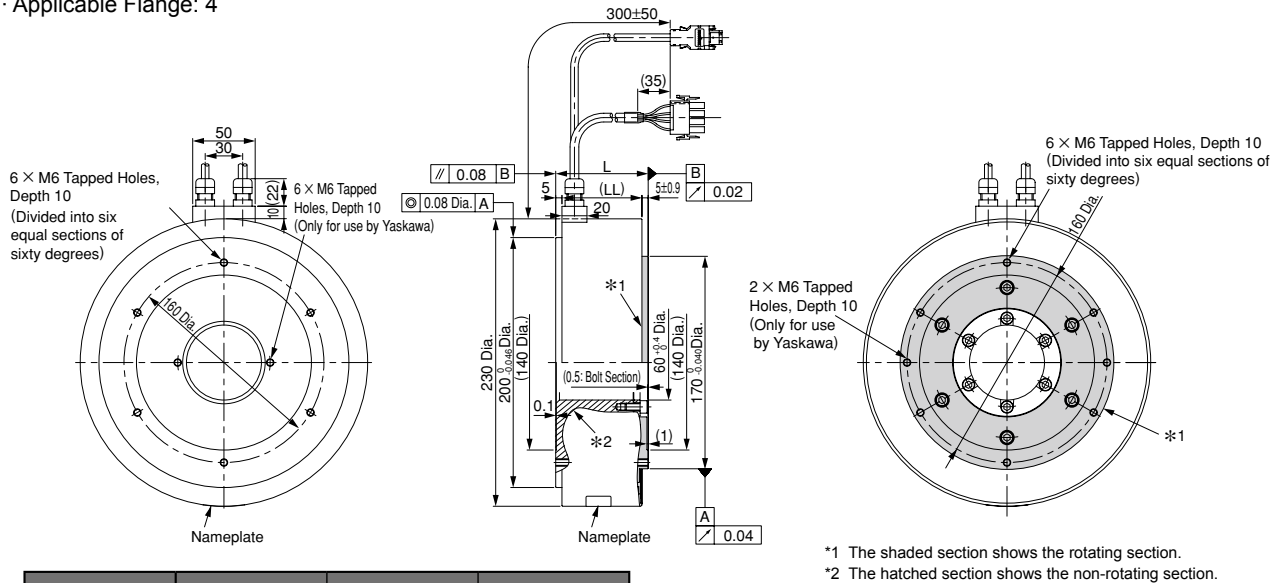

Model SGMCS-	L	(LL)	Approx. Mass kg
08D□C41	74	64	14.0
17D□C41	110	100	22.0
25D□C41	160	150	29.7

External Dimensions Units: mm

(4) Rated Torque 16.0 to 35.0 N·m (Outer Diameter 290 mm Inner Diameter 75 mm)

· Applicable Flange: 1

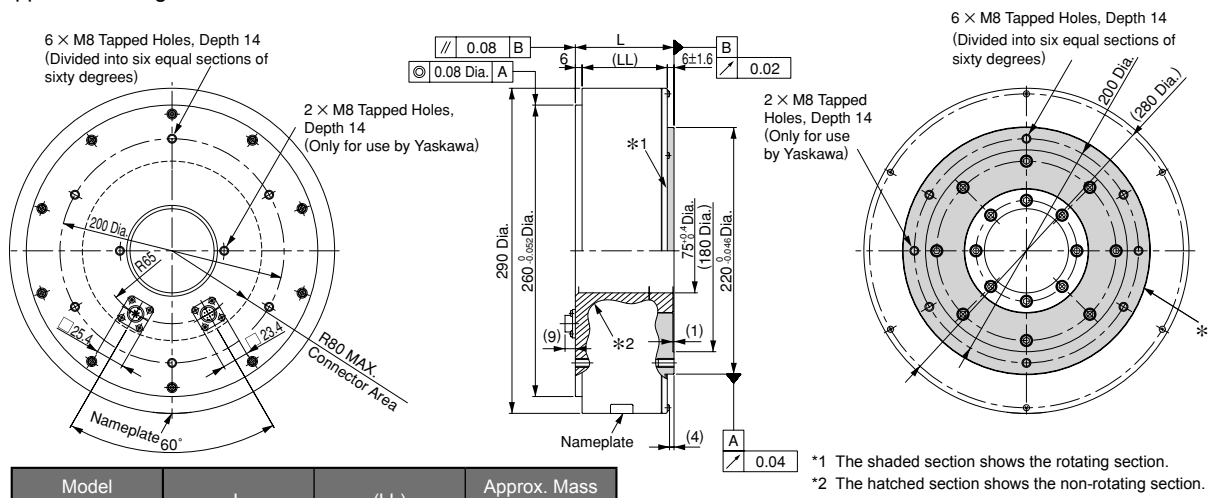

Model SGMCS-	L	(LL)	Approx. Mass kg
16E□B11	88	76	26.0
35E□B11	112	100	34.0

*1 The shaded section shows the rotating section.
*2 The hatched section shows the non-rotating section.

· Applicable Flange: 4

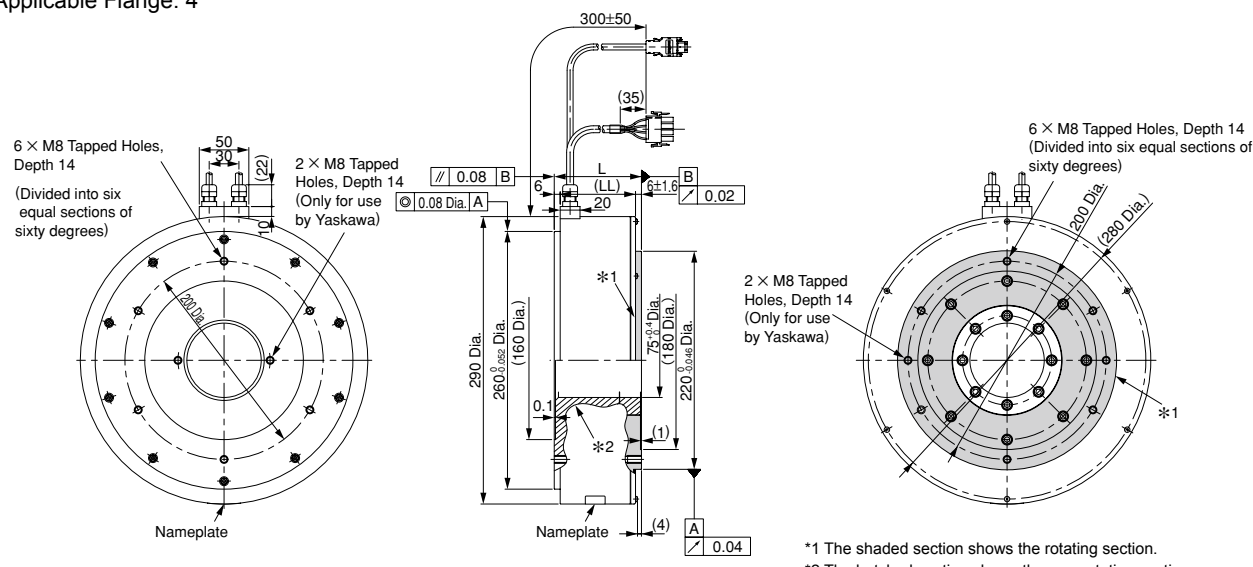

Model SGMCS-	L	(LL)	Approx. Mass kg
16E□B41	88	76	26.0
35E□B41	112	100	34.0

*1 The shaded section shows the rotating section.
*2 The hatched section shows the non-rotating section.

External Dimensions Units: mm

● Medium-capacity Series

(1) Rated Torque 45 to 110 N·m (Outer Diameter 280 mm, Inner Diameter 75 mm)

· Applicable Flange: 1

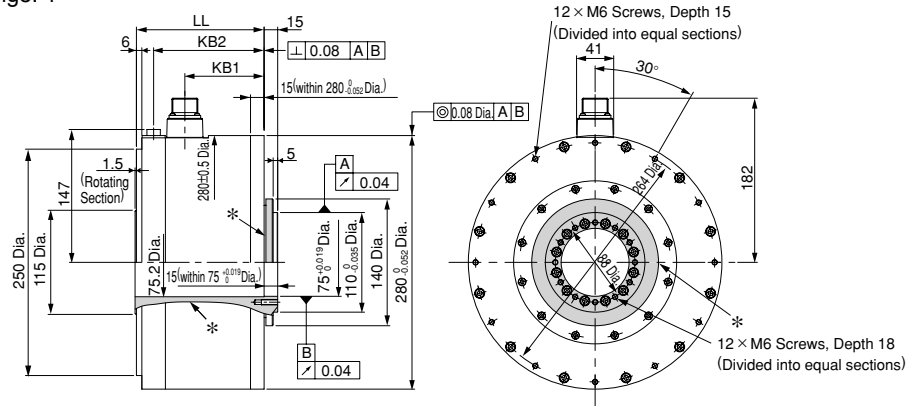

*: The shaded section shows the rotating section.

Model SGMCS-	LL	KB1	KB2	Approx. Mass kg
45M□A11	141	87.5	122	38
80M□A11	191	137.5	172	45
1AM□A11	241	187.5	222	51

· Applicable Flange: 3

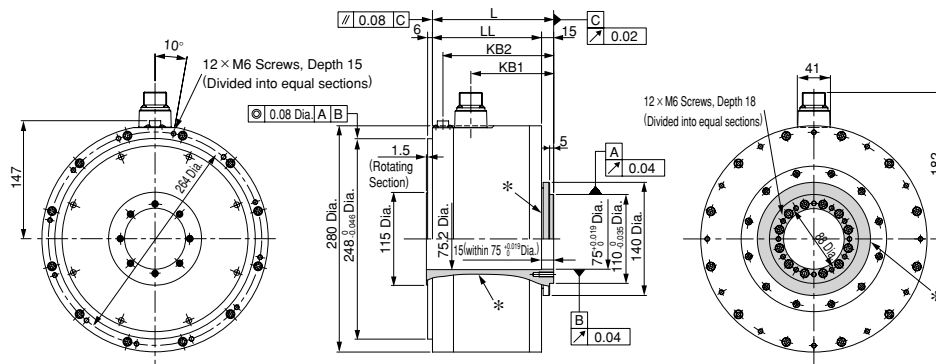

*: The shaded section shows the rotating section.

Model SGMCS-	L	LL	KB1	KB2	Approx. Mass kg
45M□A31	150	135	102.5	137	38
80M□A31	200	185	152.5	187	45
1AM□A31	250	235	202.5	237	51

● Servomotor Connector for Medium-capacity Series Servomotors (Applicable Flange: 1, 3)

Servomotor-end Connector Specifications
(Same for All Medium-capacity Models)

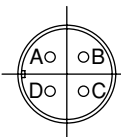

Model : CE05-2A18-10PD
 Manufacturer : DDK Ltd.
 Applicable plug and cable clamp
 Plug : CE05-6A18-10SD-B-BSS
 Cable clamp : CE3057-10A-□(D265)

A	Phase U
B	Phase V
C	Phase W
D	FG (Frame ground)

Encoder-end Connector Specifications
(Same for All Medium-capacity Models)

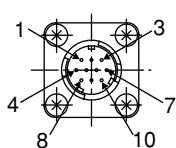

Model : JN1AS10ML1
 Manufacturer : Japan Aviation
 Electronics Industry, Ltd.
 Applicable plug : JN1DS10SL1

1	PS	6	-
2	/PS	7	FG (Frame ground)
3	-	8	-
4	PG5V	9	PG0V
5	-	10	-

External Dimensions Units: mm

(2) Rated Torque 80 to 200 N·m (Outer Diameter 360 mm, Inner Diameter 118 mm)

· Applicable Flange: 2

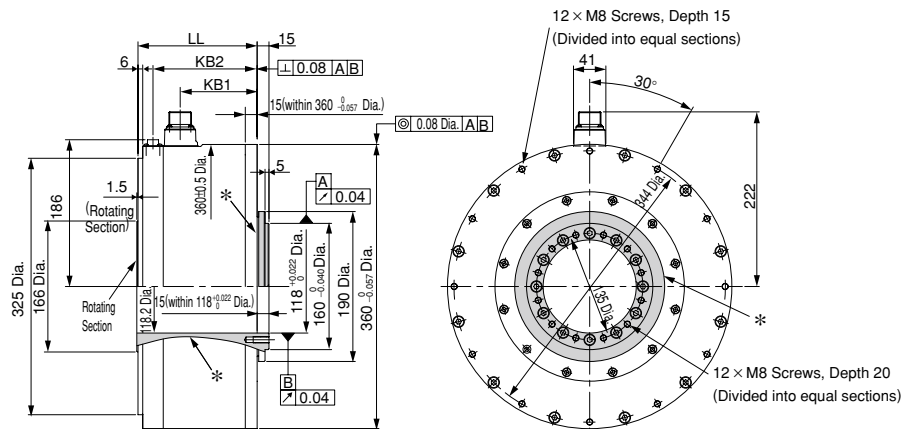

*: The shaded section shows the rotating section.

Model SGMCS-	LL	KB1	KB2	Approx. Mass kg
80N□A11	151	98	132	50
1EN□A11	201	148	182	68
2ZN□A11	251	198	232	86

· Applicable Flange: 3

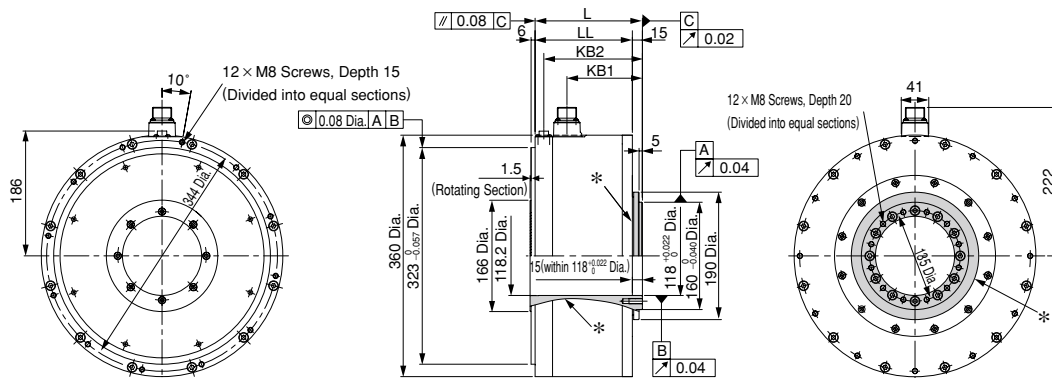

*: The shaded section shows the rotating section.

Model SGMCS-	L	LL	KB1	KB2	Approx. Mass kg
80N□A31	160	145	113	147	50
1EN□A31	210	195	163	197	68
2ZN□A31	260	245	213	247	86

Direct Drive Servomotors

Selecting Cables

● Cables Connections

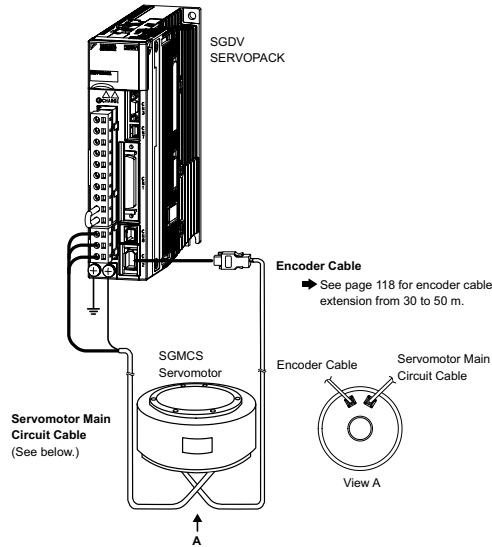

● Servomotor Main Circuit Cables

Name	Length (L)	Order No.		Specifications	Details	
		Standard Type	Flexible Type ¹			
Small Capacity (02B-35E)	Cable with Loose Wire at SERVOPACK End	3 m	JZSP-CMM60-03-E	JZSP-CSM60-03-E	Applicable Flange ² : 1 SERVOPACK End 50 mm L Servomotor End M4 Crimped Terminals	(1)
		5 m	JZSP-CMM60-05-E	JZSP-CSM60-05-E		
		10 m	JZSP-CMM60-10-E	JZSP-CSM60-10-E		
		15 m	JZSP-CMM60-15-E	JZSP-CSM60-15-E		
		20 m	JZSP-CMM60-20-E	JZSP-CSM60-20-E		
	Cables	3 m	JZSP-CMM00-03-E	JZSP-CMM01-03-E	Applicable Flange ² : 4 SERVOPACK End 8.5±0.5 (Exposed core wire) 50 L Servomotor End Sheath to Bind Core Wires Heat-shrinkable Tube M4 Crimped Terminals Cable: UL2517 (AWG20×4C) Cap : 350780-1(4-pole) Socket : 350536-6(Chained)	
		5 m	JZSP-CMM00-05-E	JZSP-CMM01-05-E		
		10 m	JZSP-CMM00-10-E	JZSP-CMM01-10-E		
		15 m	JZSP-CMM00-15-E	JZSP-CMM01-15-E		
		20 m	JZSP-CMM00-20-E	JZSP-CMM01-20-E		
Servomotor-end Connector		JN1DS04FK1		Soldered	(3)	
Cables		5 m	JZSP-CSM90-05-E	JZSP-CSM80-05-E	(4)	
Cables		10 m	JZSP-CSM90-10-E	JZSP-CSM80-10-E		
Cables		15 m	JZSP-CSM90-15-E	JZSP-CSM80-15-E		
Cables		20 m	JZSP-CSM90-20-E	JZSP-CSM80-20-E		
Cables		50 m	JZSP-CSM90-50-E	JZSP-CSM80-50-E		
		Value Type	Premium Type ^{3*}			
Medium Capacity (45M, 80M, 80N, 1AM)	Cable with Loose Wire at SERVOPACK End	3 m	B1EV-03(A)-E	B1EP-03(A)-E	L 125 mm	(2)
		5 m	B1EV-05(A)-E	B1EP-05(A)-E		
		10 m	B1EV-10(A)-E	B1EP-10(A)-E		
		15 m	B1EV-15(A)-E	B1EP-15(A)-E		
		20 m	B1EV-20(A)-E	B1EP-20(A)-E		
Medium Capacity (1EN, 2ZN)	Cable with Loose Wire at SERVOPACK End	3 m	B2EV-03(A)-E	B2EP-03(A)-E		
		5 m	B2EV-05(A)-E	B2EP-05(A)-E		
		10 m	B2EV-10(A)-E	B2EP-10(A)-E		
		15 m	B2EV-15(A)-E	B2EP-15(A)-E		
		20 m	B2EV-20(A)-E	B2EP-20(A)-E		

*1: Use flexible cables for movable sections such as robot arms.

*2: For applicable flanges, see model designations on page 105.

*3 Premium cables are intended for use in applications that require CE. They have a continuous flex rating and are intended for use in movable sections such as robot arms.

NOTES:

Shaded items are non-stock.

SGMCS servomotors with holding brakes are not available.

Selecting Cables

(1) Small Capacity Series: Wiring Specifications for Cables

• Applicable Flange: 1

SERVOPACK End		Servomotor End	
Wire Color	Signal	Signal	Pin No.
Red	Phase U	Phase U	1
White	Phase V	Phase V	2
Blue	Phase W	Phase W	3
Green/(yellow)	FG	FG	4

• Applicable Flange: 4

SERVOPACK End		Servomotor End	
Wire Color	Signal	Signal	Pin No.
Red	Phase U	Phase U	1
White	Phase V	Phase V	2
Blue	Phase W	Phase W	3
Green/(yellow)	FG	FG	4

(2) Medium Capacity Series: Wiring Specifications for Cables

• Value Type

SERVOPACK-end Leads		Servomotor-end Connector	
Wire Label	Signal	Signal	Pin No.
G	FG	FG	D
W	Phase W	Phase W	C
V	Phase V	Phase V	B
U	Phase U	Phase U	A

*For servomotors with holding brakes, the holding brake cable must also be wired.

• Premium Type

SERVOPACK-end Leads		Servomotor-end Connector	
Wire Label	Signal	Signal	Pin No.
G	FG	FG	D
W	Phase W	Phase W	C
V	Phase V	Phase V	B
U	Phase U	Phase U	A

*For servomotors with holding brakes, the holding brake cable must also be wired.

(3) Small-capacity Series: Servomotor-end Connector Specifications

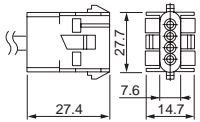
Items	Specifications
Manufacturer	Tyco Electronics AMP K.K.
Order No.	JZSP-CMM9-3-E
Cap	350780-1
Socket	350550-6
Applicable Wire Size	AWG20 to 14
Crimp Tool	Hand tool: 90296-2 Applicator: 687763-2
External Dimensions mm	

(4) Small-capacity Series: Cable Specifications

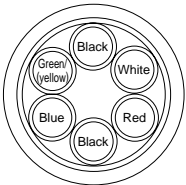
Items	Standard Type	Flexible Type
Order No.*	JZSP-CSM90-□□-E (50 m max.)	JZSP-CSM80-□□-E (50 m max.)
Specifications	UL2517 (Max. operating temperature: 105°C) AWG20×6C For power line: AWG20 (0.52 mm ²) Outer diameter of insulating sheath: 1.53 dia. mm For holding brake line: AWG20 (0.52 mm ²) Outer diameter of insulating sheath: 1.53 dia.mm	UL2517 (Max. operating temperature: 105°C) AWG22×6C For power line: AWG22 (0.33 mm ²) Outer diameter of insulating sheath: 1.37 dia. mm For holding brake line: AWG22 (0.33 mm ²) Outer diameter of insulating sheath: 1.37 dia. mm
Finished Dimensions	7 ± 0.3 mm	
Internal Configuration and Lead Color		
Yaskawa Standard Specifications (Standard Length)	Cable length : 5 m, 10 m, 15 m, 20 m, 50 m	

*: Specify the cable length □□ of order no.
Example: JZSP-CSM90-15-E (15 m)

Selecting Cables

(Medium-capacity Series (SGMCS-□□M and N): Connector Specifications

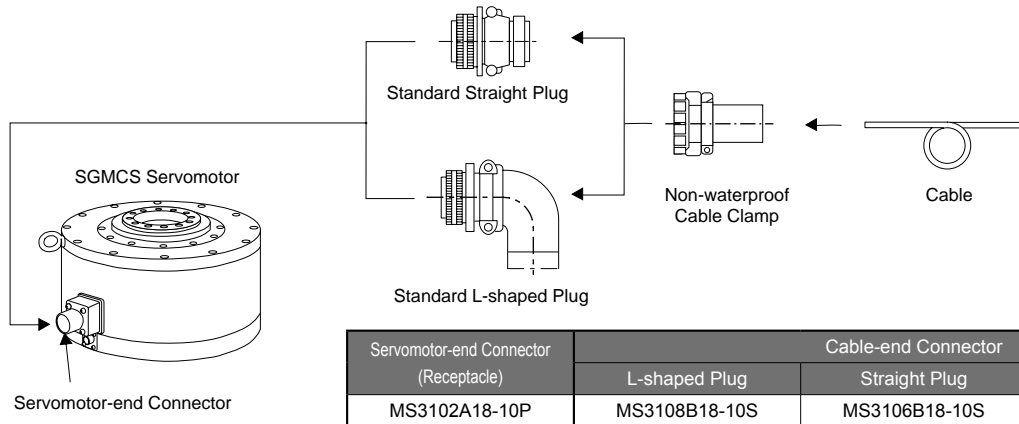

· Dimensional Drawings: MS3108B L-shaped Plug Shell

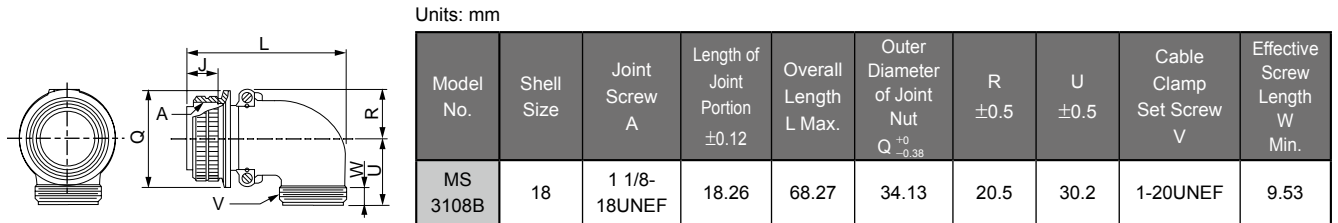

· Dimensional Drawings: MS3106B Straight Plug Shell

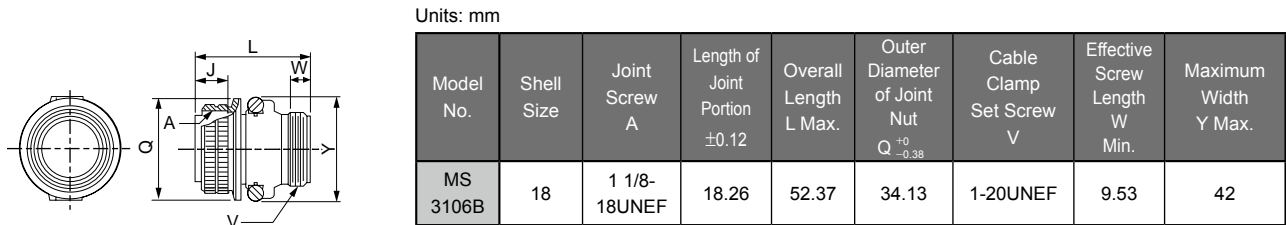

· Dimensional Drawings: MS3057-10A Cable Clamp with Rubber Bushing

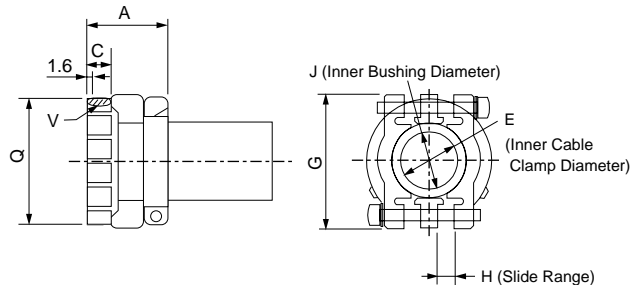





Units: mm

Model No.	Applicable Connector Shell Size	Overall Length A±0.7	Effective Screw Length C	E	G±0.7	H	J	Set Screw V	Outer Diameter Q±0.7	Attached Bushing
MS3057-10A	18	23.8	10.3	15.9	31.7	3.2	14.3	1-20UNEF	30.1	AN3420-10

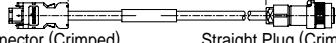
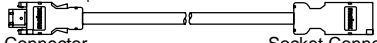
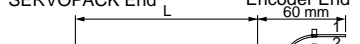
Selecting Cables

● Encoder Cables and Connectors (Max. length: 20 m)

Name	Length (L)	Order No.		Specifications	Details		
		Standard Type	Flexible Type*1				
Cable with Connectors (For Incremental and Absolute Encoder)	3 m	JZSP-CMP60-03-E	JZSP-CSP60-03-E	Applicable Flange*2: 1, 3 SERVOPACK End  Encoder (Servomotor) End Connector (Crimped) (Molex Japan Co., Ltd.) Straight Plug (Crimped) (Japan Aviation Electronics Industry, Ltd.)	(1)		
	5 m	JZSP-CMP60-05-E	JZSP-CSP60-05-E				
	10 m	JZSP-CMP60-10-E	JZSP-CSP60-10-E				
	15 m	JZSP-CMP60-15-E	JZSP-CSP60-15-E				
	20 m	JZSP-CMP60-20-E	JZSP-CSP60-20-E				
	3 m	JZSP-CMP00-03-E	JZSP-CMP10-03-E			Applicable Flange*2: 4 SERVOPACK End  Encoder End Connector (Molex Japan Co., Ltd.) Socket Connector (Molex Japan Co., Ltd.)	(2)
	5 m	JZSP-CMP00-05-E	JZSP-CMP10-05-E				
	10 m	JZSP-CMP00-10-E	JZSP-CMP10-10-E				
	15 m	JZSP-CMP00-15-E	JZSP-CMP10-15-E				
	20 m	JZSP-CMP00-20-E	JZSP-CMP10-20-E				
Cable with Loose Wire at Encoder End (For Incremental and Absolute Encoder)	3 m	JZSP-CMP03-03-E	JZSP-CMP13-03-E	SERVOPACK End  Encoder End 60 mm Connector (Crimped) (Molex Japan Co., Ltd.) Wire Markers	(3)		
	5 m	JZSP-CMP03-05-E	JZSP-CMP13-05-E				
	10 m	JZSP-CMP03-10-E	JZSP-CMP13-10-E				
	15 m	JZSP-CMP03-15-E	JZSP-CMP13-15-E				
	20 m	JZSP-CMP03-20-E	JZSP-CMP13-20-E				
SERVOPACK-end Connector Kit		JZSP-CMP9-1-E		Soldered  (Molex Japan Co., Ltd.)	(4)		
Encoder-end Connector (Straight Plug)		JN1DS10SL1				Crimping Type (A crimp tool is required.)  (Japan Aviation Electronics Industry, Ltd.)	
Encoder-end Connector (Socket Contact)		JN1-22-22S-PKG100					
Cables	5 m	JZSP-CMP09-05-E	JZSP-CSP39-05-E		(5)		
	10 m	JZSP-CMP09-10-E	JZSP-CSP39-10-E				
	15 m	JZSP-CMP09-15-E	JZSP-CSP39-15-E				
	20 m	JZSP-CMP09-20-E	JZSP-CSP39-20-E				

*1: Use flexible cables for movable sections such as robot arms.

*2: For applicable flanges, see model designations on page 105.

NOTE: Shaded items are non-stock.

(1) Wiring Specifications for Cable with Connectors

· Applicable Flange: 1, 3

(Standard type)

SERVOPACK End		Encoder (Servomotor) End	
Pin No.	Signal	Pin No.	Wire Color
1	PG5V	4	Red
2	PG0V	9	Black
5	PS	1	Light blue
6	/PS	2	Light blue/white
Shell	FG	7	FG Shield wire

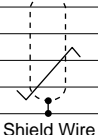

Note: Be sure to connect the shield wire of encoder cable to the connector case (shell).

(Flexible type)

SERVOPACK End		Encoder End	
Pin No.	Signal	Pin No.	Wire Color
1	PG5V	4	Orange
2	PG0V	9	Green
5	PS	1	Black/light blue
6	/PS	2	Red/light blue
Shell	FG	7	FG Shield wire

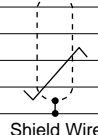

(2) Wiring Specifications for Cable with Connectors

· Applicable Flange: 4

(Standard type)

SERVOPACK End		Encoder (Servomotor) End	
Pin No.	Signal	Pin No.	Wire Color
1	PG5V	1	Red
2	PG0V	2	Black
5	PS	5	Light blue
6	/PS	6	Light blue/white
Shell	FG	7	FG Shield wire

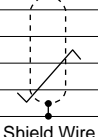

Note: Be sure to connect the shield wire of encoder cable to the connector case (shell).

(Flexible type)

SERVOPACK End		Encoder End	
Pin No.	Signal	Pin No.	Wire Color
1	PG5V	1	Orange
2	PG0V	2	Green
5	PS	5	Red/light blue
6	/PS	6	Black/light blue
Shell	FG	7	FG Shield wire

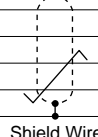

Selecting Cables

(3) Wiring Specifications for Cable with Loose Wire at Encoder End

(Standard type)

SERVOPACK End		Encoder (Servomotor) End	
Pin No.	Signal	Wire Color	Marker
6	/PS	Light blue/white	6
5	PS	Light blue	5
4	BAT(-)	Orange/white	4
3	BAT(+)	Orange	3
2	PG0V	Black	2
1	PG5V	Red	1
Shell	FG		

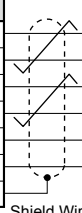

Shield Wire

(Flexible type)

SERVOPACK End		Encoder (Servomotor) End	
Pin No.	Signal	Wire Color	Marker
1	PG5V	Orange	1
2	PG0V	Green	2
3	BAT(+)	Red/pink	3
4	BAT(-)	Black/pink	4
5	PS	Red/light blue	5
6	/PS	Black/light blue	6
Shell	FG		

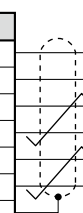

Shield Wire

Notes: 1 The signals BAT (+) and BAT (-) are not needed when using single turn absolute feedback.

2 Be sure to connect the shield wire of encoder cable to the connector case (shell).

(4) SERVOPACK-end Connector Specifications

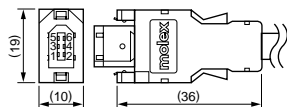
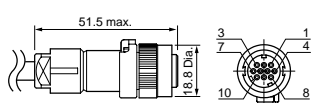
Items	SERVOPACK End	Encoder End
Order No.	JZSP-CMP9-1-E	Tools are not included.
Manufacturer	Molex Japan Co., Ltd.	Japan Aviation Electronics Industry, Ltd.
Connector	55100-0670 (soldered) Note: 55100-0670 (soldered) when using a connector kit	Straight plug: JN1DS10SL1 (crimped) Socket contact type: JN1-22-22S-PKG100 Outer diameter of applicable cable : 5.7 dia. to 7.3 dia. mm Applicable wire size: AWG21 to 25 Outer diameter of insulating sheath: 0.8 dia. to 1.5 dia. mm Crimp tool (hand tool) model: CT150-2-JN
External Dimensions (Units: mm)		

(5) Cable Specifications

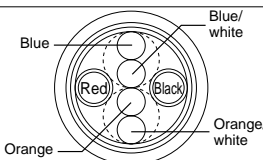
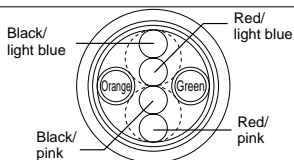
Items	Standard Type	Flexible Type
Order No.*	JZSP-CMP09-□□-E	JZSP-CSP39-□□-E
Cable Length	20 m max.	
Specifications	UL20276 (Rated temperature: 80°C) AWG22×2C+AWG24×2P AWG22 (0.33 mm ²) Outer diameter of insulating sheath: 1.15 dia. mm AWG24 (0.20 mm ²) Outer diameter of insulating sheath: 1.09 dia. mm	UL20276 (Rated temperature: 80°C) AWG22×2C+AWG24×2P AWG22 (0.33 mm ²) Outer diameter of insulating sheath: 1.35 dia. mm AWG24 (0.20 mm ²) Outer diameter of insulating sheath: 1.21 dia. mm
Finished Dimensions	6.5 dia. mm	6.8 dia. mm
Internal Configuration and Lead Colors		
Yaskawa Standard Specifications (Standard Length)	Cable length: 5 m, 10 m, 15 m, 20 m	

* Specify the cable length in □□ of order no.
Example: JZSP-CMP09-05-E (5 m)

Selecting Cables

● Relay Encoder Cables (For extending from 30 to 50 m)

Name	Length	Order No. Standard Type	Specifications	Details
Encoder-end Cables (For incremental and absolute encoder)	0.3 m	JZSP-CSP15-E		(1)
Cable with Connectors (For incremental and absolute encoder)	30 m	JZSP-UCMP00-30-E		(2)
	40 m	JZSP-UCMP00-40-E		
	50 m	JZSP-UCMP00-50-E		
Cables	30 m	JZSP-CMP19-30-E		(3)
	40 m	JZSP-CMP19-40-E		
	50 m	JZSP-CMP19-50-E		

(1) Wiring Specifications for Encoder-end Cable

SERVOPACK End		Encoder (Servomotor) End	
Pin No.	Signal	Pin No.	Wire Color
1	PG 5V	4	Red
2	PG 0V	9	Black
5	PS	1	Light blue
6	/PS	2	Light blue/white
Shell	FG	7	FG Shield wire

Note: Be sure to connect the shield wire of encoder cable to the connector case (shell).

(2) Wiring Specifications for Cable with Connectors

SERVOPACK End		Encoder (Servomotor) End	
Pin No.	Signal	Pin No.	Wire Color
6	/PS	6	Light blue/white
5	PS	5	Light blue
4	BAT (-)	4	Orange/white
3	BAT (+)	3	Orange
2	PG 0V	2	Black
1	PG 5V	1	Red
Shell	FG	Shell	FG

(3) Cable Specifications

Items	Standard Type
Order No.*	JZSP-CMP19-□□-E
Cable Length	50 m max.
Specifications	UL20276 (Rated temperature: 80°C) AWG16×2C+AWG26×2P AWG16 (1.31 mm ²) Outer diameter of insulating sheath: 2.0 dia.mm AWG26 (0.13 mm ²) Outer diameter of insulating sheath: 0.91 dia. mm
Finished Dimensions	6.8 dia. mm
Internal Configuration and Lead Colors	
Yaskawa Standard Specifications (Standard Length)	Cable length: 30 m, 40 m, 50 m

* Specify the cable length in □□ of order no.
Example: JZSP-CMP19-30-E (30 m)