

Linear Servomotors

SGLTW

(With T-type iron core)

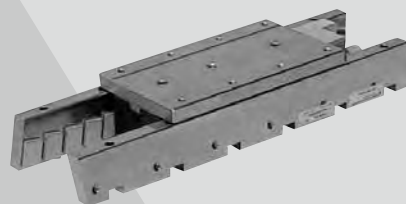

Model Designations

● Moving Coil (All Models are Non-Stock)

SGL T W - 20 A 170 A P □

Linear Σ Series

Servomotor Type

Code	Specifications
T	T-type iron core

W: Moving Coil

Magnet Height

Voltage

A: 200 VAC
D: 400 VAC

Length of Moving Coil

Design Revision Order

A, B, ...
H: High-efficiency Type

Connector for Main Circuit Cable

Code	Specification	Applicable Model
Blank	Connector by Tyco Electronics AMP K.K.	SGLTW
		-20A□□□□□□
		-35A□□□□□□
D	MS connector	SGLTW
		-40□□□□B□
		-80□□□□B□
D	Connector by Interconnectron GmbH	SGLTW
		-35D□□□□H□
		-50D□□□□H□

Hall Sensor

Code	Specifications
P	With hall sensor
Blank	Without hall sensor

Note: Shaded items are non-stock

● Magnetic Way (All Models are Non-Stock)

SGL T M - 20 324 A □

Linear Σ Series

Linear Servomotor

Servomotor Type

Code	Specifications
T	T-type iron core

M: Magnetic Way

Magnet Height

Length of Magnetic Way

Options

Code	Specifications	Applicable Model
Blank	Standard	All models
C	With magnet cover	Models with core
Y	With base and magnet cover	SGLTM-20, -35, -40, -80(Note)

Note: Not available for these models: the SGLTM-35□□□□H and the SGLTM-50□□□□H.

Design Revision Order

A, B, ...
H: High-efficiency Type

- Direct-feed mechanism for high-speed and high-precision positioning.
- Yaskawa's unique construction principles of the TW linear motors negate the effects of the magnetic attraction force between the relative motor members.
- Lack of magnetic attraction helps to extend the life of the linear motion guides and to minimize operation noise.
- Very little cogging.

- Feeders and loaders
- Mounters
- Machine tools

● Precautions on Moving Coil with Hall Sensor

When using a moving coil with a hall sensor, the magnetic way must completely cover the bottom of the hall sensor. Refer to the example showing the correct installation.

When determining the length of the moving coil's stroke or the length of the magnetic way, consider the total length of the moving coil and the hall sensor unit. Refer to the following table.

< Correct >

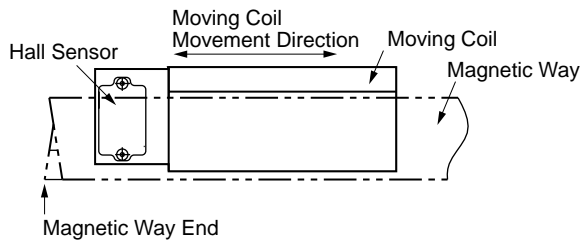

< Incorrect >

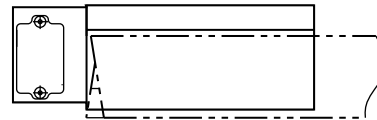

The total length of moving coil with hall sensor

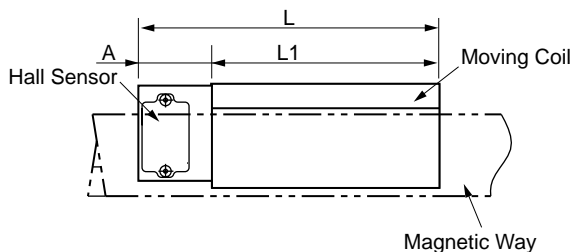

Moving Coil Model	Length of Moving Coil L1 (mm)	Length of Hall Sensor Unit A (mm)	Total Length L (mm)	
20A170AP□	170	34	204	
20A320AP□	315		349	
20A460AP□	460		494	
35A170AP□	170	34	204	
35A320AP□	315		349	
35A460AP□	460		494	
35□170HP□	170	34	204	
35□320HP□	315		349	
50□170HP□	170		204	
50□320HP□	315	34	349	
40A400AP□	395		26	421
40A600AP□	585		36	621
80A400AP□	395	26	421	
80A600AP□	585		621	
40□400BP□	395		421	
40□600BP□	575	26	601	
80□400BP□	395		421	
80□600BP□	575		601	

Ratings and Specifications

Time Rating: Continuous

Insulation Resistance: 500 VDC, 10 MΩ min.

Ambient Temperature: 0 to 40°C

Excitation: Permanent magnet

Withstand Voltage: 1500 VAC for one minute

Enclosure: Self-cooled

Ambient Humidity: 20% to 80% (no condensation)

Allowable Winding Temperature: 130°C (Thermal class B)

200-V Class

Linear Servomotor Model SGLTW- 		Standard Type										High-efficiency Type			
		20A			35A			40A		80A		35A		50A	
		170A	320A	460A	170A	320A	460A	400B	600B	400B	600B	170H	320H	170H	320H
Peak Speed	m/s	5	5	5	5	5	5	3.1	3.1	2.5	2.5	4.8	4.8	3.2	3.1
Rated Force*	N	130	250	380	220	440	670	670	1000	1300	2000	300	600	450	900
Rated Current*	A _{rms}	2.3	4.4	6.7	3.5	7	10.7	7.3	10.9	11.1	17.1	5.1	10.1	4.9	9.8
Peak Force*	N	380	760	1140	660	1320	2000	2600	4000	5000	7500	600	1200	900	1800
Peak Current*	A _{rms}	7.7	15.4	23.2	12.1	24.2	36.7	39.4	60.6	57.9	86.9	11.9	23.9	11.5	22.9
Moving Coil Mass	kg	2.5	4.6	6.7	3.7	6.8	10	15	23	24	35	4.9	8.8	6	11
Force Constant	N/A _{rms}	61	61	61	67.5	67.5	67.5	99.1	99.1	126	126	64	64	98.5	98.5
BEMF Constant	V/(m/s)	20.3	20.3	20.3	22.5	22.5	22.5	33	33	42	42	21.3	21.3	32.8	32.8
Motor Constant	N/√w	18.7	26.5	32.3	26.7	37.5	46.4	61.4	75.2	94.7	116	37.4	52.9	50.3	71.1
Electrical Time Constant	ms	5.9	5.9	5.9	6.9	6.8	7	15.2	15.2	17	17	15.1	15.1	16.5	16.5
Mechanical Time Constant	ms	7.5	6.5	6.4	5.2	4.8	4.6	4	4	3	3	3.3	3.3	2.8	2.8
Thermal Resistance (With Heat Sink)	K/W	1.01	0.49	0.38	0.76	0.44	0.32	0.24	0.2	0.22	0.18	0.76	0.4	0.61	0.3
Thermal Resistance (Without Heat Sink)	K/W	1.82	1.11	0.74	1.26	0.95	0.61	0.57	0.4	0.47	0.33	1.26	0.83	0.97	0.8
Magnetic Attraction ^{*1}	N	0	0	0	0	0	0	0	0	0	0	0	0	0	0
Magnetic Attraction(on one side) ^{*2}	N	800	1590	2380	1400	2780	4170	3950	5890	7650	11400	1400	2780	2000	3980
Applicable SERVOPACK	SGDV-	3R8A	7R6A	120A	5R5A	120A	180A	180A	330A	330A	550A	5R5A	120A	5R5A	120A

*1 : The unbalanced magnetic gap resulted from the moving coil installation condition causes a magnetic attraction on the moving coil.

*2 : The value indicates the magnetic attraction generated on one side of the magnetic way.

Notes: 1 The items marked with an * and Force and Speed Characteristics (on the next page) are the values at a motor winding temperature of 100°C during operation in combination with a SERVOPACK. The others are at 20°C.

2 The above specifications show the values under the cooling condition when a heat sink (aluminum board) listed in the following table is mounted on the moving coil.

Heat Sink Size	254 mm×254 mm×25 mm : SGLTW-20A170A,-35A170A
	400 mm×500 mm×40 mm : SGLTW-20A320A,-20A460A,-35A170H,-35A320A,-35A320H,-35A460A,-50A170H
	609 mm×762 mm×50 mm : SGLTW-40A400B,-40A600B,-50A320H,-80A400B,-80A600B

400-V Class

Linear Servomotor Model SGLTW- 		Standard Type				High-efficiency Type			
		40D		80D		35D		50D	
		400B	600B	400B	600B	170H	320H	170H	320H
Peak Speed	m/s	3.1	3.1	3.1	3.1	5	5	4	4
Rated Force*	N	670	1000	1300	2000	300	600	450	900
Rated Current*	A _{rms}	3.7	5.5	7.2	11.1	3.2	6.5	3.2	6.3
Peak Force*	N	2600	4000	5000	7500	600	1200	900	1800
Peak Current*	A _{rms}	20.7	30.6	37.6	56.4	7.7	15.5	7.4	14.8
Moving Coil Mass	kg	15	23	24	35	4.7	8.8	6	11
Force Constant	N/A _{rms}	196.1	196.1	194.4	194.4	99.6	99.6	153.3	153.3
BEMF Constant	V/(m/s)	65.4	65.4	64.8	64.8	33.2	33.2	51.1	51.1
Motor Constant	N/√w	59.6	73	85.9	105.2	36.3	51.4	48.9	69.1
Electrical Time Constant	ms	14.3	14.4	15.6	15.6	14.3	14.4	15.6	15.6
Mechanical Time Constant	ms	4.3	4.2	3.2	3.2	3.5	3.3	2.5	2.5
Thermal Resistance (With Heat Sink)	K/W	0.24	0.2	0.22	0.18	0.76	0.4	0.61	0.3
Thermal Resistance (Without Heat Sink)	K/W	0.57	0.4	0.47	0.33	1.26	0.83	0.97	0.8
Magnetic Attraction ^{*1}	N	0	0	0	0	0	0	0	0
Magnetic Attraction(on one side) ^{*2}	N	3950	5890	7650	11400	1400	2780	2000	3980
Applicable SERVOPACK	SGDV-	120D	170D	170D	260D	3R5D	8R4D	3R5D	8R4D

*1 : The unbalanced magnetic gap resulted from the moving coil installation condition causes a magnetic attraction on the moving coil.

*2 : The value indicates the magnetic attraction generated on one side of the magnetic way.

Notes: 1 The items marked with an * and Force and Speed Characteristics are the values at a motor winding temperature of 100°C during operation in combination with a SERVOPACK. The others are at 20°C.

2 The above specifications show the values under the cooling condition when a heat sink (aluminum board) listed in the following table is mounted on the moving coil.

Heat Sink Size	400 mm×500 mm×40 mm : SGLTW-35D170H,-35D320H,-50D170H
	609 mm×762 mm×50 mm : SGLTW-40D400B,-40D600B,-50D320H,-80D400B,-80D600B

Ratings and Specifications

● Force and Speed Characteristics **A** : Continuous Duty Zone **B** : Intermittent Duty Zone

200-V Class Standard Type

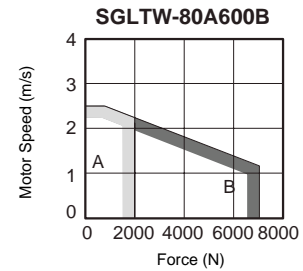
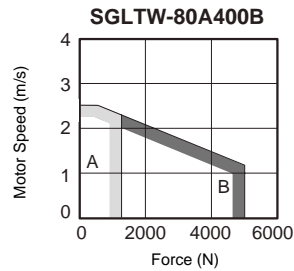
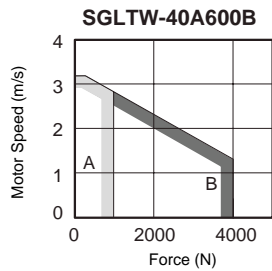
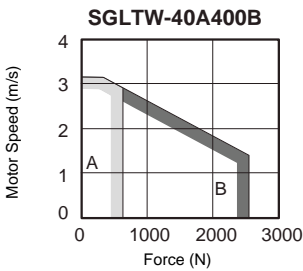
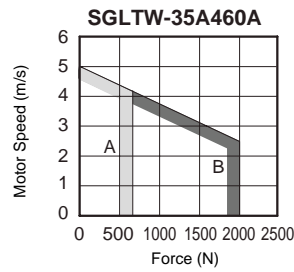
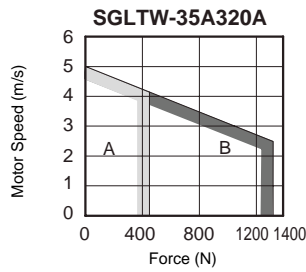
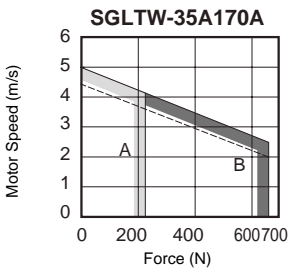
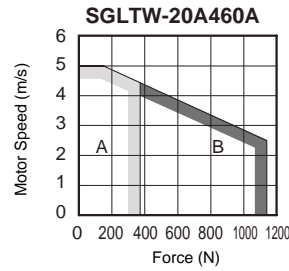
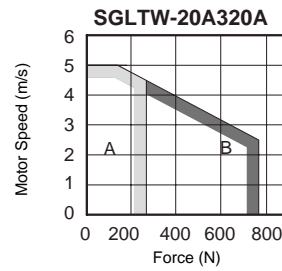
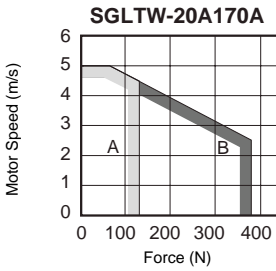

200-V Class High-efficiency Type

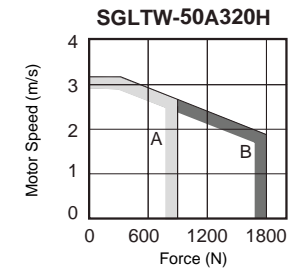
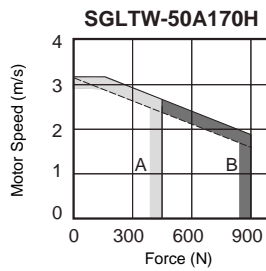
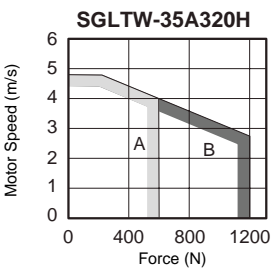
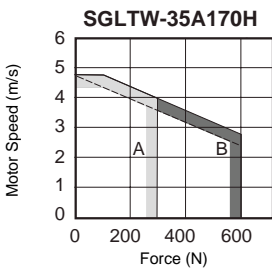

Note: When the effective force during intermittent duty is within the rated force, the servomotor can be used within the intermittent duty zone.

Linear Servomotors

Ratings and Specifications

● Force and Speed Characteristics (cont'd) A : Continuous Duty Zone B : Intermittent Duty Zone

400-V Class Standard Type

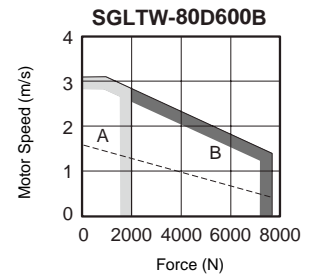
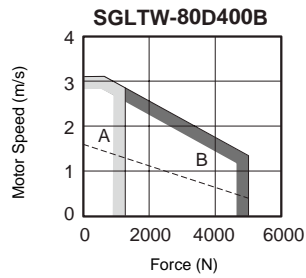
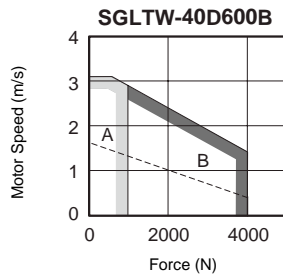
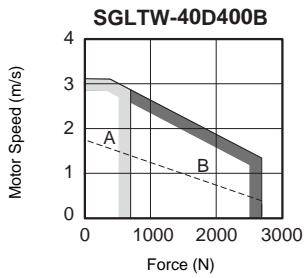

400-V Class High-efficiency Type

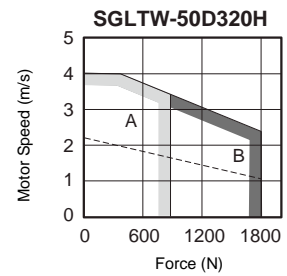
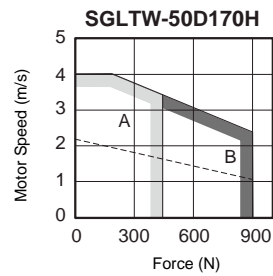
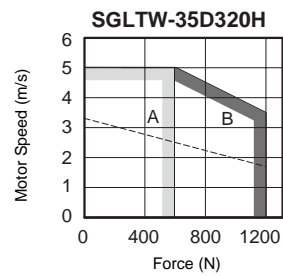
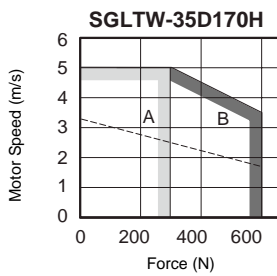

Notes: 1 When the effective force during intermittent duty is within the rated force, the servomotor can be used within the intermittent duty zone.

2 The dotted line indicates the characteristics when a 400-VAC linear servomotor is used with 200-V input power supply. In this case, a serial converter unit is required. Contact your Yaskawa representative for details.

● Mechanical Specifications

(1) Impact Resistance

- Impact acceleration: 196 m/s²
- Impact occurrences: twice

(2) Vibration Resistance

The linear servomotors will withstand the following vibration acceleration in three directions: Vertical, side to side, and front to back.

- Vibration acceleration: 49 m/s²

External Dimensions Units: mm

(1) Standard Type SGLTW-20

- Moving Coil: SGLTW-20A□□□A□ (With a connector by Tyco Electronics AMP K.K.)

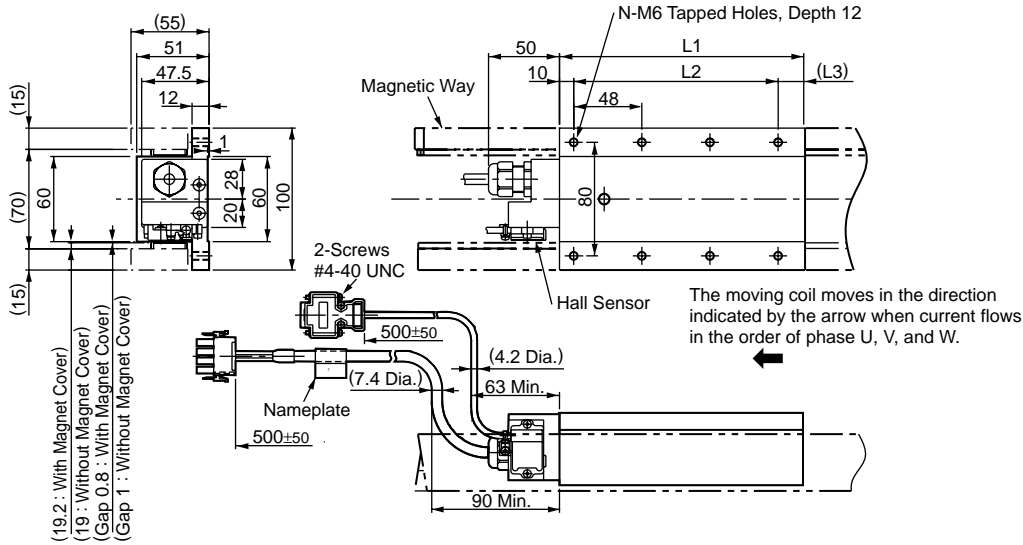

Hall Sensor Connector Specifications

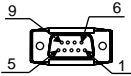

Pin Connector:
17JE-23090-02 (D8C)
by DDK Ltd.

The Mating Connector
Socket Connector:
17JE-13090-02 (D8C)
Stud: 17L-002C or
17L-002C1

Pin No.	Signal
1	+5VDC
2	Phase U
3	Phase V
4	Phase W
5	0V
6	Not used
7	Not used
8	Not used
9	Not used

Linear Servomotor Connector Specifications

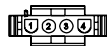

Plug: 350779-1
Pin : 350218-3 or
350547-3 (No.1 to 3)
350654-1
350669-1 (No.4)
by Tyco Electronics AMP K.K.

The Mating Connector
Cap : 350780-1
Socket: 350536-3 or
350550-3

Pin No.	Signal	Wire Color
1	Phase U	Red
2	Phase V	White
3	Phase W	Black
4	Ground	Green

Hall Sensor Output Signals

When the moving coil moves in the direction indicated by the arrow in the figure, the relationship between the hall sensor output signals S_u , S_v , S_w and the inverse power of each motor phase V_u , V_v , V_w becomes as shown in the figure below.

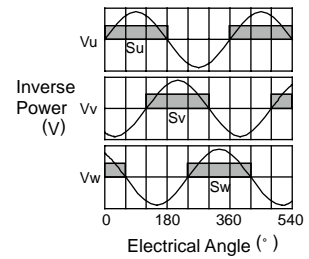

Moving Coil Model SGLTW-	L1	L2	(L3)	N	Approx. Mass kg
20A170A□	170	144 (48×3)	(16)	8	2.5
20A320A□	315	288 (48×6)	(17)	14	4.6
20A460A□	460	432 (48×9)	(18)	20	6.7

External Dimensions Units: mm

● Magnetic Way : SGLTM-20□□□A□

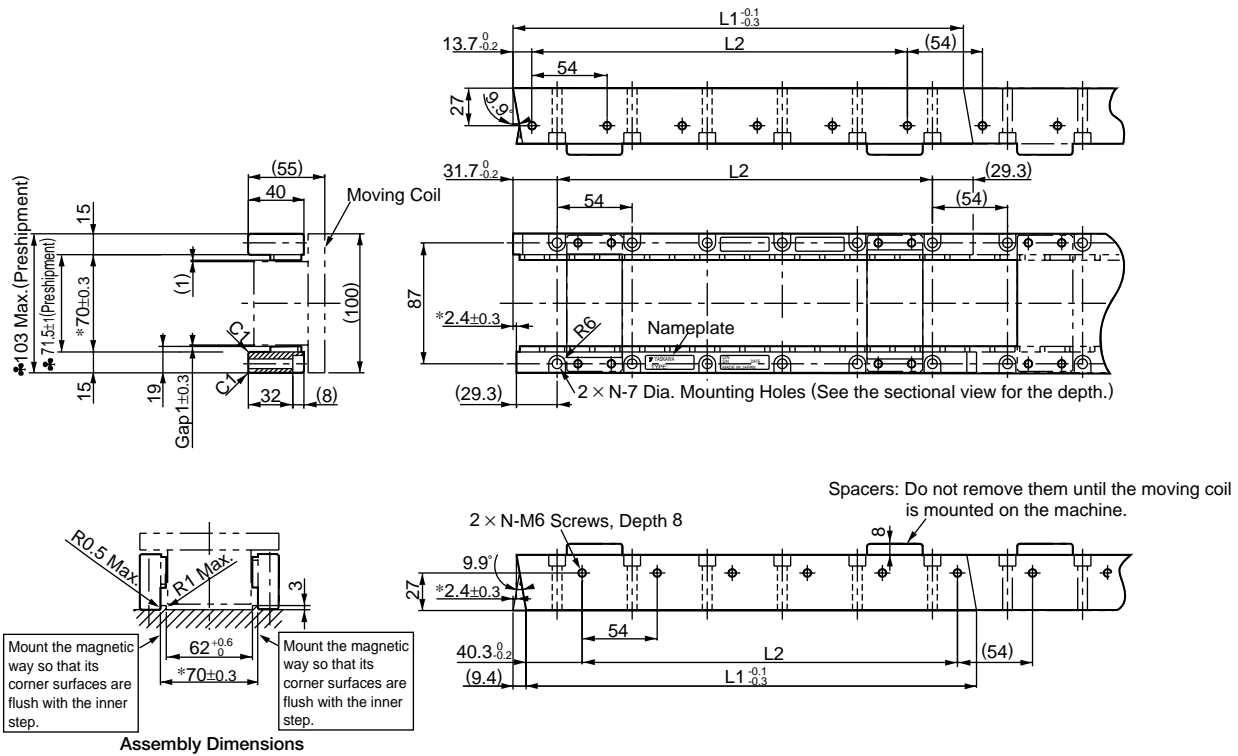

- Notes: 1 Two magnetic ways for both ends of moving coil make one set. Spacers are mounted on magnetic ways for safety during transportation. Do not remove the spacers until the moving coil is mounted on a machine.
 2 If you have a pacemaker or any other electronic medical device, do not go near the magnetic way of the linear servomotor.
 3 Two magnetic ways in a set can be connected to each other.
 4 The dimensions marked with an * are the dimensions between the magnetic ways. Be sure to follow exactly the dimensions specified in the figure above. Mount magnetic ways as shown in Assembly Dimensions. The values with a ♣ are the dimensions at preshipment.
 5 Use socket headed screws of strength class 10.9 minimum for magnetic way mounting screws. Do not use stainless steel screws.

Magnetic Way Model SGLTM-	L1 ^{0.1} _{0.3}	L2	N	Approx. Mass kg
20324A□	324	270 (54×5)	6	3.4
20540A□	540	486 (54×9)	10	5.7
20756A□	756	702 (54×13)	14	7.9

External Dimensions Units: mm

- Magnetic Way with Base: SGLTM-20□□□AY

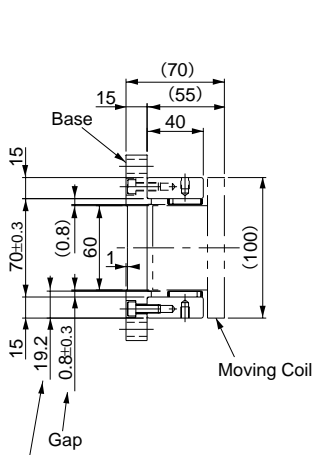

Includes a 0.2 thick magnet cover.

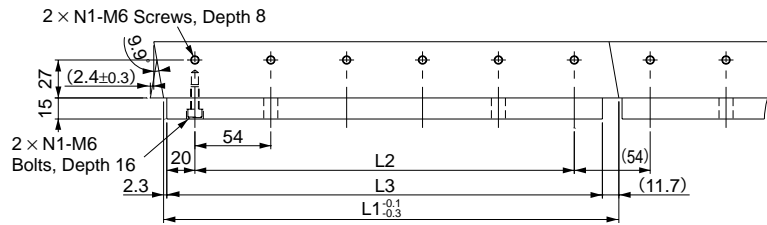
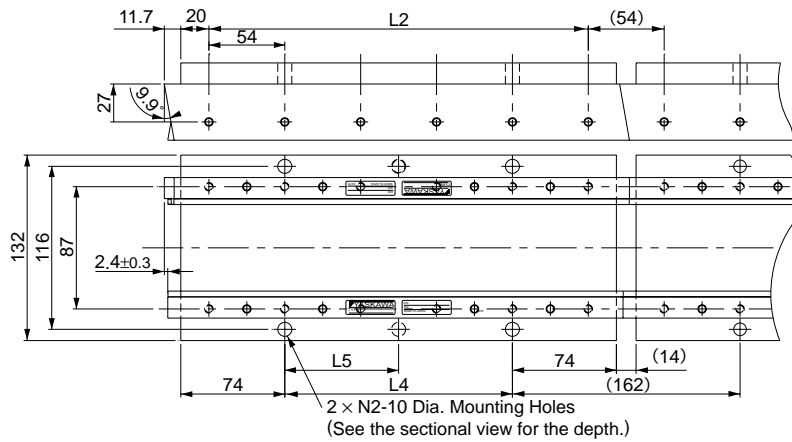

- Notes:
- 1 If you have a pacemaker or any other electronic medical device, do not go near the magnetic way of the linear servomotor.
 - 2 Two magnetic ways in a set can be connected to each other.
 - 3 The characteristics of the magnetic way with base are the same as of the magnetic way without base (SGLTM-20□□□A).

Magnetic Way Model SGLTM-	L1	L2	L3	L4	L5	N1	N2	Approx. Mass kg
20324AY	324	270	310	162	162	6	2	5.1
20540AY	540	486	526	378	189	10	3	8.5
20756AY	756	702	742	594	198	14	4	12

Linear Servomotors

External Dimensions Units: mm

(2) Standard Type SGLTW-35A

- Moving Coil: SGLTW-35A□□□A□ (With a connector by Tyco Electronics AMP K.K.)

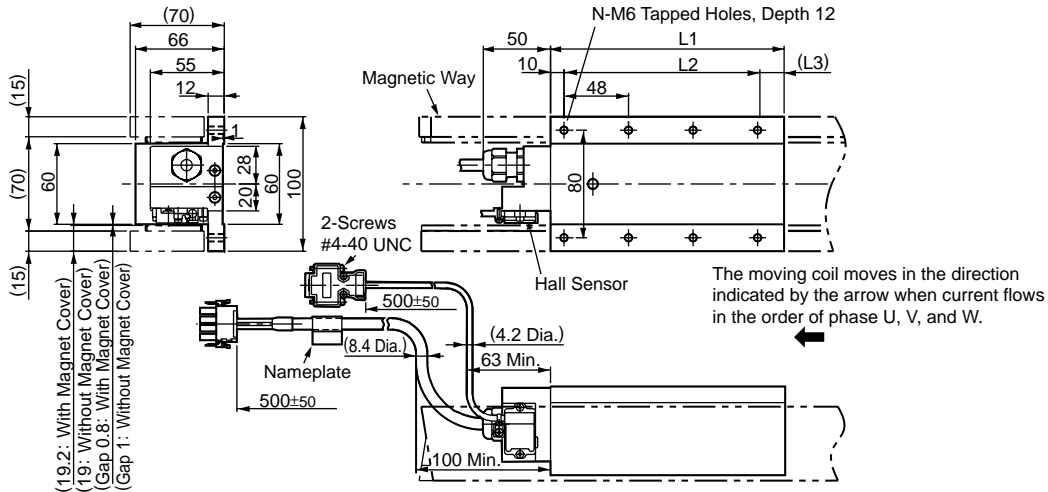

Hall Sensor Connector Specifications

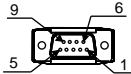

Pin Connector:
17JE-23090-02 (D8C)
by DDK Ltd.

The Mating Connector

Socket Connector:
17JE-13090-02 (D8C)
Stud: 17L-002C or
17L-002C1

Pin No.	Signal
1	+5VDC
2	Phase U
3	Phase V
4	Phase W
5	0V
6	Not used
7	Not used
8	Not used
9	Not used

Linear Servomotor Connector Specifications

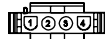

Plug: 350779-1
Pin : 350218-3 or
350547-3 (No.1 to 3)
350654-1
350669-1 (No.4)
by Tyco Electronics AMP K.K.

The Mating Connector

Cap : 350780-1
Socket: 350536-3 or
350550-3

Pin No.	Signal	Wire Color
1	Phase U	Red
2	Phase V	White
3	Phase W	Black
4	Ground	Green

Hall Sensor Output Signals

When the moving coil moves in the direction indicated by the arrow in the figure, the relationship between the hall sensor output signals S_u , S_v , S_w and the inverse power of each motor phase V_u , V_v , V_w becomes as shown in the figure below.

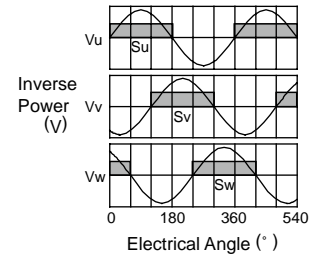

Moving Coil Model SGLTW-	L1	L2	(L3)	N	Approx. Mass kg
35A170A□	170	144 (48×3)	(16)	8	3.7
35A320A□	315	288 (48×6)	(17)	14	6.8
35A460A□	460	432 (48×9)	(18)	20	10

External Dimensions Units: mm

- Magnetic Way: SGLTM-35□□□A□

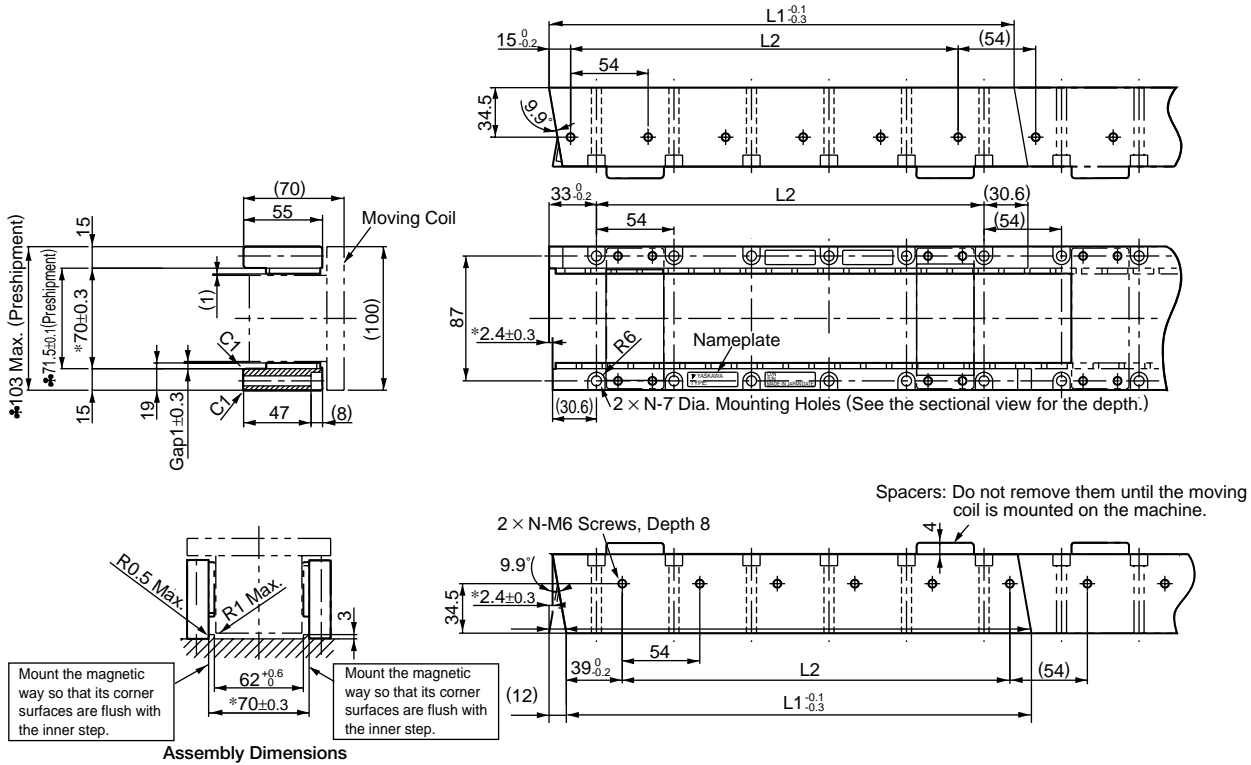

- Notes:
- 1 Two magnetic ways for both ends of moving coil make one set. Spacers are mounted on magnetic ways for safety during transportation. Do not remove the spacers until the moving coil is mounted on a machine.
 - 2 If you have a pacemaker or any other electronic medical device, do not go near the magnetic way of the linear servomotor.
 - 3 Two magnetic ways in a set can be connected to each other.
 - 4 The dimensions marked with an * are the dimensions between the magnetic ways. Be sure to follow exactly the dimensions specified in the figure above. Mount magnetic ways as shown in Assembly Dimensions. The values with a ♣ are the dimensions at preshipment.
 - 5 Use socket headed screws of strength class 10.9 minimum for magnetic way mounting screws. Do not use stainless steel screws.

Magnetic Way Model SGLTM-	L1 ^{-0.1} _{0.3}	L2	N	Approx. Mass kg
35324A□	324	270 (54×5)	6	4.8
35540A□	540	486 (54×9)	10	8
35756A□	756	702 (54×13)	14	11

External Dimensions Units: mm

● Magnetic Way with Base: SGLTM-35□□□AY

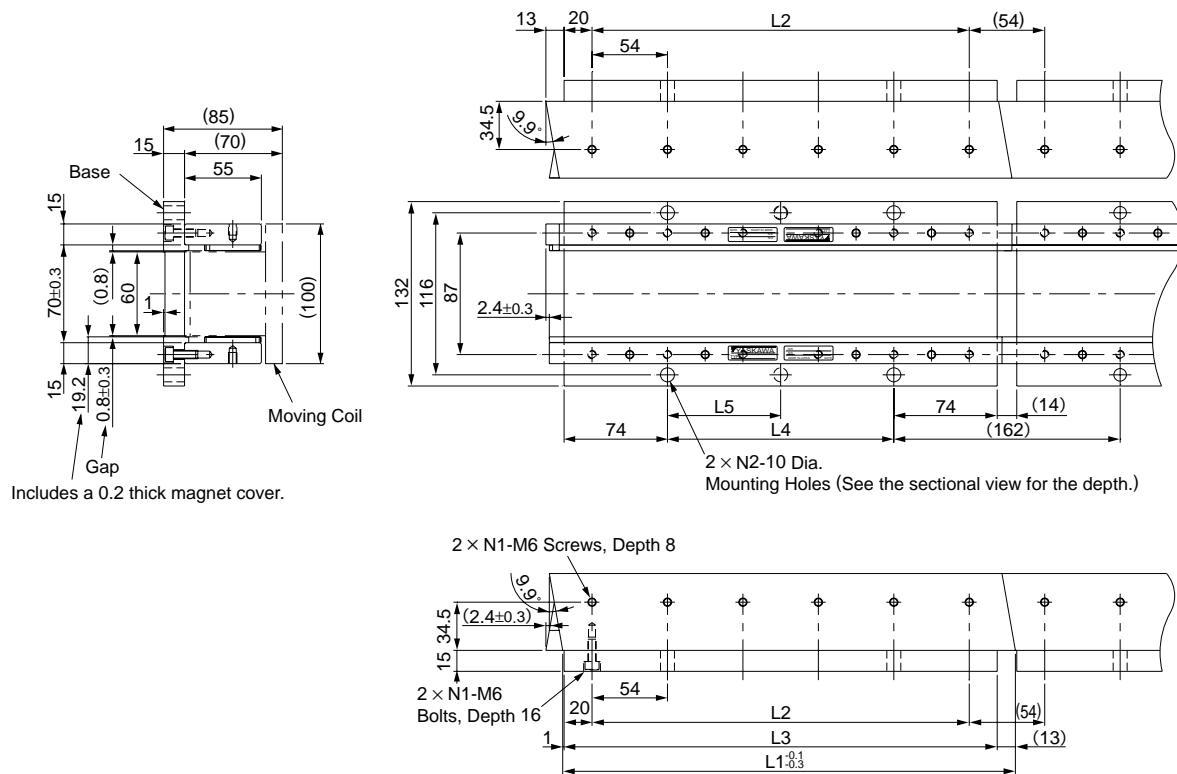

- Notes: 1 If you have a pacemaker or any other electronic medical device, do not go near the magnetic way of the linear servomotor.
 2 Two magnetic ways in a set can be connected to each other.
 3 The characteristics of the magnetic way with base are the same as of the magnetic way without base (SGLTM-35□□□A).

Magnetic Way Model SGLTM-	L1	L2	L3	L4	L5	N1	N2	Approx. Mass kg
35324AY	324	270	310	162	162	6	2	6.4
35540AY	540	486	526	378	189	10	3	11
35756AY	756	702	742	594	198	14	4	15

External Dimensions Units: mm

(3) Standard Type SGLTW-40

- Moving Coil: SGLTW-40□□□□B□ (With an MS connector)

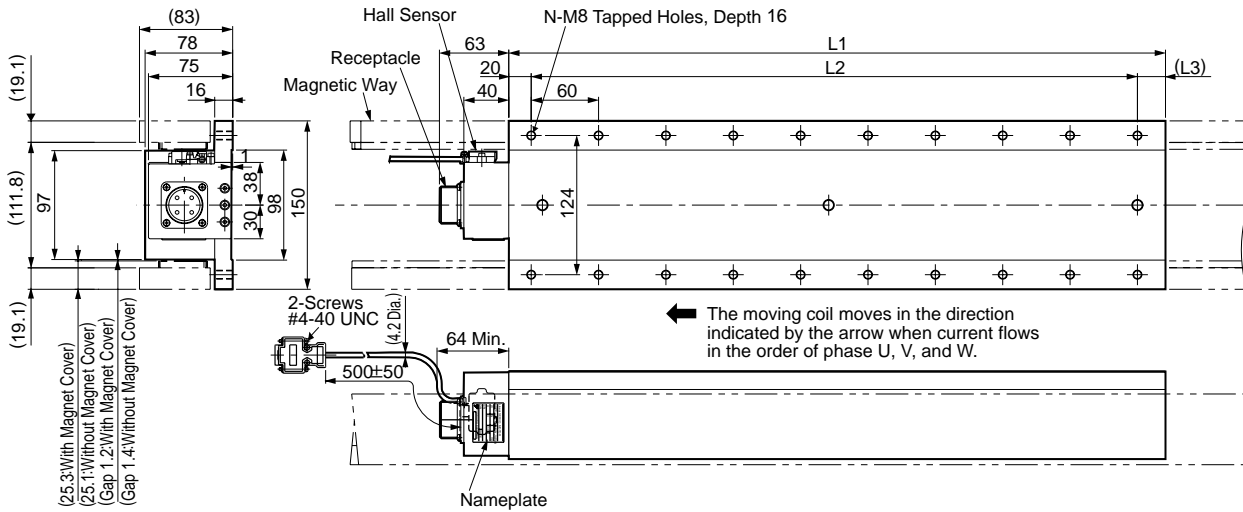

Hall Sensor Connector Specifications

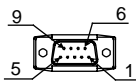

Pin Connector:
17JE-23090-02 (D8C)
by DDK Ltd.

The Mating Connector

Socket Connector:
17JE-13090-02 (D8C)
Stud: 17L-002C or
17L-002C1

Pin No.	Signal
1	+5VDC
2	Phase U
3	Phase V
4	Phase W
5	0V
6	Not used
7	Not used
8	Not used
9	Not used

Linear Servomotor Connector Specifications



Receptacle type: MS3102A-22-22P
□ by DDK Ltd.

The Mating Connector

L-shaped plug type : MS3108B22-22S
Straight plug type : MS3106B22-22S
Cable clamp type : MS3057-12A

Pin No.	Signal
A	Phase U
B	Phase V
C	Phase W
D	Ground

Hall Sensor Output Signals

When the moving coil moves in the direction indicated by the arrow in the figure, the relationship between the hall sensor output signals S_u , S_v , S_w and the inverse power of each motor phase V_u , V_v , V_w becomes as shown in the figure below.

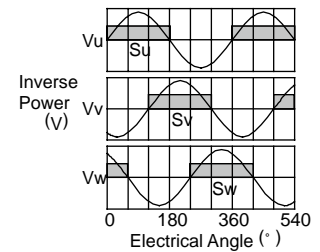

Moving Coil Model SGLTW-	L1	L2	(L3)	N	Approx. Mass kg
40□400B□	395	360(60×6)	(15)	14	15
40□600B□	575	540(60×9)	(15)	20	22

External Dimensions Units: mm

- Magnetic Way : SGLTM-40□□□A□

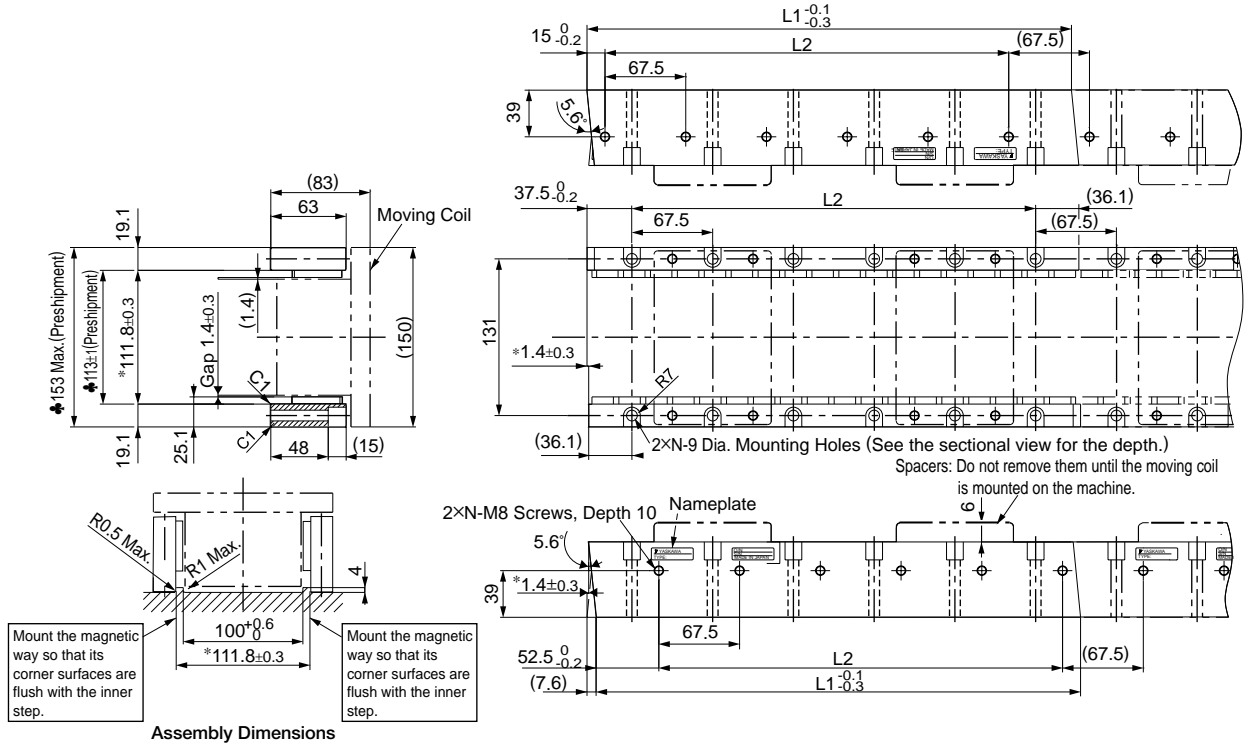

- Notes: 1 Two magnetic ways for both ends of moving coil make one set. Spacers are mounted on magnetic ways for safety during transportation. Do not remove the spacers until the moving coil is mounted on a machine.
- 2 If you have a pacemaker or any other electronic medical device, do not go near the magnetic way of the linear servomotor.
- 3 Two magnetic ways in a set can be connected to each other.
- 4 The dimensions marked with an * are the dimensions between the magnetic ways. Be sure to follow exactly the dimensions specified in the figure above. Mount magnetic ways as shown in Assembly Dimensions. The values with a ♣ are the dimensions at preshipment.
- 5 Use socket headed screws of strength class 10.9 minimum for magnetic way mounting screws. Do not use stainless steel screws.

Magnetic Way Model SGLTM-	L1: ^{0.1} / _{0.3}	L2	N	Approx. Mass kg
40405A□	405	337.5 (67.5×5)	6	9
40675A□	675	607.5 (67.5×9)	10	15
40945A□	945	877.5 (67.5×13)	14	21

External Dimensions Units: mm

- Magnetic Way with Base: SGLTM-40□□□AY

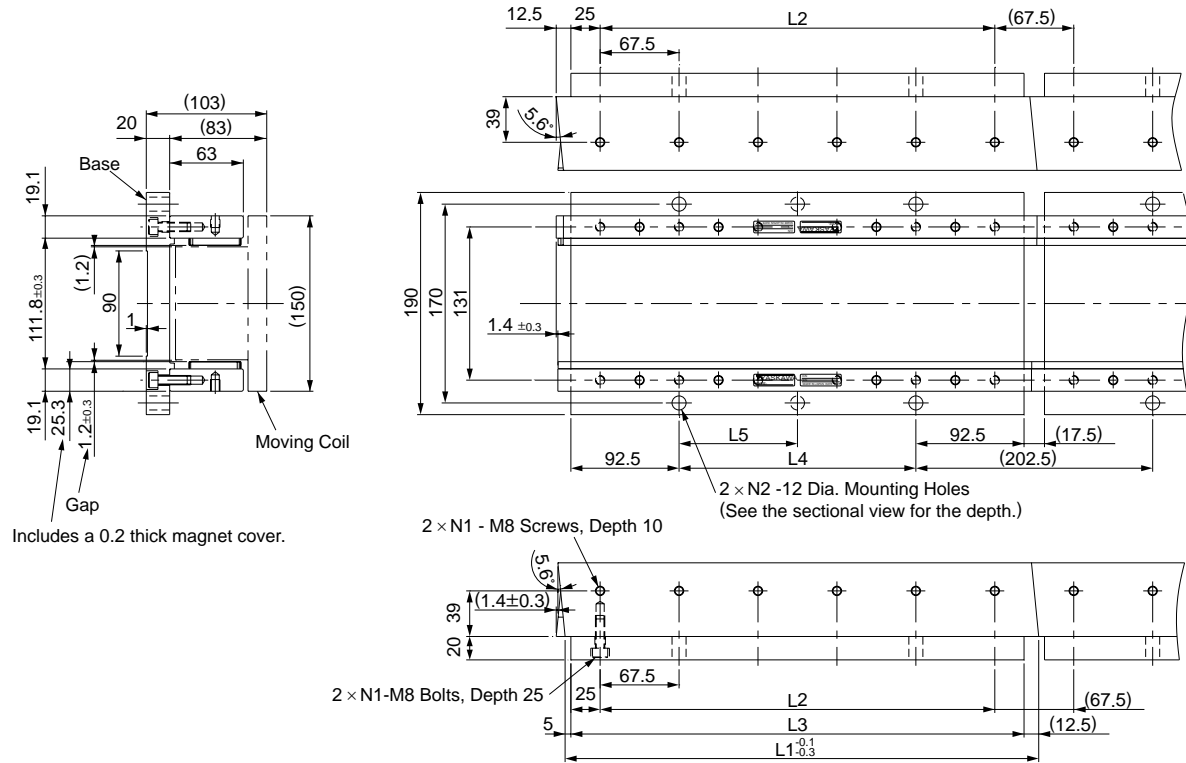

Includes a 0.2 thick magnet cover.

2 x N1 - M8 Screws, Depth 10

2 x N1-M8 Bolts, Depth 25

- Notes: 1 If you have a pacemaker or any other electronic medical device, do not go near the magnetic way of the linear servomotor.
 2 Two magnetic ways in a set can be connected to each other.
 3 The characteristics of the magnetic way with base are the same as of the magnetic way without base (SGLTM-40□□□A).

Magnetic Way Model SGLTM-	L1	L2	L3	L4	L5	N1	N2	Approx. Mass kg
40405AY	405	337.5	387.5	202.5	202.5	6	2	13
40675AY	675	607.5	657.5	472.5	236.25	10	3	21
40945AY	945	877.5	927.5	742.5	247.5	14	4	30

External Dimensions Units: mm

(4) Standard Type SGLTW-80

- Moving Coil: SGLTW-80□□□□B□ (With an MS connector)

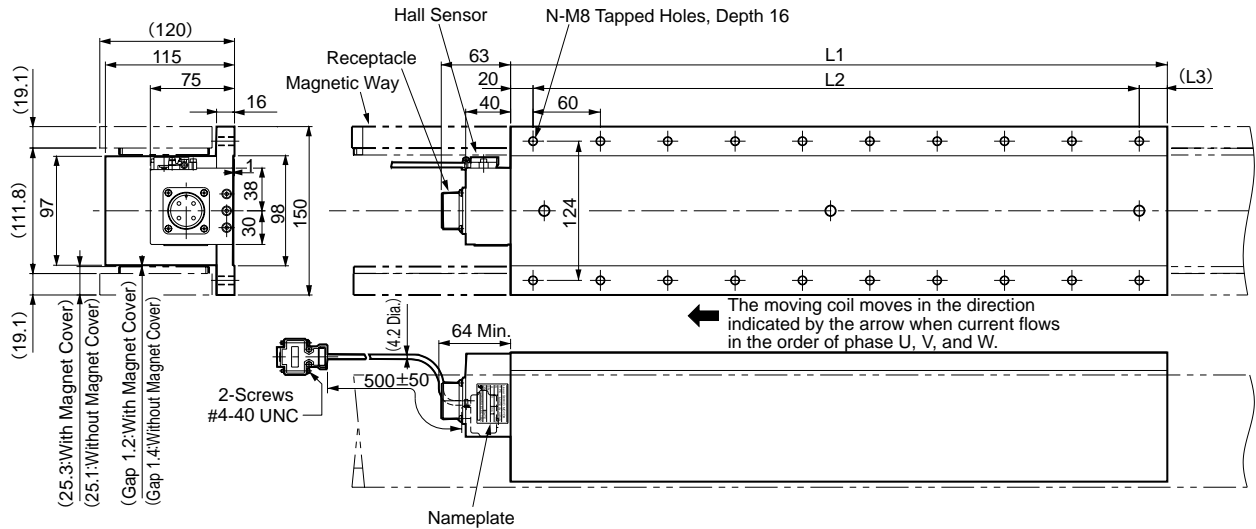

Hall Sensor Connector Specifications

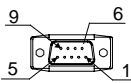

Pin Connector:
17JE-23090-02 (D8C)
by DDK Ltd.

The Mating Connector

Socket Connector:
17JE-13090-02 (D8C)
Stud: 17L-002C or
17L-002C1

Pin No.	Signal
1	+5VDC
2	Phase U
3	Phase V
4	Phase W
5	0V
6	Not used
7	Not used
8	Not used
9	Not used

Linear Servomotor Connector Specifications



Receptacle type: MS3102A-22-22P
by DDK Ltd.

The Mating Connector

L-shaped plug type : MS3108B22-22S
Straight plug type : MS3106B22-22S
Cable clamp type : MS3057-12A

Pin No.	Signal
A	Phase U
B	Phase V
C	Phase W
D	Ground

Hall Sensor Output Signals

When the moving coil moves in the direction indicated by the arrow in the figure, the relationship between the hall sensor output signals S_u , S_v , S_w and the inverse power of each motor phase V_u , V_v , V_w becomes as shown in the figure below.

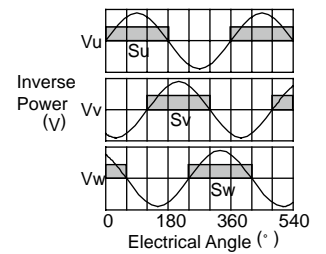

Moving Coil Model SGLTW-	L1	L2	L3	N	Approx. Mass kg
80□400B□	395	360(60×6)	(15)	14	24
80□600B□	575	540(60×9)	(15)	20	35

External Dimensions Units: mm

- Magnetic Way : SGLTM-80□□□A□

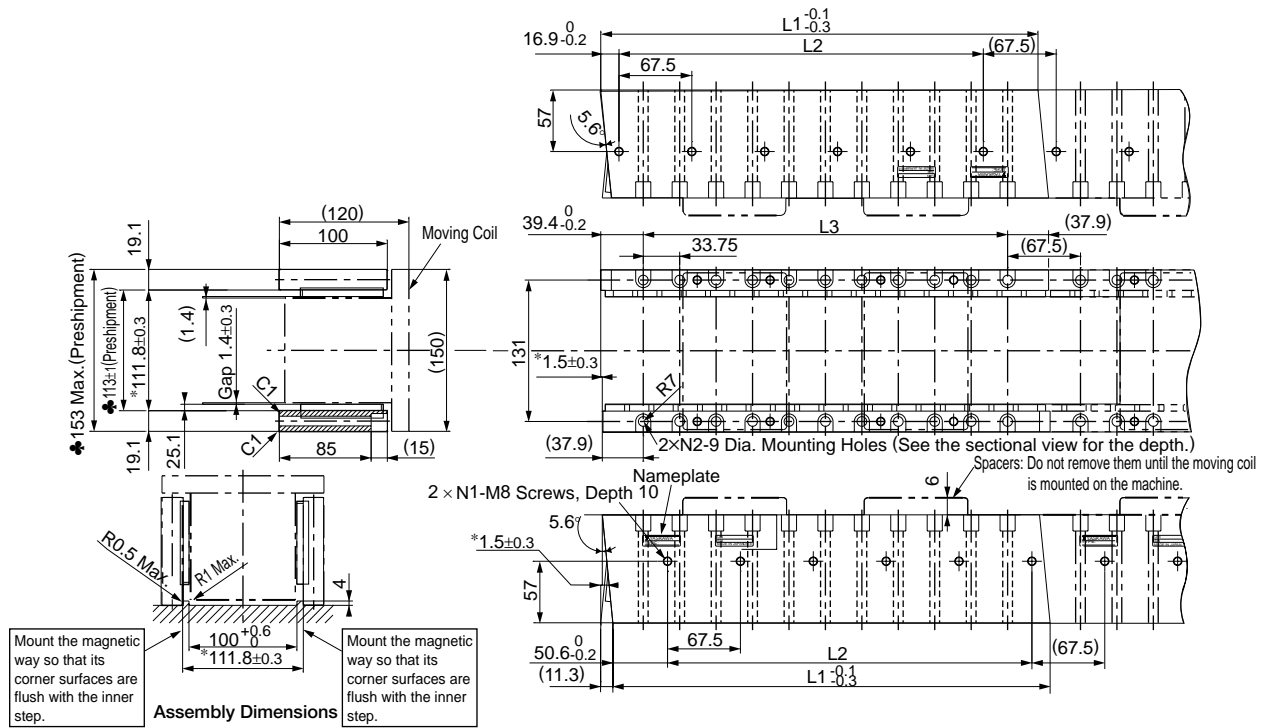

- Notes:
- 1 Two magnetic ways for both ends of moving coil make one set. Spacers are mounted on magnetic ways for safety during transportation. Do not remove the spacers until the moving coil is mounted on a machine.
 - 2 If you have a pacemaker or any other electronic medical device, do not go near the magnetic way of the linear servomotor.
 - 3 Two magnetic ways in a set can be connected to each other.
 - 4 The dimensions marked with an * are the dimensions between the magnetic ways. Be sure to follow exactly the dimensions specified in the figure above. Mount magnetic ways as shown in Assembly Dimensions. The values with a ♣ are the dimensions at preshipment.
 - 5 Use socket headed screws of strength class 10.9 minimum for magnetic way mounting screws. Do not use stainless steel screws.

Magnetic Way Model SGLTM-	L1 ^{-0.1 -0.3}	L2	L3	N1	N2	Approx. Mass kg
80405A□	405	337.5(67.5×5)	337.5(33.75×10)	6	11	14
80675A□	675	607.5(67.5×9)	607.5(33.75×18)	10	19	24
80945A□	945	877.5(67.5×13)	887.5(33.75×26)	14	27	34

External Dimensions Units: mm

- Magnetic Way with Base: SGLTM-80□□□AY

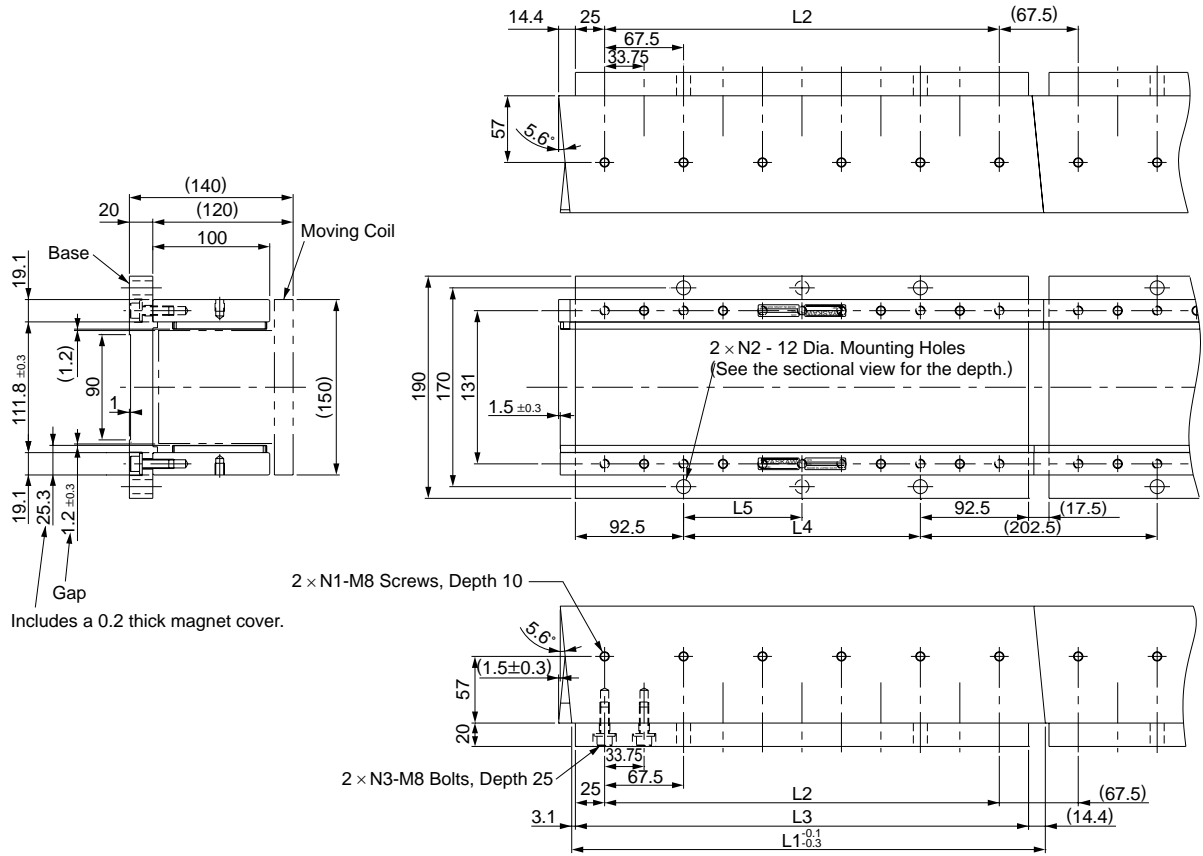

- Notes: 1 If you have a pacemaker or any other electronic medical device, do not go near the magnetic way of the linear servomotor.
 2 Two magnetic ways in a set can be connected to each other.
 3 The characteristics of the magnetic way with base are the same as of the magnetic way without base (SGLTM-80□□□A).

Magnetic Way Model SGLTM-	L1	L2	L3	L4	L5	N1	N2	N3	Approx. Mass kg
80405AY	405	337.5	387.5	202.5	202.5	6	2	11	18
80675AY	675	607.5	657.5	472.5	236.25	10	3	19	31
80945AY	945	877.5	927.5	742.5	247.5	14	4	27	43

External Dimensions Units: mm

(5) High-efficiency Type SGLTW-35A□□□H□

- Moving Coil: SGLTW-35A□□□H□ (With a connector by Tyco Electronics AMP K.K.)

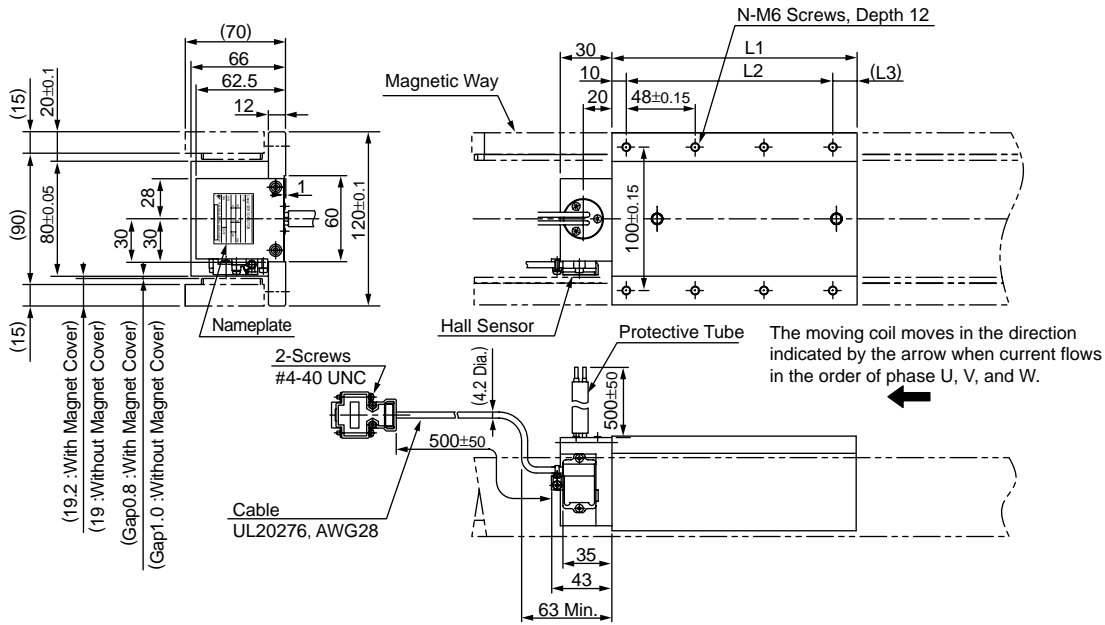

Hall Sensor Connector Specifications

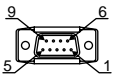

Pin Connector:
17JE-23090-02 (D8C)
by DDK Ltd.

The Mating Connector
Socket Connector:
17JE-13090-02 (D8C)
Stud: 17L-002C or
17L-002C1

Pin No.	Signal
1	+5VDC
2	Phase U
3	Phase V
4	Phase W
5	0V
6	Not used
7	Not used
8	Not used
9	Not used

Lead Specifications of Moving Coil

If this cable is bent repetitively, the cable will disconnect.

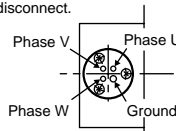

(View from Top of Moving Coil)

Name	Color	Code	Wire Size
Phase U		U	2 mm ²
Phase V	Black	V	
Phase W		W	
Ground	Green	-	2 mm ²

Hall Sensor Output Signals

When the moving coil moves in the direction indicated by the arrow in the figure, the relationship between the hall sensor output signals S_u , S_v , S_w and the inverse power of each motor phase V_u , V_v , V_w becomes as shown in the figure below.

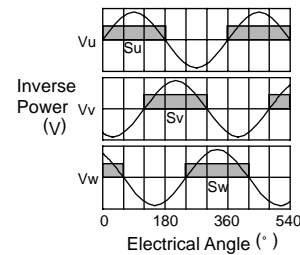

Moving Coil Model SGLTW-	L1	L2	(L3)	N	Approx. Mass kg
35A170H□	170	144 (48×3)	(16)	8	4.7
35A320H□	315	288 (48×6)	(17)	14	8.8

External Dimensions Units: mm

- Moving Coil: SGLTW-35D□□□H□D (With a connector by Interconnectron GmbH)

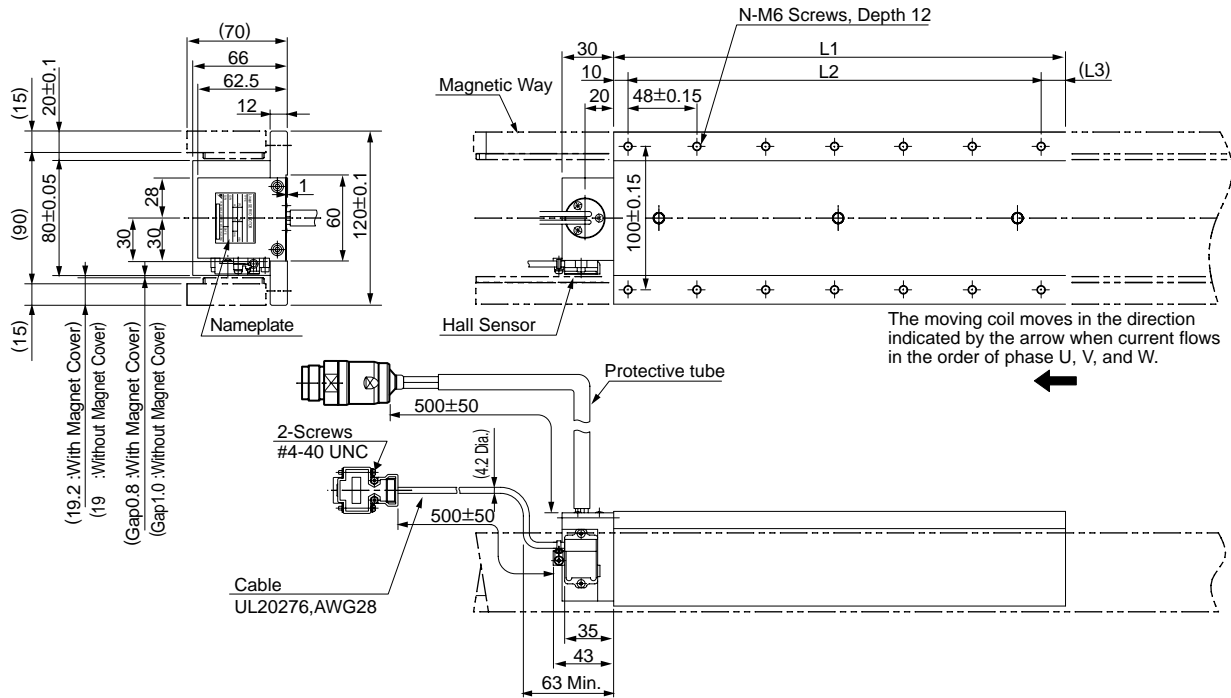

Hall Sensor Connector Specifications

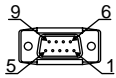

Pin Connector:
17JE-23090-02 (D8C)
by DDK Ltd.

The Mating Connector

Socket Connector:
17JE-13090-02 (D8C)
Stud: 17L-002C or
17L-002C1

Pin No.	Signal
1	+5VDC
2	Phase U
3	Phase V
4	Phase W
5	0V
6	Not used
7	Not used
8	Not used
9	Not used

Linear Servomotor Connector Specifications



Extension : ARRA06AMRPN182
Pin : 021.279.1020
by Interconnectron GmbH

The Mating Connector

Plug : APRA06BFRDN170
Socket : 020.105.1020

Pin No.	Signal
1	Phase U
2	Phase V
4	Phase W
5	Not used
6	Not used
⊕	Ground

Hall Sensor Output Signals

When the moving coil moves in the direction indicated by the arrow in the figure, the relationship between the hall sensor output signals S_u , S_v , S_w and the inverse power of each motor phase V_u , V_v , V_w becomes as shown in the figure below.

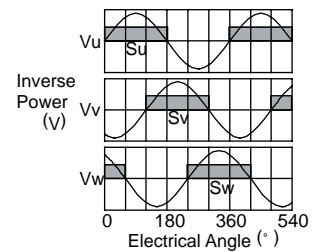

Moving Coil Model SGLTW-	L1	L2	(L3)	N	Approx. Mass kg
35D170H□D	170	144(48x 3)	(16)	8	4.7
35D320H□D	315	288(48x6)	(17)	14	8.8

External Dimensions Units: mm

- Magnetic Way: SGLTM-35□□□H□

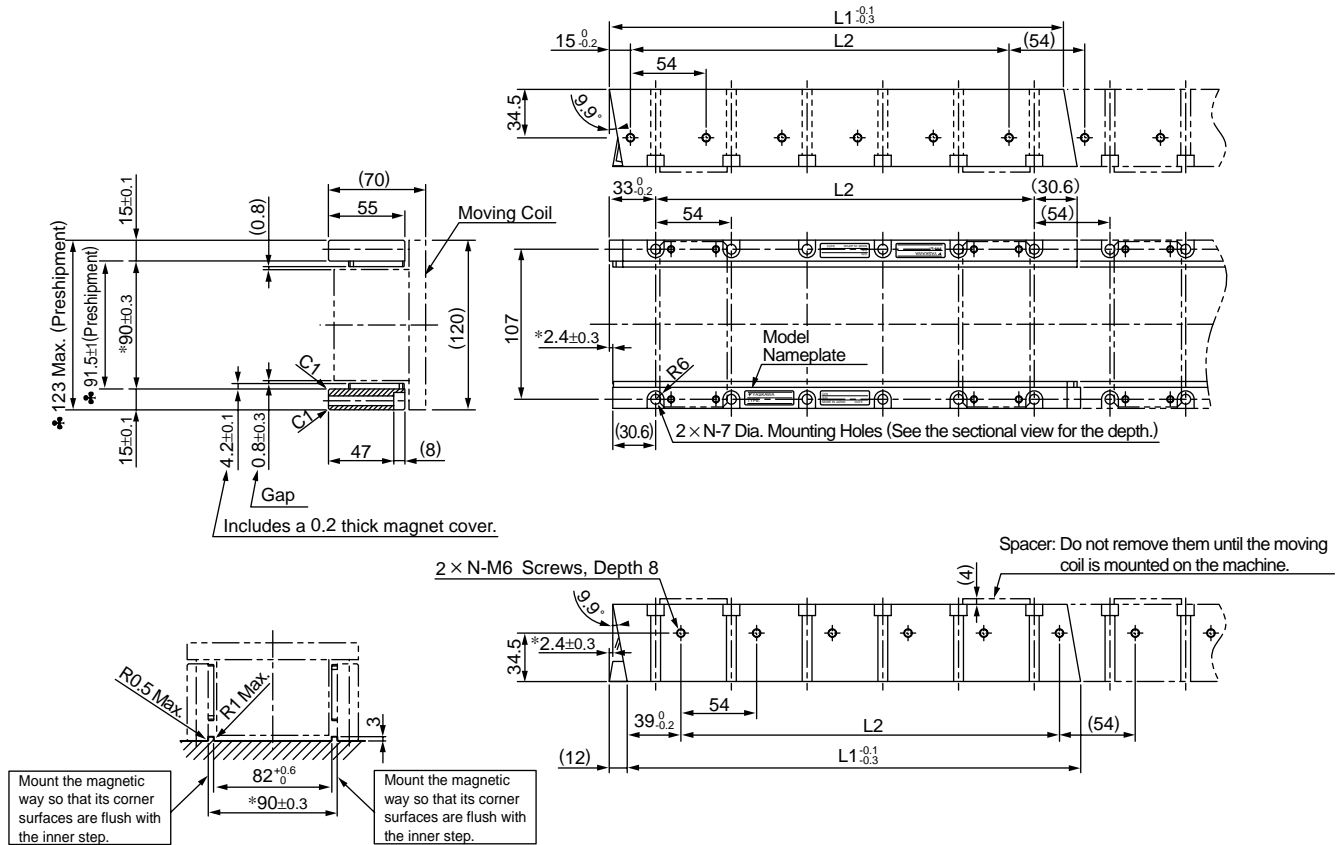

Assembly Dimensions

- Notes:
- 1 Two magnetic ways for both ends of moving coil make one set. Spacers are mounted on magnetic ways for safety during transportation. Do not remove the spacers until the moving coil is mounted on a machine.
 - 2 If you have a pacemaker or any other electronic medical device, do not go near the magnetic way of the linear servomotor.
 - 3 Two magnetic ways in a set can be connected to each other.
 - 4 The dimensions marked with an * are the dimensions between the magnetic ways. Be sure to follow exactly the dimensions specified in the figure above. Mount magnetic ways as shown in Assembly Dimensions. The values with a ♣ are the dimensions at preshipment.
 - 5 Use socket headed screws of strength class 10.9 minimum for magnetic way mounting screws. Do not use stainless steel screws.

Magnetic Way Model SGLTM-	L1 ^{-0.1} _{-0.3}	L2	N	Approx. Mass kg
35324H□	324	270 (54×5)	6	4.8
35540H□	540	486 (54×9)	10	8
35756H□	756	702 (54×13)	14	11

External Dimensions Units: mm

(6) High-efficiency Type SGLTW-50

- Moving Coil: SGLTW-50A□□□H□ (With a connector by Tyco Electronics AMP K.K.)

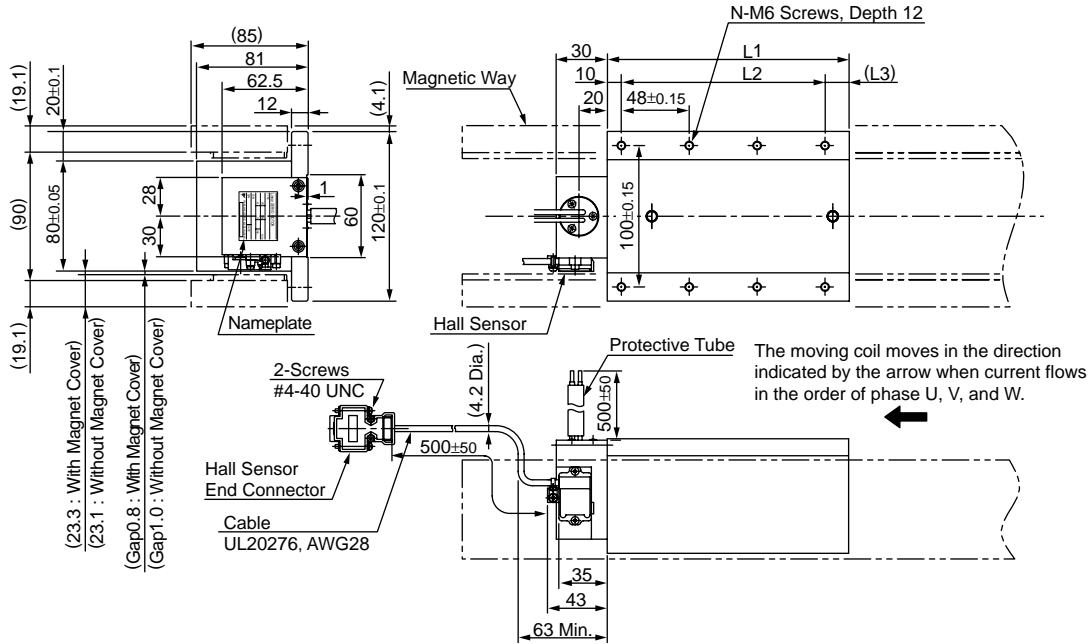

Hall Sensor Connector Specifications

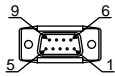

Pin Connector:
17JE-23090-02 (D8C)
by DDK Ltd.

The Mating Connector
Socket Connector:
17JE-13090-02 (D8C)
Stud: 17L-002C or
17L-002C1

Pin No.	Signal
1	+5VDC
2	Phase U
3	Phase V
4	Phase W
5	0V
6	Not used
7	Not used
8	Not used
9	Not used

Lead Specifications of Moving Coil

- If this cable is bent repetitively, the cable will disconnect.

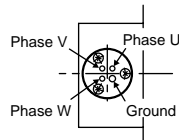

(View from Top of Moving Coil)

Name	Color	Code	Wire Size
Phase U		U	2 mm ²
Phase V	Black	V	
Phase W		W	
Ground	Green	-	2 mm ²

Hall Sensor Output Signals

When the moving coil moves in the direction indicated by the arrow in the figure, the relationship between the hall sensor output signals S_u , S_v , S_w and the inverse power of each motor phase V_u , V_v , V_w becomes as shown in the figure below.

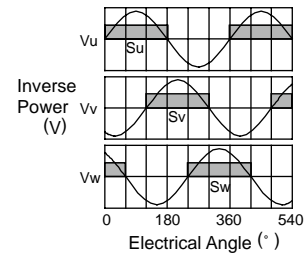

Moving Coil Model SGLTW-	L1	L2	(L3)	N	Approx. Mass kg
50A170H□	170	144 (48×3)	(16)	8	6
50A320□□	315	288 (48×6)	(17)	14	11

External Dimensions Units: mm

- Moving Coil: SGLTW-50D□□□H□D (With a connector by Interconnectron GmbH)

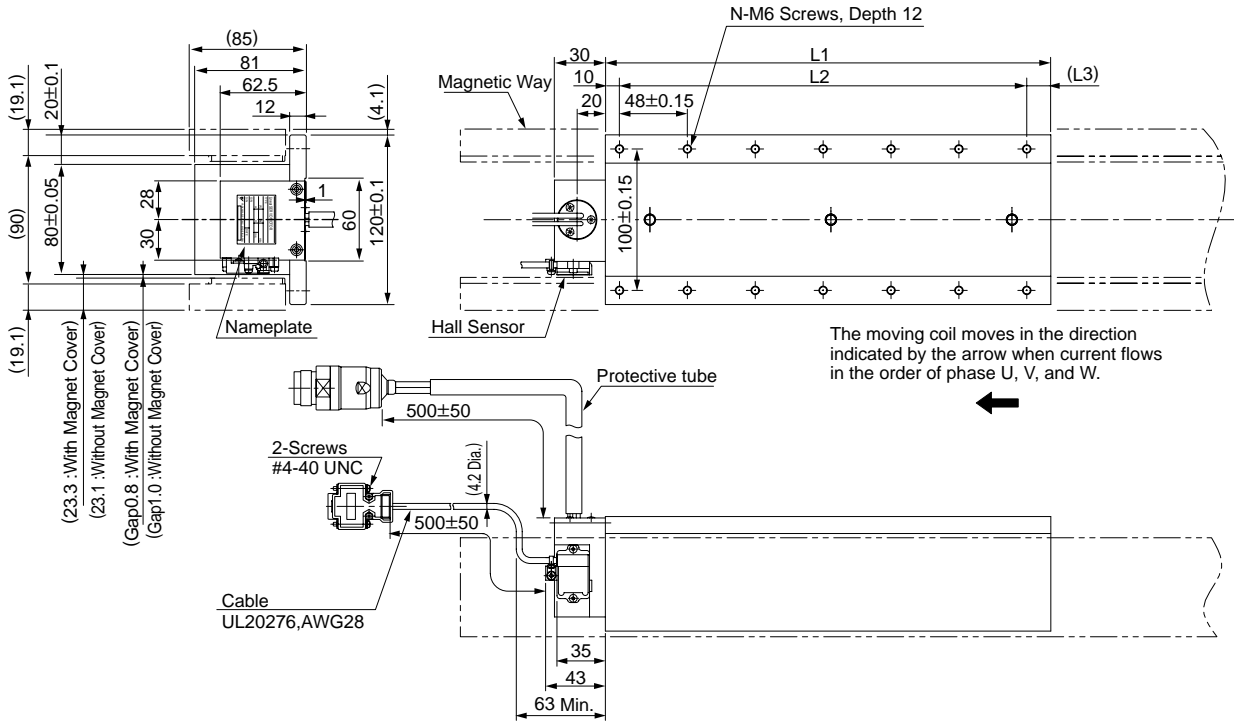

Hall Sensor Connector Specifications

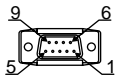

Pin Connector:
17JE-23090-02 (D8C)
by DDK Ltd.

The Mating Connector

Socket Connector:
17JE-13090-02 (D8C)
Stud: 17L-002C or
17L-002C1

Pin No.	Signal
1	+5VDC
2	Phase U
3	Phase V
4	Phase W
5	0V
6	Not used
7	Not used
8	Not used
9	Not used

Linear Servomotor Connector Specifications



Extension : ARRA06AMRPN182
Pin : 021.279.1020
by Interconnectron GmbH

The Mating Connector

Plug : APRA06BFRDN170
Socket : 020.105.1020

Pin No.	Signal
1	Phase U
2	Phase V
4	Phase W
5	Not used
6	Not used
⊕	Ground

Hall Sensor Output Signals

When the moving coil moves in the direction indicated by the arrow in the figure, the relationship between the hall sensor output signals S_u , S_v , S_w and the inverse power of each motor phase V_u , V_v , V_w becomes as shown in the figure below.

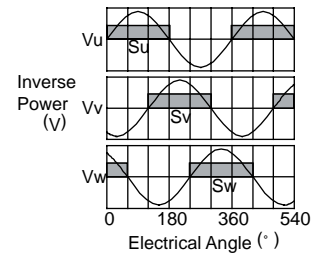

Moving Coil Model SGLTW-	L1	L2	(L3)	N	Approx. Mass kg
50D170H□D	170	144(48x3)	(16)	8	6
50D320H□D	315	288(48x6)	(17)	14	11

External Dimensions Units: mm

- Magnetic Way: SGLTM-50□□□H□

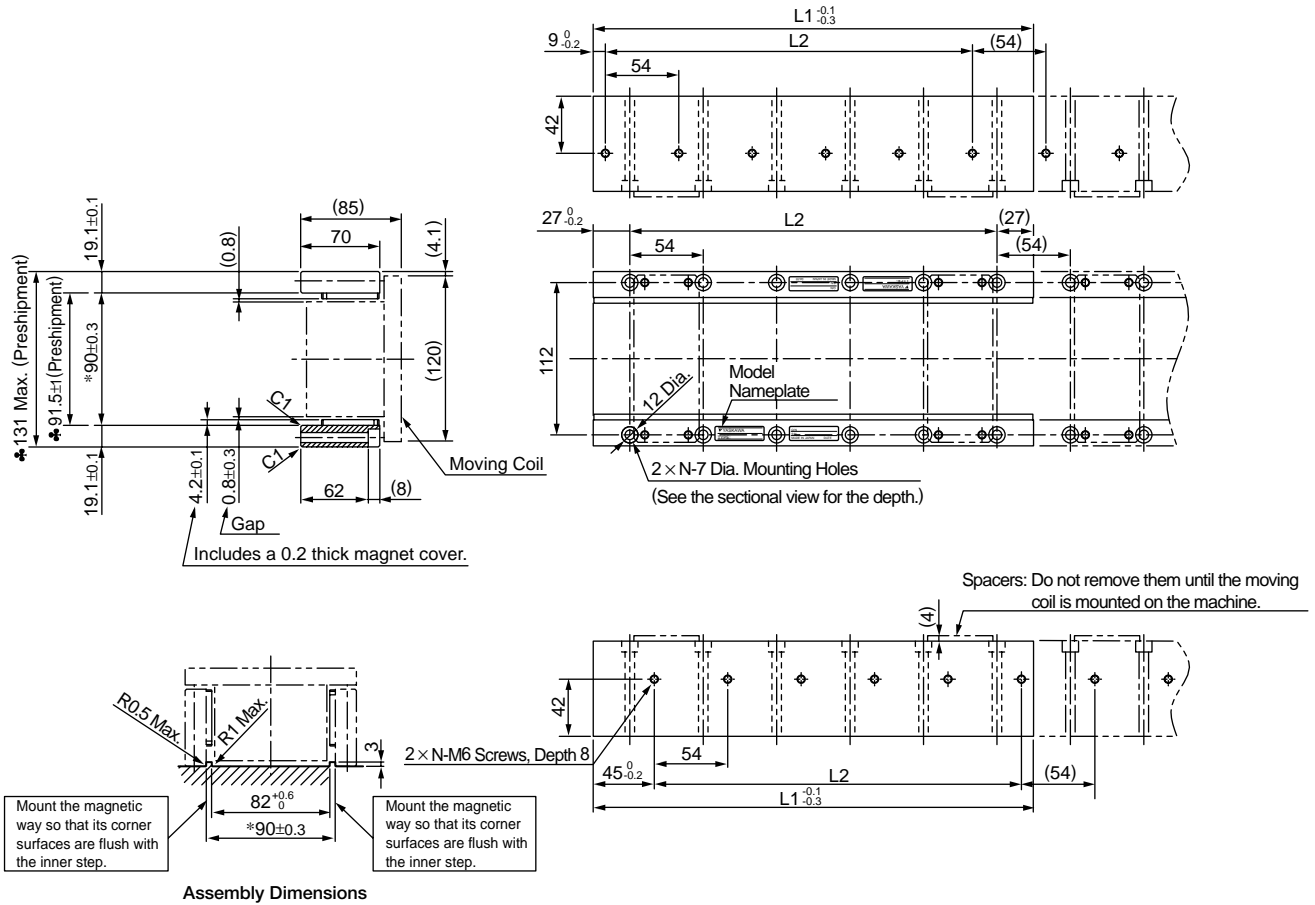

- Notes:
- 1 Two magnetic ways for both ends of moving coil make one set. Spacers are mounted on magnetic ways for safety during transportation. Do not remove the spacers until the moving coil is mounted on a machine.
 - 2 If you have a pacemaker or any other electronic medical device, do not go near the magnetic way of the linear servomotor.
 - 3 Two magnetic ways in a set can be connected to each other.
 - 4 The dimensions marked with an * are the dimensions between the magnetic ways. Be sure to follow exactly the dimensions specified in the figure above. Mount magnetic ways as shown in Assembly Dimensions. The values with a ♣ are the dimensions at preshipment.
 - 5 Use socket headed screws of strength class 10.9 minimum for magnetic way mounting screws. Do not use stainless steel screws.

Magnetic Way Model SGLTM-	L1 ^{-0.1} / _{-0.3}	L2	N	Approx. Mass kg
50324H□	324	270 (54×5)	6	8
50540H□	540	486 (54×9)	10	13
50756H□	756	702 (54×13)	14	18

Selecting Cables

● Cables Connections

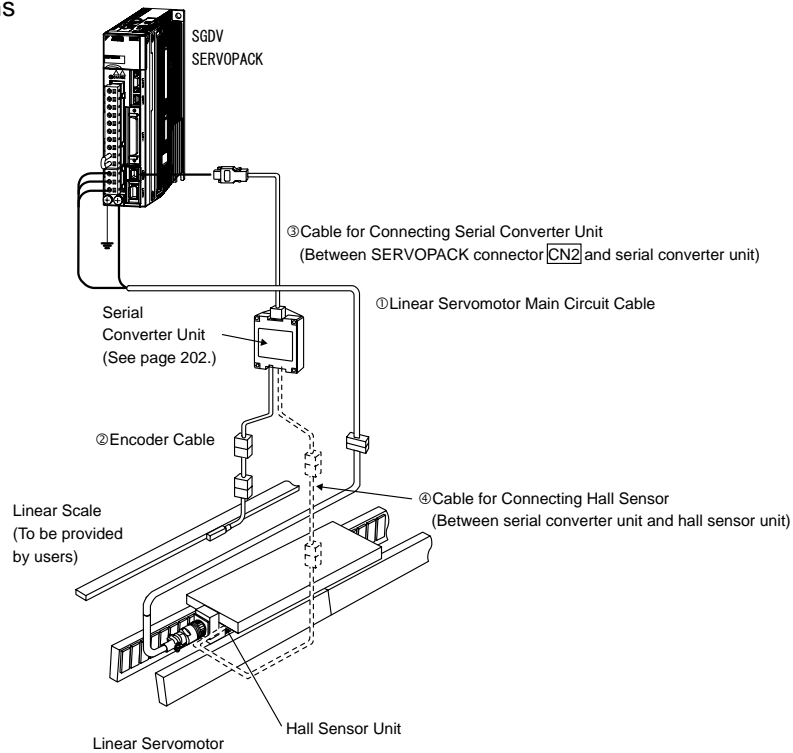

● Cables

Name	Applicable Linear Servomotor Model	Length	Order No.	Specifications	Details
① Linear Servomotor Main Circuit Cables	SGLTW -20, -35, -50	1 m	JZSP-CLN21-01-E		(1)
		3 m	JZSP-CLN21-03-E		
		5 m	JZSP-CLN21-05-E		
		10 m	JZSP-CLN21-10-E		
		15 m	JZSP-CLN21-15-E		
		20 m	JZSP-CLN21-20-E		
	SGLTW-40,-80	1 m	JZSP-CLN39-01-E		(2)
		3 m	JZSP-CLN39-03-E		
		5 m	JZSP-CLN39-05-E		
		10 m	JZSP-CLN39-10-E		
		15 m	JZSP-CLN39-15-E		
		20 m	JZSP-CLN39-20-E		
	SGLTW- □□A□□□□□D	1 m	JZSP-CLN14-01-E		(3)
		3 m	JZSP-CLN14-03-E		
		5 m	JZSP-CLN14-05-E		
		10 m	JZSP-CLN14-10-E		
		15 m	JZSP-CLN14-15-E		
		20 m	JZSP-CLN14-20-E		
	SGLTW- □□D□□□□□D	1 m	JZSP-CLN15-01-E		(4)
		3 m	JZSP-CLN15-03-E		
5 m		JZSP-CLN15-05-E			
10 m		JZSP-CLN15-10-E			
15 m		JZSP-CLN15-15-E			
20 m		JZSP-CLN15-20-E			

*1: Connector by Tyco Electronics AMP K.K.

*2: MS connector

*3: Connector by Interconnectron GmbH

NOTE: Shaded items are non-stock.

(cont'd)

Selecting Cables

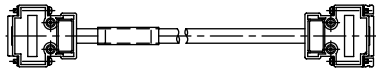
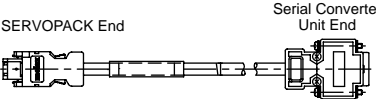
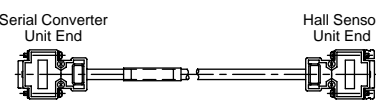
Name	Applicable Linear Servomotor Model	Length	Order No.	Specifications	Details
② Cables for Connecting Linear Scales*	All models	1 m	JZSP-CLL00-01-E		(5)
		3 m	JZSP-CLL00-03-E		
		5 m	JZSP-CLL00-05-E		
		10 m	JZSP-CLL00-10-E		
		15 m	JZSP-CLL00-15-E		
③ Cables for Connecting Serial Converter Units	All models	1 m	JZSP-CLP70-01-E		(6)
		3 m	JZSP-CLP70-03-E		
		5 m	JZSP-CLP70-05-E		
		10 m	JZSP-CLP70-10-E		
		15 m	JZSP-CLP70-15-E		
		20 m	JZSP-CLP70-20-E		
④ Cables for Connecting Hall Sensors	All models	1 m	JZSP-CLL10-01-E		(7)
		3 m	JZSP-CLL10-03-E		
		5 m	JZSP-CLL10-05-E		
		10 m	JZSP-CLL10-10-E		
		15 m	JZSP-CLL10-15-E		

* When using serial converter unit JZSP-GD00□ - □□□ -E, the maximum cable length is 3 m.

(1) Linear Servomotor Main Circuit Cables: JZSP-CLN21-□□-E

● Wiring Specifications

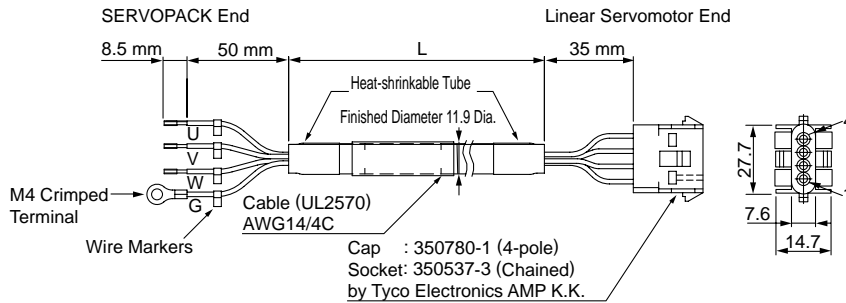

SERVOPACK-end Leads		Linear Servomotor-end Connector	
Wire Color	Signal	Signal	Pin No.
Red	Phase U	Phase U	1
White	Phase V	Phase V	2
Blue	Phase W	Phase W	3
Green/yellow	FG	FG	4

(2) Linear Servomotor Main Circuit Cables: JZSP-CLN39-□□-E

A connector is not provided on the linear-servomotor end of the main circuit cable (JZSP-CLN39-□□-E). This connector is provided by the customer.

● Wiring Specifications

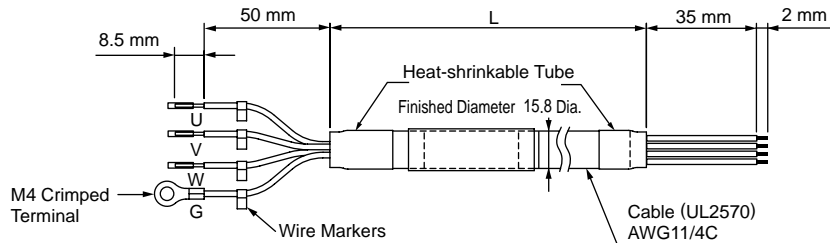

SERVOPACK-end Leads		Linear Servomotor-end Connector	
Wire Color	Signal	Signal	Pin No.
Red	Phase U	Phase U	1
White	Phase V	Phase V	2
Blue	Phase W	Phase W	3
Green/yellow	FG	FG	4

Selecting Cables

● JZSP-CLN39 Cable Connectors

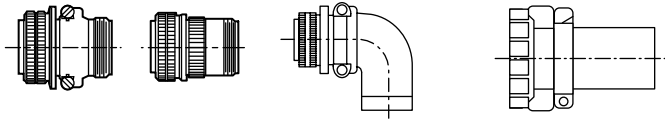

Applicable Linear Servomotor Model	Attached Connector	Plug		Cable Clamp
		Straight	Straight L-shaped	
SGLTW-40, -80	MS3102A22-22P	MS3106B22-22S or MS3106A22-22A	MS3108B22-22S	MS3057-12A

(a) MS3106B: Straight Plug with Front-shell and Back-shell Separated

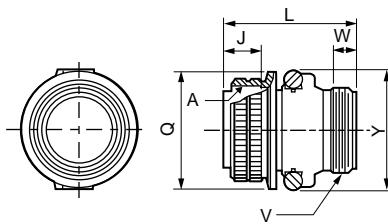

Units: mm

Shell Size	Joint Screw A	Joint Length J±0.12	Max. Overall Length L	Outer Diameter of Nut Q ⁺⁰ _{-0.38}	Cable Clamp Mounting Screw V	Min. Effective Screw Length W	Max. Width Y
22	1 3/8 -18UNEF	18.26	55.57	40.48	1 3/16 -18UNEF	9.53	50

(b) MS3106A: Straight Plug with Solid Shell

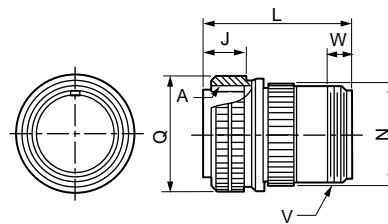

Units: mm

Shell Size	Joint Screw A	Joint Length J±0.12	Overall Length L±0.5	Outer Diameter of Nut Q ⁺⁰ _{-0.38}	Outer Diameter N±0.5	Cable Clamp Mounting Screw V	Min. Effective Screw Length W
22	1 3/8 -18UNEF	18.26	54	40.48	34.99	1 3/16 -18UNEF	9.53

(c) MS3108B: L-shaped Plug with Front-shell and Back-shell Separated

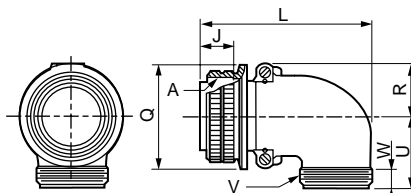

Units: mm

Shell Size	Joint Screw A	Joint Length J±0.12	Max. Overall Length L	R ±0.5	U ±0.5	Outer Diameter of Nut Q ⁺⁰ _{-0.38}	Cable Clamp Mounting Screw V	Min. Effective Screw Length W
22	1 3/8 -18UNEF	18.26	76.98	24.1	33.3	40.48	1 3/16 -18UNEF	9.53

(d) MS3057-12A: Cable Clamp with Rubber Bushing

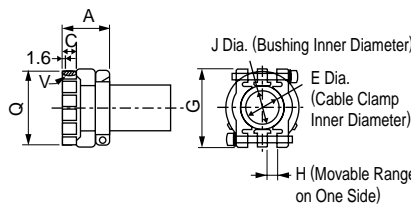

Units: mm

Applicable Shell Size	Overall Length A±0.7	Effective Screw Length C	E	G±0.7	H	J	Mounting Screw V	Outer Diameter Q±0.7	Rubber Bushing Type
20, 22	23.8	10.3	19.0	37.3	4.0	15.9	1 3/16 -18UNEF	35.0	AN3420 -12

Selecting Cables

(3) Linear Servomotor Main Circuit Cables: JZSP-CLN14-□□-E

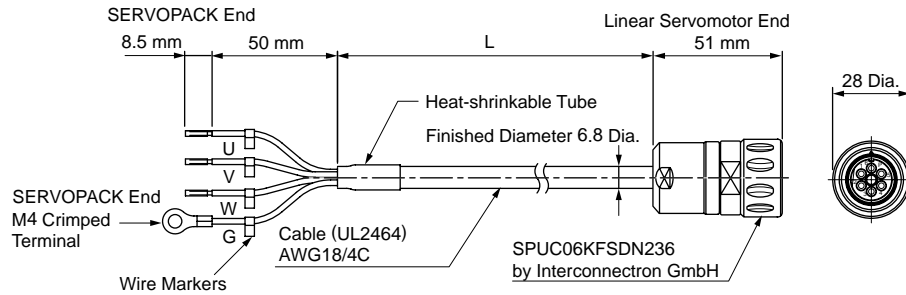

• Wiring Specifications

SERVOPACK-end Leads		Linear Servomotor-end Connector	
Wire Color	Signal	Signal	Pin No.
Black (White 1)	Phase U	Phase U	1
Black (White 2)	Phase V	Phase V	2
Black (White 3)	Phase W	Phase W	3
Green / yellow	FG	—	4
		—	5
		FG	6

(4) Linear Servomotor Main Circuit Cables: JZSP-CLN15-□□-E

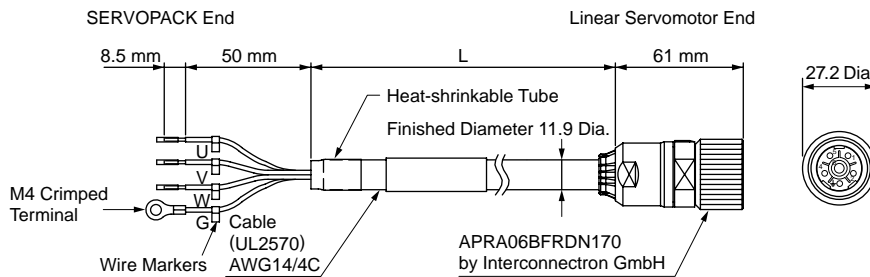

• Wiring Specifications

SERVOPACK-end Leads		Linear Servomotor-end Connector	
Wire Color	Signal	Signal	Pin No.
Red	Phase U	Phase U	1
White	Phase V	Phase V	2
Black	Phase W	FG	3
Green / yellow	FG	Phase W	4
		—	5
		—	6

(2) Cables for Connecting Linear Scales: JZSP-CLL00-□□-E

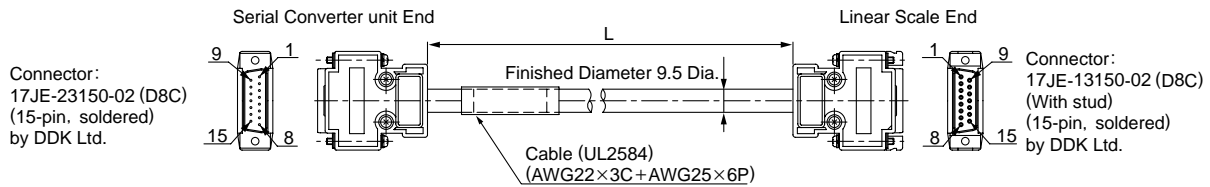

• Wiring Specifications

Serial Converter Unit End		Linear Scale End	
Pin No.	Signal	Pin No.	Signal
1	/Cos(V1-)	1	/Cos(V1-)
2	/Sin(V2-)	2	/Sin(V2-)
3	Ref(V0+)	3	Ref(V0+)
4	+5V	4	+5V
5	5Vs	5	5Vs
6	BID	6	BID
7	Vx	7	Vx
8	Vq	8	Vq
9	Cos(V1+)	9	Cos(V1+)
10	Sin(V2+)	10	Sin(V2+)
11	/Ref(V0+)	11	/Ref(V0-)
12	0V	12	0V
13	0Vs	13	0Vs
14	DIR	14	DIR
15	Inner	15	Inner
Case	Shield	Case	Shield

Selecting Cables

(6) Cables for Connecting Serial Converter Units: JZSP-CLP70-□□-E

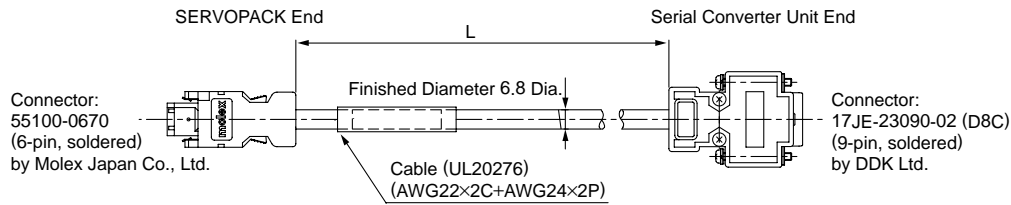

• Wiring Specifications

SERVOPACK End			Serial Converter Unit End		
Pin No.	Signal	Wire Color	Pin No.	Signal	Wire Color
1	PG5V	Red	1	+5V	Red
2	PG0V	Black	5	0V	Black
3	-	-	3	-	-
4	-	-	4	-	-
5	PS	Light blue	2	Phase S output	Light blue
6	/PS	Light blue/white	6	Phase /S output	Light blue/white
Shell	Shield	-	Case	Shield	-
			7	-	-
			8	-	-
			9	-	-

(7) Cables for Connecting Hall Sensors: JZSP-CLL10-□□-E

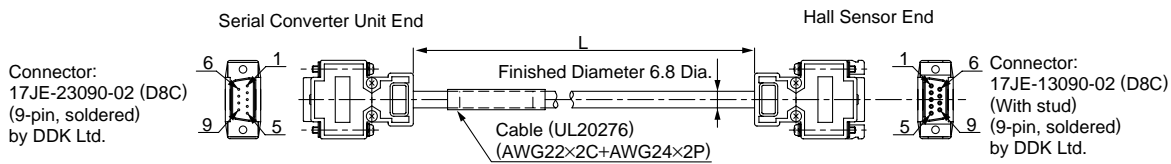

• Wiring Specifications

Serial Converter Unit End		Hall Sensor End	
Pin No.	Signal	Pin No.	Signal
1	+5V	1	+5V
2	Phase U input	2	Phase U input
3	Phase V input	3	Phase V input
4	Phase W input	4	Phase W input
5	0V	5	0V
6	-	6	-
7	-	7	-
8	-	8	-
9	-	9	-
Case	Shield	Case	Shield